

1927

RADIO NEWS

REG. U.S. PAT. OFF.

SEPTEMBER
25 Cents

Over 200
Illustrations



BROADCAST
WRNY
STATION



Edited by HUGO GERNSBACK

"A NEW RADIO
HOOK-UP"



RADIO'S GREATEST MAGAZINE

EXPERIMENTER PUBLISHING COMPANY, NEW YORK, PUBLISHERS OF
RADIO NEWS · SCIENCE & INVENTION · RADIO LISTENERS' GUIDE · AMAZING STORIES · SPARE-TIME MONEY MAKING · FRENCH HUMOR



Cunningham RADIO TUBES

*Since 1915—
Standard for All Sets*

are built in one of the greatest radio research laboratories the world has ever known.

Every process and material used in their manufacture has been developed in or passed the exacting tests of this world-renowned research organization. That is the secret of the in-built quality of Cunningham Radio Tubes.

A hidden yet ever-present integrity, twelve years of constant striving for a better and still better product, and always the ideal of "Quality First"—these combine to create value, an assurance of trouble-free radio reception.

There is a special purpose Cunningham Radio Tube for every radio and power supply use. Consult your radio dealer. He will tell you the best combination of Cunningham Radio Tubes to use for your particular set.

E. T. CUNNINGHAM, Inc.

New York Chicago San Francisco

CUNNINGHAM
RADIO
TUBES

FAIS

Tower

Presents

New Startling

1927-28 SPEAKER VALUES

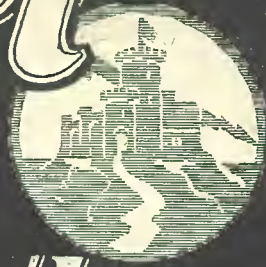

COMPLETELY revolutionizing present day standards, TOWER offers these five new, brilliantly conceived and executed cones. Select no speaker until you see them!



MODEL '28' \$17.50

Suggestive of the days of chivalry with elaborate heraldic grill and armature type unit. Superb volume and tone quality.

No matter what design meets your fancy—sailing ship or medieval castle, popular drum or octagonal cone — there's a TOWER Speaker of highest quality to delight both the eye and ear.

See your dealer or write us for illustrated circular.



Adventurer \$9.50

A genuine sailing ship model cast in bas-relief with bright natural colorings. Armature unit. WEST OF DES MOINES, IA., \$10.50

TOWER MFG. CORP.
124 Brookline Ave., Boston



Castle Cone \$9.50

A creative work of art finished in two-toned bronze. Employs powerful new type armature unit for power tube amplification.

WEST OF DES MOINES, IA., \$10.50



Pirate Ship \$7.95

The most amazing cone on the market! A fine old PIRATE SHIP with exceptional reproducing qualities. The utmost in eye and ear value.

WEST OF DES MOINES, IA., \$8.75

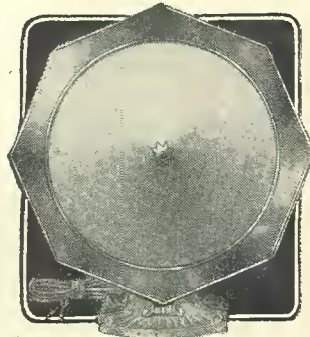

**New and Improved \$15-
Meistersinger**

America's most beautiful cone! Both a wall and table model with new armature type unit for power tubes. Mahogany finished frame. Art Metal Base.

Over Two Million Tower Products now in use!

RADIO NEWS

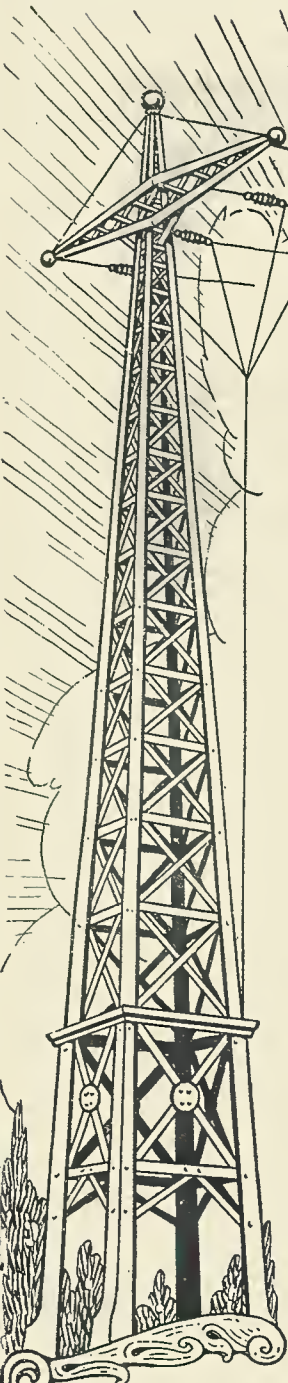

Published by EXPERIMENTER PUBLISHING COMPANY, Inc., Publishers of "Radio News," "Science and
"Invention," "Radio Listeners' Guide," "Spare-Time Money Making,"
"Amazing Stories," and "French Humor."

H. GERNSBACK, President. S. GERNSBACK, Treasurer. R. W. DEMOTT, Secretary.

Member: Audit Bureau of Circulations Radio Magazine Publishers Association

Editorial and General Offices: - - 230 Fifth Avenue, New York City

VOLUME 9

SEPTEMBER, 1927

NUMBER 3

Contents of This Issue:

A Radio Utopia, By Hugo Gernsback	201	Loop Operation of the Strobodyne Receiver, By Lucien Chrétien and R. E. Lacault	228
The Community Set Builders, By Armstrong Perry	202	The Gomez Super-Reflex Receiver, By A. van A. Sommers	230
Lamp-Socket Operation, By Chas. M. Adams	204	Space-Wound Coil Construction, By A. Binneweg, Jr.	234
Awards of the \$300.00 "What's Wrong?" Contest,	206	The RADIO NEWS Short-Wave Receiver, By Kendall Clough	236
Radio News of the Month,	207	Hints About Three-Foot Cones, By Clyde J. Fitch	237
Radio and Our Spoken Language, By Chas. M. Adams	208	New Experiments with a Transmitting Set, By John L. Reinartz	238
Cross-Country Radio Transmission Work, Sandy McGuff's "Ultimate Twin-Six," By Bruce Colter Carr	210	How Filtering is Accomplished in Radio Power Supply,	239
Views of Japan's Leading Station, JOAK,	211	With the Amateurs,	240
New Developments in Radio,	212	Working on Seven-Foot Waves, By H. E. Hollman and H. Peters	241
Real Portability in Radio Sets,	213	Progress in Radio,	242
"Silent Dynamite," By C. Sterling Gleason	214	A New System of R. F. Amplification, By F. A. Jewell	243
Radio News of the Month Illustrated, By George Wall	216	Rectifying with Metallic Detectors, By Prof. H. Pelabon	244
Innovations in Broadcast Studio Equipment, By Herndon Green	217	Obtaining Accurate Voltage Readings, By G. F. Walker	245
What's New in Radio,	218	Correspondence from Readers,	246
A Prize Portable Super-Regenerator, By Joseph Riley	222	Radio Wrinkles—Awards of the \$50 Prize Contest,	248
Experiments with Methods of Detection, By L. W. Hatry	224	RADIO NEWS Laboratories,	250
List of Broadcast Stations in the United States,	225	Radiotics,	252
Radio's Will-o'-the-Wisp, By S. R. Winters	226	I Want to Know, By Joseph Goldstein	253

In Forthcoming Issues:

OPERATION OF THE STROBODYNE
By R. E. LACAULT

Hints and kinks of value to the constructors of this remarkable new circuit; by the designer of the American model.

BURIED AERIAL CHASES STATIC
By H. WINFIELD SECOR

Full instructions on the use of this simple, yet effective, method of minimizing the greatest pest of radio listeners.

THE RADIO NEWS SHORT-WAVE RECEIVER
By KENDALL CLOUGH

Full constructional details for this high-quality receiver, which will bring in foreign countries consistently on the short waves.

RADIO NEWS is published on the 10th of each preceding month. There are 12 numbers per year. Subscription price is \$2.50 a year in U. S. and possessions. Canada and foreign countries, \$3.00 per year. U. S. Coin as well as U. S. Stamps accepted (no foreign coins or stamps). Single copies, 25 cents each. Checks and money orders should be drawn to order of EXPERIMENTER PUBLISHING CO., INC.

All communications and contributions to this journal should be addressed to Editor, RADIO NEWS, 230 Fifth Ave., New York, N. Y. Unaccepted contributions cannot be returned unless full postage has been included. All accepted contributions are paid for on publication. A special rate is paid for novel experiments; good photographs accompanying them are highly desirable.

RADIO NEWS, Monthly. Entered as second-class matter, July 12, 1924, at the Post Office at New York, N. Y., under the Act of March 3, 1879. Additional entry at Long Island City, N. Y., and San Francisco, Calif. Title registered U. S. Patent Office. Copyright, 1927, by The Experimenter Publishing Co., Inc., 230 Fifth Ave., New York. The Contents of this magazine are copyrighted and must not be reproduced in the United States without giving full credit to the publication. Translation into foreign languages must not be made unless permission is obtained from the publishers. Copyrighted in Germany. Reproduction of articles in Germany is reserved for Radio, Berlin 42.

RADIO NEWS is for sale at all newsstands in the United States and Canada, and at Brentano's, Ave. de L'Opera, Paris, France. European agents: S. J. Wise Et Cie, 40 Place Verte, Antwerp, Belgium.

HOW TO SUBSCRIBE FOR RADIO NEWS. Send your name, address and remittance to Experimenter Publishing Co., 230 Fifth Ave., New York. Mention the name of the magazine you are ordering. We also publish SCIENCE AND INVENTION, RADIO LISTENERS' GUIDE, SPARE TIME MONEY MAKING, AMAZING STORIES and FRENCH HUMOR. Write clearly.

RATES AND TERMS. The subscription rate for RADIO NEWS is \$2.50 per year. (12 numbers). When remitting do so by check, money order, or registered letter if cash is enclosed. Avoid sending cash through the mail if possible. Subscriptions for less than one year are not accepted. Subscription may be made in combination with SCIENCE & INVENTION, RADIO LISTENERS' GUIDE, SPARE TIME MONEY MAKING, AMAZING STORIES and FRENCH HUMOR.

POSTAGE. We prepay postage in all parts of the United States, Mexico and island possessions. For foreign or Canadian subscriptions we require 50 cents in addition to the subscription price for additional postage charge.

CHANGE OF ADDRESS. Notify us as far in advance as possible. It requires several weeks to make an address change on our records. Always write clearly.

General Advertising Dept., 230 Fifth Avenue, New York City

ADVERTISING REPRESENTATIVES

L. F. McCLURE, 720 Cass Street, Chicago, Ill.
DAVIES, DILDON & KELLY, 15 West 10th St., Kansas City, Mo.
T. F. MAGRANE, Park Square Bldg., Boston, Mass.

HARRY E. HYDE, 548 Drexel Building, Philadelphia, Pa.
A. J. NORRIS HILL CO., 5 Third St., San Francisco, Calif.
412 West 6th St., Los Angeles, Calif.
Leary Building, Seattle, Wash.



When the
Greatest
Show in
History thrills
the World

....You're there with a Crosley



\$35



The BANDBOX \$55
A 6 tube Receiver
Brown frosted Crystalline finish—
Bronze Escutcheon.



\$65



\$85

These approved cabinets have been selected by Powell Crosley, Jr., as ideal consoles, acoustically and mechanically, for the installation of the Crosley "BANDBOX." Genuine Musicones built in. Crosley dealers secure them from their jobbers through

H. T. ROBERTS CO.,
914 S. Michigan Ave.,
Chicago, Ill.

Sales Agents for Approved Console Factories:
SHOWERS BROTHERS CO.
THE WOLF MFG. INDUSTRIES

A tremendous Crosley radio achievement for 1927-28

RECENT court decisions which clarified the radio patent situation have paved the way for still greater Crosley triumphs. Now—completely available to Crosley—and amplifying Crosley supremacy in fullest measure, are the enormous resources, great discoveries and ideas embodied in patents of

- 1—The Crosley Radio Corporation.
- 2—The Radio Corp. of America.
- 3—The Westinghouse Co.
- 4—The General Electric Co.
- 5—The American Telephone & Telegraph Co.
- 6—The Hazeltine Corporation.
- 7—The Latour Corporation.

under which Crosley is now licensed to manufacture.

Here are the seven big things which represent radio's greatest advancement, brought together by Crosley and combined with the experience, mass production method and leadership of the Crosley organization. No wonder a waiting radio world pronounces the "Bandbox" at the unprecedented price of \$55, Crosley's paramount achievement.

The Bandbox is Shielded
Radio coils are surrounded by magnetic fields similar in every respect to the magnetic field around the earth that moves the needle of a compass but around radio coils these fields make nuisances of themselves by feeding back on each other. Heretofore it has been customary to make inefficient coils with inefficient fields to prevent such feeding back. The Crosley Bandbox incorporates copper shields around each coil to prevent such feeding back. The coils consequently can be made and are very much more efficient. The amplification of the receiver is, therefore, much higher—the sensitivity is greatly increased. Condensers are also completely shielded from each other in separate metal compartments. Hitherto, only high priced sets have enjoyed this super radio advantage.

There Is No Oscillation
The Bandbox employs completely balanced or neutralized radio frequency stages to prevent oscillation, instead of the common form of lossier method. More costly, to be sure, but extremely necessary in achieving such results as are obtained by this marvel of radio reception.

For Sharpness — The Acuminators
"Bandbox" acuminators enable "fishers" for distant stations to bring them in loud and clear. As powerful telescopes magnify distant scenes, acuminators increase the volume of far-a-way signals so they seem like local programs.

Volume Control
This is another big "Bandbox" feature which permits full brass band power for those who want their dance notes strong and loud. For others, it cuts volume down to a soft and gentle murmur, without distortion.

Illuminated Dial
A Master Station Selector has an illuminated dial for easy reading in shadowy corners. A single knob permits full tuning for ordinary reception of local, nearby and super-powered stations.

Installation Simplified
A woven table, containing vari-colored rubber covered leads, makes installation and hook-up easy for the veriest novice. No waiting for the radio service man, should the batteries be changed.

Easily Adapted to Consoles
Simply remove screws in escutcheon and in base of set. Lift off metal case. Chassis now stands ready for installation in console cabinet. Opening in console cabinet permits control shafts to protrude. Escutcheon screws in place and—Presto! the console radio is complete.

For A C Operation
A special Bandbox is available at \$65, wired specially for use with the Crosley Power Converter at \$60. This special Bandbox utilizes the new R.C.A. AC tubes which have made the operation of radio receivers direct from house current so simple, efficient and dependable. The first three tubes employed in the AC model are UX 226. These go into the radio

tion of local, nearby and super-powered stations.

Installation Simplified
A woven table, containing vari-colored rubber covered leads, makes installation and hook-up easy for the veriest novice. No waiting for the radio service man, should the batteries be changed.

Easily Adapted to Consoles
Simply remove screws in escutcheon and in base of set. Lift off metal case. Chassis now stands ready for installation in console cabinet. Opening in console cabinet permits control shafts to protrude. Escutcheon screws in place and—Presto! the console radio is complete.

For A C Operation
A special Bandbox is available at \$65, wired specially for use with the Crosley Power Converter at \$60. This special Bandbox utilizes the new R.C.A. AC tubes which have made the operation of radio receivers direct from house current so simple, efficient and dependable. The first three tubes employed in the AC model are UX 226. These go into the radio

IMPROVED MUSICONES



Although Musicones improve the reception of any radio set, they are perfect affinities in finish, beauty and reproductive effectiveness for Crosley Radios. A new model built in the form of a Colonial Tilt-Table with brown mahogany finish, stands 3 feet high. Price \$27.50.

16-Inch Super Musicone (As pictured with Bandbox) \$12.75

12-Inch Ultra Musicone \$9.75

frequency sockets. The detector tube is UY 227, with indirectly heated emitter. Another UX 226 is used in the first audio stage. Raw AC current heats the filament of all UX 226 tubes. Power tube UX 171 is in the last audio socket. This makes the "dog houses" rumble sonorously and the bass drums deep boom.

The Power Converter
The power converter which smooths the alternating current is a marvel of engineering ingenuity. Only half the size of an ordinary "A" storage battery, it supplies the required A, B and C currents, without hum. Finished in brown frosted crystalline. There are models for 25 and 60 cycle current. A snap switch shuts down the set and power converter completely.

Price of Power Converter—\$60
You owe it to yourself to see the "Bandbox" and listen to its remarkable performance. If you cannot easily locate the nearest Crosley dealer, his name and address will be supplied on request. Write Dept. 22.

CROSLEY RADIO

Crosley Radio is licensed only for Radio Amateur, Experimental and Broadcast Reception

Crosley recommends the use of five 201-A Radiotrons and one UX-171 power tube, or Cunningham equivalents which are furnished at standard tube prices, with each Bandbox. While Radiotron UX-171 is 180-volt tube, it gives a superior performance for 135-volt "B" batteries.

THE CROSLEY RADIO CORPORATION
POWELL CROSLEY, JR., Pres.
Cincinnati, Ohio
Prices slightly higher west of The Rocky Mountains

INDEX TO ADVERTISERS

	Page		Page		Page
A		K		R	
Acme Electric & Mfg. Co., The	289	Crosley Radio Corp.	195	Karas Electric Co.	276
Acme Wire Co., The...	258-285	Cunningham, Inc., E. T. Inside Front Cover		Kellogg Switchboard & Supply Co.	279
Aero Products, Inc.	260	D		Kodel Radio Corp.	255
Aerovox Wireless Corp...	276	Deutschmann Co., Tobe...	273	L	
Airgap Products Co.	295	Dubilier Condenser & Radio Corp.	199-269	Lacault Radio Elec. Labs., R. E.	199-285
Alden Mfg. Co.	295	E		Lacey & Lacey	276
Algonquin Elec. Co.	284	Eby Mfg. Co., The H. H...	280	Langbein-Kaufman Radio Co.	274
All Radio Co.	281	Electrad, Inc. 199-260-264-287-291		Leutz, Inc., C. R.	289
Allan Mfg. Co.	264	Electro-Motive Engineering Corp.	287	Mc	
Alter Co., The Harry....	266	Electric Specialty Co.	295	McCall Novelty Co.	285
American Auto & Radio Mfg. Co.	268-270-291	Emerson Radval Corp. ...	270	M	
American Bosch Magneto Corp	260	Engineers' Service Co.	270	M & H Sporting Goods Co.	274
American Hard Rubber Co.	264	Erie Fixture Supply Co....	273	Madison Radio Corp.	291
Amplion Corp. of America.	266	F		Martin-Copeland Co.	279
B		F & H Radio Labs.	277	Massachusetts Radio School	274
Balsa Laboratories	264	Fansteel Products Co., Inc..	273	Metro Electric Co. 259-270-274-276-280-283-289- 290-295-Back Cover	
Barawik Co.	276	Fast Co., John E.	270	Micarta Fabricators, Inc...	199
Belden Mfg. Co.	199	Ferbend Electric Co.	284	Midwest Radio Corp.....	262
Benjamin Electric Mfg. Co.	199	Ferranti, Inc.	293	Miniature Ship Models ...	276
Bogue, B. N.....	266	Formica Insulation Co....	277	Muter Co., Leslie F.	273
Boudette Mfg. Co.	200	Freshman Co., Inc., Chas..	289	N	
Brady, John B.	274	Fritts Co., D. H.	199	National Carbon Co., Inc..	266
C		Frost, Inc., Herbert H....	283	National Co., Inc.	199-262
C. E. Mfg. Co., Inc.	199	G		National Radio Institute.	197-271
Inside Back Cover		Gearhart-Schlueter	283	Niagara Metal Stamping Co.	266
Cable Supply Co., Inc....	283	General Radio Co.....	274	Norden-Hauck, Inc.	295
Cardwell Mfg. Co., The Allen D.	199	Goodrich Rubber Co., The B. F.	274	North American Bretwood Co.	261
Carter Radio Co.	199-274	Gould Storage Battery Co.	281	O	
Central Radio Labs.	290	Gray & Danielson Mfg. Co.	283	Omnigraph Mfg. Co.	275
Chemical Institute of N. Y., Inc.	265	Guaranty Radio Goods Co.	261	P	
Chicago Radio Apparatus Co.	278	H		Parker, C. L.	276
Chicago Salvage Stock Store	278	Hammarlund Mfg. Co..	199-275	Polymet Mfg. Corp.	274
Cloverleaf Mfg. Co.....	296	Hampton-Wright	267	Press Guild, The.....	262
Columbia Radio Corp.	293	High Frequency Labs.	285	Q	
Conrad Co., Inc. 276-280-282-284-286-290-294		I		Q. R. S. Music Co.	293
Cooper Corp., The	293	International Resistance Co.	266	X-Y	
Cornish Wire Co.	264	Interstate Sales Co.	199	X-L Radio Labs.	199-287
Coyne Electrical School...	284	J		Yaxley Mfg. Co.	268
Cresradio Corp.	266	Jewell Electrical Inst. Co..	273		

Designer of Broadcast Station WEMC



Tours Europe On Inspection Trip.

HOW WOULD YOU LIKE TO HAVE JOHN FETZER'S JOB?

Would you like to tour Europe with all your expenses paid? You would? My friend John Fetzer DID! Maybe you'd like to hold a fine job as Chief Engineer of a widely-known American broadcast station? That's what John Fetzer is right now—Chief Engineer of Station WEMC, "The Radio Lighthouse," located at Berrien Springs, Mich. Read his interesting letter at the right.

Will YOU take a Better Job—More Money?

If I offered you a job like John Fetzer's at \$100 or \$150 a week, would you take it?

If I told you that to get this job you would have to do a little studying, say half an hour a day for a few months, would you do that, too?

You bet you would. You probably even think I'm foolish to ask you such questions. But, as a matter of fact, you today have such an opportunity in the same place John Fetzer found his—in the brand-new, growing Radio Industry.

Plenty of Plums Still Left on the Tree

We've just barely scratched the surface in the Radio business. There are plenty more opportunities just as good as the one John Fetzer grasped.

You'll have to do some studying before you can hold down one of the good jobs—only well-trained men are wanted.

But that part isn't hard—lots of men without a grade school education have done it. And it only takes a comparative short time at studying about half an hour a day. You can keep right on with

your present job, and learn in the quiet of your own home.

Get My Big Free Book

300,000 new openings have been created by the swift growth of the Radio business in the past few years. During the same years I have helped thousands of men to take advantage of opportunities like these.

John Fetzer, whose picture you see above, is only one man among these thousands I've helped. Lots of the others didn't climb as high as Fetzer, but there are some, too, who have gone higher.

I'm ready to help you, too, if you are looking for a better job and more money. The good jobs in Radio pay from \$50 all the way up to \$250 a week. And the accomplishment of television, trans-Atlantic Radio telephony, the other new inventions constantly being made, all point to even greater things for the future. If you're ambitious and dissatisfied with your job or your future, let me help you share in the Rich Rewards of Radio.

Mail the coupon below for my big free book about Radio, its opportunities, and how I train you, quickly and easily in your spare time at home, to take advantage of them. No previous experience needed. You learn by doing, with six big outfits of practical experimental material I send you at no extra cost. Mail coupon now for book—Address: J. E. Smith, President, National Radio Institute, Washington, D. C.

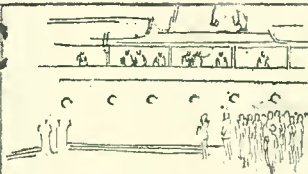

Dear Mr. Smith:

I went to Europe at the expense of my station, WEMC, to learn the best methods used there and bring them back for my station. I found about 20 stations in the British Isles, mostly used to relay programs from 2LO. They were very kind to me at 2LO—their equipment is about like that of our own good stations.



French stations, I found, don't compare with the British. There are 6 important stations in France. Eiffel Tower is the best known. I visited Holland, Belgium and Switzerland, and got a real thrill from seeing the big station at

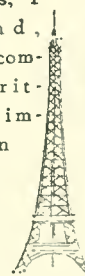

Nauen, Germany. On my return I designed and built the new high



power station for WEMC, using best features of what I had

seen. Our first program was reported in 40 States. Your training is the way to lasting success in Radio.

John C. Fetzer

John C. Fetzer

John C. Fetzer



J. E. SMITH, President of the National Radio Institute, Washington, D. C., has directed the training of more men for the Radio profession than any other educator. The National Radio Institute is the oldest and largest Radio home-study school in the world.

Originators of Radio Home Study Training

HERE'S THE SAME COUPON THAT FETZER CLIPPED

This Book FREE!



C O U P O N

J. E. Smith, President, National Radio Institute, Dept., [K.B.-9], Washington, D. C.

Dear Mr. Smith: Kindly send me your free book "Rich Rewards in Radio," and all information about your practical, home-study Radio training. I understand this places me under no obligation.

Name _____

Address _____

Town _____, State _____

RADIO NEWS

AMATEURS' HANDIBOOK

New! 1927 Edition

50c

Bigger,
Greater
and More
Valuable
Than
Ever

116
Pages
of
1927
Radio
with
Elaborate
Circuit
Diagrams
and Illus-
trations



The
Only Book
of Selected
Radio
Features
of the
Year

This is
the
4th
Great
Yearly
Edition

Just
Off
the
Press

Sold
on all
Newsstands

Here is the greatest Radio Handibook ever published!

Right up to date—a brand new edition of the very finest selected articles that have appeared in "RADIO NEWS," Radio's Greatest Magazine, this year.

All new Radio—Plenty of latest model circuits with blueprint diagrams, ready for building. This is the most popular Radio Book ever published. The past three editions were completely sold out.

—And you we offer the biggest and best edition of them all. Get your order in early—send it in today. Send 50c with this coupon or see your dealer.

EXPERIMENTER PUBLISHING CO., Inc.
230 Fifth Avenue New York, N. Y.

THE EXPERIMENTER PUB. CO., Inc.
230 Fifth Ave., N. Y.

Gentlemen: I enclose 50c for one copy of
"Radio News Amateur's Handibook."

Name

Address

City, State

Combines the Best Features of Every Circuit
Radio's most amazing set

The STROBODYNE

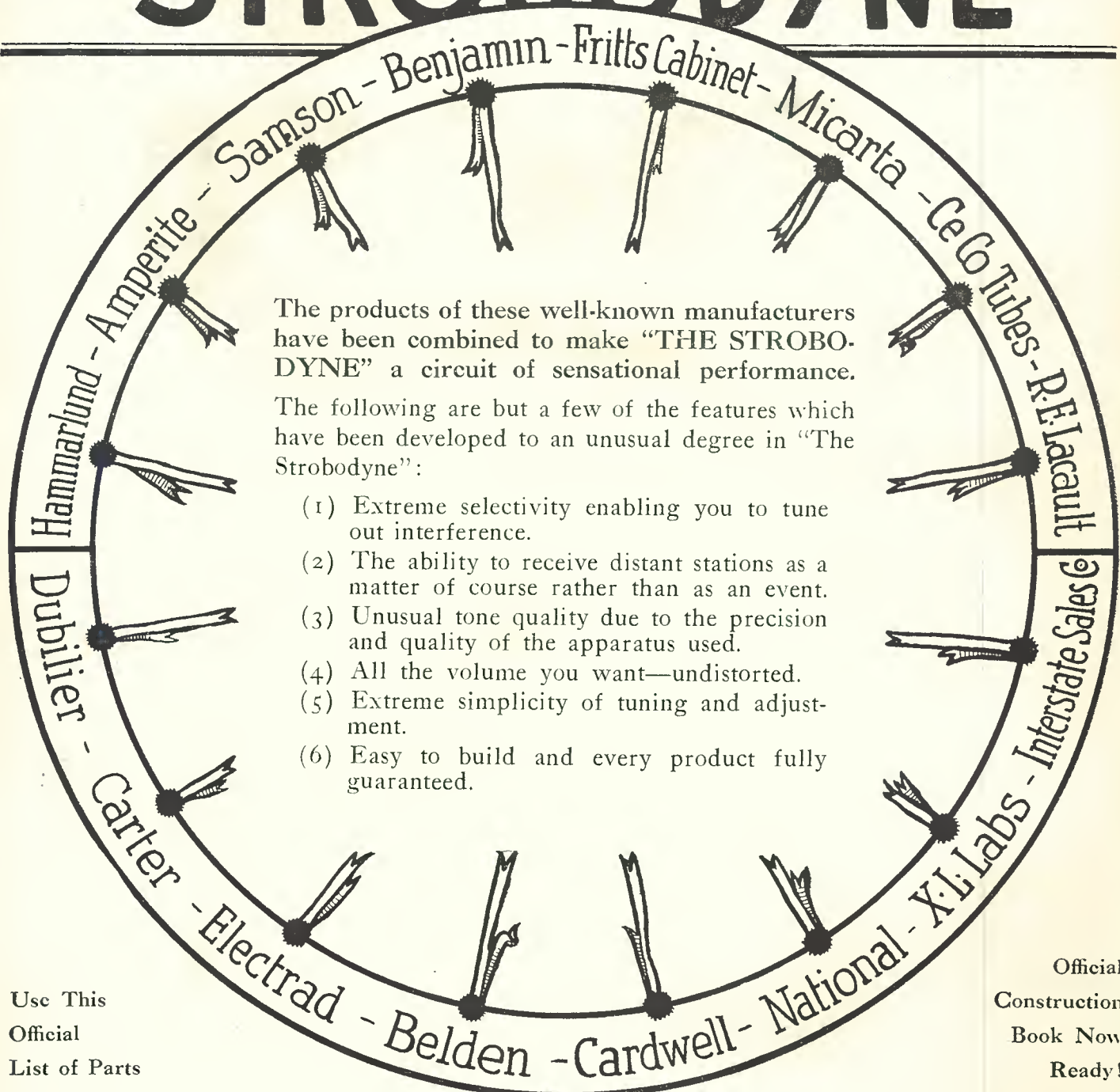

The products of these well-known manufacturers have been combined to make "THE STROBODYNE" a circuit of sensational performance. The following are but a few of the features which have been developed to an unusual degree in "The Strobodyne":

- (1) Extreme selectivity enabling you to tune out interference.
- (2) The ability to receive distant stations as a matter of course rather than as an event.
- (3) Unusual tone quality due to the precision and quality of the apparatus used.
- (4) All the volume you want—undistorted.
- (5) Extreme simplicity of tuning and adjustment.
- (6) Easy to build and every product fully guaranteed.

Use This
Official
List of Parts

Official
Construction
Book Now
Ready!

- 3 Hammarlund Variable midline condensers .00035 mf.
- 1 Set Hammarlund Strobodyne coils
- 3 Hammarlund Shields
- 2 Hammarlund Equalizing Condensers
- 1 Hammarlund Brass Shaft 10 1/4 inches long
- 2 Samson Symphonic Transformers
- 1 Samson No. 85 Choke
- 4 Radio Electric R.F. Units Type F
- 5 Radio Electric Fixed Matched Condensers
- 1 Micarta Fabricator Panel 8" x 24" x 3/16"
- 1 Micarta Fabricator Sub Panel 12" x 25 1/4" x 1/4"
- 1 Interstate Sales Output Filter
- 3 Carter No. M-20 Midget Rheostats 20 ohm
- 1 Carter No. M-400 Midget Potentiometer 400 ohm

- 1 Carter No. 1 Short Jack Open Circuit
- 1 Carter No. 2A Short Jack Closed Circuit
- 1 Carter Imp Battery Switch
- 1 Cardwell Balacet Type 618A
- 4 Dubilier By-Pass Condensers .5 mf. Type 907
- 1 Dubilier Fixed Condenser .002 mf. Type 601
- 8 Benjamin Sockets UX Type 9040
- 12 X-L Binding Posts
- 2 National Co. Dials
- 4 Radiall Amperites Type 1A
- 1 Radiall Amperite Type 112
- 1 Electrad Royalty Variable Resistance Type B
- 2 25 ft. coils Belden Colorubber
- 7 CeCo Vacuum Tubes Type 201A
- 1 CeCo Vacuum Tube Type 112
- 1 Fritts Cabinet for Panel 8" x 24" x 12 1/4"

"STROBODYNE"
230 Fifth Ave., New York

I enclose 50c. for one copy of the official construction book, giving all data on the STROBODYNE, and all supplementary information.

Name

Address

City

State

Address all inquiries to "STROBODYNE," 230 Fifth Ave., New York

Yes Sir, that's the New Sonochorde Jr.!



The SONOCHORDE Cones

WHETHER you choose the Regular or Junior Model, you buy Sonochorde quality—a cone speaker you can show your friends without apology. Back of each Sonochorde is the oldest and largest organization in America devoted solely to the manufacture of quality radio speakers. The 1928 Models represent even finer examples of the acoustic art than ever before produced. Both Cones incorporate the famous patented Sonochorde unit and are finished in mahogany with rich wine-colored silk fronts and protected backs—objects of beauty matched only by their superlative performing qualities.

Ask your dealer to show you the 18 exclusive Sonochorde features or write for Illustrated Circular.

Dept. A

BOUDETTE MFG. CO.
Chelsea, Mass.



\$15

Junior Model

Slightly smaller than the Regular Model with a simplicity of outline all its own, the Sonochorde Junior is a most fortunate choice. See and hear it.

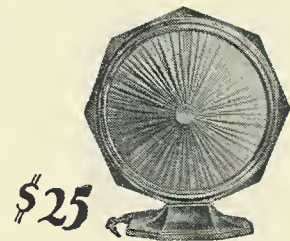

\$25

Senior Model
(Regular)

Truly the Speaker of Eloquence—the leader of the Sonochorde line. Also furnished in Wall and Floor Standard Models including all Sonochorde features. On sale by good dealers.

If you have trouble securing your Sonochorde, write us for your nearest dealer's name.



RADIO NEWS

HUGO GERNSBACK,
Editor and Publisher

Editorial and General Offices, 230 Fifth Avenue, New York

Vol. 9

SEPTEMBER, 1927

No. 3



A RADIO UTOPIA

By HUGO GERNSBACK



WE Americans are prone to pat ourselves on the back when we contemplate that, in the radio art, we have always been first, and still are far ahead of all other nations. In America the radio amateur movement back in 1910 first reached wide proportions and, again, in America we had the jump on the rest of the world, when broadcasting started. We have maintained this lead ever since. We have more broadcast stations than all the rest of the world and more radio sets in the United States, by far, than in any other two nations. All of this is not said in any vainglorious spirit, but simply as a statement of fact.

On the other hand, when it comes to telling the rest of the world about the greatness of America, and our achievements in all other directions, radio, with all its vaunted development in this country, has as yet a great and important duty to fulfill.

To make plain what I refer to, let me mention only one instrumentality that, perhaps more than all others combined, has Americanized the rest of the world. That instrumentality, as every one knows, is the motion picture. The world has learned more about America, its customs, its institutions, and its civilization, from the motion picture than from anything else. The reason, of course, is simple. The motion picture, due to the diligence of the film industry, has been broadcast over the entire globe, right into the lives of the millions of inhabitants scattered over our planet.

Nor has the American motion-picture industry permitted the lead to be taken away by another country. It may be said, therefore, that the American motion picture is supreme in the world today; and particularly when it is pointed out that it is the greatest single missionary of America, and, incidentally, of world peace.

Let us now turn to radio, and see how we appear in this light; that is, if we wish to draw a parallel between American radio and the motion picture. We actually find that American radio is known in foreign countries only through the press and through news items. The man in the street, indeed, the average man who owns a radio set, never hears American programs; or does so only if he is one of the few select experimenters who use short-wave sets.

We know, of course, that no radio transmitter in the United States can reach far over its borders, except into Canada and Mexico. When it comes to Europe or Australia, Asia, or Africa, American programs are practically never heard there, except on special short-wave sets, which may be left out of the discussion because there are so few of them.

Let us now say that the entire civilized population of the globe, no matter where located, should be in a position to listen every day to American programs. Would that not be performing a great service for this country? Would it not, in a great measure, help to maintain the peace between America and others, and would it not, like the motion-picture industry, be the best missionary that we could possibly have in foreign countries?

Therefore I propose my plan. I know that it may sound fantastic and Utopian in the extreme; but, if some one had told you, thirty or forty years ago, that the motion-picture industry would become what it is today, it would have sounded, perhaps, far more fantastic than the plan which I am about to propose.

The plan, in short, is to erect in this country five ultra-power broadcast stations—a perfectly feasible project for the present-day radio art. These stations, of course, could not be self-supporting, but might be partly supported by advertising, and perhaps otherwise

through the subsidy of a number of rich men, of whom we have plenty in this country.

I propose to erect five super-power stations, each of a minimum power of 25,000 kilowatts. If this figure could be increased to 50,000 kilowatts, so much the better.

Suppose we have four stations at the four corners of the country, as follows: one in the northern part of Maine, to cover Europe and Africa. The second, in the lower part of Florida, would cover South America. The third, in the northern part of the State of Washington, would cover Asia. The fourth, in Southern California, would cover Australasia. Each of these stations would operate on anywhere from 25,000 to 50,000 kilowatts; and each station would be a beam-transmission station, sending a beam fan-wise toward the continent that is to benefit by the reception.

The most powerful broadcast station in this country now operates on about 50 kilowatts. It covers a range of about 500 miles, on an average, consistently. The transatlantic radio-telephone operates on between 100 to 250 kilowatts; by means of which the Atlantic is now bridged by the human voice every day.

It will be seen, therefore, that the ultra-power stations which I propose are of a power at least 100 times greater than those in use now. That, however, need not disturb us; because even a station that operates on a power of 25,000 kilowatts would not use more power than one of the giant ocean liners in use today.

The fifth station would be located somewhere in the center of the United States, at a suitable location. This would not be a beam station, but would be used for general broadcasting for the United States itself. Now, the plan would be to tie all five stations up by the usual telephone net, and to broadcast from point, such as New York, Chicago, or San Francisco, whichever would be deemed advisable. The five stations could operate on a single wavelength, all being controlled by crystals, if necessary, so that only a single wavelength would be required. This would mean that there would be no conflict in their reception in the various parts of the world, and the special wavelength would soon become recognized as that of America. With 25,000 to 50,000 kilowatts power, a good signal could be laid down over practically all civilized parts of the world. Thus, for instance, the station in Maine would lay down a good signal that could be heard at practically all times of day as far as Moscow. The reason here is that transmission over the sea is much better than over land.

The plan, I admit, is fantastic, but certainly not more fantastic than radio itself was forty years ago. Against the plan may, of course, be cited, first, the tremendous expense of operating the stations; but we need not be concerned with this at once, for the simple reason that in time, I believe, with a partly-commercial program, the five stations would perhaps maintain themselves.

The second, and more important, objection is the time-difference; but this is not insurmountable either, because we could broadcast during our day, which, for part of the globe, would be night time. The night programs could easily be repeated in daylight the next day, by having the program of the previous evening recorded on a telegraphone, if this should be necessary.

A third objection will be raised on the score of the difference in languages; but, more than ever before, radio listeners of the world are familiarizing themselves with English; and the establishment of these stations, with their programs regularly audible, would give a tremendous impetus to this movement. And that is what we want.

IN which the Editor falls in with the belief that American radio development leads the world—but compares it unfavorably with the American motion picture in the matter of international influence—and suggests a method by which America can express herself to the entire world through the ears of its radio listeners—the possibilities of radio broadcasting by ultra-power world stations—and their effect in promoting international better understanding from Moscow to the Argentine and from the North Cape to New Zealand.



The Community Set Builders

A Survey of an Important Factor in Radio Production, Hitherto Unclassified



By **ARMSTRONG PERRY**

OF late there has been developed a special and important market for the radio manufacturer. This new outlet may be described under the name of "Community Set Builders." From a small beginning, several years ago, it has grown to a respectable size; so that today the community set builders are to be reckoned with in the sum total of our annual radio turnover.

The community set builder competes with no one, but simply takes care of the business that otherwise would be lost entirely. In this respect the community set builder compares with the small garage and repair shop in a rural community, or at some crossroads which cannot support a larger institution.

The community set builder is usually found in the very small community where there are no radio dealers. He, thus, does not compete with the legitimate dealer; but, quite the contrary, in time, becomes a dealer himself, from small beginnings.

These home builders are now being actually encouraged by most radio manufacturers, as Mr. Perry's thorough investigation, made on behalf of RADIO NEWS, will show. —EDITOR.

MANY of the men who began building radio sets in spare time because they enjoyed the work have capitalized their ability by becoming "community set builders."

They no longer have to limit their purchases of parts by what they can save out of their weekly expense money. They buy all they want, build any kind of set that interests them, try all the new appliances. The cost often runs into large figures; but that does not matter, because there is a

direct financial return. As soon as a set is working well it is shown to the neighbors and sold at a good profit.

This is one of the most logical developments of modern radio. The increase in the use of receivers has been marvelous, but the homes without radio still outnumber those that use it, four to one. Most men could build radio sets for their homes if they would; but gardens, cars, golf, books, cards, shows and other pastimes take their attention. Comparatively few ever get around to it. Many go without radio, simply because so many radio dealers are not salesmen and merely wait for customers to come in and buy their goods. Thousands of persons who might become customers never are approached. The community set builder fits the situation and meets a real need.

EASIER TO SELL IN THE HOME THAN ANYWHERE ELSE

In a radio store there may be sets priced all the way up to \$2,500; and the highest range of prices is prohibitive for the average family. Many customers feel embarrassed when they cannot afford to buy the best. Others are suspicious of salesmen, thinking that they always try to sell as expensive sets as they can—and perhaps to unload, upon those who know little about radio, the things that the concern needs to get rid of. But when a man or woman calls at a neighbor's home to hear a home-made set, there is no prejudice or embarrassment. A man who has built a set often talks about it and explains its operation as interestingly as he talks about his car. The visitor becomes interested at once.

The community set builder brings in a concert. Knowing his receiver from base-board to loud speaker, he smooths out the reception and eliminates a lot of noise that is often tolerated in the belief that it is caused by "static" and cannot be shut out. He explains how to tune and adjust the re-

ceiver and lets the caller try it. Usually this leads to a request: "I wish you would make me a set like that."

At that point the community set builder can clinch the sale by letting his neighbor have the set "as is." He can take it over to the home and install it without delay. There is no sales resistance to overcome, and no running up of overhead expense by sending employees to do the job. There is mutual confidence, because there is close contact. The first sale usually leads to another and another through that most potent of all advertising—the enthusiastic praise of satisfied customers. Many a community set builder, without a cent of advertising or office expense, finds his spare time filled with profitable orders from those whom he knows so well that he can let them have sets, on easy payments, without risking a dollar.

A BIG ORDER

There are two brothers on Long Island who began buying parts from the Waltham Electric Company of New York some time ago. One of them dropped in the other day and bought 400 amplifying transformers. Their purchases had increased gradually for months; but this order took the salesman by surprise. He asked some questions.

"We started building sets in our home," the customer told him. "We are still working at home, on full time now, and my brother and I are taking a hundred dollars a week out of the business, each one of us. We have bought ourselves good cars and we cover more territory now than we did at first, but we are still community set builders. My brother builds the sets. He can assemble a three-tube outfit in fifteen minutes, for we have the panels all drilled and everything ready. I do the outside work."

BUILDS FOR SAILORS

The same company has some other interesting customers who are community set builders in one sense or another. One of them roves the water front in a seaport city and makes the acquaintance of officers and men from the navy and the merchant marine. The C.P.O.'s and quartermasters, the "Chips," "Paints" and engineers used to have phonographs in their quarters; perhaps they still have them, but they all want radio sets too.

Usually they want a receiver with a loop aerial, for outside wires are likely to be in the way of the ship's gear, and where there is a loop aerial there must be many tubes. A sailor has little chance to spend money until he goes ashore; and even if he should lose his pay shooting craps it cannot leave the ship while she is at sea. Any group of sailormen can raise the price of a good radio set, if the builder gets to them before they have wandered too far from the gang plank. This set builder, by square dealing and expert construction, has worked up a patronage that keeps him busy and prosperous.

Another steady customer for radio parts is a salesman who makes five or six trips to Europe every year. Most men would think that such a job would shut them out from spare-time set building; but this man knew that there is more spare time on shipboard than anywhere else. He built a portable set and operated it in his stateroom. Other passengers listened, then they peeked, and finally came in. He was invited to operate his set in the lounges and in the dining salon at meal time. Then the orders began to flow in.

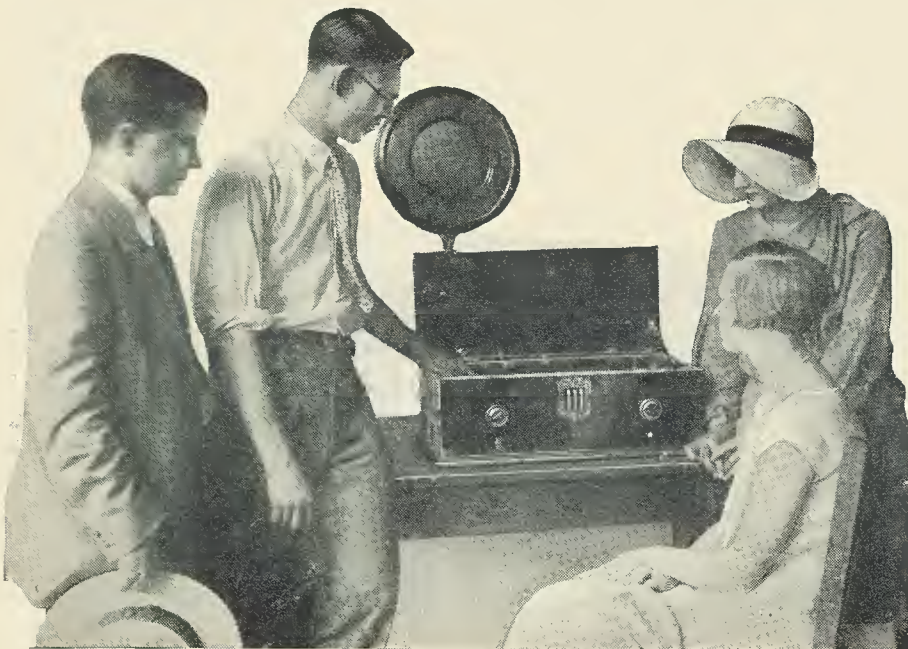

A man who has built a set talks about it as interestingly as about his car, especially if he has visitors interested in radio. He demonstrates it expertly and smoothly.



Community set builders erecting an antenna.

Outward or inward bound, it was all the same; the passengers were going home some time and they wanted radio sets built by the man whom they met at sea. The day I was at the dealer's, this set builder dropped in and handed a salesman \$100 as a deposit. "Have the parts for six power packs ready for me when I come back in a couple of hours, will you?" he said. His orders for parts run as high as \$1,000. He does his work at home or on shipboard whenever he has the time.

VETERAN REHABILITATES HIMSELF

Over in Canada lives a young man who went into the world war with the first Canadian troops, when he was seventeen, and came back home a wreck. His heart was the seat of his trouble; fortunately he did not lose his hands or feet. He could not hold a job and any work that taxed his strength was dangerous. He knew a little about radio and built a receiver for his own amusement.

A neighbor saw it and wanted it. The constructor sold it and built another. That one went quickly also, and then he began to see possibilities. Within a year his receivers were scattered throughout the community and the surrounding country and he was operating a home-built broadcast station; so that his customers who bought one-tube sets would be sure of receiving programs every day.

An advertising man on a New York daily newspaper was paying for a home over in New Jersey. He began building a radio receiver, with the usual result: he stayed up until all hours of the night. His young bride objected, naturally. A neighbor heard the set and bought it. The set builder quickly produced another. Before long the mortgage, which had been a stubborn proposition, began to shrink, as one set after another was purchased by folks in the community who wanted receivers built by someone whom they knew. Wife's attitude has changed, too; possibly because the time required to build a set is very short after a man has had a little practice.

A radio inventor in Pennsylvania needed to test his inventions in homes where he could check up the results frequently. He

became a community set builder, after he found how expensive it was to build and lend sets for the purpose of making tests. No customer objected to his changing and adjusting a set as often as he pleased; in fact all were delighted to have so much free service.

BUILDS SETS AT NIGHT

A minister in Pennsylvania became a community set builder, not for the sake of making money but in order to serve his parishioners. A sick child was the cause of his building his first set. He had to give the child medicine every half hour during the night and he decided that, since he must sit up, he might as well spend the time in making a radio set that his wife and eight children could enjoy. The night watches passed more rapidly after that and in a few days the set was completed.

It was such a success and gave his family so much pleasure that he thought of radio every time he made a pastoral call. He made a set for his father and, the moment the last connection was made, the receiver surprised them by bringing in a broadcast by one of the minister's parishioners. He began recommending radio wherever he thought it was needed; and when a member of his flock was at a loss to know how to secure a receiver, he offered to build one practically at cost. Some in his community testify that the service he rendered through radio was as great in some cases as the good he did with his preaching. Some who were unable to hear him on Sunday mornings brought in church services by radio with the sets he built.

SPECIAL WORK

The Radiall Company states that, from correspondence received at its office, it is obvious that there is a good deal of set building going on by what are known as professional set builders. These men usually exploit some popular construction or some special circuit which it may not be possible to duplicate in a factory-built receiver. Sets of this kind are usually sold in the professional's circle of friends, or to people to whom he is introduced by his friends.

It is the experience of this company that very few of these builders carry any stock of accessories or parts; most of them preferring to do their buying as their orders come in. Their purchases are made usually through the medium of the specialized mail-order jobbers, through whom they may obtain the material at a somewhat lower price than directly from their local dealer. Since a radio set is made up of standard parts, the list prices of which are quite public, these builders prefer to accumulate their margin of profit on their purchases of these parts, so that the finished set may sell slightly above the actual list cost of the merchandise it contains.

The Manhattan Electrical Supply Company, which began selling radio apparatus many years before the broadcasting era, recalls that a certain type of community set building originated several years ago in an army post. Some radio enthusiasts built a receiver and connected it with loud speakers in the officers' quarters and the barracks. Soldiers still build radio sets; for R. E. Lacault reports that among the customers of the Radio Electric Laboratories, who build and sell Ultradyne sets made from his kits, is a sergeant at an army post.

The Radiall Company reports a trend toward simplicity and fool-proof operation. Community set builders are using self-adjusting rheostats; so that filament control, one of the most perplexing problems of a radio circuit, may be obviated and forgotten so far as the operator is concerned. All that he has to do is to turn a switch and tune in. One community set builder reported recently that he was working on his one-hundred-and-

twelfth set, and that all went to buyers in rural districts who had no conception of the mechanism of radio and therefore wanted sets as simple as possible.

CHANGES IN THE RADIO BUSINESS

The business of some radio manufacturers has changed radically. Not long ago 90% of the customers of Norden-Hauck, Inc., were buying parts, but during the past year 90% have purchased constructed sets. The company says that this may be due to the fact that the best parts are too expensive for the beginner; or the professional set builder may be turning entirely to wholesale houses for complete equipment. Some houses cater to the custom set builder, and this company believes that he should be classified as a small manufacturer.

Reports concerning the community set builders vary in different localities. Hampton-Wright of Indianapolis heard little about them until recently, but has had a constantly increasing business from them during the past few months. This concern reports that, while one might expect the less accessible communities to be more productive territory for the community set builders, it is their experience that they are more numerous and larger buyers in the more thickly populated districts. Last March the state of California suddenly forged ahead as a buyer of parts for home-built sets. Maine is always a heavier buyer than many near-by states.

The community set builder may be known as such among manufacturers and dealers, for only a brief period. After he has made and sold a few sets he begins to buy parts in larger quantities, secures wholesale prices and becomes known in the business as a professional set builder or radio dealer.

THOUSANDS ARE KNOWN

The Leslie F. Muter Company of Chicago learns of many community set builders through letters received by its service department. Their requirements always have been attended to through jobbers; who, the company understands, place them on a dealer basis when their requirements and influence in the community justify it.

(Continued on page 281)



A portable superheterodyne built by a community set builder.



Lamp-Socket Operation

Four Distinctly Different Methods Are Now Clamoring for Favor



SINCE the earliest days of broadcasting, the operation of receiving sets on current drawn from the standard 110-volt A. C. lighting circuit, instead of from batteries, has been one of the most coveted goals of both designers and users. It was recognized that such a source of power supply for vacuum tubes, if practicable, would offer a degree of convenience, economy, and permanence not possible with batteries.

As most fans know, lamp-socket operation is now a thoroughly practical reality. In fact, during the last year it has been the most talked-of development in radio. But instead of one, there are no less than four methods of socket operation available—all successful, but each different from the rest. The result is that many set owners find themselves perplexed and confused when they attempt to adopt lamp-socket operation. So it seems worth while to consider just what these various methods are, stripped of befogging technicalities, and what they offer the average owner of a receiving set.

There has, of course, been no great difficulty about harnessing lighting current to provide "B" power. This has been accomplished by means of the "B" socket-power unit—now a familiar piece of standard radio apparatus—consisting of a transformer for supplying the desired voltage, a rectifying unit designed to convert the alternating current into direct, suitable resistors, and a filter unit for removing the objectionable alternating-current hum. (Truth compels the admission that this hum is still present in some inferior makes.) It is worth mentioning, however, that there are in common use three types of rectifying devices—the feature in which most "B" units on the market differ.

TYPES OF RECTIFIERS

The first is the rectifier valve—a vacuum tube designed especially for the conversion of alternating current into direct. (Two general types are available: the full-wave, converting the entire A. C. cycle; and the half-wave, converting only one side of the cycle.) The second is the electrolytic type, comprising a number of metal plates immersed in a solution, often an acid like that employed in storage batteries; and the third is the "dry" type, consisting of especially-prepared plates which require no solution. Each will give satisfactory results and can be depended on to give a good account of itself in service.

The first has the advantage of requiring a minimum of attention; but this is balanced by a slightly higher cost of upkeep, since the

By CHAS. M. ADAMS

tube will have to be replaced after 2000 to 5000 hours of operation. In the second, distilled water must be added occasionally and, after prolonged use, new plates installed; this last also being necessary in the dry type. But the cost of replacement is small, thereby compensating for the increased attention required. Choice between the three types resolves itself into a matter of personal preference and individual requirements. However, it must be borne in mind that the "B" unit chosen should be able to deliver not only the necessary voltage, but also the amount of current (in milliamperes) required—a point sometimes overlooked.

It is the "A" or filament-current supply which has presented the big problem in lamp socket operation, because of the much larger amount of current required.

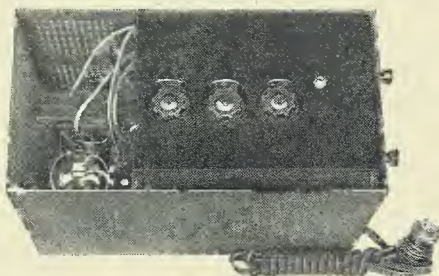

A combination tube-type charger and storage battery which conserves space.

Photo by courtesy of Stewart Battery Co.

THE "A" UNIT

The first and most familiar type of apparatus for accomplishing this result is, of course, what has come to be known as the "A" unit, consisting of a trickle charger in combination with a storage battery. (It is also possible to make up a similar unit from a separate battery and charger.) The battery is of the usual type, though often of smaller capacity; and the rectifying unit of the charger may be of any of the three types mentioned in connection with "B" units. Many are now equipped with an automatic switch, which disconnects the charger when the filament switch on the receiver is turned on, and connects it once more when the switch is turned off; at the same time connecting and disconnecting a "B" unit which can be plugged in on the "A" apparatus, combined or singly, such an "A" apparatus, with a "B" unit makes up a thoroughly sat-

Manufacturers now frequently combine such an "A" unit with a "B" device to give a single unit for supplying both "A" and "B" power from the lighting circuit; and, either

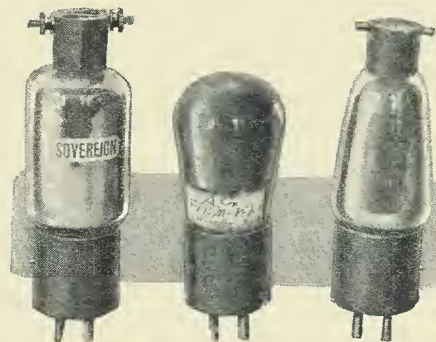

Three types of tubes, whose filaments are heated by raw alternating current.

Photos courtesy of the Sovereign Electric & Mfg. Co., the Van Horne Co., and the McCullough Sales Co.

isfactory piece of equipment which can be adapted to any receiver using standard storage-battery tubes.

This flexibility is its chief advantage; the greater because it is possible to use any combination of the several types of special purpose tubes now available. But it must not be forgotten that such a unit does not eliminate the "A" battery.

It seems necessary to emphasize this in the light of misleading statements being made by a few manufacturers, suggesting that the battery is eliminated, and hence no attention is required. Attention is required, and will be inevitably as long as a battery is employed. Fresh water must be added occasionally, and hydrometer readings taken; and, for best results, the charging rate should be checked from time to time. But the amount of care demanded is considerably less than if the battery had to be removed from the receiver; this, with practically automatic charging, is the advantage of such a unit. A surprisingly small amount of care, if intelligent, will assure an excellent and economical supply of "A" power.

The second type of filament supply from the lighting circuit, the true "A" eliminator, does offer freedom from much of the care required by a battery. It consists of a filter of new design, either combined with or separate from a charger of the heavy-duty type. Like the "A" unit, it can be adapted to any standard receiver, and makes possible the use of standard storage-battery tubes of any combination desired. Where both charger and filter are built in a single case, it can be equipped with an automatic switch controlling a "B" unit at the same time; thus making it possible to assemble a complete lamp-socket unit.

This too requires some attention, in the form of supplying distilled water occasionally, and at present its price is 25% to 100% higher than that of the usual "A" unit employing a battery; though there are prospects that this may be reduced with quantity production.

SERIES-FILAMENT ARRANGEMENT

Radically different in principle from both the types so far mentioned is a third method of securing "A" current from lighting circuits, recently developed, known as the series-filament arrangement. In this, as its name suggests, the filaments of the tubes to be operated are connected in series, instead of in parallel as usual; and the current is sup-

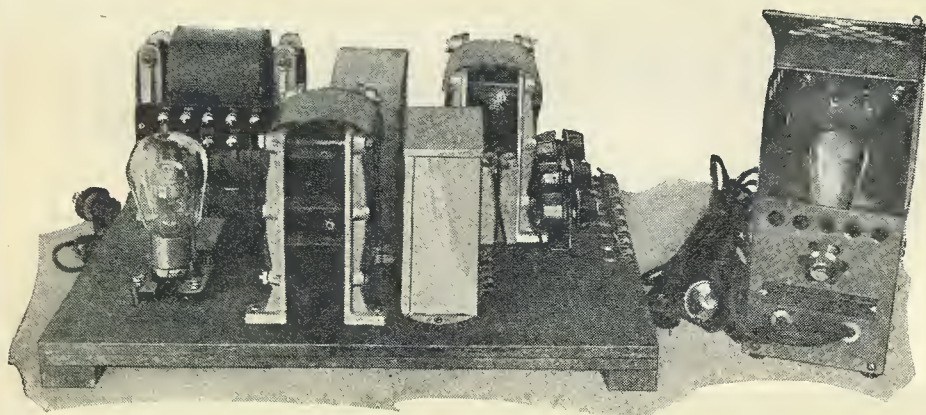

At the left is a 350-milliamperer "A, B and C" unit for 201-A tubes in series; and at the right an 85-milliamperer unit for 199-type tubes in series.

Photos courtesy of Acme Apparatus Co., Raytheon Mfg. Co., and Crosley Radio Corp.

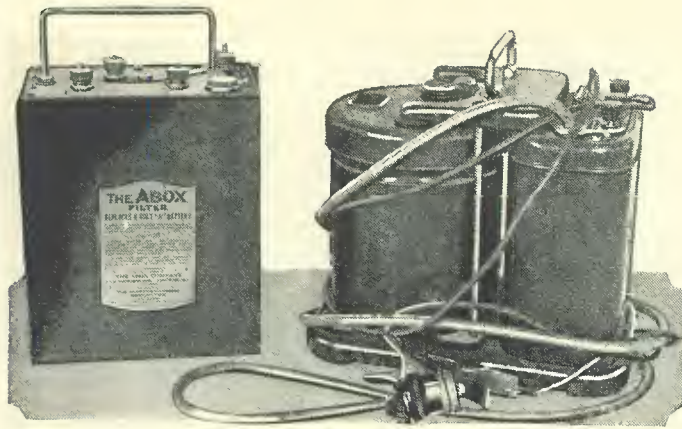

By using a filter which smooths out the ripple that is presented in the output of a chemical trickle charger, a filament current may be had which will result in no hum in the loud speaker from the A. C. lines. When using equipment of this nature no wiring changes are necessary in the receiver. The filter shown at the left of the illustration is connected between the charger and the receiver "A" terminals, for the filament. Photo by courtesy of The Abox Co. and the Faustel Products Corp.

plied by the customary "B" power unit. (A power tube is often employed in the last audio stage, with its filament lighted by unrectified A. C.) The result is simple and satisfactory operation without the necessity for any separate "A" supply, and therefore requiring only the upkeep and care of the B unit.

Tubes of either the 199 or 201A type may be operated in this manner, as suitable rectifier tubes, capable of passing as much as 400 milliamperes, are now available.

Because the filaments are connected in series instead of parallel, receivers designed for operation in this fashion must be especially constructed. (Many have a milliammeter built in the panel to insure that the filament current shall be kept at the prescribed figure.) But, when a new receiver is being purchased or built, and the fan does not wish to use any special-purpose tubes, this series-filament arrangement offers attractive possibilities in freedom from attention and trouble.

A. C. TUBES

Also quite different from the first two types, as well as the third, is the fourth method of obtaining "A" power from lighting circuits—that employing special alternating-current tubes, as against any of the usual direct-current types.

Several makes of these, based on various principles, are now available, with prospects that more will follow as development work progresses. As their name suggests, they are constructed to permit their filaments to be heated by alternating current instead of direct; the only apparatus between them and the house-lighting lines is a small transformer for stepping down the voltage. As now manufactured, they give operation as satisfactory as that of tubes employing battery power, they operate without hum, and, in some cases, have the additional advantage of longer life.

But, like the series-filament arrangement, they require sets built expressly to accom-

modate them, either because of different connections from the usual or, in some cases, because of different mechanical construction. Also, their cost is considerably higher than that of ordinary tubes, often more than

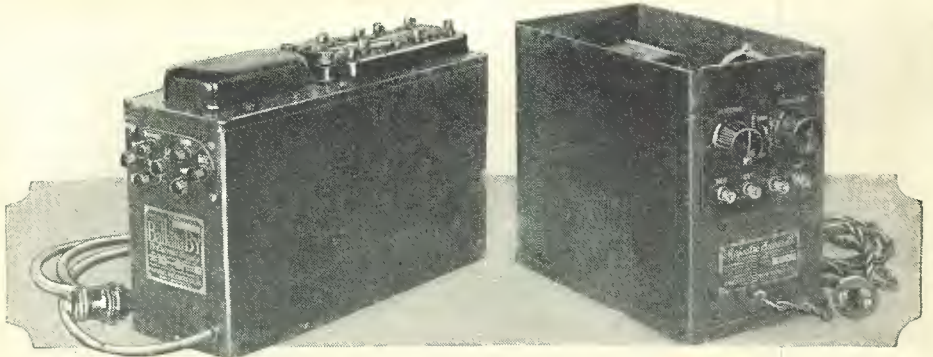

The "B" socket-power unit at the left is of the chemical type; and the other uses a rectifier tube. Photo by courtesy of Faustel Products Co. and Grigsby-Grunow-Hinds Co.

100%, a condition which, it is hoped, can be corrected by quantity production.

At present, therefore, their use would seem to be limited to those who wish to buy or build receivers designed expressly for such tubes.

PRO AND CON

So, by way of summing up, the status of lamp-socket operation, just now, can be said to be about as follows: If you want to buy or build a standard receiver, and adapt it to socket power, and do not object to a slight amount of maintenance attention, either the first or second method would seem preferable. On the other hand, if you want to buy or build a special receiver adapted to socket power, and desire a minimum of care, one of the last two methods is recommended.

As to current consumption, all four seem to be about on a par. Units employing trickle chargers, drawing current from the

line regardless of whether the set is being used or not, would appear to show a higher consumption. But under average conditions, the other types show practically the same total consumption, since the load is proportionally greater while the set is being used.

In the last analysis personal preferences and particular conditions must therefore be the determining factors.

In any event, disabuse yourself speedily and once for all of the notion that lamp-socket operation eliminates all necessity for attention. It does not and, as far as can be seen, it never will. Some care must, in the nature of things mechanical and electrical, be demanded by anything as intricate as radio receiving equipment. What lamp-socket operation offers is a gain in convenience, economy, and permanence over that possible with battery power—surely a very real and worth-while advantage.

A WORD FOR BATTERIES

It should be understood that lamp-socket operation is not a panacea for all radio ills. In a world where nothing is perfect, we cannot expect too much from the various instru-

mentalities. In fairness to the "A" and "B" batteries, the following remarks may be pertinent: Many sets, when connected to lamp-socket instruments, whether "A" or "B," or both combined, will tune somewhat broadly. DX reception is frequently not quite as good as if the set were operated solely by batteries. It is also often noted in certain localities that, where socket power is used, clicks and other disturbances are produced in the loud speaker from various other appliances on the line. For instance, ice machines, nearby fans, and lights in the house being switched on and off, all produce a noise in the loud speaker, which, as a rule, is not heard if the set is battery-operated.

With certain socket appliances a so-called "motor-boating" effect is noticed in some sets; it is often difficult to eradicate. It may be said that generally battery-operated sets are somewhat quieter.

Radio Broadcasting in the Scandinavian Countries

By SVEND A. BLANGSTED

(ODENSE, DENMARK)

person in Denmark who has not heard at least Danish broadcasting. Denmark has a population of 3,500,000, and paid licenses reach to-day the number of about 150,000, of which 35% are tube-sets. Sweden has a similar ratio, but a population twice that of Denmark.

It took some time, though, and much work also, to reach this result, and most receivers have been built during the past two years. Until then there was no regular broadcast service; but the Copenhagen newspapers hired the military stations to broadcast news, and sometimes also concerts and speeches.

As soon as the government took over the administration of the broadcasting, it instituted service, sending news at 7:00 and 9:00

p. m. every day. "Mikes" were installed in several official places; meteorological announcements can be heard half a dozen times a day, and several broadcast stations were erected for regular work.

The Danish broadcasting stations are: Copenhagen (337 meters), Soroe (1154 meters), Odense (810 meters) and, for weather reports, Ryvangen Radio (1154 meters). During the summer, probably in October, Soroe will be replaced by a 8-kw station at Gisseloere (north-western corner of Zealand). Because of Motala on 1305 meters and the coming German station at Zeesee (1250 meters with a power of 100 kw.) Gisseloere may come down to 337 meters which will make it possible for American listeners to hear Danish programs.

To cover this district Germany has a

(Continued on page 287)

ONLY about four or five years ago the Scandinavian people knew broadcasting by name only. The population of Denmark, Sweden and Norway didn't then believe that broadcasting could play so great a role in every-day life as is the case to-day. And just that, I believe, was the case in most countries except perhaps the United States. We thank you, Uncle Sam, for all your splendid inventions and your improvements of notable European inventions.

When the English trials from Chelmsford and other places were made, very few Scandinavians were so lucky as to own a receiver for broadcast programs; and those who had urgently phoned the newspaper offices to tell that they had heard a voice in the air. At that time it took hours of hard work to be able to report so fine a result. To-day, five years later, there is hardly a

Awards of the \$300 "What's Wrong?" Contest

Based on Our Television Cover Picture of May, 1927

THE readers of RADIO NEWS throughout the world responded with their usual promptness to the announcement of this contest. Replies were received from localities as far distant as Moscow, Russia (in Russian!), the Philippines, Australia, New Zealand, and Shanghai (several), and Nanking (two) in China.

The checking staff got busy, as usual, as soon as the contest had closed on June 18, and were very speedily impressed by a singular state of affairs. The sixteen errors in the picture are all very obvious, and each of them was found by innumerable entrants; but no submitted list contained all the sixteen. Our readers had proceeded to invent for themselves a number of errors, many of which were found identical in a great many of the entries.

For instance, we stated explicitly, when announcing the contest, that no errors in the figures on the dial and meters of the radio receiver were to be looked for. Our readers seemed, in many cases, unable to accept this assurance. Others did not consider the picture of the microphone to be genuine. "A microphone are like a lotus flower," protested a Chinese gentleman. Only a few of the lists, however, failed to submit a list of exactly 16 mistakes, neither more or less. One entrant, aged nine, may readily be pardoned for sending in an entry with but one.

In addition to this, it was required that each entry be accompanied by a comment (suitable for publication) on the picture, of not more than 25 words. Several runners-up, as regards the accuracy of their lists, entirely disregarded this requirement; some sending in no comment, and others as many as fifty words. And many of the best and most witty comments came with very inaccurate lists.

We had fully expected at least several

hundred 100% correct replies, with very interesting and amusing suggestions. Unfortunately, even the best replies were not perfectly correct, as we have stated. The first three prize-winners had a batting average of .875—having fourteen out of sixteen right. How they missed the others, which the majority of the less-observant competitors noticed at once, we don't pretend to guess.

It is interesting to note that one family had three entries in the class of runners-up—and their replies were not identical. Had



The picture with 16 errors.

they pooled their correct answers, it would have been sufficient to take the three first prizes, or three firsts.

COULDN'T FOOL THEM ON THIS

What most readers noticed—about half-way down their lists—was the little catch of introducing the television camera into the picture it was taking. That impossibility did not fool two per cent. of the competitors. But comparatively few observed that no possible means was provided for projecting the image upon the screen of the receiver in the home. Obviously, it could not be done edgewise.

The average score of the replies received was eleven correct out of the sixteen proper answers, which appear in an adjoining column.

SOME COMMENTS

Our foreign readers took rather undisciplined amusement in reflecting upon a great American institution. "The Outcome of Prohibition," was the suggestion of a contestant from Barbados as to the cause of such numerous errors; and a Canadian hospitably advised: "Just pack your trunk and come along, for Montreal is wet." One pessimist (perhaps an editor) inquired: "What's a few mistakes to an artist, when most all art is a big mistake?" "Hope I get a right-handed decision," is the prayer of one entrant. (He did—"out at third.") Another said: "If I don't get a prize it will be mistake No. 17." (Wrong!)

"The lady is faultless," said a gallant Englishman; and one of the feminine prize-winners noted that "there seems something wrong with about every leg in the picture, except the lady's." One man writes: "The picture's greatest fault is that the lady does not display a very fine diamond on the

proper finger." "I have entered 7321 guessing contests, and the funniest thing I could think of is for me to receive a prize," is the pessimistic comment on another slip by a reader who did too much guessing. The contest was one, not of luck, but of reasoning.

"I'm a woman—how can I say anything in twenty-five words?" may be matched by a masculine one, from a sailor in the U. S. Navy: "I think your twenty-five words chatter is a bit of a joke; as I know very well I couldn't say good-bye in such a few words." It is evident that there were a good many solvers in the military and naval services—and only lack of taciturnity keeps one of them from figuring in the prize list; he used too many words. Versified and printed replies, and a few illustrated very neatly, were received.

Two solvers sent in lists of twenty-five unconnected words as their entries! In fact, it appeared that no small number had failed to comply with the oft-repeated instruction which accompanies every contest RADIO NEWS has published, to read the simple rules.

A great number of our readers have sent their condolences to Fips (our head office boy), the instigator of the contest, with varying degrees of sympathy. "Tell him I built his Cookoodyne," writes one, "and would like to see some other circuits from him." Master Fips is unable to write to all his friends and admirers; but he trusts that he will have the opportunity of affording them many more times an opportunity to drag down a little easy money—and that it will not come out of his hard-earned \$5.77 raise the next time.

COMMENTS OF THE PRIZE WINNERS

Here are what the prize winners had to say about the picture and the contest:

(Continued on page 278)

CORRECT ANSWERS TO "WHAT'S WRONG?"

- (1) No wire connection on microphone.
- (2) Television machine in studio cannot possibly show, as it cannot transmit its own picture.
- (3) Time of clock is wrong by 15 minutes. One hour's difference is possible, because the transmitter might be in New York and the receiver in Chicago.
- (4) Radio set has no loud speaker.
- (5) Radio set and television attachment has no projecting apparatus. Where could the television picture come from? (Description in RADIO NEWS said that the apparatus was self-contained, therefore transmitter could not be located elsewhere.)
- (6) Girl in front of the apparatus would be looking at the television screen, not looking away.
- (7) No colors can show on screen, because if one color shows and there were colored picture transmission, all colors would show, not just the green and the red. (Pointed out in May issue.)
- (8) Microphone entirely too high.
- (9) Picture behind screen could not show through it, as screens are not transparent.
- (10) Radio set is minus one rear support. It would topple over in position shown.
- (11) Table leg is apparently sawed off, and could not support table.
- (12) Knob missing from left upright holding television screen.
- (13) Pendulum of clock too high.
- (14) Piano top has no supporting stay.
- (15) Hinges on clock do not match.
- (16) One leg on piano bench is missing.

LIST OF PRIZE WINNERS

First Prize	\$100.00
C. W. DONALDSON, 1507 Grand Avenue, Kansas City, Mo.	
Second Prize	\$75.00
C. A. BROMLEY, Hollister, Calif.	
Third Prize	\$50.00
N. CHAMBERLAIN, 2905 Quebec Street, Vancouver, B. C.	
Fourth Prize	\$25.00
OVILA C. DUQUET, 94 Gardner Street, Worcester, Mass.	
Fifth Prize	\$10.00
L. J. TROXLER, JR., 32 Oakland Street, Red Bank, N. J.	
Sixth Prize	\$5.00
MISS ANDREA DUQUET, 94 Gardner Street, Worcester, Mass.	
Seventh Prize	\$5.00
MARAD SERRIOV, P. O. Box 766, Palo Alto, Calif.	
Eighth Prize	\$5.00
ALICE STEVENSON, 337 Eleventh St., San Bernardino, Calif.	
Ninth Prize	\$5.00
E. C. GREENE, 127 Milligan Place, South Orange, N. J.	
Tenth Prize	\$5.00
L. L. LANE, 525 Mabbette Street, Kissimmee, Fla.	
Eleventh Prize	\$5.00
E. W. McAVOY, 23 Elmwood Avenue, Haverhill, Mass.	
Twelfth Prize	\$5.00
NORRIS E. WILSON, 4825 Stevens Ave., Minneapolis, Minn.	
Thirteenth Prize	\$5.00
A. F. HELMKAMP, Charlestown, Indiana	

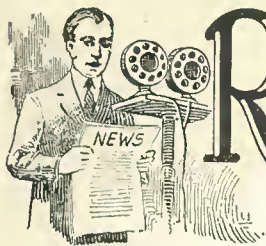

Radio News of the Month



NEW ZEALAND REBROADCASTS U. S.

A MATEURS of Palmerston North, New Zealand, recently entertained the listeners of the islands by arranging a rebroadcast of 2XAD and 2XAF, Schenectady, on their radio club's 285-meter transmitter, 2ZF. The short waves, 26.8 and 32.77 meters, were tuned-in on a receiver which the owner regulated by listening to the local rebroadcast on his long-wave set. It was found that the shorter wave gave maximum volume earlier in the day; and the longer-wave transmission held up till after midnight, when the other had faded completely. More remarkable, perhaps, was the success of the same listener, W. A. Waters, in picking up KOA, Denver, on its regular 332-meter wavelength, in sufficient volume to afford a rebroadcast for about 20 minutes, when static interfered. This distance is some 8,000 miles.—*I. N. Lect.*

RADIO LISTENERS FAVORED

THE advantage of staying beside one's radio during an important public event will not be fully realized, perhaps, until we have television; but they were recently demonstrated at the International Rotary Convention in Ostend, Belgium, which was addressed by King Albert. Listeners in the hall, which contained an audience of 14,000, found it almost impossible to hear a word. On the other hand, listeners-in by radio heard every word, with but a slight background of noise from the great throng, except for applause.—*L. Reid.*

RADIO IN DANISH SCHOOLS

DENMARK will equip its schools with radio equipment, as the result of negotiations between the national department of education and the radio control board. Radio instruction, it is announced, will be made part of the regular curriculum in the schools.

SUPER-POWER IN EUROPE

READERS of RADIO NEWS who have constructed the Transatlantic types of long-wave receivers described in this magazine (April and June, 1927) and who enjoy favorable locations, will have quite a choice of high-power stations to listen for this fall; including Daventry, already well-known to DX fans, on 1,600 meters; Motala, Sweden, 30-kw., 1305 meters; Moscow ("Kominfern") 40-kw., 1450 meters; the new Turkish station, "Radio Stamboul," 10-kw., 1200 meters; Buda-Pesth is to have a 60-kw. *input* and the Berlin Deutschlandsender (Zeescn) a 120-kw. *input* when they start working after the fall. The Germans have a knack of giving the input power, not the output. Vienna on 5 kilowatts output, 517.2 meters; Prague, 5-kw., 348.9 meters; and Bern, 6-kw., 411 meters, are all worthy of attention. The powers of the following German stations are all 4-kw.: Stuttgart, 379.7 meters; Hamburg, 394.7; Frankfurt, 428.6; Leipzig, 365.8; Breslau, 315.8; Berlin 483.9. Langenberg (described in last month's RADIO NEWS—call should have read LA—5XX is Daventry!) seldom uses his 25 kw.; nearly always about 7, as he drowns Berlin-Vexhaus on 484 meters. A 10-kw. station now operates at 5 p. m. GMT, onwards from Novosibirsk, Russia; and relays the Kremlin chimes from Moscow at 9 p. m. GMT. Lisbon is very shortly to have a 1½-kw. transmitter.—*E. T. Somers.*

RADIO IN ICELAND

THE Althing, or parliament, of Iceland has voted an appropriation of 75,000 crowns to establish three radio beacons along the coast of the island. The construction will be undertaken next year.



The cage aerial is popular in France. Here is the w.-k. American car of a Parisian radio dealer, with a few sets aboard, about to leave for the Bois de Boulogne or some other park; where he will give a free concert and incidentally advertise his business. © WIDE WORLD.

RADIO FIRE ALARM

"MIKE" demonstrated his versatility by announcing a fire, had his hearers but understood, during a broadcast in Chicago over WGN. Listeners-in heard but a crackle after a dance program was announced; then came the statement that the terrace platform was in flames. Orchestra and dancers fled; and the faithful microphone perished in the flames whose presence it had announced to the radio audience before the broadcasters discovered them!—*Harold Bowen.*

RADIO AUDIENCE ALARMED

TOO much reality was given a broadcast of an imaginary invasion by air, recently, at Adelaide, South Australia; and many listeners took it seriously. Loud protests were later heard; just as when the B. B. C. tried a similar "surprise" at London a couple of years ago.

THE NORTH-POLE BLUES

THE attempt to broadcast a program from the Arctic will be made this summer by Capt. Donald B. McMillan, whose ship, the Bowdoin, carries a short-wave phone transmitter. It is hoped that it will be possible to rebroadcast its transmissions from one of the larger stations in the United States.

RADIO IN THE DESERT

A RABIA'S orthodox sectaries have adopted modern means of communication: the forbidden cities of Mecca and Medina have been linked with Rayad in the interior, under the direction of King Ibn Saud.

ECLIPSE EFFECTS ON RADIO

A NEW field for research was presented by the total eclipse of the sun on June 29, visible in England (where the weather permitted). Because of the high latitude of the path of totality and the early hour, the sun's shadow fell on the atmosphere at an acute angle; and therefore the portion of the Heaviside layer obscured was over a hundred miles south of the shadow on the earth's surface. Short-wave experiments were therefore conducted to determine the effect of the shadow on the layer, and consequently on its reflection of signals; but no data have yet been received as to the effects experienced.

SELLING RADIO IN SWITZERLAND

IN most countries broadcasters derive their revenue, not from advertising, but from the subscriptions of listeners-in. In Zurich, Switzerland, the broadcasting company has recently been sending demonstrators about the canton to interest prospective customers in the purchase of sets. The company introduces and sells them for manufacturers; deriving its profit, not from the original sale, but from the licenses which purchasers must take out.

SHORT WAVES BEST IN CANARIES

BECAUSE static prevails about the Canary Islands, the U. S. consular service reports, it is found that the short-wave broadcasts from Europe and America give the best reception on home-made sets. This has aroused much interest in this type of receiver.

AN ILLICIT AERIAL

RESIDENTS in the Irish Free State are confronted with an unpleasant restriction, judging from the experience of Mrs. Bridget Garry, of Clontarf, who it is reported was fined 5s. and 2s. costs at the Dublin District Court last week for having an aerial erected without a license. This, comments *Wireless World*, is rather like fining a man for not possessing a car license when he owns a starting handle.

HIGH NOTES NOT HEARD

IT is well known that extremely high musical frequencies are not heard over the radio. This was noticed the other night when at Denver a man was giving bird calls. When it was announced that he would imitate a bird with a high musical note nothing was heard but a slight hissing sound; probably caused by the impersonator's breath striking the microphone. Either the transmitter could not send out such a high note, or the receiver could not reproduce it; more likely the latter.—*J. Thomas Scott.*

(There are several possible solutions of this phenomenon. A good radio set will pass and amplify a note up to 7,000 or 8,000 cycles fairly well; but the band-pass filters of some broadcast stations cut off notes sharply above 5,000 cycles, to avoid going beyond their "channels." Very selective R. F. tuning will have a similar effect; and, thirdly, human hearing varies more than two octaves in its upper range, with individuals who have apparently normal ears.—EDITOR.)

(Continued on page 258)

Radio and Our Spoken Language

Local Differences Are Negligible. But Radio Shows Up Personalities

By CHARLES M. ADAMS

BACK in 1922-3, when radio was just launching its victorious drive on the public's imagination and sleep, it will be remembered that students of language were moved to make various prophecies concerning the effect of the new art on our spoken language.

Not that prophecies concerning the effect of radio on anything were extraordinary. Instead, they were very much in order those days. But the prophecies of the language students were distinctive, in being based on something more than mere stirred imaginations.

An agency which would permit hundreds of thousands of people, scattered over widely-separated parts of the country, to listen simultaneously to a speech, play, or other spoken material, was certain to affect, and disclose facts concerning, our spoken language as no other medium had ever done. It is many times more direct, convenient, and general than travel or reading; the two means previously available; and the language specialists can well be pardoned their enthusiasm as they glimpsed the future opened by this new development.

That was five years ago. Today enough water has run under the broadcast bridge to make an appraisal of just what has happened reasonably accurate. So—without going into the rather delicate matter of reviewing the various prophecies—it should prove interesting to see what radio has actually done to or shown us about our spoken language; not from the viewpoint of the specialist, but the average listener.

NO FOREIGN LANGUAGE PROGRAMS

We have been told from time to time by certain gloomy observers of "things as they are" that the "Anglo-Saxon" elements in our civilization are being rapidly subordinated to the high proportion of unassimilated immigrants in our population. Such things as tight racial groups, each speaking its own language and having its own foreign-language press, have been cited to prove this contention; and, from these premises, it has been asserted that, in many sections, English as the predominant language is being displaced by alien tongues to a serious degree.

But, as its first disclosure concerning our speech, radio heartlessly sweeps the foundations from under this carefully-erected edifice by demonstrating that what the overwhelming majority of us speak is still English (of course in the sense of being a slightly modified form of the English spoken in Great Britain.)

The proof? As this is being written over 700 stations are attempting to broadcast in the United States. But careful search and inquiry has failed to disclose one which is a foreign-language station. Still more conclusive, diligent listening to as many as can be heard through the self-imposed QRM, has failed to uncover one which broadcasts for-

foreign-language programs (except, to be sure, a very few occasional programs in Spanish, designed for South American, and not home consumption).

It is no secret that each of these 700 odd stations is trying to win for itself as large an audience as possible; and many are located in sections where the alien element is strongest. So, obviously, if the proportion of the population preferring foreign languages were nearly as large as has been contended, some stations at least would make capital of the situation by broadcasting in foreign

ern drawl of certain announcers below the Mason-Dixon line; and Graham McNamee's precise "eyether," to mention a few. But these, like all the differences in speech encountered on the air, are mere details, for the most part in individual pronunciation; and at their greatest are so slight as to be negligible.

A listener in any part of the country can tune in a station in any other part and be assured of understanding everything that is said without difficulty; which certainly is proof that our spoken language is remarkably similar, if not identical, the country over.

Radio, to be sure, can hardly claim credit for bringing about this standardization, particularly during the short span of its life. It has been due instead to such things as the intermingling of population, travel, and business intercourse, not to mention education. But it was not till the advent of broadcasting that most of us realized there was such a striking similarity in our speech. Furthermore, radio, as reception becomes more universal, is an influence that will tend powerfully to break down the dialectal peculiarities which still persist in certain isolated communities.

PROBLEMS OF PROPER NAMES

It might be assumed from all this that radio, by providing standardized examples, has resulted in a marked improvement in pronunciation and usage among the rank and file of listeners. But it requires only a little observation to establish that this end, so much desired by the linguists, has to date not been achieved.

For example, how many listeners have heard WHAS give its location as in the city of "Louisville," and immediately repeated the name as "Louisville;" or heard KFI and KHJ announce themselves as in "Los Angeles," and gleefully proclaimed to friends next morning that they had Los "Anjelees;" or, most typical of all, listened for an hour to Major Andrew White and Graham McNamee saying "Tunney" during the ring classic last fall, yet proceeded blithely to call the new champion "Tooney."

Part of the explanation, of course, is a mistrust of announcers in the matter of correctness, carried over from the days when "sang" was used interchangeably with "sung" in many studios. Part too is due to mere inertia and carelessness. But still more can be traced to human nature.

One of the average man's most sensitive spots is pronunciation or grammar. Catch him short-changing or taking the wrong overcoat; and he is not half as red and uncomfortable as when caught mispronouncing a word or using a faulty construction. Even more amusing, rather than admit he may be wrong, he goes on making the same mistake.

(Continued on page 293)

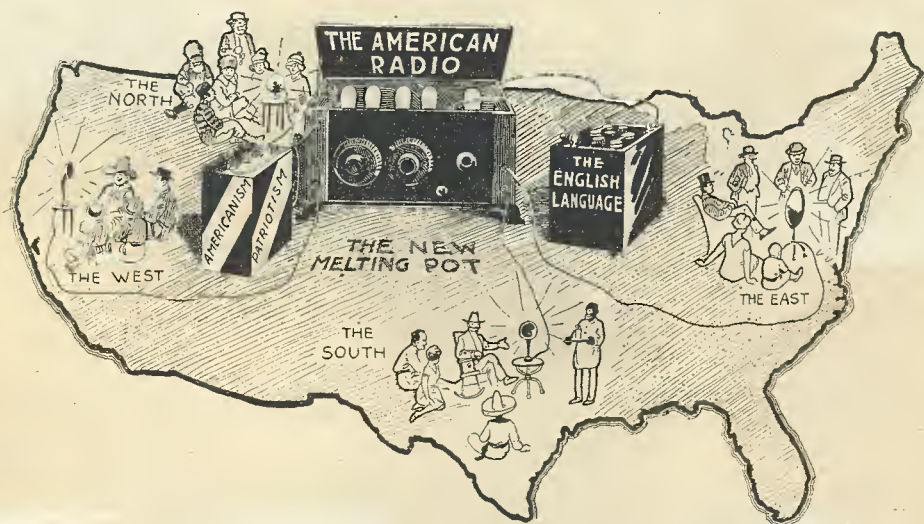

"It was not till the advent of broadcasting that most of us realized there was such a striking similarity in our speech. Furthermore, radio is an influence that will tend powerfully to break down dialectal peculiarities."

languages. Yet, as can be established merely by listening, not one has seen fit to do so; and accordingly, in spite of those who would have us believe something else, the only conclusion which can be drawn from the facts is that what the overwhelming majority of us speak is English.

Further—to risk a bit of prophecy—the predominance of English in our spoken language will become more pronounced, the longer this condition prevails. Those groups which still cling to alien tongues will have English forced upon them, the more they listen to broadcasting; with the result that radio proves to be an important if unconscious Americanizing influence to the extent that speaking English makes for Americanization.

UNIFORMITY OF SPEECH

Next, these same gloomy observers would have us believe that our country is so large and unwieldy it is falling to pieces of its own weight; that each section has a narrow background and outlook, reflected in peculiarities of speech all its own. But here again radio ruthlessly wrecks the laboriously constructed house of cards, by showing that our spoken language is amazingly similar the country over.

Certain exceptions will, of course, immediately occur to the listener; President Coolidge's Yankee twang; the broad "a" and deleted "r" (the last, by the way, not making for the best microphone enunciation) practiced by many eastern announcers; the south-

Cross-Country Radio Transmission Work

RADIO'S especial merit is in the possibilities of maintaining communication, not between fixed stations which can be linked by permanent lines of communication, but between mobile groups—vessels at sea, airships in flight, railway trains, and automobiles in motion.

The last of these problems has been technically the most difficult. It has been comparatively easy to obtain reception in moving automobiles; but transmission has been another matter. The airship is able to unroll a long antenna; the train has above and beneath it permanent metallic conductors; but to effect transmission from an automo-

to high-power fixed stations, which rebroadcast the programs for public entertainment.

For the more exacting work of military forces, and for exploring parties which might require the aid of radio en route, a French radio manufacturer has recently produced a type of equipment which surmounts the difficulties above described. The automobile equipment illustrated on these pages, especially designed for pioneering work in France's African colonies, can not only receive on several wavelengths, but send short-wave messages, while traveling at full speed.

The peculiar chassis shown is of the Citroen type, with which the Sahara desert has been successfully crossed. The vehicle, with total equipment, weighs somewhat less than 9,000 pounds. Its permanent aerial, of three bars running lengthwise of and insulated from the roof, is matched by a corresponding counterpoise under the body of the car. For long-wave stations a larger aerial and counterpoise may be unrolled and set up with a 40-foot collapsible mast. The use of a ground is avoided, as it is apt to be unsatisfactory under conditions in the desert.

RADIO APPARATUS

The transmitter, of 500-watts power, will operate on waves from 30 to 100 meters; it is supplied with current by two motor-generators, driven by a gasoline engine, and two batteries. The former gives 2500 volts, at 350 milliamperes, for the plates and 10 volts, at 50 amperes, for the filaments, and charges the batteries. About 1250 miles is the range of the transmitter, using code; and about 375 miles by phone.

There are two receivers; one for short waves, with a detector and two A. F. stages, which operate between 20 and 300 meters. The long-wave set uses an R. F. stage, detector, and two A. F. stages, one a push-pull

amplifier. It functions as an autodyne up to 3,000 meters; and the use of a sixth tube makes possible its operation as a super-heterodyne up to 25,000 meters.



We might be accused of humor if we described this tank's radio operator as "a shielded receiver."

bile, even on short waves, it has been necessary hitherto to stop and erect an aerial system. This has been done quite successfully, and in this country we have seen transmitters mounted on automobiles; from which they sent out reports of current events



Here are the operators of a British radio tank, coming up for air.

Illustrations © Photopress

The transmitter may be operated either on phone or code while the machine is in motion and the engines of both the driving mechanism and the power supply running. For phone work, however, it is preferable to stop the generator engine and work on the batteries. In case of a failure of this engine, the generators can be driven from the main shaft of the automobile. The batteries are charged in banks at 32 volts, the generator used for this purpose furnishing 50 amperes. They are used also for lighting the car at night, as well as to oper-



Above, interior views of the French radio car which is built especially for work in the desert. At the upper right is the transmitter, which works from 30 to 100 meters; its current is furnished by the motor-generators below. At the upper left are the two receiving sets; that forward for 20 to 300 meters, and the larger one with ranges from 200 to 25,000 meters. The external appearance of the car, with its aerial on the roof, is shown in the center below.

Photos by courtesy of Et. G. I. Kraemer (Paris)

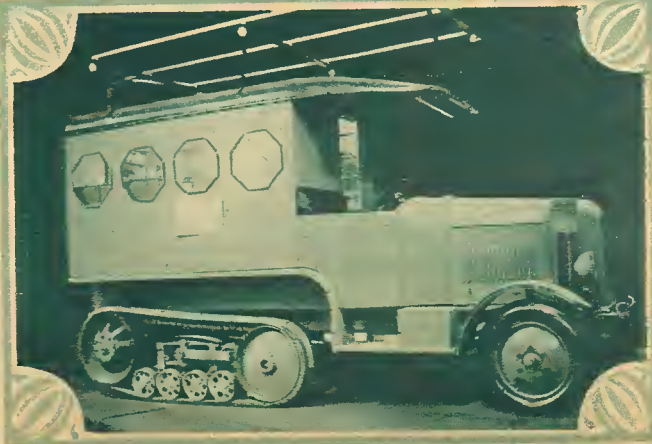

ate the motor generator, and for the self-starter of the engine.

The octagonal windows shown, which are screened, afford ample ventilation.

RADIO IN THE TANK CORPS

The British government has been carrying out recent maneuvers of a completely motorized division, intended to move as a whole at high speed. In order to maintain liaison between its units, radio is essential; and the illustrations at the top of the page are two views of a radio-equipped tank. Because of the fact that the interior of the tank is completely walled in with steel, it is quite shielded electrically. It is therefore necessary to erect the aerial mast for short-wave reception on the outside, as shown. The tank illustrated carries two operators, who thus keep in touch with their command.

Sandy McGuff's

"Ultimate Twin-Six"

By BRUCE COLTER CARR

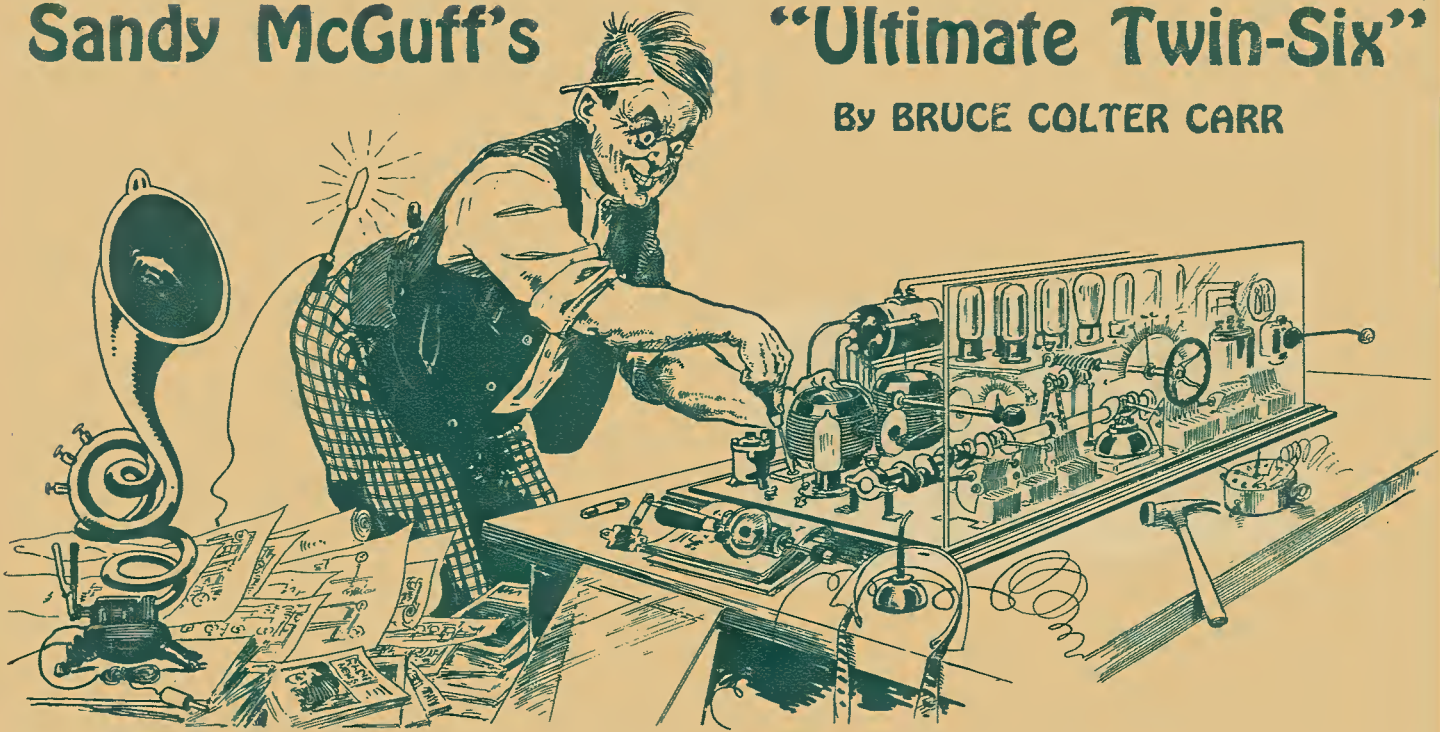

A CUCKOO who signs as Sandy McGuff
 Would sidetrack his work to map on his cuff
 The plans and the circuits of sets;
 As he wanted to make a bird that would take
 The measure of all super-hets.

Of course his radio friends were greatly enthused with Sandy's idea of constructing the world's very best receiver. They desired to aid him in every way; so each recommended the hook-up of his own particular set. Therefore:

*He studied all circuits and found with dismay
 That each was a peach in a singular way,
 But lacked a few points, as a whole.
 So he pondered the 'dynes and the 8-9 in-lines
 Till his mind got beyond his control.*

The results of his research led to but one conclusion: to combine all the good features of each circuit into one premier master-set. When he announced this decision to his friends, they slapped him on the back and pronounced him to be a genius. So:

*For many long months McGuff did perspire
 To bring to a head his burning desire
 Of building the set all supreme.
 But at last, really neat, he finished complete
 What he hailed as The Engineer's
 Dream."*

Being an auto salesman, Sandy named it the ULTIMATE TWIN-SIX. It was built of standard parts, as follows: 6 Various condensers mounted in chain-gang formation to permit of one-knot control; 6 Artichoke coils; N. Y. Central couplers; Quarterback grid-

leaks; 6 Audience transformers; 12 Ha-Ha tubes (1 defective and 11 hypo ample-liars); a Blah-Blah phoney speaker and a plate-glass cabinet. To do away with batteries he constructed an "A" and "B" eliminator from the best home-brew-filter material to insure a smooth flow of power from the light socket. Naturally, he invited the Boss, his radio friends, his wife and a news reporter to witness the ceremony of turning on the juice. After a modest speech, very fitting to the occasion, he stepped over to the ULTIMATE TWIN-SIX and pulled a switch. Then—

*Came a sudden roar and a blinding flash
 Followed at once by a terrible crash
 Jarring us all from head to feet;
 While pieces of brass and the splinters of
 glass
 Were filling the air like a storm of sleet.*

When the police had quelled the riot, and the fire department had done its duty, they took Sandy to the hospital. I went to see him the next day and thoughtfully mentioned that all his friends were going to sue him for damages. He absorbed this information through his bandages in such an absent-minded manner that I felt he was still goofy from the shock. "It's too bad," I mused softly to myself, as I watched his vacant expression, "that the Twin-Six went haywire. It might have been a bear for DX." Well:

*McGuff roused up like a man who had
 heard
 The bottom had gone from his steel stock
 preferred;
 While his eyes shone brighter than stars,
 As he said to me, "Bill, now where in Sam
 Hill
 Were YOU when I tuned in on MARS?"*



Views of Japan's Leading Station, JOAK

Located in Tokio, the Capital and Metropolis

FEW transoceanic reception records are more frequent and consistent for listeners in the United States than those of JOAK, located in Tokio, Japan; and many fans, especially on the Pacific Coast, treasure the verification cards of this station. Priding itself on its international fame, JOAK has adopted as a slogan "Truth and Sincerity to All Corners of the World."

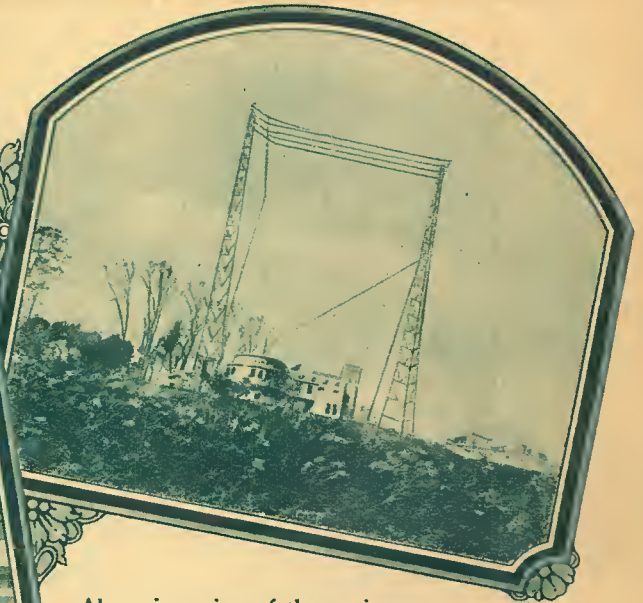

Above is a view of the station, erected on the brow of a hill. Its towers are 150 feet in height, and 105 apart, suspending an L-type antenna. The length of the aerial is 85 feet; the counterpoise, three feet above the station roof, is composed of eight wires slightly shorter.

American listeners who desire to try for JOAK may find it on 800 kilocycles, 375 meters. Japanese time is seventeen hours ahead of Pacific Standard Time; so that, from one in the morning on, Pacific Coast listeners may have the chance of receiving programs of the evening of the same day in Japan. The zone of darkness makes it much easier to obtain long-distance reception from east to west than vice versa.

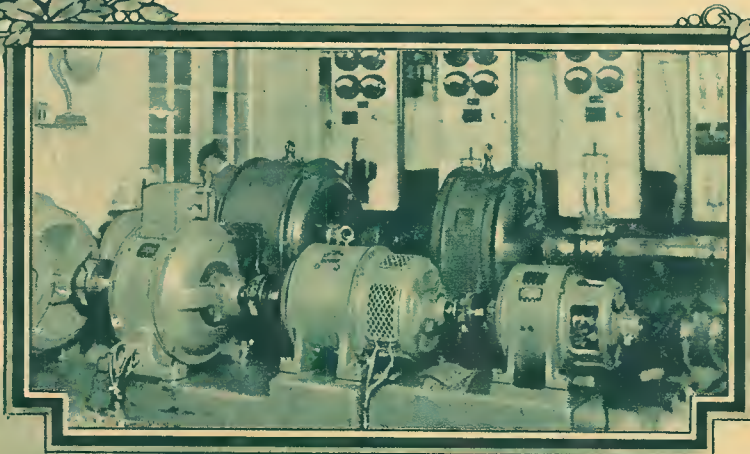

The transmitter, of American make, is one-kilowatt in power; though it is proposed to increase this. A three-stage amplifier is used, and the antenna current averages 8.5 amperes. A reserve set has been constructed by Japanese engineers. Power is available from two lighting systems; and a 580-ampere-hour storage battery is provided, which will maintain the station in operation ten hours, should an emergency cut off the power supply.

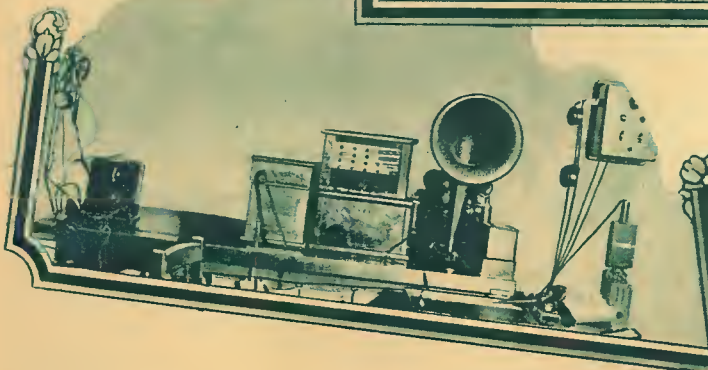

Announcements in English are made from JOAK, in addition to those in Japanese, and very good musical programs are provided. The modulation of the Japanese stations is reported to be excellent. The four Japanese stations are fairly close in wavelength; JOBK, Osaka, being 385 meters; JOCK, Nagoya, 360 meters; and the new station JODK at Keijo, 367 meters. Reception of JOAK has been reported as far east as New York, a distance of over 7,000 miles, on winter mornings. Japanese interest in American radio is high, and much correspondence has been received by RADIO NEWS from Japanese amateurs, one of whom, Mr. Fred Iwata, has supplied these photographs, as explained in his letter on page 246.



New Developments In Radio

Produced by Scientists and
Engineers



John L. Baird, the Scotch inventor, is shown below at the transmitting station in Coulsdon, England, which he has constructed for the purpose of sending television signals across the Atlantic to the United States.

© WIDE WORLD.

Above, a demonstration of wireless transmission of power at a recent meeting of the New York Electrical Society. Dr. Harvey C. Rentschler is holding up a lamp, which can be lighted brilliantly without the aid of connecting wires. With him is P. S. Grace, president of the society. © UNDERWOOD & UNDERWOOD.

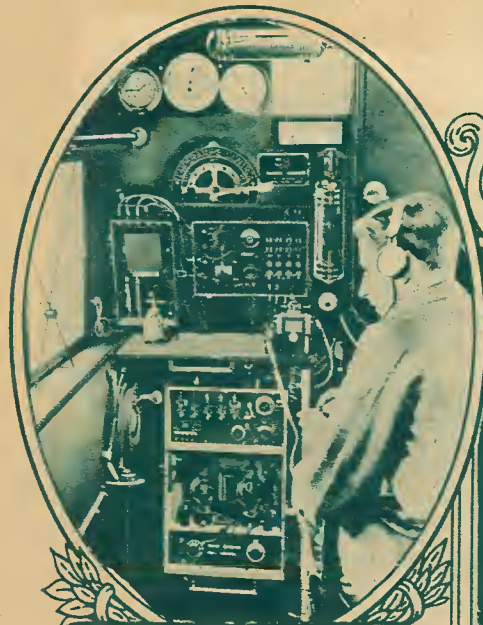
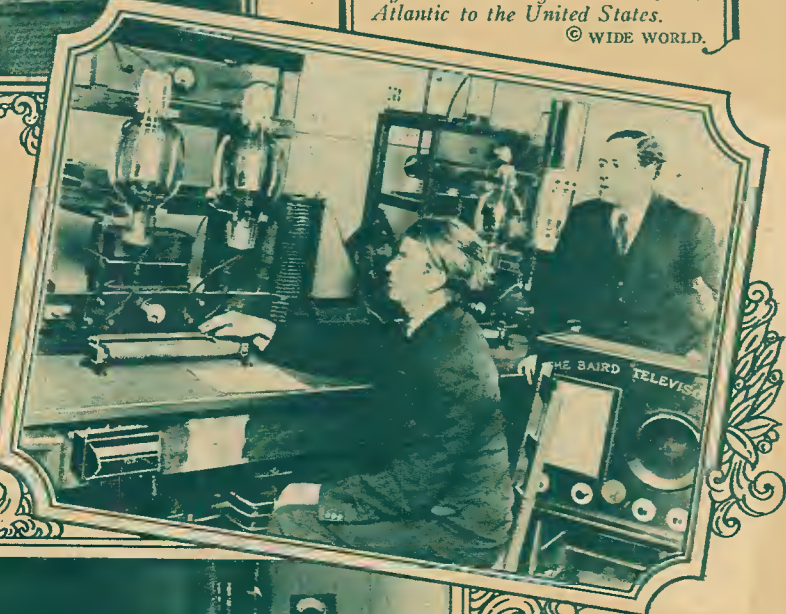

Above, the radio cabin of an airship on the route from England to India. It has a transmitter of 1,500-watt power. The aerial is suspended below the plane. © HERBERT PHOTOS.



At the left, Prof. H. H. Henline of the department of electrical engineering, Stanford University, California, standing beside equipment of the university's experimental radio station 6XBM. This station has two transmitting sets, long- and short-wave, with which it has sent out standard-frequency signals, aiding in the work of the Bureau of Standards. One ranges from 50 to 200 meters, and the other from 200 to 2,400. © UNDERWOOD & UNDERWOOD.

At the right, radiotelephone equipment designed by the Signal Corps of the United States army for communication between aeroplanes and the ground. As shown here, it is being used by the Bureau of Standards at Washington for telephoning to planes operating from the experimental flying field at College Park, Maryland, a short distance from the capital. P. T. Howard, of the Bureau's staff, is seen here conversing over the telephone with one of the planes. One of the great problems in this work is shielding the receiver on the airplane against the interference caused by the elaborate ignition systems of its huge engines. How this is done is explained on page 1277 of RADIO NEWS for March, 1926. © UNDERWOOD & UNDERWOOD.



Real Portability in Radio Sets

Which Would You Rather Take Along?

A portable set is, by definition, one you can carry with you. However, as you may see from the pictures on this page, it all depends on your facilities. The equipment shown at the bottom would stump most of us; but the British Army hikes right along with it.



Above we see John W. Harvey's notion of portable radio. He tunes in and starts off, and, like the lady in Mother Goose's rhyme, has music wherever he goes. Some of us think we could put the side car to more entertaining use; but that's a matter of preference. © UNDERWOOD & UNDERWOOD.



Radio reception is shown above in a nutshell. This miniature receiver was made, and housed in a walnut shell as you see, by Denis Woods, a 15-year old boy, living in Liverpool, England. It is claimed for this little crystal set that it will bring in the local station on two pairs of headphones. © INTERNATIONAL NEWSREEL.



At the right is another British set, shown at the radio exposition at Olympia. It will operate a loud speaker if preferred; and is entirely self-contained, having no outside leads to antenna or batteries. The other pannier on the chair can be used to store reading matter, or refreshment not so dry. © WIDE WORLD.

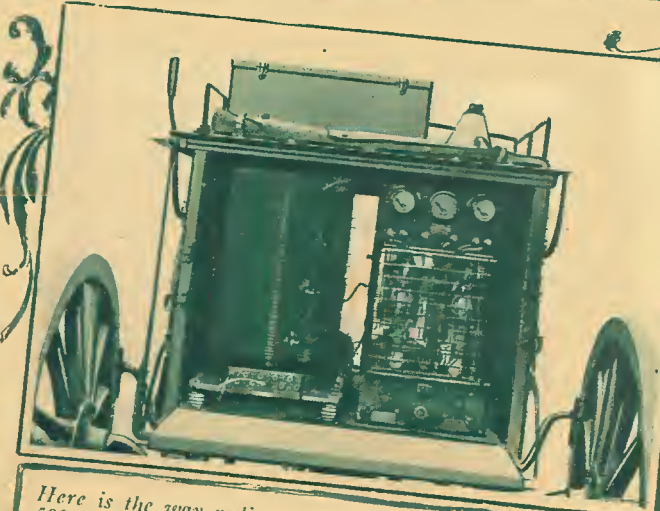

Here is the way radio travels with the British Army. A 500-watt telegraph and telephone transmitter is built into a standard-type artillery caisson, compactly, but with ample room. The antenna, wrapped in leather, is carried on top.

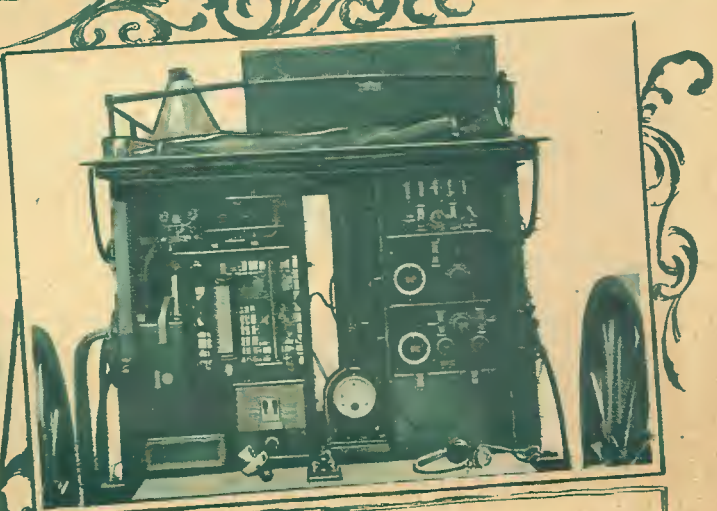

Another view of the military transmitter shown at the left; the operator's table, key, microphone and headset are shown. The equipment is very flexible, as it may have to meet extraordinary demands. © HERBERT PHOTOS.



"Silent Dynamite"

Another Spasm from the Perpetrator of "Came the Dawn"



By C. STERLING GLEASON

IN Hollywood, it is said that when Harold Dare, idol of the film-fans of the world, is seen riding through the streets of Los Angeles in his expensive limousine, many a widow wipes a furtive tear upon her apron, and murmurs a prayer of blessing after him; and many an orphan's wan face lights with a grateful smile. When he passes a certain great trust company, the officers, to a man, rush to the windows and wave their handkerchiefs in greeting; and the president of that concern, whenever he meets Harold Dare, never fails to press the actor's hand convulsively and stammer a few words of appreciation in memory of the service the film star has rendered him. For Harold Dare, with the aid of his famous radio technical staff, exposed a dastardly scheme which would have brought ruin to the Gigantic Trust Company of Los Angeles, snatching the daily bread from the mouths of thousands of widows and orphans.

Thus it happened that as Harold Dare left the Flicker Film Studio after a day of whole-souled labor for his great following of film-fans, he found a man waiting for him. It was Scott, the chief engineer of the Dare technical staff.

"Mr. Dare," he said, respectfully, "a perplexing problem has arisen in connection with our public-service work."

"What is it, Scott?" asked Dare, in a kindly tone.

"During the past week," replied the engineer, "a great many people have called our office, complaining of a noise which interferes with radio reception. Our information regarding the noise is as follows: It begins at eleven o'clock every night, and continues until daybreak; it sounds like severe static, but is louder than static ever could be; and it is noticed principally in the business and apartment-house section of the city. We have sent out a squad of men to investigate. They have found that the center of the disturbance is somewhere down-town; but it cannot be definitely located without special investigation, at a considerable expense."

"Do you see in the noise a menace to the public weal?" cried Dare.

"I cannot but view it with alarm," answered Scott. "It is bringing disappointment and hardship to the radio public. Your own station, Mr. Dare, is hardly distinguishable through the noise. Mothers say their children will not go to sleep without their bedtime story from WROT. Servants threaten to leave, guests to give up their apartments, unless the noise is eliminated. Distant reception is impossible. Several DX fans have been narrowly prevented from suicide; one has already died from apoplexy. The public weal demands action."

"Then," cried Harold Dare, his great heart touched by the need of his public—his public, for which he had labored so long, and which was dependent upon him, not only for the epoch-making Dare films everywhere in demand, but for the unrivalled entertainment and uplift disseminated through WROT—"then, go to it! Put the entire staff on the case; the public must be protected at any cost!"

He took out his note-case and extracted a bill. "Here," he said, "I am behind you. Spare no expense. Superintend the work yourself, and see that the noise is located and eliminated at once."

He reached into his pocket and took out a quarter. "Here is something for yourself."

"Thank you, Mr. Dare," murmured Scott, touched by his chief's generosity. "I shall devote my every effort to the case."

In a few moments, he had leaped aboard a street-car and was speeding toward the headquarters of the Dare organization, the studio at WROT.

The field-work of the Dare technical staff was handled chiefly through a fleet of radio-equipped motor-cars. The rear seat of each car had been removed, and replaced by a small framework, into which could be locked any of a number of interchangeable pieces of equipment. The standard apparatus, used principally for the tracing down of power leaks and other sources of radio interference, consisted of a very efficient, multi-stage

amplifier, coupled to an extremely sensitive indicating device. A loud speaker fitted into a clamp, and a loop antenna into a swivel socket. At the base of the loop was a pointer, which, revolving with the loop, pointed out the direction upon a map of the city.

To the back of the front seat was clamped another framework, into which fitted a compact transmitting and receiving outfit, equipped for both code and phone. A metallic screen, woven into a pad of cloth and placed in the top of the car, served as antenna; the steel chassis of the car made a good counterpoise. Operating in a band upon the short waves, the fleet of cars could throw a net about a large territory, and could be directed from any point in the chain.

That evening, a dozen of these cars were stationed in a circle enclosing the central part of Los Angeles. In each sat two engineers of the Dare staff, besides a chauffeur. Each car had a number, and awaited orders from number one, from which Scott was to direct the search.

At a little after eleven o'clock, the mysterious noise commenced. Around the circle sped the word. At each post, the engineers turned their loops in the direction from which the noise seemed to come. At a signal, they began to move toward the center of the disturbance.

Ten minutes later, they stopped for conference. Their circle was distorted now. In the northeast section, the three had come closer together, and were only a few blocks apart. Numbers four and five, in the southeast, were headed north; number six was going west. In the southwest, seven and eight were pointed north, number nine east; and in the northwest, number ten south, and eleven and twelve southeast. Scott plotted their positions on his chart. Nothing was to be learned, so far. "Forward," went the word.

Shortly after, numbers one and two met. The road lay along a street-car line. The plane of the disturbance lay parallel to it; but—north or south?

"Go straight north," commanded Scott, "and we will go south."

The two cars faced about, and sped in opposite directions along the street-car line.

Several miles south, the street-car line took a right turn to the west. Scott stopped his car. "Call number two," he ordered, "and see whether the noise is louder or weaker."

"Weaker," came the answer.

"Then face about and join us."

Meanwhile, number three had proceeded south, and arrived at the car line, along which number one was now travelling. The plane of the disturbance lay east and west, along the car line.

"Number three, continue south for a mile and see if you pick up the noise again."

Number three did so, and reported that the disturbance had diminished about fifty per cent.

"Proceed west, parallel to the car line."

The signal strength was the same. Seemingly, the noise was being propagated along the trolley line.

In the other quarters, the same thing was occurring. The cars were following the street-car lines. Their paths were converging toward the center of the city. As the investigators proceeded, the noise grew steadily louder.

Scott frowned as he studied the chart. A score of possibilities ran through his mind. Might the disturbance originate in the power



"Do you know what is on the other side of that wall?" demanded Scott grimly. Harold Dare thought a moment, then started, "The Gigantic Trust Company!"

lines, and get into the trolley circuit by induction? Hardly. What could be the cause of it all? A leaky insulator in the trolley line? There was no apparent reason why an insulator should begin leaking at exactly eleven o'clock every night. A thought struck him. He sent out a general call for all investigators to halt. Meanwhile, he found a telephone and called the residence of Harold Darc.

The great actor answered the phone himself. He had been working in his study, laying plans for the good of Flicker Film fans. He listened with interest to the account of the search. "Can you not localize the disturbance more definitely?" he asked.

"The paths of our parties seem to converge," answered the engineer. "They will bring us together somewhere downtown, where there are so many car lines and power circuits that a false start may throw us completely off the scent."

"Wait there a few moments," decided Harold Darc. "I will see what can be done."

He took up the telephone book and found the number of the trolley company. There was no one at the office. He called the main power-house. The man in charge was incredulous at first, but when he was convinced that the great Harold Darc himself was speaking, he was most accommodating. "Could you shut off the power on all your lines for five minutes?" asked Darc.

The man hesitated. "It's against all the rules," he finally said, "but I'll do it for you."

Darc phoned Scott, and the news went round the net.

The noise suddenly ceased. The power had gone off. All over the city, street-car traffic was at a standstill.

"Can you hear the disturbance?" flashed

round the net. At each post, the engineers turned their loops in all directions, but the noise was not to be heard.

Scott returned to the phone, and relayed the news to Harold Darc. "The noise is certainly in the trolley circuit," he said.

"Stay there a few moments more," said Harold Darc, with sudden resolution. "I am going to look into this affair myself."

In a short time, Harold Darc's powerful touring car pulled ahead of number one. Scott and Darc conferred a moment. "If we could trace the noise down to one branch of the line, it would simplify things," said the engineer.

"Then we must go to the central power station," decided Darc. In a moment, the two cars were speeding toward the power plant, while word went round the net to stand by for the test.

Awed by the presence of the great actor, the superintendent of the plant was only too glad to accommodate. The test car drew up outside the open window.

"There are four sub-stations in the city system," said the superintendent, "so you will be able to trace the trouble down in a general way."

At Harold Darc's command, the superintendent opened the switch that fed the northern quarter of the city. A gong rang insistently, and a light flashed. "Our warning system," explained the superintendent.

The engineer at the receiver called through the window. "Numbers three and four report the noise dead; all others, no difference."

"Then the trouble is not in that direction," said Scott. "Try another district."

The power man closed the switch and opened another. "The southern quarter."

In a moment they had the report. "Num-

bers six, seven, and nine report noise; others say no difference."

"Try another," said Scott.

The superintendent opened another circuit. "The western section."

The man at the receiver shook his head. "Eight and ten dead."

There remained one circuit. "This switch controls the whole down-town part of the city," said the power-man. He threw the lever.

The engineer outside muttered excitedly. "All report no noise!" he shouted.

The others looked at one another triumphantly. "That settles it," said Scott. "That trouble is somewhere in the business district."

Quickly the word went out. The superintendent gave Darc a chart of the down-town trolley system, marking the boundaries of the district fed through that sub-station. With its help, Darc directed the formation of a new circle about the city.

The noise was very strong. It was necessary to proceed very slowly, checking at every step, and turning the amplifier low to get an accurate reading. Once, Darc phoned the central station to make sure that the noise was in the trolley lines; but when the power went off, the noise vanished.

After a time, it was apparent that they were making little headway. The multiplicity of wires in the down-town district led to many errors.

"Mr. Darc," said Scott, "we must proceed in a different way. At this rate, we shall never find the trouble."

After a conference, it was decided to cut the trolley wire, a block at a time, in order to localize the disturbance. The superintendent offered the use of a number of trucks, on which were mounted ladders used

(Continued on page 264)



"He put on a burst of speed; but even as he did so, a tall man dashed out of the building, leaped into the car, and was off in a flash."

Radio News of the Month Illustrated



A double rebroadcast, on May 20-21, transmitted to the Antipodes the complete program of 2LO, London, from 3 to 9 p. m. on Friday. This was picked up by the short-wave station at Eindhoven, Holland, which relayed it on 30.5 meters with 5-kw. power. At Sydney it was rebroadcast by 2BL and heard clearly in New Zealand, half-way round the world from its origin. The corresponding Australian time was 1 to 7 a. m. Saturday. So clear was the transmission that the music of a new song in London was taken down by an Australian listener and published in the Sydney newspapers next morning. Reception at Sydney was obtained on a three-tube set, built the previous day.



The British Air Ministry is enlisting radio listeners in a study of the distance at which the fire of heavy cannon may be heard. A time signal is sent out, at the end of which a big gun is fired; and listeners are requested to note the exact time at which they hear the report.

Francesco Caruso, under sentence of death, was permitted to listen in by radio from Sing Sing to the pleas for clemency being broadcast from a New York mass meeting held in his behalf. The prisoner is thus borne up by the knowledge that sympathetic friends are working for him.

A radio "straw vote" on the question of prohibition is being conducted by an Eastern station. Short addresses on the subject are given daily and the returns of "dry" and "wet" votes announced.



The English Royal Air Forces held an "airplane dance" at Hendon on July 2. Two hundred pilots listened in to the regimental music, and maneuvered their planes accordingly.

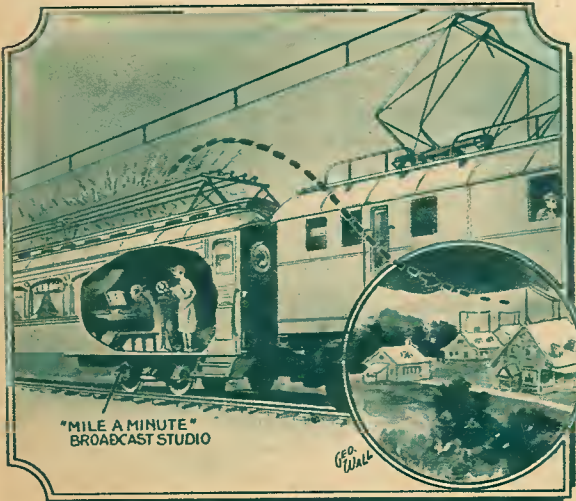

The first broadcast station on a railway train began operations July 1, on the lines of the Chicago, Milwaukee and St. Paul railway. The "Mile-a-Minute Studio" was given a special call of WHBL for the occasion; and a wavelength of 205 meters was authorized by the Radio Commission.

Barley, in the intense electrical field beneath the aerials of the government station at Arlington, opposite Washington, grew rapidly until it was higher than a man's head, says Admiral Bullard, chairman of the radio commission, who ascribes this development to the radio waves. Scepticism as to the cause assigned, however, is expressed by the Department of Agriculture.



At the signal of the tune, "Rolling Home," the planes took their cue; forming line astern to the notes of "Round the Mulberry Bush." "The More We Are Together" was the signal for resuming the original formation; and "Chick, Chick, Chicken" gave the cue for the planes to "lay their eggs," as dropping bombs is termed in aerial slang. Over twenty miles of cable to loud speakers was laid, so that the mammoth audience on the ground could follow the program.

Innovations in Broadcast Studio Equipment

German Station Has Property Room to Supply Noise Background for Programs

By HERNDON GREEN

BECAUSE of the many features incorporated in its construction, the new radio studio of the broadcast station located at Hamburg, Germany, is one of the most interesting places of its kind now in use. Two innovations not found in American studios are a director's desk in the studio proper and a room for acoustical properties, by means of which sounds of any kind can be produced to enhance the effectiveness of a musical performance or particularly a radio play. In the United States, a number of radio dra-

horns and other wind-driven devices are produced with the aid of compressed air, contained in tanks shown in a row on the left side of the room. The passage of the air through the actual noise-making instruments is controlled by a number of valves located on a control board, at which the director of the performance sits. The effects of storms and other such disturbances can be produced by means of a "storm box," which enables

led through an amplifier and reproduced in the studio itself through a regular loud speaker. Thus the actors in the studio are under the same acoustic influences as their listeners, and thus are enabled to put the proper feeling into the play. The sound reproduced by the loud speaker in the studio acts on the regular studio microphone and is broadcast in the usual manner.

Of course, the mechanically-reproduced background noise must not interrupt the dramatic movement of the radio play. To insure its proper place and use, the studio

Desk from which noises are controlled. Note phonograph turntable at left.

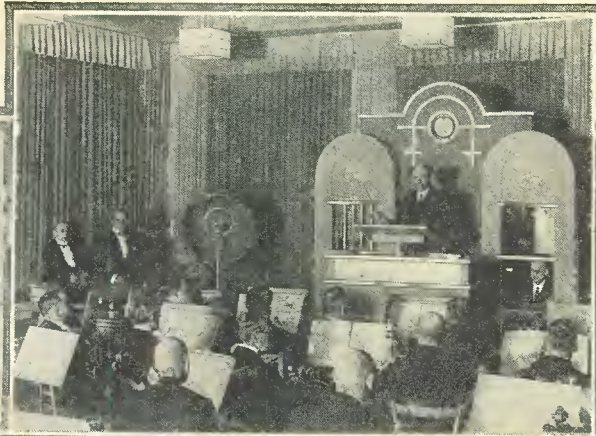
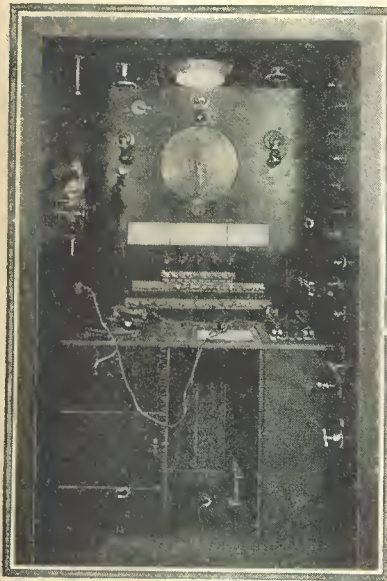

The conductor and the prompter at their desks in the studio.

the director to represent everything from the beginning of a light rain up to the final downpour of a tempest.

RECORDING NOISES FOR REPRODUCTION

When the action of a radio play, or other microphone presentation, calls for a background of sounds that cannot be reproduced with the compressed air apparatus, the technical operators of the studio visit some place where such noises may be heard, and make an actual phonograph record of them. This record is then placed on a phonograph turntable located in the acoustical property-room and connected by an electrical tone-arm to an amplifying system. When the action of the performance reaches the point where these recorded noises are essential, the attendant merely turns on the phonograph.

All the sounds produced in the radio property room are impressed on a microphone,

The interior of the acoustical property room. Notice the row of compressed air tanks at the left.

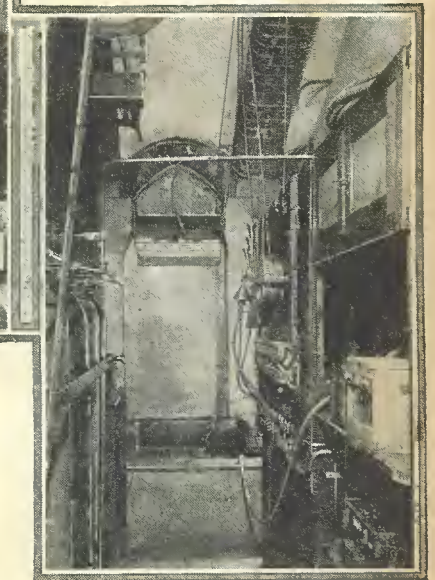

directors must prepare the complete show in advance and arrange a prompter's cue book for their own assistance.

It will be noted, in the illustration showing an orchestra playing in the studio, that the conductor stands on a little elevated platform, at one side of which is an opening forming a small desk. The prompter who sits at this position is able to direct the performance and, at the same time, maintain proper control over the acoustical property-room, which is directly behind him.

Radio DX and the International Time Zones

RADIO, it has been asserted, is making us ear-minded. For those of us, at least, who are piling up DX records, it is also making us time-minded. And now that reception of stations across the Pacific is being reported with almost monotonous regularity, a few hints on figuring the difference in time may not be amiss to readers who have not studied the matter systematically.

This is especially true, because much has been put in cold type, by those who should know better, giving a very incorrect idea of the matter. We have seen articles, hastily written of course, indicating that there can be two days' difference in date between two points on the earth; which is untrue, of course, if both are using the same calendar.

Ninety years ago, nobody but an astronomer or a ship's captain had to trouble with differences in time. But, as soon as the

telegraph was introduced, and the ocean cable, business men dealing with close margins of time had to deal with the time differences of cities; and railroads found the problem an important one. Yet, even after the establishment of the international time zones, comparatively few people had to bother with the problem, unless they were on long journeys. The institution of "daylight saving time," a few years ago, introduced a few perplexities; but, until the introduction of the radio as a domestic utility, the average man in Ohio had little cause to inquire what the time in California might be; and much less the Californian, the time in Australia. Now it is a burning question for a great many radio fans.

Although it is comparatively easy to compute the time-difference between New York and San Francisco, it is harder to compute

the difference between San Francisco and Sydney; because, in the latter case, the shortest way across is the longest way round.

DON'T TRIP OVER THE DATE LINE

The incorrect calculations we have spoken of before would have been entirely avoided if those who made them had not tried to cross the *International Date Line*. Don't do it without practise, or you may make an error of a couple of days.

A resident of Honolulu, Hawaii, for instance, who is listening to Auckland, New Zealand, knows that there are two time belts between them, each an hour wide. (The four thousand miles' difference from north to south has no effect upon time). But he also knows that the difference in time is not two

(Continued on page 275)

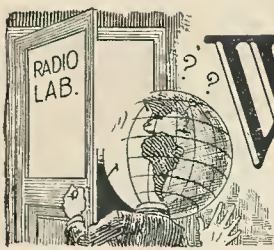

What's New in Radio



THREE MOUNTING POSITIONS POSSIBLE WITH NEW SOCKET

AN improved socket, which embodies several new features, has recently been put on the market. As can be seen from the illustrations, it is adapted to universal mounting. To mount it on a wooden panel or baseboard, it is merely necessary to drill two holes. The contact prongs are then bent over, and are wired on the top of the panel or baseboard.

If six holes are drilled in a bakelite panel, sub-panel wiring is possible with this socket, although it remains on the top of the panel as shown in Fig. C. It can also be mounted on a sub-panel of bakelite or metal by drilling one large hole and two small holes as shown in Fig. D.

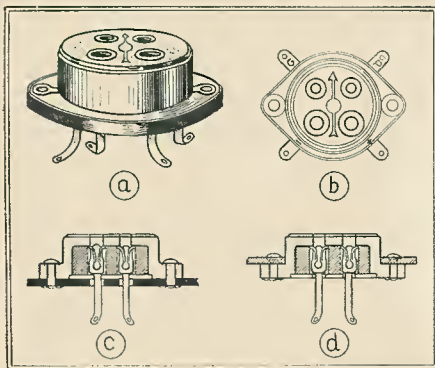

(a) General view of the socket; (b) top view, showing the shape of the receptacle; (c) method of mounting on sub-panel of bakelite or other insulating material; (d) method of mounting on metal sub-panel.

Illustrations courtesy H. H. Eby Mfg. Co.

Three-point spring contacts, the full length of the prongs in tube bases, are employed, insuring perfect contact at all times.

PRIMARY-LOAD COIL IMPROVES SELECTIVITY OF SET

RADIO listeners who are troubled with interference between broadcasting stations in the lower side of the band, between about 220 and 330 meters, may find some relief in a little device designed for connection in the aerial circuit of standard receivers, such as the neutrodyne and others of the tuned-R.F. type, using antenna couplers

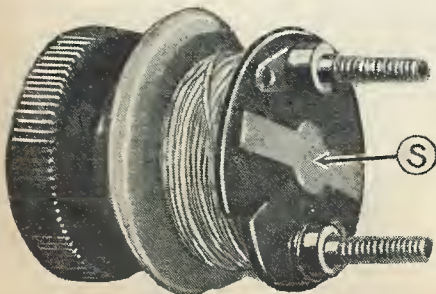

The interference reducer with its case removed. In this view are shown the jumble winding and the switch S, which short-circuits the coil when the knob is turned to "off."

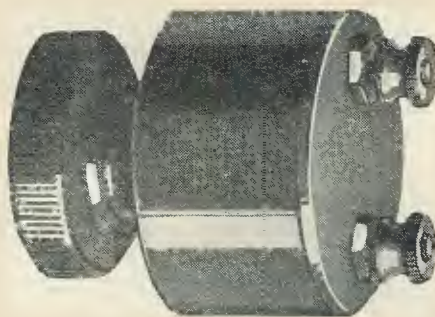

The interference reducer is a simple little affair, made of wood. The knob at the left turns a switch blade inside the case.

Illustrations courtesy Central Radio Labs.

with primaries of the untuned (so-called "aperiodic") variety. It is connected simply in series with the aerial wire, and may be cut in or out of the circuit by means of a knob.

This selector instrument consists merely of a jumble-wound coil, which acts as a loading inductance to raise the natural frequency of response of the antenna circuit to a point within the lower limits of the broadcast band. With a comparatively fair condition of resonance established between the primary and secondary, the selectivity of the first tuning stage is improved considerably over what it was previously with the roughly-untuned primary.

The makers of the device wisely qualify their claims for it, and state truthfully that it is not an absolutely positive cure-all. They warn the user not to expect it to separate stations on the same wavelength, or on waves so closely adjacent that audible heterodyning results; but they do promise, accurately enough, that it will produce an improvement with most sets of the aforementioned kind.

The instrument takes the shape of a wooden cylinder, 1½ inches in diameter and one inch high, with a switch knob on one end and two binding posts on the other. It is intended for connection in the back of the receiver somewhere, and is not made for panel mounting.

The external appearance of a novel loud speaker whose sound-producing member is a built-up panel of wooden laminations.

Left: Front view of the loud speaker, Right: back view, showing the binding cleats C and the nut N, which holds the driving rod of the speaker unit against the wooden diaphragm.

Illustrations courtesy Asparad Radio Corporation.

LOUD SPEAKER USES FLAT WOODEN DIAPHRAGM

IN a new loud speaker of unusual design the vibrating element which sets up the sound waves is a flat panel of thin wood. This is driven by a heavy speaker unit fastened to a rigid wooden bridge, which is attached to the frame holding the vibrant panel itself. The reproduction afforded by this arrangement is of high quality.

The vibrating diaphragm member is built up from half a dozen narrow strips, glued edge to edge and sawed in such a fashion that their grain runs at an angle of about 45 degrees to the horizontal table line. They are further reinforced and stiffened by three vertical cleats on each side of the assembly,

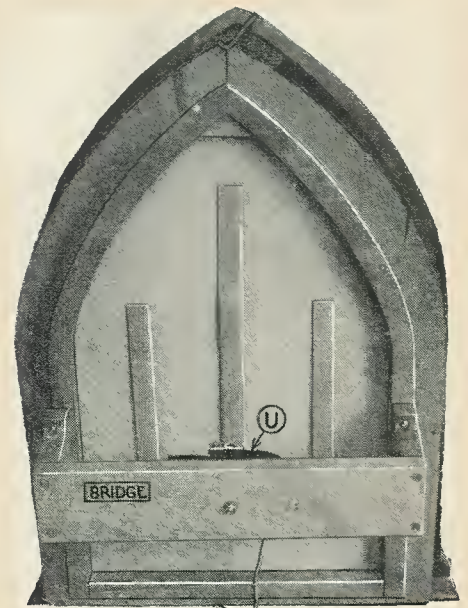

The inside of the speaker, showing the heavy wooden bridge which supports the unit U.

the same brads that hold one cleat penetrating the wood and holding another on the opposite side.

The end of the driving pin of the loud-

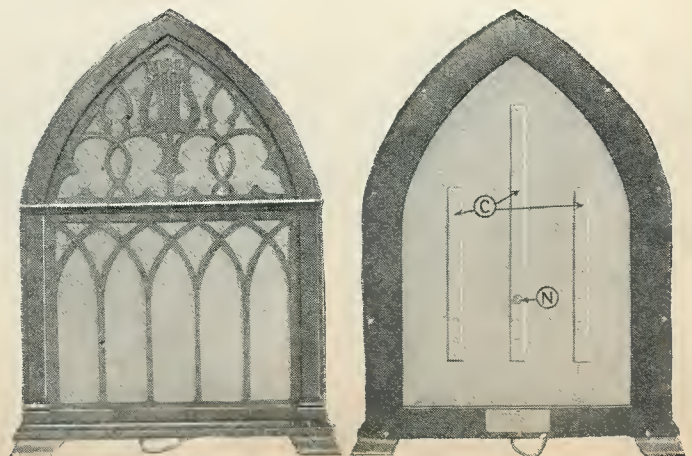

speaker unit, U, goes through the long center cleats near their bottom and emerges at the back of the instrument at the point N, where it is fastened by a nut. The wood diaphragm itself forms the back of the speaker. The front consists of a decorative sawed-out grillwork, backed by a gold-colored mesh curtain. The overall dimensions are: height 25 inches, width 18½ inches, depth 7 inches.

Because of its shallowness this loud speaker is especially suited for a place like the mantelpiece over a fireplace or the top of a narrow bookcase suspended from the wall. Of course it may be located anywhere; but a position against a wall or other broad surface is desirable, because the latter acts as a reflecting medium and spreads the reproduced sound all over the room.

ELECTRICAL TONE ARM FOR PHONOGRAPH IS EFFECTIVE

ANOTHER electrical tone-arm, for attachment to a phonograph to make the latter reproduce through the audio-amplifier portion of a radio receiver, has made its appearance. The device is of the magneto-generator type, which is proving very effective for translating the impressions in phonograph records into electrical impulses carrying the characteristics of the voice or music cut into the discs.

In fundamental construction it greatly resembles the unit illustrated on page 120 of the August, 1927 number of RADIO NEWS. A small chuck holds a regular phonograph needle, which, when vibrating in accordance with the grooves in the record, causes the end of a soft-iron armature to vibrate between the pole pieces of a permanent magnet. This movement disturbs the field of the latter, and consequently a varying emf. is induced in a bobbin of wire, through the center of which the armature passes. This current is led through the audio amplifier of the radio set, and its variations are eventually reproduced as sound by the loud speaker.

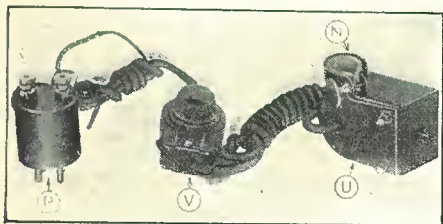

The three parts of the phonograph attachment: P is the plug which fits into the detector-tube socket of the radio receiver; V a variable resistor which acts as a volume control; U the phonograph unit itself. The latter fastens to the tone arm by means of the clamp N. Illustration courtesy Pacont Electric Co.

The whole phonograph apparatus consists of three parts: the substitute tone-arm itself (U), a volume control V, and a plug P. The tone-arm or pick-up unit is fitted with a clamp, N, which slips over the neck of the tone-arm on the talking machine.

To use the apparatus, the regular phonograph-head is removed from the tone-arm of the phonograph and the unit U clamped on in its place. The plug P is inserted in the detector-tube socket of the radio set, and the audio tubes alone in the set are turned on. A needle is clamped into the chuck of the unit and placed on the phonograph record in the usual manner. If the turntable is now started, the radio's loud speaker will reproduce the phonograph music.

When tested with a small portable phonograph and with the audio amplifier of a Loftin-White receiver (feeding a cone speaker) this attachment produced results which could really be called extraordinary. The volume was far greater than necessary, but could be kept under control easily; while the naturalness and the range of the tonal response were a revelation.

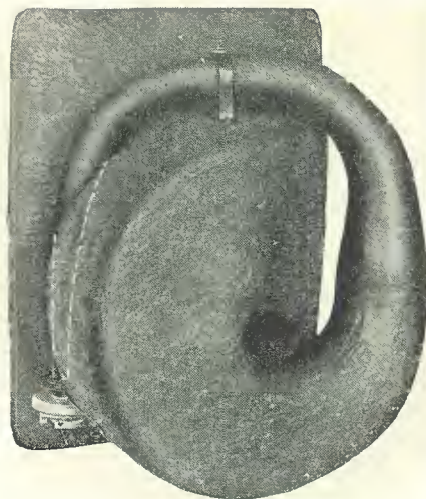

Left: Rear view of the curled up-horn. The speaker unit is attached to the small throat of the horn, which is indicated by the dotted lines. Right: The open bell of the horn. Illustrations courtesy Newcombe-Hawley, Inc.

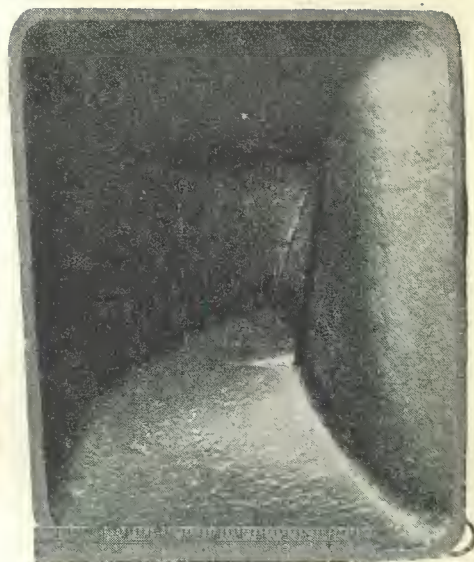

COMPACT HORN HAS SEVEN-FOOT TONE CHAMBER

RADIO constructors intending to make a cabinet speaker, or a console containing the complete radio set and loud speaker, will be interested in the large horn illustrated herewith. This reproducer measures only 18 by 24 inches across its face and appears quite shallow; but its tone chamber is actually over seven feet long, the horn being curled up in such a fashion that it occupies comparatively little space.

As shown in the back view of the horn (at the left) the small throat, to which the loud-speaker unit is attached, rests between the back of the rectangular face and that portion of the horn where it starts to expand into the bell. The diameter of the chamber continues to increase in a semi-exponential manner, the horn curling up on itself until it assumes a not-distant resemblance to a magnified pretzel.

The horn is made entirely of a papier mâché composition, which is noted for its desirable acoustical qualities. When fitted with a good loud-speaker unit of a balanced-armature type, and connected to a six-tube tuned R.F. receiver in the RADIO NEWS Laboratory, this horn reproduced broadcast voice and music with remarkable clarity and volume. It did not favor either the high notes or the low ones, as do many shorter horns, but provided a distinctly agreeable balance between them. No metallic or ringing noises were noticeable, because of the "deadness" of the paper composition itself.

This reproducer may be mounted on either its short or its long side, and is easily adapted to consoles and other types of cabinets.

SMALL VERNIER DIAL

A SMALL vernier dial, which is especially suitable for use on portable radio sets where space is limited, is now being made by a German manufacturer, who has submitted

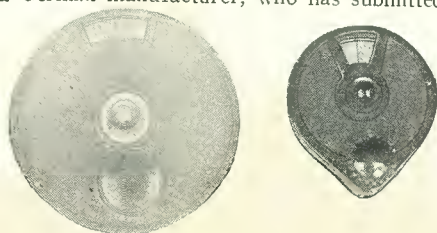

The small German dial is at the right. Note how it compares in size with the standard four-inch size, at the left. Illustration courtesy Cornalit-Werke, Berlin.

a sample of his product to the RADIO NEWS Laboratories. It is made of black insulating material and is only 2¾ inches in diameter. A small adjusting knob causes rotation of a brass disc on the inside of the dial's shell. This disc in turn is equipped with a hollow stud at its center, in which the dial of the condenser or other instrument is fastened. The accompanying illustration shows how this apparatus compares in size with a standard 4-inch American dial.

NEW VARIABLE RESISTOR WILL CARRY 25 WATTS

AT the present time, when socket-power units are coming more and more into use, resistors of fairly high current-carrying capacity must be utilized in obtaining the various "A," "B" and "C" voltages required. A rather novel resistor which is suitable for this purpose has just been put out by a well-known manufacturer. It is obtainable in various resistance ranges, up to 50,000 ohms. All the sizes are all rated at 25 watts and will stand up indefinitely under this load.

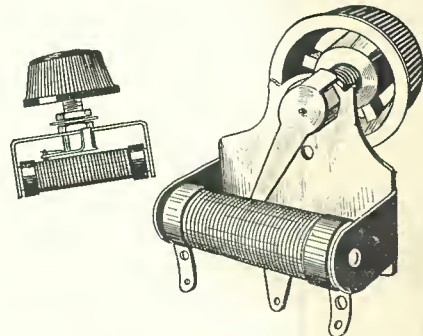

Left: Top view of the variable resistor. Right: General view, drawn from the back. Illustration courtesy Electrad, Inc.

The mechanical construction is rather unique. An asbestos-covered enameled copper wire is wound with a special resistance wire, which has a negligible "temperature coefficient," and this element is wound about an indestructible hollow tube, 9/16 inch in diameter and 2 inches long. A movable contact arm runs right over the wires, permitting exact adjustment of the resistance over the entire range.

Each unit is supplied with a perforated ventilating cover, and uses a single-hole mounting. These new instruments may be used either as straight variable resistors or as potentiometers.

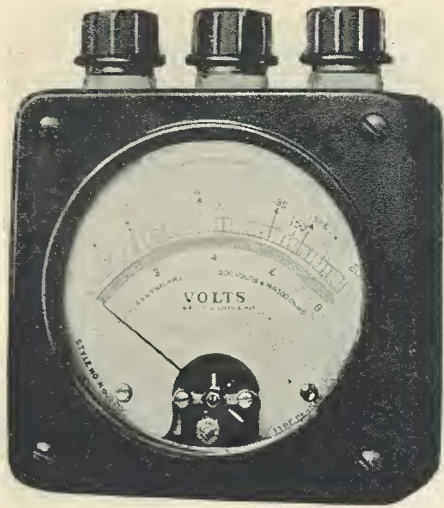

This voltmeter is provided with a strong case which protects it from dirt and injury. Illustration courtesy Westinghouse Electric & Mfg. Co.

NEW VOLTMETERS FOR "B" UNITS HAVE HIGH RESISTANCE

THE inherent characteristics of the majority of "B" socket-power units make it impossible to obtain correct readings of voltage with the ordinary commercial voltmeters having resistances of but 50 to 100 ohms per volt. The readings of these meters are from 15 to 50 volts lower than the actual voltages supplied to the vacuum tubes when the instruments are disconnected. Engineering tests show that a voltmeter must have a resistance of about 750 ohms per volt to be accurate for "B" power-unit measurements; at lower values the comparatively high current drain of the meter causes the drop in the output voltage.

Two new voltmeters, just announced by one of the largest electrical manufacturing firms in the country, are designed to provide the correct resistance values for such measurement of "B" supply voltages. One of these has a resistance of the requisite 750 ohms per volt, consuming only 1 1/3 milliamperes on full-scale deflection; the other, which has 1,000 ohms per volt and draws one milliampere, is recommended for use where specially accurate measurements are necessary.

The first meter is illustrated herewith. It is 3 1/2 inches square by 1 1/2 inches thick, and is made with a molded micarta acid-proof case of strong construction. The other is 4 1/2 inches square and 2 inches thick. They are available in various voltage ranges up to 500 volts.

FILAMENT SWITCH ACTS AS ITS OWN LOCK

A GERMAN concern is marketing the filament switch shown in the accom-

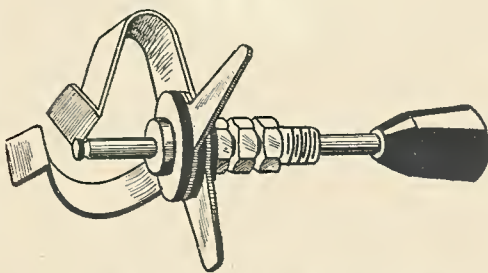

The little plunger-rod of this filament switch can be removed completely from the sleeve in which it fits. Illustration courtesy Owen, Berlin.

panying illustration. The device is of extremely simple construction and very light in weight. It measures 1-7/8x1 inch, and is equipped with a one-hole mounting. Positive contact is made by two springs; the movement of the plunger is very smooth. A minimum of metal is employed in its construction.

The little plunger, which is fitted with a knob of insulating material, can be removed entirely from the mounting sleeve. Thus the switch acts as its own lock, and only the possessor of the plunger can turn the set on.

ADJUSTABLE CONDENSER USES SEPARATE 1-MF. UNITS

A VERY compact adjustable condenser has recently been developed by a New Jersey manufacturer. As will be seen in the illustration, this device consists of a bank of 1-mf. units, held securely in place by a patented metallic bracket. It can be mounted in any position.

By means of an adjustable connector strip, which slips over the lugs on the condensers, different combinations of capacities can be had at will. Should any single unit of the condenser bank break down, it is very simple and economical to replace it. In the usual

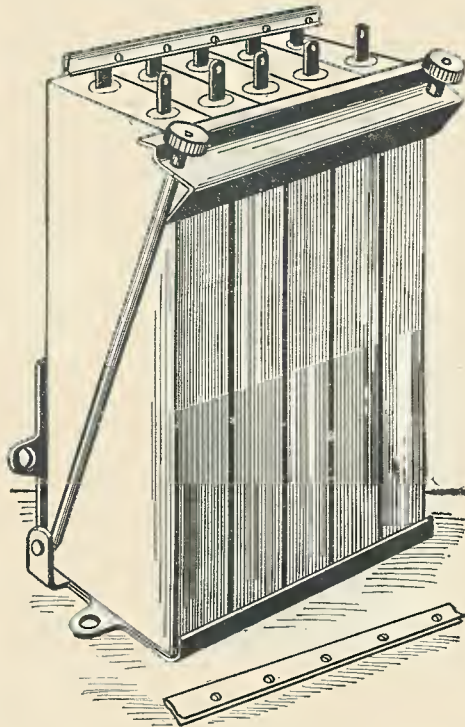

Different capacity-combinations can be quickly obtained with this condenser bank, by means of the connector strips shown. Illustration courtesy Globe Art Mfg. Co.

high-capacity condenser, if a breakdown occurs, the entire condenser is rendered useless.

These condensers are non-inductive (this is especially important in radio-frequency circuits) and the working voltage (which allows a wide safety margin), is indicated on each unit.

ALUMINUM PLATES USED IN FIXED CONDENSERS

IN the accompanying illustration will be seen an improved condenser, for use in socket-power units or other devices requiring a high-test filter or by-pass condenser. This instrument has been designed for the lowest electrical losses. Pure linen paper, impregnated with paraffin under high vacuum,

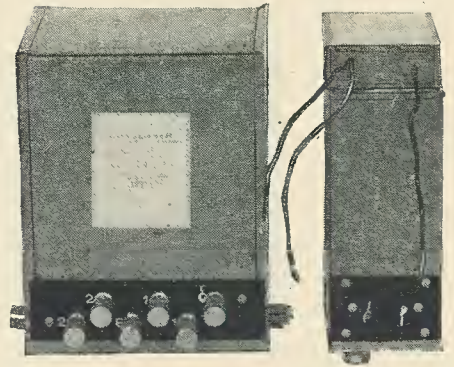

Left: A multiple-condenser unit designed for use in the filter circuits of "B" socket-power devices. Right: Two smaller condensers. Illustrations courtesy Igrad Condenser & Mfg. Co.

is used as the dielectric. Aluminum foil in place of the usual tin foil is used for the plates. Theoretically, copper foil would be ideal for this purpose; but, because of its tendency to corrode, it is usually avoided. The conductivity of aluminum is five times that of tin and, therefore, of considerable advantage. Furthermore, a condenser wound with aluminum foil weighs only about one-half as much as one made with tin foil.

These new condensers are tested at a D. C. voltage which does not exceed twice the designated D. C. operating voltage. (A flash test of a condenser is avoided by the manufacturers; who point out that it might frequently happen that, during a test of this nature, the condenser would be slightly damaged, although not broken down. Consequently, a condenser tested in this manner might not be perfect and cause trouble later.) Prior to shipment, each condenser is given a "life test" on a voltage more than 35% in excess of the operating figure. This test is conducted over a period of several days; so that any possible defect in process of manufacture would be uncovered.

These new condensers are available in all the standard capacities, and are suitable for use in different parts of radio receivers and socket-power units.

NO RESONANCE POINT IN R.F. CHOKE COIL

A NEW radio-frequency choke coil of good design is the latest product of a prominent New York radio manufacturer. It employs a specially-wound coil which possesses an extremely high impedance to R.F. currents of the frequencies used in American

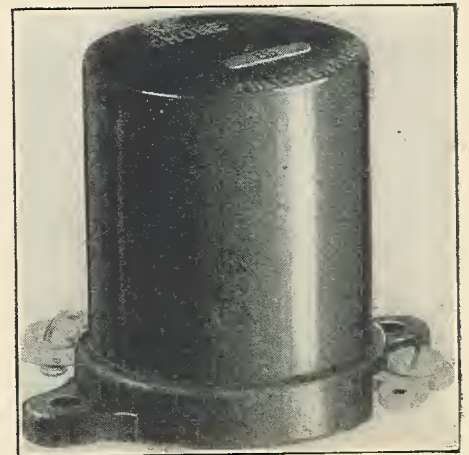

This R. F. choke coil is completely enclosed in a neat molded bakelite case. Illustration courtesy Hammarlund Mfg. Co.

broadcast work, and also has a minimum of distributed capacity. Because of the damping resistance of the inductor and its special method of winding, the choke does not become resonant at any point in the 200-600-meter broadcast band; and its choking action is uniformly effective throughout this range.

After being wound and impregnated with a low-dielectric compound, the choke coil is mounted in a molded, polished bakelite case which protects it against mechanical injury of any kind. The case itself is fitted with two small drilled feet, by means of which the device can be mounted in any position in a set. Soldering lugs and binding-post connections are provided at the bottom of the case.

The whole instrument, over all, is $1\frac{1}{2}$ inches in diameter and $1\frac{3}{4}$ inches high. It is available in two electrical values for the broadcast band. One type has an inductance of 85 millihenries, a distributed capacity of approximately 3mmf., and a D.C. resistance of 215 ohms.; the other has an inductance of 250 millihenries, a capacity of 2mmf., and a resistance of 420 ohms.

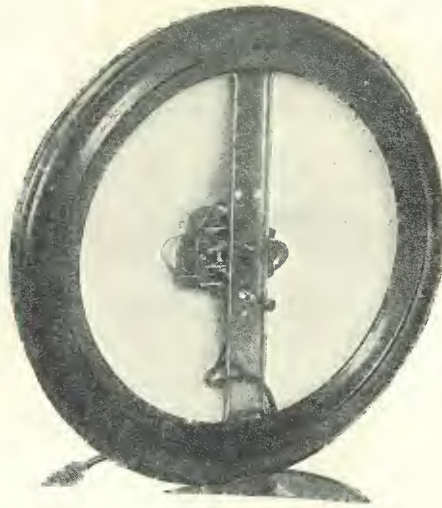

Left: The back of the cone speaker, with the silk cover removed to show the position of the drive-unit on the upright section of the frame. Right: The front of the same speaker. Illustrations courtesy *Bondette Mfg. Co.*

INSULATED ROTOR SECTIONS IN DOUBLE CONDENSER

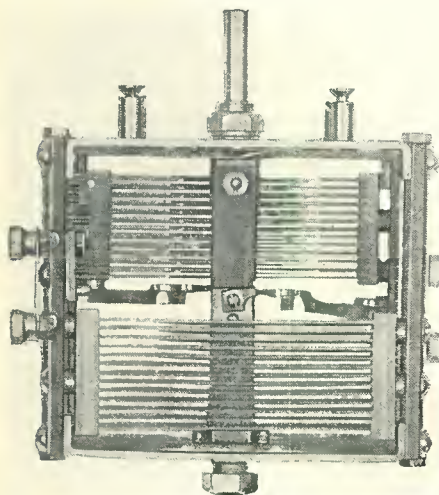

The two sections of the balanced rotor of this variable condenser are mounted on the same shaft, but are insulated from each other electrically. Note the pigtail connections in the center of the instrument, between the upper and lower stator sections.

Illustration courtesy *Ste. Belge Radioelectrique.*

A FRENCH radio firm has brought out a new double-rotor variable condenser, of the balanced type, in which the two sections of the rotor unit arc completely insulated from each other. This feature of the construction permits the instrument to be used in R.F. circuits of certain balanced or bridge types in which a common rotor connection would be distinctly a disadvantage.

The stator sections are likewise separated from each other electrically, being equipped with separate binding posts. By means of suitable connection strips supplied for the purpose, the two sections may be connected either in series or in parallel, to suit the requirements of particular hook-ups.

Because of the electrical separation of the rotors and the stators and of the number of available capacity-combinations, this instrument will appeal to the radio fan who is constantly experimenting with hook-ups. By its use the danger of short-circuiting the "A" battery in single-control sets is to a great extent overcome.

Mechanically, the condenser is well made. It is equipped with four threaded studs for mounting to the panel. The electrical construction is of the low-loss type, the insulating strips between the rotors and the stators being located at points where the electrostatic field is weakest.

CONE SPEAKER USES RIGID METAL FRAMEWORK

A NEW cone speaker possessing excellent acoustical characteristics has been brought out by a firm specializing in the manufacture of radio reproducers. It uses a single paper cone, a foot in diameter, which is driven by a unit of the balanced-armature type. The latter can be adjusted by means of a long screw which projects through the back of the speaker.

The thin paper cone is completely protected by a metal framework, which, because of its weight and rigidity, does not interfere with the operation of the vibrating element itself. The whole instrument is unusually rugged for a cone speaker, and is capable of withstanding rough handling.

The front side of the cone, which is finished to resemble wood, is partially covered by a five-armed frame. The back side is covered by a piece of pleated brown silk. This cover is not shown in the accompanying illustration of the back of the speaker; as it has been removed to show how the loud-speaker unit is fastened to a vertical bar running diametrically across the round frame.

The speaker, over all, is 13 inches in diameter and 15 inches high, and is neatly finished in an unobtrusive shade of dark brown. It is suitable for use with any type of broadcast receiver, and affords high-quality reproduction of both voice and music.

RADIO'S LATEST GADGET

FOR the past ten years the common radio grid leak has been the favorite victim of the sharp pens of comic writers. In numerous cartoons this defenseless little device has been shown equipped with faucets, lengths of garden hose, sprinkler nozzles, pails, sponges, blotters, water tanks and other contraptions; intended, presumably, to control and to catch the leakage from it. However, it has remained for a Chicago radio manufacturer blessed with a sense of humor to actually make and publicly display a grid-leak drip pan, a little nickel-plated brass trough which swings from the body of a grid leak in the manner indicated in the accompanying illustration.

This great invention was exhibited for the first time a couple of months ago, at the Radio Trade Show held in Chicago, where it was displayed in perfectly serious fashion along with the grid leaks, condensers, choke coils and other legitimate products of the manufacturer. Believe it or not, but a number of visiting dealers thought the device was an article intended for sale, and innocently

inquired about prices, package quantities, and so forth!

A printed folder was given away with each drip pan. We are reprinting its contents here so that our readers may acquaint themselves with the attachment:

FUNCTIONS OF THE DRIP PAN

"The tremendous strides of radio during the past year are only exceeded by this remarkable invention. No single radio item has ever been able to accomplish so much in doing so little. The ability of the Grid Leak Drip Pan to perform as well as anticipate irregularities in remote parts of the set with which it is not connected is almost beyond human comprehension. In fact, the inventor himself could never advance any real necessity for its use.

Grid Leak Drip Pan

Uniform Leakage (Maybe)



Automatic Control (Perhaps)

Patented and Patents Pending — Who Cares ?

The grid leak drip pan simply swings from the body of the leak, in the manner indicated above.

Illustration reproduced from folder of the *Leslie F. Muter Co.*

"The exact value of the grid leak has always been a question amongst authorities and yet this simple device easily settles the question for all time. Consider a two-megohm grid leak installed with a Grid Leak Drip Pan, in a position requiring a three megohm grid leak. One megohm immediately drips into the pan which with the value of the grid leak itself gives the proper value of three megohms, as the Pan easily understands the conditions and being very industrious maintains this position in spite of the laws of electricity, which it takes particular delight in upsetting without, of course, spilling its vague contents and *vice versa*.

"While testimonials have been rather slow in coming in, we feel confident that a trial on your part will readily substantiate the great merit of this device. While your grid leak might, again it might not. Who can tell? With summer here, this is at least a conservative sound and logical investment by which you alone can prove the numerous shortcomings of the device. As production will be limited to ten percent of the "B" Power Units made this year, we suggest your early action, although there will probably be a great surplus."



A Prize Portable Super-Regenerator



Radio News Contest Won by a Small but Efficient Set With Plug-In Coils

Super-Regenerative Set Contest

FIRST PRIZE, \$100.00

won by Dr. Titus Konteschweller, 69 rue de Wattignies, Paris, France.

HONORABLE MENTION:

O. F. Haylor, 318 Sherwood Avenue, Syracuse, N. Y.

Howard A. Newby, 5 West End Avenue, San Rafael, Cal.

A. P. Nielson, 1521 West 52nd Street, Seattle, Wash.

T. L. Battler, 217 South Front Street, Harrisburg, Pa.

Robert Bradford, 471 Merrick Road, Lynbrook, N. Y.

Gustave Huot, 3642 So. Bannock, Englewood, Col.

By JOSEPH RILEY

American radio constructors, and the seventh, the only prize winner, all the way from Paris, France. A total of eleven prizes (the first \$100, the second \$75, the third \$50 and the others smaller amounts), was offered; but RADIO NEWS regrets that it can award only the first prize, of \$100; as the other receivers, when carefully tested by the judges, were found to be neither stable enough electrically nor consistent enough in their operation to deserve inclusion among the winners. Their designers are to be congratulated, however, for their sincere efforts, which very evidently represented an enormous amount of personal labor.

A VERY ATTRACTIVE RECEIVER

The first and only prize winner is Dr. Titus Konteschweller, of 69 rue de Wattignies, Paris, France, whose entry is shown in the accompanying illustrations. The doctor's receiver is an exceedingly ingenious two-tube affair; it is completely contained in a strong carrying-case which is only 10 inches wide, 11 inches long, and 5 $\frac{3}{8}$ inches deep, and weighs altogether, just under ten pounds. It complies entirely with the conditions of the contest; which required, among other things, that the set be portable, that its total cubic capacity should not exceed 672 cubic inches, and that all parts, including batteries, tubes, loop aerial and loud speaker or telephone receivers, be built into the case.

Dr. Konteschweller's receiver worked very well—exceedingly well. The little case, greatly resembling a popular portable typewriter, could be laid on a desk and snapped open, and in a few seconds it would be bringing in local broadcast stations with comfortable volume. It uses a pair of headphones, and, for its antenna, a tiny loop that fits inside the top cover of the case.

What most impressed the judges is the fact that *there is absolutely no hand-capacity effect* about this set. This is most unusual, with super-regenerative receivers; and has been hitherto the greatest objection to the use of such circuits.

The prize-winning set received also a number of semi-distant stations with fair volume.

CIRCUIT EMPLOYED

The complete hook-up of the set is shown in Fig. 1. Dr. Konteschweller's description of his entry follows:

"The ends of the loop aerial connect to the single tuning condenser, C1, through the coil, L1; this tuning circuit being bridged across the grid of the detector tube, V1. The usual grid condenser and grid leak, C2 and R1, are

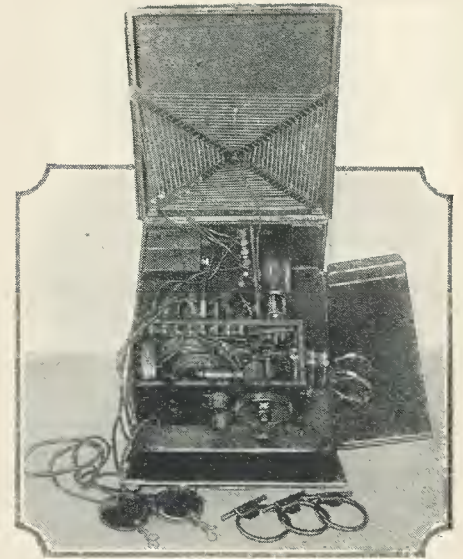

The prize-winning portable receiver opened and ready for operation. Note the headphones and the inductors in the foreground.

WHEN RADIO NEWS, in its April, 1927 number, announced a \$300.00 prize contest for super-regenerative receivers, it did so in the full realization that it was asking its readers to tackle one of the most difficult receiving circuits known to the radio art. Some of the best minds in radio have attempted to perfect super-regenerative sets that would function satisfactorily every time they were turned on; but, because of the inherent characteristics that make the operation of super-regenerators so complex, very few really successful instruments have been developed. A number of particular adaptations of the "super" principle, like the Muhleman *Autoplex*, produce wonderful results when they are operating just right; but the trouble seems to have been that they seldom operate properly.

In offering \$300.00 in cash awards for super-regenerative receivers of limited physical size, RADIO NEWS hoped to encourage home radio experimenters to greater effort than they would exert in dabbling with a more ordinary radio circuit. Of course, we did not wish to lend a mercenary air to this enterprise, which is of a purely scientific nature; but no one will deny that the prospect of acquiring a substantial sum of money looks far more interesting to the experimenter than the mere recollection of patient hours spent at the work table.

In view of the nature of the circuit and the strict terms of the contest, (see pages 1229, 1275 and 1276 of the April, 1927 number of RADIO NEWS), the number of receivers submitted, seven in all, is to be considered quite respectable. Six came from

used; the former has a capacity of .0001-mf. and the latter a resistance of 3 megohms. The tuning condenser is of the standard .0005-mf. size.

"The coils, L1 and L2, provide the regenerative effect, being connected in a regular series-tickler manner. Coil L1 has an inductance value of 65 microhenries, and L2 of 180 microhenries.

"Separate rheostats are used for the two tubes. The detector, V1, is a Philips valve, type B.406. Its filament is rated at 3.5 to 4 volts and 30 milliamperes, and requires a 15-ohm rheostat. The low-frequency oscillator, V2, is a Vicco tube, with filament rating of 2.5 to 4 volts, .06 amperes; filament rheostat 30 ohms. The 'A' and 'B' current is furnished by heavy-duty flashlight batteries contained in a compartment in the set case, as shown in the illustrations.

"In the plate circuit of the detector tube is included the pair of headphones (each phone of 2,000 ohms resistance), shunted by a .002-mf. condenser. The phones themselves are shunted by a filtering system, composed of the coil L3, of 100,000 microhenries, and the condenser C3, of .007-mf.

"From the grid-condenser connection of the detector tube a wire runs to the inductor, L5, in the grid circuit of the low-frequency oscillator, V2. This coil is in inductive relation to another of identical size (L4, 180,000 microhenries) which is in the plate circuit. Each is bridged by a fixed condenser of .002-mf. Coil L4 obviously is a straight tickler coil, reacting on L5 to produce oscillations, the frequency of which is determined by the electrical dimensions of the coils and condensers.

"No filament switch is provided, nor is one necessary. The tubes are turned on and off by means of their individual rheostats, which must be adjusted carefully in order to make the tubes oscillate properly."

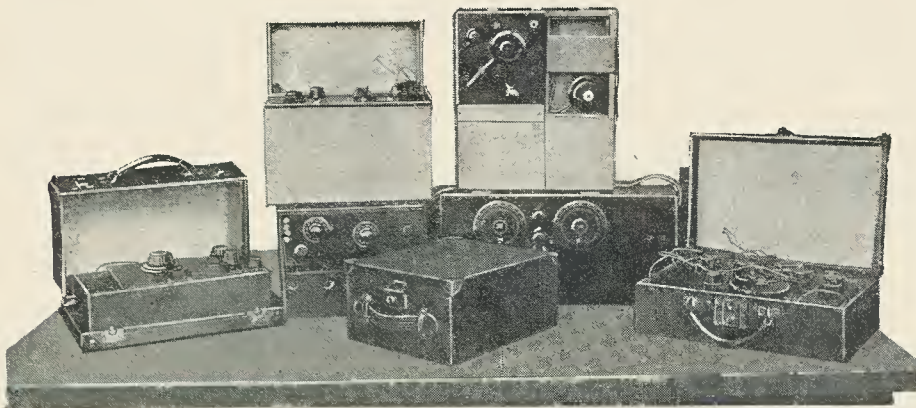

The entries in the super-regenerator contest. The case in the center of the group (front) contains the prize-winning receiver.

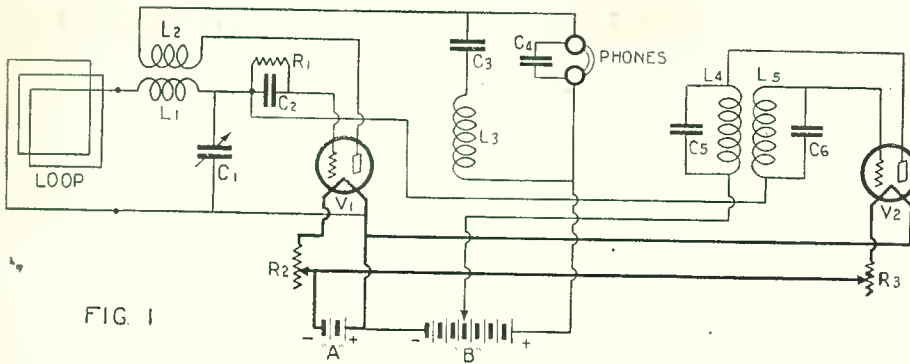

FIG. 1

The circuit diagram of the two-tube super-regenerative receiver, which was awarded first prize in RADIO NEWS' constructional contest.

METHOD OF CONSTRUCTION

This completes the description of the essential electrical features of the receiver. We are not giving the full details of the mechanical construction, because all the instruments used are of French make and cannot be obtained outside of Europe except at considerable trouble and expense.

Dr. Konteschweller's receiver is cleverly made, and other radio experimenters may be able to glean a few ideas from its construction. The loop aerial is of the flat variety, with one turn inside another on a simple X-shaped frame. The two ends of the cross bars that fit in the bottom edges of the cover are fastened by hinges to the latter, so that some adjustment of its position is possible. Of course, its directional effect is marked, and the set must be swung around so that the loop points in the direction of the station to be received. The whole loop fits snugly inside the shallow top of the carrying case.

INTERCHANGEABLE COILS

The top of the case swings upward, the right side swings outward and the front folds down. The tuning condenser and the filament rheostat are mounted on a small panel, which forms the cover of a box containing the various fixed condensers and the coils, L3, L4 and L5. Coils, L1 and L2, are not fixed permanently in place, but fit between clips on the right end of the instrument box. Along with Dr. Konteschweller's set came a number of coils of different sizes, which permit the circuit to be tuned to a number of wave bands beyond the 600-meter wave, which marks the upper limit of American broadcast transmission. The necessity for this coil arrangement will be understood when it is remembered that, in Europe, broadcast stations use waves from about 180 all the way up to about 3,000 meters. No single set of coils can take in such a wide range efficiently.

The batteries, as mentioned before, occupy the left section of the case between the loop aerial and the little instrument box. The two tubes are placed in sockets fastened to the rear of the latter, and assume a horizontal position when the receiver is laid flat on its back and opened. In the last few remaining cubic inches of space between the ends of the tubes and the back of the case are found the two earphones and the extra tuning coils. The earphones are not clamped in the usual U-shaped headband; instead, each is fitted with a half-moon clip which hangs over the ear.

The side and the front of the carrying case fold together in such a manner when the latter is completely closed that the whole affair has the appearance of a lady's small bag.

RADIO NEWS wishes to thank the following constructors for submitting entries in the super-regenerative set contest, and re-

grets that it is unable to award them prizes: O. F. Haylor, 318 Sherwood Avenue, Syracuse, N. Y.; Howard A. Newby, 5 West End Avenue, San Rafael, Cal.; A. P. Nielson, 1521 West 52nd Street, Seattle, Wash.; T. L. Battler, 217 South Front Street, Har-



This illustration shows the manner in which the French headphones are worn, as well as the relative size of the set.

risburg, Pa.; Robert Bradford, 471 Merrick Road, Lynbrook, N. Y.; and Gustave Huot, 3642 So. Bannock, Englewood, Col.

SOME CONCLUSIONS

The conclusions RADIO NEWS has drawn from the results of this super-regenerative set contest are as follows:

(1) Super-regeneration, a method of tube operation whose superiority has been demonstrated both theoretically and practically, has not received as much attention from radio experimenters as it deserves.

(2) Super-regenerative circuits are difficult to control, but they can be tamed, just as our once-hopeless oscillating R.F. circuits have been tamed.

(3) Tube for tube, super-regenerative receivers produce better results than others of any other design. And logically, therefore,

(4) Super-regeneration can be applied to the design of portable radio receivers; by which we mean sets which can be carried comfortably by one man, and which do not require the services of an automobile-trailer for their transportation.

(5) Super-regeneration, because of its many untouched phases and its marvelous potentialities, presents the most fascinating field for radio-receiver research the experimenter can wish for.

Although the super-regenerative contest is now over, RADIO NEWS will always be glad to learn of the experience of its readers with super-regenerative sets of any description; and it will welcome articles, both theoretical and constructional, dealing with the subject.

In a forthcoming issue RADIO NEWS will give, for the benefit of readers who may be desirous of constructing a super-regenerative portable of this kind, full constructional details for a set, very similar to Dr. Konteschweller's, but employing throughout American components which they can easily obtain. The excellent results which have been obtained with this circuit and arrangement warrant the fullest experiment by experienced set constructors.—EDITOR.

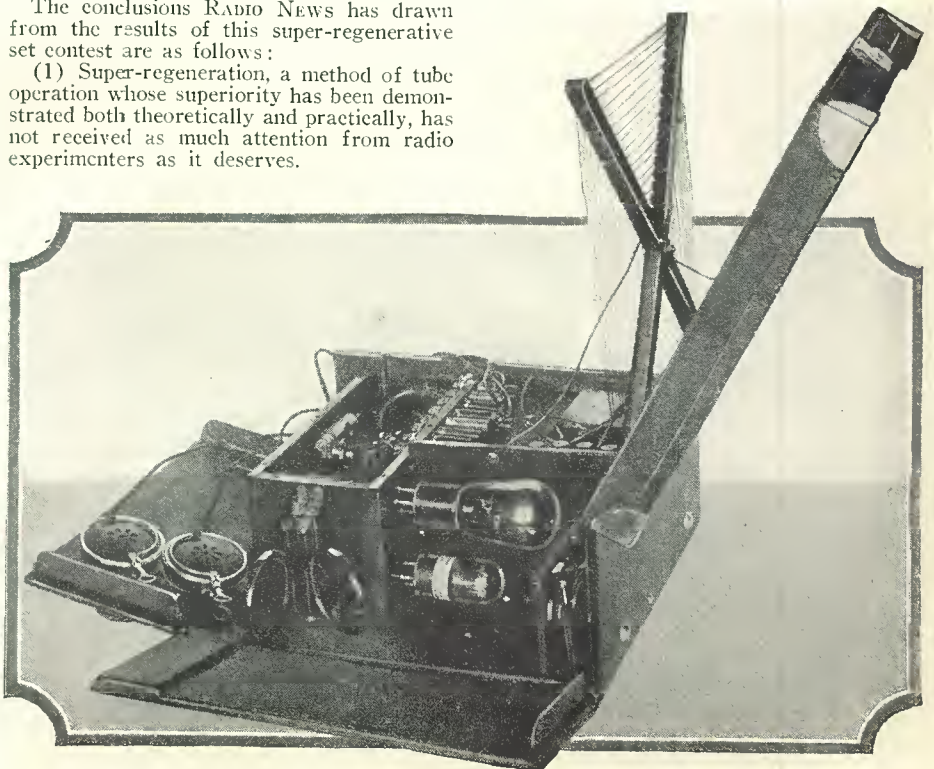

The side view of the super-regenerative receiver; the loop antenna folds into the lid. Notice the French tubes.

Experiments with Methods of Detection

An Analysis of the Respective Merits of Plate-Circuit and Grid-Circuit Rectification

By L. W. HATRY

THERE are two ways in which to connect a vacuum tube for detection, as indicated in Figs. 1 and 2. Fig. 1 shows the connection which produces what is called "plate-circuit rectification"; and Fig. 2 is the familiar "grid-leak-and-condenser" arrangement, which operates the tube in the method called "grid-circuit rectification".

An explanation of plate-circuit rectification will be clear in conjunction with Fig. 3. The curve shown is known as the grid-voltage-plate-current curve. The grid voltage (E_g) is plotted horizontally, the plate current (I_p) vertically. It is noticeable that increasing positive grid-voltage increases the plate current, and increasing negative voltage decreases it. Both ends of the curve flatten out; which shows that greater E_g , positive or negative, will have little or no effect upon the plate current. Upon these bends we depend for rectification, the effect of which is necessary to produce detection. By adjusting the grid-voltage until the tube in use operates approximately at point A (*i. e.*, with the "C" battery of biasing voltage suitably negative), an impressed R.F. voltage will vary the operating grid-voltage between points in the E_g - I_p curve equidistant on either side of A. The shape of the curve is such that these points on either side of A will not have equal effects upon the plate current. The negative side will have a small effect upon the plate current, and the positive side will have one relatively larger. Fig. 3 shows this well.

(I_g) plotted vertically. The result is a curve of the general shape of the lower end of the curve in Fig. 3. The rectifying action depends upon the same inequality of the effects of the alternations of the R.F. (alternating) current; the difference lying in the fact that it is all occurring in the grid circuit.

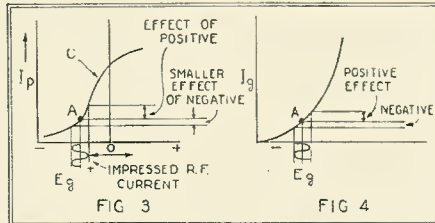

Figs. 3 and 4 are curves illustrating the actions in the circuits of Figs. 1 and 2, respectively.

If it is of the right size, the grid leak serves to bias the grid at the point A in Fig. 4. The grid-current through the leak causes across it a voltage drop which produces the biasing potential; this generally is somewhat negative in order to hit the most acute and useful point of the curve (the point indicated as A). Since the positive half of the R.F. achieves the greater effect, the result is an average increase of grid-current. The increase in grid-current from the incoming R.F. serves to increase the current-flow through the leak. Following the usual law expressed by the formula voltage drop equals product of current and resistance (or $E=RI$), the voltage drop through the leak is increased, and the negative bias on the grid likewise is increased. As negative E_g reduces I_p , this is why grid-rectification results in signal variation of I_p by reduction.

The rectified current through the leak is varied at the frequency of modulation of the carrier; *i. e.*, usually at an A.F. rate. With rectification occurring in the grid circuit, the amplification factor of the tube is utilized, with a result similar to amplification; thus causing the grid condenser-grid leak schemes to be the more sensitive method of detection.

Thus we see the differences between Figs. 1 and 2 to be: first, grid-circuit rectification in the latter, with some amplification; second, the amplification obtained is greater if the "mu", or amplification factor, of the detector tube is as high as practicable. So we understand why a high-mu tube often is recommended for the detector. (The ordinary tube (201A or 199) has a "mu" of 7 to 9; whereas a good high-mu tube has a mu of 25 to 30, and thus affords the greater step-

up.) Third, whereas Fig. 1 requires tube operation at A on the E_g - I_p curve of Fig. 3, Fig. 2 is not so critical as to the I_p curve; and the best operation is to be expected if we hit about the center, or point C, of Fig. 3 for our fixed level.

SUPPLEMENTING THE LEAK

From what has been said of the functions of the grid-leak, it becomes obvious that a division of them possibly might be advantageous. For instance, the size of grid-leak for best sensitivity may be different from that required to place the right bias upon the grid, and different again from the resistance for best A.F. functioning to obtain best quality. The separation of the drain and the biasing functions of the leak may be facilitated by the use of a potentiometer, connected as in Fig. 5. For any size of leak the potentiometer can be adjusted to a point to give the bias which proves best according to the volume of signal; and the leak resistance can be then chosen to give other performance separable from bias.

The connection in Fig. 5A is preferable to that in 5B, because the by-pass condenser C of 5B is not necessary, and so that much expense is avoided. I have found the potentiometer scheme very useful sometimes, although with some tubes one value of resistance will unite leak functions admirably. At any rate, Fig. 5 is worth experiment by any-

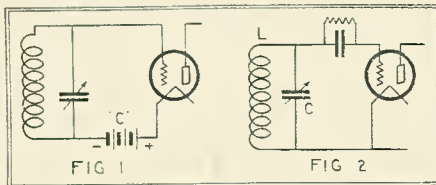
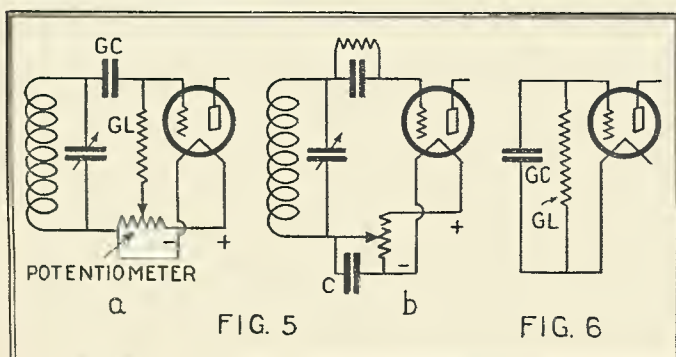

Fig. 1 illustrates plate-circuit rectification; and Fig. 2 the more familiar grid-condenser-and-leak method.

Thus the effect of the negative half will be largely suppressed and that of the positive half will dominate; and the R.F. control-voltage results unidirectionally; it seems to be rectified. It is important to remember that the R.F. current upon the grid is alternating, even though the average result in the plate circuit is as though the signal were pulsatingly unidirectionally.

GRID-CONDENSER-AND-LEAK DETECTION

We also need illustrations to assist in explaining the operation of Fig. 2. In Fig. 4 is a curve with the grid-voltage (E_g) again plotted horizontally, and the grid-current



In Figs. 5a and 5b are shown two methods of utilizing a potentiometer to obtain the proper grid bias. The method of 5a is better than the other. Fig. 6 is similar to Fig. 2, with the inductance, L, and the condenser, C, left out; the result being an A.F. impedance.

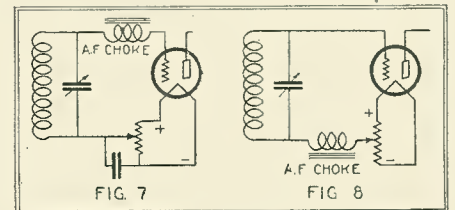

Two circuits in which the grid leak and condenser are replaced by an A.F. choke coil.

one who depends upon one or two tubes in his receiver and wants to get the best out of them; and because one always learns something by experiment.

DISTORTION WITH DETECTION

Both methods of detection are accompanied by a certain amount of distortion. One form of distortion is laid strictly at the door of the method of Fig. 2, and is due to the frequency-characteristic of the grid condenser. There is an explanation of this distortion which is so usual that it may be considered conventional. In experimenting to improve detector faithfulness I gradually forced myself to about face; with the result that another and contradictory explanation seems to me to be more logical. Possibly a compromise between the two would be nearer accuracy, but both will be given, the more usual explanation second.

Since the tuned circuit LC of Fig. 2 need not exist (from an A.F. viewpoint) it may be ignored and the circuit redrawn as in Fig. 6. The result is an A. F. impedance, consisting of the grid condenser and grid leak, which supplies the control voltage to the grid—or, otherwise stated, upon which the tube input is a load. As usual, it seems desirable that the load impedance be greater than the output impedance from which it is supplied. Largely on the negative half of

(Continued on page 268)

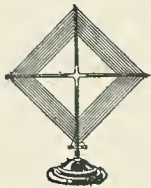

Radio's Will-O'-The-Wisp

A Resume of "Static-Eliminator" Patents

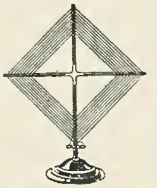

By S. R. WINTERS

INVENTIVE means for minimizing static in radio reception are embodied in approximately a hundred United States patents, granted up to the present. These contrivances, so-called "static eliminators," vary in character and magnitude from improvised violin strings, which are unresponsive to atmospheric disturbances, to apparatus resembling a miniature cannon and which is so cumbersome as to require a motor truck for its transportation.

Since the first patent relating to a separation of atmospheric disturbances from radio signals was granted to Dr. Reginald A. Fessenden, a quarter of a century ago, inventive minds have sought a device that would com-

pletely eliminate static. Their efforts have been only partially successful; many instruments and methods reduce this form of interference, but no device has yet been designed that will completely reject or suppress static. This fact was recently emphasized in an editorial written by Hugo Gernsback, editor of RADIO NEWS, in which it was stated that an electrical company had made the gesture of offering a bounty of \$1,000,000 for a simple, practical, and inexpensive static eliminator.

Under the latter general method of procedure, interest attaches to an invention of Dr. Greenleaf W. Pickard of Boston, whose contrivance (see Fig. 1) challenges our imagination and invites, as well, serious attention because of its possibilities. Bearing similarity to violin strings, a reflection grating (RG) is employed, composed of wood or metal slats, these being in tune or harmony with the air-wave frequency of the particular radio communication to be received. These improvised violin strings are supposed to select certain tones; and the notes of static, being of extremely low frequency, do not set the violin strings in vibration and thus atmospheric disturbances are segregated from radio signals. "Interference Preventer" is the name chosen by the inventor for this device and, in handling sound waves, he compares its functioning to that of an optical method. The electric ether waves, as a preliminary to their segregation from static, are transformed into short air-waves. In the final analysis, this tuned grating of wood or metal slats concentrates the desired air-waves in a definite direction while the interfering air-waves are destroyed or dispersed. (U. S. Patent No. 1,460,439.)

as large particles exert pressure on the mesh and yet do not gain entrance through the sieve. The signal sifter consists of a vacuum tube, an arc circuit, and an amplitude-limiting circuit. In functioning, it is analogous to the sieve; in that small-amplitude current passes through the sifter without much potential difference between the terminals of the sifter; while large-amplitude current cannot pass through the sifter and the potential difference between the terminals is comparatively large. (U. S. Patent 1,485,485.)

BALANCING OUT THE STATIC

Illustrative of the principle of reducing static by means of a combination of balanced and selective circuits, is an invention of F. A. Hart of New York City. In a manner, he

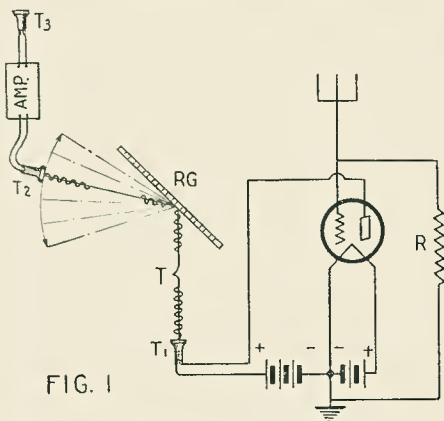

Dr. Pickard's "Interference Preventer," RG, a metal or wooden refraction grating; T1, T2 and T3, telephone receivers, and T, the static-free wave.

WINNOWING THE SIGNALS

Equally commanding in interest is the so-called "Signal Sifter," conceived by Henry G. Cordes of Bremerton, Washington. In operation, it is comparable to a sieve which admits the passage of small particles without the exertion of pressure on the mesh; where-

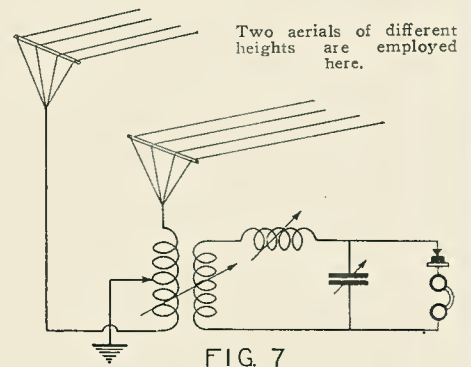

provides two well-defined paths for the respective travels of static and radio signals. One of these paths consists of an inductance and a capacity, and the other of a capacity and two inductances; these being so arranged that one of the two inductances shall be placed in parallel with a portion of the other variable at will. Non-inductive resistances are employed for eliminating the undesired wavelengths.

One of the most practical methods for reducing interference caused by atmospheric disturbances in broadcast reception is an invention of Roy A. Weagant. Approximately a dozen patents have been issued covering this system and, since it has already been exploited widely, suffice it to say that it consists of a plurality of coil or loop antennas, separated by a distance equal to one-half a wavelength (See Fig. 2). In this double-loop system the connections to the antennas are electrically shielded from signal waves and static and the tuning means for the antennas are located in these connections at points between the shielding and antennas. (U. S. Patent No. 1,336,398.)

R. H. Ranger likewise, has been granted a patent on a double-loop antenna system for reducing static interference. This device differs in that the receiving antennas have different characteristics with respect to their distance from the transmitting station, directional properties, tuning, etc. For example, the coupling between the two receiving systems is not such as to cause the incoming signals to combine, signals from only one loop reaching the detector. Signals from the other antenna are used for the purpose of rendering the indicating means unresponsive under certain conditions and responsive under dissimilar circumstances. See Fig. 3; this shows a schematic diagram of the arrangement. (U. S. Patent 1,616,923.)

A STATIC CUSHION

Under the assumption that atmospheric disturbances are impulses of extremely low

pletely eliminate static. Their efforts have been only partially successful; many instruments and methods reduce this form of interference, but no device has yet been designed that will completely reject or suppress static. This fact was recently emphasized in an editorial written by Hugo Gernsback, editor of RADIO NEWS, in which it was stated that an electrical company had made the gesture of offering a bounty of \$1,000,000 for a simple, practical, and inexpensive static eliminator.

Inventors, until recently, have largely addressed their efforts to designing contrivances to divorce atmospheric disturbances and similar interference from radiotelegraph signals. These inventions have accomplished

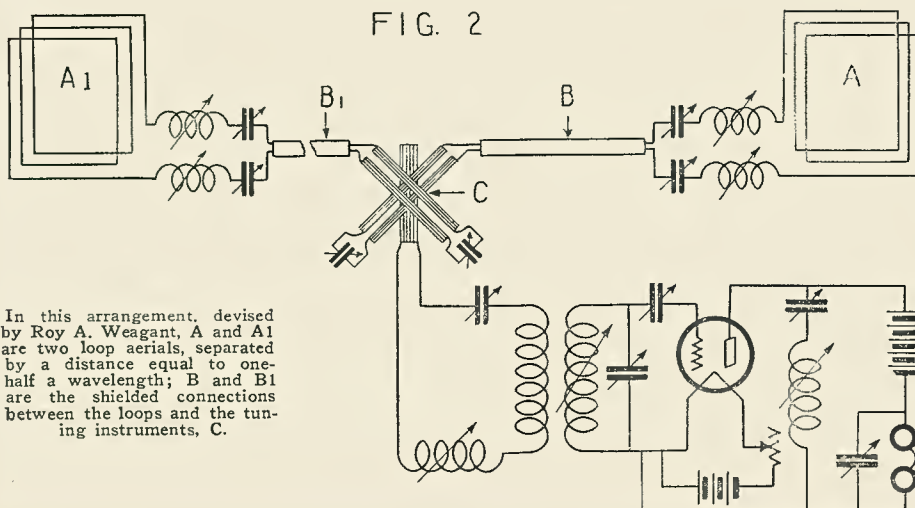

In this arrangement, devised by Roy A. Weagant, A and A1 are two loop aerials, separated by a distance equal to one-half a wavelength; B and B1 are the shielded connections between the loops and the tuning instruments, C.

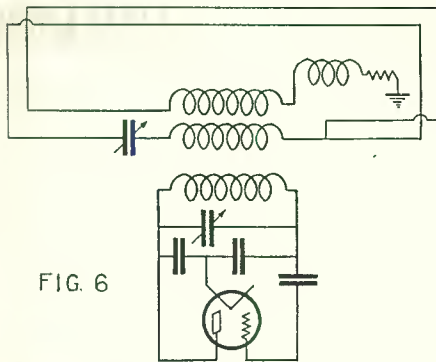

FIG. 6

In this scheme, credited to J. A. Proctor, a combination of open and closed antennas is used.

frequency, the Signal Corps of the Army has introduced a "guard tube" in the so-called resonance-wave coil. The "guard tube" is supposed to drain off static. It operates under the theory that, when an impulse of atmospheric strikes the antenna, it produces the effect of abruptly injecting a high voltage on the left end of the resonance-wave coil. The voltage is absorbed by the latter, and unless it is interrupted in its course, the coil will oscillate at its own wavelength. Use of the "guard tube" in the circuit of the resonance-wave coil averts this oscillation and static impulses are relayed to the ground (See Fig. 4). Radio signals are drained off as well; but, by grounding the "guard tube" according to instructions, the connection will function as a solid ground on all wavelengths except one—the one desired for receiving signals. (U. S. Patent 1,476,691.)

Austen M. Curtis of Brooklyn, New York, uses a wave filter constituted of resistance elements and elements of one kind of reactance and substantially free from reactance of the other kind. For example, the filter may be made of resistance and capacity elements and thus virtually free from inductance; or it may be made of resistance and inductance elements and practically free from capacity. Static impulses impressed on this filter are largely dissipated in producing natural oscillations of such high frequencies that the filter will not transmit these oscillations. (U. S. Patent 1,371,228.)

Dr. E. F. W. Alexanderson declares, "A fundamental rule must be the basis of any device used for decreasing the effect of static disturbances. Any discrimination between waves of the same frequency originating from static and from the signal must be based on some difference in character between these two waves." In accordance with this enunciated principle, he has devised a static reducer. It makes use of a tuned circuit of lower than radio frequency, but above audibility, for effecting the prolongation of the time during which the signal and disturbance may be compared.

UNDERGROUND ANTENNA

As generally known, Dr. J. Harris Rogers, the distinguished scientist of Hyattsville, Maryland, buries the antenna as a method of eliminating the disturbing effects of static. His invention, which has been patented, is a signaling system comprising an antenna extending horizontally, substantially parallel to the earth, with radio instruments connected to one end of the antenna and a ground connection at the other end. A metallic screen is buried beneath the surface of the earth to enclose the antenna, the screen being insulated from the latter.

Lloyd Espenschied of Hollis, New York, has been granted a patent which embraces an invention whereby the receiving set is connected to an auxiliary circuit in addition to the receiving antenna. This auxiliary cir-

cuit simulates the antenna proper, as regards natural oscillations. Means are provided for exciting natural oscillations in the auxiliary circuit simultaneously with the excitation of natural oscillations in the receiving antenna by transient disturbances. See Fig. 5. (U. S. Patent 1,362,612.)

What may seem a corrupted designation or function of the grid leak in our radio receiving sets is an invention of Walter W. Massie of Providence, Rhode Island. He combines a condenser and a "leak coil" as an invitation to oscillatory currents to effect their escape to the ground without visiting the receiving set. Thus static passes through this "leak coil," by the capacity produced by several turns of wire.

J. A. Proctor of Lexington, Massachusetts, in reducing atmospheric disturbances, uses a closed antenna associated with an open antenna. The combined effects of loop action and an open antenna, in proper phase relation, are brought to bear on the receiving set. Such a system, it is claimed, has great efficiency in eliminating the effect of static and interference from other broadcasting stations. Moreover, it serves to improve the directional effects of radio reception. This system comprises an aerial of the closed, functionally-grounded loop-circuit type, and a second aerial of the open, functionally-grounded cir-

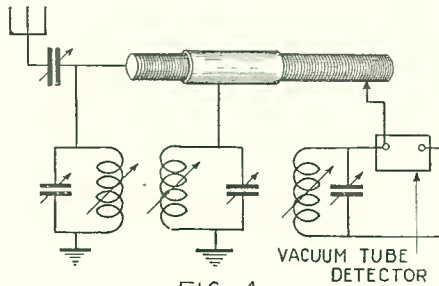

FIG. 4

The "Guard Coil," shown above, is supposed to drain off static from the resonance coil. This expedient was first used by the Signal Corps of the U. S. Army.

cuit type including a loop arranged virtually as a whole in electrostatic and electromagnetic relation to said closed loop circuit substantially as a whole. See Fig. 6 (U. S. Patent 1,484,189.)

Frank Conrad has devised a radio receiving set in combination with two antennas of different heights (Fig. 7). The receiving circuit is differentially connected to the plurality of antennas and susceptible to adjustment, so that the energy received on one an-

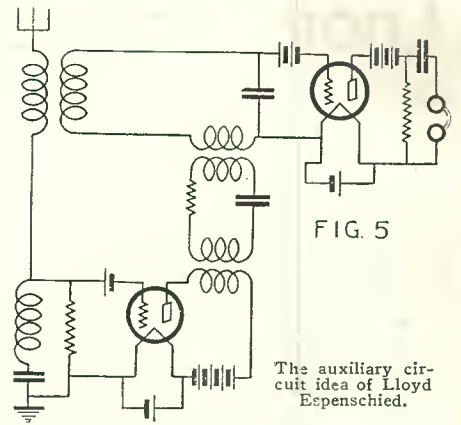

FIG. 5

The auxiliary circuit idea of Lloyd Espenschied.

tenna from a static impulse cancels the energy received upon the other antenna, and so that similar cancellation is not effected with incoming transmitted impulses. (U. S. Patent 1,513,223.)

Michael I. Pupin and E. H. Armstrong of New York City have introduced resistances in a receiving antenna for diminishing the effects of static and other disturbing factors. This system is likely to diminish the signal strength unless the resistances are properly placed. Their invention serves as a guide for inserting these resistances to avoid the latter undesirable effect. (U. S. Patent 1,336,370.)

Another invention of Greenleaf W. Pickard provides a system whereby it is possible so to adjust the phase relations of the currents arriving at the secondary, that interference or static arriving from any particular direction is cancelled out in the primary. (U. S. Patent 956,165.)

Peter L. Jensen of San Francisco has devised a radio receiving circuit tuned to receive an undamped or very slightly damped wave of definite length; the exactness of tuning being in practice about one per cent. (U. S. Patent 1,106,874.)

David G. McCaa of Lancaster, Pennsylvania, has a receiving system whereby the received energies are divided between two reactive paths withholding from the signal-translating path the effects of the signal representing or desired oscillations. (U. S. Patent 1,522,136.)

C. W. Rice, of Schenectady, New York, in reducing static, uses a plurality of electron-discharge relays or amplifiers, preferably of the high-vacuum or plotron type;

(Continued on page 270)

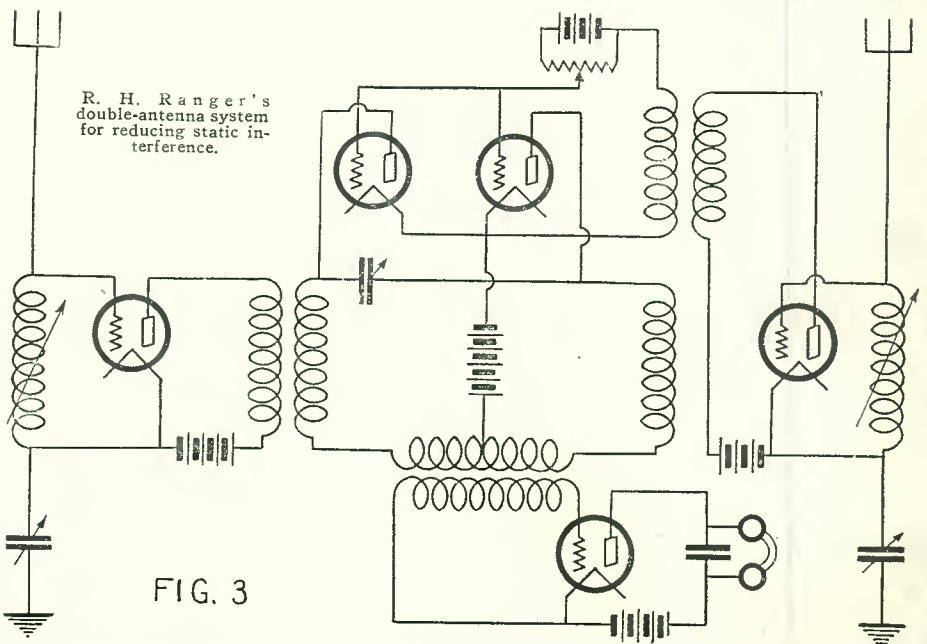

FIG. 3

R. H. Ranger's double-antenna system for reducing static interference.

Loop Operation of the Strobodyne Receiver

Necessary Details of Modifications for Use of Loop, Power Tubes, &c.

By LUCIEN CHRÉTIEN

AMERICAN ADAPTATION BY
ROBERT E. LACAULT

THE STROBODYNE Receiver, which embodies a new and remarkable system of frequency-changing, has been described at length in the July and August issues of RADIO NEWS; the latter of which contained complete structural details and specifications for the construction of an eight-tube set of this type, operating on either an outdoor or an indoor aerial.

In this article Mr. Lacault, who constructed the set previously mentioned, the first of its type in America, explains how it may be altered for use with a loop as well; and shows also the connections of the set if the loop only is to be used, with or without a stage of R. F. amplification. In the latter form the Strobodyne is excellently adapted to use as a portable.

Instructions for the use of a power tube in the second audio stage, and for the connection of the Strobodyne to a source of socket-power current supply, are also given here.

In RADIO NEWS for October will appear an article with further practical advice to constructors of the Strobodyne on its construction and operation. Inquiries and reports from any of our readers on their work with this circuit will be welcomed.—EDITOR.

THE Strobodyne receiver, described in the August issue of RADIO NEWS, was designed for operation on an outside antenna. As a rule, an extended wire (whether outdoor or indoor) is preferable to a loop, because it picks up more energy and this, in turn, results in louder signals. However, there are some cases when a loop is preferable; such as, for instance, when two stations sending on the same or almost the same wavelength interfere with each other. If they are not in the same direction from the receiver, one of them may be eliminated by turning the loop at right angles to it.

The only difficulty encountered, when using a loop on a set tuned by a multiple condenser, is that it is very difficult to make the inductance of the loop of exactly the same value as that of the other coils in the set. The distributed capacity is as a rule different and this results in different tuning curves. In order to make up for the difference it is necessary to use an extra compensating capacity across a loop, which should be designed

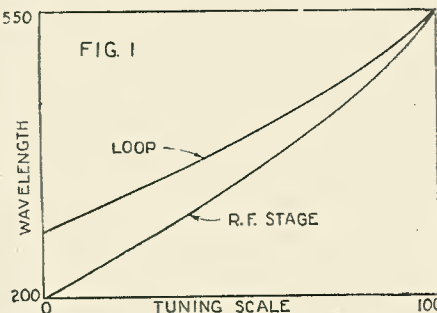

These two curves show how the tuning of the Strobodyne is off at the lower wavelengths without a second shunt condenser.

to tune on the same wavelength as the coils in the set at zero setting of the condenser dials. This compensating capacity may be increased to make up for the difference between the natural frequency of the loop circuit and that of the other tuned stage.

If the loop circuit were tuned with the same maximum capacity across it as the other coils in the set, at the lower wavelengths the tuning of the loop circuit would be off; and the signals could not be tuned in, or else would be heard but faintly. Fig. 1 shows how the tuning curves fail to coincide; and Fig. 1A how they may be made to do so with the aid of a second shunt condenser.

When adapting the Strobodyne in this fashion to work on a loop, it may be necessary to experiment with the number of turns of wire in use on the loop aerial. Eleven turns of the fourteen with which the loop is supplied with should be the correct number in most cases; but, if you find it impossible to receive a short-wave station (say one on 230 meters) with the compensating condenser set at zero, then merely solder an ordinary pin to the wire leading to

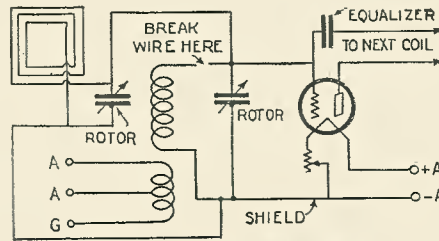

FIG. 2

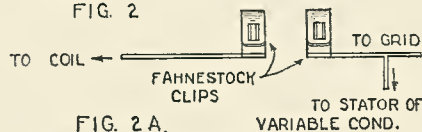

FIG. 2A.

Fig. 2 shows the circuit diagram of the loop antenna for the Strobodyne; and Fig. 2A, how the connections can be easily made.

the loop from the condenser stator. Push this pin first through the 12th turn, then through the 10th and again through the 11th, and see which connection works best. Once the correct number of turns has been determined, this loose wire may be soldered permanently in place. To make this joint it will be necessary, of course, to remove some of the insulation from the loop wire.

In adapting the Strobodyne for loop operation, a Bodine loop, as shown in the picture, was used because of its desirable characteristics. Some turns were removed, and an auxiliary or compensating condenser was employed to make up for the difference in tuning on the higher wavelengths. The loop should have eleven turns, and the condenser a capacity of .00025 mf. Of course this extra condenser has to be reset for each station tuned in, making a total of three controls to tune; but, since it is not critical, this does not prevent bringing in distant stations.

CONNECTIONS FOR LOOP OPERATION

To adapt for loop operation the set described in the August issue of RADIO NEWS, it is necessary merely to break the wire connecting the top end of the antenna-coil sec-

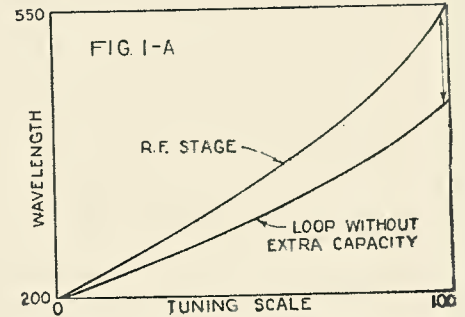

When a second shunt condenser is added, as in Fig. 2, the tuning curves appear as in the above graph.

ondary to the lead which runs from the stator of the variable condenser to the grid ter-

Editor, RADIO NEWS:

In addition to the stations I mentioned before (in my letter published on page 135 of RADIO NEWS for August) I have received several others; though, due to the fact that I have never been a "DX hound," I have not added as many as I might.

The following are a few that I received last night and today: WABC, WRNY, WICC, WEAJ, WTIC, WOR, WJZ, WPG, WHN, WMCA, WBZ (daytime), WGCP and WWRL; and here are the further ones—KDKA, WTAM, WLW, WSAI and KMOX. These were all heard on a W. E. cone in a medium-sized room, so loud that conversation at the same time was difficult, and with a three-foot loop only as pickup. The only change from the description given in my first letter is the addition of a third stage of intermediate R.F. amplification. The set seems to be much more sensitive to weak signals than the regular super. It lacks the reactive effect of the oscillator upon the loop tuning and that "see-saw" effect that is typical of many supers.

Our local station WDRC is only about two miles from me, and I don't think that this circuit is as stable as the standard when receiving very near to WDKC's wavelength. There is a great tendency either to unbalance or stop oscillating, or else paralyze.

Another thing that is very noticeable is the clear tone that this set gives. My audio end is the same as I used with the standard super; and the tone of the Strobodyne is much more natural, especially on the weaker signals. I have not yet tried out the stage of R. F. ahead of the frequency-changer, because I want to get well acquainted with all points before getting into new ones. I have not yet put a stage of R. F. ahead of any super and gained the results that might be expected. You gain one way and lose another.

If you wish to give me the specifications of the coil P-S-T in Fig. 6 (page 29, July RADIO NEWS) I will make it up and try it. I will be glad to hear from you again and to be of assistance if possible.

THOMAS I. BURWELL,

565 Quinpiac Ave., New Haven, Conn.

(*Mr. Burwell's set, from which such excellent results have been obtained, was built solely from the theoretical diagram of the frequency-changer published in July RADIO NEWS, and without the aid of the specifications for the complete receiver which appear in the August issue and (for loop adaptation) on another page of this magazine.

After seeing the design of the Strobodyne in RADIO NEWS for August, Mr. Burwell adds:

"I have added the stage of R. F. ahead of the Strobodyne, but continue to use the loop as signal collector. I used three dials, and find the R. F. stage gives much better selectivity and more sensitiveness. Following is log of reception last night on my loud speaker: WIP, WEAJ, WJZ, WOR, WGY, WMCA, WDWM, WGCS, WJAX, WSM, WBEZ, WPCH, WGCP, WPG, WAAT, WHAP. There was considerable static and I had to change the neutralizer as I came on the shorter wavelengths; or the R. F. would oscillate."—EDITOR.)

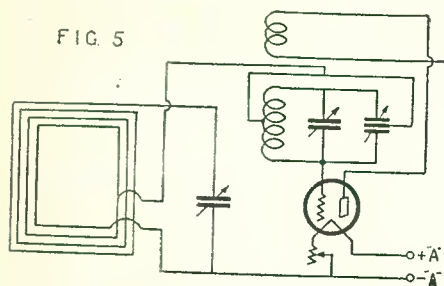

The above circuit diagram shows how the loop antenna is connected if the stage of R. F. amplification is omitted.

minimal on the socket. One end of the loop is then connected to the condenser lead and the other to the shield, which is part of the "A—" circuit. Fig. 2 shows the connection. The simplest switching arrangement to use is made of two Fahnestock clips fastened or soldered to the ends of the wire, as shown in Fig. 2A. The clips make it easy to connect the loop to the condenser and, if the regular antenna is again to be used, it is merely necessary to connect the two clips together with a piece of wire, thus connecting the secondary coil to the condenser. The compensating condenser should be mounted on the loop base, because there is no practical and simple way to install it in the set. If the set owner prefers to do so, it may be mounted on a small bakelite panel fastened upon a small baseboard; or else the bakelite panel may be used as the cover of a small box which keeps dust out of the condenser. Of course there are several arrangements which may be used, but we leave to the experimenters this small detail to decide for themselves.

READJUSTMENTS

It may be found that the radio-frequency tube oscillates when a loop is used; while it is stable when the aerial and ground are connected to the set. This is due to the characteristics of the latter antenna system, which reacts on the secondary and prevents it from oscillating. Since the aerial is not used with the loop, this effect does not take place and the circuit oscillates more easily. In such cases it is necessary to readjust the equalizer mounted on the R.F. tube socket to neutralize the circuit more accurately. The circuit may be neutralized accurately by plugging into the R.F. socket a tube similar to the one used in the set but having a burned-out filament. If the tube is exactly of the same type the screw on the equalizer should be turned until the signal being received disappears entirely or is weakest. Then place the good tube in the socket and the stage of R.F. should not oscillate at any point of the scale. When doing this, set the R.F. rheostat almost in full and tune on a station coming in at about 30 to 40 on the dial. If no burned-out tube similar to the one used is at hand, disconnect the plus "A" wire from the socket, so as to prevent the tube from lighting and adjust the equalizer as explained above.

Remember that when using a loop it is necessary to turn it so that the plane of the turns points toward the station to be received. This is not as a rule critical for nearby stations but on weak signals the effect is very noticeable. If it is desired to build the set for loop operation exclusively, the following changes should be made in its design.

Leave out the tuning coil, which of course is not needed, and use a .0005-mf. condenser instead of a .00035-mf. in the rear shield. The loop is connected directly to the stator and rotor of this condenser as shown in Fig. 3. In order to compensate for slight unavoidable variations, a small midget condenser, about 32-mmf. (9 plates), should be connected in parallel with the left forward variable condenser. It will be found the midget condenser should be set at zero when

THE STROBODYNE CIRCUIT

BY arrangement with Lucien Chrétien, the inventor, all articles on this circuit for this country have been copyrighted by RADIO NEWS in the United States, and must not be republished without permission of the publishers.—EDITOR.

tuning to the longer wavelengths, and increased for the shorter waves.

The loop used in this calibration was wound with fourteen turns. In order to bring the readings alike one turn should be removed, the extra wire cut out and the end

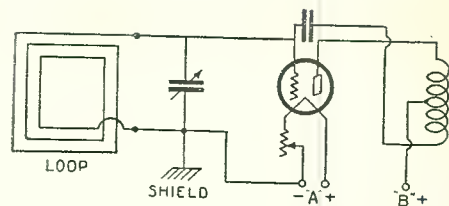

FIG. 3

Showing how the loop condenser is connected in the input circuit of the Strobodyne set when built for loop use only.

re-soldered to the lug. If it is desired to build such a loop the dimensions are given in Fig. 4. Care should be taken to build the loop exactly as shown; otherwise the calibration will be different. Wire especially designed for loop winding should be used because this wire does not stretch after it is once wound.

ELIMINATING THE R.F. STAGE

It is possible to simplify the receiver by doing away with the stage of radio frequency; though at the cost of some sensitivity, because the R.F. stage helps to boost weak signals. In such case, a loop designed to tune over the entire broadcasting band with a .00035-mf. condenser is connected directly across the condenser and a tap taken at about the first quarter of the winding (counting from the end connected to the rotor). This tap goes directly to the center tap of the tapped auto-couple coil as shown in Fig. 5.

This simplified Strobodyne design is particularly adapted to a portable set; but, to get the utmost in efficiency, the R.F. stage should be employed.

USING A.C. ON THE POWER TUBE

Another improvement, which may be added to the Strobodyne receiver, is the use of alternating current on the power-tube filament. There are now on the market several power transformers, compacts, and "B" socket-power units equipped with a special 5-volt winding to light the filament of the power tube with alternating current. If such a power supply is used, it is necessary merely to disconnect the wires from the filament terminal on the second audio tube socket, and to connect these terminals to two extra binding posts by means of two rubber-covered leads twisted together.

The "C—40v" binding post should be connected to the "A—" post directly with a piece of wire, and the center tap of the filament winding on the power transformer should also connect to the "A—" post through a 2000-ohm fixed resistor. This resistor provides the proper "C" voltage on the grid of the 171-type tube. If a 210-type power tube is used, a 1000-ohm resistor should be used instead. Fig. 6 shows the connections of a typical B socket-power circuit.

(Continued on page 258)

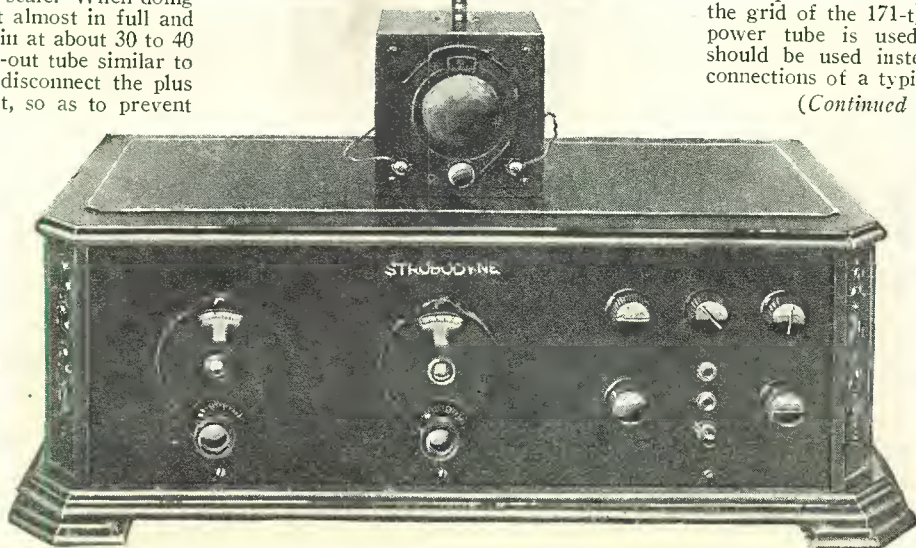
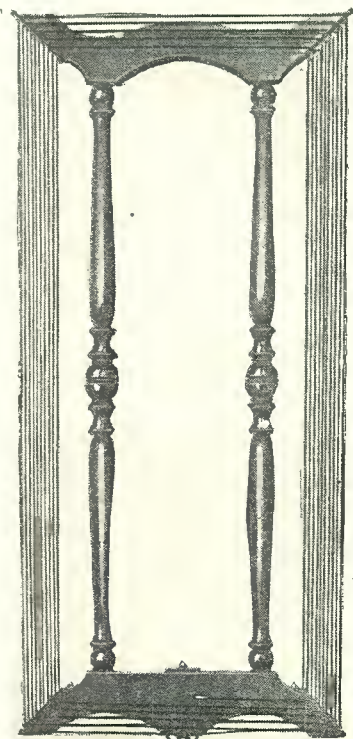

At the left is shown the Strobodyne receiver, equipped with the variable condenser and loop antenna. The variable condenser, which is shunted across the loop, is contained in the wooden box, in the top of which is fixed the rod on which the loop antenna revolves. The loop and condenser are connected as shown in the circuit diagrams in Figs. 2 and 3. By using a box for housing the condenser as illustrated, a very neat appearance can be given to the entire equipment.



The Gomez Super-Reflex Receiver*

An Easily Constructed Three-Tube Loop Set with Great Sensitivity and Range



By A. VAN A. SOMMERS

THE receiver described in the accompanying article is not at all difficult to construct, and its range and reproduction are remarkable when it is considered that only three tubes are employed. As a loop antenna is used, this set should appeal to a person living under conditions where interference from conflicting broadcast stations is bothersome. In New York City no difficulty was experienced in separating all the stations in the vicinity. We can recommend this receiver to those constructors who are looking for a set which will be interesting to build and operate and which will perform in a satisfactory manner.—Editor.

A GREAT deal has been said and written concerning super-regeneration and the application of this principle to various circuits, such as the superheterodyne, reflex and others. In fact so much has been written, and relatively so little accomplished in true performance, that many people laugh when the word "super-regeneration" is used. Yet many experimenters have been working with the super-regenerative principle while saying very little about it; and it is the result of such an experimenter's labors that we

present in this article. The circuit here described has been worked out by Señor Ignacio M. Gomez, of Buenos Aires; and its theory is explained here, with details for the construction with standard parts of a receiver embodying it.

The circuit shown in the accompanying diagram may not at first seem new or radical to the casual observer; but if the reader will study it more closely he will find several innovations. In the first place, the method of controlling regeneration is a new adaptation; as also the simultaneous tuning of the plate circuit of the first tube and the grid circuit of the second or detector tube.

REGENERATION CONTROL

The essential principle of the functioning of this circuit is the regeneration control of the first tube, V1. This part of the circuit is a development of a new system of radio-frequency neutralization which may be applied to any receiver of the regular type. This system gives very good results, not only for the apparatus that has been used in the present receiver, but for a set of any kind to which it is necessary to add another stage of radio-frequency amplification. However, as this necessitates additional controls, it is not recommended for ordinary purposes.

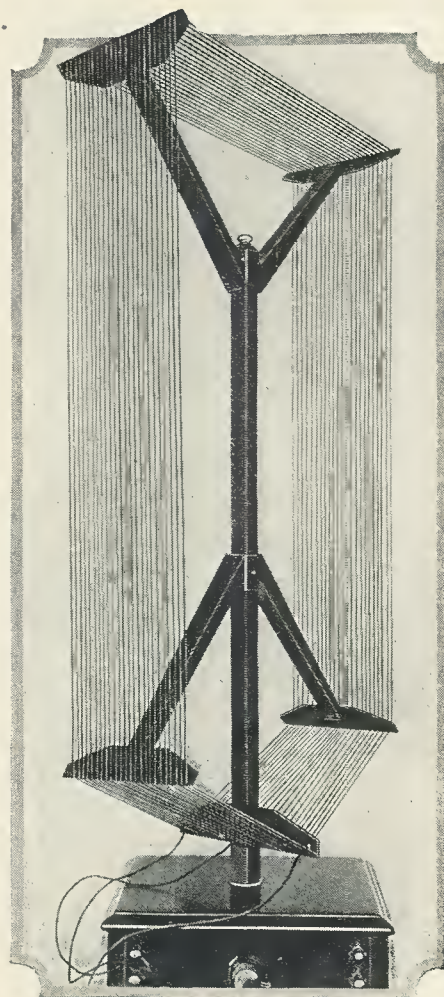

The specially-wound loop antenna, which is here shown in its socket on top of the cabinet.

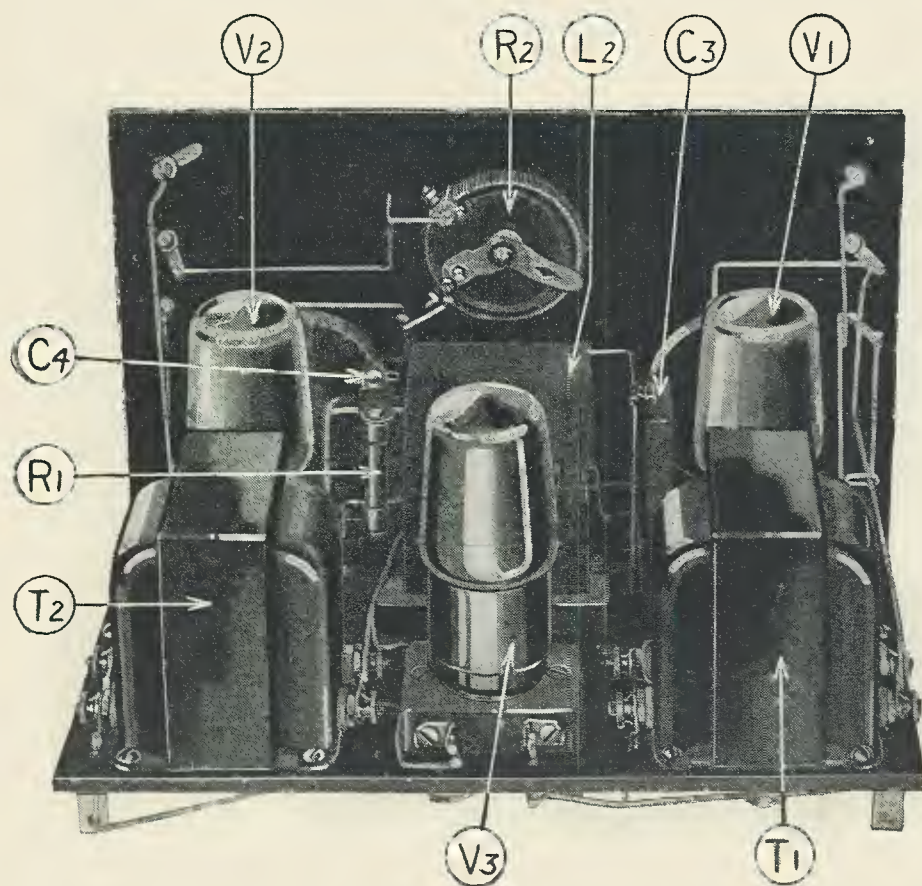

V1, V2 and V3, R.F., detector, and A.F. tubes respectively; L2, grid inductor; T1, T2, A.F. transformers; R1, grid leak; R2, rheostat; C3, plate condenser; and C4, grid condenser.

For this reason it was found of greater interest to experiment with obtaining more amplification and sensitivity without the addition of more tubes. To gain this point we started from the radio-frequency end of the circuit and tried all kinds of combinations to get amplification at both radio and audio frequencies in the same tube simultaneously.

Results at first were very discouraging, as we discovered all sorts of audio-frequency howls, making reception impossible. In order to stabilize the circuit it was necessary to separate the plate coil of the amplifier from the grid coil of the detector, using a choke coil and a coupling condenser.

The resulting circuit is quite stable in operation, in spite of the difficulty of having an apparent reflex circuit of only two tubes. All the difficulties were overcome by using the system of regeneration, which gives control, not only on the radio-frequency oscillations, but on the audio oscillations as well.

The inductance L1 (which is really the tapped loop antenna) works both as a grid coil and as a regeneration factor. The regeneration condenser C1 is a midget condenser of but 25 mmf. capacity and is used to control the regeneration of the radio frequency tube, producing also regeneration of audio frequencies, which increases the strength of the signals—one of the most important of

* Radio News Blueprint Article No. 30

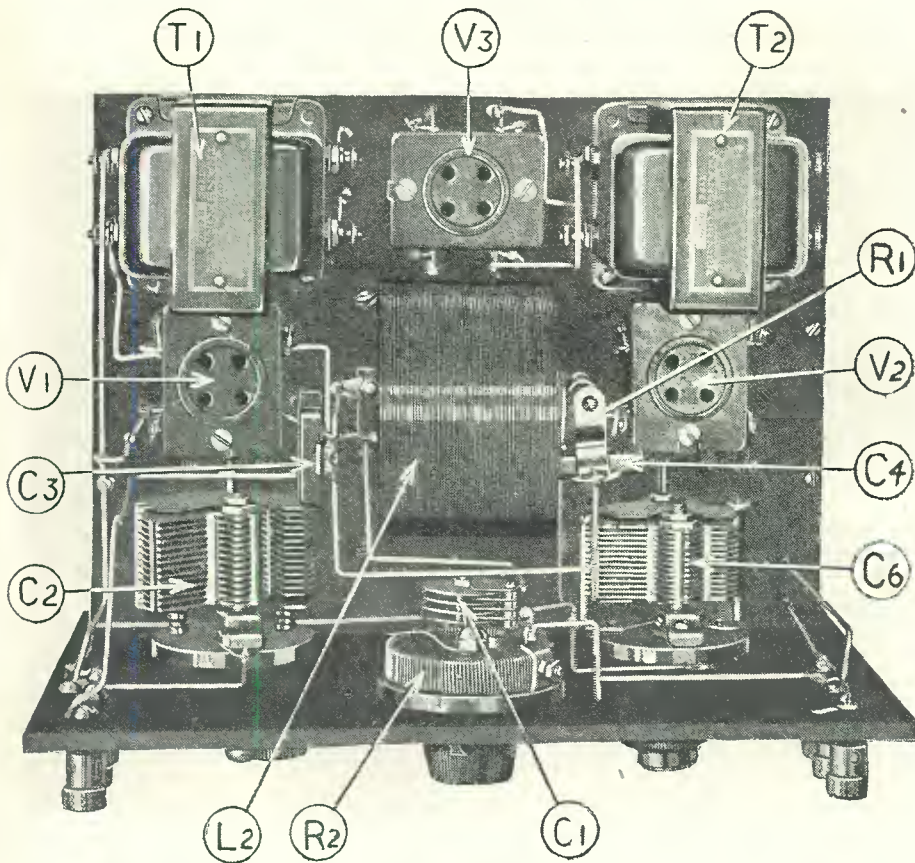

C1, midget variable condenser; C2 and C6, tuning condensers. The R.F. choke coil and the condenser, C5, are beneath the sub-panel.

the factors that contribute to the extraordinary volume obtainable with this receiver. The regeneration of audio frequencies gives a greater volume than would any audio amplifier. The amplification obtained by this new system is equivalent practically to that of two stages of A. F. amplification and has the disadvantage only of causing audio howls when regeneration is carried too far. For this reason the regeneration condenser C1 should be kept below the point of oscillation.

THEORY OF OPERATION

In order to allow the passage of the radio-frequency current, the 5-mmf. condenser, C5, is used in shunt with the secondary of the audio-frequency transformer T1. The radio-frequency current passes through the condenser C3 to the coil L2 of the detector grid circuit and, after having been rectified, the signal passes through the transformer T1 to the grid of the first tube V1 whose plate is connected in series with the radio-frequency choke coil RFC, whence it goes to the audio-frequency amplifier T2 and V3.

The energy picked up by one side of the loop goes to the grid of the first tube, the other half of the loop being used to neutralize the internal capacity of the tube, and to control the regenerative action of the latter. It might seem that this is an ordinary reflex circuit, but such is not the case. It is really a super-regenerator. The super-regeneration effect is obtained by the imposition of the super-audio oscillations, produced by the windings of the transformer, on the grid of the first tube.

The first tube really does three things. In the first place it amplifies the incoming frequency; secondly, it acts to a slight extent as a reflex audio amplifier; and, thirdly, it

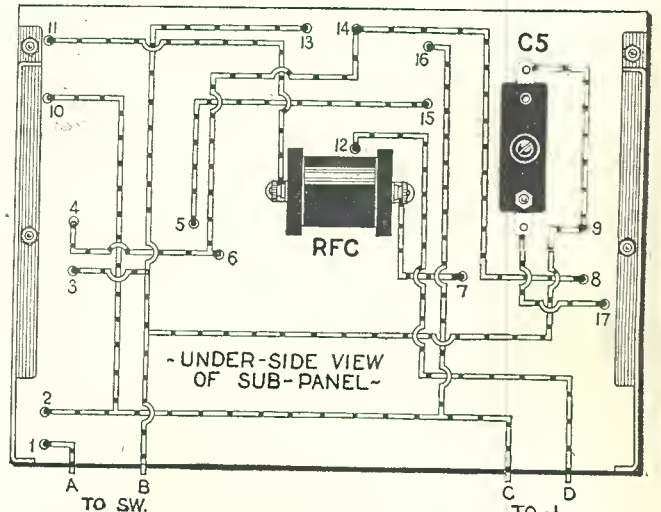
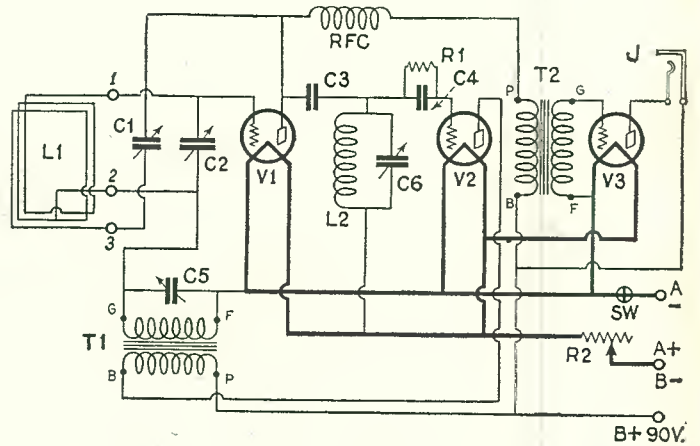
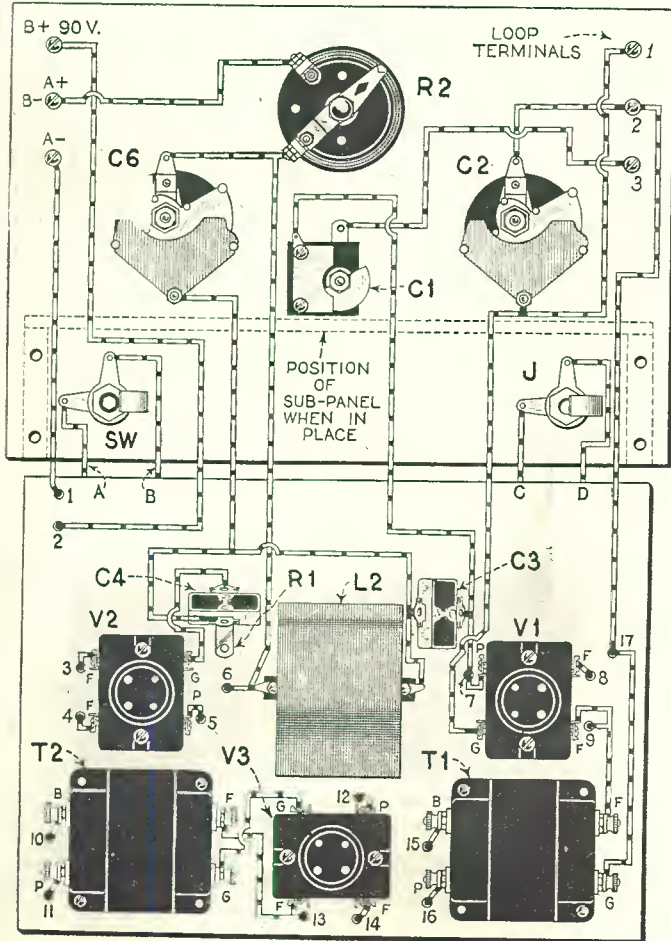

In the upper right corner is the schematic diagram of the Super-Reflex receiver. Below it is shown the wiring of the bottom of the sub-panel. At the left, the wiring diagram of the apparatus on the panel and sub-panel. The holes are numbered alike in both views of the sub-panel.

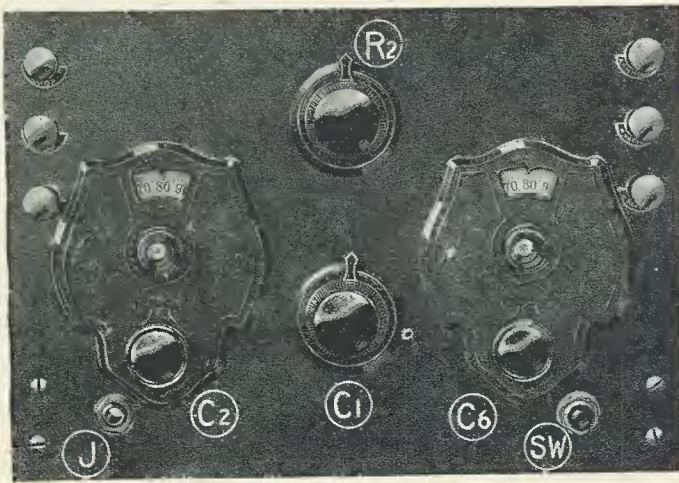

At the left is shown the front view of the panel of the Gomez super-reflex receiver. The binding posts at the upper left of the panel are for the loop connections; the middle one being connected to the center tap of the loop antenna, and the outer posts to the outside terminals of the loop. C1, C2 and C6 are the controls for the three variable condensers; R2 is the rheostat control; J, the jack in the output circuit; and SW, the filament switch. The three binding posts at the right are for connecting the "A" and "B" batteries to the receiver.

is an audio-frequency oscillator. It seems that the Rice system of neutralization is indicated here; but the Gomez circuit is distinctly different from Rice's.

The neutralizing condenser, when once set, need not be changed except on the longer wavelengths, variations being obtained by use of the impedance-coupling system between the radio-frequency tube and the detector.

CONSTRUCTION

The construction of the receiver is indeed simple. The sub-panel is attached to the front panel by means of two brackets, and the greater part of the apparatus is mounted on and beneath the sub-panel, simplifying the wiring and mounting.

After the two panels have been drilled, the several pieces of apparatus are screwed to

TESTS made with the super-reflex set described in this article were made in New York City. The two tuning condensers worked together, bringing in the local stations at the points on their respective dials shown below.

Station Call Letters	Dial Reading	Wavelength Meters
WNYC	98	535
WEAF	82	492
WJZ	76½	454
WOR	67½	422
WHN	61	395
WLWL	53	370
WAAM	44½	349
WABC	39½	326
WRNY	32½	309
WGL	26½	294
WGCP	21½	280
WWRL	14	268
WEBJ	11	256

Operating in a very unfavorable location, this three-tube receiver brought in these stations—on the loop—with remarkable clarity and excellent loud-speaker volume. In this respect it may be compared with the standard five-tube set which does not employ regeneration. The selectivity is that which may be expected with a single tuned input circuit and, in the ordinary location, should be found quite satisfactory.

them, as indicated on the constructional drawings elsewhere shown. The three vacuum-tube sockets are placed first and then

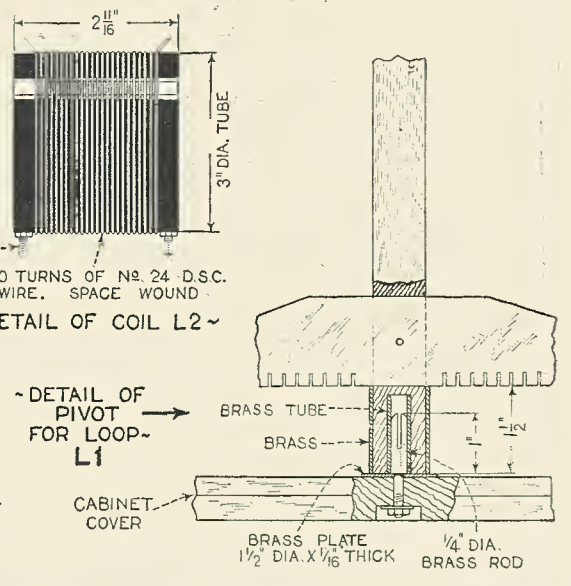
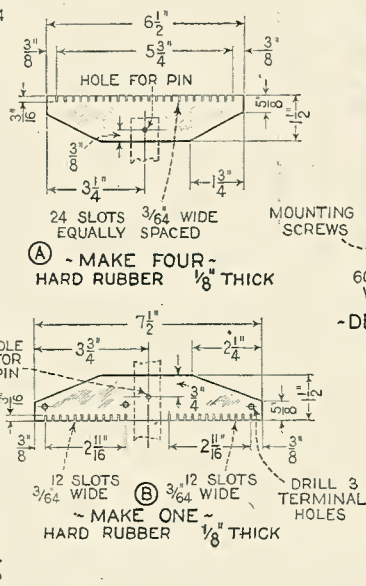
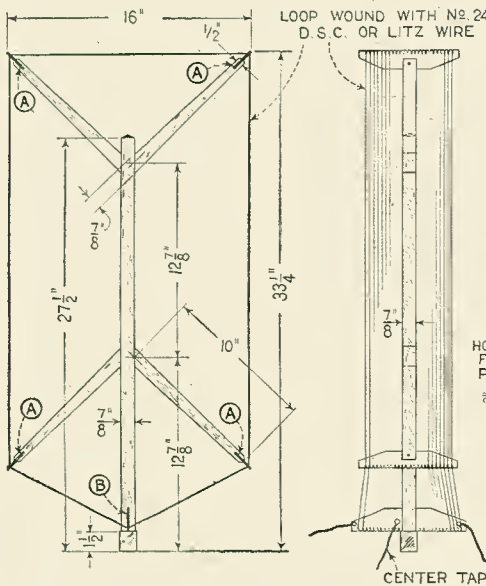
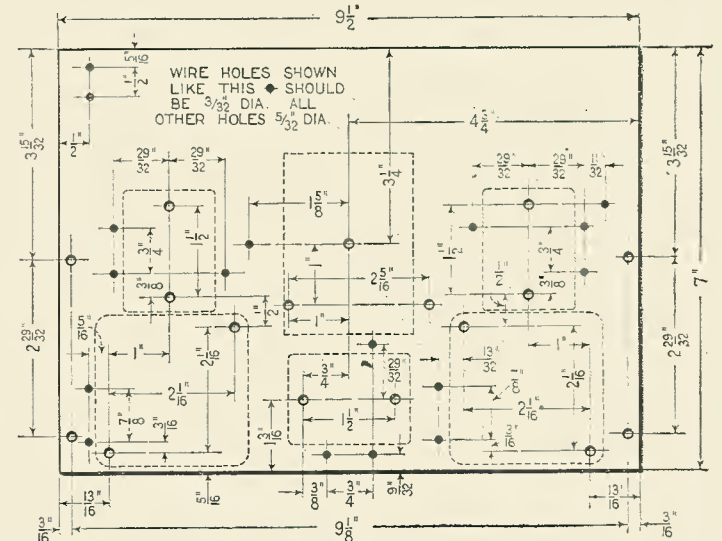
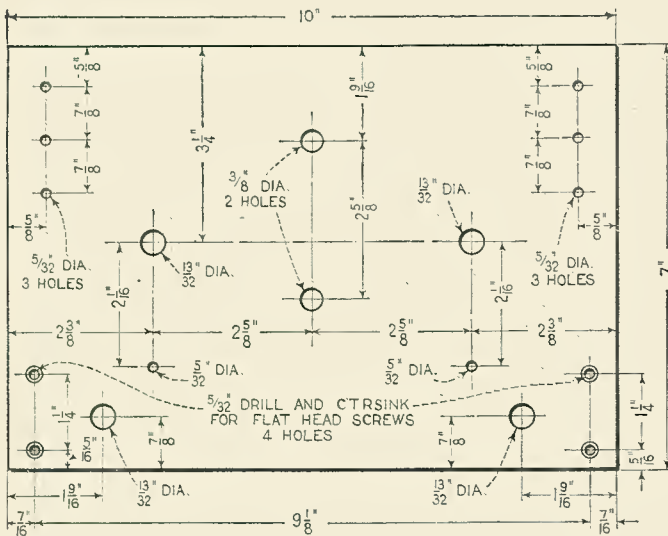

Constructional details are given above for the loop antenna and the grid coil, L2. At the top are the drilling layouts; that for the front panel at the left, and that for the sub-panel at the right.

the two audio-frequency transformers; after securing them, this much of the equipment is wired.

The inductance L2 has 60 turns of No. 26 D.S.C. wire space-wound, the constructional details of this coil being shown in an accompanying sketch. (This coil can be made self-supporting by placing celluloid on a 3-inch cylindrical form which is collapsible. On top of the celluloid the correct number of turns are wound and the wire is thinly coated with collodion. After this has thoroughly dried the wooden form is taken apart and the coil removed.) It may be mounted by placing the turns of wire between two 1/8-inch strips of bakelite or hard rubber, 1/2-inch wide, and screwing these to the sub-panel.

The two fixed condensers C3 and C4 are supported by the bus-bar connection on each side of the inductance L2. The variable condenser designated as C5 is let alone after it has been adjusted at 5 mmf., which value can be easily determined by the constructor.

The specially-wound loop antenna L1 is 16 inches wide and 30 inches long; this is mounted in the cover of the cabinet as shown in the accompanying illustration. This method of mounting the loop is not absolutely necessary, as it will operate just as well if it is supported by the usual base; but mounting it in the top of the cabinet will result in a neat and handy set and save quite a bit of space on the table. The loop must be re-wound, as it is necessary to have 24 turns of wire spaced 1/4-inch. There is a center tap.

OPERATION

After the set has been wired it should be thoroughly checked. First insert a tube in each of the sockets in turn with only the "A" battery connected. If the tube lights in each case then connect the "B" battery to the proper posts, as shown in the accompanying diagram.

After this final check the set is placed in its cabinet and the loop antenna placed on its post on top of the cabinet. The two outer ends of the 24-turn loop are connected to the top and bottom binding posts at the upper left-hand side of the panel. The center tap is connected to the middle binding post of the three.

Tubes of the 201-A type are inserted in the sockets indicated by V1 and V2, and in V3 is placed a 112-type tube. Although no negative grid bias is provided, it is advisable to employ a semi-power tube in the second A. F. stage to handle the output.

When the set has been connected to the batteries and a loud speaker, the small midget condenser, C5, should be so turned that its plates are about half way in. The capac-

SYMBOL	Quantity	NAME OF PART	REMARKS	MANUFACTURER *
C2, C6	2	Variable Condensers	29 plates .00045 mf.	1 22
C1	1	Variable Condenser	Midget .00025 mf.	2 10,11,23,41
	3	Sockets	UX type	3 2,10,15,17,23,25,26,27,29,30.
T1, T2	2	A. F. Transformers	Ratio maximum 3:1	4 2,8,15,21,23,26,28,30,10
R2	1	Rheostat	6 ohms	5 10,13,14,23,26,29,31,32
C3	1	Fixed Condenser	.00025 mf.	6 5,10,14,28,29,32,33,34
C4	1	Fixed Condenser	.001 mf.	6 5,10,14,28,29,32,33,34
R1	1	Grid Leak	2 megohms	5 5,6,28,29,32,33,34,35
	6	Binding Posts		7 10,13,16,23,29,41
RFC	1	R. F. Choke	85 millihenries	8 11,15,28,30
J	1	Jack	Single circuit	9 10,13,14,20,21,26,28,29,37
SW	1	Filament Switch		9 10,13,14,20,21,26,28,29,32,37
C5	1	Variable Condenser	1.8 to 20 mmf. screw adjustment	7 11
	2	Dials	3 inches diameter	10 18,19,20,21
	1	Panel	7 X 10 X 3/16 inches	16 25
	1	Subpanel	7 X 9 1/2 X 3/16 inches	16 25
	2	Brackets		17 10,16,25,41
L2	1	Coil (Special)	60 turns-space wound	11
L1	1	Loop Antenna	24 turns-center tapped - special	12
V1, V2	2	Vacuum tubes	201-A type	24 38,39,40
V3	1	Vacuum tube	112 type	24 38,39,40
	1	Cabinet	7 X 10 X 9 1/2 inches - inside	36

NUMBERS IN LAST COLUMN REFER TO CODE NUMBERS BELOW.

1 Arno Radio Laboratories	2 Silver-Marshall, Inc.	3 Gray & Danielson Mfg. Co. (Bantler)
4 Thordarson Elec. Mfg. Co.	5 Polymat Mfg. Company	6 Ansonix Wireless Corp.
7 L. T. Radio Laboratories	8 Saxon Electric Company	9 Eclair, Inc.
10 Pilot Elec. Mfg. Company	11 Hammarlund Mfg. Company	12 Duro-Metal Products, Inc.
13 Tealey Mfg. Company	14 Carter Radio Co.	15 All-American Radio Co.
16 Vicarita Fabricators, Inc.	17 Benjamin Elec. Mfg. Co.	18 Kurz-Kasch Company
19 Cornell Electric Co.	20 Brooklyn Metal Stamping Co.	21 Martin-Copeland Co. (Marco)
22 United Scientific Lab. (USL)	23 General Radio Company	24 Megavox Company
25 American Hard Rubber Co. (Radion)	26 Pacort Electric Co.	27 Airgap Products Company
28 Leslie F. Muter Company	29 Amoco Products, Inc.	30 Bremer-Tolly Mfg. Company
31 Central Radio Lab.	32 Allen-Bradley Mfg. Co.	33 Dhillier Condenser Co.
34 Electro-Motive Engineering Corp.	35 International Resistance Co. (Datum)	36 Fritta Cabinet Co.
37 Horhart H. Frost, Inc.	38 C. E. Mfg. Co. (Caco)	39 E. T. Cunningham, Inc.
40 Radio Corp. of America	41 C. R. Leutz, Inc.	42
43	44	45

* THE FIGURES IN THE FIRST COLUMN OF MANUFACTURERS INDICATE THE MAKERS OF THE PARTS USED IN THE ORIGINAL EQUIPMENT DESCRIBED HERE.

If you use alternate parts instead of those listed in the first column of manufacturers, be careful to allow for any possible difference in size from those originally used in laying out and drilling the panel and sub-base.

Form copyright, 1927, E. Pub. Co.

ity of the two variable condensers, C2 and C6, is increased slowly, while the loop is slowly rotated until a station is heard. It will be found that the loop condenser C2 is more critical than C6. C2 is varied until signals are as loud as possible without any distortion. The loop is again rotated until the station comes in with maximum volume. Next the regeneration controls C1 and C6 are varied until the receiver is balanced. The right-hand condenser, C6, is placed at approximately the same scale reading as C2; which will no doubt cause a howl to come from the loud speaker. The midget condenser is then varied until this howl disappears, this adjustment being uncritical. However, it will be wise to bring the set, with this condenser, to maximum efficiency,

this condition being a point just under the point of oscillation. Also, the nearer the set is adjusted to this point, the closer will the dial readings be.

Up to a certain point the two condensers, C1 and C6, will give equal control. Beyond this point it will be found that the capacity of the midget condenser, C1, must be increased slightly. Of equal importance is the position toward which the loop antenna is directed when searching for a station. In many cases a matter of 10° in the position of the loop from the direction of a broadcast station will prevent that station from being picked-up. Although the set is very selective, improper tuning will result in apparent broadness in reception.

Rapid Growth of Radio In Czechoslovakia

By HUBERT SLOUKA (Prague)

BROADCASTING in this country did not commence until 1923, when a 1-kw. transmitter was erected at Kbely, the principal aerodrome near Prague. A considerable amount of conservatism had to be overcome; and the first six listeners' licenses were issued in October of that year. At the end of 1924 there were but 1,564; there are now half a million, one for each five families.

All transmitting stations are owned by the national postal service. "Radiojournal," the broadcasting company, was organized by the radio manufacturers in 1923, with a capital of 500,000 kc. (crowns, not kilocycles!) or \$16,000, which was doubled two years later.

In February, 1925, a 500-watt French transmitter was erected at Sirasnice, near Prague, the national capital; and was moved a year later to Bratislava, capital of Slovakia, being replaced by a 5-kw. station of American make. License fees were reduced to 35 cents a month, payable at the nearest post-office. The construction also of a 2.4-kw.

British transmitter was undertaken at Brno, capital of Moravia.

The usual controversies under the license system have arisen, however, listeners complaining that the government should not seek to make a profit on the fees. At present it retains 30% of them for cost of collection.

During the past four years, great progress has been effected by the national radio industry, which now manufactures all needed parts and accessories, and has built up a good export trade in South America. American apparatus and tubes, however, are very widely used, their excellent appearance, as well as their efficiency, being esteemed.

At present the three stations listed above are in daily operation: Prague (Praha) 349 meters; Brno, 441; Bratislava, 300 meters; there is also an experimental station at Kosice. Concerts are given each evening over the first three. Prague should be heard in America, under favorable conditions.

Prof. Thomas G. Masaryk, the president

of the republic, is an ardent supporter of radio. His important addresses are broadcast, and loud speakers are installed in public places on such occasions.

During the Sokol (national athletic society) festivals, great special broadcasts are given; and the music of the National Theatre at Prague and important concerts are likewise regularly broadcast.

Recently the 50-kw. station at Podedbrady has been put in operation by the ministry of foreign affairs, for direct communication with the nation's legations and consulates abroad.

Unfortunately, short-wave work is not supported by the government, and only a few transmitting amateurs are licensed.

Czechoslovakia, which was organized as a republic at the close of the war, is located in the very heart of Central Europe. It is about 55,000 square miles in area, corresponding to the state of Illinois. It is known to its citizens as *Ceskoslovensko*.



Space-Wound Coil Construction



Complete Data for a New Form which Simplifies Construction

By A. BINNEWEG, Jr.

THE construction of coils having mechanical strength and low electrical losses has always been a problem to the radio experimenter. Mechanical strength is desirable to allow safe handling of the coils and low electrical losses are also required if one is to obtain good results. The writer has devised a method of coil construction which allows the experimenter to make coils having the required strength and low losses.

COIL LOSSES

It is well known that the resistance offered to a high-frequency current by ordinary wire increases with the frequency. As shown in Fig. 1, a wire may be considered to be composed of a bundle of an infinite number of very fine conductors. The distribution of flux lines about a wire, and in a wire carrying a direct current, will be somewhat as shown. There are of course, more lines of force surrounding the inner particles than there are about the outer ones; the inductance of the inside of the wire is therefore higher. Therefore, an alternating current will encounter more "inductive reactance" at the center of the wire, and will therefore tend to flow on the surface of the conductor. The higher the frequency, the greater will be this tendency. The "skin effect" will, of course, be less with wires of smaller diameter. Because of this effect, the resistance offered to a high-frequency current may be many times that offered to a direct current.

Fig. 2 shows the flux distribution inside a short solenoid. On account of the "skin effect," most of the current will tend to flow on the inside of the winding. In the diagram, the heavier shading represents greater current density.

EDDY-CURRENT EFFECT

Another effect that must be considered is due to circulating or eddy currents in the metal of the wire composing the coil. The flux threading a coil also penetrates the wire and, because of its alternating nature, will set up currents in the wire; these currents may be very small, but they may cause a considerable increase in the "resistance." These currents tend to oppose the free flow of current in the windings, thereby increasing their resistance, and they also constitute a waste. It is evident that, the smaller the amount of metal in the wire of a given inductance, the less this loss will be. It may be seen that the eddy-current loss will be less for a given inductance and for the same size of wire, if the winding is larger in diameter. The greater the flux density in the conductor of the winding, the greater this loss. For a given eddy-current loss, therefore, the larger the diameter of the winding, the larger the wire which may be used. The diameter of the coil must, therefore, be taken into consideration, as well as the size of wire, and certain length-diameter ratios will give lower losses than others.

Fig. 3 shows approximately how currents are set up in the wire as the flux changes. At one instant the flux will be in one direction and at the next in the opposite direction, that is, it usually passes through a "sinusoidal" variation. The eddy currents will be largest when the flux is changing most rapidly and they will be set up in such a direction as to oppose the variation in the flux.

DISTRIBUTED CAPACITY

In addition to skin effect and eddy current loss, the distributed capacity of a winding may be a source of loss. There is capacity between each turn and every other turn of a winding, as shown in Fig. 4A. This distributed effect is known as distributed capacity, and ordinarily it may be treated as a small capacity in parallel with the winding (Fig. 4B).

Since a condenser is usually already in shunt with the winding, the reason for this

will then be decreased, necessitating more turns for a given value and, perhaps, making the coil too long. There are limits and best values for all of these purposes and these "optimum" specifications will differ for different frequencies. It is evident that this distributed capacity increases with the diameter of the coil; in our condenser analogy, this is equivalent to increasing the area of the plates.

EFFECT OF NEARBY PARTS

This rather brief discussion of coil losses suggests that the design of inductances for use at radio frequencies is quite complicated. For practical reasons, coils must be made having a definite size and proper rigidity. Not only does coil loss depend on the factors mentioned, but also on the position of neighboring apparatus and conductors, found in the ordinary receiver. A nearby circuit, resonant at the same frequency to which the coil is tuned, may cause a large increase in the apparent resistance of the coil; power is absorbed from the coil, which is equivalent to a large increase in resistance in the coil. Whenever possible, therefore, a low-loss coil should be kept at quite a distance from all apparatus; there is little advantage in having a low-loss coil if it is placed too near other parts. In some circuits, losses are purposely introduced to secure some practical result, but the experimenter may use to considerable advantage coils having low electrical losses. Their construction will be described below.

MEETING THE REQUIREMENTS

With these facts in mind, the writer has developed some coils that approach the ideal construction. In order to obtain the proper size and length-diameter ratios, the diameter chosen for coils to be used on the broadcast range is three inches. As may be seen in the illustration, the coils are space-wound, and supported by very small strips of celluloid, about the best material for this purpose.

Coils of this type have not been generally used because of the constructional difficulties involved. With the forms illustrated here, two coils may be wound exactly alike as far as diameter, spacing of turns, etc., are concerned, and they will be so rigid that the wire can be made to "ring" when struck lightly. For the experimenter who wishes to secure the maximum results, these are the coils to construct.

At the left of the illustration may be seen two suggested "amateur" units, for use on the short-waves. Since it is extremely important to prevent any vibration of the coils at the higher frequencies, and since each experimenter has his own pet value of coupling between coils, it is suggested that the primary and secondary inductances be wound on the same celluloid strips. The tickler, although usually subjected to much twisting and turning during experimentation,

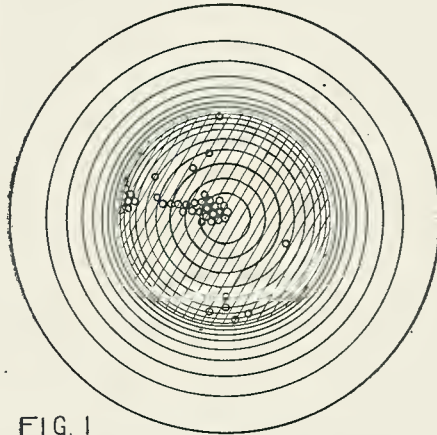

FIG. 1

The distribution of the flux lines, surrounding a wire carrying a direct current is approximately as shown.

loss may not be clear to the reader. Under ordinary conditions this distributed effect may be a very poor "condenser"; that is, there may be between the "plates" (or turns of the winding) a very poor dielectric, such as the form upon which the wire is wound or the "dope" used to fasten the wire in place. Just as the capacity of a condenser may be decreased by decreasing the size of the plates or increasing the distance between plates, the distributed capacity of a coil may be decreased by using smaller wire or leaving a space between adjacent turns of the coil. The size of the wire cannot be decreased too much, for the resistance will then increase; and the distance between turns cannot be made too large, for the inductance

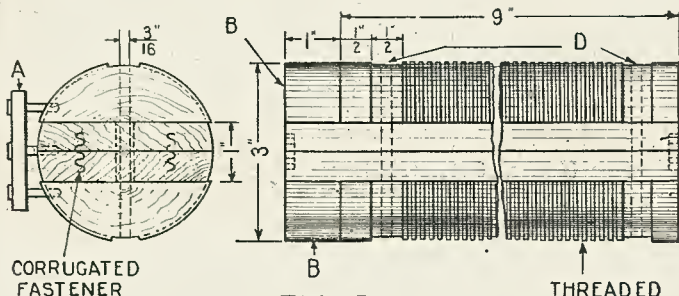

FIG. 5

At the right, in Fig. 3, is a section of wire in a radio-frequency coil, showing the flux lines and eddy currents. Note that the useful lines and the eddy currents oppose each other in certain positions, where the arrows are in opposite directions; this creates "resistance."

At the left, in Fig. 5, it is shown how to construct a wooden form; like that on which the coils, shown on the opposite page, are wound.

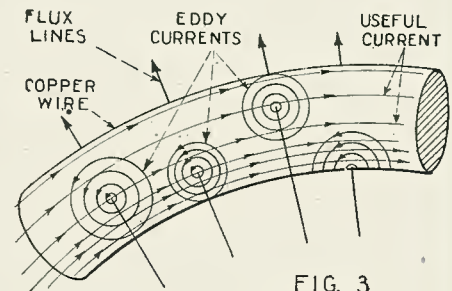

FIG. 3

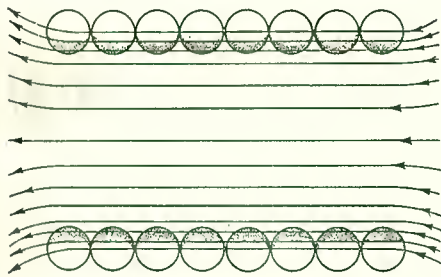

FIG. 2

Approximate flux distribution inside a short solenoid; the shading on the wire sections indicates the path of the high-frequency currents.

may be wound in the same fashion to keep the coils alike. Its distance from the secondary and the direction in which it should be wound should be determined beforehand. For the higher frequencies, a three-inch diameter is somewhat too large; hence these coils must be made smaller in diameter, as described later.

One of the greatest difficulties in the construction of coils of this kind has been the removal of the coils from the cardboard tubing, or other form used, without injuring the winding. This has been overcome by constructing the form in three parts. In the center of the large illustration are shown the three parts of a form in the "rough"; at the right a completed form with one of the bolts and its wing-nut. The center section, although held firmly in place by the bolts and wing-nuts when assembled, is quite independent of the rest of the form. When the winding is completed, one of the bolts is removed and the center section pulled out. This allows the form to "collapse"; so that the coil is left free and may be easily slipped off. It is really surprising how quickly and easily these coils can be made.

CONSTRUCTION OF FORM

Two 2-inch pieces of fairly hard wood, of the proper length, were securely screwed together and turned down to a cylinder 3 inches in diameter. The cylinder was then placed in a screw-cutting lathe, trued up, sandpapered smooth, and 10 threads per inch were cut over its length. The ends were then marked as shown in Fig. 5 and the cylinder was cut with a band saw into three lengthwise sections. In order to keep the saw cutting properly, a small piece "A" (Fig. 5) was nailed to the cylinder, as a support.

Small pieces, 1 inch long, were then cut from the ends of the two outer sections (as indicated at "B") and the threaded sides of the middle section were planed off, deep enough so that the celluloid strips could be laid on these sides without exceeding the original circumference for the wire.

The three pieces were securely held together until two 3/16-inch holes were drilled, about 1/2-inch from the edges. These were fitted with stove bolts and wing-nuts to fit, as may be seen in the illustration. The center piece was then cut from the end into the hole at the opposite end from the "tongue," as shown in Fig. 6. This allowed the piece to be pulled out independently of the bolt. Small grooves were then cut around the circumference at the ends of the form, and other grooves 1/2-inch wide cut lengthwise as shown at "D" and "E" respectively. The former are for two small brass securing strips, the construction of which is shown in Fig. 7; and the latter to provide two more positions for celluloid strips, four in all. The brass strips provide an easy way of securing the celluloid and wire when the wire is being wound on.

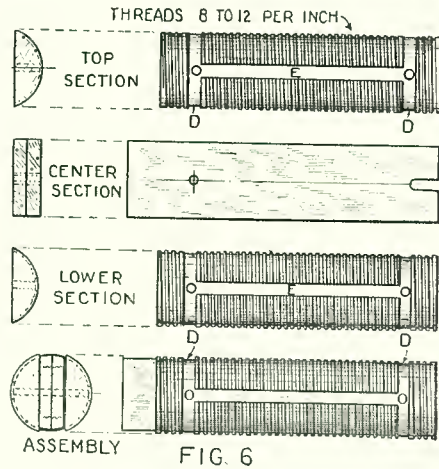

Additional details for the construction of the wooden form on which the coils are wound.

Stove bolts are passed through the 3/16-inch holes and then through the form; the strips are bent round the form and the ends of the bolts passed through the slots in the strips, small washers and the wing-nuts serving to clamp the strips to the form.

When two or more forms are being made,

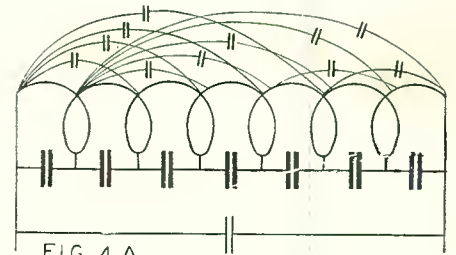

FIG. 4 A

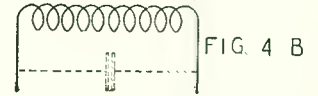

FIG. 4 B

Fig. 4A shows the distributed-capacity effect in a single-layer solenoid. Fig. 4B indicates this capacity schematically.

the original cylinder may be turned long enough so that all the desired forms can be cut from it. Although eight or ten threads per inch proved satisfactory, any number of threads may be cut; for general use, it seems that 12 per inch should be about right. For the lower amateur ranges, the form should be 2 1/2 inches in diameter and should have 8 threads per inch.

These forms, although quite easily made as described, may be made in the ordinary workshop with slight modifications. Perhaps the only difficulty involved will be the threading of the cylinder. This can be easily done if the threads are laid out in pencil and then cut as small depressions with a sharp knife. These depressions, as in the case of the threads described above, need be deep enough only to prevent the wire from slipping during the winding process. The tongue on the smaller forms need not be as large as on the larger ones.

COIL CONSTRUCTION

To construct a coil, choose a form of the proper length for the contemplated winding, loosen the wing-nuts holding the brass strips, and place the celluloid strips in the proper grooves. Then, at the end without the tongue, insert the end of the wire under the brass strip, and press the strip together at the top while screwing down on the wing-nut. If a very strong coil support is desired other celluloid strips should be laid over the first ones, with the wire between. When separate strips are used, a large coil may be wound and smaller ones may be made by cutting into several parts.

(Continued on page 273)

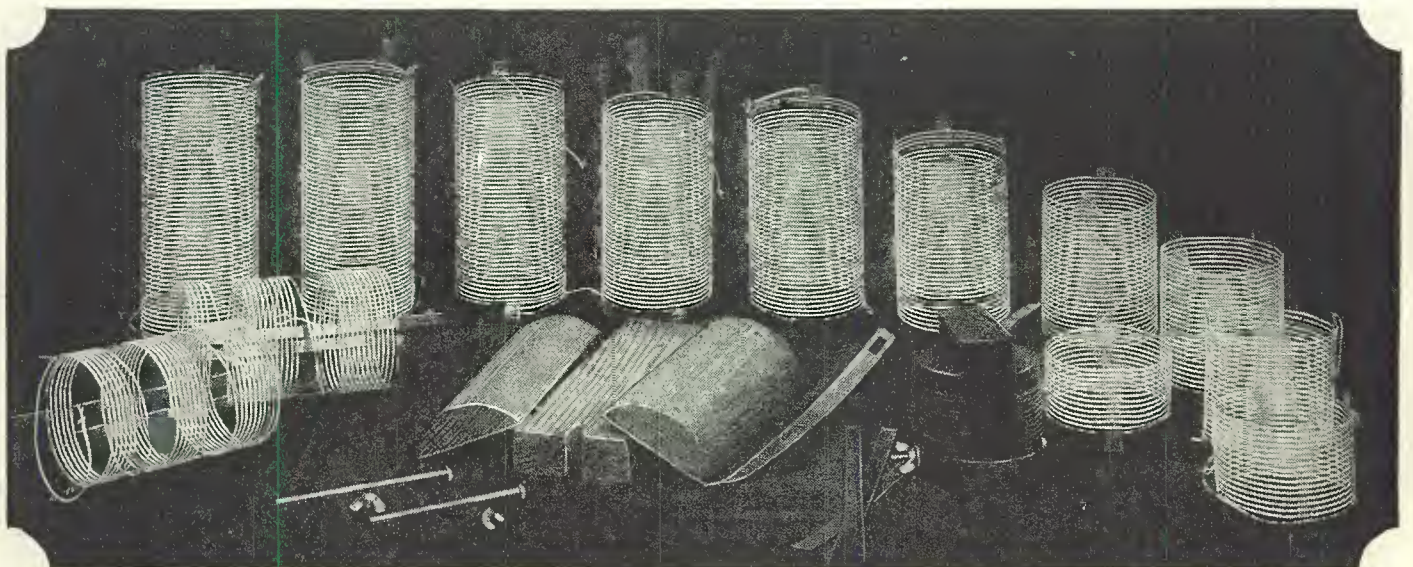

A group of extremely low-loss coils, wound by the author, and two of the coil forms which he has developed. The large coils cover the broad-

cast range and the small ones the amateur bands. Any of these may be made very easily by the methods explained in this article.

The Radio News Special Short-Wave Broadcast Receiver

Designed for Quality Reproduction on Waves From 15 Meters Up

By KENDALL CLOUGH*

IN this article Mr. Clough discusses briefly the most important theoretical points concerned in the operation of the RADIO NEWS Short-Wave Receiver; which, unlike most other short-wave sets, is designed for high quality of reproduction. The construction of this receiver will be described in the October number of RADIO NEWS, in which complete working drawings and picture- and schematic-wiring diagrams will be given.

—EDITOR.

IF we should attempt to list the outstanding classics of radio literature for the past year, we would surely include a paper by E. T. Chaffee and G. H. Browning, on "The Detection of Small Signals," which appeared in the February, 1927, issue of the proceedings of the Institute of Radio Engineers. Any attempt at an abstract of this paper is unnecessary and out of order for present purposes, except to mention a striking conclusion reached by the authors with regard to the use of the grid-leak-and-condenser combination, commonly used in the type of receiver about to be described. Such a combination (condenser and leak in shunt) has characteristics such that a low impedance is presented to currents of radio frequency, and a high impedance to currents of audio frequency, and to direct current.

A NEW TYPE OF DETECTOR-GRID IMPEDANCE

As pointed out in the conclusions of the paper cited above, this is not the ideal type of impedance for detection purposes, if the highest quality of output is to be obtained from the detector. As stated by the authors, the impedance employed should have, not only a high impedance to audio-frequency currents and a low impedance to radio frequencies, but a very low resistance to direct currents as well. An impedance of this type is provided by a large iron-cored inductor shunted by a small fixed condenser. In the

receiver to be described this impedance is the secondary of a 2:1 A.F. amplifying transformer shunted by a .0001-mf. mica condenser.

In this essential respect the RADIO NEWS Short-Wave Receiver differs from the many receivers for short waves which have been previously described in the popular press. In the usual type of receiver designed for extreme short-wave reception, only code (telegraph) signals have been contemplated; so that no such expedient is necessary or even desirable. In addition, such receivers are usually equipped with high-ratio transformers and small tubes; the purpose being actually *poor* audio quality, in order to amplify greatly the single-frequency code signal, with a minimum amplification of other frequencies.

Reception of the extreme short-wave broadcast stations seems to be of increasing popularity and, to meet the demands of listeners, there is offered the herewith-illustrated receiver, equipped with a special detecting system, high-quality audio transformers, and a power tube in the last stage.

FROM 15 METERS UP

The fundamental circuit diagram of the receiver (minus the audio amplifier) is shown in Fig. 1.

As ordinarily supplied, three special space-wound coils with a plug-in base are included in kit form for this set. The wavelength ranges of these coils are as follows:

- No. 1, 15-35 meters (approximately)
- No. 2, 32-68 meters (approximately)
- No. 3, 57-133 meters (approximately)

These ranges will vary somewhat with different condensers and detector tubes, but the above figures will be of assistance in locating stations of known wavelengths. Additional coils may be procured for extending this range upwards as follows:

- No. 4, 125-250 meters
- No. 5, 235-550 meters

All of these coils are readily interchangeable in the same coil base, thus altering the wavelength range of the receiver.

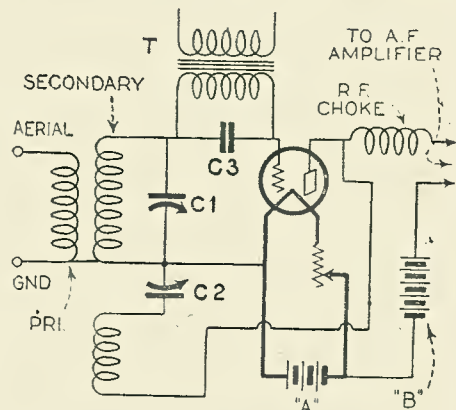

Fig. 1. This shows in schematic form the detector section of the RADIO NEWS short-wave broadcast receiver.

The secondary of the tuner is shunted by a 140-mmf. condenser of the S.L.F. type (C1), while regeneration is controlled by a 250-mmf. variable (C2). Close to the grid terminal of the receiver is the 2:1 audio transformer (T), the secondary of which is shunted by a 100-mmf. mica condenser (C3). This transformer is placed at the rear of the sub-panel to prevent troublesome capacity effects from the hand of the operator.

SPECIAL CHOKE USED

In order to prevent the self-capacity of the primary of the first transformer in the audio amplifier (not shown in Fig. 1) from short-circuiting the radio-frequency currents in the plate circuit of the detector, a special radio-frequency choke coil is employed. The use of this choke is important; as it has been designed to have a uniform "choking" effect on the wide range of wavelengths covered by the receiver. Many chokes employed in this position have the unpleasant characteristic of showing so-called "holes" in the tuning range: that is, points on the tuning dial where the receiver cannot be made to oscillate, regardless of the amount of capacity used in the 250-mmf. regeneration condenser.

The remainder of the circuit comprises the usual two stages of audio-frequency amplification, terminating in a power tube in the last stage. A 171-type tube is employed in this position, for the best quality of output; therefore, 180 volts of "B" is applied to the plate, and 40 volts of "C" to the grid.

SIMPLE AND SATISFACTORY

The operation of the receiver is very simple, as there is only one dial (at the left) to control the tuning of the receiver; the right hand dial controls the regeneration and thereby the amplification. If it is not found possible to throw the receiver into oscillation with this dial, the "B" voltage on the detector should be increased from 45 to 67½.

In laboratory tests the performance of the receiver has been found very excellent on the short-wave broadcasts, the tone quality being of the best and the over-all sensitivity being as good, if not slightly better, than is obtained by the use of the usual leak-and-condenser combination.

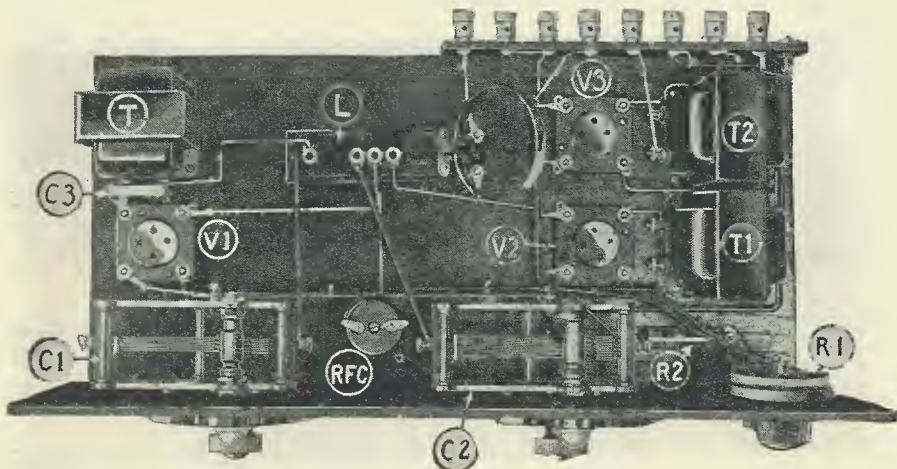

Top view of the complete three-tube short-wave receiver of which will be described in detail in next month's RADIO NEWS. C1, tuning condenser; C2, regeneration control; L, plug-in coil base; T, grid choke; C3, grid condenser; R.F.C., R.F. choke; T1, T2, A.F. transformers; R1, R2, filament resistors; V1, V2, V3, tube sockets.

*Director, Research Laboratories of Chicago.

Hints About Three-Foot Cones

A Few Tips which Will Help Their Constructors

By CLYDE J. FITCH

It has always been the aim of the radio expert to develop a loud speaker that would actually respond to the full frequency range covered by musical instruments; and not merely to the higher frequencies or the higher harmonics of the lower frequencies, which is the case with many loud speakers. A good loud speaker should respond to the lowest tone of the bass viol which, in the international pitch, is about forty cycles. Of course the piano keyboard extends to a lower range, the lowest note having a frequency of 27.188 cycles; but it is doubtful if any broadcasting stations transmit frequencies as low as this and consequently there is no advantage in having a loud speaker that would operate on them.

It is easy to build a loud speaker that will operate on the higher frequencies. Practically all the horns and small cones do this. The difficulty has always been to make a loud speaker that would operate on the lower frequencies as well as the higher. This has been accomplished in some of the larger cone speakers, about three feet in diameter. It seems that a large cone is required in order to get the bass notes. At the same time the unit which drives the cone should be matched to suit it, so that both high and low notes come through with more or less equal fidelity.

On account of the size of these speakers they are now furnished in kit form for convenient home assembly. But there are many little details of construction which might seem very simple and unimportant, yet in reality have a great bearing on the quality of reproduction. We must remember that the mechanical vibrations applied to the cone by the unit are in the order of one or two one-thousandths of an inch in amplitude, and therefore a slight change in the design of the instrument will produce very noticeable results.

TYPES OF MOUNTING

While the three-foot cone may be mounted on the wall, ceiling, pedestal, or in a console cabinet, the wall and ceiling types are the most popular; and the type shown in the various illustrations, in which a single cone only is used, is the best for home assembly, from the standpoint of not only mechanical simplicity but also acoustical superiority. Remember that the back of the cone should be entirely open and free, and therefore the finished wall cone should be spaced a few inches from the wall for best results.

Fig. 1 shows details of the frame construction for the wall- or ceiling-type cone. This should be built first, and the arms should be

well fitted and glued into the center block to prevent rattling. Vibrations are transmitted to the frame as well as to the cone, and any looseness in the frame will cause disagreeable noises.

Fig. 2 is a rear view of the assembled speaker with the cone and unit mounted on the frame. The construction is obvious from the illustration. Fig. 3 is the front view of the same instrument. Note the pleasing appearance of the decorated cone. It will harmonize with the best home interiors, so that the purchaser can install one without inviting domestic dissension.

TIPS ON THE ASSEMBLY

In assembling one of these speakers, the unit should be mounted to the frame before the cone is made. On the drive pin of the unit are two metal cones which are used for clamping the apex to the large cone and making a tight mechanical connection. One important point in this part of the assembly,

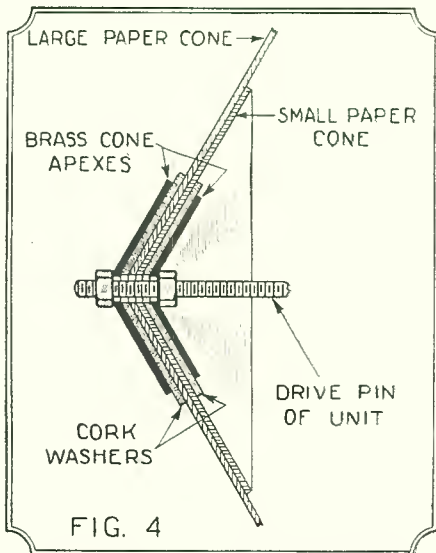

Method of mounting the paper diaphragm to the shaft of the unit. The resiliency of the cork damps undesirable vibrations.

which is overlooked in practically all cones now on the market, is that we may term "cushion drive." This is illustrated in Fig. 4.

Two cork washers, about one thirty-second of an inch in thickness, are placed under the metal cones. Thus the vibrations from the unit are transmitted through cork to the large



Fig. 5 illustrates the paper diaphragm being cut out, preparatory to gluing and mounting.

cone. The purpose of the cork is to absorb extremely high frequencies which produce harsh disagreeable noises and which are caused by the fundamental periods of vibration of the metal parts of the unit, such as the drive pin and the metal cones themselves. Even though you now have a cone speaker, it is very advisable to procure a large cork, slice off two thin washers with a safety-razor blade, and clamp them under the metal cone attachments. You will immediately note a difference in tone, due to the elimination of the harsh overtones and an increased amplitude of the fundamental bass tones.

The cone material is usually furnished in the form of a square sheet rolled up in a small package. After unrolling it will look like Fig. 5. The cone is made by cutting on the lines indicated and gluing into shape. The small cone printed in the upper right corner of the sheet is to be cut out and glued to the apex of the main cone for strengthening purposes. (This is shown in Fig. 4.) The flange is bent towards the apex along the line indicated. It is advisable to scratch or indent the surface of the paper along this line with a blunt tool before bending. This flange strengthens the cone and makes it sufficiently rigid to be self-supporting.

When assembling the cone to the unit and frame, make sure that it is in good alignment and that the cone is clamped to the drive pin where it naturally falls; so that no mechanical strain is placed on the pin. Thumb tacks are used to attach the cone to the four arms of the frame as shown.

ADJUSTMENT

The unit employed on this particular speaker is illustrated in Fig. 6. The extension pin for the drive rod and the cone apices are shown in this illustration. While it is adjusted for the average set, a slight readjustment may be necessary after the speaker is assembled; this can be made by means of the two lock nuts. Loosening the upper one and tightening the lower widens (Continued on page 271)

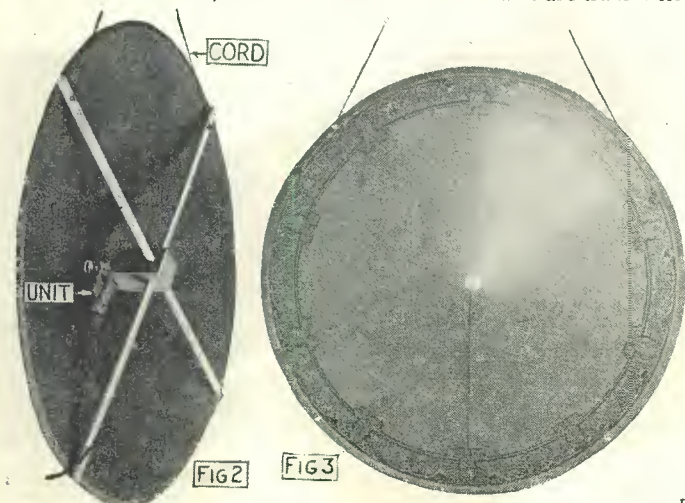

At the right are illustrated constructional details of a central frame, for either the wall- or the ceiling-type three-foot cone speaker. The arms should be carefully fitted and then glued into the center block to eliminate any vibration.

Fig. 2, at the left, shows the rear view of a completed three-foot speaker, with the driving unit in place on the central wooden block.

Fig. 3 is the front view of a completed cone, of the model described in this article.

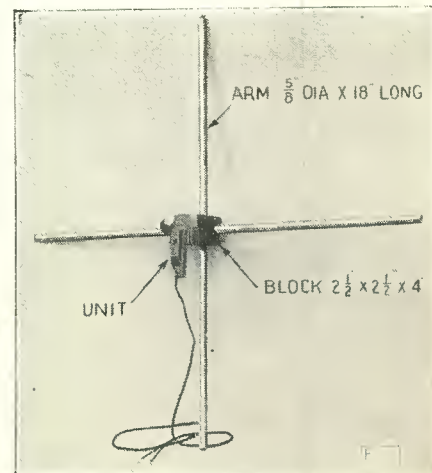

New Experiments with a Transmitting Set

The "Moduloscope" as an Indicator of Various Operating Conditions

By JOHN L. REINARTZ

IN this, the fifth of this series of articles, Mr. Reinartz describes the construction and operation of a Moduloscope, a device which, by means of a "coronal" discharge, indicates the nature of the plate-supply voltage. Many interesting experiments can be performed and several worthwhile tests made using this instrument.

The whirling of the spinner with its coronal discharge forms an optical illusion, similar to that described in the August issue of RADIO NEWS (page 131) in connection with the Strobodyne Receiver. The various spots may be made to rotate in either direction or to remain stationary by varying the frequency of the transmitter.

In the sixth and last of Mr. Reinartz's articles, appearing in September RADIO NEWS, he will describe some experiments which can be performed when using ultra-short wavelengths.—EDITOR.

the moving wire, it should spin around. Therefore, a wire was prepared and mounted in the manner shown in Fig. 2.

AN ELECTRIC "WINDMILL"

When the system was again in resonance this wire rotated rapidly, exhibiting a coronal discharge at each end. This discharge now assumed different characteristics; for, instead of a continuous coronal display, a series of spots of light appeared as the wire gained in speed. In other words, there were an even number of spots of purple light and an equal number of dark spaces. It was found that the length of these spots was a function of the plate voltage; the "blackness" of the dark spaces depends upon the nature of the supply voltage, and the number of spots and spaces on the power put into the oscillating system.

By far the most interesting phase of these effects is that dependent on the nature of the plate supply. Many photographs were made of the revolving wire, while different types of plate voltage were being supplied. The results of these photographs are reproduced in Figs. 3, 4, 5 and 6. In Fig. 3 the 14 spots and dark spaces indicate that the voltage supplied to the plate of the tube was unrectified alternating current. When this A.C. was rectified the spots were not as far apart as they are in Fig. 3 but rather as they are shown in Fig. 4. Fig. 5 is the result when the supply was rectified and partially filtered, and Fig. 6 shows that of fully-filtered supply current. It will be seen, in the last two figures, that the spots become more and more merged into the dark spaces until the latter are completely wiped out; the final result being a smooth ring of light.

THE average amateur owning a short-wave transmitter very seldom realizes that he can utilize his equipment in a number of ways, other than for the sending of messages. If he is interested in the theory of his set he will find here described several interesting experiments which will quickly acquaint him with the operating characteristics of his apparatus.

Figs. 1A and 1B are variations of the transmitting circuit described by the writer in the June, 1927, issue of RADIO NEWS. The coil, M, is inductively coupled to the antenna coil, A, of the set. When the circuit is oscillating, let us say at 40 meters, and if the coil, M, is of such proportions that it is resonant, either on its fundamental or some harmonic, at this wavelength, then a large voltage will be induced in M. If the two ends of the coil are brought within two or three inches of each other, at the exact point of resonance, a "coronal" discharge will occur between the loose coil ends.

During the use of this apparatus for the testing of some insulators the wire extending from the upper end of the coil, M, was seen to be swaying back and forth with a periodical motion. This movement was evidently caused by the reaction of the discharge of the corona upon the air. The thought came that, if a wire were slightly curved and balanced upon the upper end of

to keep the wire from unwinding. The upper end of the coil wire is bent at an angle of 90° to the bottle, and the insulation is removed from about an inch or two of the wire's end. In order that no coronal discharge shall occur at the end of the wire, the end is bent around to form a small loop.

The spinner is then prepared. A piece of bare No. 30 (or smaller) copper wire is looped in the center, so that it will fit snugly over the end of the coil's wire and yet spin freely. The ends of this spinner are then bent into the shape shown in Fig. 2A. The

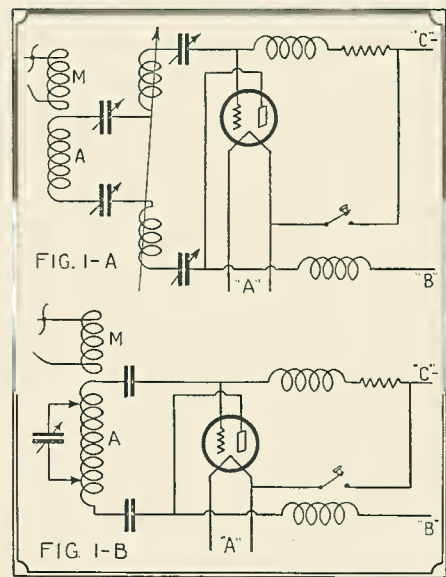

Two methods of connecting the Moduloscope in a transmitting circuit.

CONSTRUCTION OF THE MODULOSCOPE

It will be well, before going any farther, to describe the construction of the coil with which these experiments and many others can be performed. In order to withstand the heat generated it is best to wind the coil on a glass cylinder; in the writer's equipment this is a straight bottle, two inches in diameter and about ten inches in length.

The coil consists of about 125 turns of No. 26 D.C.C. wire wound on the bottle, allowing about six or eight inches for the free ends. The last few turns on each end of the coil are wrapped with adhesive tape

length between the ends of the spinner after bending should be about 4 inches. The lower free end of the coil is then bent towards the middle of the coil, until it is approximately 3 inches from the spinner, when the latter is in a vertical position.

This little device has proved so handy to the writer that he advises its being mounted permanently. The closed end of the bottle may be fitted into a hole, about one inch deep, in a wooden block about eight inches square and 1½ inches thick. This idea is shown in Fig. 2. The large copper coil shown (which is the coil A in Figs. 1A and 1B) is ordinarily of ribbon 3/8-inch wide

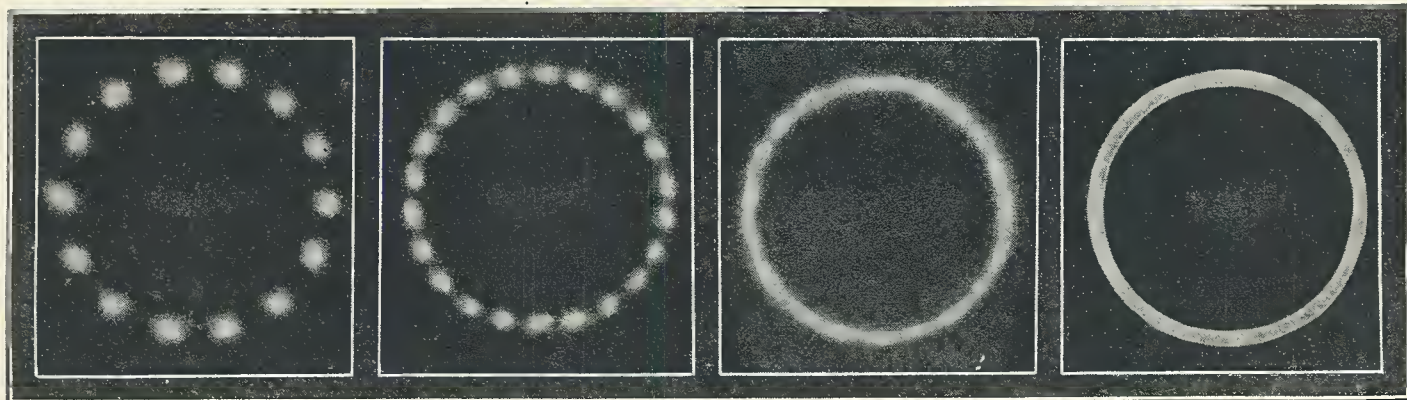

Fig. 3. Unrectified A.C. as it is indicated by the Moduloscope.

Fig. 4. The A.C. has been rectified, but not filtered.

Fig. 5. The rectified A.C. after it has been partially filtered.

Fig. 6. The fully-filtered current is shown by a smooth band of light.

and wound to a diameter of 6 inches. If it is so desired, the ordinary antenna coil of the transmitter can be used when the moduloscope is being operated; or a series of coils may be prepared with the same dimensions and characteristics as the antenna coils of the transmitter.

When the moduloscope is being operated it need not be near the transmitter. Leads from the condensers (Fig. 1A) may be about three feet long.

It might be mentioned here that a certain amount of precaution should be exercised when operating the moduloscope. The voltage generated in the coil (M, Fig. 1A) is somewhere between 25,000 and 30,000. This voltage is not dangerous, as the current is extremely small. It can be taken through the body without being felt, if a metal rod is held in the hand and the discharge allowed to jump to that. The rod dissipates the charge over a large area of the skin of the hand and no ill effects are experienced; which would not be the case, however, if the charge were allowed to jump to a finger. Here the entire charge would be concentrated at one point and a burn would result.

WAVELENGTH TESTING

One of the most useful purposes to which the moduloscope can be put is the testing of the wavelength of the transmitter. We will suppose that the ham wishes to work on some wave between 35 and 40 meters, say 37.5. He can prepare a standard-frequency inductance, such as described by the writer in the August issue of RADIO NEWS, for that wave; only, instead of winding it on a cardboard or bakelite form, he should follow the directions we have outlined here for building a moduloscope.

If a spinner is put on the free end of the coil it will be possible to get a series of discharges when the transmitter is at the same frequency as the fundamental frequency of the standard coil. It must be realized, however, that care should be taken in preparing the coil; but the accurate checking of standard inductances is far from

being difficult, as was explained in the fourth of this series of articles last month.

Let us assume that we have made a coil which we are positive is of the correct inductance to resonate at our wave of 37.5 meters. We have checked this coil with our calibrated wavemeter. We place this coil with its ends prepared, one with a spinner and the other bent up away from the antenna coil, A. The condensers of the transmitter are then varied very slowly; i.e. the wavelength is changed, until the spinner starts rotating, thus indicating that the trans-

easily done by placing the lower free end upon the coil in different places, thus short-circuiting that number of turns from the bottom. The insulation need not be removed to perform this test, as the discharge will easily go through it. After carefully trying the end on different turns, some point will be found where the spinner will start rotating, indicating resonance. If so desired, the end of the coil can be allowed to remain at that spot, or the superfluous turns of wire can be removed.

Not only will the operator have an excellent check on the frequency upon which he is working, but he will have a good idea of the condition of his plate supply, as shown by the type of discharge from the spinner. This can be learned by comparison with the illustrations (Figs. 3, 4, 5 and 6).

TEST OF INSULATION

Another series of interesting and instructive experiments can be performed with a transmitter; these showing the effect of moisture on losses in power and changes in wavelength.

The moduloscope is set in operation and a dry object is brought near the upper end of the coil. There will be the slightest drop in the plate milliammeter and a slight slowing up of the spinner. If this same object (which we will assume to be a glass insulator) is moistened, there will be observed a sharp drop in the milliammeter and decided slowing of the moduloscope spinner, indicating a change of wavelength.

A great many interesting experiments can be performed along these and similar lines by the aid of the moduloscope. If it is desired to make a coil that has many more turns on it (say 300) then the apparatus can be used as a Tesla coil, which will give long high-frequency sparks, and can also be used for many interesting experiments. Insulation testing of glass, porcelain, bakelite, etc., can be done with a high-frequency outfit; and all this type of work is of a nature to teach the amateur something and get him thinking along lines that are constructive—something needed today.

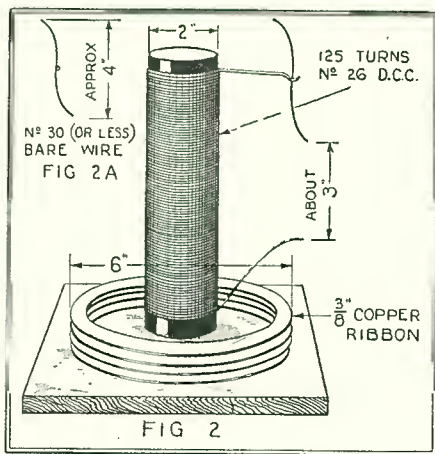

The moduloscope may be mounted in a wooden base as shown in Fig. 2. In Fig. 2A is shown the spinner.

mitter and the moduloscope are in resonance. These results can now be checked again by means of a wavemeter.

For the sake of argument, suppose that we are not positive just how many turns should be put on this standard inductance for the wavelength on which we wish to transmit. We will suppose that the number is approximately 60. With the aid of a wavemeter we set the transmitter at the desired frequency and then vary the number of turns in the moduloscope coil. This is

How Filtering Is Accomplished in Radio Power Supply

A BETTER idea of the action of the "filters," so essential in the operation of a radio receiver by current taken from the house-lighting socket, will be easily obtained from a hydraulic analogy. The illustration here explains the action, without taking into consideration the phases created in the generation of current by a dynamo; but this is a matter of detail only.

Let us imagine a pump, as shown at the center of the illustration (Fig. 1), in which

a piston P is moving alternately up and down. If the pipes connecting the top and bottom of the pump cylinder offered no resistance to the flow of the liquid, the movement of the latter would be alternating; it would be forced first to one side of the piston, and then to the other, during every cycle of one stroke up and one stroke down.

FLOW DIRECTED ONE WAY

In the illustration, however, we have represented at S and S1 valves which will per-

mit the water to flow in but one direction. It must course through the system, as indicated by the arrows, to the water wheel B which it is driving, and then back into the pump at S-S1. In this illustration the valves represent rectifiers of electricity (whether chemical devices or vacuum tubes) which permit an alternating current to pass only while it is flowing in one direction, and block it whenever the positive and negative

(Continued on page 280.)

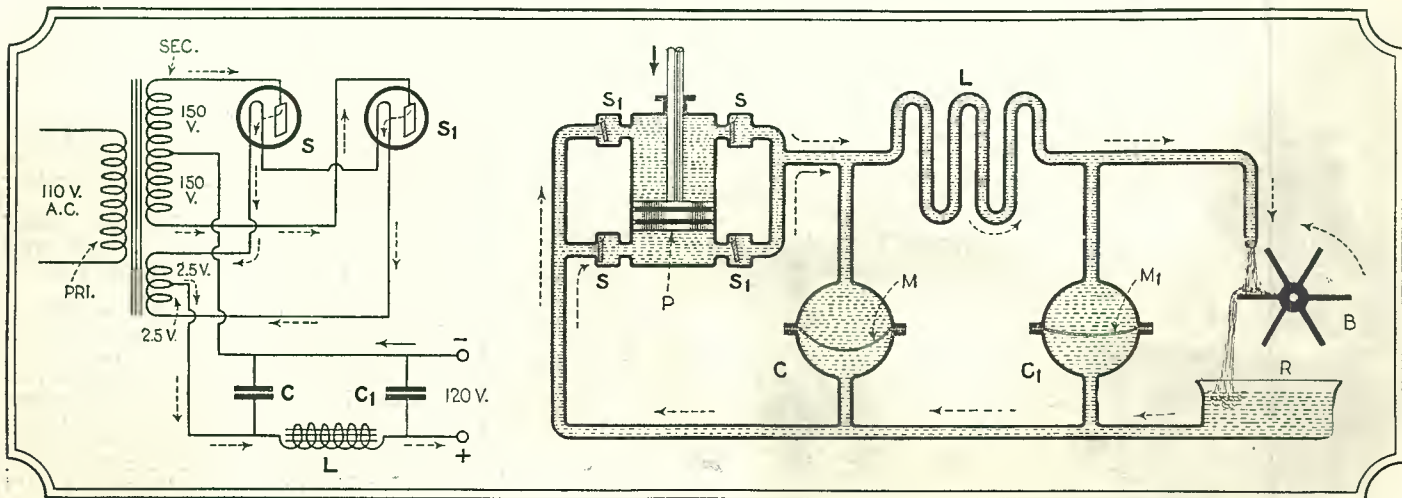

The hydraulic system shown at the right is Fig. 1. This simple analogy shows clearly how the electric A.C. power-supply unit in Fig. 2 (left) oper-

ates, by the conversion of reciprocating motion into a steady, smooth current flow.

Illustration adapted from "La Science et la Vie," Paris.



With the Amateurs

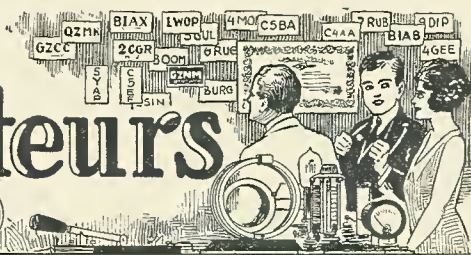

A REAL "HAM" CLUB

A GOOD example of how radio experimenters and amateurs in a community may get together and form a club for the mutual exchange of ideas and knowledge is found in the Butte Radio Club of Butte, Montana. In this western city, a score of typical radio experimenters formed a fraternal organization and proceeded to contribute apparatus for the establishment of a club radio station and experimental laboratory. The tangible result of their fine cooperation is shown here.

The club room of the organization, a large, comfortable place in which the members can feel perfectly at home, contains, in addition to three receiving sets, a complete amateur transmitting outfit, which has been licensed by the Department of Commerce and which has the call letters 7NT. This station is well known to amateurs throughout the country. Here the individual members who are not fortunate enough to possess expensive apparatus of their own may use the common property of the club and may perform numerous experiments. Many radio clubs talk about building a club station and outfitting a small laboratory for experimental work, but few of them have actually put their ideas into action so completely as the Butte Radio Club does. The finely-equipped club room of the latter organization should serve as a goal which other radio clubs should try to reach.

An idea of the completeness of the installation may be gained from a close examination of the illustration shown below. On the top of the table, at the extreme left, are a power amplifier outfit, along with a special cone speaker, and a 150-volt Edison "B" battery, a heavy storage "A" battery, and a charger for the "B" battery. On the shelf, placed between the legs of the table, is a charger for the "A" battery. The middle table, which is the largest of the three shown, holds the following apparatus: A Hammarlund-Roberts receiver for broadcast waves, a Reinartz receiver for long waves, a 50-watt short-wave transmitter, a short-wave wavemeter and a Reinartz short-wave receiver. On the floor, beneath the table, are a 1,000-volt transformer and a chemical recti-

fier, which supply the plate voltage for the transmitter. The small table on the extreme right is the operating one, and serves also as a desk for the secretary.

The group photograph shows the officers and some of the members of the Butte

connected with the Anaconda Copper Mining Company, in the capacity of group superintendent of zinc mines. He is a member of the Montana Society of Engineers and of the American Institute of Mining and Metallurgical Engineers.



Officers and members of the Butte Radio Club in their meeting room.

Radio Club. Seated in the center, and holding a copy of RADIO NEWS, is Judge William E. Carroll, the president. To his right are Carl J. Trauerman, publicity director, and E. D. Lomas, assistant publicity director. To the Judge's left are Moses E. Cooper, secretary; John R. Bartlett, vice-president and chairman of the program committee, and Dan Georgevich, chairman of the entertainment committee. Judge Carroll, a graduate of the University of Michigan, has been practicing law in Butte for thirty-two years and for the last six years has been judge of the District Court. Mr. Bartlett is also a graduate of the University of Michigan and has been

The other officers are likewise successful business men and engineers who have adopted radio as an extremely interesting and diverting pastime. Mr. Cooper, for instance, was in the Signal Corps of the United States Army during the Spanish-American war and served as an observer for the government during the World War. Mr. Trauerman is a mining engineer, a broker, and also editor of the Montana Natural Resource Bulletin.

(RADIO NEWS invites the secretaries of radio clubs to send in descriptions of the activities of their bodies, along with photographs of their club rooms and stations. If the material is interesting and contains suggestions and ideas that other clubs may apply to good advantage, it will be published.)

RECORDS ACROSS THE PACIFIC

"HELLO, Hawaii! How are ye? This is 7XF at Seattle in the 'Charmed Land,'" says Neil Brown, station operator at 7XF, experimental station at Seattle. "I am using only a 100-watt transmitter with Simpson-circuit arrangement. Do you hear me?"

"I hear you clearly and I like your voice" says OH-6ACG, replying in code from Honolulu across nearly 3,000 miles of the Pacific.

Thus it goes between Seattle and Hawaii since their recent establishing of communication by wireless telephone and code. Some half-dozen stations in the islands are participating in these experiments and wonderful results are being attained, even in spite of some very severe cyclonic storms which have been sweeping the sea near the islands.

7XF, which sends on 38 meters, is located at the water's edge on the Grand Trunk Pacific dock; with two 75-foot masts on the roof and antenna 150 feet above the water.

(Continued on page 290)

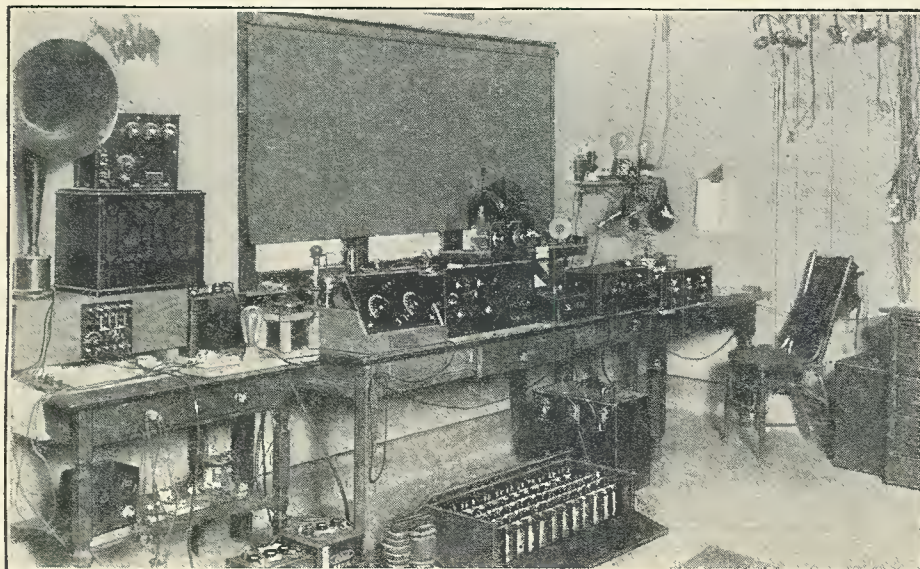

Splendid equipment with which the Butte Radio Club works and plays.



Working on Seven-Foot Waves

A Description of German Experiments Using a Frequency of 141,400 Kilocycles



By H. E. HOLLMAN and H. PETERS

INVESTIGATIONS of high-frequency transmission, on waves as short as 2.12 meters, are now being carried on in the Physical Institute of the Technical High School of Darmstadt, Germany. Because the transmitters used in this research work are of rather simple—if unusual—construction, this general description of them will undoubtedly interest amateur experimenters and students of radio.

A short-wave set, designed to operate on the band between 10 and 20 meters, is pictured in Fig. 1. Two German tubes, of a model known as "RS5," are employed in the circuit (Fig. 2.) The components of this transmitter are few, consisting merely of a heavy copper ring about ten inches in diameter, a single variable condenser, CV, two small fixed condensers, C, and three radio-frequency chokes, RFC. Plate voltage is obtained from a D.C. motor generator, and filament and grid voltages from storage batteries.

DESIGN OF TRANSMITTERS

The oscillating circuit is of a balanced

current, they permit the "C" battery to bias the grids of the tubes properly, and at the same time they prevent a short circuit, to the filament, of the R. F. energy produced in the oscillatory circuit.

The frequency of oscillation (and hence the length of the radiated wave) is determined by the inductance value of the single copper ring and the capacity of the variable condenser, CV, across which it is connected.

The plate voltage is impressed on the transmitter at the neutral point of the copper ring (the exact top), through an open spiral of wire which acts as an R.F. choke and prevents the R.F. energy from surging back through the generator and milliammeter, MA. The "RS5" tubes used in this transmitter draw about 100 milliamperes at a plate potential of 1500 volts; this represents a load of 150 watts.

A 7.05-METER TRANSMITTER

Another interesting laboratory transmitter, which works on a wave of 7.05 meters, and is used principally for the study of wave-progress through the atmosphere, is shown

in Fig. 3. It employs two "RS228" tubes, which operate at a plate voltage of 220.

This transmitter is set up according to the diagram of Fig. 4. There are two copper rings, connected in the grid and plate circuits and tapped at their neutral points to form a double oscillating circuit. The inner (plate) ring is a piece of stiff copper tubing, the outer one (grid) of heavy wire curved into a circle an inch greater in diameter. As can be observed from the illustration, the rings are separated by three insulating studs, placed about 120 degrees apart. They terminate at a rubber mounting-stand, the ends of the inner ring going directly to the terminals of the variable condenser, CV, and the ends of the other to the grid pins on the tubes. The latter protrude from the sides of the mounting frame holding the condenser and rings; in this position they permit the use of extremely short connections.

The grid and plate voltages are applied through loose spirals of wire, which act as R.F. chokes. These coils are plainly visible in Fig. 3.

The plate circuit fixes the wavelength of
(Continued on page 256)

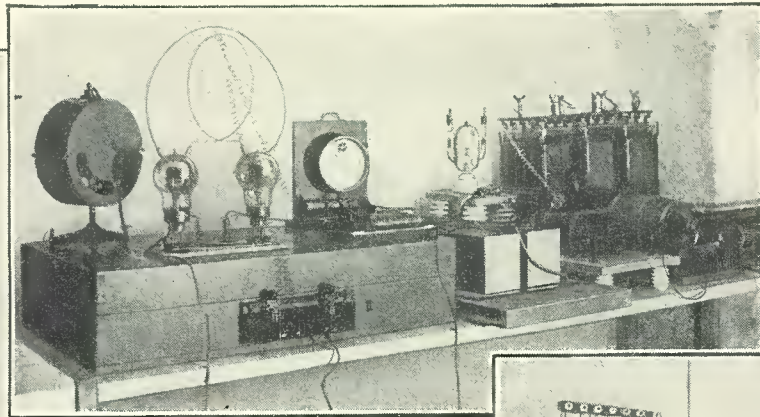
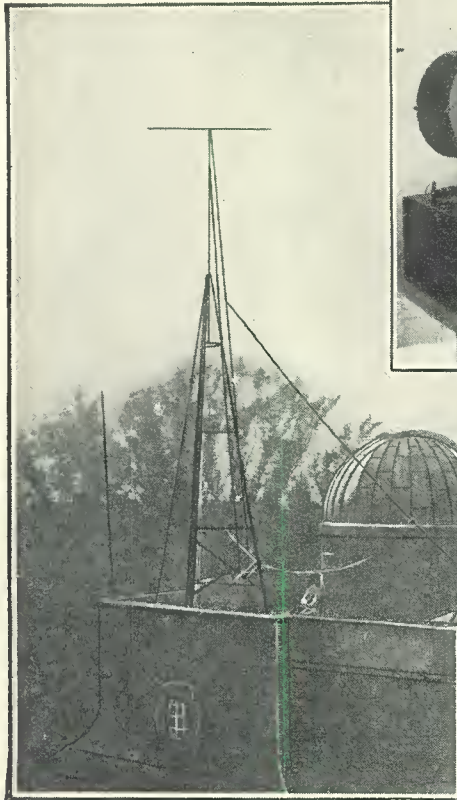

Fig. 6, at the left, shows a transmitter which is designed for operation on 2.12 meters. The circuit diagram for this set is given in Fig. 7, found on page 256.

Fig. 5, at the left, shows the antenna system, the horizontal portion being telescopic, for use on different frequencies. The transmitter is in the cupola.

Fig. 3, below, is a transmitter designed to operate on 7.05 meters. The circuit diagram, Fig. 4, will be found on page 256.

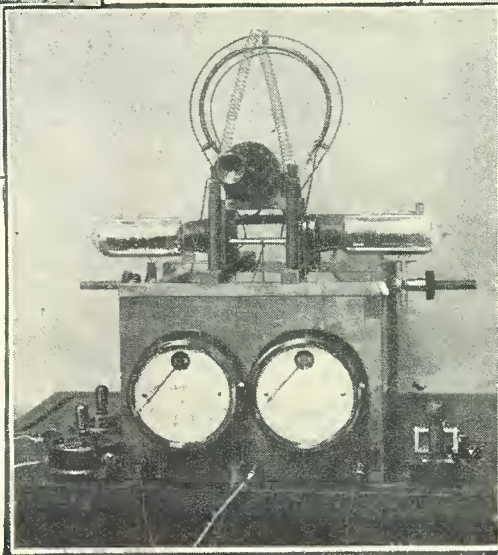
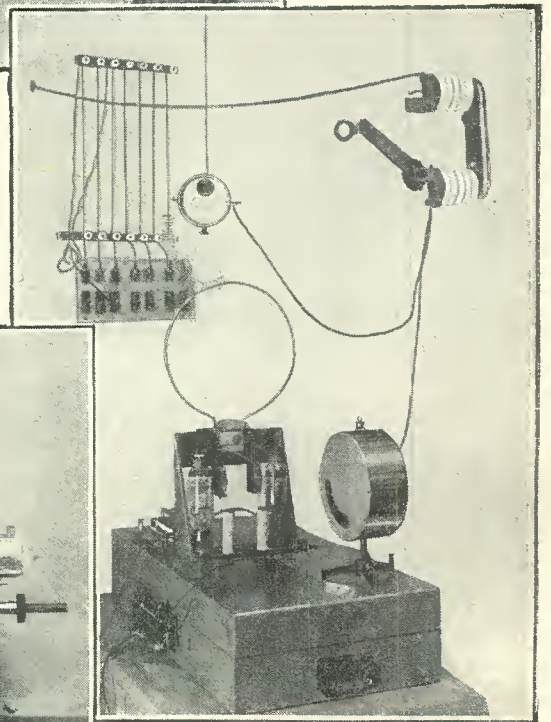
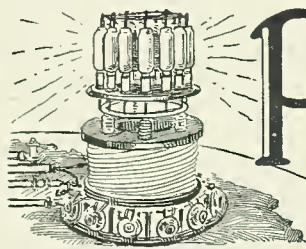

Fig. 1. Above is shown the short-wave transmitter for operation on wavelengths between 10 and 20 meters. See Fig. 2 for its circuit diagram.

type, as can be seen from Fig. 2. The plate-to-grid feed-back coupling necessary for the production of oscillations is obtained by the cross-connection of the condensers C. These are mounted on the wooden framework of the transmitter, between the two tubes and just below the ends of the copper ring.

The two choke coils in the grid leads to the "C" battery are mounted on the bottom of the framework, between the bases of the tubes. They consist of 300 turns of fine wire (about No. 26) on a rubber core one inch in diameter. Possessing a low resistance to direct current and high resistance (or, more properly, "impedance") to high-frequency alternating



Progress in Radio

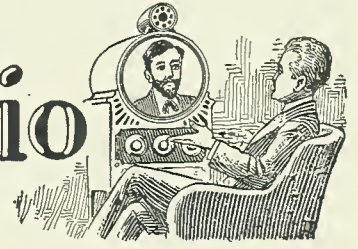

THE "SULFOTRON" RECTIFYING VALVE

AMERICAN radio fans who have been following the development of heavy-duty rectifying devices for supplying "A" power to receiving tubes from the house-lighting circuit may be interested in the "Sulfootron," a new invention of Lucien Lévy, the prominent French radio engineer. It is an electro-chemical rectifier and takes the form of a snub-nosed cartridge, about an inch in diameter and three inches long. It passes a current of one ampere, and thus is capable of supplying enough current to operate four standard ¼-ampere tubes in parallel. Parallel connection of two or more such rectifiers, in suitable circuits, obviously will furnish heavier currents for sets employing a greater number of tubes.

CONSTRUCTION

This "valve" is made of a hollow body of aluminum, fitted at the bottom with a standard screw-type lamp base. The lower end, where the base is attached, is sealed by an insulating screw stopper. The upper portion, which is threaded on the outside, is covered by an aluminum cap which makes the device look like a small shell or projectile.

The bottom stopper is pierced by an aluminum rod which enters vertically into the cylindrical cavity in the body. The upper end of this rod bears against the end of a similar pencil of copper, which is centered in a bar of aluminum passing through a hole drilled in the vertical axis of the hood. By means of a coiled spring, the facing ends of the aluminum and copper rods are kept pressing against each other in the interior of the valve.

(See accompanying cross-sectional drawing.)

The hollow portion of the cylindrical valve is filled with a sulphurous liquid, which is confined to this chamber by an India-rubber washer, fitting between the joint made by the cap and the body. The entire valve is further protected by an outer hood which covers the whole assembly.

The sulphurous liquid is a specially prepared solution of ammonium sulphide. In the sulphurous atmosphere which this chemical creates, the copper rod soon becomes covered with a conductive coating of copper sulphide.

ACTION OF THE VALVE

When the copper is the anode (positive) it takes up more sulphur, and the current

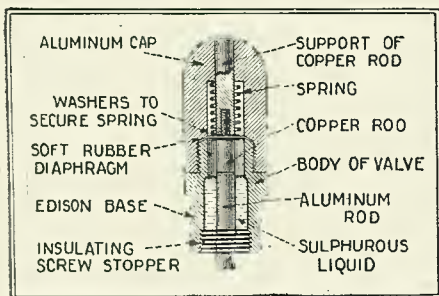

The internal construction of the "Sulfootron" rectifying tube, showing the location of the various parts, as explained in the text.

encounters only a negligible resistance in passing through the valve. The contrary is the case when the aluminum becomes the anode, for an insulating film of aluminum sulphide forms around it. Under these conditions (and we must remember that the electric currents traverse the surface of the conductors) it will be seen that the valve favors the copper-to-aluminum path, while on the other hand, the aluminum-to-copper path presents an almost infinite resistance.

What is especially surprising is that the physico-chemical phenomena which come into play can be produced in synchronism with the frequency of the alternating current which is being rectified, at the rate of 120 times a second (for a frequency of 60 cycles).

This shows very clearly that we are dealing with phenomena of a physical, or more precisely of an electronic nature. It is impossible that at each change of polarity of the metal pencils, a chemical reaction of the two bars, in the proper sense of the word, should take place. The chemical phase of the phenomena indicated by the existence of a sulphurous atmosphere must be taken as a role of pure catalysis—a simple surface action. However all this may be, the rectifying action is absolutely perfect.

The sulfootron valve rectifies a current of the order of one ampere, with a very trifling fall of interior potential. Its efficiency is rated at 80% to 90%. The life of this rectifier is about 300 hours. The device can be renewed after this length of service, however, by the simple replacement of the solution and the rods.—René Brocard.

A STABLE RADIO-FREQUENCY AMPLIFIER

THE R. E. Manufacturing Co. and B. Phelps describe in a British patent a form of stable radio-frequency amplifier

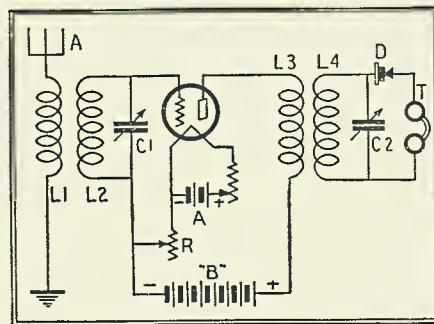

The circuit diagram of the new R. F. amplifier.

which is stabilized by coupling back a certain proportion of the potentials produced in a plate circuit into a grid circuit by means of a resistor. The inductance L1 is coupled to a closed grid circuit comprising an inductance L2 tuned by a variable condenser C1. The plate circuit contains the primary winding of a radio-frequency transformer L3, the secondary L4 being tuned by a condenser C2. The amplified potentials produced across this circuit are rectified by a crystal detector D in series with the usual phones T. Instead of connecting the negative pole of the "B" battery and the lower end of the grid circuit directly to the fila-

ment, connection is made through a resistance R.

Since this resistance is included in the plate circuit, a portion of the potentials occurring in the plate circuit will be produced across it. But as this resistance is in the grid circuit of the tube as well, the same potential will be applied to the grid. But it must be remembered that the voltages occurring in the plate circuit are of opposite phase to those in the grid circuit which cause the production of the potentials in the plate circuit. Hence the function of the resistance will be to lower materially the overall amplification of the tube.

Thus, supposing there is sufficient stray inter-electrode coupling, or stray magnetic coupling, to cause the tube normally to generate continuous oscillations; by suitably adjusting the value of this resistance it is possible to introduce into the grid circuit voltages which will counteract those tending to maintain the generation of oscillations.—Wireless World, London.

A RESILIENT TUBE SOCKET

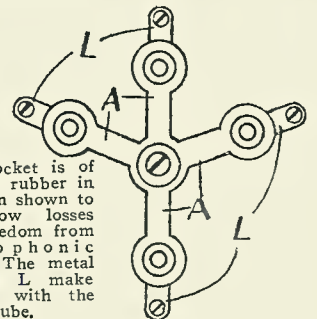

This socket is of resilient rubber in the form shown to give low losses and freedom from microphonic noises. The metal lugs at L make contact with the tube.

IN the invention of Charles Jeffrey Layne, of Charlton, London (British patent 268,118) a tube socket is moulded of rubber or similar insulating and resilient material in cruciform shape. As shown in the diagram, the socket has a hole for the securing screw through the junction of the arms A, and the tube prongs fit into other holes located at or near the ends of the arms. The ends of the arms are slotted in a plane parallel to the upper and lower surfaces of the holder, to communicate with the socket holes, and metal lugs L are fitted as shown. The lugs are bored to allow the contacts to pass through them. These are either screwed or are a driving fit; so that when the prongs are fitted into place they are held securely by the lugs. The outer ends of the lugs are provided with terminal screws, and the central screw hole is surrounded by a projection to space the main part of the socket from the panel and thus give greater resiliency in mounting.—Wireless Trader, London.

RADIOACTIVE BATTERIES

AN English experimenter has been successful, *The Broadcaster* (London) states, in producing a high-voltage dry battery whose efficiency is materially increased by the use of layers of radioactive material between the plates. It does not appear that the article has reached a commercial stage, nor what the cost of its construction may be; though its life is stated to be long.



A New System of R. F. Amplification



A Description of a Set which Gives Equal Amplification Over the 200-500 Meter Band

By F. A. JEWELL

ONE of the most interesting circuits that has lately been brought to our attention is described in the accompanying article. This circuit was developed by the author, who has written for previous issues of RADIO NEWS several articles describing some of his other inventions. In this receiver the radio-frequency amplifier is so designed that it gives equal amplification over the entire broadcast waveband, and the audio-frequency amplifier provides excellent amplification without distortion. In a forthcoming issue of RADIO NEWS, an article giving complete data for the construction of this set will appear.—Editor.

THE receiver described in this article is the result of an attempt to take the fundamental vacuum-tube circuits as they are given to us—for it is clear that all such circuits possess similar characteristics—and try to get the most out of them. The value of the vacuum-tube circuits in radio receivers is, it is well known, greatly enhanced by the employment of regeneration; but, in most of the receivers thus far developed, it has not been possible to utilize this effect to a uniform degree over the whole range of frequencies to be received.

For instance, in many receivers where regeneration is employed, and where adjustments are so made that oscillations will not be established in the circuits, great sensitivity results when the receiver is tuned to the higher frequencies, but it becomes comparatively dead when tuned to the lower frequencies. In other receivers, where special methods have been employed to suppress oscillations, other than the usual "losser" methods, just the reverse has occurred.

REGENERATION CONTROL

The first distinctive feature of this circuit is embodied in the radio-frequency amplifier, so we will discuss this feature first. Regeneration is obtained in vacuum-tube circuits in two ways, and it is by the combination of these two methods that a uniform degree of regeneration is obtained in this circuit. The first of these methods is that of allowing feed-back from the plate to the grid circuit through the inter-electrode capacities within the tubes. The other method is that of allowing feed-back of power through the coupling between a tickler coil and the tuning coil in the grid circuit.

The fundamental arrangement of the circuit is shown in Fig. 1.

L1 is the tuning coil; connected and coupled inductively to it is another coil, connected also through a blocking condenser C1 and radio-frequency choke coil RFC to the plate circuit of the tube. This is the portion L2 of the coil. In the plate circuit of the tube we have the usual inductance (L3) for coupling this stage to the one following. It will be noted that a variable resistance, R, is connected in series with the "B" battery. This resistance plays a very important part in the adjustment of the receiver.

Now, let us analyze the operation of this radio-frequency amplifier and, at the same time, learn the method used in making the necessary adjustments for stability and uniform sensitivity. Let us suppose that the

condenser C is tuned to a high wavelength, say 500 meters. But first let it be understood that, if the radio-frequency choke coil is short-circuited, the system will oscillate continuously over the whole range of frequencies to be received.

Now, when the condenser is tuned to the longer wavelengths, or the lower frequencies, the feed-back from the plate to the grid circuit is less than it is when tuned to the shorter wavelengths, or higher frequencies. So when C is adjusted to say, 500 meters, if the resistance R is increased gradually, a point will be found at which oscillations begin. Let us note the value of the resistor R at this point. Since R acts as a partial short-circuit around the feed-back coil, L2, by increasing this resistance it is made less of a short circuit. Or, take another way of looking at the matter; there are two paths in the plate circuit over which the feed-back current may flow. One of these paths is through RFC and the condenser C1, and then to the coil L2; and the other path is through the resistance R directly to the filament. The feed-back current through R produces regeneration mainly through the tube capacity. At long wavelengths, the feed-back through the tube is very small, so that it has little influence on the regeneration; but by increasing R the

again and the setting of R is again marked. The happy medium between the two values of the resistance R is obviously about half way between the two marks, so that, at that point, the regenerative effect will be very uniform over the whole frequency range.

DETERMINING CORRECT INDUCTANCE

The action of the circuit depends very strongly upon the value of the choke coil RFC. Suppose we start making our adjustments with a very large choke coil in the circuit. It may not be possible to make the circuit oscillate on the longer wavelengths (by increasing R) when the choke is too large, because it will keep the feed-back current out of the tickler coil. But let us gradually reduce the inductance of the choke in steps; at each step making the adjustments described above.

When the choke has been reduced sufficiently, it will be possible to make the circuit oscillate at the longer wavelengths. At the same time the tendency to oscillate will be also weak on the short wavelengths; for, in order to create oscillations on the long wavelengths, we have to increase R so much that little feed-back is permitted through the tube capacity.

But, as we reduce the R.F. choke more and more, it will be found that it becomes easier and easier to create oscillations at both the high and low ends of the frequency range. At each step, as we reduce the R.F. choke, the distance between the two points on the resistor at which oscillations are produced becomes shorter and shorter. In other words, we increase R, when tuned to the long wavelengths, until oscillations begin, and make a mark on the resistor. Then we tune to the short wavelengths and decrease R until oscillations begin, and make another mark. The distance between these two marks becomes smaller and smaller as the R.F. choke is made smaller and smaller.

Finally, when the choke is made small enough, the two points come together; and just before this condition is obtained we have the R.F. amplifier working at its best. The regeneration, and hence the R.F. amplification, is the greatest possible over the whole scale, and the amplifier operates just on the verge of oscillation.

Obviously, there is no sense in making the choke any smaller than the critical value. If we were to do so, we would find that the two regions of oscillation would overlap, and it would not be possible to make any satisfactory adjustment of the receiver. The success of the receiver depends upon the values of the different parts—of the R.F. choke, the blocking condenser, the resistor, and the number of turns on the coils. If the set builder were to start out to design a receiver of this type, it might take quite a long time before the happiest combination

(Continued on page 272)

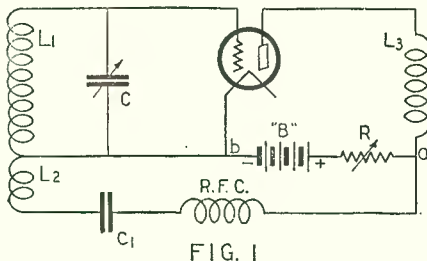

FIG. 1
The fundamental circuit diagram of the R.F. stage which is the heart of the set.

potential of the point a is increased with respect to that of the point b. Thus feed-back current is forced to flow through RFC and into the tickler coil, L2. So, on the longer wavelengths, the lack of feed-back through the tube is compensated by tickler feed-back in L2.

Now let us tune the condenser C to a short wavelength, say 250 meters. At the short wavelengths, or higher frequencies, the feed-back through the tube is comparatively strong; but, with the resistance R set at a high value, this current is not able to pass through R and produce the regeneration which we want. So when C is tuned to the shorter wavelengths, the resistance R is decreased gradually until oscillations begin

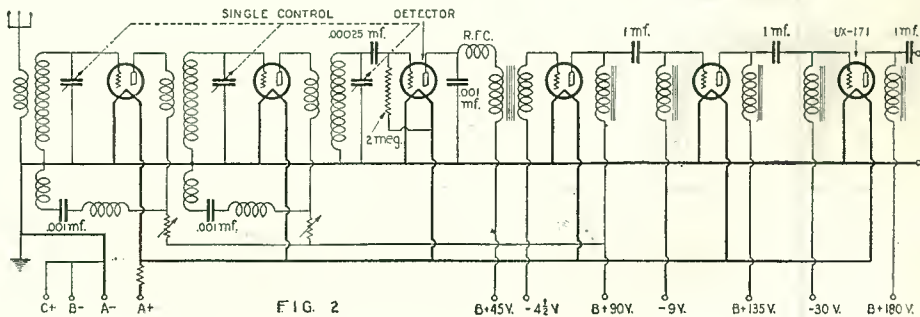

FIG. 2
The complete circuit diagram of the author's receiver.



Rectifying with Metallic Detectors



A Resume of Experiments Using Unusual Forms of Non-Crystal Rectifiers

By Prof. H. PELABON*

THE detection of electro-magnetic waves can be carried out through the means of a contact between two metals separated by a very thin dielectric; provided the thinness of the dielectric can be kept sufficiently constant by placing insulating particles between the two metals. It is possible to solve this problem of detection in another way, and in this article is described an apparatus which has served the writer for rectifying radio waves by means of metals placed in direct contact with each other.

The first experiments were made with the highly resistant contact between a spherical surface and a plane. The principle of the apparatus, shown in Fig. 1, is very simple. A conducting sphere is balanced on three points *a*, *b* and *c*, the last movable. The sphere was a chrome-steel ball-bearing 50.8 mm. (2 inches) in diameter and weighing 535 gms. (17 ounces). The insulating (bone) points were 1.5 mm. (1/16-inch) in height and imbedded in the brass plate *P*, which is shaped as illustrated. By means of the screw *V*, moved by the gear *r* meshing with another gear *R*, the plate *E*, carrying the point *c*, can be moved very minute distances. Calculations show that, under these conditions, a displacement of 1-mm. (1/25 inch) of any point on the circumference of the wheel *M*, produces a variation in distance of the two conductors (one the sphere and the other the plate) which is in the order of .000001-cm. (1/2,500,000-inch).

TESTS WITH VARIOUS METALS

Later this apparatus was modified by attaching flat springs to the plate *P*, so that plates of different metals could be substituted below the sphere. The bone points were also discarded and grooves containing tempered small, flat spring strips were provided to receive small rods of quartz or glass, indicated at *a* and *b* in Fig. 2. The advantage of this arrangement was that it enabled us to vary the size of the triangle *a-b-c*, and also the thickness of the wedges inserted. Under such conditions, the possible variation in the size of spheres is not restricted within such small limits. The experiments can be varied by using balls, of the same size, which have been electroplated with gold, copper, or nickel.

Another method of experimenting with the sphere-and-plane detector consists of compressing an insulating ring *a* (Fig. 3) between the spheres and the plate *m*, by means of the screw *V*. The action of the

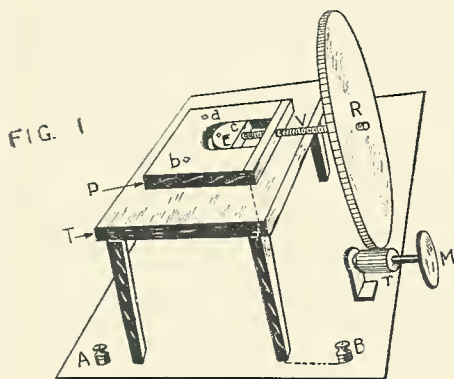

The apparatus for conducting rectifying experiments between a spherical surface and a plane. By means of the wheel *M*, as explained in the text, the distance between the sphere and plate can be regulated to less than a millionth of an inch.

apparatus can be clearly seen from the sketch.

Detection by two spheres in contact can be carried out quite easily by means of the apparatus shown in Fig. 4. The sphere *B* is suspended from the screw by means of a thin copper wire *b*; the distance between the two spheres *A* and *B* can be varied by adjusting *V*. The wire *a*, soldered to *A*, passes through an eye *R*, and is then attached to the terminal *M*. The terminal *N* is in electrical contact with the screw.

RESULTS OF TESTS

Fig. 5 is a schematic diagram of the hook-up used in these experiments.

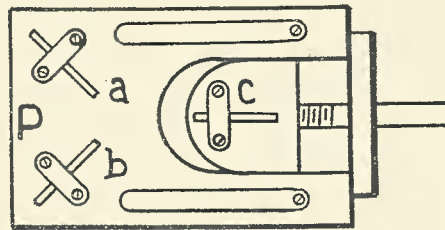

FIG. 2

A modification of the plate, *E*, in Fig. 1; showing quartz or glass strips at *a*, *b* and *c* instead of points.

In the tests with sphere and plane of the same metal, a steel ball-bearing was placed upon the three points *a*, *b*, *c*, of the steel plate *P* (Fig. 1). When the sphere was brought nearer to *P* a buzzing persisted as long as the distance of the two conductors exceeded a certain limit, which will be called *D*. As soon as this limit was reached it was possible to pick-up radio transmission. The intensity of the signal passed through a maximum and then decreased; reaching complete silence when the conductors were at a very small distance *d* from each other. The thickness of the zone of detection is then $D-d$. From numerous experiments it seems that this quantity, $D-d$, is in the order of .000001-cm. (1/2,500,000-inch). This system of detection is quite stable, giving very good results.

On substituting for the steel ball-bearing, gilded, silver-plated and other spheres and depositing on the plate *P* films of corresponding metals, detection could always be produced; but with varying stability. Silver, gold and nickel act in practically the same manner; but with them detection is attained with more difficulty than with steel. Copper, used in the same way, is a very poor detector.

In all cases the direction of the current is from plate to sphere. It is possible to vary the intensity of the sound received, through establishing a difference of potential between the two electrodes by means of a potentiometer. If this difference of potential is of the same polarity as that which corresponds to the rectified current, the loudness of the sound is materially increased; if it is of opposite polarity, the intensity is diminished.

In this last case, if the potential difference given by the potentiometer increases in value, the intensity of the sound becomes practically zero for a certain value, *V*; then we hear signals again with increas-

ing intensity as the potential difference continues to increase. It is impossible in either case to exceed the limit without hearing a continuous buzzing. The value *V*, which gives silence, is in the order of 1/100-volt.

BETWEEN DIFFERENT METALS

When the sphere and plane are of different metals, and using the apparatus shown in Fig. 2, the direction of the current after rectification is from sphere to metal, which is the opposite of the results quoted above. The metals used which gave good reception are lead, tin, aluminum, cadmium, platinum and palladium; metals which gave unstable reception are gold, silver, zinc and copper. In each case a steel sphere was used.

In the case of rectification between two spheres with the apparatus shown in Fig. 4, if the spheres are of the same material and if they vary in diameter, the current usually goes from the larger to the smaller. When the spheres are of different metals the rectified current goes in the same direction, if thermoelectric coupling gives the same polarity; but, in the contrary case, the direction is very uncertain. As in the preceding experiments, it is possible to control to a certain degree the intensity of the sound, by using an auxiliary electromotive force.

When the spheres are of the same diameter and the same material, the system is then symmetrical, at least in appearance. With two steel balls 3 cm. (1 1/5 inches) in diameter suspended as in Fig. 4, broadcast signals from the Eiffel Tower were received very distinctly. A similar result was obtained on the same day by M. Cuyrel, of Bordeaux, with two identical gold rings. However, although these two spheres appear to be identical, they may not be really so. For instance, the adjacent surfaces may have somewhat different radii of curvature, and the composition of the steel may not be absolutely the same in both cases.

The writer has succeeded, nevertheless, many times in producing a symmetrical detector by placing one of the balls on top of the other and in varying the points of contact by rotating the lower sphere in its support. This condition is characterized by

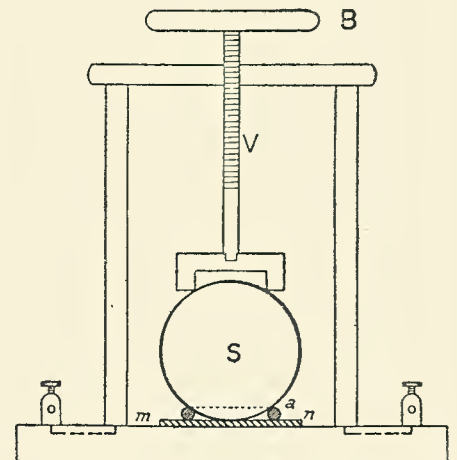

FIG. 3

Another piece of apparatus for determining the rectifying action between a sphere and a plane surface. The section *a* is a ring of elastic material.

*Faculty of Sciences, Lille University, France.

the fact that there is no sound as long as each conductor has the same potential value; but there is a response as soon as a difference of potential in either direction exists between the two spheres.

A METAL'S ATMOSPHERE

Before going any farther, it might be interesting to explain the mechanism of detection. It is due to a passage of electrons from one of the conductors to the other; a passage which is easier in one direction than in the other. In the electronic theory of metals it is premised that a metallic body contains, per unit of volume, free electrons of a number which depends on the nature of the metal. These electrons act like the molecules of a gas; that is to say, they are characterized by irregular movements in every direction, and their mean velocity is very high because their mass is very small.

Suppose that a metal A at some particular temperature contains N_a electrons per

the temperature. There exists, therefore, over the whole surface of A an "atmosphere," composed of electrons whose density

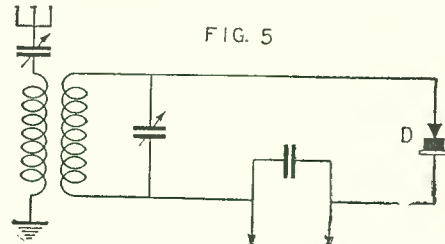

Diagram of the simple circuit which was employed in these experiments.

is a maximum at this distance d . This density should evidently be greater in proportion as the number of free electrons N_a is increased. Physicists agree in attributing a thickness in the order of .000001-cm. (1/2,500,000-inch) to this layer.

For a different metal B similar conclusions can be reached, to show that its surface should be covered by an electronic layer of the same thickness but of different density. This is true because the second metal B contains, per unit of volume, a number N_b of free electrons which differs from N_a . Now, let us suppose that these two metals are arranged as shown in Fig. 6, their plane surfaces facing each other and parallel, and that the distance between them is gradually diminished. An instant will come when the electronic layers in motion will touch each other and then, in the writer's opinion, detection becomes possible. Everything goes on as in a vacuum tube, with this exception; in the vacuum tube the atmosphere of electrons must be driven away from the filament by raising its temperature. The main difficulty in the case of the two spheres is to maintain a constant distance between the two conductors, but this problem has been solved.

If the comparison of the metallic detector and the vacuum tube can be sustained, it should be possible to find the direction of the rectifying current. This current should go from the conductor which is poorest in

free electrons toward the one which possesses the most; at least if the facing surfaces are planes.

It is impossible to ascertain any numerical values for N_a and N_b . However, the electron theory leads to a formula which gives the ratio of these two numbers as a function of the thermoelectric *emf* of a couple formed by the metals under consideration. The ratio of the numbers of free electrons also varies with the specific conductivities of the two metals. If we consider, for a given temperature, the length of the free mean path traversed by the electrons to be independent of the nature of the metals, we will find that the ratio of the two conductivities is equal to the ratio of the numbers of free electrons in an equal volume of each metal.

If we consider the active surface of the sphere used in our first experiment as a plane, it will be found that the experimental

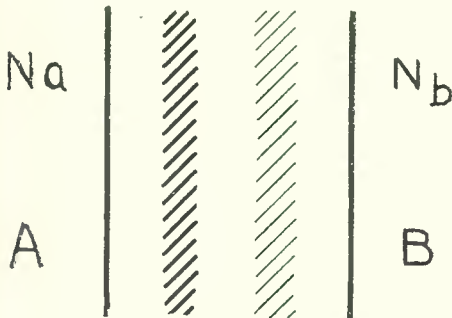

FIG. 6

An illustration depicting the "electronic atmosphere" surrounding two surfaces used in these experiments. The distances, however, are almost unimaginably small.

unit of volume; let us consider what occurs on its surface. Some electrons escape; but, as their departure creates a field of force which draws them back, they cannot travel far. Most of them return after having traversed a distance d , which depends upon

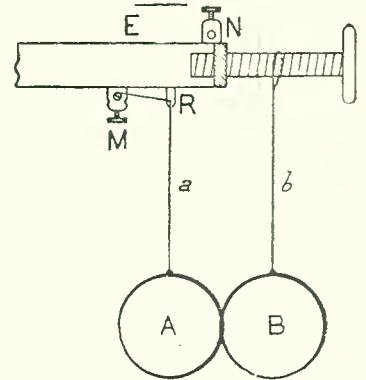

FIG. 4

The apparatus used to bring together two spherical surfaces for these detector experiments.

results are sufficiently in accord with the theoretical conclusions; at least when we are dealing with bimetallic couples which have an appreciable thermoelectric *emf*.

(Adapted, with illustrations, from "L'Onde Electrique," Paris.)

Obtaining Accurate Voltage Readings

Use of a Current-Flow Meter in Testing Batteries

By G. F. WALKER

A COMMON statement of the radio fan is that his batteries are delivering full voltage. How does he know? He tested them with a voltmeter and that read 45 volts; so he thinks they must be "up." Yet his set and tubes may be out of order and he assures the service man that his aerial and ground are intact—well soldered and insulated. What, then, is the real cause of this fan's grief? His batteries!

There is a law of electricity which states that when there is no current through a device, "its electromotive force (voltage), and terminal potential difference are numerically equal." (Pender,—"Electrical and Magnetic Circuits"). This means that the electromotive force (*emf*) delivered depends upon the amount of current flowing through the device—be it a battery or other form of "electrical pump."

EFFECT OF LOAD

If the current flow through the device is almost zero, the *emf* and the voltage-drop across its terminals will be equal. If, on the other hand, a load-drawing current is thrown across the electrical pump, the *emf* delivery will be found to differ very much from the voltage drop, across the terminals of the pump, in very many cases. This is illustrated by a concrete example.

In this case, a laboratory potentiometer was used. This instrument measures the voltage drop across the terminals of an electrical pump when no current is flowing through that device. This arrangement is shown in Fig. 1. A is a standard cell which delivers a constant open-circuit voltage of 1.0183. A1

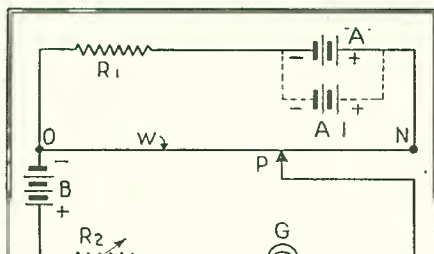

FIG. 1

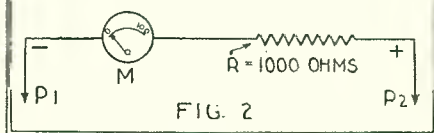

FIG. 2

Fig. 2 shows the voltage on load. Two methods of making voltage measurements.

is a cell of unknown circuit voltage which may be substituted for A. R1 is a protective resistance which may be cut out when making fine adjustments, where current flow is almost zero. B is a battery of somewhat higher voltage than A. The current delivery of B is regulated by R2. G is a sensitive galvanometer or current-flow indicator, capable of detecting currents measured in microamperes. W is a wire of known resistance, along which a sliding contact P moves.

In operation, the slider P may be moved along W until G shows no deflection; or P may be set at a given point while R2 is regulated until G shows no deflection. In either case, the current flow from "A—" to P is exactly equal and opposite to the current flow from "B—" to P, and the voltage drop from "O" to "P" is exactly 1.0183 volts. Now an unknown cell A1 is substituted for A, and the slider P is moved until G does not deflect. The ratio between the original settings of P and the new settings, multiplied by the voltage of the standard cell, gives the open-circuit voltage of the unknown cell. There is no current flow in the circuit.

DECEPTIVE VOLTAGE READINGS

On this instrument, a 1.5-volt cell was measured and the open-circuit voltage was (Continued on page 289)



Correspondence from Readers



TOURING WITH PORTABLE SETS IN GREAT BRITAIN

Editor, RADIO NEWS:

With reference to your letter of May 6, I am directed by the Commissioners of Customs and Excise to inform you that a person resident abroad who intends to make a temporary visit to this country and who brings with him a portable wireless receiver in baggage for his own use would be allowed to import the receiver on deposit of duty for refund on re-exportation within six months or, in certain circumstances, without payment of duty. All articles liable to duty should, of course, be properly declared and produced to the customs and excise officers at the port of importation.

I am, Sir, Your obedient Servant,
R. D. DAVIS,
Office of The Secretary, Custom House,
London, E. C. 3., England.

RADIO IN JAPAN

Editor, RADIO NEWS:

To my note which you published in the April, 1926, issue of RADIO NEWS (page 1448, asking for American correspondence) I have received over fifteen hundred letters and cards from all over the globe. No wonder that the postman did not smile to me for several days! It is absolutely impossible for me to send them all a reply, so I am taking this method of reply; and sending herewith photographs of the leading Japanese station, JOAK, Tokio. (These appear in the rotogravure section of this issue.—EDITOR.) Its staff are exceedingly courteous, and glad to send verifications to American listeners.

Most Japanese listeners use a crystal set. Tube receivers commonly utilize two-tube reflexed circuits, with a loud speaker; though there is a considerable number of five-tube neutrodynes and super-heterodynes in the country. Parts are commonly of Japanese make, although for the finest quality of reproduction, the best American makes are preferable. Japanese vacuum-tube manufacture has been greatly improved. Aerial masts are commonly of bamboo here.

Broadcast listeners are required to pay three yen (approximately \$1.50) quarterly, for the privilege of listening to the programs, which are splendid. I am very sorry to put the "hams" in second place, as I desired especially to correspond with them; but over eighty per cent. of the letters I have received are from B.C.L.s.

It may interest my correspondents to know that I am a Canadian, having been born in Vancouver. I wish to thank all who have written me, and wish them success. For the hams: CUL, best DX and 73. SK.

FRED IWATA,
30 Azahara, Takigashira Machi,
Yokohama, Japan.

ON BEHALF OF THE SPONSOR

Editor, RADIO NEWS:

Permit me to compliment you on the stand you have taken in publishing the article on page 15 of your July issue, "The Fly in the Ointment."

I have no connection, direct or indirect, with any broadcaster or sponsor of a broadcast program; yet I am struck by the simple justice of the arguments presented by the

author of this article in "presenting the case of those who entertain the radio audience—gratis."

I might add that your policy in this respect is in refreshing contrast to that of another radio monthly, with its high-and-mighty "These-stations-must-go" and "The-public-vigorously-resents-their-existence" twaddle.

Respectfully,

G. I. RHODES,
735 West Broadway, Long Beach, Calif.

RESPECT FOR THE CLASSICS

Editor, RADIO NEWS:

I am writing you, not alone as a constant listener-in to the best which is coming to our dials, but as one who gets much pleasure from study of programs and radio itself, and as a reader of RADIO NEWS as well. I am not in the least in sympathy with those who would "gag" radio broadcasting or censor programs other than that they may all "come clean"; but there is one type of program which I would like to bring to your attention. Although I have one particular sponsored feature, one particular station as well in mind, this is not confined to any particular station or any particular sponsored program.

I shall speak of one specific case, although violations are frequent, and that is the broadcast of a certain sponsored program, from a certain station, the selection being that classic of classics "O Sole Mio." It was agony to hear these words interwoven with words advertising the products of the sponsors, interwoven in such a way as to cause laughter to those who do not appreciate the beauty of this selection, vocal or instrumental; just one effort to "be funny" which fell flat as regards the writer.

Of course, this type of program may be allowable, and I do not refer to the so-called "parodies," for many of them are actually beautiful and but create a taste for the original. But is the scope of music, vocal and instrumental, not sufficiently broad to eliminate any desire to "murder," and hold up to ridicule such classics, even though the standpoint be that of pride in music's best and nothing else?

Sorry to take up your time, but I feel that this criticism is in a line of construction, and that seems to be one outstanding feature of RADIO NEWS. Do I enjoy-it? Well, if I did not, I would be foolish to read it each month from cover to cover; for it sure is in line with radio advance along practical lines.

H. V. PETTIBONE,
4 Clinton Street, Worcester, Mass.

COMPETITION IN DX

Editor, RADIO NEWS:

In the "Correspondence from Readers" section of your good magazine, issue of July,

is noted a letter from a Mr. F. C. Staves of this city, who offers to post immediately in any bank in the city of Des Moines a certified check for \$500, payable to the "fellow" who can show him a set which will out perform his eight-tube Victoreen.

The immediate reference to myself in the succeeding paragraph of his letter, on account of my published results with Browning-Drake, causes me to declare that "I seen him first."

I accept this challenge and await this gentleman's formal statement to RADIO NEWS that his certified check is posted in the Iowa National Bank of this city, made payable to the writer with the understanding it is to be turned over to myself if a committee of three decide that I have a set which will outperform his eight-tube Victoreen in distance, volume, selectivity and quality.

The above committee to be composed of one judge appointed by myself, one by Mr. Staves and the third by the two judges then chosen; and that the test shall be made in our own homes as we operate our sets on two or three nights' tests.

Awaiting Mr. Staves' formal announcement through RADIO NEWS of his posting this check, I am, yours very truly,

T. G. MANN,
1703 Mondamin Ave., Des Moines, Iowa.
(We are since advised that Messrs. Staves and Mann have failed to agree upon terms. Any more DX competitions?—EDITOR.)

AUSTRALIA ON FOUR TUBES

Editor, RADIO NEWS:

Being a constant reader of your most valuable magazine, I pen these few lines, hoping it will not take up too much of your time. In the July issue I came across a very humorous letter written by Mr. Staves, of Iowa.

Speaking of DX reception, I might say that I have a home-made set of four tubes—a regular haywire set. I have logged Australia fifty times since Nov. 6; have written verifications from the government station at 4QG, Brisbane, 3LO, Melbourne and 2BL, Sydney. I have logged Japan twice and I am now waiting for a reply from Bombay, India. I am talking DX; other stations on my list consist of the Philippines and Honolulu.

Well, Mr. Staves, I wish you were here to read these letters; they would give you a thrill. I don't know whether I am in line for that \$500; but, anyway, keep on trying—you'll get there. Lots of the DX fans can beat me; but remember, only four tubes and everything comes in on a loud speaker, as I never use phones. Come and live in West Vancouver, and then your set will work.

DAVID WILLINGTON,
1472, Fulton St., West Vancouver,
B. C., Canada.

P.S.—Mr. Staves probably stays in bed when we fellows are up at three o'clock in the morning, and sometimes all night. Would like to show him my set to prove it to him.

NEXT!—IF ANY

Editor, RADIO NEWS:

I am by nature the most modest of men; and it was only through the continued urgings of my friends and relatives, and the

(Continued on page 285)

OUR worldwide army of readers sends in many letters daily, all of which RADIO NEWS is glad to receive; but few of them can be printed on this page. In making a selection, preference is given to those containing novel information; and then to those most concisely presenting opinions on various phases of questions of general interest, reflecting different points of view, without regard to whether or not they are those entertained by the editors. All letters should contain the writer's complete address, that they may be acknowledged or answered, if not published.

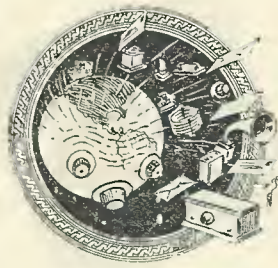

Radio Wrinkles



First Prize

AUTOMATIC "B" SUPPLY SWITCH

By H. J. DANA

DETAILS of construction are here given for an automatic relay switch, designed to operate under the control of the filament switch of the radio set, which will cost the average experimenter but very little for materials.

The magnet core is of $\frac{5}{8}$ -inch round iron 5 inches long, the ends of which are driven firmly into $\frac{3}{8}$ -inch holes in pole tips made of $\frac{1}{2} \times 1\frac{1}{2}$ -inch iron, about $2\frac{1}{4}$ inches long. The armature is of $\frac{1}{4} \times 1$ -inch iron, one end of which is pivoted, or hinged to one of the pole tips as shown in the illustration. The other end of the armature is retained by a brass yoke which also serves as a guide. An adjustable flat spring on the armature serves to hold the contacts open when not in use.

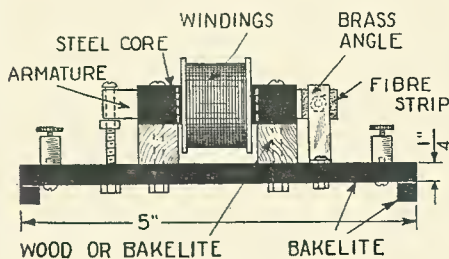

Side view of the automatic "B" supply switch, which is simple of construction.

The relay contacts consist of brass machine screws, to the tips of which are soldered the alloy contacts taken from the vibrator on a Ford spark coil. These contacts, which control the eliminator circuit, are threaded into insulated brass blocks, one of which is screwed to the free end of the armature, and one to the adjacent tip of the electromagnet. It will be noted that both these contacts are insulated from the armature and the pole tip, but connected by wires to binding post as shown.

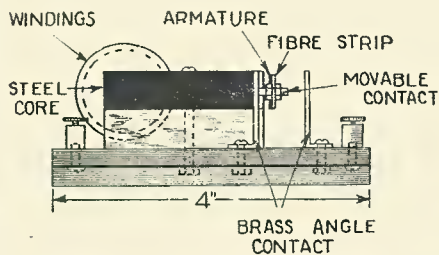

End elevation of automatic switch, showing movable contact and armature.

The magnet coil was found to require about 200 ampere-turns to operate the switch satisfactorily. It is also desirable to use a magnet coil which, for a radio set using six UV-199 tubes, would reduce the "A" supply not more than one-half volt. Such a winding was designed, using 600 turns of No. 16 cotton covered magnet wire wound on the $\frac{5}{8}$ -inch iron core. This

Prize Winners

First Prize \$25

AUTOMATIC "B" SUPPLY SWITCH

By H. J. DANA

703 Linden Ave., Pullman, Wash.

Second Prize \$15

PLUG-IN COIL

By H. W. HOLDSWORTH

60 Stearns Street, Bristol, Conn.

Third Prize \$10

A TRANSPARENT INSULATED SHIELD

By ROBT. N. AUBLE

1121 Tecumseh St., Indianapolis, Ind.

All published Wrinkles, not winning prizes, will be paid for at the rate of two dollars each week.

The next list of prize winners will be published in the November issue.

The same magnet coil will also operate on a radio set using two or more UV-210A tubes. However, it is desirable, in a set using more than one-half ampere in the filament circuit, to wind the magnet with fewer turns of heavier wire, keeping approximately the same number of ampere-turns in the coil.

The drawing shows the relay switch mounted on a varnished wood base and secured thereto by two machine screws extending through short pieces of iron pipe and screwed into the iron pole tips of the magnet. The addition of another set of contacts, which will close when the armature is released, would adapt the relay switch for use with a radio set having a trickle charger for the "A" battery. Such an automatic switch can be built by the average experimenter who has access to a hacksaw, drills, and taps, and will give entire satisfaction in use.

Second Prize

PLUG-IN COIL

By H. W. HOLDSWORTH

THIS coil is very easily made with the aid of a simple form, a little collodion, a small strip of bakelite and an old tube base.

The form may be made of two blocks of wood and pieces of $\frac{3}{16}$ -inch brass rod. These rods are driven tight into one block and are a snug fit in the other, so that

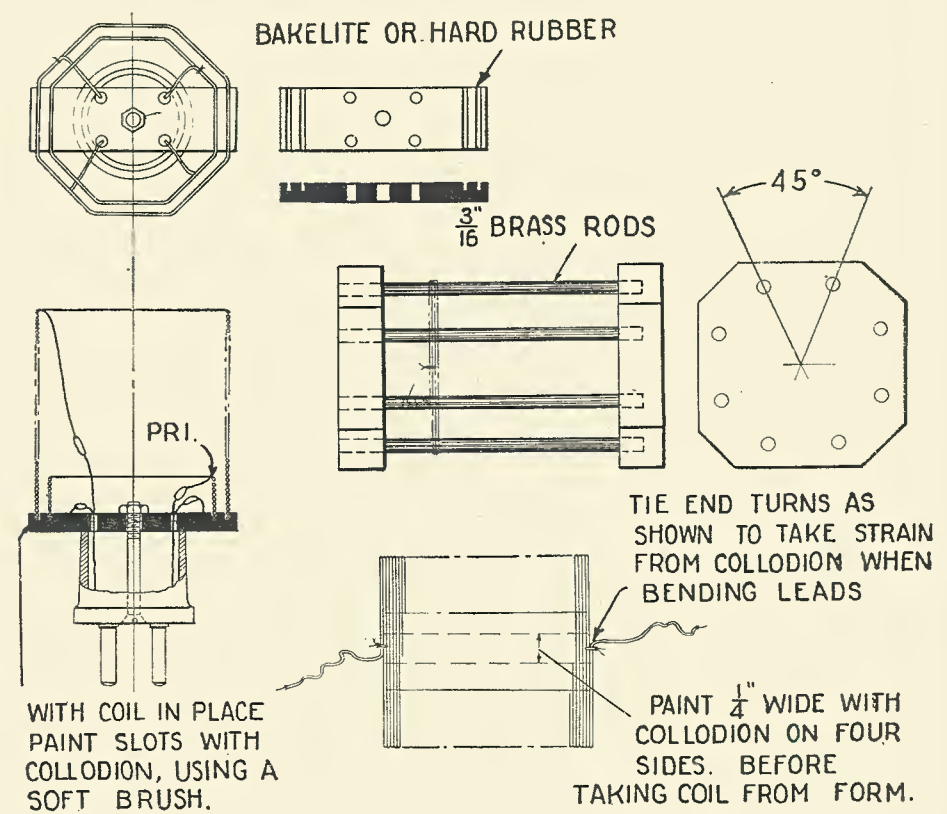

WITH COIL IN PLACE PAINT SLOTS WITH COLLODION, USING A SOFT BRUSH.

TIE END TURNS AS SHOWN TO TAKE STRAIN FROM COLLODION WHEN BENDING LEADS
PAINT $\frac{1}{4}$ " WIDE WITH COLLODION ON FOUR SIDES. BEFORE TAKING COIL FROM FORM.

Details of construction of plug-in inductances which are mounted in a vacuum-tube base.

it may be pulled off in removing the coil. Before removing the coil, tie with silk thread at ends as indicated, and paint a strip 1/4-in wide on four sides with collodion.

The finished coil is fitted loosely into slots in the small bakelite strip and the slots are then filled with collodion, which, if allowed to dry thoroughly, will be found to hold both primary and secondary securely enough for quite rough handling.

Any form can be used for such coils, but the octagonal shape seems to produce the most selective tuning. The diameter of coil and number of turns, etc., can, of course, be varied to suit the capacity of tuning condensers.

Third Prize

A TRANSPARENT INSULATED SHIELD

By ROBERT N. AUBLE

THE advantages of shielding in radio set construction need no discussion; most of the better-class, commercially-built instruments make provision for the use of shields; and some of the kits for home set building provide shields of one sort or another. But many of us who like to develop our own ideas in set construction, unless we have had extensive training in sheet metal work, are forced to employ the most makeshift, and consequently the most useless types of shields. And, because of the inherent difficulties in shield building, few of us have had the patience to construct a new set of shields for each new idea.

The shield described below is less expensive than aluminum, is very flexible, and at the same time sufficiently rigid to stay in place, is easily prepared and easily put into place; and it has the two additional advantages that it is transparent and insulated. And there is a slight additional advantage

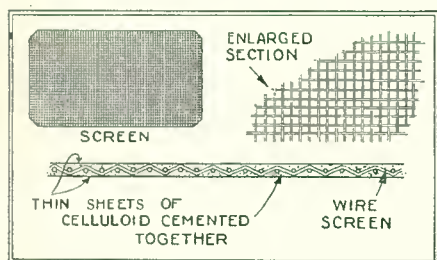

By placing celluloid on each side of copper screening and cementing it with acetone, an effective shield can be made.

in that Foucault currents, which absorb energy and reduce the over-all efficiency of any set, are somewhat reduced.

The shield itself is constructed of copper gauze, such as commonly used for window screens. It is made sufficiently rigid for use as a shield, and at the same time insulated against accidental short circuits, by pasting transparent sheet celluloid—the kind which is used in the storm curtains of automobiles—to the two sides. Two sheets of the celluloid, of suitable size, are cut and painted over with acetone. The wire gauze is then placed between them; the celluloid sheets will adhere to each other through the openings in the screen, and form a perfectly rigid single sheet. If the sheet is clamped tightly between two smooth boards in a vise, the resulting sheet will be found to be somewhat more solidly stuck together.

This shield may be cut with ordinary shears; it will easily bend about corners; and separate sections of it may be fastened in place by moistening it with acetone and pressing it together for a moment between the fingers.

CHARGING "B" BATTERIES

IN response to numerous requests from customers and friends for some efficient circuit by which storage "B" batteries of over 110 volts might be charged directly from the ordinary house current without employing expensive transformers, the

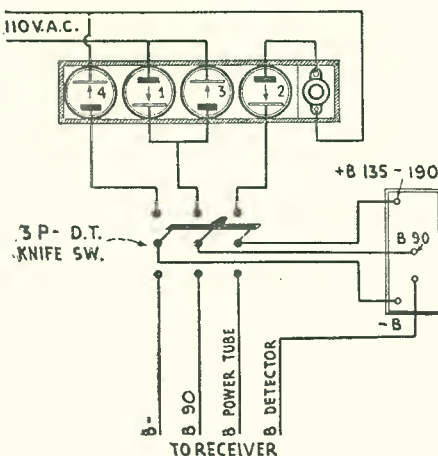

Fig. 1. Wiring diagram of the complete "B" charger unit.

writer conducted a series of experiments with chemical rectifiers. The result is a circuit which not only serves the purpose in an efficient way but is very simple to construct and operate.

The question seems to be: "When I put in a power tube must I discard the use of my storage 'B's,' go to the expense of a transformer to build a charger, or be bothered with multiple control by cutting the battery and throwing it into multiples?" The answer is "No." You can build your "B" unit up to 180 volts if you wish and, by building a simple charger as shown in diagrams, still have the same old simplicity of handling.

The rectifiers shown are of the usual type, lead and aluminum; quart Mason jars are used for containers. In this circuit, the size of the electrodes is important; the pencil or rod type should be used. The aluminum should not be over 3/8-inch in diameter and the lead slightly smaller; and they should be immersed to the depth of about 4 inches. This is because the exposed surface of the electrode in the solution alone governs the charging rate of the 90 volts of battery on the negative side. The positive end is charged through a lamp resistance which can be varied to lower the voltage to whatever is required. For example; if the complete battery consists of 180 volts, then the positive section will contain 90 volts and no lamp will be required; but, if 135 volts of battery is being used the positive section will contain only 45 volts and a lamp resistance must be introduced to lower the voltage of the charging

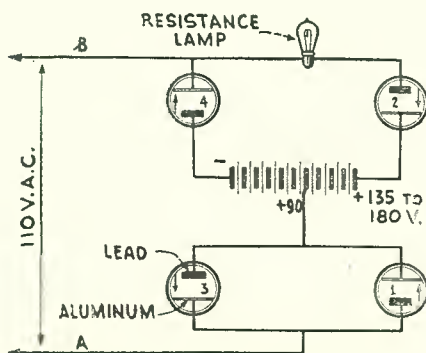

Fig. 2. Schematic diagram showing how the rectifiers are connected to the battery.

source, so that the battery will charge evenly. The lamp must in this case be between 20 and 50 watts, depending entirely upon the size of the electrodes in your rectifier.

To determine what size of lamp to use when the section is 45 volts, leave rectifier No. 4 disconnected and, with the battery in a discharged condition, connect the other leads as shown in Fig. 3; insert a small lamp (10-watt) in the socket and allow battery to charge for one hour. If the resistance is proper, the voltage of this section will come up to about 50 or 55 volts. At this time, the voltage of the battery being equal to that of the charging source, all current will cease to flow. Thus, by testing the voltage of the battery after an hour, you can determine exactly the voltage of the charging source for that half of the battery. If the lamp has too much resistance the voltage will stop short of 45 volts; on the other hand, if the voltage continues to rise to the full 90, a higher resistance should be used.

In connecting the wire coming from Nos. 1 and 3 to the center of the battery the strap is never to be cut; but the wire is simply clipped to the connecting strap between the two cells.

The solution used for rectifying may be any one of the following: borax, baking soda (sodium bicarbonate), or half-and-half sodium phosphate and potassium phosphate. Personally I believe that the latter is the best solution but, as the potassium phosphate is sometimes hard to procure, it may be necessary to use one of the others. These should not be saturated solutions, in any case. As usual, the three terminals that go to the battery should be twisted together and the current turned on for a short time in order to "form" the plates in the rectifiers. When this is completed the aluminum should have a coating of chalky substance.

It will be noted that the lead electrode

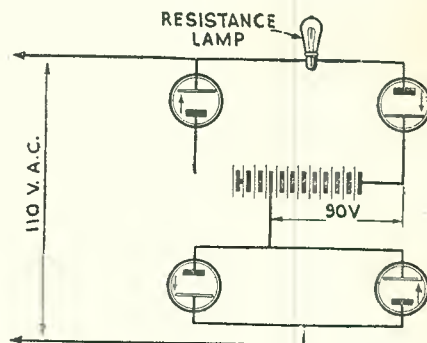

Fig. 3. By leaving No. 4 rectifier disconnected the proper size of the resistance lamp may be determined.

is designated by a short line, while the aluminum is shown by a long line with the direction of current flow, indicated by arrow, always from lead to aluminum. It is important that these terminals be wired very carefully; as a mistake in wiring any one of the jars will result in a complete failure of the circuit.

In dealing with these circuits it is a good thing to remember that you are dealing with two different kinds of resistance. For example, decreasing or increasing the size of electrodes in rectifier will decrease or increase the flow of current but will not change the voltage. On the other hand, if large electrodes are used and the flow of current is governed entirely by a lamp resistance, the voltage will be considerably affected; therefore, if the maximum voltage is desired, it is necessary to regulate the current flow by the size of the electrodes in the rectifier.

Chemical rectifiers Nos. 3 and 4 in this
(Continued on page 275)



Radio News Laboratories



RADIO manufacturers are invited to send to RADIO NEWS LABORATORIES samples of their products for test. It does not matter whether or not they advertise in RADIO NEWS, the RADIO NEWS LABORATORIES being an independent organization, with the improvement of radio apparatus as its aim. If, after being tested, the instruments submitted prove to be built according to modern radio engineering practice, they will each be awarded a certificate of merit; and a "write-up," such as those given below, will appear in this department of RADIO NEWS. If the apparatus does not pass the Laboratory tests, it will be returned to the manufacturer with suggestions for improvements. No "write-ups" sent by manufacturers are pub-

lished in these pages, and only apparatus which has been tested by the Laboratories and found of good mechanical and electrical construction is described. As the service of the RADIO NEWS LABORATORIES is free to all manufacturers, whether they are advertisers or not, it is necessary that all goods to be tested be forwarded prepaid, otherwise they cannot be accepted. Apparatus ready for, or already on, the market will be tested for manufacturers free of charge. Apparatus in process of development will be tested at a charge of \$2.00 per hour required to do the work. Address all communications and all parcels to RADIO NEWS LABORATORIES, 230 Fifth Avenue, New York City.

RESISTOR

The resistor strip (No. 2 of kit No. 2313 shown) submitted for test by the Carter Radio Co. 300 So. Racine Ave., Chicago, Ill., is formed of strip bakelite $8 \times \frac{3}{4} \times \frac{1}{8}$ -inch, and covered with three separate windings of thin resistance wire; each winding having a resistance



of approximately 1,000 ohms. One of the outer windings is equipped with two sliders to permit accurate adjustment of the desired resistance. This strip is designed to be used in "B" power units as a voltage-regulating device.

AWARDED THE RADIO NEWS LABORATORIES CERTIFICATE OF MERIT NO. 2034.

"B" POWER-SUPPLY UNIT

The "B" power-supply device shown, submitted for test by the Consolidated Battery Co. 1600 Walnut Street, Philadelphia, Pa., operates on 110-volt 50- to 60-cycle house-lighting current, and uses a Raytheon BH tube as rectifier. The direct current supplied, up to 180 volts, is of good quality and sufficient to

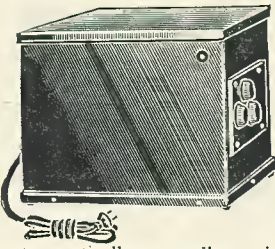

operate practically any radio receiver on the market. When tested in connection with different radio sets, this power-supply unit has been found to be very satisfactory.

AWARDED THE RADIO NEWS LABORATORIES CERTIFICATE OF MERIT NO. 2046.

RECTIFIER BULB

The rectifier tube (type G100 shown) submitted by the Globe Electric Co., 341 Halsey Street, Newark, N. J., is of the full-wave gas-filled rectifier type. It can be



used very conveniently as a rectifier in most of the existing "B" power-supply units using tubes of this type.

AWARDED THE RADIO NEWS LABORATORIES CERTIFICATE OF MERIT NO. 2048.

AUDIO AMPLIFIER

The "Crystola A" shown, submitted by the Novelty Products Mfg. Co., 802½ S. Virginia Street, Hopkinsville, Ky., is a one-stage transformer-coupled audio amplifier, built into a neat little cabinet. This amplifier, when connected to a suitable crystal receiver, allows loud-speaker reception of very good quality.

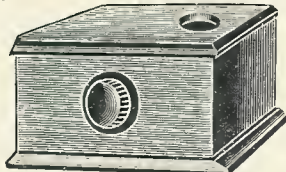

AWARDED THE RADIO NEWS LABORATORIES CERTIFICATE OF MERIT NO. 2052.

VARIABLE CONDENSER

The variable condenser (D27 shown) was submitted by the Stassfurter Licht & Kraftwerke, A. G., Stassfurt, Germany. It is, electrically and mechanically, a well-designed instrument of the low loss type. The special-shaped stator and rotor plates give to this condenser a straight-line-frequency characteristic. It is equipped with a vernier arrangement of the friction type, which is operated by a small shaft passing through the hollow main shaft of the condenser. The vernier ratio is approximately 1 to 8. The pigtail attachment insures noiseless connection between the rotor and condenser frame. The condenser is

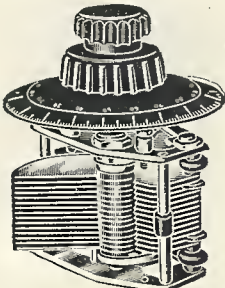

supplied with a neat bakelite dial and a bakelite knob for the vernier.

AWARDED THE RADIO NEWS LABORATORIES CERTIFICATE OF MERIT NO. 2064.

VIBRATION ELIMINATOR

The aluminum caps shown, submitted by Mary J. Lobato, 1 Mason Court, Lowell, Mass., are designed to prevent microphonic noises resulting from mechanical vibrations transmitted to the radio tube through the socket or through the air. The two identical parts forming each cap are cast of aluminum and held together over the glass part of a 201A-type tube by two coil springs. The anti-microphonic effect of these

caps has been found efficient in a great number of cases.



AWARDED THE RADIO NEWS LABORATORIES CERTIFICATE OF MERIT NO. 2063.

RADIO MAST

The "Premax Telescoping Radio Mast" shown was submitted by the Niagara Metal Stamping Corp., Niagara Falls, New York. Each mast consists of two telescoping steel tubes. To the bottom of the lower (outside) tube, which is approximately 46 inches long and $\frac{7}{8}$ inches in diameter, is attached by means of a "U"-shaped iron strip a steel plate, 3 inches in diameter, which serves as a support for the mast. To the top of the upper (inside)



tube, which is 36 inches long and $\frac{3}{4}$ inch in diameter, is riveted a spherical cap which is provided with holes for the guy wires; another spherical cap slides along the same tube. The latter is held in its position by a special screw on the top of the lower tube. Although this mast is very light, it is nevertheless very strong and safe, especially when the guy wires are judiciously placed.

AWARDED THE RADIO NEWS LABORATORIES CERTIFICATE OF MERIT NO. 2066.

R. F. COIL

The radio-frequency coil (type 95 shown) submitted by the Daven Radio Corp. 158-160 Summit Street, Newark, N. J., uses as a form a bakelite tube, 3 inches long and $1\frac{1}{2}$ inches in diameter. The primary is wound in a groove at the middle of the tube; while the secondary does not come in contact with the tube at all, as it is wound on 12 thin wooden rods equally spaced along the periphery of the tube. Two brass brackets allow either panel or baseboard mounting.

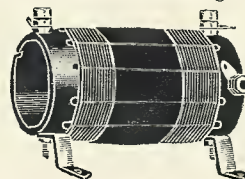

AWARDED THE RADIO NEWS LABORATORIES CERTIFICATE OF MERIT NO. 2070.

VACUUM TUBE

The vacuum tube shown, submit-

ted for test by the Universal Electric Lamp Co., Newark, N. J., is of the 201A type, and has a bakelite UX base. Its characteristics are similar to those of a standard 201A tube, and it operates very satisfactorily as either detector or amplifier.



AWARDED THE RADIO NEWS LABORATORIES CERTIFICATE OF MERIT NO. 2071.

RESISTOR

The "Hy Watt" resistor, submitted for test by the Electro-Motive Engineering Corp., 127 W. 17th Street, New York, N. Y., consists of an isolantite tube about $3\frac{1}{2}$ inches long, $\frac{3}{4}$ inch in diameter and $\frac{1}{8}$ inch thick, covered on the outer side with a special conductive compound which is fused into the surface of the tube. To obtain the desired resistance value, a spiral groove is cut through the conductive surface; after which it is covered with insulating enamel. At the end of the tube the conductive surface is sil-



vered in order to allow perfect contact with the end caps or rings equipped with lugs. This resistor is designed to carry heavy loads and is rated at 12 watts. It can be very conveniently used in "B" power-supply units.

AWARDED THE RADIO NEWS LABORATORIES CERTIFICATE OF MERIT NO. 2074.

LOUD SPEAKER

The loud speaker shown (type A), submitted for test by the United



Radio Corp., 15 Caledonia Ave., Rochester, N. Y., is of the cone type.

The paper cone is approximately 7 inches in diameter and has its edge glued to a soft-leather ring, which in turn is fastened to the metallic ring around the mouth on the front panel by a rubber band. The unit is of the conventional type and very well constructed. A built-in filter system controls the output, and the whole is mounted in a beautiful mahogany cabinet. The reproduction of music and speech is very fine and of great volume.

AWARDED THE RADIO NEWS LABORATORIES CERTIFICATE OF MERIT NO. 2075.

TUBE SOCKET

The "Shock Proof Universal" socket shown, submitted for test by the Pilot Mfg. Co., 323 Berry Street, Brooklyn, New York, is designed to eliminate vibrations which cause microphonic noises. The bakelite unit which carries the tube is at-

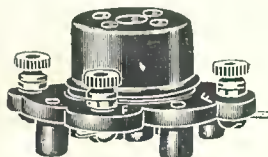

tached to the base by four phosphor-bronze contact springs which act as shock absorbers. This socket can be used with any standard UV or UX tube, and insures a perfect contact with the tube prongs.

AWARDED THE RADIO NEWS LABORATORIES CERTIFICATE OF MERIT NO. 2076.

VARIABLE CONDENSER

The variable condenser shown, submitted by the Owin Radio Apparate Fabrik, Falstrasse, 6, Hannover, Germany, is of the low-loss straight-line-frequency type. This

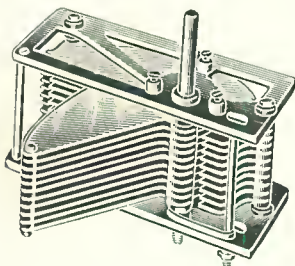

condenser, which is made almost entirely of aluminum, is very neatly constructed; although very light it is sturdy and electrically efficient.

AWARDED THE RADIO NEWS LABORATORIES CERTIFICATE OF MERIT NO. 2077.

VARIABLE CONDENSER

The "Precision" variable condenser shown submitted by the same company, is a very fine piece of

mechanical and electrical work. It is of the straight-line, low loss type and embodies many interesting features. It can be used for panel

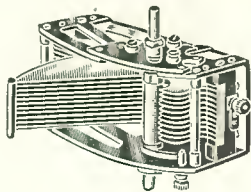

and baseboard mounting; for the former it can be attached either by three screws, or, with a nut around the shaft, as a one-hole-mounting device. The frame of the condenser, which is of nickel-plated brass, is one stamped piece; two rods insure perfect rigidity. The rotor runs very smoothly and is connected to the frame by a pigtail attachment. An extension of the rotor shaft allows gang mounting.

AWARDED THE RADIO NEWS LABORATORIES CERTIFICATE OF MERIT NO. 2078.

RESISTANCE MOUNTING

The resistance mounting shown, submitted by the same company, is made of a bakelite strip, 1/4 x 3/8 x 1 3/4 inches and four nickel-silver side-springs attached to the strip by screws and nuts. The springs make



a perfect contact with the cups of the resistance element and allow an easy exchange of the resistance units. This mounting is compact and easily installed.

AWARDED THE RADIO NEWS LABORATORIES CERTIFICATE OF MERIT NO. 2082.

A. F. COUPLING UNIT

The "Resistance Block" shown, submitted by the Pilot Mfg. Co., 323 Berry Street, Brooklyn, New York, is a resistance-coupling unit and consists of a molded brown bakelite base carrying a .01-mf. condenser, and equipped with phosphor-bronze springs for the corresponding resistors. This unit is very compact and easy to connect.

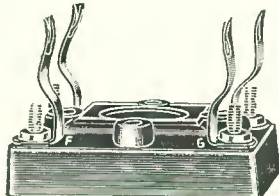

AWARDED THE RADIO NEWS LABORATORIES CERTIFICATE OF MERIT NO. 2084.

RESISTOR

The "Powerohm" shown, submitted by the International Resistance Company, Ferry Building, Philadelphia, Pa., is a resistor intended for use in "B" power units and designed to carry relatively heavy loads. The resistance element which is a "Durham" metallized-glass rod, is lodged in the slot of a cylinder of ceramic insulating material, 3/8-inch in diameter, and protected with putty against atmospheric action. The close contact between the resistance element and the ceramic housing and putty produces better heat dissipation. The tested unit, 1/2-inch in length, has a nom-



inal 10,000-ohm resistance value, and is rated at 2 1/2 watts load.

AWARDED THE RADIO NEWS LABORATORIES CERTIFICATE OF MERIT NO. 2085.

GRID LEAK

The "Metaleak" shown was submitted for test by the Dubilier Radio & Condenser Corp., 4377 Bronx Blvd., New York, N. Y. The resistance element of this unit



consists of a glass rod coated with an extremely thin layer of specially-prepared metallic substance. The coated rod is hermetically sealed in a glass tube and soldered to the two end caps. The "Metaleak" is slightly shorter than most resistance units, but fits nevertheless in any standard grid-leak mounting. It is available in different resistance values.

AWARDED THE RADIO NEWS LABORATORIES CERTIFICATE OF MERIT NO. 2086.

LOUD-SPEAKER HORN

The loud-speaker horn (No. 400 "Purepower") shown was submitted for test by the Platter Cabinet Co.,

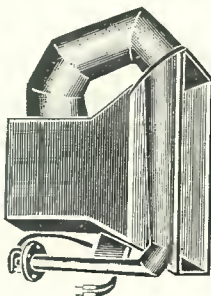

North Vernon, Ind. It is constructed partly of impregnated paper and partly of three-ply veneer. The average length of the air column is

approximately 50 inches. When used in conjunction with a good speaker-unit, this horn gives very fine reproduction of music and speech, with regard to both quality and volume. It is designed for use in radio cabinets of the console type.

AWARDED THE RADIO NEWS LABORATORIES CERTIFICATE OF MERIT NO. 2087.

A. F. TRANSFORMER

The "Radiogrand" audio-frequency transformer shown, submitted for test by the Telsen Electric Co., Ltd., Birmingham, England, is a very neatly built instrument. It is completely enclosed in an iron housing equipped with mounting feet. Within the limits of the most-used frequencies of speech and music, the transformer shows a very good characteristic and amplification. When used in an audio amplifier with suitable tubes and voltages, it affords very fine reproduction.

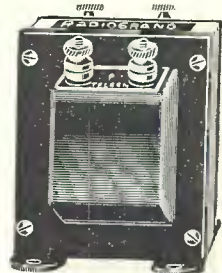

AWARDED THE RADIO NEWS LABORATORIES CERTIFICATE OF MERIT NO. 2088.

A. F. TRANSFORMER

The "Ace" audio transformer shown, submitted by the same com-



pany is somewhat smaller in size than that described above. Therefore, it can be used very conveniently in portable receivers, or wherever little space is available. The amplification features of this transformer are good.

AWARDED THE RADIO NEWS LABORATORIES CERTIFICATE OF MERIT NO. 2089.

Correspondence from Home Radio Set Constructors

(Continued from page 247)

that a snare drum will almost smother the whole orchestra.

I had the Ferrantis in a World's Record super; hut took them out and constructed an amplifier on the Truphonic principle, plugged in on the detector of an Atwater Kent 20. I think, and so do a great many others, that I have the best reproduction any of us have heard. I would like to have a speaker curve from the combination that I have.

I think it would help set builders a great deal, and increase the sales of their product, if manufacturers brought the terminals out at the bottom instead of the top of apparatus; thus giving us shorter grid leads and less chance of back-coupling.

I have a little hope for your readers on the World's Record super. The old hook-up called for seven "peanuts," and 201As throughout were almost impossible. The new way calls for oscillator, first and second detector, first and fourth intermediate tubes on a 10-ohm rheostat; and the second and third intermediate tubes on another 10-ohm rheostat in series with the first. Thus 201As or UX-199s can be handled easily. If any of your readers have this super, they will be glad to know of this rheostat change, which makes a real set very easy to handle.

HERBERT COX,
1936 Ferry St., Easton, Penna.

THE ROLL-TYPE SPEAKER—PRO—

Editor, RADIO NEWS:

It is with pleasure, that I extend to you congratulations on the excellent number of RADIO NEWS, just on the stands; i.e. the July, 1927, issue. It is almost impossible to say which division of

articles is the best; they are all of the finest, and only the interest of the reader can determine which one is best suited to his needs. In every issue there are so many good articles on construction; and the department of "Radio Wrinkles" is always worth more than the price of the magazine.

In this issue the article by E. M. Yarbrough, "A Simple Roll-Type Loud Speaker," is a whirlwind. The construction looks, and is so simple, that I was skeptical as to its working; but, having an old unit in the junk box, and at a cost of thirty-five (35) cents for paper and thumb tacks, I went to it. I now have a roll-type speaker that I will put up against any thirty-five dollar speaker I ever heard, for volume, clarity and stability. I was unable to get a parchment-finished paper and had to substitute ordinary drafting paper. I wonder what it will be like when I can get a good paper for the rolls.

J. N. BACON,
c/o Postal Telegraph Cable Co., Oshkosh, Wis.

—AND CON

Editor, RADIO NEWS:

I wish to take exception to certain statements made in your article in the July issue of RADIO NEWS on "A Simple Roll-Type Loud Speaker." I have used a Dictogrand horn-type loud speaker for nearly three years, and have been thinking of constructing an exponential horn for same; but your article aroused my interest, as it was set forth as "most nearly perfect in reproduction"—"highly efficient"—"and capable of great volume."

I constructed the roll as per instructions, but mounted the Dictogrand reproducing unit in place of the phone, as described in the article. Later I used a Western Electric headphone in place of the Dictogrand and compared this with the regular Dictogrand combination using the horn. The tone of the roll seemed slightly better than that of the horn, but the volume was very much reduced. One stage of audio amplification using the horn gave twice as much volume as two stages of audio using the roll. On the first stage audio the roll was just audible, that was all.

Perhaps in comparison with a cone loud speaker this roll may be very good—however, I doubt it. I know, from testing a certain make of cone in series with the Dictogrand that its efficiency is low as compared with the Dictogrand; for when in series, the horn operated perfectly while the cone was inaudible; while when placed in parallel they both operated with about equal volume, showing that the cone drew more current than the horn. This was a Rola cone speaker.

Why not try out this device in your testing laboratory and make the comparisons as I did? I will state that I am not in the radio business.

RALPH C. WHEELER,
2838 Woolsey St., Berkeley, Calif.
(The subject of horns and cones is scientifically discussed in the article, "A Loud Speaker with a Three-Quarter Mile Range," in RADIO NEWS for August. The horn is more directional than the cone, and therefore concentrates a larger volume of sound into a smaller space. Both, in their best forms, are highly-efficient reproducers; and each better fitted to specific purposes.—EDITOR.)

Radiotics

DOES IT SOUND LIKE THE DEVIL?

Weird suggestion in *Radio Broadcast Advertiser* for July: "...and two stages of IMP DANCE coupled audio." Sometimes, from the way our set sounds, we think that more than imps are dancing around in our audio stages. How do you filter out the noises they make—with a pitch fork?

Contributed by E. A. Weisenhorn.

FROM THE EAST, LIGHT SETS

This from an advertisement in *Radio News Magazine* of July: "A compact traveler's set, ORIENTAL kit, \$15.95." We don't know whether this reference is made to some sort of a radio Persian pussy, or whether the Turks are going into the radio business. Perhaps the latter.

Contributed by Joel H. Dearth.

SATURDAY NIGHT SETS

Bathroom gesture from the *Chicago Tribune* of May 30. In furnishing radio bulletins for the development of sets, an ad states they are for fans "who build their own or WASH to improve their present sets." We wonder if it is necessary to work on this set while immersed in a bathtub up to your neck.

Contributed by Milton R. Lots.

THE LATEST IN TUBES

Progress reported in tube manufacture, taken from an advertisement in the *Waterbury (Conn.) Republican* of June 17: "A few good radio tubes WITH BATTERY COMPARTMENTS, left, \$5.00 to \$11.75." This type of tube will evidently do away with console models; as the unsightly batteries can be stowed away in the tubes.

Contributed by John G. Knauf.



GIVE THEM A VACATION

Advertisement in the *Pittsburgh Post* on May 29, of joyous, carefree apparatus: "Trade or sell lot of radio parts. Want NON-CARE radio transformers." Evidently the transformers that the gentleman had in his set, had too much capacity for worry and got nervous; thereby spoiling reception by their turns and twistings.

Contributed by Lawrence A. Welsh.



EMPLOYERS, TAKE NOTE

Argument against undue application to work is found in the *New York Sun* of May 21: "Such extremely long HOURS have resonance points near the lower edge of the frequency scale and yield remarkable results." We don't know what frequency they refer to; but maybe it is the number of times per second that the stenographer powders her nose.

Contributed by S. S. Rogers.



WOOF! WOOF!! THE GYASTICUTUS!!!

A radio monster has evidently been captured, according to the *Buffalo Evening News* of May 21: "Copy of our regular FOUR-JAW trickle charger has been sent." We have heard of two-headed calves, sheep with five legs and kindred abominations; but we never before heard of a charger like this one.

Contributed by Ernest G. Graf.



ANTI-VOLSTEADIAN GESTURE

From the *Detroit News* of June 4: "BREWER TULBY, power six, console cabinet." Apparently this set has not only a built-in loud speaker and other radio advantages, but something for those who like a bit of refreshment while listening to the dryer parts of the program.

Contributed by Christ Babler.



LATEST MODERN INCONVENIENCE

An item of interest to addicts of the Turkish bath appeared in the *Cleveland Plain Dealer* of April 22: "Alternate use of HOT AND COLD AIR TUBS, governed by radio." There certainly has been a lot of hot air floating around some radio sets we have met; but we were blissfully unaware that anything like this had been developed.

Contributed by J. G. Grant.



PLETS WITT FILLYOUMENTS WITT QUADRILLINGS

Latest development announced by the R.C.A. in the *Literary Digest* for May 28: "We talk about quadrillions of them (electrons) per second leaping across from the filament OF the plate of a Radiotron." Evidently these are cold weather tubes; because they have to heat up the plate so that the electrons will have a nice warm place after their trip through the vast spaces.

Contributed by Stanley Lavarie.



VAUDEVILLAINS, TAKE NOTICE

For the comedy relief in your new act, we advise this item, announced in the April issue of *Radio Merchandising*: "The COMICAL horn of laminated paper composition has very moderate taper." We know of no cheaper way to get a comedian than this method of going to a store and getting one of these funny horns to pep up the act.

Contributed by Ed. Page, Jr.



WANTA NICE VOLT?

Volts and amps under the hammer as advertised by the *Mussoorie Times*, of Kipling's India, on May 13: "The undermentioned goods will be sold to the highest bidder. ELECTRIC AMPERES AND VOLTS." Evidently over in India they have other kinds of amperes and volts. Can anybody give us any dope on this?

Contributed by C. M. Sweet.



TRY THIS AERIAL ON YOUR PANCAKES

This from the *Rochester Evening Journal* of May 7: "A vertical BUTTER PIPE antenna system is employed." This type of antenna might perhaps be satisfactory within the Arctic, but we certainly doubt if it would be very serviceable where the climate is inclined to be hot.

Contributed by John C. Heberger.



NOT FOR US

Frank advertisement in the well-known *Montgomery Ward Catalogue*: "NO AID Truphonic Amplifier." Apparently this amplifier is not expected to help much in the reproduction of music; at least the mail-order house is certainly frank in describing the goods.

Contributed by T. F. Maher.



NEED SOME JACK?

Economic suggestion from the *Barwick Company's* catalogue in the advertisement of a battery charger: "Charging at 2 1/2 amperes for 110-volt 50-60 cycles CURRENCY." All you now have to do is to plug in this little gadget and attach the clips to your pay envelope—and presto!—a raise in pay.

Contributed by John C. Heberger.



FOR THE AESTHETIC FAN

This from the *Chicago Evening Post* of April 21, in the caption under a picture of a 100-kw. transmitting tube: "The tube has a large copper anode, or plate, which is WATER COLORED." Maybe the plate is painted to have a greater interest for the intelligentsia among the electrons, so they will be attracted thereby.

Contributed by Grote Reber.





I Want to Know

Conducted by Joseph Goldstein

THIS Department is conducted for the benefit of our Radio Experimenters. We shall be glad to answer here questions for the benefit of all, but we can publish only such matter as is of sufficient interest to all.

1. This Department cannot answer more than three questions for each correspondent. Please make these questions brief.
2. Only one side of the sheet should be written upon; all matter should be typewritten or else written in ink. No attention paid to penciled matter.
3. Sketches, diagrams, etc., must be on separate sheets. This Department does not answer questions by mail free of charge.
4. Our Editors will be glad to answer any letter, at the rate of 25c. for each question. If, however, questions entail considerable research work, intricate calculations, patent research, etc., a special charge will be made. Before we answer such questions, correspondents will be informed as to the price charge.

OUTPUT FILTERS

(Q. 2231.) Mr. J. Jenkins, Bryn Mawr, Pa., asks:

Q. Will you please explain the use of an output filter for a loud speaker; stating its advantages and theory of operation and giving diagrams of several possible methods?

A. The amount of current which actually actuates the loud speaker is continually varying with the voice- or music frequency received by the set. This may be considered as an alternating current, superimposed upon a direct current. The direct current is flowing through the last audio tube at all times, and is dependent upon the voltage supplied and the resistance of the tube. This direct-current component, however, does no useful work at all in the circuit and, if it were possible, it would be gotten rid of. The output device does away

with a very small wire. If sufficiently large wire were used, the heavy current used in power tubes could be carried; but the bulk of the coil would be much greater and we would still have the unwanted direct current interfering with the operation.

Rather than redesign the speaker completely, to take care of a large D.C. component, it is much more simple to eliminate the direct current from its windings. This is what the output device does. There are several different kinds of these, available for use when the power tube is used.

Use of Transformer

In one method a low-ratio or a 1:1 transformer is used. As a transformer has an output of alternating current only, the loud speaker is entirely free from the D.C. current, and the voltage across the speaker is very small. The connections for this device are shown in Fig. 2231A.

As we are not limited by size of wire, etc., the primary of the transformer may be made of sufficient carrying capacity so that there will be no danger of burnout. Special transformers are made for this purpose; though sometimes fair results may be had by the use of a standard low-ratio transformer. It may be connected directly across the output of the receiver.

Choke-and-Condenser Coupling

Fig. 2231B shows another type of output device, which has a choke coil connected directly across the two output terminals of the receiver. Two condensers are used to transfer the A.C. to the speaker. This device puts no high-voltage strain on the loud speaker and may be connected directly; its condensers may be of the low-voltage type, as there is no great electrical strain on them. The burning out of one condenser, while it would give the speaker a considerable potential above ground, would not burn it out.

Fig. 2231C gives another choke-coil connection, using only one condenser and one choke. A low-voltage condenser may be used and there is little danger of burning it out; as the only voltage impressed across it is the drop in the choke. The disadvantage of this method is that the speaker lead is at high potential and a severe (though not dangerous) shock may be had by coming into contact with the leads. The D.C. component is eliminated, as before, since direct current will not flow through a condenser.

Fig. 2231D gives perhaps the most common connection for an output device. A choke is used as before, connected between the "B" supply and the plate of the tube. A by-pass condenser, between one side of the loud speaker and the other output

terminal, is connected also to the negative return of the "B" battery. The loud speaker has on it no high voltage at all, and is perfectly safe to handle. It must be noted, however, that the full "B" potential is placed directly across the speaker to the negative return. This means that the condenser must be of the high-voltage type. A shorted condenser would put the full "B" through the speaker, by way of the choke, with the result that the speaker windings would probably be burnt out.

Where there is no danger in coming in contact with the loud-speaker lead, there is no reason why the method shown in Fig. 2231C should not be used. The results obtained from the various methods when properly operated seem to be practically the same; though some preference may be perhaps given to the choke-coupled methods.

The type shown in Fig. 2231B, while requiring two condensers, is perhaps the safest and easiest to install. The condensers may be of the cheaper type, and a burn-out is not likely to cause any damage other than to the condenser. The value of the coupling condensers may be from 2 to 6 microfarads; the higher values giving better results on the low notes. The choke is usually about 30 henries. These constants are not at all critical; and any sort of output device will certainly improve the quality over none at all. Some manufacturers recommend the use of output filters on voltages as low as 90, but others say only that all voltages over 135 should have a coupling device.

RADIOLA 20 RECEIVER

(Q. 2232.) Mr. R. Palusso, Glenhead, N. Y., asks:

Q. Will you please publish in your columns the circuit diagram, and any other information on the Radiola 20 five-tube receiver?

A. The diagram which you request will be found at the bottom of this page.

The Radiola model 20 employs tuned-radio-frequency amplification with regeneration in the detector tube. The tuned-radio-frequency stages are two in number and of the neutralized type, employing the Rice method of neutralization. The neutralizing condensers are designated in Fig. 2232 as C₃, C₁ and C₂.

The tuned circuits are capacitatively tuned with S.L.F. condensers mechanically coupled so that they are controlled from one drum. Vernier adjustments in the form of two vernier condensers are also included; these condensers are designated as C₃ and C₄. The complete receiver system consists of two stages of neutralized tuned-radio-frequency amplification, a regenerative detector and

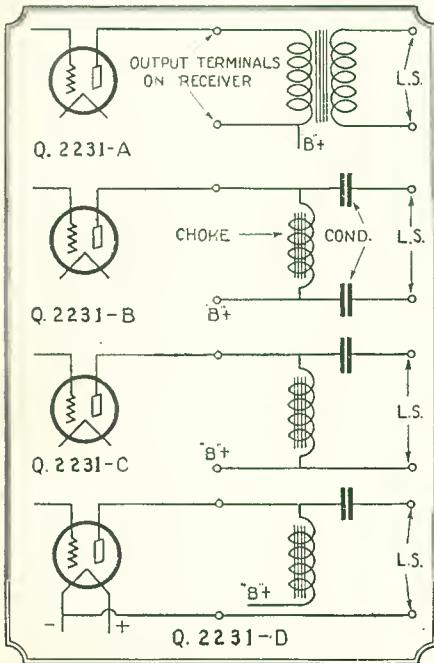

The various types of output filter devices shown here are used to protect the loud speaker from being damaged by heavy currents. They are fully explained in the text.

with this unnecessary current-component in the loud speaker.

All loud speakers have motor mechanism, of some type, which consists of one or more coils which act upon an armature or reed, which then transfers the motion to the diaphragm or to the cone. A permanent magnet also is arranged in a certain relation to the coils and accentuates the movement.

These coils must have a large number of turns in order to be effective, as the alternating current is very small. That is, to get enough force to actuate the speaker properly, we must have a large number of ampere turns. The ampere turns are measured by multiplying the number of turns by the current (in amperes) flowing in the coil and are, in a way, a measure of the force we may obtain from the magnet. Therefore, as the current is small, we must have a very large number of turns. In order to get the number of turns required for proper operation, it is necessary to use

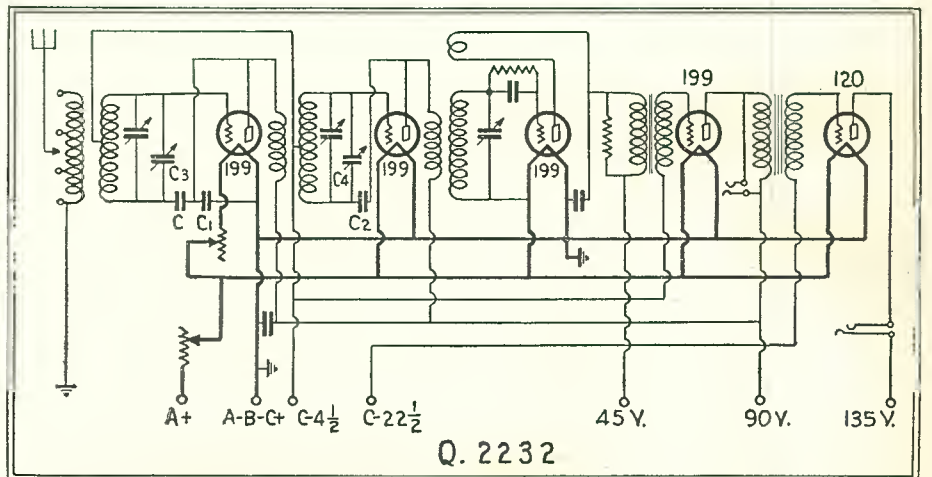

Circuit diagram of the popular "Radiola 20" five-tube receiver. Two stages of balanced radio frequency, with a regenerative detector, provide unusual sensitivity.

two stages of transformer-coupled audio-frequency amplification. The regeneration is obtained by means of a tickler coil connected in the detector-tube plate circuit and coupled to the grid coil of that tube.

The aerial input coil (the primary) is tapped in order to provide for various aerial lengths and conditions. The R.F. amplifying tubes are so wired that a bias of "4½" volts is applied to the grids of these tubes. The tubes utilized are 199 in the R.F., detector and the first audio stages; and a 120 in the output stage. The filament control is obtained by means of a rheostat controlling the second R.F., detector and both A.F. tubes. The volume control is a separate rheostat for the filament control of the first R.F. tube.

The sequence of the tubes, looking down upon the receiver with the panel facing the individual, is as follows: First R.F., second R.F., second A.F., first A.F., and detector. A jack is provided so that either or both stages of A.F. amplification can be employed. Pin jacks are provided, to make possible the connection of a voltmeter for the determination of the filament potential.

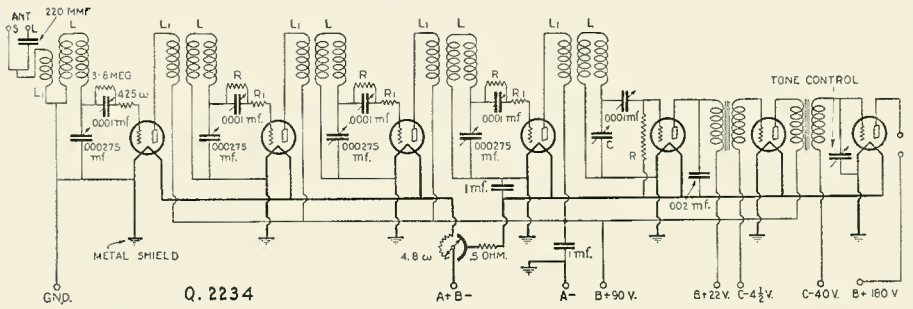

A seven-tube receiver of recent design. "Binocular" fieldless coils are employed, thus preventing any feed-back and oscillation due to interaction between coils.

DOUBLE-IMPEDANCE AMPLIFIER

(Q. 2233.) Mr. C. Gold, Brisbane, Australia, writes:

Q. After much experimenting, I have come to the conclusion that the quality obtained from a receiving set depends to a great extent on the design of the audio amplifier. Therefore, I would like to construct an amplifier to substitute for my present resistance-coupled amplifier, and am thinking of using double impedances for this purpose. Can you give me any information, and a circuit diagram of an amplifier of this type?

A. It is generally conceded that transformer-coupled amplification provides the simplest and most stable means of obtaining ample loud speaker volume. While the better makes of present-day transformers provide good tone quality in combination with a suitable loud speaker, to those with a critical musical ear, however, somewhat better tone quality, with less volume, may be obtained with impedance- and resistance-coupled methods. However, the last two methods, because of their inherent characteristics, have often been abandoned in favor of the more stable transformer-coupling system, with its greater volume for given "B" or plate voltages, though at a slight sacrifice in realistic rendition.

Double-impedance coupling differs radically from the usual impedance-coupling in the amplifier, as well as from the well-known resistance coupling. In the usual type of impedance-coupled amplifier, "blocking" frequently occurs, particularly in the last A.F. tube. This is probably due to the fact that, in spite of precautions taken to adjust the grid bias properly, an occasional signal causes the grid to charge. Unless this charge has leaked off before the next impulse reaches the grid, "blocking" occurs. The high-resistance leak used in the usual impedance-coupled amplifier does not permit the charge to leak off rapidly enough. If the resistance is reduced to the point where blocking no longer occurs, signal strength suffers. The reactance type of leak in the double-impedance coupler, on the other hand, combines a high impedance to alternating current with a low direct-current resistance, and the tendency to block is overcome.

Problems of Coupling

The high value of the coupling resistance required in resistance-coupled amplifiers for good quality generally results in tubes being operated at a plate voltage too low for best results. (Plate voltage is the actual voltage on the tube and, in a resistance-coupled amplifier, is much less than the voltage across the "B" battery or socket-power unit.) While the drop through the resistance can be compensated by raising the plate voltage, very

few persons find it possible to attain the necessary high voltage for proper operation. In consequence, while distortion due to unequal amplification of different frequencies is avoided, harmonics are frequently introduced as a result of rectification due to overloaded tubes; with consequent confusing distortion in what is claimed to be a distortionless amplifier.

For those seeking the utmost realism in radio rendition, together with reliable operation on reasonable plate voltages, the amplifier shown in the accompanying diagram is suggested, although it need not be followed in precise detail. Three stages of double-impedance coupling may be employed; but increased volume, without perceptible loss of quality, results from the use of one transformer-coupled stage, as indicated. If a great volume of output is desired, a 112-type tube should be used in the second stage, and a 171-type in the last stage, with the usual 201A-type in the first stage.

With A. C. Current Supply

In using impedance-coupled amplifiers with plate supplies having an A.C. source, trouble is sometimes encountered. Several methods of overcoming this trouble are generally successful. The use of different plate voltages on the different tubes of the amplifier is frequently effective. It will sometimes be found helpful to place the transformer in the middle stage of the amplifier. In this case the primary should be reversed if necessary. Condensers placed across the plate-supply binding posts of the receiver help materially in stabilizing the amplifier. Also, to provide the utmost clarity on low, sustained notes, a large condenser, with a capacity of from 10 to 20 mf., may be shunted across the full output of the "B" unit if found necessary.

It goes without saying that the tubes employed in this amplifier must be properly operated, with their full rated filament voltages, ample plate voltages, and proper grid-biasing or "C" batteries.

Because of the excellent frequency-characteristic of this amplifier, nothing but a very high-quality speaker, with distortion reduced to a minimum, should be employed. The high voltage output of the power tube calls for a speaker filter or output transformer. In the circuit shown, a speaker filter is employed. Practically the same results may be obtained by substituting an output transformer.

The results obtained with this combination double-impedance and transformer-coupled amplifier will prove a surprise party to the dyed-in-the-wool broadcast listener, because of the full tone and pleasing musical values of the loud speaker rendition.

SYNCHROPHASE SEVEN RECEIVER

(Q. 2234.) Mr. S. Jacobson, Brooklyn, N. Y., asks:
Q. Kindly print in your columns the descrip-

tion of the latest type of Synchrophase receiver. This is a seven-tube set and employs coils of the binocular type.

A. We are indebted to Mr. W. A. Schudt, Jr. of A. H. Grebe Co. for the following description of this receiver.

Principally by the combination of ingeniously devised tube-isolating circuits and fieldless, space-wound, binocular coils, the following improvements have been achieved: greater and more uniform signal response and selectivity on both the high and low wavelengths within the broadcast band; nullification of all tendency toward oscillation; removal of detuning effects due to differences in vacuum-tube characteristics of any one type; liberal tuning leeway on dial below and above broadcasting range; elimination of critical tuning effects on low wavelengths; accurate matching of tuned stages on all broadcast wavelengths.

The fieldless properties of the binocular coils overcome feedback between the tuned stages and prevent signals from entering the detector except through the first radio-frequency stage. The space-winding of this wire produces a marked increase in selectivity on the shorter wavelengths, where selectivity is particularly desirable.

Close scrutiny of this circuit reveals that we have four stages of tuned R.F. amplification, a detector and two stages of A.F. amplification; the last audio stage being designed for use with a 171-type power tube. In all we have five tuned stages, requiring five variable condensers, with a maximum capacity of .000275-mf. each.

Correspondents asking questions about the construction or operation of home-made sets will prevent delay by enclosing a schematic diagram, with value of the components used; as such circuits are not always standard.

These five individual variable condensers, horizontally mounted and rigidly secured in place, are driven in unison by a three-point tuning-drive device, which is connected with the single dial and vernier on the front of the marquetry panel. The rigidity of the tuning condenser assembly insures the permanency of the accurate factory adjustment.

The letters L and L1 indicate the binocular coils in the schematic diagram above. (Fig. Q2234.) L1 is the primary coil, which is the same in each stage throughout the receiver, and consists of thirty-five turns of No. 36 wire. The secondary coils are divided into two halves, each having 122 turns of 10 x 38 Litz wires.

In the grid circuits of the tuned stages, R, R1 and C1 comprise the newest Grebe feature, the tube-isolating circuits, through which more uniform signal response and better reception on the low wavelengths are obtained, as well as nullification of excess oscillation.

Briefly, the tube-isolating circuit consists of an adjustable condenser having a maximum capacity of 100-mmf., a resistor R, with a value between 3 and 8 megohms, and a second resistor, R1, value 425 ohms.

Note carefully that all of the "A—" terminals are connected to the aluminum "deck," this acting as a ground and master-connector. Where such connections are made they are indicated by the conventional "ground" symbol. Thus the "A—" terminal goes directly to the shield (deck) and to a small by-pass condenser.

The detector stage is slightly different (i.e., the tube-isolating circuit) in that we have here one less resistor; and the remaining one is connected between the grid and the "A+." The adjustable capacity remains at the same maximum as in previous stages, and in the same place in the circuit.

The receiver is adaptable to use with either a short or long aerial, having facilities in the antenna circuit, in the form of a direct connection and a series-condenser connection, for use with either type respectively.

The method employed by the designers of the Synchrophase Seven, of operating five variable condensers through one dial and a tangent vernier, which is unusual, utilizes a three-point driving device which controls through its main shaft the five variable condensers simultaneously. Perfect

(Continued on page 270)

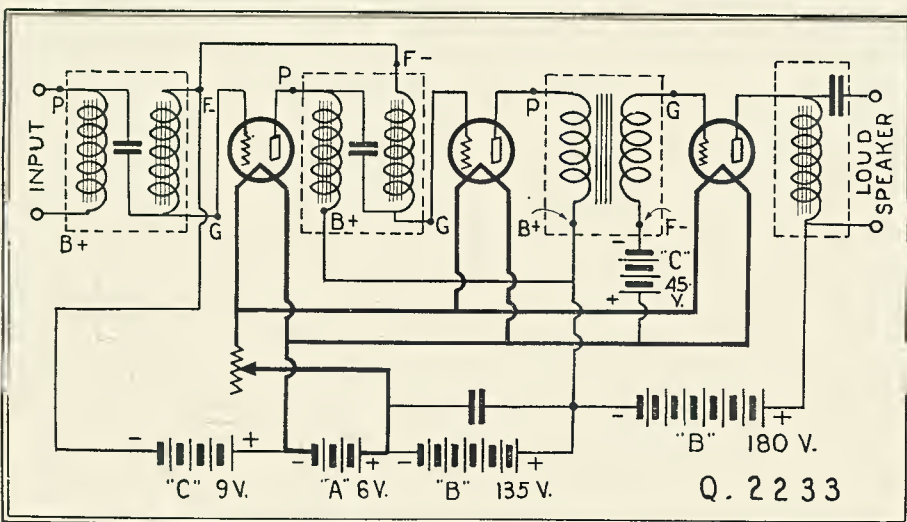

An amplifier which provides a quality of reception that is unusual. The combination of a transformer and dual impedances gives faithful reproduction, throughout the entire musical range, with ample volume.

Scientists Perfect Light Socket Power

OUT of the wizardry of retorts and test tubes, born of molten temperatures far beyond the conception of the average man, scientists have developed a new metal that makes radio light socket power as dependable as your own house current, that demands no more attention than your electric iron, sweeper, or toaster.

Scientists, led by Professor S. J. M. Allen, Ph. D., of the Post Graduate College of Engineering, University of Cincinnati, working with metals and minerals in temperatures and electric furnaces of unheard-of proportions after years of experimenting, succeeded in re-arranging the entire atomic structure of copper, thus converting an ordinary conductor material into this new metal, now known to the scientific world as Kuprox.

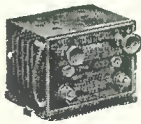

The Replacement Unit, a series of simple Kuprox metal discs, riveted together.

A tiny disc of Kuprox, scarcely as large as a half-dollar now does the work that formerly required charging bulbs, noisy vibrators, and ruinous jars of acid and electrolyte.

Kuprox is now offered in stores of radio dealers the country over in many forms. Units, delivering radio "A" power, radio "B" power, and compact single units from which all radio power necessary for the operation of a set, is obtained are among the new items in which this new rectifying metal is used.

One of its most interesting forms is the Kuprox Replacement Unit, consisting of a series of several Kuprox Discs, with which to replace the acid jar and charging unit on all existing electrolytic trickle chargers and power units. With this unique replacement unit, retailing for only \$4.50, it is but the work of a few minutes to do away with all the bothersome watering and other attention that has been necessary to keep a trickle charger functioning. Two simple binding post connections are all that are necessary. Merely disconnect the present acid jar from the transformer of the trickle charger, throw it away and connect the same two leads to two binding posts on the Kuprox Replacement Unit. Thus any electrolytic charger becomes absolutely dry. In addition to eliminating all the attention necessary with the ordinary wet charger, this replacement unit of course does away with the acid fumes and the possibility of ruined clothing and furniture. The Replacement Unit also gives a great deal higher charging rate, resulting in greater operating efficiency of the battery.

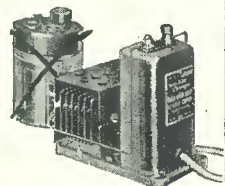

How the Kuprox Replacement Unit replaces the acid jar on trickle chargers.

Revolutionizing Radio Socket Power!

No acid, liquids,
or charging bulbs - -
Dry, permanent power
No watering or bother!

At last, radio power as dependable and permanent as your house current, that requires no more attention than the snap of a switch. KUPROX, the new, dry metallic rectifier supplies all radio power, A, B, and C, constantly, dependably - - probably the greatest of all developments in light socket radio power.

With KUPROX Devices your set is truly electric. KUPROX is all-metal - - dry - - it needs no watching or watering - - it cannot wear out. Various models, from Trickle Chargers to the Combinations which supply all radio power from a single compact unit.

KUPROX RADIO POWER DEVICES

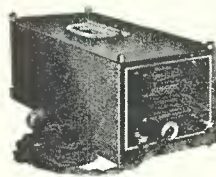

KUPROX "A" TRANSIFIERS—Batteryless, noiseless, electric "A" power. Dry, dependable, needs no attention. Operates any receiver. 4-volt or 6-volt, \$28.50 and up.



KUPROX A & B TRANSIFIERS—All radio power from a single unit. Controlled from set switch. Absolutely dry, requires no attention. \$57.50 and up.



KUPROX "B" TRANSIFIERS—Dry, permanent, free of hum. Models for all sets and circuits, \$14.50 and up.



KUPROX Replacement Unit—For replacing acid jar on all standard trickle chargers and power units. \$4.50

KUPROX Trickle Chargers—1-amp. rate. Large model gives 2½-amp. booster charge. \$10.50 and \$18.50.



[Free Booklet—"The Secret of Battery Elimination." Contains performance curves on most standard eliminators.]

THE KODEL RADIO CORPORATION, 501 E. Pearl St., CINCINNATI, O.

© 1927 K. R. Corp.

Townsend "B" Socket Power "Best in World!"

Says A. W. GALE
of Gloversville, N. Y.



Below is a reproduction of Mr. Gale's letter of May 8th, 1927.

48 W. Fulton St.,
Gloversville, N. Y.

"Received the Townsend all O. K. It is the best in the World and that is saying some. I have a Radiola 4 tube. Get more stations than ever before. Some of them are CFCF, CKNC, WGY, KDKA, WGZ, WIP, WWJ, KTHS, KOP, KOA, WHAS, WTAM and KSD—besides 4 in Chicago, all in the East and then some."

A. W. Gale.

Replaces "B" Batteries

The letter above speaks for itself—proves beyond doubt that the Townsend "B" Socket Power is the most remarkable value in Radio today. Sam E. Fry of 1415 Holmes St., Kansas City, Mo., writes: "Eliminator works fine. Showed it to a friend and he wants one also. I will say it sure beats batteries. I get stations I never got before on a 6 tube set." Charles Ellis, 88 Jones Ave., Columbus, Ohio, says, "Your Eliminator is working fine. Have had station WJAX and others over 1,000 miles distant. Picked up 22 different stations one evening and around 30 a'other time. My neighbor has a \$27.50 Eliminator and I don't see that it works any better than yours."

Delivers up to 100 volts on any set, on D. C. or A. C.—any cycle. Full tone, clarity and volume.

Tested and approved by America's leading Radio authorities—Radio News and Popular Radio Laboratories

ORDER TODAY!

Simply fill out the coupon and slip it into an envelope with only \$1.00 and mail at once. Your Townsend "B" Socket Power Unit will be sent promptly. Deposit only \$5.85 plus postage with the postman. Try out for 10 days—then if not delighted with improvement in reception, return it to us and purchase price will be refunded.

TOWNSEND LABORATORIES
713 Townsend St., Dept 25 Chicago, Ill.

Attach Only \$1.00
to this Coupon!
SEND TODAY



TOWNSEND LABORATORIES
713 Townsend St.
Dept. 25 Chicago, Ill.

Gentlemen: Attached find \$1.00. Kindly send at once Townsend "B" Socket Power Unit, C. O. D., for \$5.85, plus postage, on guaranteed 10-day free trial.

Name _____
Address _____
City _____ State _____

Working on Seven-Foot Waves

(Continued from page 241)

the generated oscillations, and is adjusted simply by the variable condenser, CV. The power absorbed by this transmitter is approximately 80 watts, of which about 70 percent goes to the antenna. This efficiency is rather high.

ANTENNA SYSTEM

The transmitters are set up in the cupola of the institute. The antenna (see Fig. 5)

have grid and plate connections brought out separately to terminals fixed in the top of the glass bulb, an arrangement that keeps the capacity at a minimum.

The complete transmitter employing these tubes was made to operate successfully on 2.12 meters. It is shown pictorially in Fig. 6 and diagrammatically in Fig. 7.

There is no condenser in the plate cir-

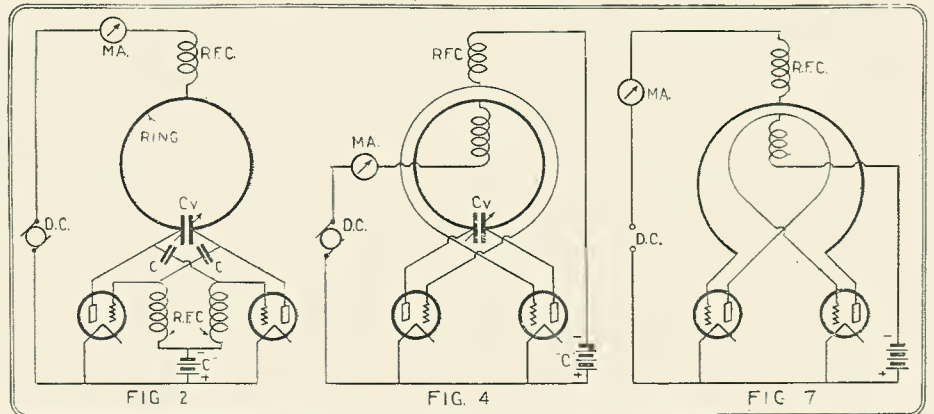

Fig. 2 is a 10-20-meter circuit; Fig. 4, a circuit for 7.05 meters; and Fig. 7, a circuit operating on 2.12 meters. Observe that in the last, no condensers are used; the self-capacity of the apparatus being sufficient.

is a copy of the Hertz "bi-polar," and is mounted at the top of a wooden mast about 40 feet high. It consists of two telescoping tubes, about 7/8 inch in diameter, and can be turned around on its vertical axis.

The coupling between transmitter and antenna is accomplished by a Lecher parallel-wire system, the leads of which are carried to the antenna through porcelain tubes in the cupola wall. (See Fig. 1, in which wires are shown attached to wall.) This system, which involves no direct connection between the oscillator and the antenna, possesses the advantage of high efficiency, and, we believe, is used here for the first time.

Tubes of the two types hitherto used are not suitable for the production of still shorter waves, because of their relatively high internal capacity. Further decrease of wavelength can only be brought about, therefore, by the use of valves with lower inter-electrode capacity. Such tubes are not made in Germany, so French valves of the type known as "E-4-M" were selected. These

cuit, the oscillating circuit consisting of only a wire bow or arc connecting the two plates together; within this wire is another, bridging the two grids. Spirals of wire, as in the other transmitters, are used to carry the grid and plate voltages to the neutral points of the rings, and act as chokes to prevent the R.F. current from wandering into the power-supply circuits. This transmitter draws 170 watts on the plate side—170 milliamperes at 1000 volts. The working efficiency is very high, because of the elimination of all unnecessary capacity.

The plate supply for this 2.12-meter outfit is rectified A.C. The high-voltage transformers, condensers, chokes and rectifier tube composing the power-supply unit occupy the right end of the table shown in Fig. 6. The rectifier tube employed, a German product, contains argon gas.

Practical researches of an important scope will be carried out with the 7.05-meter transmitter, and under the call letters KS9, it will be used for telegraphic communication.

"High-Mu" Tubes Give Ample Volume with Two Stages of Resistance Coupling

CONSTANTS

ALONG with the remarkable tone quality for which resistance-coupled A. F. amplification has long been recognized, many radio enthusiasts are now beginning to realize that there is plenty of volume available with this method, together with a marked economy in battery drain. In fact, for ample loud-speaker volume, operating on "B" batteries, this method will be found more economical than transformer coupling; which makes it desirable for those who employ "B" batteries.

The high-amplification ("high-mu") tubes recently introduced, such as the 240 and similar types, have so increased the amplification per stage for resistance coupling that it compares favorably with the usual stage of transformer coupling. Thus, a two-stage resistance-coupled amplifier, using one of these tubes for the first stage and a power tube for the second, will deliver ample loud-speaker volume, while the "B" battery drain will be found surprisingly low.

The two-stage resistance-coupled amplifier, in its latest form, comprises a high-amplification tube for the first stage, coupled to the detector by means of a 250,000-ohm plate resistor and a 2-megohm grid leak, with a .05-mf. coupling condenser. The second stage comprises a power tube of the 171 or 112 type, with a coupler made up of a 250,000-ohm plate resistor and a 100,000-ohm grid leak, with a .05-mf. coupling condenser. Obviously, the correct plate voltage and "C" battery should be employed for the power tube. The same plate voltage may be applied on the first stage, with a "C" battery of 1 1/2 for 135 volts "B," and 3 for 180 volts. The detector also should be a high-mu tube if only two stages of amplification are employed.



You wouldn't stuff yourself tonight — then go hungry all next week!

DON'T expect your radio storage battery to bring in programs loud and clear when you work it day after day without replenishing the power. Keep the battery strong and active by feeding it regularly— with a Rectigon Home Charger.

Charge at trickle or high rate — Rectigon does both.

With the Rectigon you can get a steady "trickle" to replace "A" power as you use it. In case of heavy drains due to prolonged

use of the set, by a mere rearrangement of the leads you charge "A" or "B" batteries quickly, at a heavy rate. Either way, when you turn on your radio, you have power to spare. There are no acids or chemicals with Rectigon — no moving parts. You just attach the leads and plug into the light socket. It will charge your automobile battery the same quiet, "no trouble" way.

Rectigon, the many purpose charger, at good radio stores.

WESTINGHOUSE ELECTRIC & MANUFACTURING COMPANY, EAST PITTSBURGH, PENNSYLVANIA
OFFICES IN ALL PRINCIPAL CITIES / REPRESENTATIVES EVERYWHERE / TUNE IN WITH KDKA—KYW—WBZ

BESIDES Rectigon for better battery charging, Westinghouse also makes Micarta Panels and tubing for better insulation, and power testing instruments for better reception.

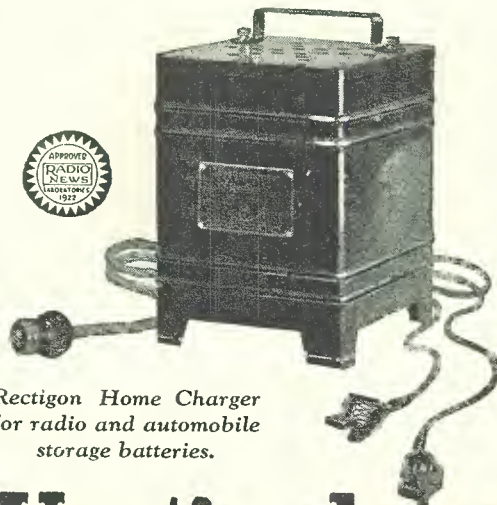

*Rectigon Home Charger
for radio and automobile
storage batteries.*

Westinghouse



ACME

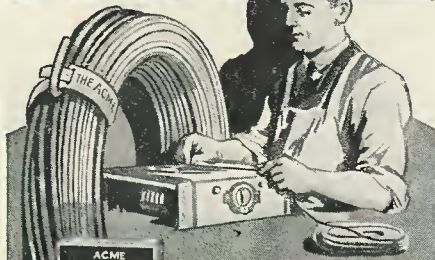

Flexible Celatsite Wire

A cable of fine, tinned copper wires with non-inflammable Celatsite insulation. Ideal for sub-panel or point-to-point wiring. Strips easily, solders readily. Nine beautiful colors; sold only in 25 ft. coils, in cartons colored to match contents.

Acme Celatsite Wire

Tinned copper bus bar hook-up wire with non-inflammable Celatsite insulation, in 9 beautiful colors. Strips easily, solders readily, won't crack at bends. Sizes 14, 16, 18, 19; 30 inch lengths.

Spaghetti Tubing

Oil, moisture, acid proof; highly dielectric — used by leading engineers. Nine colors, for wire sizes 12 to 18; 30 inch lengths. (We also make tinned bus bar, round and square, in 2 and 2½ ft. lengths.)

Stranded Enameled Antenna

Best outdoor antenna you can buy. Seven strands of enameled copper wire. Presents maximum surface for reception, resists corrosion; this greatly improves the signal. Outside diameters equal to sizes 14 and 16. (We also offer solid and stranded bare, and stranded tinned antenna.)

Loop Antenna Wire

Sixty strands of No. 38 bare copper wire for flexibility, 5 strands of No. 36 phosphor bronze to prevent stretching. Green or brown silk covering; best loop wire possible to make.

Battery Cable

A rayon-covered cable of 5, 6, 7, 8 or 9 vari-colored Flexible Celatsite wires for connecting batteries or eliminator to set. Plainly tabbed; easy to connect. Gives set an orderly appearance.

Send for folder
THE ACME WIRE CO., Dept. D
New Haven, Conn.



Loop Operation of the Strobodine

(Continued from page 229)

circuit attached to the Strobodine, and supplying the "A," "B" and "C" current to the power tube in addition to the "B" voltage for all the other tubes.

If a power-supply unit is used with a 210-type tube, care should be taken to turn off the power whenever adjustments are to be made in the audio circuit; because these units deliver a high voltage, which gives a serious shock when touched with the bare hand.

At the right in Fig. 4 are given the constructional details for making the loop for the Strobodine receiver. When constructing this loop care must be taken to have the dimensions and the number of turns correct.

ALL data on the Strobodine Circuit are published in conjunction with RADIO NEWS' sister publication, TSF MODERNE, of Paris. Sole rights to the publication of the Strobodine in the United States are held by RADIO NEWS.

Below is shown the circuit diagram of a socket-power unit that will operate satisfactorily with the Strobodine receiver.

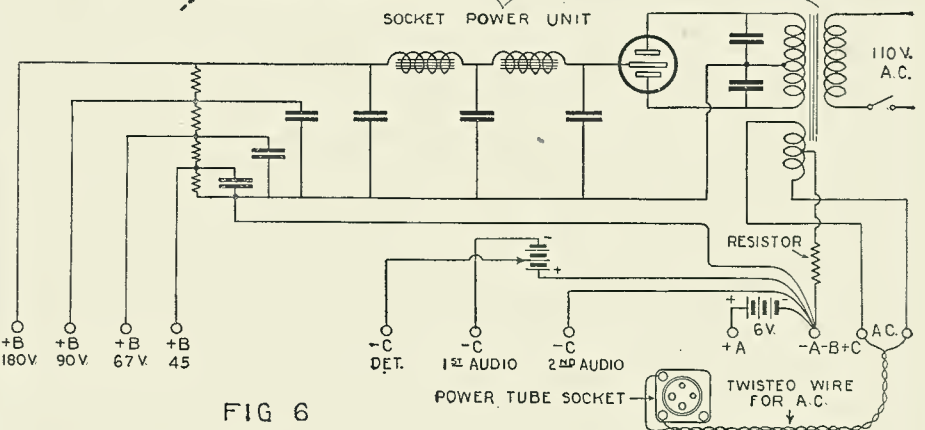
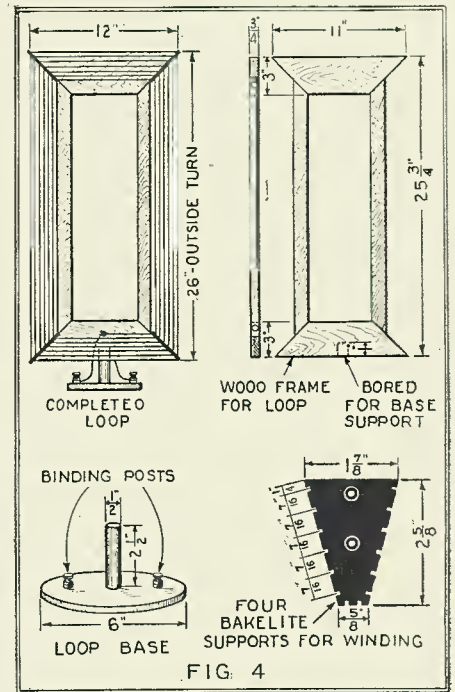

Radio News of the Month

(Continued from page 207)

SHORT-WAVE TIME SIGNALS

IN addition to the 112-kc. (2677-meter) wave on which Arlington has been broadcasting time signals from the U. S. Naval Observatory, at noon and 10 p. m. E. S. T. daily, short-wave transmissions are now being made and will materially widen the range of this service. It is expected that these can be heard from Hawaii to the Eastern Mediterranean by day with suitable receivers; and over a much larger area at night. The frequencies used are 4,015-kc. (74.67 meters), 8,030-kc. (37.34 meters) and 12,045-kc. (24.89 meters); the latter two being harmonics of the first.

BROADCASTING IN INDIA

ELABORATE plans for covering immensely populous India with a chain of high-power stations, making reception possible to millions of inexpensive sets, show tangible result with the completion of a 12-kw. station at Bombay, on the west coast of the peninsula of Hindustan. This is in a time zone 5½ hours east of London.

WIRED RADIO IN AUSTRIA

THE new broadcast station at Innsbruck, in the Tyrol, relays Vienna programs on 294 meters, 500 watts. This station is linked with the studio by four hundred miles of land-line. Of this distance a large portion is covered by power lines, over which the programs are sent at radio frequency. They are again stepped down at Wörgl, 45 miles from Innsbruck, and complete the journey by regular telephone cable.

PORTUGUESE RADIO CHAIN

THE colonial empire of Portugal is now linked with Lisbon by a chain of five stations, the latest of which was recently opened at Lourenco Marques on the east coast of Africa. Others are at Madeira, the Azores, Cape Verde, and Loanda in West Africa.

RADIO SERVICE TO MANILA

DIRECT radio service between San Francisco and Manila has now been established, eliminating relays, by the use of short waves. The new Manila transpacific station has a 40-kw., C. W. transmitter, and is located in the same building with the new high-power broadcast station of that city.

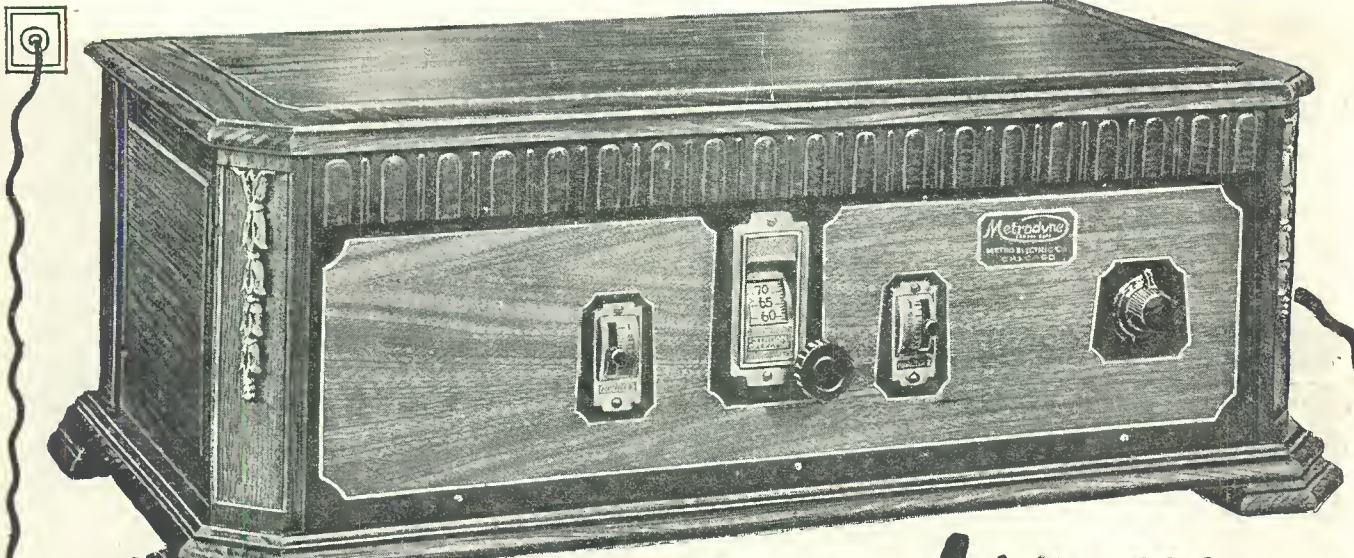

**30
Days
Free
Trial**

**AGENTS! DEALERS!
BIG PROFITS!**

Make big money taking orders for Metrodynes. All or part time. Metrodyne All Electric Radios are in a class by themselves. Unequaled for quality, performance and price. Demonstrate at home and take orders. Lowest wholesale prices. Your demonstrating set on 30 days' free trial. Mail coupon below for details.

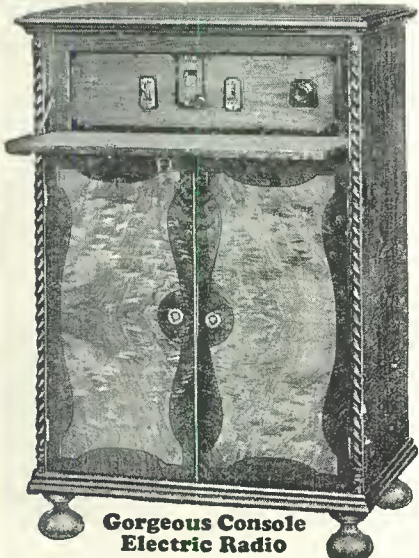

**Gorgeous Console
Electric Radio**

Here is the Metrodyne All Electric Console Radio — a gorgeous, genuine walnut cabinet, in a beautiful two-tone finish. Has a built-in genuine Metro-Cone large size speaker. Brings in programs with great volume, reproducing the entire range from the lowest to the highest notes with remarkable clearness and distinction. All metal parts are finished in old gold. Wonderful electric radio, in a cabinet that will beautify the appearance of any home.

Now! A Real Electric Radio Set

Three Year Guarantee
Shipped direct from our factory at rock bottom prices—cost less than most battery sets

No Batteries, Chargers or Eliminators
No Acids; No Liquids—Plug In—Press Button—"Tune In"

Metrodyne
ALL ELECTRIC RADIO

7 Tubes—Single Dial Set

100% Electric Radio

**BEAUTY—EFFICIENCY
DEPENDABILITY**

At last! The radio you've dreamed about! If you have electricity in your home you can now really enjoy coast to coast radio reception without the care, bother and muss of batteries, chargers, eliminators, etc. The Metrodyne All Electric is a real, genuine batteryless radio set. Simply insert the plug in the socket, press the switch button and "tune in." You could not possibly buy a better radio set than the Metrodyne All Electric, no matter what price you paid.

The Metrodyne All Electric Radio is a 7 tube, single dial set. Only the highest quality low loss parts are used throughout. Solid walnut cabinet, beautiful two-tone effect, with handsome gilt metal trimmings. Size of cabinet, 28 inches long, 13 inches deep, 10 inches high. Has electrically lighted dial so that you can log stations in the dark. Only one dial to tune in all stations. Excellent tone qualities — wonderful volume — very selective.

Costs Less Than Most Battery Sets

Do not confuse the Metrodyne electric radio with ordinary light socket sets, because the Metrodyne is truly an all electric radio — consumes less than 2c worth of power a day. Comes to you direct from the factory. Its low cost brings it down to the price of an ordinary battery set. We are so confident that you will be delighted with this wonderful, easy-to-operate batteryless radio that we offer to ship it to your home for thirty days' free trial — you to be the judge.

Mail This Coupon

We are one of the pioneers of radio. The success of Metrodyne sets is due to our liberal 30 days' free trial offer, which gives you the opportunity of trying before buying. Thousands of Metrodynes have been bought on our liberal free trial basis — WRITE TODAY!

METRO ELECTRIC COMPANY
2165 N. California Ave. Dept. 601 Chicago, Illinois

METRO ELECTRIC COMPANY
2165 N. California Ave., Dept. 601
Chicago, Illinois

Gentlemen:
Send me full particulars about Metrodyne All Electric Radio and your thirty days' free trial offer.

Name _____
Address _____
If you are interested in AGENT'S proposition place an "X" in the square

MAIL COUPON NOW!

The Famous AERO Short Wave Kit Used in Important New Circuit!

Be sure to read all about the new circuit employing these improved coils described in RADIO NEWS.

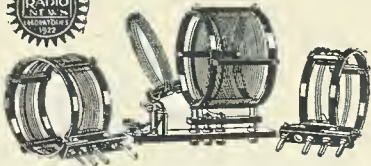

AERO LOW WAVE TUNER KIT

Code No. L. W. T. 125 . . Price \$12.50

Always the prime favorite of all experts and amateurs insistent upon the very best in short wave reception, the AERO Low Wave Tuner Kit for this season has been made even better than ever!

As used in the new short wave circuit described in RADIO NEWS, these improved coils are certain to produce performance beyond compare. Even greater volume, selectivity, tone quality and flexibility is definitely assured.

USED BY TWO FAMOUS EXPEDITIONS

The AERO Coils used in the AERO Short Wave Kit have proved themselves so extraordinarily efficient that they have been selected for use on the University of Michigan's Expedition to Greenland (1926-27-28) and on the MacMillan Arctic Expedition. No greater proof of their efficiency could be offered than by their selection for these important tasks.

The AERO Low Wave Tuner Kit illustrated above is completely interchangeable. The kit itself includes 3 coils and base mounting covering U. S. bands 20, 40 and 80 meters. You can increase the range of this kit to 725 meters by use of AERO interchangeable coils No. 4 and 5 (Price \$4.00 each) or you can decrease the range to go as low as 13 meters by use of AERO interchangeable coil No. 0 (Price \$4.00).

By all means build this new RADIO NEWS Short Wave Set. The AERO coils used in its construction can be procured from your dealer or direct from our factory. We have also arranged to furnish the Westinghouse Micarta drilled and engraved panel for this receiver direct from our factory. Write us at once for full information.

AERO PRODUCTS, INC.

Dept. 105

1772 Wilson Ave.

Chicago, Ill.

The New AERO Choke 60

Modern circuits of high sensitivity demand the use of radio frequency chokes in certain parts of the circuit. The AERO Choke 60 is designed to have a uniform choking action over a wide range of wave lengths, including Broadcast bands and Amateur short wave bands as well. Many chokes employed for this service have an unpleasant characteristic of showing so-called "holes" in the tuning range, that is, points on the tuning dial where the receiver cannot be made to oscillate. These conditions are completely corrected with the new AERO Choke 60. Price \$1.50 each, at your dealer's or direct.



WORLD SYNCHRONIZING SIGNALS

A PROPOSAL which may seem fantastic, but may be some day realized, is made by an English correspondent, G. Chapman, in *Wireless World* (London), to the effect that, with the increasing demand for television, a worldwide wavelength should be set aside for synchronizing signals. A high-power station, according to this plan, would be devoted to sending forth standard-frequency signals of this kind, by which all television machines could be regulated, as well as radio clocks operated. While in the future, this idea seems like one which may be practical with the development of the art.

RADIO FAN GREET'S FLIERS

THE first reception in Europe was given to Chamberlin and Levine, immediately after their forced landing, by a German engineer, A. Amling, who had been listening to radio reports all night, while he worked on an amplifier. Seeing the descent of the plane he rushed at once to the spot, constituted himself a reception committee and interpreter; and sent in to Berlin the first notification of its arrival. "That I was able to observe the fliers so quickly and assist them," said Herr Amling, "is not the least of the services rendered by broadcasting."

—Frank A. Gibson.

The readers of RADIO NEWS are invited to co-operate by the contribution of news items which concern novelties in radio or in the uses to which it may be put; especially those in which the element of human interest is found. Government announcements or press dispatches of general circulation will not qualify; send stories of something that has happened in your own vicinity. They should be short; for each one published \$1.00 will be paid. Address News Editor, RADIO NEWS, 53 Park Place, New York City.

COMBINATION SHORT-WAVE RECEPTION

WHILE the carrying power, at long distance, of the higher radio frequencies (short waves) has been demonstrated most remarkably in the past year, even these are subject to severe fading. In recent tests at Keston, England, by the B. B. Co., on reception from Schenectady, use was made of the fact that different waves fade at different times. Two short-wave receivers were tuned, one to 32.8 and the other to 22 meters, and their combined output was fed into one loud speaker. The transmission was thus made remarkably steady. The drawback, however, is that the atmospherics ("static") were doubled in strength. However, the experiment seems to indicate remarkable possibilities in the way of improving long-range broadcasting. It will be tested upon European chain stations; and similar tests might be made by American listeners with two receivers upon the "network" programs.

EMERGENCY RELAY TRANSMISSION

EACH broadcast station in Great Britain is now equipped with a receiver which can be connected to the control board for rebroadcasts; thus providing a reserve method of carrying on, in case of a failure of the land-lines linking the station with others. This is said to have been used at Glasgow during the general strike, which affected the British postal telephone and telegraph service.

RADIO IN THE RED SEA

OIL prospectors in the Red Sea are the latest of the world's isolated communities to adopt wireless as a means of communication with the nearest centres of civilization. Islands, in the Farsan group, are being prospected by the Red Sea Petroleum Company, and are being equipped with transmitting (spark) and receiving apparatus of the type used on board ships.



Licensed by Rider
Radio Corporation
Pats. Pending

Pat'd 5-2-'16
7-27-'26

Are You Tired Of Oscillations?

"Phasatrols"

**A True Balancing Device for
Radio Frequency Amplifiers**

\$2.75

More and more, fans throughout the country are using Phasatrol to control the old bugaboo of oscillation.

This instrument, which can be installed in a few minutes' time, has proven of complete satisfaction to old and new radio enthusiasts. Ask your neighbor, or, better still, try one yourself.

**Write for free hook-up circuit
for any set or circuit.**

Dept. 45A, 175 Varick St., New York, N.Y.

ELECTRAD

Nathaniel
BALDWIN
LOUD SPEAKERS

A Famous Speaker



Benj. Franklin once said:
"My performance devotes itself entirely to thy service & will serve thee faithfully and if it has the good fortune to please thy master, tis gratification enough for the labor of—"
—Poor Richard

The New "99"

is, without comparison. To-day, as 15 years ago, Baldwin performance is the standard by which others are judged, comparable to the sensitive mechanism of a fine watch. At all good dealers . \$23.50 Can be used on any set. Ask your dealer to demonstrate it. Write for booklet.

BALDWIN UNITS
Loudspeaker units, Phono adapters, and head sets are standard the world over.

J. W. & W. L. WOOLF
Distributors & Exporters
227-229 Fulton St., N. Y.



RADIO PANELS

OF GENUINE BAKELITE

Cut, drilled and engraved to order. Send rough sketch for estimate. Our Complete Catalog on Panels, Tubes and Rods—all of genuine Bakelite—mailed on request.

STARRETT MFG. CO.
520 S. GREEN ST. CHICAGO

BOSCH RADIO 5-6-7 tube receivers wired for battery or socket power. Cone type reproducers—"A" and "B" power units. Beautiful cabinets. **AMERICAN BOSCH MAGNETO CORP.** Springfield, Mass. Write for Booklet.



**B. S. T.
CONE
SPEAKER**
\$7.50

18-Inch Cone with Adjustable Unit. Excellent low-note reproduction.

Guaranty Radio Goods Co.
Dept. N, 143 W. 45th St.
New York City

**More Volume!
Greater Distance!
Better Quality!**

**All of These at Your Command
When You Use a De Luxe
Model BRETWOOD VARIABLE GRID LEAK**

When you are deciding on what parts are to go into the receiver you are about to build, under no circumstances dismiss the grid leak with only casual consideration. Respect the grid leak as something well worthy of expert choice.

The best course is to select a variable grid leak with an ample resistance range, one that may be mounted on baseboard, sub-panel or front panel, as you prefer.

Such a leak is the BRETWOOD VARIABLE GRID LEAK, which is now on the market in new de luxe model, representing improvements in mechanical strength, electrical efficiency and utility.

You should use a variable grid leak like the BRETWOOD VARIABLE GRID LEAK in a set you are about to build, or should put one in your present receiver, because it will enable you to get highest operating efficiency from the detector tube. As nearly all tubes used as detectors draw grid current, the resistance value of the leak is important for biasing and discharge purposes. Not only can exactly the right degree of flow be established to discard excess electrons, but the grid-to-filament impedance is so affected as to afford best selectivity under the circumstances. Only a variable leak gives this precision choice.

You prevent overloading of the detector tube by correct leak setting. This improves tone quality considerably. Often if your set sounds distorted, this is immediately and permanently remedied. Hence you reap greater volume, better selectivity and purer tone quality—all by the simple insertion of a BRETWOOD DE LUXE MODEL VARIABLE GRID LEAK.

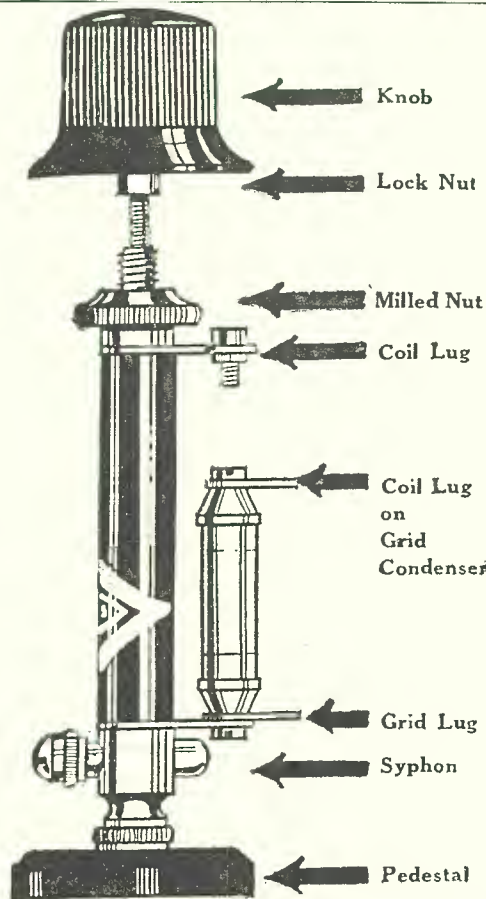

The De Luxe Model Bretwood Variable Grid Leak is shown in actual size. The lock nut secures the knob to the threaded shaft. The milled nut secures the leak to the front panel, if such mounting is desired. The coil lug goes to the outside of the secondary and to the corresponding lug on bullet grid condenser. The grid lug is connected to the grid post of the detector tube socket. The syphon contains the secret resistance element. The pedestal is for baseboard mounting.

North American Bretwood Co., 141 West 45th St., N. Y. City.

Gentlemen: Enclosed find \$1.75. Send me at once one De Luxe Model Bretwood Variable Grid Leak on 5-day money-back guarantee. (Or \$2.25 for leak with grid condenser attached.)

NAME

ADDRESS

CITY STATE

Inquiries Solicited from the Trade
Dealers: If your jobber can't supply you, write us

**BLUEPRINTS
OF INEXPENSIVE
DX RECEIVERS**

THE FIVE-TUBE DIAMOND OF THE AIR, a very selective circuit of thrilling tone quality, that brings in distant stations to the great delight of the fans, is easily built, in fact can be constructed in a couple of hours. The authorized blueprints that make this speed and efficiency possible will be shipped at once, together with a booklet of full textual exposition of construction, including winding of coils, how to connect coil terminals, what values of condensers and resistors to use, etc. If you want a tone quality set that will give you great enjoyment, be sure to build this five-tube Diamond of the Air. The receiver consists of a stage of tuned radio frequency amplification, a specially sensitized detector, first stage of transformer audio and next two stages of resistance audio. It is easily adapted to playing phonograph records on your speaker.

THE FOUR-TUBE DIAMOND

represents the most that is obtainable from four tubes. A stage of tuned radio frequency amplification, a specially sensitized detector, and two stages of transformer coupled audio. Follow the diagrams as shown in the blueprint and you can't go wrong. You will be amazed at the results. Build the set from parts that you have. Full instructions cover utilization of such apparatus. Thousands are eager to build an economical set and this one is the most economical in cost of construction and upkeep, where one considers the surpassing results. Works splendidly from batteries, with either type 99 or type 01A tubes, and can be used with A and B eliminators, power packs, etc. with great success.

SPECIAL OFFER!

Send in 75c and we will ship you immediately the blueprint of the Five-Tube Diamond and the blueprint of the Four-Tube Diamond, also the Five-Tube booklet and the textual data on building the Four-Tube. Besides all this, as a premium we will send with each such order one Auto-Strop Safety Razor, including one razor, one blade and one automatic razor strop.

Price of Five-Tube Diamond blueprint and booklet alone 25c.
Price of Four-Tube Universal blueprint and textual data alone 25c.

Guaranty Radio Goods Co.
Dept. N, 143 West 45th Street
New York City

Thousands Use These Ingenious TRANSMITTER UNITS

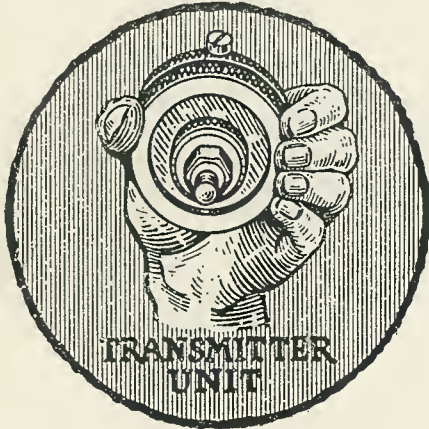

Here's a marvel of engineering design—a practical miniature transmitter, used by thousands of radio fans and experimenters for amplification purposes. It is a most novel unit, having hundreds of uses. Every amateur should have two or three of these amplifiers in his laboratory.

A FEW USES FOR THESE UNITS

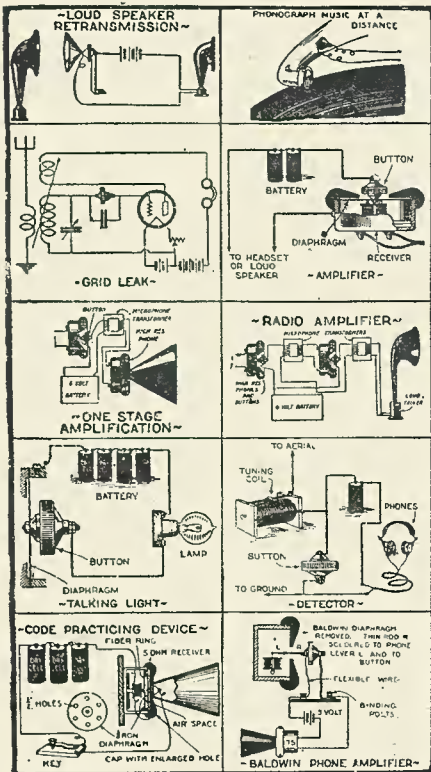

With each unit is mailed an eight-page instruction pamphlet containing suggestions for innumerable uses. Our supply is limited; avoid disappointment by ordering today. The coupon below is for your special convenience.

SPECIALY PRICED AT 95c (or Two for \$1.75) per unit

THE PRESS GUILD, 16-R East 30th St., New York, N. Y.

Enclosed find 95c/\$1.75 for which send me postpaid one/two amplifier units as advertised.

Name _____
 Address _____
 City, State _____

SHIP AND SHORE QRM

ONE of the important problems before the international radio conference this fall, announces Radio Commissioner Caldwell, in reply to complaints on this score, is that of interference between ship transmitters and broadcast stations located near the seacoast. The SOS and calling band is especially close to the broadcast wavelengths, as listeners have often been made aware. However, this ship service is of the highest importance, and only international action can change this wavelength away further from the broadcast band.

ENGLAND TURNS TO K.C.

JUST as in America, so in England are endeavors being made to establish the use of "kilocycles" as a popular phrase; and, just as here, strong resistance appears to be encountered. The British Broadcasting Company now announces its station transmissions in kilocycles.

RADIO AT THE MAGNETIC POLE

EVEN more interesting, scientifically, than the north pole is the magnetic pole, and as little visited. The Putnam expedition, now at West Baffin Island, north of the continent of America, will approach this spot and conduct experiments as to the effects on radio of the earth's magnetic field. The party's schooner, the *Morrissey*, carries a battery-powered transmitter, working on 20 and 33 meters, and both short- and long-wave receivers.

POWER DEVICES INTEREST GERMANS

THE trend of German receiver development is shown by the action of the Reich Rundfunk Gesellschaft, central organization of all German broadcasting, in offering prizes for the best home-built sets shown at the national exhibition to be held in September at Witzleben, near Berlin. Three first prizes will be given to the best sets deriving their power from the A. C. house mains; one for a crystal detector with amplifier, one for a four-tube set, and one for a DX receiver using multiple tubes.—*Frank A. Gibson.*

TUBES REPLACE CRYSTALS

HITHERTO the British listener has remained content with the crystal, it has been asserted; but a recent survey made by the British Broadcasting Company indicates that over 50% of British fans are now using tube sets.

Our British cousins persist in being different. Notwithstanding their nautical inclinations, they describe motorboating in audio amplifiers as "motor-biking."

HIGH R. F. RESISTANCE

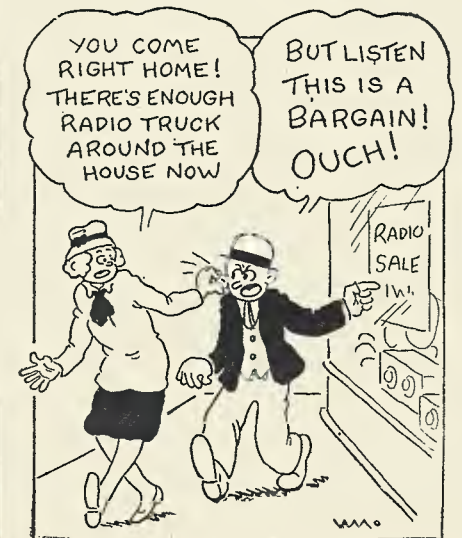

NATIONAL B-POWER SUPPLY

A new designed B-Eliminator, with special features not hitherto offered to the public, will be announced in the near future. The unit is small, light, simple and easy to connect. The price will be attractive.

The new NATIONAL B-POWER SUPPLY is manufactured under license association with Radio Corporation of America, General Electric Co., Westinghouse Electric & Manufacturing Co., and the American Telephone & Telegraph Co.

BE SURE YOU GET THE GENUINE

NATIONAL RADIO PRODUCTS

Send for Pamphlet N-9 NATIONAL CO., Inc., Malden, Mass. W. A. Ready, Pres.



Our dealing direct brings this cabinet to you at half the usual retail price. Made either from selected hardwood, with Mahogany finish or from solid Walnut, rubbed to a beautiful piano lustre, the Iveyline Cabinet makes a fitting climax to your set-building efforts. It has full length, nickeled piano hinge, nickeled lid support, rubber feet to prevent vibration and lid splined to avoid warping. Fully illustrated catalogue available. Just write. If you send us your order today, the cabinet will be on its way within 12 hours from receipt of order. Select your size and finish and mail your order today. Cash with order or if C.O.D. half price with order.

"The Iveyline"

	Mahogany Finish	Solid Walnut
7x18x10.....	\$5.50	\$6.50
7x21x10.....	6.00	7.00
7x24x10.....	6.25	7.50
7x26x10.....	6.75	8.00
7x28x10.....	7.00	8.50
7x30x10.....	7.25	8.75
7x18x12.....	7.00	8.00
7x21x12.....	7.50	8.50
7x24x12.....	7.75	9.00
7x26x12.....	8.25	9.50
7x28x12.....	8.50	10.00
7x30x12.....	8.75	10.25

All prices f.o.b. Hickory

12 hour service factory to you

Southern Toy Co. Inc. Manufacturers Hickory N.C.

Enjoy a Big Powerful Radio: 30 Days FREE!

MIRACO Ultra
 27 in. long
 Users everywhere report it gets Coast to Coast, Canada to Mexico, loud and clear on speaker; outperforms \$100 to \$200 sets. Some hear Europe. Marvelous bargain! Don't buy unless 30 Days Trial proves it Most Selective, Clearest and Most Powerful Distance-Getter among big, fine 5-tube radios. Retail LIST price, now \$49.75. **Factory Prices—SAVE UP TO 1/2!** Every set completely assembled, rigidly tested, fully guaranteed. Single Dial Sets, Speakers, batteries, tubes, etc., at big savings. **Free literature, users' testimonials and BIG SPECIAL OFFER!** **USER-AGENTS WANTED** Write for discounts
 Pioneer Builders of Sets
 Send for Proof 404, 0 Miraco Bldg., Cincinnati, O.

WHOLESALE PRICES

--- For Dealers, Community Set Builders, General Repairmen and Agents ---

WE have just issued a new catalog with net prices to the radio trade. This company is Radio's oldest radio parts mail order house, and the new confidential discounts on standard Radio Merchandise are given only for resale purposes. We are ready now to appoint several thousand additional radio dealers and radio agents all over the country, so if you are contemplating going into the rad io business, be sure to get in touch with us at once.

IN SENDING IN YOUR COMMUNICATION TO US, BE SURE TO USE YOUR LETTERHEAD.

In case you are not entitled to whole sale prices, address your request for our No. 17 Catalog to our Retail Department, and note that our retail prices are considerably less than current radio prices and less than those of most radio mail order supply houses.

—and don't forget, on practically all retail orders—we pay all transportation!

1927
Edition

No. 17

500
Illustrations

NEW

Enlarged
Edition



**THIS
100 PAGE
RADIO
CATALOGUE
FREE**

75 HOOKUPS



BUY!!

from Radio's Oldest Mail Order House

WE are the oldest established, exclusive radio mail order house in the country. Our motto is "Quick Shipment." All orders are shipped within 24 hours. Quick, prompt, courteous service. We carry a larger variety of radio parts and findings than any other radio house in the country.

"RASCO HAS IT"

If you are in need of certain small radio parts that other radio and mail order houses do not bother to carry, get the Rasco parts catalog and you will find them there, anything from a screw to copper ribbon and telephone diaphragms, as well as thousands of other small radio findings. Just to mention a few:

Lugs, nuts, dials, vernier dials, jacks, plugs, every kind of knob, cords, panels, screws, sliders, washers, selenium, tinfoil, switches, crystals, cap nuts, litz wire, cord tips, brass rods, resistances, name plates, spring binding posts, switch parts, metal ribbon, carbon balls, binding posts, all types, switch points, switch levers, lock washers, carbon grains, ground clamps, metal pointers, insulated tubing, low melting metal, antenna connectors, bus bar wire, as well as thousands of other articles.

We carry the Largest Variety of Small Radio Parts in the World. BUT We also carry ALL standard radio merchandise. ANYTHING IN RADIO

RADIO SPECIALTY CO.

98W PARK PLACE
NEW YORK CITY, N. Y.

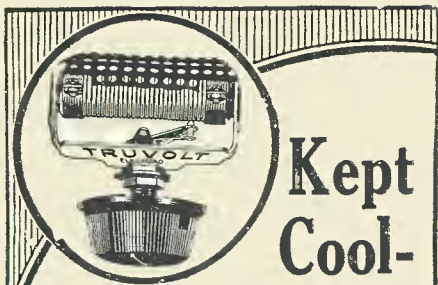

Kept Cool-

Like an Air-Cooled Engine!

TRUVOLT

A Variable Power Resistor

Truvolt, a wire variable high resistance of special mechanical construction, is air cooled on the same principle as Lindbergh's transatlantic motor. This results in a greater radiation area and adapts it especially for B Eliminators and power devices.

1. Made entirely of wire; permanently accurate and long life.
2. Permits potentiometer control; positive metallic contact at all times.
3. Nichrome wire resistance—very low temperature coefficient. Only heat resisting materials used.

Type	Ohms Resistance	Milliamperes Current
T- 20	0 to 2,000	112
T- 50	0 to 5,000	71
T-100	0 to 10,000	50
T-250	0 to 25,000	32
T-500	0 to 50,000	22.5

All rated at 25 watts

Also full line of fixed wire resistances. Write for free resistance booklet.

Dept. 12, 175 Varick Street
New York City

"This is an Eliminator Year"

ELECTRAD

Valley Chargers

Manufactured by
VALLEY ELECTRIC CO.,
ST. LOUIS, MO.

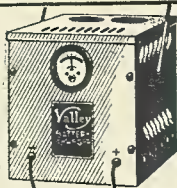

RADIO'S BEST WIRE
From the Ground Up At All Dealers

HOME FURNISHINGS ON CREDIT - Catalog FREE

Over 1400 bargains in living room, dining room and bedroom furniture, rugs, dishes, etc. A year to pay. 30 days trial. Write today for free catalog.
STRAUS & SCHRAM Dept. 3576 Chicago, Illinois

Silent Dynamite

(Continued from page 215)

by the linemen for repairing the trolleys. Thus they were able to proceed with more certainty. The suspected area grew smaller and smaller.

Traffic was now at a minimum, and they were able to work more rapidly. In a few hours, they had reduced the unexplored area by half.

Suddenly, at five o'clock, the noise ceased. The engineers waited, but it did not continue. Finally, they gave up the search for the night. The engineers went home to sleep; but Harold Dare, ever mindful of his waiting public, and of his contract, caught a scant two hours' nap, and appeared at the Flicker Film Studio at the usual time.

At eleven o'clock that night, the Dare staff assembled once more. Harold Dare was there, keen as ever, in spite of his loss of sleep. They stationed themselves about the unexplored zone, and recommenced operations. Tonight the noise was louder than ever; it roared for seconds at a time, and flashed constantly.

Steadily the engineers closed in. At last, they converged upon one block. The trouble was obviously between the two corners. Working toward each other, they cut the trolley at each support. Behind them came electricians, who re-soldered the wire as each section was cleared. At length, one section lay between them. That section must contain the source of the trouble.

There seemed nothing amiss. Scott himself had mounted one of the ladders, and was inspecting the wire with the aid of a flashlight. The wire seemed all right. Then he moved slowly along the supporting wires, which ran above the sidewalks to metal poles.

"Oh, Mr. Dare!" called Scott, with an exclamation.

The actor climbed the ladder. The beam of the flashlight was trained upon a heavy wire, which was fastened to the guy wire below the insulator which insulated the trolley from the pole!

"There is foul play here!" cried Scott, for the wire ran upward a few feet and disappeared through a porcelain tube into the building.

But Harold Dare had become all action. In an instant he had leaped into his car. "Watch the front entrance!" he shouted, and, with a word to the chauffeur, was off like a shot, down the street, round the corner, to the alley behind the building. Dare's keen mind foresaw that whatever criminal might be working his nefarious design, tapping the trolley company's lines, he would probably be alarmed at the arrival of the trucks, and abandon his enterprise.

His surmise was correct. As he swung into the alley, he saw a car standing in the middle of the block. He put on a burst of speed; but even as he did so, a tall man dashed out of the building, leaped into the car, and was off in a flash.

Dare's car leaped forward as the chauffeur pushed the throttle to the floor. He gained—then the other car shot out into the street.

There was a squeal of brakes, and a yellow street car bore down upon the automobile, sending it crashing into the curb.

Dare was the first to reach the wrecked car. As he flashed a light upon the tall man who lay limp at the steering wheel, Dare gave a start. The light disclosed an evil face which film-fans of the world heartily despise as that of vile Dandy Diavolo, hated villain of a thousand Flicker Films, and originator of innumerable fendish schemes to harm and discredit the universally-loved Harold Dare!

You will find that ACE Hard Rubber PANELS

have superior insulating values and easy working qualities—yet they cost no more than ordinary panels. Ask to see the new ACE Crackle Surface and Walnite Surface Panels.

Order from your dealer
or write to

AMERICAN HARD RUBBER CO.
11 Mercer Street
New York, N. Y.

ONE YEAR of Perfect Reception or we MAKE GOOD



**VOGUE
NONPAREIL**

FANS

Vogue tubes are made in all types. If there is no Vogue dealer in your section, write us direct for information on our long life guarantee.

Folder on Request.

ALLAN MFG. CO.
HARRISON, N. J.

Los Angeles 487 C. of C. Bldg. Chicago 100 W. Chicago Ave.

BUILD A GENUINE TRU-TONE BALSA WOOD SPEAKER

Marvelous new discovery, Balsa Wood. Gives sweetness of tone never before heard—and remarkable clearness. Light as a feather—can be painted or draped to harmonize with room—easily made up into handsome speaker that you will be proud to own.

COMPLETE KIT \$6.50 LESS UNIT
Size 36 x 20 inches
with full instructions
postage paid. Any cone unit can operate the Balsa Speaker.

Clip this coupon.
NAME
ADDRESS
Please send—Kit
Booklet
SPECIAL OFFER TO DEALERS
Balsa Laboratories, 205 Greenwich St., N. Y. City

SUCCESS

From

CHEMICAL INSTITUTE OF NEW YORK
16 East 30th Street, New York City.

Mountoursville, Pa.

Gentlemen: I must tell you the success I have had since taking your chemistry course. My salary has been increased several times, and different industrial plants are coming to me for a little advice on different things, netting me a fair side income.

I am only sorry that I did not make My whole life study of the wonderful science.

(signed) M. E. Van Sickle.

CHEMISTRY

NOW
is the TIME to Study
Chemistry

Not only are there boundless opportunities for amassing wealth in Chemistry, but the profession affords congenial employment at good salaries to hundreds of thousands who merely follow out its present applications. These applications are innumerable, touching intimately every business and every product in the world. The work of the chemist can hardly be called work at all. It is the keenest and most enjoyable kind of pleasure. The days in chemical laboratory are filled with thrilling and delightful experimentation, with the alluring prospect of a discovery that may spell fortune always at hand to spur your enthusiasm.

Easy Monthly Payments

You don't have to have even the small price of the course to start. You can pay for it in small monthly amounts—so small that you won't feel them. The cost of our course is very low, and includes everything, even the chemistry outfit—there are no extras to buy with our course. Our plan of monthly payments places a chemical education within the reach of everyone. Write us and let us explain our plan in full—give us the opportunity of showing you how you can qualify for a highly trained technical position without even giving up your present employment.

CHEMISTRY has no equal as a profession in the modern world. There is mystery, romance and fortune awaiting the man in the laboratory.

Millions have been made by the discoverers of the chemical formula of dynamite, bakelite and many other world known chemical products.

Opportunities in the chemical profession abound on every hand—and as modern business and competition progresses the chemist will play an important part.

Profit by the experience of Mr. Van Sickle and many others, resolve to study chemistry NOW.

YOU CAN LEARN AT HOME

To qualify for this remarkable calling requires elaborate specialized training. Formerly it was necessary to attend a university for several years to acquire that training, but thanks to our highly perfected and thorough system of instruction, you can now stay at home, keep your position, and let us educate you in Chemistry during your spare time. Even with only common schooling you can take our course and equip yourself for immediate practical work in a chemical laboratory. Dr. Sloane gives every one of his students the same careful, personal supervision that made him celebrated throughout his long

career as a college professor. Your instruction from the very beginning is made interesting and practical, and we supply you with apparatus and chemicals for performing the fascinating analyses and experimental work that plays such a large part in our method of teaching, and you are awarded the Institute's official diploma after you have satisfactorily completed the course.



T. O'CONNOR SLOANE,
A.B., A.M., LL.D., Ph.D.

Noted Instructor, Lecturer and Author. Formerly Treasurer American Chemical Society and a practical chemist with many well known achievements to his credit. Not only has Dr. Sloane taught chemistry for years but he was for many years engaged in commercial chemistry work.

Special 30 Day Offer

Besides furnishing the student with his Experimental Equipment, we are making an additional special offer for a short while only. You owe it to yourself to find out about it. Write today for full information and free book "Opportunities for Chemists." Send the coupon right now while it is fresh in your mind. Or just write your name and address on a postal and mail it to us. But whatever you do, act today before this offer is withdrawn.

DON'T WAIT—MAIL COUPON NOW!

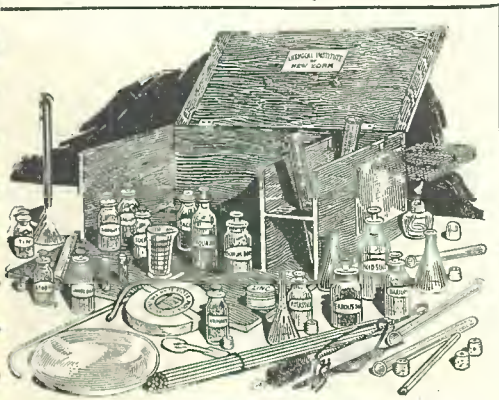

EXPERIMENTAL EQUIPMENT FURNISHED TO EVERY STUDENT

We give to every student without additional charge this chemical equipment, including forty-nine pieces of laboratory apparatus and supplies and forty different chemicals and reagents. These comprise the apparatus and chemicals used for the experimental work of the course. The fitted heavy wooden box serves not only as a case for the outfit but also as a useful laboratory accessory for performing countless experiments.

Chemical Institute of New York

Home Extension Division 9

16-R- East 30th St.
New York, N. Y.

CHEMICAL INSTITUTE OF NEW YORK
Home Extension, Division 9
16-R—East 30th Street, New York City.

Please send me at once, without any obligation on my part, your free Book "Opportunities for Chemists," and full particulars about the Experimental Equipment given to every student. Also please tell me about your plan of payment and your special 30 day offer.

NAME

ADDRESS

CITY STATE.....
R.N. Sept., '27.



BOTH LEADERS

—and Adopted
by Leaders!

Durham Powerohms (for "B" Power Supply Units) and Durham Resistors are the recognized leaders in their field. Both are metallized. Both are made to exacting standards. Both are noiseless. Both are supreme in durability. Both are used by leading manufacturers, sold by leading dealers and endorsed by radio fans everywhere. Durham Powerohms, 500 ohms and 10 megohms, are made in 2.5 watt and 5 watt sizes, each in all ranges and with special standard or special tips.

DURHAM
RESISTORS
& POWEROHMS
International Resistance Company
2 1/2 S. 20th St., Philadelphia, Pa.

just out!
GET YOURS QUICK

Don't wait! Send today for this wonderful book. See how 14,000 live radio dealers make bigger profits by buying from The Harry Alter Company, America's foremost wholesalers of receiving sets, kits, parts and accessories—the largest stock of standard, nationally advertised radio goods carried anywhere.

RADIO'S GREATEST CATALOG

Compare its low prices with those of any other catalog. You will be amazed. Note: We sell only to radio retailers. Write for your copy NOW.

The Harry Alter Co.
1736 Michigan Avenue CHICAGO

You can be quickly cured if you

STAMMER

Send 10 cents for 288-page book on Stammering and Stuttering "Its Cause and Cure." It tells how I cured myself after stammering 20 yrs. B. N. BOGUE, 6971, Bogue Bldg., 1147 N. 111 St., Indianapolis.

EVEREADY
Radio Batteries
—they last longer

A lesser man would have rejoiced, perhaps, at the misfortune of his chief enemy; but the great heart of Harold Dare throbbed with sympathy even for the cruel monster who lay unconscious before him. Diavolo's fluttering eyelids told Dare that the villainous actor still lived. "Stand back," cried Harold Dare to the crowd that was gathering about the car. With the help of one or two bystanders, he lifted Diavolo from the wreck and laid him gently upon the seat of his own automobile. "To the hospital as fast as gasoline will take you!" he commanded; and the chauffeur set off at full speed to save the life of Dare's unworthy persecutor.

As he returned to the scene of the evening's activity, Dare saw that Scott had dismissed the trolley company's trucks. Outside the building to which the disturbance had been traced, stood a police patrol-wagon. Dare made for the entrance to the building, but almost collided with a group of burly bluecoats. Behind them followed a dozen or so of men—Dare's engineers!

The officers halted in amazement at the sight of the great film actor's face; for in the whole civilized world, there lives not one follower of the films who would not know the screen sultan at sight.

"Where are you going with my engineers?" demanded Harold Dare, quietly.

Abashed, the policemen fumbled with their caps. "Excuse us, Mr. Dare," they begged. "We didn't know they were yours."

Dare dismissed them with a curt nod. "You may go," he said. "Don't forget your handcuffs."

Scott touched Dare's arm. "Mr. Dare," he said, "we have unearthed the root of the whole mystery." Dare followed the engineer down several flights of stairs, to the lowermost sub-basement of the building; and there, in a corner of the little room, lay the object of their search.

For the wire which tapped the trolley line terminated in a black resistance box, whence led a heavy, insulated flexible conductor. At the end of this was soldered a large clip with insulated handles. To a water-pipe which ran straight into the floor and thence to the ground, was connected a second cord, which also ended in a clip. Each of the two clips was fastened to a piece of steel—the reinforcing steel which projected from the concrete of the wall. Between the two clips, the concrete was cracked and crumbling, exposing a network of small wires. Many of the wires had been pieced and the joints taped. On the floor lay pliers, rubber gloves, a spool of solder, and an electric soldering iron.

"What is the meaning of this?" asked Harold Dare.

"It means," replied the engineer, "that we have uncovered a vile piece of crookery. Had we been a day or two later, there would have been a large hole through that thick concrete wall."

"But what has that to do with the mysterious noise?" queried Dare.

"Do you know what causes concrete-pier piling to decompose? Not age, nor the sea water, directly, but electrolysis. The minute potential difference caused by the chemical action of the sea water upon the reinforcing steel electrolyzes the concrete, causing it to crack and decompose. Now, if so small a current working incessantly can break down concrete slowly, what would a heavy current at a high pressure do?"

"It would break it down more rapidly," responded the shrewd Dare.

"Right," agreed Scott. "That is exactly what has been going on here. Some scoundrel has tapped the trolley line, and has been applying 550 volts of direct current between this wire and another electrode connected to ground, through the reinforcing steel of the concrete. The current immediately set up electrolysis, crumbling the concrete away. Here was the cause of our mysterious noise.

World "A-B" Socket Power Unit

World Prices

Save 50%

\$37.50 complete

\$14.75 complete

"A" POWER UNIT

For economy—service—lasting satisfaction—there are no finer Power Units made, even at twice the price. Thousands of satisfied users back this statement. See for yourself. "A-B" Unit has variable control with 40 milliamperes capacity at 135 volts. "A" Unit has Westinghouse electrical equipment. Both operate on 50 or 60 cycles at 110 volts A.C.

Send No Money Just state Unit wanted and we will ship day order is received, by express C. O. D. subject to examination on arrival. 5% discount if cash is sent with order. Modernize your set at 50% saving. Send today.

WORLD BATTERY COMPANY
1219 So. Wabash Ave., Dept. 50, CHICAGO, ILL.
Station W.S.B.C. owned and operated by World Battery Company

Hook Your Aerial To A PREMAX Mast

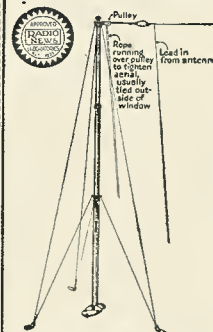

10 ft. 3-section Mast complete with all attachments, \$3.00 each, \$6.00 per pair. 7 ft. mast \$2.00 each, \$4.00 per pair, parcel post prepaid.

THIS neat, strong aerial support of rust proof tubular steel assures better reception—eliminates interference by wires, trees and other aerials.

Fits any roof—flat or sloping—and sides or ends of buildings. Both 7 ft. 2-section or 10 ft. 3-section masts are attractively finished in olive drab enamel and telescope readily into 4 ft. lengths for easy erection.

Complete with guy wire, pulley and anchors for less than the cost of a good wooden mast. At your dealers or direct from

Niagara Metal Stamping Corp.
Dept. RN-1 Niagara Falls, N. Y.

PREMAX Parkerized Rustproof Metal Specialties

A Laboratory Product

CRESCENT
LAVIÉ
RESISTANCES

For Distortionless Amplification
Used in 75 big broadcasting stations.
12,000, 48,000, 50,000 and 100,000 ohms.
\$1.50 each. Other special resistances made to order at \$2.50 each. We can supply resistances from 3,000 ohms to 10 megohms.

Cresradio Corp., 166-32 Jamaica Ave., Jamaica, N. Y.

AMPLION

The intermittent make-break action of electrolysis, and the fluctuations as the current arced from steel to steel, were transmitted through the trolley system on this circuit, thus spreading the disturbance over a large area."

"But why should anyone go to so much trouble to break down a concrete wall, when they could do it in a short time with a hammer and chisel?" asked Dare, in perplexity.

"Do you know what is on the other side of that wall?" demanded Scott, grimly.

Harold Dare thought a moment, then started. "The Gigantic Trust Company!" he exclaimed.

"Yes, indeed," replied the engineer. "The vaults of the Gigantic Trust Company. A chisel driven into that wall could not fail to break one or more of the fine wires imbedded in the concrete, setting off the burglar alarm. Something more gradual, more insidious, was needed; and the silent dynamite of electrolysis was soon to open the way to millions of dollars in cold cash, for the crime would have been discovered only when the vault was opened. By that time, the criminal would be far away, leaving no trace behind him."

"But the wires—how could anyone get through such a network of wires without cutting them?" questioned Dare.

"That is what the soldering iron is for," replied Scott. "The obvious remedy was to make the wires longer; but how to piece them without ringing the alarm? Simple enough. It was necessary merely to solder a long piece of wire to each alarm wire, one end at each side of the gap in the wall. Then the alarm wire could be cut without opening the circuit. The operation was not difficult; only, care had to be taken not to break any of the wires. One of our engineers happened to pull too hard on one of them, and set off the alarm, bringing the police. It was fortunate for us, Mr. Dare, that you came to our aid; else we should never have

been able to convince them that we ourselves were not attempting robbery."

"Oh, 'tis a mere nothing," graciously replied the modest Dare. "It is fortunate, however, for the clients of the Gigantic Trust Company, the countless widows and orphans who depend upon that company for their daily bread, that the interests of the public are protected by the altruistic Dare organization and its ever-watchful head. Fortunate, indeed, that Dandy Diavolo is in the hospital, suffering the consequences of his reckless scheme. But here is another example of the great truth illustrated in every good scenario: that in the end, right must triumph over wrong, and wickedness must prove its own undoing. Again, evil has overreached itself, and virtue has earned its just reward—the gratitude of many millions of film-fans—who shall hear of this as soon as word can speed to WROT."

SIMPLE CURE FOR NOISY HIGH-POWER AMPLIFIERS

AMONG the many things charged to "static" are the troublesome noises sometimes experienced with a high-power amplifier operating on socket power, but really due to resistors incapable of handling the load. This trouble is not encountered with wire-wound resistors, but rather with other forms of fixed resistors, the ratings of which may be greatly exceeded. The heat generated by overload soon causes such resistors to disintegrate, with tiny arcs between the conducting particles to cause noises.

A simple cure is to remove the overload from the resistor by providing a by-pass resistor. The exact resistance value may be difficult to determine, since the overloaded condition may be due to an incorrect resistance value in the first place. Hence a variable high resistor, with a sufficient current-carrying capacity, should be employed either as a shunt or as a substitute.

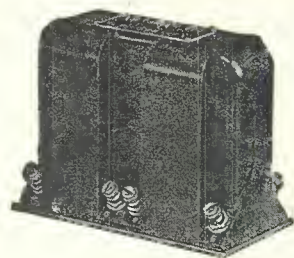

Victoreen "112" Audio Transformer Unit

New, because for the first time two scientifically developed audio transformers are successfully combined into one unit, giving utmost simplicity and efficiency.

Different, because of its radically different design and the recommended use of two "112" tubes, with high plate voltage.

Better, because for the first time, broadcast programs are reproduced with the same clarity and naturalness as is heard in the original.

Simple to install in either new or old sets.

PRICE \$22.00

Victoreen R.F. Transformers, Master Control Units, Rheostats, Potentiometers and Audio Control Units are the recognized standard of quality. Send for complete folder.

THE GEO. W. WALKER CO.
Merchandisers of Victoreen Radio Products

6528 Carnegie Avenue, Dept. 8
Cleveland, Ohio

Radio Set Builders and Radio Fans

will find unparalleled values in parts and accessories in the NEW

FREE HAMPTON-WRIGHT RADIO CATALOG

It's the "Book of a Thousand Radio Bargains"—whether you are a professional set-builder, a dealer, or an enthusiastic radio fan. The thousands who have taken advantage of Hampton-Wright radio offerings have been highly pleased with our well-known quality merchandise, excellent service and surprisingly low prices.

Our new catalog is ready—brimful of the greatest values ever offered by Hampton-Wright. This is going to be our greatest year. Won't you fill in the coupon below and let us mail to you what we think is the best catalog of radio values ever offered radio fans?

HAMPTON-WRIGHT

128 Darmody Building Indianapolis, Indiana

—JUST OUT FOR 1927-1928

Send for It TODAY!

Hampton-Wright,
128 Darmody Building,
Indianapolis, Ind.

I want to see this new catalog of radio bargains. Please send one to:

Name

Street

City..... State.....

"Keeping Pace with Radio"

**Where Results
Count**

YAXLEY

*Approved Radio
Products
Are Preferred*



**Switching
Rheostat**

Now, you can have all the satisfaction of the Yaxley Air-Cooled Rheostat with its velvet smooth action and watchlike precision plus a filament switch in one. Try this ideal combination in your next hook-up.
2 to 700 ohms.....\$1.75

Phone Tip Jacks



You will have to hunt a long time for a better and more convenient connection for your loud speaker than the compact, easy to mount Yaxley Pup Jacks at 25c the pair.

Write for Complete Price List

The new Yaxley Illustrated and Descriptive Price Sheet, eight pages, shows the complete line of Yaxley Approved Radio Products—products that are made to give you best results. Ask your dealer for this helpful booklet—or address

YAXLEY MFG. CO.
Dept. N 9 So. Clinton St., Chicago

Experimental Detection

(Continued from page 224)

an alternation, the grid impedance of the average tube will suffice; if it does not, the trouble is often found to be caused by a leaky socket or tube base.

These last two defects evidence themselves, in the case of high-vacuum or "hard" tubes like the 201A and 199 types, in the apparent lack of need of a grid leak; if the leak is necessary to prevent blocking no harmful leakage occurs. This leakage in average practice may act as the grid-leak resistance; but it is not desirable because its path may be to wrong side of the filament and thus cause incorrect biasing and reduced signal strength.

Although the grid impedance will qualify on the negative half of an alternation, the practical condition is a result of an average of positive and negative halves. Thus the external impedance, composed of the grid leak and grid condenser in parallel, feeds into the load impedance, which is that of the "G to F" electron path, and which works out for D.C. and for a detector tube to have a resistance of about 900,000 ohms. While the A.C. figure is smaller, especially for the higher tones, even 900,000 ohms allows something to be wished for. The impedance of the leak-condenser combination is one that varies according to frequency, since the reactance of a condenser varies inversely with frequency. With a two-megohm leak, the leak-condenser impedance drops below that of the tube's input at the higher audio frequencies, and rises above it at the lower; therefore, through failure to match impedances, it is likely that the lower tones will suffer attenuation from the frequency-characteristic of the leak and condenser.

Though the above seems logical, the more usual explanation runs differently; it is that the grid condenser serves as a shunt across the grid-leak, and in so acting tends to drop the higher frequencies, because of its inverse frequency-characteristic. It has been stated that 60% of the amplitude of a 3000-cycle current is lost in a .00025-mf. grid condenser, causing noticeable distortion by emphasis of the bass tones. The contradiction of this with the foregoing theory is obvious.

EXPERIMENTS

If the second explanation is correct, we should be able to do the following things: (1) Reduce the grid-condenser capacity and thus reduce the by-passing of higher tones and improve A.F. quality; (2) Reduce the grid-leak's resistance, with a loss in sensitivity perhaps, but with an increase of A.F. quality by reduction of the high A.F. cutoff; (3) Substitute an A.F. impedance of another kind than the leak-condenser combination and thus, if this new impedance has a better frequency-characteristic, the result will be better quality. (Obviously here we meet an *impasse*: are we to classify this new impedance against the grid, and in this case what seems to me the load, impedance; or are we to ignore the input impedance of the tube, as this theory implies in the published dissertations upon detection, and assume this external grid-circuit A.F. impedance to be independent of the device it feeds?)

In experimenting with the first proposition above, I found that the implications of the second theory were not fulfilled. For grid condenser capacities down to .00001-mf. with a non-regenerative detector, improvements as great as postulated were not apparent to the ear. Yet the ear will perceive a 25% change, and possibilities of a greater change are indicated by the second theory. The grid condenser, the purpose of which is to pass the R.F. around the high resistance of the leak, began to lose signal potential and thus to reduce volume at about .00005-mf.; so capacities under that value are inadvisable.



LAUGH

an hour a day
for the rest of
your life!

1001 LAUGHS

*The newest and funniest
joke book in the
world*

Did you ever pick up a French, German or Spanish joke magazine and wonder what their specially good jokes were?—Here's a brand new laugh book with hundreds of the best Foreign jokes and illustrations translated into English for you, together with plenty of good American humor and cartoons.

Altogether this is the greatest, funniest, most uproarious book of jokes and cartoons ever presented to Americans. Each leaf of this book is one merry round of pleasure. Every joke is a winner.

Relax from your daily grind, spend an hour a day in good old-fashioned laughter. It's a healthy recreation.

"1001 Laughs" is an extra-large size book, 9 x 12 inches, with over 300 illustrations.

50c ONLY

116 PAGES OF
UPROARIOUS JOKES
and
HUNDREDS OF SELECTED
ILLUSTRATED CARTOONS.

From All Nations—Especially Translated

ASK YOUR NEWSDEALER
OR ORDER DIRECT

EXPERIMENTER PUB. CO., Inc.,
230 Fifth Avenue, New York City

SET BUILDERS! DEALERS!

Standard parts and equipment at money-saving prices, with discounts that show you a real profit. Our kits are the last word in easy assembly. New A C tubes and transformers—3-foot cone kits—power audio equipment—short wave supplies—they are all in our big new 1928 Catalogue. Write for it today, with discount sheet. 12-hour shipment guaranteed.



Van-Ashe Radio Co.

210 North 10th St. ST. LOUIS, MO.



5 TUBE RADIO

At Low Factory Prices

It's a wonder for power and selectivity. Famous ARL circuit. Coast to coast reception! Finely built of selected, tested parts. Thousands now in use.

FREE Log and Call Book and New 1928 Catalog with thousands of nationally advertised bargains. Latest in radio at big savings. Write for Free copy.

AMERICAN AUTO & RADIO MFG. CO.
HARRY SCHWARTZBERG, PRES.
Dept. 10 I, American Radio Bldg., Kansas City, Mo.



With a regenerative detector conditions are somewhat different. Increase of regeneration, if carried to an extreme, will result in an increase of tuned-circuit selectivity to the point of sideband reduction and a consequent emphasis of bass tones. From this last well-known and easily-heard action, we can derive a check of (1) by hearing that sidebands in supposed greater strength suppress more obviously if the second theory is right. This did not prove to be true.

From experiment No. 2 we do not learn a great deal, unless it is that sufficient reduction of grid-leak resistance (with potentiometer maintenance of correct grid-bias) will also reduce signal strength. By reducing the grid-leak resistance sufficiently, the entire range of reactance variation of the leak-condenser combination is shifted downward, so that at no time does it over-meet with the grid-filament load impedance. The car tells us that the bass tones seem to pick up. It tells that the regenerative action, while adjusted further from the edge of oscillation, emphasizes the bass as strongly as when, in the ordinary case, stronger regeneration is necessary. This sounds like manufacture of evidence and may be that has occurred; but the tests are easy to make. At any rate the results are a contradiction to the second theory and served in part to instill doubts while yet I had faith in it.

USE OF CHOKES

Experiments with No. 3 arc, as indicated in the first paragraph of this "Experiments" section, somewhat doubtful in bases. Published theory seems to ignore the grid-filament input impedance, which certainly is the load upon the A.F. impedance represented by the leak-condenser unit, or by an A.F. grid-circuit rectifying impedance of another nature. If we take that for our basis of deciding the A.F. inductance of the choke, with which we are going to replace the leak-and-condenser to feed into a load near 900,000 ohms for D.C. (and which should be lower to A.C.) we find that almost any A.F. choke obtainable will do; since it would take an enormous one of 2500 henries to have a reactance greater than the 900,000 ohms at 60 cycles. Being modest, we will not need more than 50 henries; although it is a bet that this size will have too great an impedance at a frequency no higher than 3000 cycles.

So tests were made with chokes rated at 1 henry, 12 henries, 20 henries and 100 henries. The circuit used (grid circuit), whether with regeneration or without, is shown in Fig. 7.

The tests disclosed principally that it is important to pick a small choke with a resonant frequency well out of the useful A.F. range. The self-capacity in the A.F. choke was depended upon for passing R.F. to the grid, but was found insufficient.

I found it possible to do a number of things which speak for themselves in view of the foregoing. On using the secondary of a very large A.F. transformer, the self-inductance of which was on the order of 500 henries or more, high-frequency cutoff became very noticeable; for the suppression should begin about 300 cycles, and probably really was lower still in beginning. Using a still larger A.F. choke resulted even more effectively in suppression of the higher tones and in very muggy and voice-in-barrel reproduction. The circuit of Fig. 8 seems as good as Fig. 7, and should be so, if not better, in removing a large mass that acts possibly to produce many harmful capacities when connected as in Fig. 7. Both circuits were used often for checks.

The things the experiments brought out were chiefly that the leak-condenser combination is a good practical solution of providing satisfactory detection utilizing grid-rectification phenomena. The way to do the trick is to use as large a grid condenser as one is satisfied is necessary. The well-known .00025 mf. capacity is good, and with 250,000 ohms for the leak, makes a good quality combination with a slight sacrifice in

Dubilier

The Pioneer

A history of the Dubilier organization takes us back to the very conception of wireless telegraphy. Then, practically every Dubilier device was a "special order" built for experimenters whose names are now famous. Today, these same electrical and radio engineers turn instinctively to Dubilier for either standard articles of manufacture or laboratory models for their research. This keeping step with the industry has given Dubilier a merited reputation for condensers which are way above the average in ruggedness, safety factor and long life.

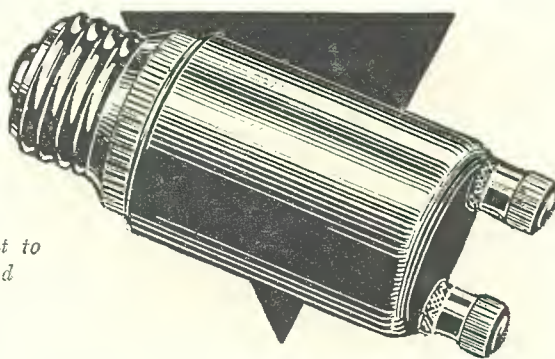

Just Connect it to
your Set and
Plug in



List Price
\$1.50

Why Bother with Outdoor Aerials?

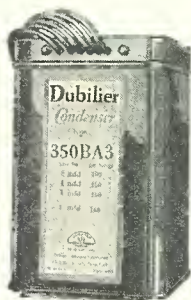

Present-day broadcasting and modern receivers don't require them. A Dubilier Light Socket Aerial and a few feet of cord will give you a highly efficient antenna and do away with lead-in wires, insulators, faulty connections and lightning arresters. The device consumes absolutely no current and needs no attention whatever. Works on any cycle, A.C. or D.C.

Sold on a 5-day money-back basis. Price \$1.50

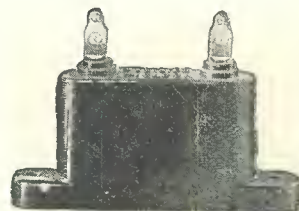

The Approved Condenser Blocks for Radio Power-Units

Dubilier condenser blocks for Raytheon and other leading circuits are rugged in construction, and have the unusually high factor of safety of better than five to one—insuring the longest condenser life obtainable. Your dealer will gladly supply you with the right Dubilier Block Condenser for the right purpose.

A New Dubilier MICADON Moulded in Bakelite

Here's the famous Dubilier Micadon in its modern shape and new case of rich Bakelite. Compact, handsome and efficient. Terminals adapted to screwed or soldered connections. Your dealer has them in all capacities.

Prices.....40c. to 80c.



The Noiseless Dubilier Metaleak

A tubular grid leak you can bank on for accurate resistance value and noiseless operation. Your dealer has them in all values from 20,000 ohms to 5 megohms.

Prices.....50c. and 75c.

Dubilier Condenser Corporation

4377 Bronx Blvd., New York

Enesco

THE ORIGINAL AND WORLD'S
FINEST 3 FOOT SPEAKER
COSTS NO MORE

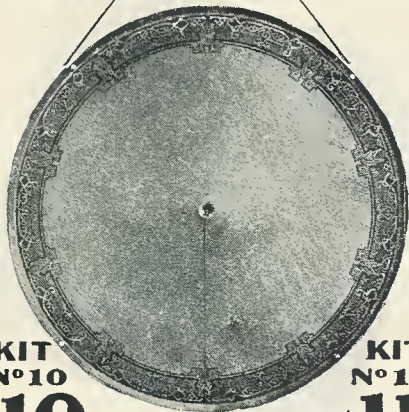

KIT
No 10
\$10

KIT
No 11
\$11

Buy the first, the best and the most popular, the 3 foot ENSCO CONE SPEAKER KIT, for finest Radio reception. Tested and endorsed by all leading magazines and newspapers. Kit No. 10 includes Enesco Unit; decorated, marked material (FONOTEX) for cone, apexes, extension and book of instructions, 5 types of cone or roll speaker. Price \$10. Kit No. 11 includes hardwood wall frame. Price \$11.

Licensed under Clyde J. Fitch Patent No. 1630119

Assemble your own in less than 1 hour. Sold under Money Back Guarantee. Ask your dealer or send order to nearest office.

ENGINEERS' SERVICE CO.

25 Church St., New York 911 Steger Bldg., Chicago
73 Cornhill, Boston

Send check or money order—or we will ship C.O.D., you pay the postman, we pay shipping.

Name
Address
City, State



Raytheon
or Q. R. S.
A-B-C Unit
Condenser
Packs

Illustration shows condenser pack used in Q. R. S. or Raytheon A-B-C unit. Fast extra capacity Hi-Test condensers fit all units, whether specified or not. Free condenser booklet brings the facts. Dealers and jobbers, send for price list.

JOHN E. FAST & Co.

3982 Barry Ave., Dept C. Chicago, U. S. A.

M-EMERSON-MULTIVALVE

Seven-element tube with 201A filament, three plates and three grids. Uses any battery. Operates on 5 volts. Draws only 1/4 ampere. Fits any standard socket. Can be used with many circuits. Write for information.

List Price \$6.50
Exclusive Licensees and Manufacturers

Emerson Radval Corp.
25 West 43rd St. N.Y.C.

AGENTS! DEALERS! BIG MONEY IN RADIO

Demonstrate Metrodynes at home. Big profits. Demonstrating set on 30 days' free trial. Write for money making proposition to agents and dealers.

METRO ELECTRIC CO.

2161 N. California Ave. Dept. D. CHICAGO, ILL.

volume and a definite gain in quietness. The use of an A.F. choke, as in Figs. 7 and 8, is all right; but is probably harmful to quality unless we use a choke certain not to have humps and hollows in its frequency curve.

Radio's Will-O-The-Wisp (Continued from page 227)

connecting these relays in cascade. The plate circuits of all of these amplifiers are supplied with current from a common source. To overcome static, Mr. Rice adjusts the operating characteristics of one of the amplifiers of the series in such a way that the amplified current produced by strays or static cannot exceed that produced by the signals. (U. S. Patent 1,401,644.)

The Laboratory for Special Radio Transmission Research of the Bureau of Standards and the Radio Central of the Office of Communications, United States Navy Department, reduce static to a minimum by use of the so-called Beverage or "barrage" receiving system. This involves the combined use of both overhead and indoor antennas, the opposing forces of the two serving to neutralize interference from atmospheric disturbances coming from a given direction, and signals are admitted into the receiving instruments with relative freedom from hissing, crashing, and rumbling noises.

(Copies of patents may be obtained at a cost of 10 cents [cash—not stamps] each, by addressing the Commissioner of Patents, Department of Commerce, Washington, D. C.—EDITOR.)

STREET RAILWAY EQUIPMENT

To eliminate interference with radio receivers, Vienna (Austria) now equips its cars with double trolley contacts, about three feet apart. Sparking is thus avoided when joints in the power line are passed. It is also found that a carbon-to-copper contact reduces much of the annoyance from breaks in the circuit.

SOME REPRODUCER!

THE Melbourne station, 3LO, has received this polite request from a listener: "We like band performances best, and would like you to announce each time one is heard. Sometimes we don't know whether it is a band or a thunderstorm!"—*News of the World.*

I Want To Know

(Continued from page 254)

control and synchronization is had throughout the entire wavelength range by the final factory adjustment of the various tube-isolating capacities.

These capacities, it will be noted by referring to the accompanying diagram, are adjustable, final adjustment being made before the set leaves the testing room.

Operating on six 201A-type and one 171-type (power) tubes, the Synchrophase Seven is suited for operation with any standard type of A and B power unit. When this receiver was tested with a standard socket-power unit, supplying both "B" and "C" voltages, no hum or "motorboating" was noticeable in the reception on the loud speaker.

Voltages varying from 22 to 180 are required for the plate supply; 90 volts for the four R.F. and the first audio stages, 22 volts for the detector, and 180 volts for the 171-type tube.

A negative bias of 4 volts is fed to the grid of the first A.F. tube, and 40 to the grid of the power amplifier.

Because of the greatly-improved quality output, due to the use of specially designed A.F. transformers, this receiver is particularly adaptable to use with the modern cone type of loud speaker. These transformers employ heavy cores with a great many turns of well-insulated wire. A chart, drawn to indicate the frequencies which these transformers reproduce with fidelity, shows almost a straight line; which indicates that they reproduce faithfully practically the entire range of audible frequencies.



PUNCH

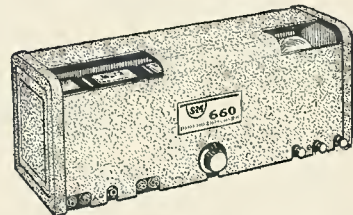

For those critical fans who desire the very finest of reproduction with ample power, the new S-M Unipacs (Universal Power Packs) offer as great an advancement this year as did S-M 220 audio transformers last year. And nothing finer than 220s has ever been produced, as is proven by their specification for over half the popular 1927 circuits to come!

If you're a real quality hound, write for "The Secret of Quality" and the new Unipac booklet—they will tell you volumes about realistic reproduction. They're free.

SILVER-MARSHALL, Inc.

848 W. Jackson Blvd.

Chicago, U. S. A.

RADIO NEWS

SEPTEMBER BLUEPRINTS

You can obtain a complete set of Blueprints for this receiver direct from RADIO NEWS

THE GOMEZ SUPER REFLEX RECEIVER
Blueprint Article Number 30
Price \$1.00

RADIO NEWS

230 Fifth Ave. New York, N. Y.

6 TUBE RADIO

One Dial Latest advanced circuit. All steel chassis totally shielded. Balanced parts of best quality. Marvelous power and selectivity. Gets the long range stations as clear as a bell. One dial single control. An unsurpassed value—just one of our many mighty bargains.

FREE Log and Call Book and **Big New Catalog**—just off the press. Full of Radio Bargains. Send for your free copy now!

American Auto & Radio Mfg. Co.
Harry Schwartzberg, Pres.
Dept. 102, American Radio Bldg.,
Kansas City, Mo.

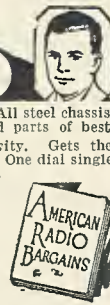

FREE Wholesale Radio Catalog

Dealer-Set Builders! Save Money! Send for this book of bargains. Everything in Radio—all the newest hook-ups. Sets, kits, parts, cabinets, consoles and supplies. If you want the best for the least money, you need this catalog. Write on your business stationery.
SHURE RADIO COMPANY
335-A Madison St. Chicago, Ill.

Hints About 3-Foot Cones

(Continued from page 237)

the air gap which is located at the center of the solenoid coil.

In operation the coil will stand voltages up to 200; so that it is safe to use it on a 171-type power tube without the use of an output filter. In this case the terminals of the speaker must be connected in the manner from which loudest results are obtained; as the unit is polarized.

It was stated before that, for best results from the wall-type speaker, it should be

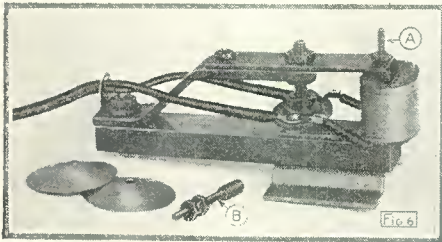

The driving rod, A, is attached to the paper diaphragm by means of the rod, B, which is threaded.

spaced a few inches from the wall. A simple method of doing this is illustrated in Fig. 7. A small cardboard box has a slot cut in each of the four sides so that it fits on the back of the frame. This box is sufficient for spacing. The ceiling-type cone is, of course, the same as the wall type; except that the suspension cord is attached to the center block, so that when the cone is suspended it balances in a horizontal position. This type gives better results, as it can be hung ten or twelve inches from the ceiling and the sound will be distributed. As it is, for the most part, reflected from the ceiling, the distribution is more uniform. A person entering the room has difficulty in locating the source of the sound.

The location of the speaker in the room also has a decided bearing on the quality output. This is more noticeable with the

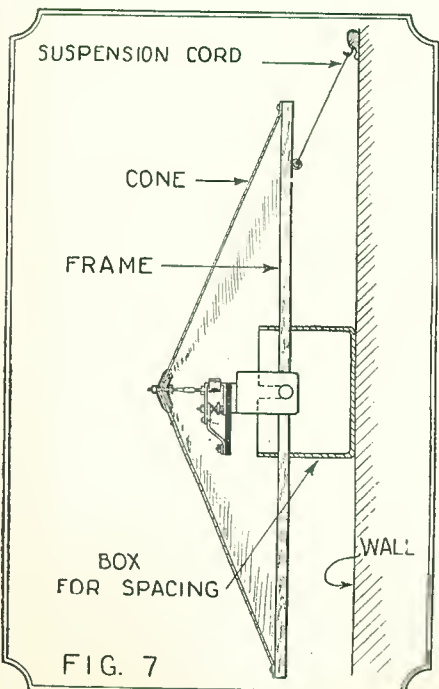

The method of keeping a cone away from the wall by means of a small cardboard box.



A SIAMESE CHARLESTON
These three professional dancers are considered pretty good in Siam. Here they are shown giving, for the benefit of the camera, their own version of the American Charleston.

FOR MEN AND YOUNG MEN World Travel With All Expenses Paid!

How often you've longed to see for yourself the awe of Egypt's pyramids—the beauties of the gorgeous Mediterranean sunset—the squalor of China's ancient cities! Now you can do it—travel the whole world at will, all your expenses paid. Every one of your expenses of travel will be paid for you—you won't be out a cent of your own. And you can draw a good salary besides!

There is a big demand for men to handle the Radio operating on board the ships of the world. Practically every vessel must carry one man—many of them two or three or more. Radio operating is easily and quickly learned—and the work is very interesting and pleasant. There is no other work like it for the man who wants the experiences and pleasures of world-travel.

Radio operators aboard ocean liners live luxuriously—they rank as officers of the ship. Meals, a private cabin, all other living needs are furnished free, and besides the operators draw a good salary. You don't have to sign up for a long term—you can change ships as often as you like, so as to go to any part of the world you prefer on each voyage.

Book with Full Information Sent Free

My free 64-page book gives all information about this field of work, and the opportunities for travel, fascinating work and advancement. Send for it today—get all the facts. You can learn in your spare minutes at home to qualify for a Radio Operator's position. Just a few months of my practical training in your spare time at home and you'll be prepared to start on your travels.

My methods of training are recognized by the U. S. Government. My graduates are all over the world. My Employment Department, which keeps in touch with employers and supplies them with Radio Operators, is at your service without charge when you complete your training.

No special education is necessary—lots of men I've trained didn't even finish the grades. Read about it for yourself in my big free book—learn how I'll prepare you quickly and easily at home for these big opportunities.

Send the coupon TODAY! Address: J. E. SMITH, President, National Radio Institute, Washington, D. C.

The "Sailaway" Coupon—Mail it now!

J. E. SMITH, President,
National Radio Institute,
Dept. KB-99 Washington, D. C.

Dear Mr. Smith: Please send me your free 64-page book, with all information about learning Radio for bigger pay, and as a means to world-travel at will, all expenses paid. I understand this places me under no obligation.

Name _____

Address _____

Town _____ State _____



The whole
COUNTRY
is
praising
AMERICA'S
FIRST
RADIO
ENCYCLO-
PEDIA

\$2

A place in every
home, every library,
every laboratory

S. GERNSBACK'S RADIO EN-
CYCLOPEDIA is the only
standard work ever published in
America attempting to classify al-
phabetically the countless words
used in the highly specialized science
of RADIO. The ENCYCLOPE-
DIA is written in plain English so
that everybody can understand the
definitions and descriptions.

No expense has been spared, cover-
ing over two years in compilation,
to make it worthy a place in your
library.

It is published in one volume—
168 pages—size 9x12 inches, nearly
an inch thick and nicely accom-
modates the beautiful illustrations and
the large, easy to read type.

Every page is replete with illus-
trations—to make the text easily
understandable.

REMEMBER THIS IS A
REAL ENCYCLOPEDIA—NOT
A DICTIONARY.

The book contains as a supple-
ment a classified cross-index de-
signed to bring together radio refer-
ences under one heading having re-
lations in common.

All circuits new and old are de-
scribed by word and picture.

The work contains 1,930 defini-
tions, 549 photographs, drawings
and diagrams.

SEND NO MONEY—Just for-
ward your name and address. We
will send you the Book at once.
You pay postman \$2, plus postage
on delivery.

Order Direct from
S. GERNSBACK
230 Fifth Ave., New York

NEW YORK, N. Y. . . . It is the best work of the kind we have ever seen and shows considerable painstaking and laborious effort.—*Telegram*.

NEW YORK, N. Y. . . . The volume amounts to practically a compact review of all that has been done in radio up to this time.—*Radio News*.

WASHINGTON, D. C. . . . It presents a complete classification of the latest authoritative data in radio.—*Evening Star*.

SAN FRANCISCO, CAL. . . . A book that will be of value to all that are interested in practical radio work.—*Examiner*.

PITTSBURGH, PA. . . . Many radio fans will be interested in the new Radio Encyclopedia by Sidney Gernsback.—*Sunday Post*.

PITTSBURGH, PA. . . . It is a complete classification of the latest authoritative data in radio.—*Day Tribune*.

NEW YORK, N. Y. . . . Mr. Gernsback is author of other volumes on radio and his encyclopedia may be regarded as authoritative.—*Daily Press*.

CHICAGO, ILL. . . . S. Gernsback has aimed to provide not merely a dictionary of radio terms but an actual ready reference.—*Herald and Examiner*.

ST. LOUIS, MO. . . . S. Gernsback's new radio encyclopedia holds all needed facts.—*St. Louis Star*.

ST. LOUIS, M. . . . This book of radio information is S. Gernsback's radio encyclopedia.—*Globe Democrat*.

MACON, GA. . . . Gernsback's radio encyclopedia fills a demand that has been made by every radio fan as well as technical expert since the industry has started.—*Telegraph*.

DALLAS, TEXAS. . . . This encyclopedia is readily understandable to anyone who reads English and is thorough and readable.—*Sunday News*.

LOS ANGELES, CAL. . . . Its references cover every item of importance relative to the radio industry.—*Sunday Times*.

OTTAWA, CANADA. . . . It is an encyclopedia in the true sense of the meaning and not a mere dictionary.—*Journal*.



NIAGARA, N. Y. . . . The volume is recommended for informational use by every radio listener.—*Evening Review*.

BUFFALO, N. Y. . . . Here is the world of radio, all in one volume, and it is one of the most comprehensive, enlightening and illuminating publications that has yet been issued.—*Courier-Express*.

BRIDGEPORT, CONN. . . . All radio terms are fully described in layman's style, and the explanation of the whys and wherefores of various circuits are also given.—*Herald*.

BOSTON, MASS. . . . A practical handbook with references covering every item of importance relating to radio.—*Globe*.

PHILADELPHIA, PA. . . . In his Encyclopedia Mr. Gernsback has succeeded in reducing high sounding electrical and technical terms to every day speech.—*Daily News*.

three-foot cone than with smaller ones; as the larger cone has greater carrying power, although the volume is apparently less. Good results on the wall type cone are obtained by suspending it in the corner of the room, as this gives more open space behind the cone in which the air vibration may build up. Of course, when it is so mounted the spacer shown in Fig. 7 is not required. The ceiling type works well when suspended directly in the center of the room or underneath a lighting fixture. No definite instruction can be given regarding the best location, as this varies in each individual case due to the size and shape of room and other variables. The best location can be easily found by a trial.

New R. F. Amplifier
(Continued from page 243)

of values would be found. But, in a forthcoming issue of RADIO NEWS, will be presented an article which will furnish all the information necessary to build and operate one of these receivers. There is nothing critical in the values of these constants; so that the adjustments can be made easily and rapidly.

Now, before we pass on to the audio amplifier used in this receiver, let us briefly review the operation of the R.F. amplifier in a few words, so that it will be perfectly clear. First let us assume that we have the correct size of R.F. choke in the circuit. Tune to a long wavelength, say 500 meters. Feed-back through the tube is small now; so we make up for this lack by increasing the resistance R and making the feed-back current flow through the tickler, L2. So, by increasing R, we can make the circuit oscillate. Next tune to a short wavelength, say 250 meters. Feed-back through the tube is now strong, and feed-back through the tickler is not so strong, on account of the greater choking action of the R.F. choke at the higher frequencies. But, in order to allow the feed-back through the tube to show its effect, we must reduce R. So by reducing R at this time, we can also make the circuit oscillate.

In between these two values of R at which the circuit oscillates, will be found the best value of resistance to use in R. Care must be taken that these two points are not too far apart, otherwise there will be a lack of sensitivity near the middle of the dial. But when the proper value of R.F. choke is used, the sensitivity at the middle of the dial will come up to that on either side; so that we will have uniform sensitivity and, of course, uniform selectivity, all over the dial. This uniformity of operation is one of the main features of this type of amplifier.

THE A. F. AMPLIFIER

Now we will consider the audio amplifier used in this receiver. A considerable amount of work has been done by many experimenters on A.F. amplification; and they all seem to agree on several points on which other types of amplifiers fail. The three most important of these points are; the possibility of blocking the grids of the tubes, as often happens in resistance-coupled amplifiers, the existence of resonance peaks in transformer-coupled amplifiers; and the blocking of the tubes in impedance-coupled amplifiers, which use grid leaks.

The amplifier used in this receiver is of the dual-impedance type, in which impedances are used both in the plate and in the grid circuits of the tubes. This has several notable features; one of these is its stability. Furthermore, it will be found that the combination of a transformer in the first stage, where the signal strength is still weak and will not overload the transformer, with the dual-impedance stages following, will fur-

S. GERNSBACK 230 FIFTH AVE., N. Y.
Send me 1 copy of your Radio Encyclopedia. I will pay postman \$2 plus postage on delivery.
Name
Address
City
State

nish a greater amount of amplification than either the usual two-stage transformer-coupled amplifier, or the usual three-stage impedance-coupled amplifier.

It will be found that the quality obtainable with this system is as perfect as can be obtained with almost any kind of audio amplifier. The low frequencies are amplified just as much as the high frequencies, for two reasons. First, large coupling condensers are used, the value being 1 mf. Secondly, the impedances used are very large, giving to the low frequencies substantially the same amplification as to the high frequencies.

The complete wiring diagram of the receiver is shown in Fig. 2. As mentioned before, complete constructional details will be given in a later article in RADIO NEWS. It will be found that the combination of the R. F. amplifier, which is equally sensitive and equally selective all over the dial, with this audio amplifier, which will furnish a great amount of volume without distortion and overloading, will result in an ideal receiver for all purposes and all locations.

Space-Wound Coil Construction

(Continued from page 235)

To remove the coils, loosen the wing-nuts, which allows the brass strips to spring loose, remove the wing-nut at the "tongue" end and pull the corresponding bolt out. With this bolt out, the entire middle section pulls out and allows the form to "collapse." Sometimes it is necessary to press slightly at the opposite end, in order to slide the parts together easily. The coil is now easily slipped off and is complete after the ends have been trimmed with shears.

Although comparatively small wire may be used to advantage, it is best to use No. 20 to assure the proper rigidity. The wire may corrode after a time, even though a double cotton covering be used; for this reason enameled wire having also a cotton covering is best. The cotton covering serves to hold the wire securely to the strips.

COIL-SUPPORT STRIPS

The celluloid may be secured from old auto side-curtains, but a large piece of it, sufficient for many coils, can be secured for 25 cents or so at any auto supply store. A convenient way to cut the celluloid is to nail together two small boards with a small space between, so that the celluloid may be slipped between them. A knife may be used to cut the strips at the edge of the board. Strips 1/4-inch wide are about the right size.

The stove-bolts should be of the same diameter as the holes drilled for them. This will make them fit rather tightly but, if they are forced through the holes several times, the holes will be the proper size to keep everything firmly in place when winding the coils.

If a number of coils is to be made, it is best to purchase a large bottle of the col-

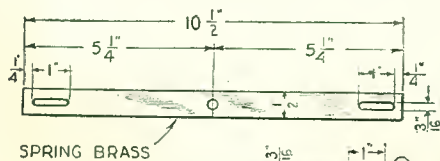

DIMENSIONS ARE FOR A 3" FORM.

FIG. 7

Details of the brass strips for holding the celluloid strips in position.

What Kind of Voice Has Your Loud Speaker?

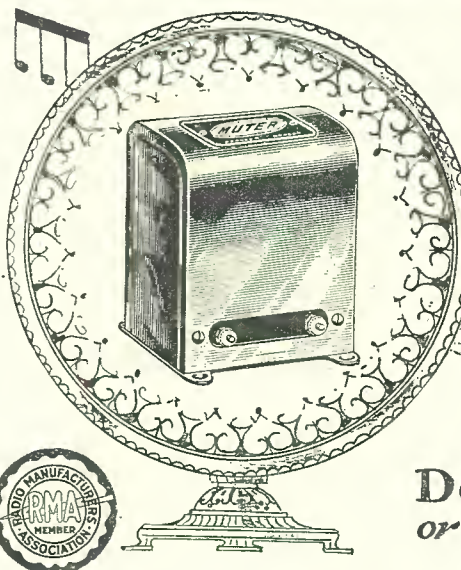

Does It Sn-n-narl?

Does It Whine? or Does It~

Register Clear, Natural Human Tones? The Muter Clarifier

[NEW OUTPUT TRANSFORMER]

on your set will astonish and delight you by immediate, almost unbelievable improvement in reception. In nine cases out of ten that weak, distorted voice issuing from the speaker unit is suffering paralysis from high "B" Voltage. The Clarifier protects Speaker coils from this shattering current, assuring longer life as well as strong, full tone, clarity and volume.

If your speaker is one of the great majority that fail to respond properly to the output of the set—you need a Muter Clarifier. It's the only thing that will remedy the cause. Easily attached in a few seconds without disturbing set. Try it out to your own satisfaction on our liberal guarantee—you won't recognize your set!

SEE YOUR DEALER—or SEND DIRECT

Dealers can easily secure Muter Products for you from leading Jobbers. If, however, you have any difficulty in obtaining from your dealer, mail coupon direct to us. Prompt shipment will be made upon receipt of price or C.O.D. if preferred. Give your speaker a chance to produce its utmost. Mail coupon today.

LESLIE F. MUTER CO.

76th & Greenwood Ave., Dept. 827-M CHICAGO, ILL.



DEPENDABLE PRODUCTS

The complete Quality Popular Priced Line
Send for comprehensive catalog



Use This Coupon!

LESLIE F. MUTER CO.

76th & Greenwood Ave., Dept. 827-M Chicago, Ill.

- Send Muter Clarifier at once, postage prepaid. \$5.00 is enclosed.
- Send C. O. D.
- Send complete Muter Catalog.

Name.....

Address.....

City.....State.....

LIGHTING FIXTURES
Ready to Hang
Direct from the manufacturer. Completely wired, including glassware. Send for new catalogue No. 28. Just Reduced Prices.
Special Proposition To Dealers.
Erie Fixture Supply Co., Inc., Erie, Pa.

Balkite
Radio Power Units
FANSTEEL PRODUCTS CO., Inc.
North Chicago, Illinois

JEWELL WRITE
For Our 32 Page
Radio Instrument Catalog
No. 15-C
JEWELL ELECTRICAL INSTRUMENT CO.
1650 Walnut St. Chicago

TOBE
CONDENSERS—RESISTORS
Specified—Used—Universally
TOBE DEUTSCHMANN CO. Cambridge, Mass.

Use Polymet Products

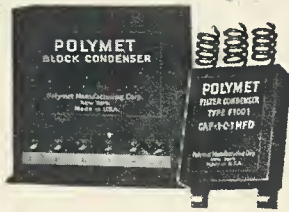

Type F1002-F1003—
The entire condenser
requirements for Filter
section. Two units
tapped at 4.-4.-c Mfd.
and 8.-1.-1.-c-1.-c Mfd.

Type F1001 — Small
Buffer Condenser for
the output of the trans-
former. Tapped .1-c-1
Mfd.

**For Raytheon "ABC"
Eliminators**

For efficiency and permanent satisfaction you can't beat Polymet Products. More and more Radio Engineers are every day specifying Polymet Products because they know by experimentation that they are the leaders. To insure lasting, satisfactory results for Battery Eliminators, Power-Packs and Electric Sets, buy only Polymet "better made Radio Essentials." They are the best.

Send for our latest booklet showing some of the most popular circuits and the complete line of Polymet Products.

**POLYMET
MANUFACTURING CORP.**
599 Broadway, New York City

**POLYMET
PRODUCTS**

CARTER

as usual is ready for the latest developments in the Industry

The New
**R.C.A.
Cunningham
and other**

**A. C. Operated Tubes
Rheostats, Potentiometers
Adjustable Resistors
(semi-variable)**

Ask your dealer

In Canada:
Carter Radio Co., Ltd., Toronto



RADIO SCHOOL

Send for Catalogue
**MASSACHUSETTS RADIO and
TELEGRAPH SCHOOL**

NEW TERM SEPT. 12
18 Boylston St. Boston, Mass.

ELKAY EQUALIZERS

and Suppressors are made by The Langbein-Kaufman Radio Co. (Dept. N), 62 Franklin St., New Haven, Conn. Write for prices and tables of values.

lotion, as the liquid evaporates very quickly. A convenient method of reducing this evaporation and also providing an easy means of applying the collodion to the winding is to construct a slender "fountain pen" for the bottle. This may consist of a piece of tin bent to form a small cone, the cone being soldered to the cap of the bottle. Many bottles are provided with metallic screw-caps, but such an arrangement may be used with an ordinary cork.

When winding the wire, hold the form at the tongue-end and straighten out all little kinks in the wire between the thumb and forefingers as it is wound in the threads on the form. When the winding is completed, it may be noticed that the turns will be somewhat irregularly spaced at the middle section, since there are no threads here. These should be straightened out by hand and all wires put into their proper grooves before the winding is painted with the collodion.

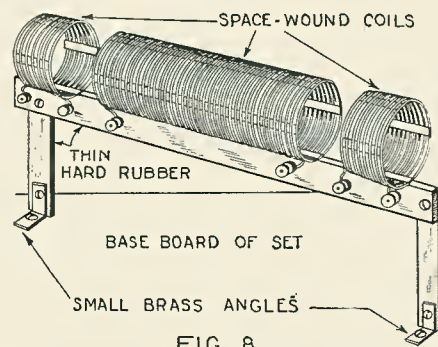

FIG. 8
Above is shown an excellent method of mounting the coils herein described.

When using low-loss coils of this type, do not mount them near other apparatus. It is perfectly useless to make a good coil if the rest of the set is too close. Some day those desiring maximum results will learn that it is only through plenty of "breathing" space that such results can be attained. A very good method of keeping the coils in the clear is shown in Fig. 8. This is about the most practical arrangement.

Although the coils as a whole are very strong, they will unwind from the ends if these are left loose. It is therefore important to secure the ends properly. The best way to do this is to secure a cheap punch and make a hole in the strips where the wire is to terminate. Pass the wire over the strip, under this strip and through the hole. Then press the strip firmly in place with a pair of pliers.

For the construction of coils of the type above described, the writer has developed several forms, some of them being adaptable to production purposes. Those interested in the forms may secure such information upon request. All rights are absolutely reserved.

SIMPLIFIED TELEVISION

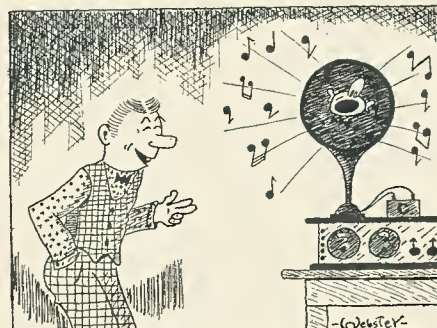

DIZZY DAN: "I think I'll get me one o' these here 'see' batteries so that I'll be able to watch the people while they broadcast."

Goodrich



Radio Panels

Black, Mahogany and Walnut.
Standard thickness 3-16" and 1/4".
High softening point prevents warping.

Low free sulphur content prevents discoloration.

Machine easier and are better electrically than any other material in common use.

Your radio dealer has them or will get them for you—if not, write to us and we will see that you are supplied.

Also hard rubber for coils, spaghetti tubing and miscellaneous rubber items for Radio Manufacturers.

Radio Sales Division

The B. F. Goodrich Rubber Company
Established 1870 • Akron, Ohio

M&H
Radio's largest
kit supply house

ESTABLISHED 30 YEARS

Genuine

STROBODYNE

KITS—Ready for delivery
Complete outfit as selected by
designer for Radio's most
amazing circuit

We have complete kits for all
constructional articles appearing
in this Magazine.

M & H SPORTING GOODS CO.
512 Market St., Philadelphia, Pa.

Special Library of Information
on
RADIO PATENTS
and
TRADE MARKS

JOHN B. BRADY

Patent Lawyer

Ouray Building Washington, D. C.

Cable address:
RADIOPAT

Telephone:
Main 4806

**RADIO AGENTS AND
DEALERS—BIG MONEY**

Our Agents and Dealers make big money selling Metrodyne Sets. You can work all or part time. Demonstrate superiority of Metrodynes in your home. Metrodyne Radios have no competition. Lowest wholesale prices. Demonstrating set on 30 days' free trial. Greatest money making opportunity. Write!

METRO ELECTRIC CO.
2161 N. California Ave. Dept. D. CHICAGO, ILL.

GENERAL RADIO

Parts and Accessories. Write for Catalog
No. 926-N.
General Radio Co. Cambridge, Mass.

Radio Wrinkles

(Continued from page 249)

diagram are used merely as valves, and the size of the electrodes in these is not so important as in Nos. 1 and 2; except that they should be a little larger if anything. Nos. 1 and 2 alone govern the input.

Needless to say, this circuit will not operate except on alternating current.

—Contributed by W. H. Burrows.

International Time

(Continued from page 217)

hours, as it is between New York and Denver; it is *twenty-two hours*, because it must be figured the long way around, and not across the Date Line. When it is 1:00 o'clock Wednesday morning in Honolulu, it is 11:00 o'clock Wednesday night in Auckland. At that same time, it is 3:30 a. m. in San Francisco; 6:30 a. m. in Washington, D. C.; 11:30 a. m. in London; 12:30 p. m. in Berlin; 5:00 p. m. in Bombay; 7:30 p. m. in Perth, Australia, and in Manila; 8:30 p. m. in Tokio; and 9:30 p. m. in Sydney, Melbourne and Brisbane, Australia; all on the same Wednesday.

Now, if our listener in Honolulu were a radio "ham," or amateur, he would be very apt to say that it was 1130 GCT (Greenwich Civil Time) and let it go at that. For "hams" all over the world are transacting business in GCT, which is independent of local time, and consequently the same at any instant for sender and receiver.

But, so long as broadcasters throughout the world are governing themselves by the demands of their local audiences, it will be a little too much to ask them to accommodate themselves to GCT schedules for listeners thousands of miles away. Yet this is just what the short-wave broadcasters do today when they ask observers round the world to report on experimental transmissions; and, as the number of short-wave broadcasts and of short-wave receivers increases, with consequent lengthening of ordinary reception ranges, a better understanding of international time will have to be obtained.

It is fortunate, just at present, that there are no large broadcast stations in the

40 Non-Technical Radio Articles

every month for the beginner, the layman and those who like radio from the non-technical side.

SCIENCE & INVENTION, which can be bought at any newsstand, contains the largest and most interesting section of radio articles of any non-radio magazine in existence.

Plenty of "How To Make It" radio articles and plenty of simplified hook-ups for the layman and experimenter. The radio section of SCIENCE & INVENTION is so good that many RADIO NEWS readers buy it solely for this feature.

Radio Articles Appearing in September Science & Invention Magazine

- A Portable Radio Receiver for Vacation Trips, By Herbert Hayden
- Gravity Nullified by Short Waves Applied to Crystals
- The Radio Furnace, By Paul Welker
- The Belin Radio Television System
- The Radio Séance, By Karyl Kanet
- How to Build a Vibrating-Type Battery Charger, By Raymond C. Miller



Two New Quality Products

by the makers of the famous
Hammarlund Condensers

The New
Hammarlund R. F. Choke

MODERN engineering practice has proved the value of R. F. chokes for confining radio-frequency currents to their proper channels, thus preventing unbalanced circuits and consequent distortion. This is a *quality* idea, ideally exemplified in the use of the new style Hammarlund Choke. Made in two sizes: 85 and 250 millihenries, effective over the entire broadcast and amateur wave-band.

Wherever radio is known throughout the world, Hammarlund's reputation for precision quality is recognized. No other introduction is required for these two worthy new members of the Hammarlund radio family.

Write for Literature

An Improved
"Hammarlund Jr."

THE famous Hammarlund Midget Condenser has been simplified. The new "Hammarlund Jr." has all essential features of the former model—soldered brass plates, aluminum frame, one-hole or baseboard mounting. Knob included. In addition, it is equipped with a rotor lock which fixes the rotor in any position—an important advantage when used for neutralizing. Four sizes.

HAMMARLUND MANUFACTURING CO.
424-438 W. 33rd Street, New York

For Better Radio
Hammarlund
PRECISION
PRODUCTS

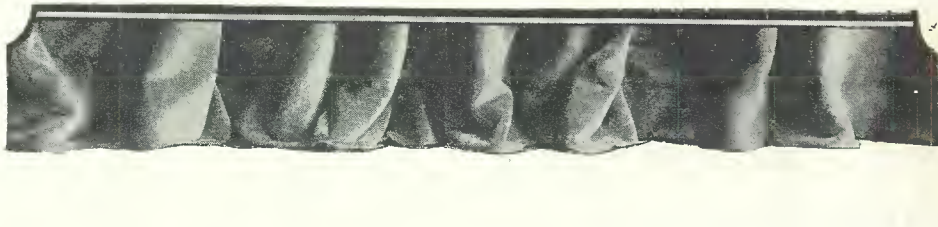

LEARN THE CODE AT HOME

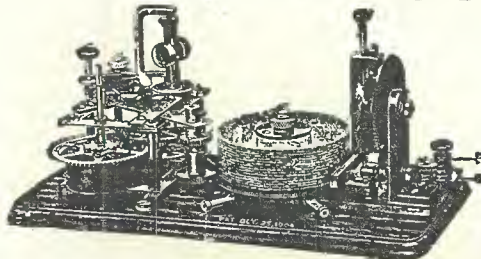

WITH THE OMNIGRAPH

THE OMNIGRAPH Automatic Transmitter will teach you both the Wireless and Morse Codes—right in your own home—quickly, easily and inexpensively. Connected with Buzzer, Buzzer and Phone or to Sounder, it will send you unlimited messages at any speed, from 5 to 50 words a minute.

THE OMNIGRAPH is not an experiment. For more than 15 years, it has been sold all over the world with a money back guarantee. The **OMNIGRAPH** is used by several Depts. of the U.S. Govt.—in fact, the Dept. of Commerce uses the **OMNIGRAPH** to test all applicants applying for a Radio license. The **OMNIGRAPH** has been successfully adopted by the leading Universities, Colleges and Radio Schools.

Send 6c for Catalog
THE OMNIGRAPH MFG. CO.

DO IT TODAY.
15 HUDSON STREET, NEW YORK CITY

If you own a Radio Phone set and don't know the code—you are missing most of the fun

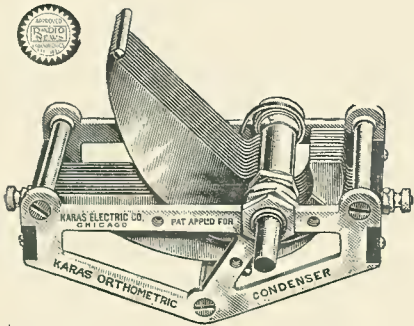

Use Karas S. F. L. Variable Condensers in Your RADIO NEWS Short Wave Set

BE sure to use Karas S. F. L. Variable Condensers when you build your RADIO NEWS Short Wave Receiver, described and illustrated in RADIO NEWS. In this set two Karas Condensers are SPECIFIED—our .00014 mfd. and .00025 mfd. Straight Frequency Line Condensers. You can secure these from your dealer. The price of the .00014 7-plate type and of the .00025 11-plate type is \$6.50 each.

These remarkable condensers have our scientific eccentric shape plates, giving a perfectly straight line frequency curve. This means that every point of the dial is equally separated from its adjoining point in both directions by 10 kilocycles, exactly according to government allocation of stations.

You, of course, want extremely fine results from your new RADIO NEWS Short Wave Set. Insure this by using Karas S. F. L. Condensers.

About Our New Apparatus

The NEW Karas Radio Apparatus for 1927-28 includes the NEW Karas Type 28 Audio Transformers, the NEW Karas Output Filter, the NEW Karas Types 17 and 23 S. F. L. Removable Shaft Variable Condensers, and the NEW Karas 2-Dial Equamatic—the season's most remarkable radio receiver that gives 7-tube performance and volume with 5 tubes. Write today for interesting literature about these new Karas items.

KARAS ELECTRIC CO.
4038-I North Rockwell Street
CHICAGO

BUILD A \$100 SHIP MODEL LOUD SPEAKER FOR \$12.50



We will supply all the necessary parts, cut to fit and ready to assemble. The mainstay acts as the loudspeaker. The entire kit, which includes the unit and sail, for \$12.50. Nothing else to buy. No tools needed except a small hammer. Write for our illustrated catalog
MINIATURE SHIP MODELS
3818-20-22-24 Baring street
Dept. T Philadelphia, Pa.

Single Dial-7 Tube Set on 30 Days' Free Trial

Judge the wonders of this marvelous radio by taking advantage of our liberal offer. Write at once for details of money making proposition to agents and dealers. Deal direct with factory.

METRO ELECTRIC CO.
2161 N. California Ave. Dept. D. CHICAGO, ILL.

PATENTS As one of the oldest patent firms in America we give inventors at lowest consistent charge, a service noted for results, evidenced by many well known Patents of extraordinary value. Book, Patent-Sense, free. Lacey & Lacey, 631 F St., Washington, D. C. Estab. 1869

Aleutian islands of Alaska or in the Fiji islands, and other places in the immediate vicinity of the International Date Line; or there might be more confusion. Alaska covers the full width of four time zones; the Fiji group also crosses the Date Line, but has a time six minutes later than standard at the latter. And on each side of the Date Line there is a strip of the earth's surface—mostly water, fortunately—where the same hour, but a different day is reckoned.

TABLE OF TIME ZONES

Summing up the advice to the DX listener; never reckon time from east to west across the Date Line, which runs down the middle of the Pacific. Here is a little timetable; when a day is beginning at the Date Line, it is the hour given of the preceding day in the following places: (The numbers of the zones show the hours to be added to or subtracted from local time to give Greenwich civil time.)

Samoa (+ 12)	12:00 midnight
Hawaii	1:30 a. m.
Alaska (+ 10)	2:00 a. m.
Pacific Standard Time Zone (+ 8)	4:00 a. m.
Mountain Time Zone (+ 7)	5:00 a. m.
Mexico	5:24 a. m.
Central Standard Time Zone (+ 6)	6:00 a. m.
Cuba	6:31 a. m.
Ecuador	6:46 a. m.
Eastern Standard (Central Daylight Saving Time) Zone, Panama (+ 5)	7:00 a. m.
Colombia	7:04 a. m.
Chile	7:18 a. m.
Bolivia	7:27 a. m.
Haiti	7:20 a. m.
Venezuela (Eastern Daylight Saving Time), Intercolonial (Canadian) Standard, Porto Rico, British West Indies, Central Brazil, Argentina, Uruguay (+ 4)	8:00 a. m.
Newfoundland	8:21 a. m.
Eastern Brazil, except Pernambuco and Parahyba (+ 3)	9:00 a. m.
Pernambuco, Azores (+ 2)	10:00 a. m.
Canary Islands, West Africa (+ 1)	11:00 a. m.
Greenwich Civil Time, England, France, Belgium, Spain, Algeria (0)	12:00 noon
Holland	12:20 p. m.
Scandinavia, Germany, Austria, Italy, Yugoslavia, French Equatorial Africa (- 1)	1:00 p. m.
Roumania, Greece, Turkey, Egypt British Central Africa (- 2)	2:00 p. m.
Russia (European)	2:01 p. m.
British East Africa	2:30 p. m.
Madagascar (- 3)	3:00 p. m.
Mauritius (- 4)	4:00 p. m.
British India (except Calcutta)	5:30 p. m.
Calcutta (- 6, 6:00 p. m.)	5:53 p. m.
Burma	6:30 p. m.
Siam, French Indo-China (- 7)	7:00 p. m.

ANNOUNCEMENT IN OUR SEPTEMBER ISSUE:

THE RADIO GHOST, by Otis Adelbert Kline. You can not fail to remember "The Malignant Entity," by this well-known author. Here he has outdone himself in an original story, never published before; you shudder to think that the same instrumentalities which we actually have today might be put to use by someone with a criminal mentality. **THE MALIGNANT FLOWER**, by Anthos. This story, which has just come to us from Germany, is a little literary masterpiece and scientific gem. This story is so unusual and so excellently told, that we have no hesitancy in calling your particular attention to it.

THE STONE CAT, by Miles J. Breuer, M.D. "...but his (Lot's) wife looked back from behind him and she became a pillar of salt." Thus reads the Bible (Genesis xix:26). In reading this story by the author of "The Man with the Strange Head," you will instinctively think of petrified forests and prehistoric animals, many of which can be found in our national museums.

THE WAR OF THE WORLDS, by H. G. Wells. In the second installment we find the Martians in possession of the earth. By means of their superior intelligence and their death-dealing war implements, they have thoroughly subjugated everybody. You will read with intense interest the concluding part of this great scientific story.

And many more new stories of unusual interest.



Permanent Accuracy!

AEROVOX Fixed Mica Condensers stay accurate because they are moulded in genuine Bakelite and are sealed and protected against possible injury, moisture or chemical action.

A special process in the manufacture of the condenser element enables us to manufacture and guarantee them to be within 10% of their marked rating.

AEROVOX
70 Washington St., Brooklvn. N. Y

STROBODYNE Complete Parts as Specified

As usual, Barawik is first with its service to radio set builders and fans. No sooner was the Strobodyne announced in RADIO NEWS than we had complete parts for this new circuit available for our customers.

Complete parts as specified will be quickly furnished to RADIO NEWS readers C.O.D. in order to save time. Barawik, as usual, carries all the parts for the new 1927-1928 circuits, besides sets, kits, radio supplies and thousands of the latest accessories. Standard discounts to dealers and set builders.

BARAWIK CO., 129-131 N. Jefferson St., CHICAGO, ILL.

C. L. PARKER

Ex-Examiner U. S. Patent Office
Attorney-at-Law and Solicitor of Patents
McGill Building, Washington, D. C.
Patent, Trade Mark and Copyright Law

SAVE 25% TO 60% on every book you buy.

Write for
BOOK BULLETIN No. 5

CONSRAD CO., 230 Fifth Avenue, New York

Philippines, West Australia, Eastern	
China (-8)	8:00 p. m.
Japan (-9)	9:00 p. m.
South Australia, Guam	9:30 p. m.
New South Wales, Tasmania, Victoria, Queensland (-10)	10:00 p. m.
New Hebrides (-11)	11:00 p. m.
New Zealand	11:30 p. m.
Fiji Islands	11:54 p. m.
DATE LINE (-12) beginning	
next day	12:00 midnight

From this table it is fairly simple to compute the time in any zone, at a given hour, if we remember that time is *always earlier west of us, and later east of us.*

USE OF THE TABLE

For instance, take 1:00 a. m. Eastern Daylight Saving Time, which is 12:00 midnight standard time. This is seven hours earlier than the time given for Eastern DST above. Subtracting seven hours from the figure given above for Alaska ($2 + 12 - 7 = 7$) we find that it is 7:00 p. m. of the *preceding day* in Alaska; subtracting seven hours from the time given for the Philippines, we find that it is 1:00 p. m. of the *same day* in Manila.

Or, suppose that it is 11:00 p. m. Central Standard Time where we are; this is seventeen hours later than the time given above. Adding seventeen hours, we find that it is 6:30 p. m. in the *same day* at Honolulu; in Tokio, Japan, it is 2:00 p. m. of the *next day*—because we have to count around the long way to the east to avoid the Date Line, and must therefore consider Japan as *east* of us, not west.

Many charts and measuring devices have been made to illustrate this time-difference. A large and handsome colored map is Chart No. 5192 of the Hydrographic Office of the U. S. Navy. This may be obtained from Uncle Sam for 20 cents (cash, not stamps).

ILLUSTRATED RADIO TERM



HIGH - MU
SE. Callahan

PROVINCIAL RADIO MONOPOLY

THE province of Manitoba, Canada, has but one broadcast station, CKY, owned by the department of telephones of the province (This transmitter is leased under another call, CNRW, to the Canadian National Railways), and it has been announced by Manitoba's minister of telephones that no approval will be given for the applications of broadcasters anywhere else in the province. Trouble started, says *Radio Sales* (Toronto) when the board of trade of Brandon declared for a project to establish a station in their city, and that they would not lend support to the Winnipeg station. Listeners are at present required to pay a license fee of one dollar a year, which is used as a subsidy for CKY.

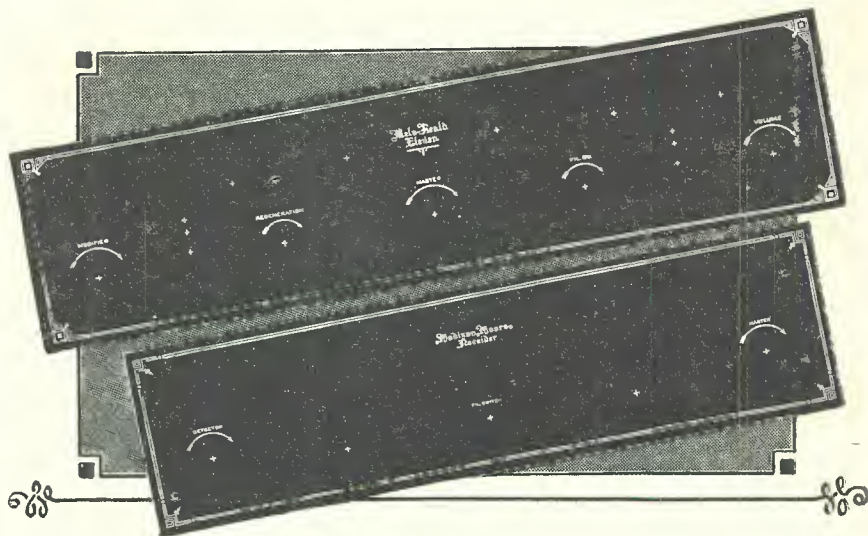

Handsome Sets Built at Home

FORMICA kit panels have helped thousands of amateurs to build at home, out of kits, efficient sets of the most attractive appearance.

These kit panels are made of gloss black Formica handsomely printed in gold. They are sold by leading jobbers and dealers everywhere: Melo-Heald Superheterodyne; Madison Moore One Spot; World's Record Super Nine; B. T. Power Six; Browning Drake; National; Victoreen one and two dial; H. F. L. Nine In Line; Karas Equamatic; Infradyne and many others.

Formica tubing and panels are also available for amateurs.

THE FORMICA INSULATION COMPANY

4618 Spring Grove Avenue
CINCINNATI, OHIO

Hear the FORMICA
Orchestra Tuesday
9 to 10
over WLW

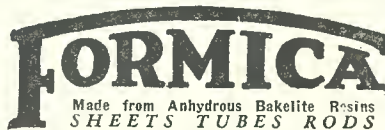

Formica has a
Complete Service on
Insulating Material for
Radio Manufacturers

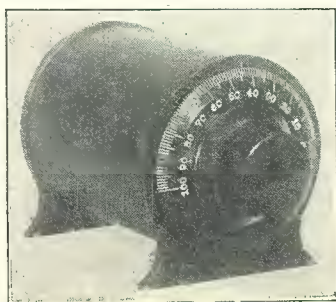

Pat. Pending

\$3.75

References: First National
Bank, Dunn's or Bradstreet's.

**"When a station is hard to get,
and it is a distant hit,
Use a REESONATOR"**

Introducing the latest addition to a radio set. The Reesonator is guaranteed to bring in distant stations that were infinitely out of your reach before and bring them in loud and clear so that they will fill the whole house with perfect rendition of speech and music. Through actual tests we have found that it will increase the power and volume of your radio from five to twelve times. Equivalent to two extra tubes. Made especially for single and two dial machines but will also work to great advantage on three dial radios. It is not a wave-trap, but will eliminate or reduce to an absolute minimum all interfering stations.

DON'T TAKE OUR WORD FOR IT. WE GUARANTEE SATISFACTION.

Can be installed without tools by anyone in less than a minute. Try one for three days, if not thoroughly satisfied we expect you to return it and your money will be cheerfully refunded. Sent post-paid on receipt of \$3.75 or remit \$1.00 with order and pay balance to postman on delivery.

F & H RADIO LABORATORIES
North Dakota
 Fargo

TELEVISION -is here!!!



Radio Fans! Mechanics! Scientific men! Everybody! Build a TELEVISION SET--The greatest and most amazing development of the 20th Century

The first and only complete book on TELEVISION.

50 CENTS

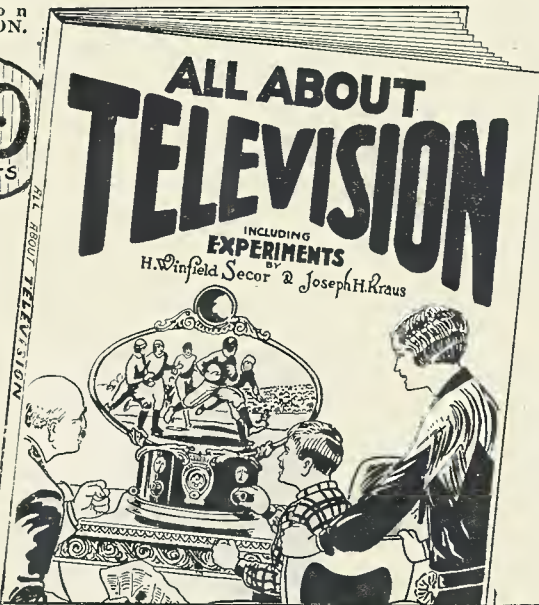

HERE, friends, is the first book to be published giving you the history of TELEVISION, from the first crude experiments at the beginning of the 20th Century—to the comparatively perfect machines just put into daily operation.

From this book you can build your own, workable television set that will serve as a fundamental apparatus for hundreds of tremendously interesting and amazing experiments.

Get in now on this new development. You may be fortunate enough to discover some improvement to Television that will be worth many thousands of dollars.

Start with a copy of this new book today. 116 Pages—Size 9 x 12 inches. Illustrated.

50 CENTS THE COPY —EVERYWHERE

or clip this coupon and send it to EXPERIMENTER PUB. CO., Inc. 230 Fifth Ave., New York, N. Y.

EXPERIMENTER PUBLISHING CO., Inc.
230 Fifth Avenue New York, N. Y.

Gentlemen:—I enclose 50c for one copy of the new book "TELEVISION."

Name

Address

City

State

TRANSMITTING APPARATUS

A Complete Stock at "Chi-Rad"

In addition to our regular broadcast apparatus we carry a very good stock of transformers, chokes, grid leaks, high test condensers, etc., for transmitting purposes.

NEW SHORT-WAVE COILS

Specially built by "Chi-Rad." Write for descriptive bulletin and catalog. Dealers and set-builders please use business letterhead when writing for discounts.

Chicago Radio Apparatus Co.
415 S. Dearborn St., Dept. RN, Chicago

SET BUILDERS

Before you build get our special prices on the parts you are planning to use. We'll save you money. Largest and most complete stock in U. S. A.

Chicago Salvage Stock Store
Dept. RN. 509 S. State St., Chicago, Ill.

"What's Wrong?" Contest

(Continued from page 206)

"Any dumbbell can make one or two mistakes—but it certainly must take a fox's great-grandmother to put sixteen in one picture."—C. W. Donaldson, 1st Prize.

"Poor Fips, how hard you tried to please the Boss—that offered the raise—that went for prizes—that everybody wants, regardless of sizes."—C. A. Bromley, 2nd Prize.

"Tell Fips I went one better and found 17 (Wrong! or you would have had first prize—EDITOR). Let's have his picture so we can see how many mistakes we can find on him."—N. Chamberlain, 3rd Prize.

"I agree with Mr. Gernsback, Fips ought to get that long-promised raise. It is indeed too bad that part of it will fade away!"—Ovila C. Duquet, 4th Prize.

"Distortion occurs in television as in telephony. This picture is a specimen of visual distortion produced by overloading—not the tube—but Fips' mental capacity."—L. J. Troxler, Jr., 5th Prize.

"Well Fips, OM, here is my entry and congratulations on your fine work! It won't be long before you are the Editor now!"—Miss Andrea Duquet, 6th Prize.



"SO MANY Nights I've battled with failure! Now I've lost the decision. What chance has a 'radio widow' With this picture-sque Television? NOT ANY!"—Marad Serrioc, 7th Prize.

"Apprehension!"
"Men'll worship, Women'll weep, If singer's lovely, But We'll have to keep, Away from 'Mike' By force'n decision Most aspiring broadcasters, For Television!"
—Alice Stevenson, 8th Prize.

"Brevity is the soul of wit; I've done my very best with it, And hope these answers make a hit."
—E. C. Greene, 9th Prize.
(This entry was very neatly sketched in pen-and-ink. We regret that it will not reproduce suitably here. —EDITOR.)

Station WRNY

NEW YORK

309.1 Meters—970 Kilocycles

is owned and operated by the publishers of this magazine

Our Editors will talk to you several times every week—

See your Newspaper for details

TUNE IN ON WRNY

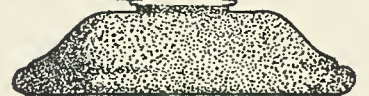

"When you see what you hear, and hear what you see,
No more that old gag, 'Guess who! This is me!'"
—L. L. Lunc, 10th Prize.

"Television—the miracle of science, the wonder-child of Radio—stands on the threshold. It enthralles the imagination; spellbound, we can only murmur, 'What next?'"—E. W. McCoy, 11th Prize.

"The picture moves, the voice rings out;
I drop my book,
And, if a Man were singing, I might turn
My head to look."
—Norris E. Wilson, 12th Prize.

"Thoughts afar, a distant stare;
She doesn't know what's on the air.
Screen's not worth a wasted minute,
Because a handsome 'Sheik's' not in it."
—A. F. Helmkamp, 13th Prize.

Honorable Mention

To Nat. Berger, Brooklyn, N. Y., E. J. Thielen, Bronx, N. Y., and Herbert F. Heaton, U. S. S. Tennessee, for lists of fair correctness, though unaccompanied by comment in accordance with the terms of the contest. Also to Col. W. J. Simpson, Winnipeg, Canada, for this clever limerick—unfortunately also too long:

"Said the Boss: 'Fips, my boy, do your stuff.'
So he sketched out a scene in the rough.
When the clock had struck six
There was no time to fix
The mistakes, so he just ran a bluff."

We have said that many incorrect answers were given by our readers. Here are some of them, beginning with those which were most popular:

IRREGULAR ANSWERS

- The microphone is not facing the singer. (Wrong! the type pictured is reversible, so WRNY shows on both sides.)
- The grandfather's clock lacks weights.
- Arms of listener's chair at different heights.
- Coloring of shadow under receiver incorrect.
- Frame of screen does not continue around top.
- Screen unbalanced. Screen supports at different heights.
- Room should be darkened.
- Pianist playing too high on keyboard.
- Should be no studio clock, because of noise.
- Piano should not be turned away from mike.
- Singer too close to microphone.
- Third leg lacking under piano.
- Piano lid should be closed.
- Right rear table leg lacking.
- Rings on wrong fingers; wrong hands.
- Singer turned away from piano and has no score.
- Singer and listener same person.
- Clock case opens on wrong side. No keyholes, no door for dial.
- Perspectives of receiver and grandfather's clock do not agree.
- Shadows do not fall at corresponding angles.
- No hooks for wall picture. (This was expressly excluded in the previous article.)
- No black keys on piano.
- No printing (no cover) on book; upside down.
- Ribbons lacking on ladies' left shoulders.
- Camera too close to piano and singer; at wrong angle; would take singer's back, etc.
- Cameraman's hand should not show. Should not be left hand. (Included in No. 2.)
- Hour hand of studio clock should show quarter past hour.
- Piano lid not proper shape.
- No place in United States where listener could be an hour ahead of New York time. (Grandfather's clock shows an hour and a quarter behind studio time.)
- Singer has only one arm.
- Listener short of fingers; has too many. (Both equally wrong.)
- No seat in chair.
- Table scarf wrinkled; too long; falling off (!)
- Ladies' hair too long.
- Studio clock upside down. (Some readers supposed it to be on the wall of the living room.)
- Pianist too small. (One suggestion that he is defying New York's child-labor law.)
- Interior of microphone exposed.
- Receiver not in center of table.
- RADIO INTERNACIONAL on cover spelled incorrectly. (Not so! This is Spanish.)
- R in WRNY too large.
- Only one tuning dial for music and television. (As both will undoubtedly be sent on the same wavelength, this is wrong.)
- Listener wearing "party dress" in home.
- Floor of studio not indicated.
- Television not yet invented. (Wrong!)
- Receiving screen should be square. (Why?)
- Should be no red and green lights on camera; only one lighted at once. (Why?)
- Readings of meters wrong. Figures on tuning dials wrong. (Both of these expressly excluded in terms of contest.)
- Clock pendulum off center. (This was done to indicate that it is not stopped.)
- WRNY at wrong point on tuning dial.
- Studio should be draped.
- Singer should not stand in front of pianist.
- Television will show scenes in reverse. (Wrong!)
- No such station as WRNY. (This reader is in California. We can assure her that her scepticism is entirely unfounded.)

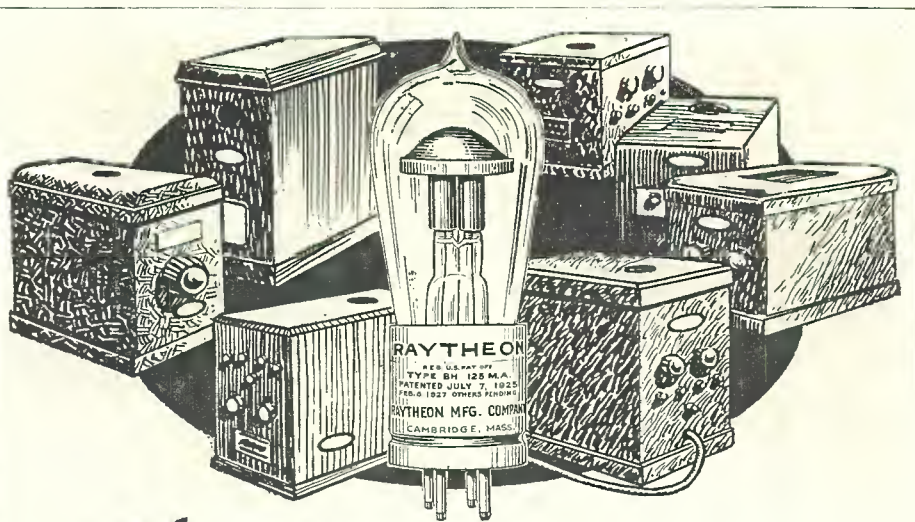

The Outstanding Radio Power Units

What does it mean to you that over fifty leading manufacturers of light socket power units submitted their designs to the Raytheon research laboratories for approval and right to use Raytheon long life rectifying tubes? Just this—that Raytheon's technical personnel and unusual scientific facilities in conjunction with the use of the Raytheon rectifier are invaluable aids in the making of a reliable radio power unit.

Look over the Raytheon-approved devices. They are the outstanding radio power units by reason of their highly dependable performance. Today, over 700,000 receivers are performing at the height of their efficiency by being powered with Raytheon-approved light socket power units.

Your dealer can show you a Raytheon-equipped unit exactly suited to the needs of your receiver.

RAYTHEON MANUFACTURING CO.
Cambridge, Mass.



When you see this green Seal of Approval on a power unit you know that it is a Raytheon-approved unit and can buy it with full confidence in the integrity of its makers and the performance of the device.

Raytheon

THE HEART OF RELIABLE RADIO POWER

Magnaformer

Radio Fans—Get a new radio thrill from the Magnaformer 9-8 circuit with its double-volume amplification. While the heavens rumbled, lightning flashed and skies poured, the Magnaformer logged 43 DX stations in 2 hrs. Experts were astounded. The year's sensation. A 1928 idea! Amazing, hair-splitting selectivity, superb tone. Product of leading engineers. The secret lies in Magnaformer self-shielded intermediate matched transformers. 1st, because they are factory-tuned and sealed; 2nd, doubly amplified; 3rd, no squeals or howls. Everything new, different, better. A boon to set builders. Saves 50%. 10c brings complete booklet and blueprints. Be the first to get it.

RADIART LABORATORIES COMPANY
19 S. La Salle Street Dept. 16 Chicago

Build Sets!
make \$100.00 a week

WRITE NOW FOR FREE DATA

Get into the radio business. Let us show you how to make spare time money—easily and surely. **COMPLETE SYSTEM** No obligations. Get our system now—today. A post card brings full details.

Dept. R. N.
Radio Constructors Corp., 357-12th St., Oakland

Mar-Co Dials

KELLOGG BATTERY-LESS RADIO
Made possible by the wonderful Kellogg A. C. Tube. Operates direct from alternating current line. No "A," "B" or "C" batteries. Write for details.

KELLOGG SWITCHBOARD AND SUPPLY COMPANY
Dept. 10-16 Chicago, Ill.

New!

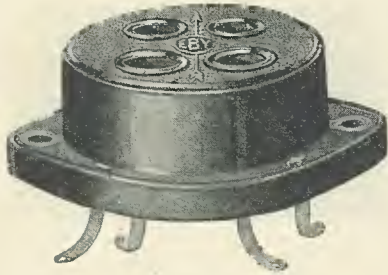

and *Much* Better

The prongs are completely enclosed and *can't* spread. No more socket trouble to shoot!

After all, a socket's only job is to provide a perfect contact. The Eby three point wiping spring contact is the most scientifically perfect type known.

Easy to mount above or below Bakelite, Wood or Metal. Specified in Hammarlund Roberts Hi-Q6 and other popular circuits.

List Price 40c

THE H. H. EBY MFG. Co.

INCORPORATED
4710 Stenton Ave.
Phila., Pa.

Makers of Eby Binding Posts

Televocal
QUALITY TUBES



Better
—by Far!

Combine delicate detection with high amplification. Non-microphonic and cannot short because of exclusive TELEVOCAL SUPPORT and method of construction. Tested, balanced and proved perfect before leaving factory.

Insist on Televocal—they cost no more! Televocal Tubes are made in all standard types.

If your dealer cannot supply you, write us, sending his name.

Televocal Corp'n.

Televocal Building
Dept. A, 588 12th St., West New York, N. J.

PLUG IN AND TUNE IN ALL ELECTRIC RADIO

The Metrodyne 100% Electric Radio Set is the sensation of this radio age. Costs no more than most battery sets. Shipped direct from our factory on 30 days' free trial. Write immediately for complete details.

METRO ELECTRIC CO.

2161 N. California Ave. Dept. D. CHICAGO, ILL.

How Filtering Is Accomplished
(Continued from page 239)

poles are reversed (as happens during each cycle). Just so, one pair of pump valves at diagonally opposite corners open during a stroke of the pump in one direction and close immediately when its motion is reversed; and the action of the other pair is exactly opposite.

But, while the flow of the current is always in one direction, on account of the rectifiers, it is *pulsating*, for the strokes of the pump can be felt. The piston stops at the end of each stroke, and consequently there is variation in the pressure caused by it. It is now that the filter comes into play, and smoothes out the "waves" which the pump causes.

THE CONDENSER

Let us place between the outlet of the pump and its intake, a large receptacle C, which is divided in the middle by an elastic membrane M. As the pressure on one side becomes greater than that on the other, the membrane is put under a strain (corresponding to potential or "electric pressure" on the *dielectric* between the plates of a condenser). As that pressure is relaxed, the elasticity of the membrane returns the energy previously put on it, and exerts pressure in the opposite direction on the liquid, thus maintaining its flow. This is similar to the action of a "buffer" or "filter" condenser in an electric circuit.

The regulation thus obtained, however, is still far from perfect. To make the flow still more even, the liquid is made to pass through a coil of pipe L, which has a great number of turns, and therefore offers a great amount of resistance—through friction—to the movement of its contents. This resistance acts as a brake upon, not only the flow of the current, but also the speed with which the membrane M can force a discharge of the contents of the receptacle C. This coil corresponds to the inductance or "choke" used in an electrical circuit. However, the electrical phenomena are more complex; a choke offers enormously greater resistance to the reversal, or even pulsation, of a current than to its steady, direct flow.

The addition to the system of a second receptacle C1, with a similar elastic membrane M1, on the opposite side of the coil, makes the flow of the liquid in the system much more regular, and gives a uniform supply at B, which corresponds to the load ("B" and perhaps "A" current) in a radio receiver.

THE ELECTRIC FILTER

The diagram (Fig. 2) of a complete "B"-supply system for a radio receiver, with "two-electrode" rectifying tubes, will be seen to resemble very closely in its arrangement the hydraulic system we have just described. The power transformer (left) has two secondaries; one furnishes five volts for the filaments of the tubes, and might be compared to a mechanical arrangement for opening and shutting the valves S. The other, with a potential difference between its terminals of about 300 volts, supplies the plate current for the tubes, and corresponds to the energy put upon the piston P. Each of these secondary windings is supplied with a center tap and lead, as shown.

The rectifying tubes play the part of the valves in the hydraulic system (in fact, the vacuum tube is commonly known, outside the United States, as a "valve," having been so named, when first invented as a two-element device). Their output, which fluctuates strongly, at twice the rate of the cycles of the input alternating current, is filtered by

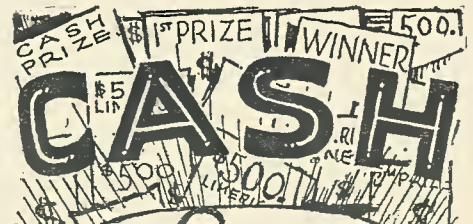

from
LIMERICKS!

Fatten YOUR bankroll on Limerick Contests—learn how prize winners are picked—and what makes them winners.

LIMERICKS!—Those little five-line verses of rhyming nonsense—are paying cash, big, substantial cash prizes from hundreds of contests every month in the year.

Limericks can be manufactured with tremendous success by studying the construction of last lines, by studying the special kinds of rhyming words that are most effective and by learning the "inside dope" on how limericks are judged.

Ninety-nine per cent or more of entrants to Limerick Contests know little or nothing of the best method of selecting a prize winning answer. A study of our new book will put you way ahead of the general run from the first.

This book gives the first and only specially prepared *Rhyming Dictionary* of words especially fine for Limericks and the similar words that rhyme with them. It is prepared by one of America's leading authorities who had much experience in how limericks are judged.

Sixty-eight pages of instruction, large-sized book 9 by 12 inches, the only book of its kind.

50c Tells You How to Win
CONSRAD COMPANY, Inc.
230 Fifth Ave. New York

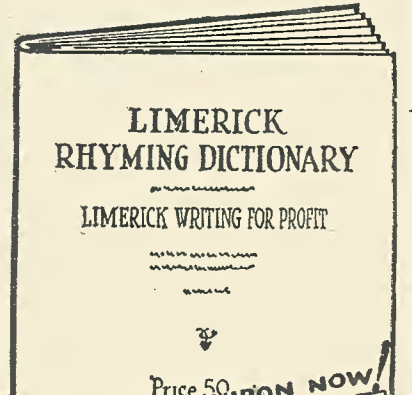

Price 50c
MAIL THIS COUPON NOW!

CONSRAD CO., INC.,
230 Fifth Ave., New York City.
Gentlemen: I enclose 50c for one copy of your new book "LIMERICK WRITING FOR PROFIT."

Name

Address

City..... State.....

the condenser-coil combination C-L-C1, in which we readily trace a resemblance to the hydraulic system above described. As the number of these combinations is increased, the purity and steadiness of the current is increased, though with a corresponding loss of energy in overcoming the internal resistance of the system.

The whole system offers a certain resistance to the flow of the current, which is represented by a loss of voltage corresponding to the conversion of electricity into heat; so that the potential difference between the terminals at the output of the power-supply unit will be found lower by, say 30 volts, than that existing between the terminals at the output of the transformer's high-voltage secondary winding.

The Community Set Builders

(Continued from page 203)

Randolph Radio Corporation of Chicago ventures to say that 30% to 40% of the parts that it sells from day to day go to individuals who build radio sets in their homes or small shops and sell them to local customers. The company says that complete sets have become more and more the vogue, and that some dealers have discontinued the carrying of parts. These two conditions have started the community set builders building sets for people who want custom-built outfits.

The Alden Manufacturing Company, Springfield, Massachusetts, which has no direct contact with community set builders, knows that there are many of them because its jobbers and dealers are approached by many who are trying to secure wholesale prices.

The Allen-Rogers Company, New York, is said to have about 3,000 names of set builders on its mailing lists.

The Benjamin Electric Manufacturing Company, Chicago, says that undoubtedly professional set builders will constitute a large portion of the market for radio parts. This company corresponds with many builders and finds that most of them desire to try out the latest ideas in radio construction and at the same time sell the sets which they build in order to make enough money to pay the cost of their experiments and a little extra. Usually, after one of them constructs a good set which gives excellent results, he is able to sell easily a number of sets in his own neighborhood and build up a good business.

This company states that, in spite of the fact that there are many good manufactured sets on the market, there are plenty of people who prefer a specially-built set, incorporating the features which they consider desirable in order to meet local broadcasting and reception conditions. It says that there is a good field in every community for a capable set builder and that such men ought to earn good incomes.

The General Radio Company, Cambridge, Massachusetts, believes that it has the names of hundreds of community set builders in its files, but finds it difficult to determine which customers should be so classified. Customers are listed either as dealers or consumers. Many of the consumers may be community set builders; and many of the dealers may be carrying on activities in a spare room or attic at home instead of operating a store.

A well-known New England advertising man says that he believes there is a great deal of community building of radio sets by "hams" throughout the country, and that community set builders are one of the biggest factors in keeping the parts manufacturers going. He says the market is large enough for them and the set manufacturers, too.

The Thor Radio Manufacturing Company of Chicago states that the larger proportion

A NEW IMPROVED UNIPOWER

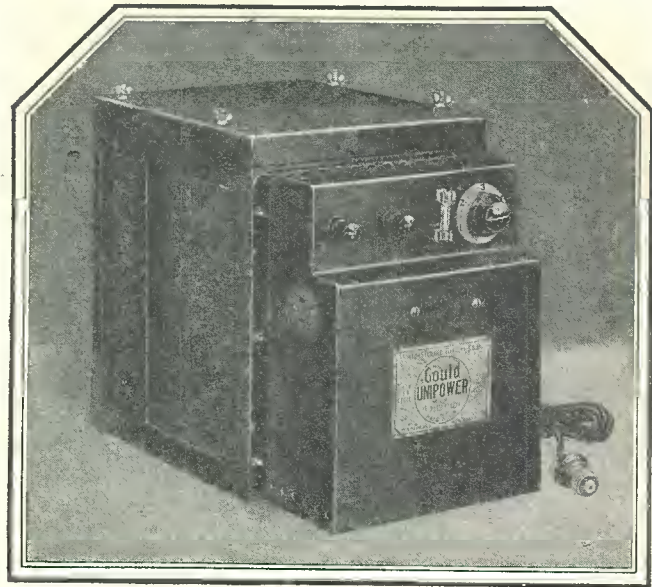

The same reliable tested design

... plus KATHANODE

A new submarine type battery element gives Gould Unipower still longer life—and practically ends all service expense.

ASK TO SEE THE FINEST
UNIPOWER GOULD EVER BUILT

The new
IMPROVED
Kathanode

Unipower

A GOULD PRODUCT

INDISPENSIBLE
for 100%
Tube Efficiency

Only Amperite supplies automatically the self-adjusting filament current your tubes require. Eliminates hand rheostats. Simplifies wiring. Insist on Amperite. Accept nothing else. Price \$1.10 complete. Sold everywhere. Write for Free Hook-Ups and construction data to Dept. RN-9.

RADIALL COMPANY
50 Franklin Street
New York City

AMPERITE
REG. U.S. PAT. OFF.

The "SELF-ADJUSTING" Rheostat.

EVERYTHING IN RADIO
AT ATTRACTIVE PRICES. SETS OR PARTS.
Orders shipped exactly as ordered. Prompt Service.
Write for Prices. Mail Order Only. Send Your Address.
ALL RADIO COMPANY, 417 North Clark St., Chicago

WEBSTER

"Bone-Dri" A Socket Power and Battery Chargers
Equal to Webster "B's"—Raytheon equipped.

Enough said! Before you miss an important program from run down batteries, equip your set with Webster "A," "B" and "C" socket power. Operate from electric light socket. Send for free booklet "How to eliminate your batteries"

THE WEBSTER CO.,
866 Blackhawk, Chicago

WINDSOR HORN and CONE Loudspeakers and Loudspeaker Consoles
WINDSOR FURNITURE COMPANY
1410 Carroll Avenue, Chicago, Illinois
Los Angeles Branch, 917 Maple Ave.

FEATURES OF THE MONTH IN THE NEW MAGAZINES

SCIENCE and INVENTION

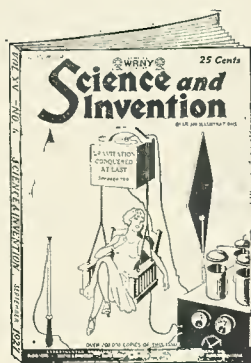

The Man Who Grows! —While You Watch

A man came into the office of SCIENCE and INVENTION recently. He propounded a theory that by simple exercises anyone could, at will, increase their height or length of arms, etc., several inches. To prove his statements, he demonstrated how it was done. While we watched he grew exactly 7½ inches in height, and increased the length of either arm 6½ inches, along with some other remarkable things.

The September issue of SCIENCE and INVENTION tells all about this marvelous feat—with pictures of the originator. Don't fail to read about it.

Gravity Nullified

The cover of September SCIENCE and INVENTION shows a beautiful girl seated in a chair, suspended in the air by a very ingenious instrument that nullifies gravity.

This is one of the most interesting features ever presented. Be sure to read it in September SCIENCE and INVENTION.

To the Moon via Tunnel

A new method is presented of accomplishing the inevitable journey to our moon—via tunnel. Tremendously interesting. Full details and illustrations in September SCIENCE and INVENTION.

Summer Amusements

Here is one of the most elaborate articles on a host of practical helps to summer recreation, written by an authority on this subject.

And many other new, illustrated articles on Science and Radio.

25c EVERYWHERE

Subscriptions—\$2.50 the year

Experimenter
Publishing Co., Inc.
230 Fifth Ave., New York

AMAZING STORIES

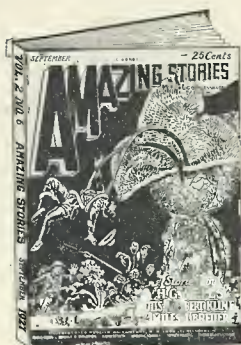

The Malignant Flower

"But even then the awful thing came to pass. The flower slowly opened, and something bright and flesh-colored shot out of it. What darted so suddenly? Was it the sucking arms of an octopus? Was it the soft arms of a woman? From Sir George there came a scream that cut to the very marrow, and John Bannister, frozen stiff with fright, saw his master lifted by his shoulders, up, higher, and higher, saw him, hanging for a couple of seconds in uncertain balance, and finally disappearing slowly into the calyx of the atrocious, malignant flower, whose petals once more drew themselves together with a start."

We have given you only one exciting paragraph of the most amazing story of the month. The terrible valley of the malignant flower, the journey of Sir George, the dreadful result and his subsequent rescue will keep you in tense excitement every minute of the time. Read this complete story in September AMAZING STORIES.

The Radio Ghost

The radio instruments we know today are diverted to very odd and criminal uses which weave a tremendously exciting story dealing with a great fortune in money. A big feature of September AMAZING STORIES.

The Tide Projectile Transportation Company

How would you like to fly from San Francisco to New York in about 17 minutes? Impossible, you will doubtless say, but the thing is not half as impossible as it sounds. There is no question but that our transportation means will increase in speed as time goes on. If you had told your great-grandfather that some one would fly from New York to Paris in 33 hours, you probably would have been called a lunatic, or worse.

Some very interesting and really excellent science on high speed travel is woven in this splendid amazing story. See September AMAZING STORIES. Other illustrated stories—100 pages of Scientifiction. Size 9 x 12 inches.

25c EVERYWHERE

Subscriptions—\$2.50 the year

Experimenter
Publishing Co., Inc.
230 Fifth Ave., New York

SPARE-TIME MONEY MAKING



Reader Tells How He Established Sparetime Business Netting \$109 Monthly

How would you like to have \$109 a month over and above your regular income? R. A. Privott of Suffolk, Va., overcame his financial difficulties with ease through SPARETIME MONEY MAKING. Adopting a suggestion from an early issue, he set out to sell a Theatre Program. With the sanction of the local theatre manager, he visited the local merchants. In one day he sold enough advertising space to realize \$180 that month. Deducting printing costs and miscellaneous expenditure, the total clear profit was \$109.50.

This is only one of hundreds of men and women who have turned SPARETIME MONEY MAKING ideas into ready cash with little effort. Every issue contains page after page of practical plans, complete in every detail and ready to use.

Enjoy life's luxuries. Make your life free from financial worries. What thousands of others have done, you can do.

Read SPARETIME MONEY MAKING.

96 pages of workable plans of making a bigger, better income. Size 9 x 12 inches.

15c THE COPY

Subscriptions—\$1.50 the year

CONSRAD CO., Inc.
230 Fifth Ave., New York

RADIO LISTENERS' GUIDE

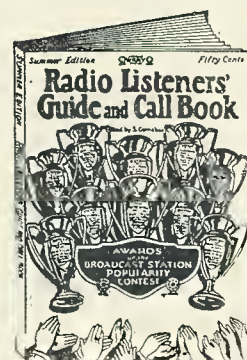

Broadcast Stations of the World

Here is the latest book of complete information on the Broadcast Stations of the world—giving call letters, ownership, power, wave length in meters and kilocycles, and time of operation—together with space for listing dial readings.

U. S. stations are listed 3 ways. By call letters, by wavelengths and by states and cities.

Transoceanic Receiver

In this issue of RADIO LISTENERS' GUIDE AND CALL BOOK is given complete data and information on "how to build" one of Radio's great super-power receivers called the "Transoceanic New Phantom Receiver." This is an ideal set for listeners who desire good volume, clear reception at all seasons and distance when desired.

13 to 735 Meter Receiver

Here is the ideal set ranging from 13 to 735 meters. This means short wave reception as well as regular waves. It is unique in that it is one of the most practical and efficient circuits of its kind. All "How to build" instructions are given in the Summer Edition of RADIO LISTENERS' GUIDE AND CALL BOOK.

How to Install Power Tubes

Power tubes are essential to many receivers, learn how to install them. See RADIO LISTENERS' GUIDE AND CALL BOOK—Summer Edition.

Experiments with Large Cone Speakers

Large cone speakers are the solution of many reproducing problems. Noted engineer tells about them in the Summer RADIO LISTENERS' GUIDE AND CALL BOOK.

50c THE COPY
ON ALL NEWSSTANDS

or direct from
CONSRAD CO., Inc.
230 Fifth Ave., New York

**Now
You can build the
kind of a radio you
have always wanted**



**This
BOOK
TELLS
HOW**

No matter whether you want to improve a set you now have or build a new one - get this book first. Tells how to build the latest one, two and three dial receivers - 5 to 7 tubes.

10¢ PREPAID

GEARHART-SCHLUETER, Fresno, Cal.

FROST-RADIO

**DE LUXE
APPARATUS**



YOUR dealer now can furnish Frost-Radio De Luxe Rheostats and Potentiometers, Variable High Resistances and Fixed Resistances—the NEW Frost Apparatus with highly polished hand buffed nickel plated metal parts and other features. Rheostats and Potentiometers have genuine flexible Bakelite resistance

strips, new style Bakelite knobs with white engraved pointer. Supplied with filament switch at slightly higher cost. There is no finer apparatus than the new Frost-Radio De Luxe line. Your dealer has it.

HERBERT H. FROST, INC.
Main Offices and Factory: Elkhart, Ind.

Improve reception in any circuit!

**REMLER
RADIO PARTS**

Write for New 1927 Catalog
Remler Division of
Gray & Danielson Mfg. Co.
260 First Street - San Francisco

100% ELECTRIC RADIO

The Metrodyne All Electric Radio does away with all batteries, eliminators, chargers, acids, etc. World's Greatest Electric Radio. Shipped on 30 days' free trial. Write for details!

METRO ELECTRIC CO.

2161 N. California Ave. Dept. D. CHICAGO, ILL.

of parts sold are sold direct to a group of set builders, young men who have a fair knowledge of radio construction and set building and are able to do very efficient work. They buy at the usual dealers' discount. Their customers secure the big advantage of a personal service that no regular dealer having a large business and numerous customers can give. They do practically no advertising, secure customers through friends and users of their sets, and build their business on their reputation.

The Gearhart-Schlueter Radio Corporation of Fresno, California, has nearly 5,000 professional set builders on its lists and sends them literature regularly just as it does its regular dealers. It recognizes the professional set builder who actually resells parts and sets, and tries to get its jobbers to take care of their needs. They believe that most of the parts now being sold are going to the professional set builders. They do not sell direct to these builders, except in territory where they have no distributors; but they feel sure that thousands of set builders are building and selling their sets.

WHAT ABOUT COMPETITION?

Do the community set builders cut into the business of those who sell factory-built receivers? One man of wide experience states that their competition is less than might be supposed. While they may build custom sets for some customers who otherwise might purchase factory-built sets, they also develop fields that are scarcely touched by regular radio dealers.

Often it is assumed that the cities where there are radio shops fill the needs of all the small villages, hamlets and rural districts for miles around; but one has only to live in a small community for a few days to realize that there are many country people who seldom visit a city. One reason is that a large proportion of persons whose incomes are less than the average live in the smaller places and on farms. They have to count the pennies. Only the community set builder who knows them intimately and is trusted by them can bring them into the radio market. He can build a small set for what it would cost some customers to look for one in the city.

HELPS ALL CONCERNED

There have been few developments in any business that seem more promising, from every point of view, than this community set building. To the extent set manufacturers can cover the field, they will secure the patronage of all who want manufactured sets. The community set builders themselves will not be slow to sell factory-built sets when they discover customers who want them rather than custom-built receivers. No manufacturer is covering the field completely.

For example, there is a man who has been in the market for radio for more than a year. He is ready to buy a broadcast receiver, a short-wave receiver and an amateur transmitter. He made his wants known through a coupon published in RADIO NEWS and received two or three catalogues. He acknowledged these and asked where he might see the apparatus in operation.

One concern, instead of clinching the sale, referred him to its state distributor; thus putting the prospective customer to the trouble of writing another letter. After a week or two the state distributor sent his name to the local dealer, who sent a salesman. The salesman carried the deal up to the point where the customer was ready to buy, as soon as he saw the apparatus in operation and thus satisfy himself that it was what he wanted. The salesman promised him a demonstration, but it never was given and there the matter dropped. The customer's credit was good and he was prepared to pay cash. A community set builder would

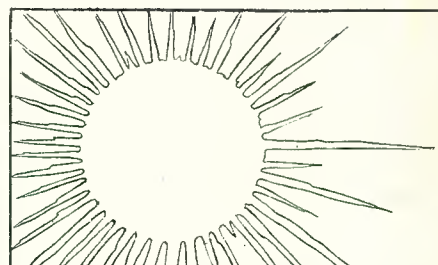

*Everywhere
Under
The Sun*

**Speed
SUPER
EMISSION
Radio
Tubes**

*A Tube for
Every Radio Need*

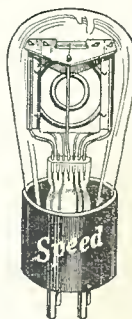

CABLE SUPPLY CO. ^{INC.}
MANUFACTURERS

EXECUTIVE OFFICES

31 Union Square, New York

10 Days Trial



Forget "B" Battery Nuisance

~ FERBEND ~
"B" Socket Power Unit
Within Reach of All

Original cost less than half of any equipment of similar quality; lowest maintenance cost. Equal to any, not only in operation, but in workmanship, quality, durability and appearance. Sooner or later you will change to "B" Socket Power. Why pay more?

Model III, for all sets using 90 volts . . . **\$12.50**

Model IV, for extremely large sets and sets using power tubes; delivers up to 180 volts, \$17.60.

ORDER NOW

Shipment made direct upon receipt of price or C. O. D., if preferred. Use for 10 days; if not satisfied, write us within that time and purchase price will be refunded. Send today. **FERBEND ELECTRIC CO.** 425 W. Superior St., Chicago

ENDORSEMENT
 Hartford, Conn.
 "Enclosed find \$17.50 for which please ship me one of your high voltage eliminators as advertised. At the present time I am using your 90 volt model bought from you some time ago, but having built a new set which requires more "B" voltage, the larger Eliminator is necessary. I am having no trouble disposing of the smaller Eliminator to one of my friends. It certainly does all you claim for it, and I will gladly recommend your products to anyone."
 Herbert G. Bissell

Tested and Approved by the Rigid Laboratory Tests of Radio News and Popular Radio

Like a Long Arm!

Tune out a poor program and bring in a good one—without leaving your easy chair. Only tuning unit of its kind.



The NEW
Thermidyne
Patented in U.S.A. and Foreign Countries
REMOTE CONTROL RADIO TUNING UNIT

Easily attached to any single dial receiver with removable dial by removing old dial and attaching Remote Control adapter plate.
 Mechanical Model. \$18.00
 Electrical Model. \$60.00

Write for illustrated descriptive circular
ALGONQUIN ELECTRIC CO.
 245 Fifth Avenue New York City

BIG RADIO CATALOG

From the "Big, Friendly Radio House"

NEW 1928 Book offers finest, newest well-known sets; parts, eliminators, accessories at lowest prices. Set-builders, dealers, agents—WRITE for this CATALOG!

Western Radio Mfg. Co.
 126 West Lake Street—CHICAGO, ILL.

ELECTRICITY—EASY AT LAST!

Learn By Doing in 90 Days

NO BOOKS—NO LESSONS. Prepare for jobs leading to \$60 a week and up. Come to COYNE for 90 days then get one. Learn by doing. COYNE gives you training and experience. Write for big FREE book. **COYNE ELECTRICAL SCHOOL, 500-524 S. Paulina Street, Dept. 67-77, Chicago, Illinois.**

take care of such a customer in a hurry; but a large organization, after spending thousands of dollars in advertising to interest customers, often loses them through carelessness.

NEGLECTED OPPORTUNITIES

To a New England town one of the richest men in America gave a new school building, and after that an athletic field. Then he gave thousands more for up-to-date equipment, and stated that he wanted that school to have every modern appliance. There are five stores in the town that carry radio as a side line. A man who is in touch with the situation, though not in the radio business, has found amusement in watching to see how long it will be before the radio dealers wake up. Such a school could use several first-class receivers, and a dozen or more loud speakers in different class rooms; and there is hardly any doubt that the philanthropist would provide them if anyone suggested it.

Months went by. The principal and teachers did not seem to know that radio was being used extensively in school work. The state board of education started to broadcast a formal course of instruction. The first lesson was received by 275,000 pupils in five states, but not in this town.

Eventually one of the dealers was approached by the superintendent of schools. He made a feeble and unsuccessful attempt to bring in a lesson; not at the school on the hill, where conditions may be very good, but at his shop down in the valley. The broadcasting station is only one hundred miles away, but he fizzled and lost the sale. He ignored the fact that stations at all points of the compass are broadcasting programs of educational value that would justify the installation of radio receivers, even if the station he tried for could not be brought in. He could have installed a good set in the auditorium, brought in one of Lindbergh's speeches the day he returned to America, and aroused the enthusiasm of pupils to the point where there would have been a spontaneous demand for radio in the school. But—nothing doing!

THE BUILDER'S OPPORTUNITY

A community set builder has many advantages over those who sell radio only when the customers are insistent enough to drag a set out of a store. He knows circuits, parts, the fine points of operation. He is of necessity an accurate trouble-shooter. He is close to the customers. They know that the man who builds a set is the best man to install it and keep it in working order.

He can work on part time until he becomes established. His overhead expense is much smaller than that of a regular dealer; if, indeed, he has any overhead at all. He can buy parts at wholesale prices as soon as he can take a reasonable quantity, and sell a complete set for about what it would cost the customer to buy the parts.

He can remodel a set, or exchange sets, at less expense than a dealer who has to employ someone to do the work.

Many a man could fill his spare time profitably, and possibly emancipate himself from less agreeable work and financial worry, by becoming a community set builder.

FRENCH NOT "BOILED OWLS"

THE prevalent American idea of the Frenchman as a devotee of late hours should be subject to revision, in view of the complaint of *L'Antenne* (Paris) that the present broadcast programs are "entirely too late for the majority of their possible hearers. Their schedules are planned for the wealthy inhabitants of cities, and not for those who live in the country, or who have to get up at a reasonable hour. After 20 or 21 o'clock (8 to 9 p. m.) the programs are a waste of time. The "noctambules" (night owls) can listen in to foreign stations."

R.E. Lacaull * Knows- SUPER-HETERODYNES

*Originator and designer of the nationally known 'ULTRADYNE,' Radio Engineer, and former Editor with many years practical experience on Super-Heterodynes.

He has written this book for you

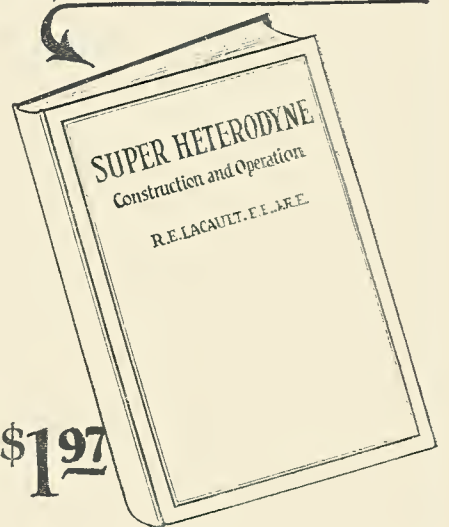

\$1.97

R. E. LACAULT has been an Editor of R. Radio magazines for many years. He has specialized in the greatest and most powerful of all Radio Circuits, "The Super-Heterodyne." He has studied, originated and developed to marvelous perfection the "ULTRADYNE" Super-Heterodyne. He has advised thousands of set owners and builders in Super-Heterodyne problems.

—and now he has used his immense experience, his clear mind and his editorial ability to write, by far the most lucid, interesting, instructive and plainly written book on the theory and construction of Super-Heterodynes that has ever been published.

You who already own Super-Heterodynes will find this book especially helpful in locating and correcting troubles. A special trouble chart is printed for detecting and correcting common faults.

SEND NO MONEY

Just send us a card mentioning the book with your name and address. We will mail you the book. You pay the postman \$1.97 plus a few cents postage on delivery.

Distributed by

THE CONSRAD CO., Inc.

230 Fifth Ave., New York, N. Y.

for power circuits

It has become standard practice to use Parvolt Wound Condensers

in circuits which quickly break down ordinary by-pass or filter condensers.

You will find that the same characteristics of accuracy, high direct current resistance, and the ability to give continuous duty at full rated voltage, make them desirable in circuits where even a poor condenser might "get by."

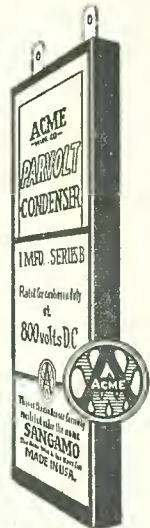

THE ACME WIRE COMPANY
New Haven, Connecticut

PARVOLT WOUND CONDENSERS



NEW UNITS

of the plug-in type designed to receive all wares. R. E. L. units may be used in any circuit. Accurately matched capacitors for tuning amplifiers designed to operate at one frequency only. 35c each. As illustrated—price complete with base \$1.50.

We Specialize
In All Specified
PARTS FOR



THE STROBODYNE

Let us send you new Radio hand book. It's Free.

RADIO ELECTRIC LABORATORIES

116 West 65th St., New York City
Only firm having exclusive services of
Mr. R. E. Lacault, E. E.

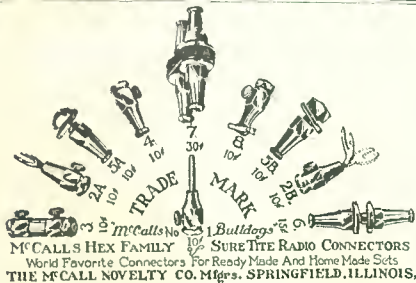

McCALL'S HEX FAMILY
World Favorite Connectors For Ready Made And Home Made Sets
THE McCALL NOVELTY CO. Mfgs. SPRINGFIELD, ILLINOIS.



TRANSFORMERS
The ultimate choice of America's leading radio engineers. Unconditionally guaranteed. Jobbers—Dealers—Write for facts.
HIGH FREQUENCY LABORATORIES
129 N. Wells St., Chicago, Ill.

Correspondence from Readers

(Continued from page 246)

studied arrogance of your correspondent. Mr. Endax, who boasts, in the July number of RADIO NEWS, of having received Australia on his crystal set, that I was impelled to set down a brief account of my DX successes.

My set was built from a hook-up furnished by one of your competitors and the parts were obtained from a local dime store. The initial cost was but \$4.50 but I must admit that the upkeep was something terrible.

Simplicity and efficiency plus were obtained by using the local telegraph line as an aerial and the Delaware River as a ground. San Francisco, Shanghai and Lhasa came in easily; although I must admit that the broadcasting of Babylon and Damascus could be improved upon immensely.

Not content with these notable contributions to DX literature, I added several more tubes and condensers and with some suspense twirled a few of the dials.

After an agonizing pause the most unearthly howlings that I ever heard proceeded from the loud speaker, followed by the distinct sentence: "A little more coal, Boys!" An eminent English clergyman who was standing nearby (the very soul of truth, by the way) immediately recognized this broadcasting as proceeding from Station L. Geheima. "Those howls," he remarked simply, "are undoubtedly the anguished cries of deceased DX hounds who are paying the penalty for their misdeeds and misrepresentations on earth."

It would appear boastful were I to tell of receiving certain celestial harmonies that were never produced on earth and the daily weather reports from Mars. However, I believe that I have said enough to convince the wildest DX enthusiast that he has a formidable rival.

H. S. SMITH,

104 Spring Garden Street, Easton, Pa.

THE RADIO ANNOUNCER

*Valued servant, he knows howeski
People should pronounce Tchaikowsky,
Ponders deeply, forehead moppin',
On some words to say of Chopin,
Or explains to us the theme
Of the lovely "La Bohème."
Though he may miss out on "Thais"
His dispatch deserves our praise.*

Park Cummings in *The Forum*.

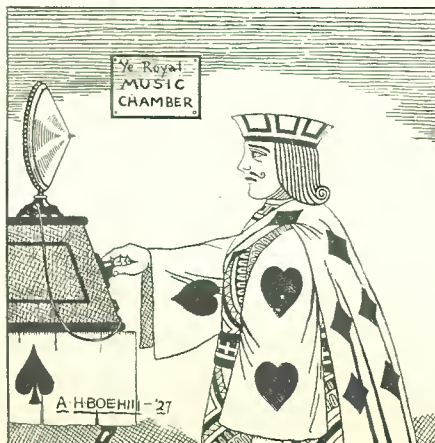

"A RADIO JACK"

Announcing New WARREN

"B" Supply

Model "T"
Tube
Unit



\$27
including
tube

Here's what it's
Guaranteed to deliver

260	Volts	at	25	Mills
235	"	"	35	"
210	"	"	45	"
185	"	"	55	"
162	"	"	65	"
140	"	"	75	"

from 110 V. 60 Cycle
A.C. Current

Here it is—an absolutely new "B" supply (tube unit) that gives you even more power than you'll ever need. Whether you have a one or a dozen tube set the Warren delivers the voltage and current even above its rated capacity. It comes to you complete, including 85M. tube for \$27. (West of Rockies \$28.50.)

Unapproached in reproducing the most delicate sounds in their natural tones; unparalleled in delivering constant "B" power without objectionable hum. Unsurpassed for quality material, workmanship and appearance.

The Warren has three voltage controls. A turn of a knob provides any voltage you may require on the detector, intermediate or the amplifier. Also has direct power tap for high power tubes. Measures 5 1/2" x 6 1/2" x 9 1/4". Steel case finished in old gold.

The same house that makes the famous "Warren" electrolytic (chemical) unit—approved by RADIO NEWS—that is giving complete satisfaction in every state in the Union is now placing on the market this new Model "T" tube unit. Acclaimed by engineers, experts and radio laboratories as equalling and in fact surpassing units of double the price. Send in your order direct if your dealer does not yet have the new Warren. Sold on a money-back guarantee.

Dealers: Write for proposition quick!

Warren Electric Co.

Dept. RN

Peoria, Ill.

Ship at once Warren "T" (tube unit) @ \$27. Complete. (West of Rockies \$28.50.)

Ship at once Warren "C" (Chemical unit) @ \$29.75. Complete. (West of Rockies \$31.25.)

Send Free Literature on Tube Unit
Chemical Unit

Use this coupon—write name and address plainly on margin below.

Buy or BUILD with confidence

and Insure Permanent Enjoyment of Your Radio Set!

USE
**"THE DIRECTORY OF
 STANDARD RADIO SETS"**
 for
 buying

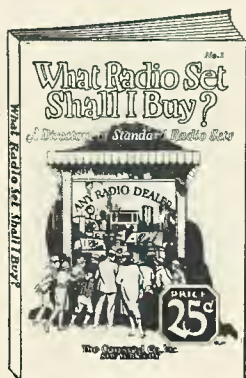

THERE is one easy—simple way to decide on what Radio Set to buy. If you are particular as to the style of the set, the power, the sensitivity, the price, or anything that has to

do with a manufactured set you will find a complete answer in the "DIRECTORY OF STANDARD RADIO SETS."

Photographs of all standard manufacturers are shown together with an exhaustive printed description furnished by the manufacturers themselves.

This book is absolutely impartial. It is the only printed book in existence that gives you this information.

40 pages of descriptions and illustrations, size 6 x 9 inches with handsome colored cover.

PRICE, 25c.

USE
**"HOW TO TUNE YOUR
 RADIO SET"**

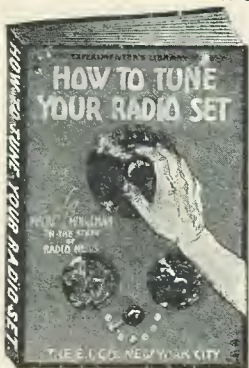

to
 enjoy all
 programs

RADIO Receivers know no rules of etiquette—they cannot be taught to act on best behavior when company and friends are judging them—but they can be made to act properly if the operator understands the few simple factors that effect tuning or the proper adjustment of the Receiver's controls.

Be one of those on the safe side. Don't be afraid to invite friends and show them that good tuning means good reception and enjoyable programs.

The 64-page, illustrated book on How to Tune Your Radio Set (Conrad—25c) is a carefully prepared, yet simplified, instruction book on tuning alone.

Receivers, of different types, individual characteristics are handled separately. All there is to know, all that must be known before one can really say to understand the tuning of a set—is given in this book.



only
 \$1.00

buys an entire set of these four books of vital importance to every one owning or contemplating the purchase of a radio set.

They can be bought separately if desired at

25c each

Fill out the coupon below and mail it with your remittance today.

All orders filled promptly.

USE
"THE RADIO TROUBLE FINDER"
 to insure permanent satisfaction

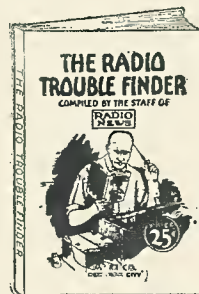

THE "RADIO TROUBLE FINDER" is a book prepared by a Radio Expert with many years of practical experience. It is a proven fact that 99 out of every 100 complaints from Radio set owners can be traced to simple and minor troubles that a child could repair with a simple book of instructions—and only once in a lifetime the average man need pay an expert to repair his set—if he has a copy of the "RADIO TROUBLE FINDER."

This simplified 64-page book charts all troubles and how to correct them.

It is the simplest thing imaginable to use it. Even the more difficult jobs of changing internal mechanism of the set can be accomplished successfully.

The "RADIO TROUBLE FINDER" contains 64 pages, many of which are illustrated. It is size 6 by 9 inches with a colored cover—PRICE 25c.

USE
"150 RADIO HOOKUPS"
 for BUILDING



THIS 68-page book of the Conrad Company is the latest compilation of Hookups in Radio. The Hookups are those that have been tried, tested and perfected by time and by thousands of Radio Listeners. This priceless book contains: 18 Crystal Detector circuits, 39 Regenerative, 21 Reflex, 23 Radio Frequency, 10 Super-Regenerative, 10 Amplifier and Oscillator, 5 Super-Heterodyne and other valuable Hookups.

All circuits are shown by simplified drawings and each is explained in detail. The book is 6x9 inches in size, illustrated, and is contained in a special attractive 2-color cover.

PRICE 25c

CONRAD CO., INC., 230 5th Ave., New York.
 Gentlemen, I enclose \$.....for one copy of

- Directory of Standard Radio Sets.
- Radio Trouble Finder.
- How to Tune Your Radio Set.
- 150 Radio Hookups.

Name

Address

City, State

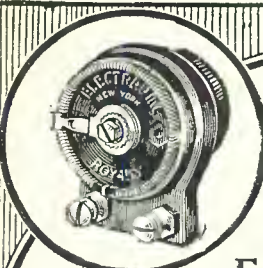

Exclusively Licensed by Technidyne Corporation under U. S. Patent 1593658, July 27, 1926.

For Better Reception

ELECTRAD Royalty Variable High Resistances

If you take pride in your set—if you want reception at its best—insist on these quality resistances. Remarkably accurate and dependable under all conditions. Used and endorsed by radio experts. Note these features.

- 1—Contact made positive by metallic arm on wire wound strip.
- 2—Resistance element not exposed to mechanical wear.

A range for every purpose—11 in all, designated A to L. Type E \$2.00. All other types \$1.50.

Write for hook-up circular.
Dept. 48A, 175 Varick St., New York, N. Y.

ELECTRAD

XL Products



Pep up Your Set!

Model "N" Vario-Densifier

Easier tuning—correct tube oscillation—more volume and clearness with an X-L VARIO DENSIFIER in your circuit. Specified and endorsed by foremost radio authorities in all leading circuits.

Model "N" Micrometer adjustment easily made assures exact oscillation control in all tuned radio frequency circuits. Neutrodyne, Roberts 2-tube, Brownig-Drake, Silver's Knockout. Capacity range 1.8 to 20 mfd. Price \$1.00.

Model "G" Obtains the proper grid capacity on Cockaday circuits, filter and intermediate frequency tuning in super-heterodyne and positive grid bias in all sets. Capacity range, Model G-1 .00002 to .0001 Mfd. Model G-5 .0001 to .0005 Mfd. Model G-10 .0005 to .001 Mfd. Price each with grid clips, \$1.50.

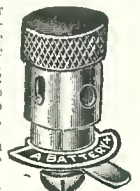

X-L PUSH POST—Push it down with your thumb, insert wire, remove pressure, wire is firmly held. Vibrations will not loosen, releases instantly. Price each 15c. Also in strips of 7 on black panel marked in white. Price \$1.50.

Free wiring diagrams showing use of X-L units in the new LOFTIN-WHITE constant coupled radio frequency circuit, and in other popular hook-ups. Send for yours today.



X-L RADIO LABORATORIES
2426 Lincoln Ave., Chicago, Ill.

EL MENCO HY-WATT

TRADE MARK
HEAVY DUTY RESISTORS

Ideal for all power work because metallized deposit on vitreous base gives wide, cool radiating surface. Permanently accurate, absolutely noiseless. Write us.

Electro-Motive Engineering Corp.
127 W. 17th St. New York

Scandinavian Radio Broadcasting

(Continued from page 205)

transmitter at Kiel, which covers South Jutland with the best of news, music and propaganda. The Danish government wishes to wait and see how much the Gisseloere station can do. If it can't cover this district, a new relay station will be erected in Jutland as far south as possible.

The tax to the government for a program of the best music is 1/10 of a cent, which we do not believe to be too much; as nothing can be bought cheap in Europe since the war—except broadcasting. This is for those who pay their license; we do not know anything about the number of persons listening without paying a cent, but there are quite a number here in Denmark as well as everywhere else.

The receivers used here in Denmark are chiefly crystal sets where these can be used with good results. Otherwise, modern 2-, 3-, 4-, and 5-tube-sets; and a few use "Supers" with loops. Many use 2- and 4-tube receivers of the neutrodyne system for 200-600 meters and 800-2200 meters. An automatic switch changes from short to long waves. Popular American sets and cone speakers are much in use in Denmark.

NORTHERN SCANDINAVIA

Sweden and Norway have more stations in operation than Denmark, on account of the longer distances.

Some of the Swedish stations are: Stockholm (454.5 meters), Motala (1305 meters), Boden (1200 meters), Gothenburg (416.7 meters), Falun (400 meters), Malmoe (260.9 meters), Helsingborg (229 meters), and Karlsborg (196 meters). Motala, with a power of 50 kw., new and up-to-date, is said to be the most powerful station in the world except for a couple of American short-wave stations.

Of Norwegian stations I'll mention: Oslo (461.5 meters), Bergen (370.4 meters), Fredriksstad (434.8 meters), Rjukan (448 meters), Notodden (423 meters), Hamar (566 meters), and Porsgrund (500 meters).

Swedish broadcasting is of a very high standard, especially the transmissions from the Royal Opera House at Stockholm. Also the studio programs come through beautifully; the orchestras, the materials used and everything being absolutely first-class work, the best that money can buy. Most programs are sent from Stockholm and transmitted over the other stations; but sometimes, Malmoe, Falun and Gothenburg send programs, which then are transmitted over Stockholm as well.

The latest relay station opened in Sweden was Helsingborg, lying opposite Helsingoer (Elsinore) in Denmark; whereby the Danes at Elsinore can now receive good Swedish programs on cheap crystal receivers.

The Norwegian broadcasting as well is good, but its quality is not so high. The country is large, with relatively few inhabitants, wherefore many costly stations are needed to cover the whole country with broadcasting. This does not pay so well as in Denmark where just as many people live on one tenth of the area. Lately, though, a few of the Norwegian stations have been well heard over good distances; but the quality and programs could be much better.

"TELL-OF-VISION"

Mrs. Jones: "Did you ever see such a marvelous television apparatus as that the Smiths have!"

Mrs. Brown: "Not in all my born days! I never saw a bigger bunch of gossips!"

—Rudolph V. Mezner.



"What do you think of that quartet?"

"Pretty good. And with the Rola Cone Speaker how rich, clear and full-toned is each voice. No tubbiness or slurring; every word clear and distinct and every bit of delicate tone-shading faithfully reproduced.

"That armature they use in the Rola Cone certainly is a wonder, Jack. With that set of yours and a Rola Cone you could hear a whisper in China."

The laminated armature, an exclusive, patented feature, is made up of eighteen precision parts, yet it is less than half the size of a postage stamp and is hardly thicker than a dime!

The new Rola Cone Speaker is artistically designed and beautifully finished in rubbed walnut.

Pedestal type, with twenty-foot cord, \$32.50. Table type, \$28.50.

Ask your dealer for a demonstration on your own set.

Rola CONE SPEAKERS

Manufactured by

THE ROLA COMPANY
Oakland, California

America's First Three Home Entertainers!!!

The incomparable book of
MYSTERY and
AMAZING FICTION

The First **AMAZING STORIES** "ANNUAL"

featuring... The Master Mind of Mars
by EDGAR RICE BURROUGHS

also stories by such famous Authors as H. G. Wells, A. Merrill,
Murray Leinster, A. Hyatt Verrill and Austin Hall

Where can you duplicate the galaxy of Amazing, Scientific fiction writers listed above? Where in America or elsewhere can you match the fiction stories of these master writers?

The feature of this new 116 page volume, AMAZING STORIES ANNUAL, which includes the very choicest selections of these writers is a special attraction, the story "The Master Mind of Mars," by no less a leading writer of America EDGAR RICE BURROUGHS.

This story appears in print for the first time in AMAZING STORIES ANNUAL.

If you want a copy of the greatest book of Amazing Fiction.—If you want a book that will give you thrills and chills galore—then buy a copy today of the first AMAZING STORIES ANNUAL.

50c THE COPY

Sold on all Newsstands or order direct

EXPERIMENTER PUB. CO., Inc.
230 Fifth Ave. New York, N. Y.

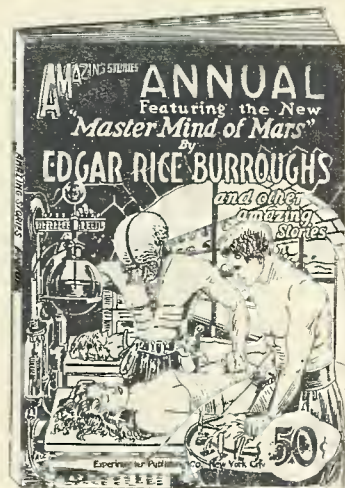

A whole book of
TRICKS

1000 HOURS of FUN With SAM LOYD

THERE are more than one thousand hours of truly amazing fun and frolic—in Sam Loyd's "Tricks and Puzzles." There is only one Sam Loyd, the Puzzle King, the incomparable, a true master mind, and he has crowded, in this new volume, "Tricks and Puzzles," the best work of his lifetime.

In this book are thousands of puzzles of every conceivable nature, games, tricks, conundrums. Hundreds of illustrations. Scores of real brain-teasing puzzle stories, dozens of humorous anecdotes.

50c THE COPY—ON ALL NEWSSTANDS

If your dealer cannot supply you write direct

EXPERIMENTER PUB. CO., 230 5th Ave., New York

With this inexhaustible gold mine of lively entertainment at hand you need never be at loss for an evening's party program or a rainy day's delight.

It's a book for young and old folks alike—Riddles for the youngsters—Brain teasers for the grown-ups.

The kind of a book every home should have in its book-rack. 116 pages, 100 or more illustrations, large size, 9 x 12 inches, with beautiful 2-color cover.

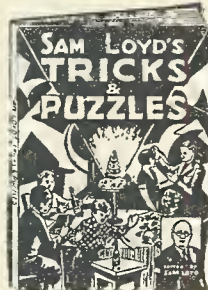

Learn the
SECRETS

SECRETS of YOUR HANDS!

96 Page Book. The Revelation of Character, etc., in Hands

FINGERPRINTS are used throughout the world as a means of apprehending criminals—but fingerprints are but a small portion of the secrets of your character that your fingers, your palm, ever, your handshake reveals.

Every inch of your hand as been charted by the experts of this highly developed science, and so simply and accurately that anyone can learn the telltale signs by heart.

50c THE COPY—ON ALL NEWSSTANDS

If your dealer cannot supply you write direct

EXPERIMENTER PUB. CO., 230 5th Ave., New York

Here is a brand new book with all the latest information—written in such a way that you can quickly master "Palmistry."

Typical hands of lawyers, doctors, people of strong characteristics are shown in large drawings on many pages.

Everything is simplified, easy to understand. The book contains 96 pages, hundreds of illustrations and is the large book size, 9 by 12 inches.



Obtaining Accurate Voltage Readings

(Continued from page 245)

found to be within 4 in the fourth decimal place of its "rated" value. This cell was then placed in a circuit containing a small load and another galvanometer, also sensitive to currents measured in microamperes. No current flow was detected by the galvanometer. The cell was "dead"!

In a manner similar to that of a potentiometer, an ordinary voltmeter measures batteries on a nearly-open circuit. The higher the resistance of the voltmeter, the nearer is the reading to that on an open circuit; and, besides, the ordinary voltmeter is not very carefully scaled. Thus, though the fan may read his voltmeter correctly, at the same time that instrument is lying to him.

In the case of the 1.5-volt dry cell described, the load gave the correct value of the *emf* delivery, which was zero. In the same manner, if the fan uses a milliammeter *in series with a load*, he will obtain the correct battery reading. Table I shows the open-circuit (voltmeter) and loaded-current meter data on several "B" batteries.

Table I

Bat. No.	Rating	Voltmeter	Loaded Current Meter
1	45V	40V	30V
2	45V	33V	20V
3	45V	42V	38V
4	45V	42V	38V

In each case, it is seen that the voltmeter reading is higher than the load reading. Data about a battery are obtainable by the use of a voltmeter only when the battery is so nearly dead that the set will not operate at all.

A DEVICE FOR TESTING

The fan and the service man may construct a good test instrument for measuring the electromotive force of both "A" and "B" batteries, as shown in Fig. 2. M is a 0-100-scale milliammeter, and R is a 1000-ohm resistance in series with it. P1 and P2 are contact points for touching the battery terminals. The scale reading on the milliammeter is then read directly in volts. A new "B" battery should read 45 on the meter and it should be discarded when the meter reads 35. An "A" battery should give a reading of 6 when it is fully charged and should be recharged at 4.5.

Though the above method is effective is shown by the facts detailed above and can be further checked with Ohm's Law. This law states that the electromotive force is equal to the product of the resistance by the current, or

$$E=RI.$$

Therefore, if the test instrument described is thrown across the battery and the meter reading is 38 milliamperes, then from the equation,

$$E=.038 \text{ (amperes)} \times 1000 \text{ (ohms)} = 38 \text{ (volts)}$$

The correct *emf* delivery is obtained.

FLIGHT BROADCASTS IN GERMANY

THE interest in the transatlantic flights in America was no greater than that in Europe. Six of the German high-power stations maintained continuous operation for forty-two hours during the Chamberlin-Levine flight on Sunday and Monday, which coincided with a season of long special programs on the Continent. A large part of the population of Germany remained awake through Sunday night, musical programs being kept up between the bulletins. On Monday the studios commenced broadcasting from Tempelhofer Field, where the airmen were unsuccessfully awaited, until the news of their forced landing at Kottbus was received.—Frank A. Gibson.



POWER UNITS

GIVE MATCHLESS SERVICE

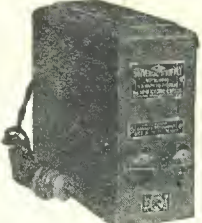

UNIVERSAL "B" POWER SUPPLY UNITS
BE-40 BE-60
\$35 \$39.50

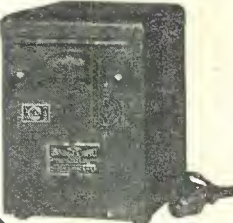

"A" POWER UNIT
Complete with 6-volt Battery and tube, etc. \$35.00



Use them to banish all your reception troubles. For performance, reliability and continuous efficiency they are unexcelled. Attractive, compact and of exceptional value.

The Acme A & B Socket Power Unit, at the turn of the switch, gives your radio a strong flow of constant, dependable A & B Power. It's quiet. Recommended for any number of tubes. Complete ready to operate at only.....\$72.50

Acme products are sold thru leading Jobbers and Dealers everywhere. For full information on the complete Acme Line write us. All prices quoted are List, East of the Rockies.

Clip and mail this coupon today—

AUTO-MATIC CONTROL SWITCH
\$3.75



Factory Representatives in leading cities
Members also of Radio Mfrs. Assn.

A & B" SOCKET POWER UNIT
AB-1-R \$67.50
AB-2-R \$72.50

Send me your latest literature on Acme Radio Products.

Name.....

Address.....

City.....

EQUIPMENT

THE ACME ELECTRIC and MANUFACTURING CO.
1412 Hamilton Avenue
Cleveland, Ohio

Greater—Better Radio Values IN THE WORLD'S GREATEST RADIO CATALOG

ALL under one roof. You don't need to look elsewhere. Complete stock carried. Prompt, efficient, dependable service. All orders, small or large, filled promptly.

You must have this catalog if you want everything—the best in radio, at a big saving. Contains all the information that you need. Answers all radio questions that you ought to know. It won't cost you a cent. Just drop us a card today.

Established 1918



IT'S FREE!

TELEPHONE MAINTENANCE COMPANY
123-B S. WELLS ST. CHICAGO, ILL.

CHICAGO'S OLDEST RADIO HOUSE

Complete sets—Cabinets—Speakers
Tubes—Batteries—Accessories—New Devices—Complete Parts for Every Known Circuit.



WHOLESALE ONLY

Six tubes—One Control **FRESHMAN MASTERPIECE**

Sold by Authorized Freshman Dealers Only

30 DAYS' FREE TRIAL! METRODYNE RADIOS!

We are one of the pioneers of radio. The success of Metrodyne sets is due to our liberal 30 days' free trial offer, which gives you the opportunity of trying before buying. Thousands of Metrodynes have been bought on our liberal free trial basis. Don't buy any radio set until you get our offer. Write!

METRO ELECTRIC CO.
2161 N. California Ave. Dept. D. CHICAGO, ILL.

C. R. LEUTZ, Inc.

6th and Washington Aves.
LONG ISLAND CITY NEW YORK

Radio Transformers

For All Purposes

Thordarson Electric Mfg. Co.
500 W. Huron Street
Chicago, Ill.

(3511)

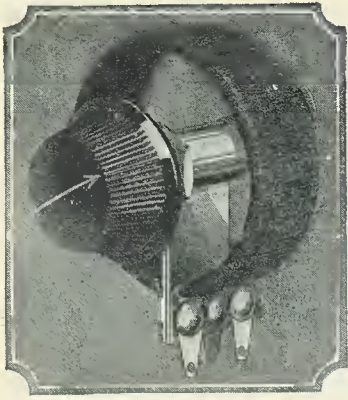

WIRE WOUND POWER Rheostats Potentiometers

A new Centralab unit designed for heavy current control in Power supply and AC Radio Circuits. All materials practically heat-proof. No fibre to warp or burn out. Wire wound on metal core insulated with asbestos. Wire is firmly held in position at all times because core and wire expand under heat in the same ratio. These new units will dissipate over 50 watts at 482° Fahrenheit. Diameter 2 inches, single hole mounting.

Write for new circuit folder on Light Socket Power for Radio Receivers.

CENTRAL RADIO LABORATORIES
19 Keefe Ave. Milwaukee, Wis.

Centralab
CRL

90 Volt Power Unit :: \$12.75

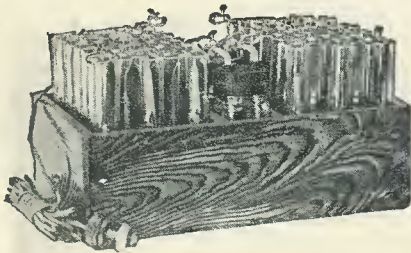

Hums, line noises, etc., positively impossible with this new advanced unit. Plug in and forget Non-acid and noiseless. All detector and intermediate voltages plainly marked. Simpler to hook up than dry cells. Operates any type set 1 to 12 tubes. Greater volume and clearness guaranteed. If not thoroughly satisfied return after using 30 days for complete refund. Guaranteed further 2 years. For 110-120 volts A.C. 25 to 60 cycle current. 90 volts, \$12.75; 112½, \$15.25; 135, \$17.50; 157½, \$19.50; 180, \$24.00; 202½, \$26.00. Also built for D.C. current 110 and 32 volts at only \$3.00 additional, any size above. Ample stocks—same day shipments. Simply say—ship C.O.D. or write for my interesting literature, testimonials, etc.

B. HAWLEY SMITH

334 Washington Ave., Danbury, Conn., U. S. A.

World's Greatest Radios

Thousands of homes are enjoying coast to coast programs on Metrodyne receivers. None better at any price. Shipped on 30 days' free trial. Write for details before you buy any radio set.

METRO ELECTRIC CO.

2161 N. California Ave., Dept. D. CHICAGO, ILL.

With the Amateurs

(Continued from page 240)

The transmitter works on the ninth harmonic of a 354-meter fundamental.

Cards acknowledging reception of 7XF broadcasts have been recently received from



Mr. Brown at the "mike" of 7XF, which has crossed the Pacific with two-way voice transmission.

SC-2BL, Valparaiso, Chile, about 7,000 miles; G-2BZW, Surrey, England, and EG, receiving station, Exeter, England.

—Robert Day.

(Since the receipt of this item and photograph, press dispatches announce that a world's record in two-way telephone transmission has been set by a two-hour conversation between E. J. Lesser, manager of the Simpson Radio Corp., owning 7XF, and J. W. Robinson, 2RN, an amateur at Concord, about two hundred miles from Brisbane, Australia. The distance covered with 100 watts, on 38 meters, is about 7,000 miles. —EDITOR.)

ALL CONTINENTS ON A 201A

A CALIFORNIAN "ham," Col. Clair Foster of Carmel, 6HM, succeeded in working South Africa and China in the same day, thus completing the coveted record of all continents on the same tube—a common 201A and dry batteries. The work was done on 38.2 meters; except for communication with English amateurs on 20.2.

IRISH AMATEURS ACTIVE

Editor, RADIO NEWS:

I enclose a list of the licensed amateur wireless transmitters in the Irish Free State in the hope that it may be of some interest.

Reports will be appreciated. Irish amateurs can be heard working most evenings on a wavelength of 45 meters.

JAMES KITCHEN,

Editor, Irish Radio Review,
179 Great Brunswick St., Dublin, Ireland.

AMATEUR RIGHTS IN COURT

AN injunction against the town of Wilmore, Kentucky, is sought by R. B. Whitehurst, 9ALM, to prevent the levy of a tax of \$100 a year on his amateur transmitter, on the grounds that its operation is a matter solely under the jurisdiction of the federal government. Hitherto several such cases of attempted local regulation (usually inspired by a mistaken belief that the amateur spoils broadcast reception) have been made; but the local authorities have given

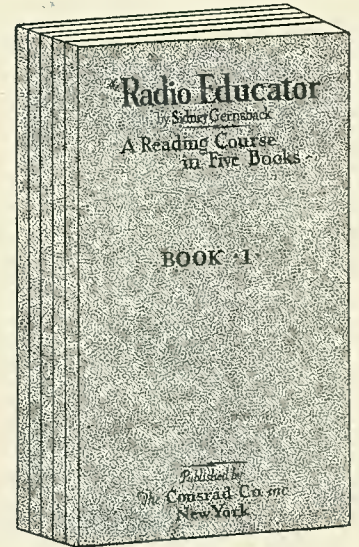

Price \$1.97

A RADIO EDUCATION IN 5 VOLUMES

"THE RADIO EDUCATOR"

Theory, Design, Construction,
Operation and Maintenance

LEARN AT HOME

THESE five component parts of a complete Radio Instruction Course are outlined in five volumes that contain not merely the essentials as so many books do, but more, they contain all that any modern up-to-the-minute textbook on any subject would cover. They are in themselves a COMPLETE radio education teaching every possible portion of Radio science.

Size of each book 6 by 9 inches, handsomely bound and illustrated with charts, diagrams, descriptions of equipment, etc. Each volume 52 pages.

SEND NO MONEY for these books. Just forward your name and address. We send you the books at once. On receipt of same you pay the postman \$1.97 plus a few cents postage and then they are yours.

Distributed by

The Consrad Co.

Incorporated

230 Fifth Ave., New York, N. Y.

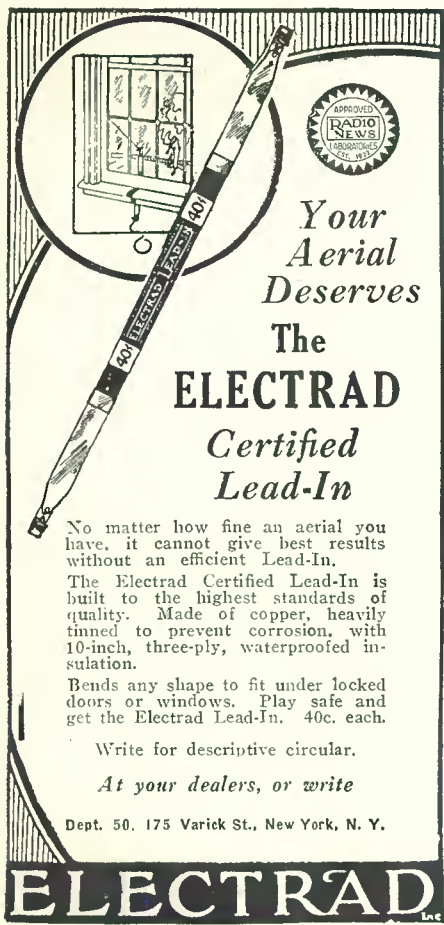

Your Aerial Deserves The ELECTRAD Certified Lead-In

No matter how fine an aerial you have, it cannot give best results without an efficient Lead-In. The Electrad Certified Lead-In is built to the highest standards of quality. Made of copper, heavily tinned to prevent corrosion, with 10-inch, three-ply, waterproofed insulation. Bends any shape to fit under locked doors or windows. Play safe and get the Electrad Lead-In. 40c. each.

Write for descriptive circular.
At your dealers, or write
Dept. 50, 175 Varick St., New York, N. Y.

ELECTRAD Inc.

up the attempt rather than support their position in the courts.

IN THE "HAM" LANGUAGE

WE have never concealed our dislike of the misuse of "Radiese" in ordinary written correspondence and are therefore entirely in agreement with a correspondent in the *Journal des 8* who writes as follows on the absurd misuse of the code "73" as a suitable finish to correspondence: "The employment of "'s" after the formula of courtesy "73" is superfluous, for "73" stands for "best regards"; why then add a possessive "s"? Perhaps to give it a more American air; but is it not a redundancy? Again, why put a superfluous "best" before the "73"? "73" itself means "best regards."—*Wireless World.*

NEW POLISH STATIONS

A 4-KW transmitter has been opened at Posen, thus extending the Polish broadcast system; it operates on 270 meters. Another station, at Kattowitz, is scheduled to begin operations in September.

NEW QRAs

- 2AUA, Dramin D. Jones, removed to 2254 Cedar Ave. (Bronx), New York, N. Y. 75 watts, 40 meters.
- 5AXA, J. Barbour, 2829 Alabama St., Shreveport, La. 15 watts, 40 meters.
- 5AYA, Harold Brown, Cedar Grove, La. 50 watts, 40 meters.
- 5FX, Bob Trimble, 618 Herndon Ave., Shreveport, La. 100 watts, 20 meters.
- 5WY, Hugh Claycomb, 212 Marshall St., Shreveport, La. 1 kw., 40 meters.
- 9AKR, Howard Bailey, R2, Senath, Mo., 7½ watts, 80 meters.
- NU7PH, 7ABV, Leo G. Sands, 2119 McDougall Ave., Everett, Wash. Low-power tests with GBM, Leafield, Oxford, England, and KWT, Palo Alto, Calif. If you hear mi sigs, pse QSLL.

The latest additions to the ranks of amateurs in the Irish Free State, bringing the number to seventeen, are (see letter above):
GW-16C, George Norrander, 44 Dufferin Ave., S. C. Rd., Dublin.
GW-17C, J. B. Scott, 9 Upper Garville Ave., Rathgar, Dublin.
GW-18C, J. Benson, 46 Dufferin Ave., S. C. Rd., Dublin.
The above intermediate is still in use. QRAs can be published only if they are new or involve a change, so that they are not available in amateur's call books.—EDITOR.

STANDARD-FREQUENCY TRANSMISSIONS

THE schedule of standard frequency transmissions by the Bureau of Standards, from its station WWV, Washington, for the next three months is given below. Information on how to receive and utilize them is contained in Letter Circular 171, sent by the Bureau on request from interested parties. The transmissions are by continuous-wave radio telegraphy. The signals have a slight modulation of high pitch which aids in their identification. A complete frequency transmission includes a "general call" and "standard frequency signal," and "announcements." The "general call" is given at the beginning of the 8-minute period and continues for about 2 minutes. This includes a statement of the frequency. The "standard frequency signal" is a series of very long dashes with the call letter (WWV) intervening. This signal continues for about 4 minutes. The "announcements" are on the same frequency as the "standard frequency signal" just transmitted and contain a statement of the frequency. An announcement of the next frequency to be transmitted is then given. There is then a 4-minute interval while the transmitting set is adjusted for the next frequency.

The figures given opposite each time represent the frequencies in kilocycles, which correspond to the respective wavelengths in meters given below in parentheses. The time is Eastern Standard.

Time	Aug. 22	Sept. 20	Oct. 20
10:00 to 10:08 p. m.	250 (1199)	3000 (100)	550 (545)
10:12 to 10:20 p. m.	283.3 (1058)	3300 (91)	633.3 (473)
10:24 to 10:32 p. m.	320 (937)	3600 (83)	733.3 (409)
10:36 to 10:44 p. m.	363.7 (825)	4000 (75)	850 (353)
10:48 to 10:56 p. m.	410 (731)	4400 (68)	975 (308)
11:00 to 11:08 p. m.	466.7 (643)	4900 (61)	1125 (266)
11:12 to 11:20 p. m.	525 (571)	5400 (56)	1300 (231)
11:24 to 11:32 p. m.	600 (500)	6000 (50)	1500 (200)



There's the 'B' for Your Set

\$28⁵⁰

with Raytheon B Tube

IF YOUR SET has five tubes or five and a Power tube, you can now get a Sterling Raytheon-equipped "B" for it at \$28.50—why spend more? Think of it! For less than \$30 you can get rid of "B" batteries once and forever and in their place be sure of full-powered Sterling-filtered "B" current right from the light socket.

Sterling Model RT-81 has an output at 35 mills of 135 volts. Detector and Medium voltages are each adjustable and the high tap takes care of the Power tube on most sets. This assures plenty of voltage and exact power regulation for your particular set. RT-81 is no larger than one dry "B" battery, and fits right into the console cabinet or into Radiolas 25 & 28.



RT-81

Another Popular Sterling Model for Larger Sets, R-98 "B-C" Power Unit

A "Universal" "B-C" model for high class sets. Output at 35 mills, is 180 volts. Has four "B" terminals, two of which are independently variable. All four voltages are variable through primary control. Variable High "C" voltage. On and Off switch. Uses Raytheon B or B H Tube. List price; without Tube, \$33.50.

USE MADISON ULTRAFORMERS

(Designed by R. E. Lacault)

In the New Strobodine

\$4.00 each

(subject to regular trade discount)

Type B Ultraformers have a primary of 200 turns and a secondary of 400 turns.

MADE AS SPECIFIED for the STROBODINE

according to specifications on page 134 of the August issue of RADIO NEWS.

Send for catalog

MADISON RADIO CORP.
35-37 West 31st Street
New York, N. Y.



RADIO WHOLESALE

Write for my Big 1928 Radio Catalog—just off the press. Thousands of marvelous bargains in nationally advertised goods. All the LATEST IN RADIOS and equipment. Lowest wholesale prices.

FREE Agents Wanted.

It's a regular encyclopedia on Radio. All about trouble finding. **FREE Log and Call Book** and Catalog. Get your copy today. Send postcard now!

American Auto & Radio Mfg. Co.
HARRY SCHWARTZBERG, PRES.
Dept. 103 American Radio Bldg., Kansas City, Mo. 3

DEALERS NEW 1928 CATALOG

Sterling

"B" POWER UNITS

THE STERLING MFG. CO.
2831 Prospect Avenue - Cleveland, Ohio

DESIGNED FOR USE WITH **Raytheon** TYPE BH LONG LIFE RECTIFYING TUBE

FRENCH HUMOR Arrives in America



FRENCH HUMOR

Food for Thought

COLONEL PASTORELLI, who became illustrious during the Italian-Turkish War, belonged to the guard of honor. For this reason he wore an eagle in his cap.

One day he had a violent altercation with a colonel of the infantry about a plan which the former was elaborating.

"The eagle which you wear on your head has eaten your brain," exclaimed the exasperated colonel of the infantry.

Then, Colonel Pastorelli answered very calmly:

"That's lucky for him. If the eagle were on your head, he would have starved to death."

Nothing to Worry About

ONE day a learned doctor told his patient that he had to submit to a very serious operation.

"Is it dangerous?" inquired the patient.

"Not for the patient, as we put him to sleep. But it is a very painful operation for the doctor."

"How's that?"

"We suffer from anxiety. Just think! It succeeds only once out of a hundred times."

THE BIG SHOT



*-J'ai cue un lièvre!
-Et tu ne l'as pas tué?
-Il était trop petit.
-Pour le tuer?
-Non pour le toucher!*

*"I saw a hare!"
"And you didn't kill it?"
"It was too small."
"To kill it?"
"No, to hit it!"*

THE ONLY OBJECTION



*-Et le mariage? Vous aimez le mariage?
-Bien sûr, j'aime le mariage, mais c'est le mari qui me gêne.*

*"And what do you think of marriage? Do you like it?"
"Of course, I think it's great! But it's the husband that annoys me."*

When Modesty is Great

THE great Italian composer, Verdi, was extremely modest. He hated the indigest, and fled precipitously from those who wished to interview him.

One day a reporter asked him what were the most important happenings in his life.

Verdi thought it over for a moment, and then answered gently:

"The most notorious event in my life was my birth, in 1813. Since then nothing has happened which deserves to be called important."

ISN'T IT THE LIMIT?



*-Qu'est-ce que c'est que ce portrait de femme-là?
-C'est une femme que j'ai connue autrefois.
-Alors, c'est ça, tu me trompais déjà avant de me connaître!*

*"What's this woman's picture doing here?"
"That's a girl I used to know."
"So, that's it! You were untrue to me even before you met me!"*

Bravery

THE old maid—"Oh! That was a wonderful charity bazaar we had, and I had such a good time. Can you imagine, the Mayor gave me five dollars for one kiss!"

The young maid—"The Mayor is a very courageous man. He does everything for charity."

FRANCE sends its matchless wit and humor to every American Home

FRANCE, the magic land of humor, wit, and keen, knife-edged "parlay," no woffers humor-loving Americans its choicest, finest humor through the new weekly magazine, "FRENCH HUMOR."

Americans (who have never been in France) invariably hold the opinion that anything French in humor or jokes must be smut with a Capital S. This is, of course, all tommyrot. The average far-famed Gallic with is no more smutty than the average Chicago citizen is a Gun-man.

This new magazine will show America what makes the Frenchman laugh—also that humor is international. It will

foster a better understanding between Americans and Frenchmen as a whole. Illustrated jokes in "FRENCH HUMOR" are printed first in French—and then in the English translation—this will be of great interest and help to those who are studying or who have a smattering of this important world language.

The first copy of "FRENCH HUMOR" will prove what we say—it's the funniest, wittiest and most entertaining magazine you have ever read.

Copies are sold on all newsstands, large size magazines 9x12 inches, profusely illustrated with genuine French illustrations.

EXPERIMENTER PUBLISHING CO., Inc.,
230 Fifth Ave. New York

10c WEEKLY
ON ALL NEWSSTANDS

Radio and Our Spoken Language

(Continued from page 208)

Accordingly the forecast that radio would bring about an improvement in popular pronunciation and grammatical usage, chief among the language students' prophecies at the beginning of broadcasting, seems still far from realization. But there is no reason to abandon hope.

Given sufficient repetition of correct examples, even the names of some composers and performers which must now be spelled can be mastered by the average listener; and, whether or not this end so much desired by the purists is attained, radio has at least given us some interesting sidelights on our language as it is spoken.

SHAKESPEARE UP-TO-DATE

"When shall we three meet again—
in thunder, lightning, or in rain?"
"No, for there is too much static then."
—David Ferris Kirby.

THE RADIO FAN'S CREED

If you can keep your head when all about you
The room is filled with squeals, and howls,
and roars;
If you can trust your set, when all about you
Are cursing theirs and blaming it on
yours;
If you can sit and not be tired of sitting,
And waiting do not lose your patience too;
If you can keep a smile upon your visage
When people praise their radios to you;
If you can dream, and not make dreams
your master,
Of that fine set you some day mean to
own;
If you can meet and conquer all your
troubles
And build the radio of perfect tone;
If you can bear to hear the truth you've
spoken
About the stations you have reached each
night
Twisted to suit the whims of all your neigh-
bors,
And not get fery mad and want to fight;
If you can get an ear clear full of static,
And keep your temper sweet, and not get
"het"—
Then you will be a perfect fan, my brother,
A fan that people will not soon forget.
—Velma Louise Ransdell.

A FAULTY CONNECTION



The Listener-In, Melbourne, Australia.

For Your "B" Battery Eliminator Ask Your Dealer for Guaranteed

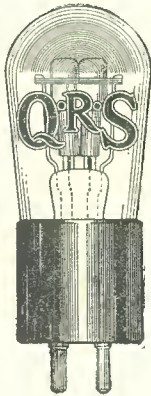

Q·R·S
Trade Mark
Registered

Gaseous Rectifier Tubes

Are Better

60 MILLIAMPERES

\$4⁵⁰

85 MILLIAMPERES

\$4⁵⁰

400 MILLIAMPERES

With Ionizer 300 Volts
for A, B and C Eliminators
with Charts and Diagrams

\$7⁰⁰

Manufactured by **The Q·R·S Company** CHICAGO
MUSIC

Established 1900. References: Dun, Bradstreet or any bank anywhere.



FRED W. STEIN
Designer of Famous
Steinite Circuit.

Steinite ELECTRIC RADIO RECEPTION

Don't confuse the Steinite with Power Units that operate independently and merely attach to light socket to eliminate batteries. *Steinite uses no batteries—no chargers—no chemicals—is one complete synchronized unit.*



1c An Hour To Operate THE HIGHBOY

With Built-in Speaker



\$125 Built-in Speaker

Highly selective; distance, loud and clear. All cabinets solid Philippine Mahogany, beautifully finished dark Brown Two-Tone Duo. Attach to any lighting circuit (60 cycle a.c. 95 to 125 v.) Use new Q.R.S. Rectifier Tube. Guaranteed against all electrical or mechanical defects. 2-dial control uses new Q.R.S. Tubes. Prices do not include tube.

STEINITE LABORATORIES

Gen'l Sales Office:
506 So. Wabash, Chicago, Ill.
Largest Exclusive Radio Factory in the West

Faithfully reproduces all voices and every musical instrument with fidelity of tone. Not merely designed to eliminate battery annoyance and expense—these Steinite Models are built to use power that batteries can not supply. Hear the Tone Test and you will be convinced. Any Steinite Dealer will gladly answer every question asked about these new Steinite Electric Models. Licensed by RCA for certain purposes only.

\$150

In One
Complete
Synchronized
Unit

Jobbers!
Write for Terms and
Territory on these
popular Steinite
Models
Dealers
Write your Jobbers
Factory at Atchison,
Kans.

\$100 TABLE
MODEL



Use any speaker

For Perfect Amplification— FERRANTI



Audio Frequency Transformers Amplify faithfully every note in the scale—each transformer tested ten times—your set needs one for perfect reproduction. Model A.F. 3 —\$12.00. Model A.F. 4—\$8.50.

FERRANTI, INC.
130 West 42nd St., New York, N.Y.



SET BUILDERS—DEALERS
Get this Bargain Sheet
It enables you to buy high grade, nationally advertised kits, transformers, condensers, and parts at less than factory cost. Most prices are equal to 60% and 75% discounts. We sell you C. O. D. direct by mail ONLY—no references required.
HENRY WEBER
6742 N. Maplewood Ave., Chicago, Ill.

RADIO DEALERS' CATALOG—FREE!

A most complete catalog of everything in Radio. All the latest hook-ups, Sets, Parts and Kits of every description. Live Dealers need this book. Write on your business stationery.

COLUMBIA RADIO CORP.
711 W. Lake St., Dept. 248, Chicago, Ill.

Cooper

RADIO BATTERIES
THE COOPER CORP., Cincinnati, O.

OPPORTUNITY AD-LETS

Follow these advertisements every month. Reliable advertisers from all over the country offer their most attractive specials in these columns.

Classified advertising rate twenty-two cents a word for each insertion. Ten per cent discount for 6 issues. 20 per cent discount for 12 issues. Name and address must be included at the above rate. Cash should accompany all classified advertisements unless placed by an accredited advertising agency. No advertisement for less than 10 words accepted.

Objectional or misleading advertisements not accepted. Advertisements for the November issue must reach us not later than September 1st.

Circulation Larger Than That of Any Other Radio Publication

EXPERIMENTER PUBLISHING CO., INC., 230 Fifth Avenue, New York, N. Y.

Agents Wanted

Big Money and fast sales. Every owner buys gold initials for his auto. You charge \$1.50; make \$1.35. Ten orders daily easy. Write for particulars and free samples. American Monogram Co., Dept. 133, East Orange, N. J.

Guaranteed Genuine Gold Leaf Letters anyone can put on store windows. Large profits, enormous demand. Free samples. Metallic Letter Co., 422 N. Clark, Chicago.

Radio Agents—Make Big Money—Easy! selling Marvellous New Sets and accessories. Buy from factory at lowest prices. Get Big New Catalog with thousands of nationally advertised bargains. FREE Call Book. Write today. American Auto and Radio Co., Dept. 108, Radio Bldg., Kansas City, Mo.

Business Opportunities

Free Book. Start little Mail Order Business. Pier Company, 72AF Cortland Street, N. Y.

Inventions Commercialized. Patented or Unpatented. Write Adam Fisher Mfg. Co., 278 Enright, St. Louis, Mo.

Co-operative membership in EIA RADIO is establishing one honest, industrious man of each locality in his own successful radio industry. Young married men preferred. Write, naming your county. Equitable Industries Association, Radio Division, 350-R Broadway, New York.

Chemistry

Learn Chemistry at Home. Dr. T. O'Connor Sloane, noted educator and scientific authority, will teach you. Our home study correspondence course fits you to take a position as chemist. See our full page ad on page 265 of this issue. Chemical Institute of New York, 66R-W. Broadway, New York City.

Correspondence Courses

Used correspondence school courses sold on repurchase basis. Also rented and exchanged. Money-back guarantee. Catalog free. (Courses bought). Lee Mountain, Pisgah, Alabama.

For Inventors

Inventions Commercialized. Patented or Unpatented. Write Adam Fisher Mfg. Co., 278 Enright, St. Louis, Mo.

Help Wanted

Earn \$25 weekly, spare time, writing for newspapers, magazines. Experience unnecessary. Details FREE. Press Syndicate, 973, St. Louis, Mo.

Detectives Needed Everywhere... Travel. Experience unnecessary. Particulars free. Write, American Detective System, 2190 Broadway, N. Y.

We want men and women who have distributed free samples and advertising matter. New Offer. Steady Work. Good Pay. Write immediately. American Products Co., 9370 Monmouth, Cincinnati, O.

Instruction

Learn Chemistry at Home. Dr. T. O'Connor Sloane, noted educator and scientific authority, will teach you. Our home study correspondence course fits you to take a position as chemist. See our full page ad on page 265 of this issue. Chemical Institute of New York, 66R-W. Broadway, New York City.

Double Entry Bookkeeping mastered in 60 hours with 8 Keys; guaranteed; diplomas. International Bookkeeping Institute, Dept. 28, Springfield, Mo.

Miscellaneous

Inventions Commercialized. Patented or Unpatented. Write Adam Fisher Mfg. Co., 278 Enright, St. Louis, Mo.

Multigraph typewritten letters sell anything. Two dollars thousand. Meyer Rey Corporation, Monmouth, Illinois.

Forms to Cast Lead Soldiers, Indians, Marines, Trappers, Animals, 151 kinds. Send 10c for illustrated Catalogue. H. C. Schiercke, 1034 72nd St., Brooklyn, N. Y.

Old Money Wanted

\$2 to \$500 each paid for hundreds of Old or Odd Coins. Keep all old money, it may be very valuable. Send 10c for New Illustrated Coin Value Book, 488. Guaranteed prices. Get posted. We pay Cash. Clarke Coin Company, 14 Street, LeRoy, N. Y.

Patent Attorneys

Patents—Send for form "Evidence of Conception" to be signed and witnessed. Form, fee schedule, information free. Lancaster and Allwine, Registered Patent Attorneys in United States and Canada, 269 Ouray Bldg., Washington, D. C.

Patents. Send drawing or model of your invention for examination and instructions. Advice and booklet free. Highest references. Best results. Promptness assured. Watson E. Coleman, Patent Lawyer, 724 9th Street, N.W., Washington, D. C.

Inventors—Should write for our Guide Book, "How to Obtain a Patent" and Record of Invention Blank, sent free. Send model or sketch of inventions for our inspection and instructions free. Radio, Electrical, Chemical, Mechanical and Trademark Experts. Terms Reasonable. Victor J. Evans & Co., 922 Ninth, Washington, D. C.

Patent applications filed for inventors. New financial plan. Inventors' Service Bureau, Box 1648, Washington, D. C.

Patents

Inventions Commercialized. Patented or unpatented. Write Adam Fisher Mfg. Co., 278 Enright, St. Louis, Mo.

Patent Sense—Valuable book free. See Lacey's ad page 276. Lacey & Lacey, 631 F. St., Washington, D. C. Established 1869.

Printing Outfits and Supplies

Print your own cards, stationary, circulars, paper, etc. Complete outfits \$8.85; Job Presses \$11, \$29; Rotary \$149. Print for others, big profit. All easy, rules sent. Write for catalog presses, type, paper, etc. Kelsey Company, P-13, Meriden, Conn.

Radio

Boys! Don't Overlook This. The "Rasco" Baby Detector. Greatest detector ever brought out with moulded base. Fully adjustable. See former advertisements in this publication, or our catalog. Detector with Galena Crystal, complete 50c, the same detector with Radiocite Crystal, 75c prepaid. Send for yours today. Radio Specialty Company, 96-98 Park Place, New York City.

Attention—50 vacuum tube hook-ups. The greatest collection of vacuum tube circuits ever brought under two covers at such insignificant cost. These diagrams will be found in the great "Rasco" catalog, which contains raw materials and parts in a greater profusion than any other catalog. Send for free catalog. Radio Specialty Co., 96-98 Park Place, New York.

Radio (continued)

Eliminator Transformers 420V.—6v. from 110v. \$1.00, 550v. from 110v. \$3.50. Write for lists. Radio Parts Sales Co., Orange, N. J.

Sell Amateur Transmitters, receivers. Orville Crossland, Jefferson, Kansas.

Be the licensed Radio Doctor of your community. \$7-\$10 spare time evenings. Our co-operative plan procures all the work you want. Secure franchised territory now. Write for booklet. Co-Operative Radio Doctors, 131 Essex St., Salem, Mass.

Salesmen Wanted

66 Miles on 1 Gallon—Amazing new moisture gas saver. All autos. 1 Free. Crittlow, E-88, Wheaton, Ill.

Scenery to Rent

World's Most Beautiful settings for operas, plays, minstrels. Amelia Grain, Philadelphia.

Song Poems

Song Poem Writers—Address Hibbler, D7X, 2104 N. Keystone Ave., Chicago.

Real Composer Wants Good Song Poems At Once. Cora Broadwell, Spirit Lake, Iowa.

Song Writers

Song-Poem writers. Address Monarch, 236 W. 55th St., Dept. 122, New York.

Telegraphy

Telegraphy—Both Morse and Wireless taught thoroughly. Big salaries. Wonderful opportunities. Expenses low, chance to earn part. School established fifty years. Catalog free. Dodge's Institute, Cour St., Valparaiso, Ind.

Wanted to Buy

Full Value Paid for Old Gold, Jewelry, Watches, Diamonds, crowns, bridges, dental gold, silver, platinum, gold or silver ore; magneto points, old false teeth. Packages returned if our offer is not satisfactory. United States Smelting Works (The Old Reliable), 39 So. State St., Dept. 16, Chicago, Ill.

What is a COOKOO-NUT?

A COOKOO-NUT is a new wrinkle to pass away your time. Far more interesting, more entertaining and more humorous than a cross-word puzzle. The COOKOO-NUT illustrates an ordinary well known saying in a distinctly new manner. Study the examples. The test of a COOKOO-NUT is that *there must be no question as to the correctness of the description.* The quotation must absolutely fit the COOKOO-NUT, otherwise it does not go. Cover up the captions of the COOKOO-NUTS on this page, and make your friends guess what each COOKOO-NUT stands for.

An exciting new game is to play COOKOO-NUTS at parties where everyone is asked to make up an original COOKOO-NUT. The most mirth provoking one gets the party prize.

The best COOKOO-NUT printed in FRENCH HUMOR beginning with issue of August 13th, gets a weekly prize of \$5.00.

HERE'S A SAMPLE



Capitalize your talent for

COOKOO-NUTS — See "FRENCH HUMOR" WEEKLY

10c at all Newsstands

Experimenter Pub. Co.

INCORPORATED
230-5th Ave. New York, N.Y.

HERE'S ANOTHER

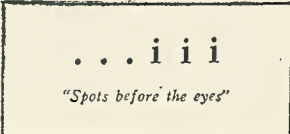

Book Review

THE AMSCO RESISTOR HANDBOOK, by Zeh Bouck. Published by Amsco Products, Inc., New York, N. Y. 6 x 9 inches, 24 pages, paper covers. Price, \$25.

The importance of reliable resistors in radio reception has stimulated several manufacturers to the publication of booklets on the uses of these important units. The latest of these is "The Amsco Resistor Handbook," which covers the characteristics of resistors in general and the metaloid type in particular.

"The Amsco Resistor Handbook" has been prepared for the manufacturer by Zeh Bouck, and contains a wealth of interesting and instructive information. An endeavor has been made to tabulate the various data relevant to "B" and "C" power-supply design in form readily applicable to the requirements of the amateur designer. Progressive tables have been prepared which enable the builder of a socket-power unit to calculate the approximate current which his receiver will draw from the line power device, the output voltage under this load, the resistance of the various resistors required to drop this maximum voltage to the optimum potentials of the various tubes (R.F., detector, etc.) and lastly, the wattage dissipation requirements of the chosen resistors.

Other uses of resistors, such as in stabilization of R.F. amplifiers and in resistance-coupled A.F. amplifiers, are described in detail. The booklet contains constructional and operating data on a resistance-coupled amplifier designed for use with the new high-mu tubes.

Particular attention has been directed to the desirability of "C" power supply; and directions have been given for adding this feature to any standard "B" power-unit.

THE MUSICIAN'S PALETTE, published by the New York Edison Company, New York City. 6 x 9 inches, paper covers. Cost free.

"The Musician's Palette" is the title of a series of musical programs broadcast from station WRNY during the Edison Hour, between the dates of June 21 and August 23 of this year. This tastefully prepared booklet, of the same name, contains the full details of each hour's entertainment, and has been distributed in large quantities among radio listeners by the New York Edison Company. By the time this number of RADIO NEWS appears the series will be practically completed; but we are bringing the booklet to the attention of our readers because of the interesting data on music and musical instruments that it contains.

All of the instruments of the modern symphony orchestra were presented in the programs, with explanations of how they are used to produce the combined effect which makes orchestral music so colorful. In the booklet these explanations are given in printed form, and can be read and understood by one who has no technical knowledge whatsoever of music. They are clearly written, and even a casual perusal of them will enable the radio listener to appreciate the features and characteristics that identify different instruments. The pages on the violin, viola, violoncello and double bass, for instance, brief as they are, cast much light on the essential differences between these instruments, whose resemblance to each other confuses people without musical training.

The booklet starts with a brief history of the orchestra, telling of its development from a luxury of princes to its eventual widespread enjoyment by rich and poor alike. Then follow pages on the violin and viola, cello and double-bass, oboe and English horn, flute and piccolo, clarinet and bass clarinet, bassoon, French horn, trumpet, trombone, and percussion instruments. If you enjoy good music and would like to learn a little about it, without delving into deeply technical works full of incomprehensible Latin terms, here is some light and painless reading for you. Copies cost nothing; simply write to the New York Edison Company and you can get one for the asking.

WAITING FOR TELEVISION

"One reason why the habit of attending church by radio is not apt to become popular with certain persons," says a keen observer, "is that other people will not be able to see their new hats."—David Perry Kirby.

POOR RECEPTION

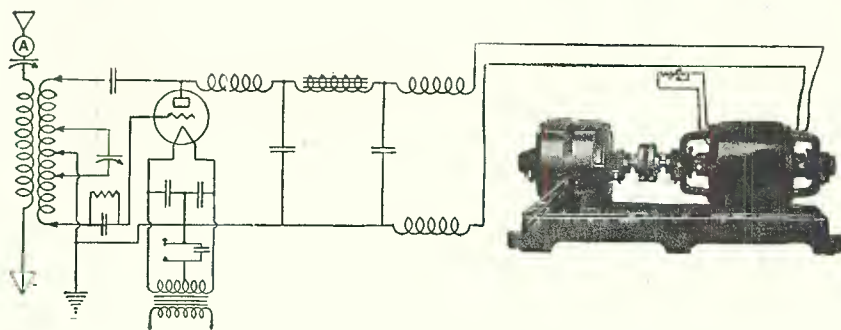
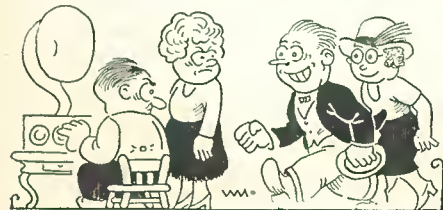

This is Item #26 used as a Plate Power Supply for a 204-A Tube.

Bulletin 237 lists over 300 other Generators, Motor-Generators and Dynamotors for Radio purpose. If you haven't your copy, write for it today!

ELECTRIC SPECIALTY COMPANY

Mark "ESCO" Trade

211 South Street

Stamford, Conn., U. S. A.

Manufacturers of Motors, Generators, Motor-Generators
Dynamotors and Rotary Converters, for Radio and Other Purposes

\$75.00 A WEEK
BUILDING RADIO SETS
— in your spare time

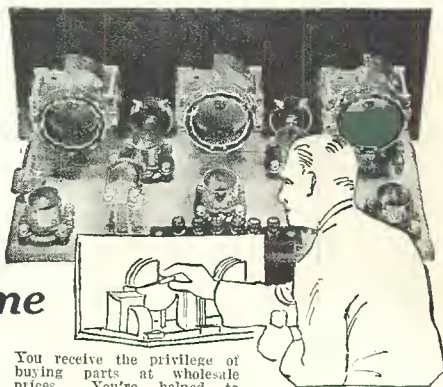

Join the Radio Association of America. Learn how to build and repair radio sets. The Association will train you—start you out in business if you wish. Be the radio "doctor" of your community. \$3 an hour upwards easily made. Radio offers you a big money-making opportunity right now.

EARN \$500 IN SPARE HOURS

"I have at last found myself," writes Lyle Follick, Lansing, Michigan, "I have already made over \$500 building radio sets after working hours." Werner Eichler, Rochester, N. Y., writes, "I have made over \$50 a week in my spare time."

Our members are starting radio stores, increasing their salaries, securing better positions, earning big money for the most enjoyable kind of spare-time work.

WHAT A MEMBERSHIP MEANS

A membership in the Radio Association of America enables you to get into Radio and make money from the start. You're taught how to build and repair all kinds of sets.

You receive the privilege of buying parts at wholesale prices. You're helped to make money.

JOIN THE ASSOCIATION NOW

If you're interested in Radio for either pleasure or profit, join the Association without delay, because we have a plan whereby your membership may not—need not—cost you a cent. Only a limited number of these memberships are acceptable. Write now for details. Write before it's too late.

This Association has prepared a beautiful book that gives figure-facts regarding the profit possibilities of the Radio Industry, the purpose of the Association, and the details of the Special Membership Plan.

MAIL THIS COUPON

RADIO ASSOCIATION OF AMERICA
Dept. RN-9—4513 Ravenswood Ave., Chicago.
Send me your book and details of your Special Membership Plan.
Name
Address
City State.....



NA-ALD

UX POWER TUBES installed in any set without rewiring by Na-Ald Adapters and Connectorals. For full information write Alden Manufacturing Co., Dept. K-32, Springfield, Mass.

METRODYNE RADIOS 1928 MODELS

Completely assembled 6 and 7 tube sets, equipped for battery or electric operation. Also a wonderful line of 100% electric sets. Don't buy any radio until you get our 30 days' free trial offer. Write today!

METRO ELECTRIC CO.
2161 N. California Ave. Dept. D. CHICAGO, ILL.

ADMIRALTY SUPER-10 HIGHEST CLASS RECEIVER IN THE WORLD

Write for Information
NORDEN-HAUCK, Inc.
Engineers

Marine Building Philadelphia, Pa.

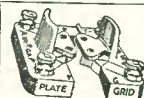

**The AIRGAP
SOCKET**
"It gets that last mile"

The Improvement Airgaps make will surprise you. At Dealer, or direct postpaid 60c each
AIRGAP PRODUCTS CO.
56 Clinton Street Newark, N. J.

Insure your copy reaching you each month. Subscribe to Radio News—\$2.50 a year. Experimenter Publishing Co., 230 Fifth Avenue, N. Y. C.

EASY TO INSTALL
 No climbing on slippery, dizzy roof tops, no dangerous work to put up. Just dig a hole in the ground. A small hole in the ground. HURRY SUBANTENNA in a few minutes. Never again needs attention. Never gets torn down by wind or storm like an aerial does.

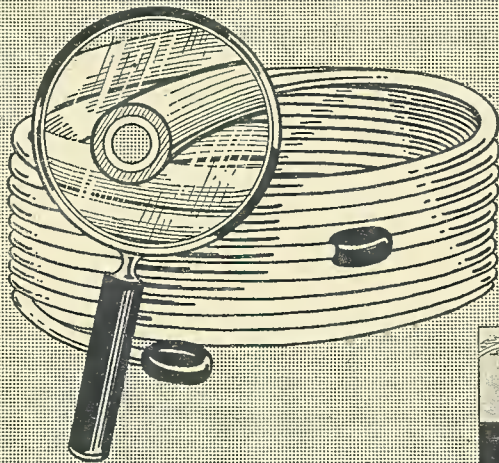

This graph-picture tells the greatest radio story ever told. Send coupon for the complete explanation of the difference between noisy air waves and static-free ground waves.

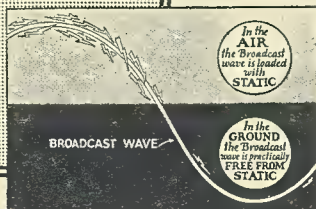

Oh—the joy of Radio with a SUBANTENNA

“I get plenty of stations with my Subantenna, on the loud speaker, that I have never been able to reach with my outside aerial. It absolutely cuts down interference to the minimum, cuts static out, too —not just partly out—but ALL out”

H. S. M., North Carolina

And besides that he gets stations with his Subantenna that he never could coax out of the air with an aerial! Read what Mr. H. S. M. of North Carolina thinks of Subantenna, in his letter which we have reprinted in brackets at the top of this column. He is just one of many thousands of fans who are enjoying clearer, louder, better long distance radio reception since discarding the unsightly, static-collecting, up-in-the-air type of aerial, and using in its stead, Subantenna, the new underground antenna.

Every Night a Good Radio Night —Now an Actuality

Gone is the time when the first warm day is the signal for pushing the radio back in the corner until cold weather comes again. A thing of the past is the disappointment of having an evening's radio fun spoiled by an unexpected storm or attack of static. Install a Subantenna and your radio will be as dependable as the sunrise. On any night, in any season, in any weather you can get real “distance,” enjoyable clarity and bigger usable volume than you ever could before—all you need is a Subantenna.

What Scientists Found Out

For years the heads of great laboratories have been trying to perfect a means of tun-

ing static out of radio impulses received from the air. And all this time they knew not only that the same radio wave which travelled thru the air also travelled thru the ground, but that the ground is practically free from static! Knowing this, a group of inventors set out to develop a device by which the radio wave could be satisfactorily picked up from the ground. Result! Subantenna—already tested and proved by thousands of users—and offered to YOU to test on an unconditional, unqualified guarantee basis. Read herewith, a few more of the voluntary letters of praise which Subantenna users have sent in. Then get the whole explanation of Subantenna—why the ground is almost static-free—why Subantenna increases the distance-getting capabilities of practically any set—why it increases volume and improves selectivity. Get this information from your dealer, or mail the coupon from this announcement for booklet and our free trial offer. Now, read:

Says its WONDERFUL!

“After 4 years of testing aerials I at last found the master in the Subantenna. The first night I used it was a very hot summer night. Static was very bad on my outdoor aerial. I connected my Subantenna and one could hardly believe the results. It was wonderful.”—F. L. C., Mass.

Works Fine with “B” Eliminator

“We have the Subantenna installed and it is all you claim it to be. It works fine and

we enjoy it very much. We also have a B Battery Eliminator and the two together work fine. We would not want to go back on the high-in-the-air aerial again as we get so much better reception on Subantenna.”—A. J. L., Maine.

SURPRISED!

“I received the Subantenna and installed it the same night and believe me I was surprised with the result for I was quite suspicious about it. I am well satisfied.”—R. E. G., Canada.

FREE TRIAL

Make This Convincing Test

Install SUBANTENNA. Leave your old aerial up. Select a bad night when DX is almost impossible with the ordinary aerial. Make a comparison station for station connecting first your aerial, then SUBANTENNA. If, from stations that are just a mess of jumbled noise with the old aerial, you don't get reception that rivals local in sweetness and clarity the instant you switch to SUBANTENNA, this test won't cost you even a single penny. Obtain a SUBANTENNA from your dealer or send coupon at once for scientific explanation of SUBANTENNA and for particulars of GUARANTEE and FREE TRIAL OFFER. SEND COUPON NOW!

SUBANTENNA

The New Underground Antenna

Made by CLOVERLEAF MANUFACTURING CO.

2717-M CANAL STREET

CHICAGO, ILLINOIS

CLIP AND MAIL AT ONCE

CLOVERLEAF MFG. CO.,
 2717-M Canal Street, Chicago, Illinois
 Tell me all about SUBANTENNA, your unqualified, unconditional guarantee and your FREE TRIAL OFFER.

Name.....

Address.....



Tireless Performance

These gulls fly and fly until we wonder *how* such stamina can be contained in so frail an object.

Just so with CeCo Tubes. A strong combination of frail materials. Glass for a covering; hair-like wires for filament; fine spun metal for grid.

But so carefully engineered, so cleverly assembled, so skillfully exhausted, so thoroughly tested that their durability is astounding to the radio operator and fan who judges CeCo performance by ordinary standards.

You expect *MORE* of CeCo Tubes—and *get more*.

A Type for Every Radio Need

General Purpose Tubes, Special Purpose Tubes, Power Tubes, Filament Type Rectifiers, Gas Filled Rectifiers.

Ask your radio dealer for complete data sheet of CeCo Tubes.

C. E. Mfg. Co., Inc., Providence, R. I.



Announcing Our New Gas Filled Rectifier (NO FILAMENT) TYPE D - G

Maximum Volts—300 Maximum Cur.—85 M-A

Long Life without decrease in output is assured if these values are not exceeded.

Easy Filtration. Less strain on Filter condensers and smoother output with less Hum or Ripple.

These tubes are tested in a Standard rectifying circuit using well designed parts. The unit is connected to a ripple test position, and tube checked both by phones and observed on an oscillograph, insuring a perfect tube which will give excellent results in *well designed and constructed units.*

PRICE \$5.00

Makes a Good "B" Eliminator—BETTER



Write for Data Sheet giving characteristics of all CeCo Tubes

**30
DAYS
FREE
TRIAL**

7 Tube Set

Single Dial Radio



**Metrodyne
Radio Sets**
Are Equipped
For
**BATTERY or
ELECTRIC**
operation

The **Metrodyne**
ONLY ONE DIAL TO TUNE

RETAIL PRICE
\$75⁰⁰
Completely Assembled
Big Discounts to
Agents and Dealers

Wonderful offer direct from the factory! The world's greatest radio! A perfect working, single dial control, 7 tube receiver! And just to prove our claims, we will ship it to your home for **30 days' free trial**. Test it under all conditions. Test it for distance, volume and tonal quality—and if you are not convinced that it is the best single dial set you ever heard, return it to the factory. We don't want your money unless you are completely satisfied.

Three Year Guarantee

**BIG PROFITS
TO AGENTS AND DEALERS**
Our Agents and Dealers make big money selling Metrodyne Sets. You can work all or part time. Demonstrate the superiority of Metrodynes right in your home. Metrodyne Radios have no competition. Lowest wholesale prices. Demonstrating set on 30 days' free trial. Greatest money-making opportunity. Send coupon, a letter or a postal for our agent's proposition.

Metrodyne Super-Seven Radio

A single dial control, 7 tube, tuned radio frequency set. Tested and approved by Popular Science Institute of Standards, Popular Radio Laboratory, Radio News Laboratory and by America's leading Radio Engineers. Designed and built by radio experts. Only the highest quality low loss parts are used. Magnificent, two-tone walnut cabinet with beautiful, gilt metal trimmings. Very newest 1928 model, embodying all the latest refinements.

Easiest set to operate. Only one small knob tunes in all stations. The dial is electrically lighted so that you can log stations in the dark. The volume control regulates the reception from a faint whisper to thunderous volume, **1,000 to 3,000 miles on loud speaker!** The Metrodyne Super-Seven is a beautiful and efficient receiver, and we are so sure that you will be delighted with it, that we make this liberal **30 days' free trial offer**. You to be the judge.

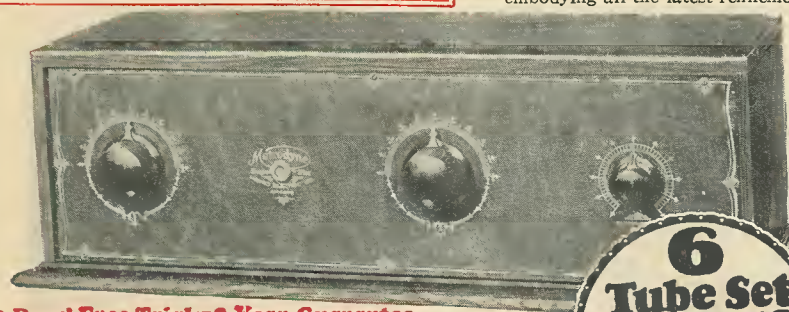

30 Days' Free Trial—3 Year Guarantee

Metrodyne Super-Six

Another triumph in radio. Here's the new 1928 model Metrodyne 6 tube, two dial, long distance tuned radio frequency receiving set. Approved by leading radio engineers of America. Highest grade low loss parts, completely assembled in a beautiful walnut cabinet. Easy to operate. Dials easily logged. Tune in your favorite station on same dial readings every time—no guessing.

Mr. Howard, of Chicago, said: "While five Chicago broadcasting stations were on the air I tuned in seventeen out-of-town stations, including New York and San Francisco, on my loud speaker horn, very loud and clear, as though they were all in Chicago."

We are one of the pioneers of radio. The success of Metrodyne sets is due to our liberal 30 days' free trial offer, which gives you the opportunity of trying before buying. Thousands of Metrodynes have been bought on our liberal free trial basis.

**6
Tube Set**
\$48⁵⁰
RETAIL PRICE
Completely
Assembled

**MAIL THIS
COUPON**
or send a postal or letter. Get our
proposition before buying a radio.
Deal direct with manufacturer—
SAVE MONEY—WRITE NOW!

MAIL COUPON BELOW

Let us send you proof of Metrodyne quality—our **30 days' free trial offer and 3 year guarantee**

Mrs. Wm. Leffingwell, Westfield, N. J., writes: "The Metrodyne Radio I bought of you is a wow! This is as good as any \$225 machine I have ever seen."

N. M. Greene, Maywood, Ill., writes: "My time is up and the Metrodyne works fine. I got Havana, Cuba, Oakland, Calif., Denver, Colo., Toronto, Canada, all on the loud speaker."

J. W. Woods, Leadville, Colo., writes: "Received the 7-tube Metrodyne in fine condition. Had it up and working same day received. Was soon listening to Los Angeles, San Diego, Oakland and other California points; also St. Louis, Kansas City and other east and south stations—all coming in fine. Am more than pleased. Sure enjoying it."

We will send you hundreds of similar letters from owners who acclaim the Metrodyne as the greatest radio set in the world. A postal, letter or the coupon brings complete information, testimonials, wholesale prices, and our liberal **30 days' free trial offer**.

METRO ELECTRIC COMPANY
2161-71 N. California Ave., Dept. 1
Chicago, Illinois

Gentlemen:
Send me full particulars about Metrodyne 6 tube and 7 tube sets and your **30 days' free trial offer**.

Name _____
Address _____

If you are interested in AGENT'S proposition, place an "X" in the square

METRO ELECTRIC COMPANY
2161-71 N. California Ave. • Dept. 1 • Chicago, Illinois