

TELEVISION

RADIO'S GREATEST MAGAZINE

RADIOVISION

RADIO NEWS

REG. U.S. PAT. OFF.

SEPTEMBER
25 Cents

Over 200
Illustrations



BROADCAST
WRNY
STATION



Edited by HUGO GERNSBACK

Soon!

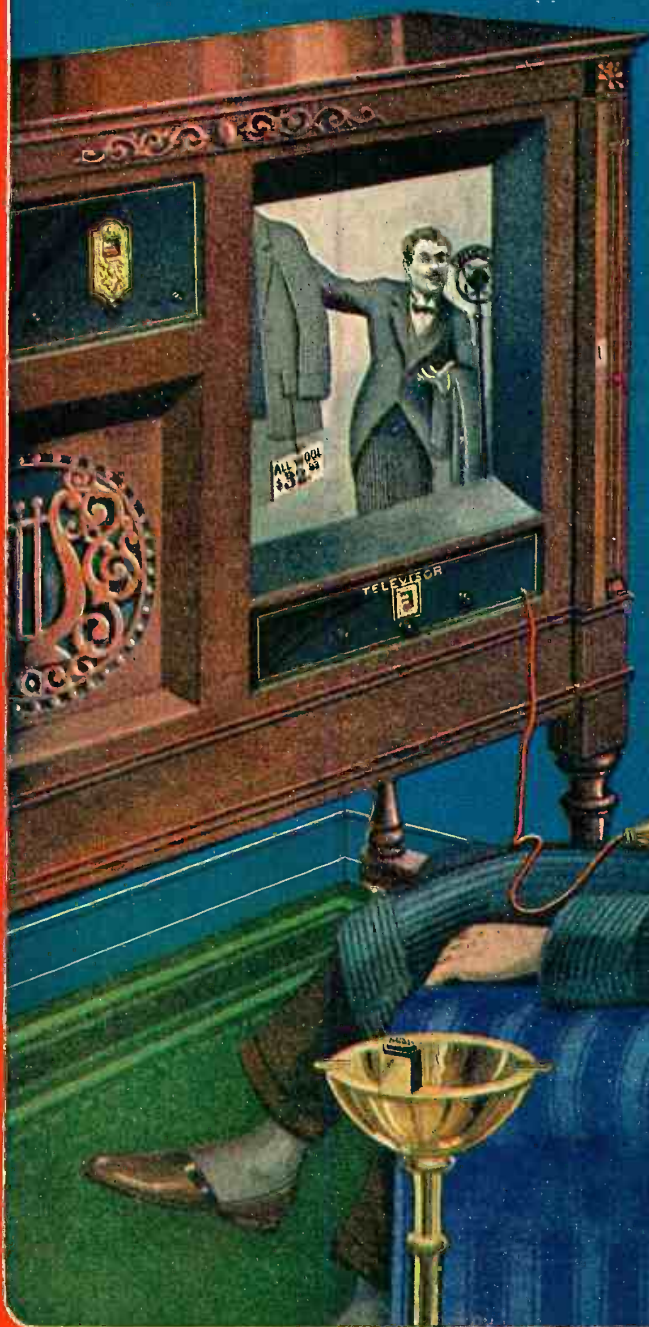

RADIOVISION

TELEVISION

RADIOVISION

TELEVISION

RADIOVISION

TELEVISION

RADIOVISION

TELEVISION

RADIOVISION

TELEVISION

TELEVISION

EXPERIMENTER PUBLISHING COMPANY, 230 FIFTH AVENUE, NEW YORK

RADIOVISION

THESE

2

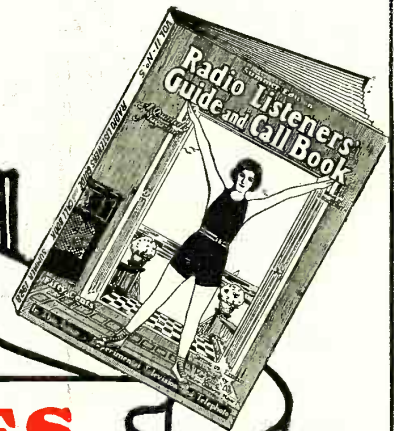

MAGAZINES

for

THE PRICE

OF

1

A year's subscription to these two popular magazines for the price of Radio News—alone. If you were to buy Radio News and Radio Listeners' Guide and Call Book individually for one year they would cost you \$5.00. By our special combination yearly subscription rate you can get both of these foremost radio periodicals at the tremendous bargain price of \$3.00. In order to keep up with the latest developments of Radio, to know the newest sets and how to build them, to find every radio broadcasting station you must read these leading periodicals of radio.

The RADIO LISTENERS' GUIDE AND CALL BOOK is the foremost quarterly magazine in the field. A special feature of this remarkable magazine is the up-to-the-minute log of every station in this country,

Special Combination Yearly Subscription Rate

\$3.00

For the Radio Listeners' Guide and Call Book and Radio News

**EXPERIMENTER PUBLISHING
COMPANY**

230 5th AVE., NEW YORK CITY, N. Y.

Canada and in Europe. This list of call letters is carefully checked and corrected in each quarterly edition.

RADIO NEWS is read each month by more radio enthusiasts than any other publication in the field. It contains the latest developments and the most modern circuits of the radio world. Honest, unbiased opinions on every subject of interest—this is what RADIO NEWS gives you.

Write today—insure your receiving each issue of RADIO LISTENERS' GUIDE and CALL BOOK and RADIO NEWS. Take advantage of this special subscription offer—Two magazines for the price of one.

EXPERIMENTER PUBLISHING COMPANY
230 5th AVE., NEW YORK, N. Y.

Gentlemen:—Enclosed find \$3.00 for which please send me the RADIO LISTENERS' GUIDE and CALL BOOK, and RADIO NEWS for one year beginning with the next issue. It is understood there will be no further payments of any kind.

Name
Address
City
State



EARN \$75⁰⁰ a week — in Your Spare Time

JOINING the Radio Association enables you to cash in on Radio *now!* Follow its success-proven plans and you can earn \$3 an hour, in your spare time, from the very first. Over \$600,000,000 is being spent yearly for sets, supplies, service. You can get your share of this business and, at the same time, fit yourself for the big-pay opportunities in Radio.

Founded on a New Idea

Members of the Association do not wait for months before they make money out of Radio. Without quitting their jobs, our members are earning \$25 to \$75 a week spare time by building "tailored" radio sets, serving as "radio doctors," selling ready built sets and accessories, or following one of the many profit-making plans of the Association.

Earned \$500 in Spare Hours

Hundreds earn \$3 an hour as "radio doctors." Lyle Follick, Lansing, Mich., has already made \$500 in spare time. Werner Eichler, Rochester, N. Y., is earning \$50 a week for spare time. F. J. Buckley, Sedalia, Mo., is earning as much in spare time as he receives from his employer.

We will start you in business. Our cooperative plan gives the ambitious man his opportunity to establish himself. Many have followed this plan and established radio stores. Membership in the Association has increased the salaries of many. Scores are now connected with big radio organizations. Others have prosperous stores.

A year ago Claude De Grave knew nothing about Radio. Today he is on the staff of a famous radio manufacturer and an associate member of the Institute of Radio Engineers. He attributes his success to joining the Association. His income now is 350% more than when he joined.

Doubled Income in Six Months

"I attribute my success entirely to the Radio Association," writes W. E. Thon, Chicago, who was clerk in a hardware store before joining. We helped him secure the managership of a large store at a 220% increased salary.

"In 1922 I was a clerk," writes K. O. Benzing, McGregor, Ia., "when I enrolled. Since then I have built hundreds of sets—from 1-tube Regenerative to Superheterodynes. I am now operating my own store and my income is 200% greater than when I joined the Association. My entire success is due to the splendid help it gave."

Easiest Way Into Radio

If ambitious to become a Radio Engineer, to fit yourself for the \$3,000 to \$10,000 opportunities in Radio, join the Association. It gives you a comprehensive, practical and theoretical training and the benefit of our Employment Service. You earn while you learn. You have the privilege of buying radio supplies at wholesale. You have the Association behind you in carrying out your ambitions.

ACT NOW—if you wish Special Membership Plan

To a limited number of ambitious men, we will give Special Memberships that may not—need not—cost you a cent. To secure one, write today. We will send you details and also our book, "Your Opportunity in the Radio Industry." It will open your eyes to the money-making possibilities of Radio. Write today.

What a Membership Can Do for You

- 1—Enable you to earn \$3 an hour upwards in your spare time.
- 2—Train you to install, repair and build all kinds of sets.
- 3—Start you in business without capital, or finance an invention.
- 4—Train you for the \$3,000 to \$10,000 big-pay radio positions.
- 5—Help secure a better position at bigger pay for you.
- 6—Give you the backing of the Radio Association.

A MEMBERSHIP NEED NOT COST YOU A SINGLE CENT

RADIO ASSOCIATION OF AMERICA,
4513 Ravenswood Ave.,
Chicago, Ill.

Dept. RN-9

Gentlemen:
Please send me by return mail full details of your Special Membership Plan and also copy of your book, "Your Opportunity in the Radio Industry."

Name.....

Address.....

City..... State.....

RADIO NEWS

Volume 10

SEPTEMBER, 1928

Number 3

Contents of This Issue

The Short-Wave Era By Hugo Gernsback	201	The Scanning Disc—Television's Canvas By C. P. Mason	222
Making Radio Easier for Aviators By Allan K. Ross	202	The Standardization of Radio Terms and Abbreviations By Robert Hertzberg	224
Some Problems of A.C. Operation By Charles Magee Adams	204	The Radio Beginner—The Uses and Value of Meters By C. Walter Palmer	226
X-Raying the Radio Set to Show Its Insides	206	How to Build from the Schematic (Part I) By Fred H. Canfield	228
Novel Indoor Aerial Increases Signals By Armstrong Perry	207	Making Serviceable and Efficient Coils By Philip H. Greeley	232
The Listener Speaks By Himself	208	The Screen-Grid Stroboddyne Receiver By R. E. Lacault	235
Broadcastatics	209	Radio Wrinkles	242
List of Broadcast Station Calls	210	Screen-Grid Tubes as A.F. Amplifiers By William H. Fortington	244
A Britisher Chats on Radio By E. Blake	211	Letters from Home Radio Constructors	246
What's New in Radio	212	RADIO NEWS LABORATORIES	248
How Much Amplification for the Best Quality? By C. Sterling Gleason	216	Review of Recent Radio Literature By A. K. Ross	249
Successful Television Accomplished on the Broadcast Band	219	Radiotics	250
Giant Photoelectric Cells for WRNY'S Television Transmitter	221	I Want to Know By C. W. Palmer	251
		On the Short Waves	254
		Television Out of Doors	258

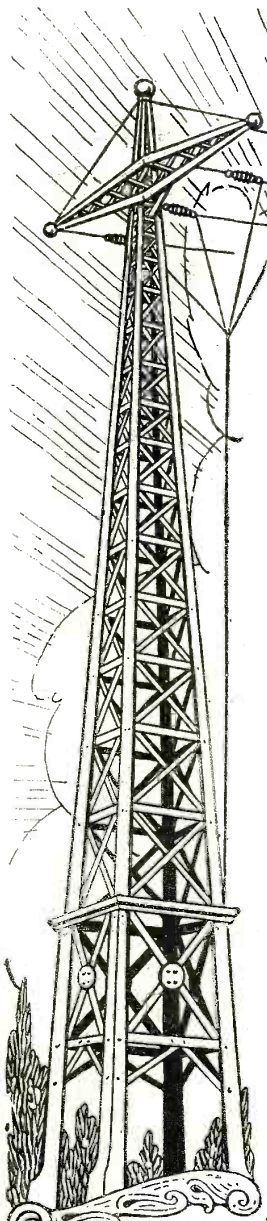

RADIO NEWS is published on the 10th of each preceding month. There are 12 numbers per year. Subscription price is \$2.50 a year in U. S. and possessions. Canada and foreign countries, \$3.00 per year. U. S. Coin as well as U. S. Stamps accepted (no foreign coins or stamps). Single copies, 25 cents each. Checks and money orders should be drawn to order of EXPERIMENTER PUBLISHING CO., INC.

All communications and contributions to this journal should be addressed to Editor, RADIO NEWS, 230 Fifth Ave., New York, N. Y. Unaccepted contributions cannot be returned unless full postage has been included. All accepted contributions are paid for on publication. A special rate is paid for novel experiments; good photographs accompanying them are highly desirable. Publishers are not responsible for loss of manuscripts, although every precaution is taken with such manuscripts, upon receipt thereof.

RADIO NEWS. Monthly. Entered as second-class matter, July 12, 1924, at the Post Office at New York, N. Y., under the Act of March 3, 1879. Additional entry at Dunellen, N. J. and San Francisco, Calif. Title registered U. S. Patent Office, Copyright, 1928, by The Experimenter Publishing Co., Inc., 230 Fifth Ave., New York. The contents of this magazine are copyrighted and must not be reproduced in the United States without giving full credit to the publication. Translation into foreign languages must not be made unless permission is

The contents of RADIO NEWS are indexed in the Industrial Arts Index, copies of which can be found in every library.

obtained from the publishers. Copyrighted in Germany. Reproduction of articles in Germany is reserved for Radio, Berlin 42.

RADIO NEWS is for sale at all newsstands in the United States and Canada, and at Brentano's, Ave. de l'Opera, Paris, France. European agents: S. J. Wise & Co., 40 Place Verre, Antwerp, Belgium.

HOW TO SUBSCRIBE FOR RADIO NEWS. Send your name, address and remittance to Experimenter Publishing Co., 230 Fifth Ave., New York. Mention the name of the magazine you are ordering. We also publish SCIENCE AND INVENTION, RADIO LISTENERS' GUIDE, AMAZING STORIES and TIDBITS. Write clearly.

RATES AND TERMS. The subscription rate for RADIO NEWS is \$2.50 per year. (12 numbers). When remitting do so by check, money order, or registered letter if cash is enclosed. Avoid sending cash through the mail if possible. Subscriptions for less than one year are not accepted. Subscription may be made in combination with SCIENCE & INVENTION, RADIO LISTENERS' GUIDE, AMAZING STORIES and TIDBITS.

POSTAGE. We prepay postage in all parts of the United States, Mexico and island possessions. For foreign or Canadian subscriptions we require 50 cents in addition to the subscription price for additional postage charge.

CHANGE OF ADDRESS. Notify us as far in advance as possible. It requires several weeks to make an address change on our records. Always write clearly.

Published by **Experimenter Publishing Company, Inc.**

H. GERNSBACK, President S. GERNSBACK, Vice-President and Treasurer C. E. ROSENFELT, Secretary

Member: Audit Bureau of Circulations Radio Magazine Publishers Association

Advertising Representatives: RHODES & LEISENRING

New York Offices: 624 Graybar Building Chicago Offices: 307 North Michigan Ave.

Editorial and General Offices 230 Fifth Avenue, New York City

New!

WONDERFUL!
Super-Eight—100% Electric
8 TUBES—SINGLE DIAL
Coast-to-Coast

30 Days Free Trial

[Battery or Electric]

Now comes Metro's latest achievement—the world's greatest electric radio set—a powerful long distance eight tube receiver—clearness of tone that is astounding—ultra-selective—a set that expert radio engineers have pronounced as the ultimate for all around perfection. And to prove our claims, we will send this marvelous set to you direct from our factory on 30 days' free trial. Test it to your heart's content. Compare its quality, beauty and price with any other radio on the market, and decide to keep it only after you are satisfied that the new 1929 Metrodyne super-eight is the peer of them all.

Metrodyne

SUPER-EIGHT ELECTRIC

Save One-Half—Low Price a Big Feature!

You will be amazed at the low price of these wonderful sets, in the console or table cabinet. Our low cost of distribution direct from our factory enables us to save you about half their regular value. Never before in radio history have you been offered such sets at such low prices. And we are so sure of their quality, beauty and performance pleasing you that we do not hesitate to let you try one for 30 days before deciding to keep or return it.

SUPER QUALITY THROUGHOUT!

Eight powerful tubes. Highest quality low loss parts. Illuminated single dial. Positive switch control—simply turn a knob and it's on. Select your stations with accuracy at any desired volume. Beauty of tone that cannot be surpassed. Console and table cabinets are hand-somely grained genuine walnut, hand rubbed, in two-tone effect—artistically carved trimmings. All metal parts finished in two-tone gold. Seeing is believing. You will be the judge.



Georgous console with newest type, built-in sonorous loud speaker that reproduces the entire range of vocal and instrumental music. Amazingly clear and distinct. Low, direct-from-factory price on **30 DAYS' FREE TRIAL!**

AGENTS and DEALERS

The 1929 Super-Eight line offers great money making opportunities. Nothing like them for high quality—nothing near them in price. Let us prove this by shipping you a

Demonstration set on 30 days' free trial

Test it—compare it—demonstrate it to prospective radio buyers. Get our liberal discounts—exclusive territory—newspaper and billboard advertising offer that will help you sell Metrodyne radios quickly.

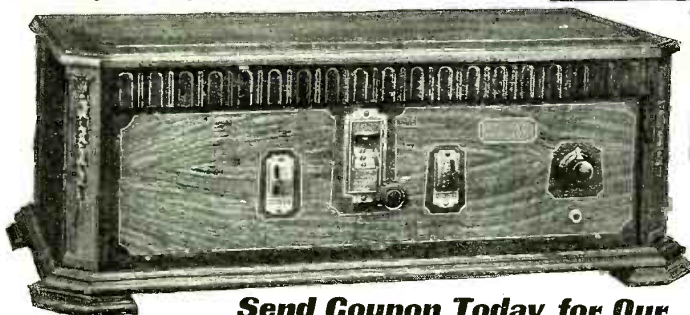

**Send Coupon Today for Our
 30 Days' Free Trial Offer** →

**METRODYNE
 RADIO SETS
 Are Equipped For
 BATTERY or
 ELECTRIC
 OPERATION**

We are one of the pioneers of radio. The success of Metrodyne sets is due to our liberal 30 days' free trial offer, which gives you the opportunity of trying before buying. Thousands of Metrodynes have been bought on our liberal free trial basis. We will send you hundreds of letters from owners who acclaim the Metrodyne as the greatest radio set in the world. A postal, letter or the coupon brings complete information, testimonials, wholesale prices and our liberal 30 days' free trial offer—**WRITE TODAY!**

METRO ELECTRIC COMPANY
 2161-71 N. California Ave., Dept. 10
 Chicago, Illinois

Gentlemen:

Send me full particulars about Metrodyne Super-Eight sets and your 30 days' free trial offer

Name.....

Address.....

If you are interested in AGENT'S proposition, place an "X" in the square →

METRO ELECTRIC COMPANY

2161-71 N. California Ave. • Dept. 10 • Chicago, Illinois

INDEX TO ADVERTISERS

	Page		Page		Page
A					
Abox Company, The	Back Cover	Elkon Works	280	Lafayette Hotel	287
AccustiCone Labs.	272	Exello Products Corp.	280	Leutz, Inc., C. R.	275
Aero Products, Inc.	272	F			
Aerovox Wireless Corp.	264	Fanspeaker Radio Co.	272	Mc	
All Radio Co.	275	Freshman, Inc., Chas.	275	McSweeney Electrical Schools....	287
American Sales Co.	270	G			
American School	287	General Antenna Co.	276	M	
American Transformer Co.	260	General Radio Co.	266	M & H Sporting Goods Co.	287
Amrad Corp., The	259	Gernsbach, S.	274	Massachusetts Radio and Tele- graph School	264
B					
Barawik Co.,		H			
258-264-266-271-275-278-280-283-287		Hamilton-Carr Corp.	280	N	
C					
Carborundum Co., The	264	Hammarlund Mfg. Co.	284	National Company, Inc.	272
Carls, M. J.	271	I			
CeCo Mfg. Co.	263	Independent Electric Works	273	National Electrical School	279
Central Radio Labs.	258	J			
Chemical Institute of N. Y., Inc.	257	J.-M.-P. Mfg. Co., Inc.	258	National Radio Institute.....	197-261
Chicago Radio Apparatus Co.	273	K			
Claroostat Mfg. Co., Inc.	269	Karas Electric Co.	277-287	Norden-Hauck, Inc.	269
Cloverleaf Mfg. Co.,		Kimley Electric Co.	277	P	
Inside Back Cover		Kodel Electric & Mfg. Co.	265	Pathfinder, The	269
Consrad Co., Inc., The		L			
256-258-260-270		Lacey & Lacey	287	Pilot Electric Mfg. Co., Inc.	196
Consumers Radio Co.	275	Lacault, R. E.	267	Press Guild, Inc., The	285
Craftsman Radio Products	279	M			
Cunningham, Inc., E. T.	285	N			
Curtan Mfg. Co.	279	O			
D					
Daven Corp., The	280	P			
Dresner Radio Mfg. Corp.	279	R			
E					
Electrad, Inc.	273-277	S			
Electric Specialty Co.	279	Scott Transformer Co.	283	See Jay Battery Co.	280
F					
G					
H					
I					
J					
K					
L					
M					
N					
O					
P					
R					
S					
T					
U					
V					
W					
X-Y					

PILOT Leadership in Rad'io



"PILOT'S "FLYING LAB"

Airplane radio communication is being aided by Pilot's Airplane (Station 2XBQ) enabling ground stations to inform planes while aloft of weather conditions en route and also to direct pilots "flying blind" in fogs.

PILOT radio parts lead in volume of sales because radio fans all over the world know they can depend upon Pilot for correctness of engineering design and precision workmanship that assure results. Pilot's important contributions to Airplane Radio and Television place this organization in the forefront of progressive manufacturers aiding development work.

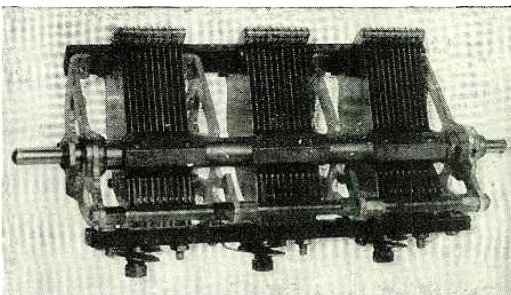

NEW PILOT GANG CONDENSERS

New precision type condenser series for single control tuning. Wide-spaced plate construction, balanced to 1/2% accuracy. Individual compensators take care of distributed capacities. Other features: Universal mounting (Sub-Panel, front panel or both), removable shaft, self-aligning cone bearings, clockwise or anti-clockwise rotation, capacity .00035 mfd. each section, 21 plates. Also made single and double.

RADIO'S BIGGEST
25¢ VALUE!

"RADIO DESIGN," a Quarterly Magazine edited by M. B. Sleeper, national radio authority, is brimming over with the newest and latest Short Wave, A. C. Data, Power Amplification, latest Television Development, etc. Send 25c. stamps or coin for four meaty quarterly issues.

Name

Address

Send 4c. Stamp
for Catalog

PILOT ELECTRIC M'FG. CO

323 BERRY ST. BROOKLYN, N.Y. INC.

TRADE MARK REGISTERED

"WORLD'S LARGEST RADIO PARTS PLANT"

"PILOT RADIO PARTS ARE SOLD IN EVERY CIVILIZED COUNTRY IN THE WORLD!"

Please say you saw it in RADIO NEWS.

I Will Train You at Home to Fill a Big-Pay Radio Job

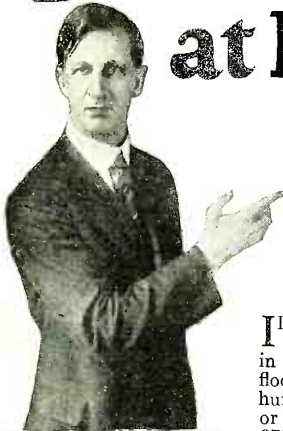

Here's the PROOF

Made \$185 in Three Weeks' Spare Time
I have met with continued success. For instance, recently I realized a profit of \$185 in three weeks for spare time work. I charge \$1.50 an hour. Right now I am making more money in my spare time than I am making in my regular job. I have been making good money almost from the time I enrolled. I am going to give up my present position and open a Radio shop. The N. R. I. has put me on the solid road to success.—Peter J. Dunn, 91 N. Monroe St., Baltimore, Md.

Made \$588 in One Month
The training I received from you has done me a world of good. Some time ago, during one of our busy months, I made \$588. I am servicing all makes of Radio receiving sets. I haven't found anything so far that I could not handle alone. My boss is highly pleased with my work since I have been able to handle our entire output of sets here alone. Herbert Reese, 2215 South E Street, Elwood, Indiana.



Earns Price of Course in One Week's Spare Time
I have been so busy with Radio work that I have not had time to study. The other week in spare time, I earned enough to pay for my course. I have more work than I can do. Recently I made enough money in one month's spare time to pay for a \$375 beautiful console all-electric Radio. When I enrolled I did not know the difference between a rheostat and a coil. Now I am making all kinds of money.—Earle Cummings, 18 Webster Street, Haverhill, Mass.



You can build 100 circuits with the six big outfits of Radio parts I give you

If you are earning a penny less than \$50 a week, I send for my book of information on the opportunities in Radio. It's FREE. Clip the coupon NOW. A flood of gold is pouring into this new business, creating hundreds of big pay jobs. Why go along at \$25, \$30 or \$45 a week when the good jobs in Radio pay \$50, \$75, and up to \$250 a week. My book, "Rich Rewards in Radio," gives full information on these big jobs and explains how you can quickly become a Radio Expert through my easy, practical, home-study training.

SALARIES OF \$50 TO \$250 A WEEK NOT UNUSUAL

Get into this live-wire profession of quick success. Radio needs trained men. The amazing growth of the Radio business has astounded the world. In a few short years three hundred thousand jobs have been created. And the biggest growth of Radio is still to come. That's why salaries of \$50 to \$250 a week are not unusual. Radio simply hasn't got nearly the number of thoroughly trained men it needs. Study Radio and after only a short time land yourself a REAL job with a REAL future.

YOU CAN LEARN QUICKLY AND EASILY IN SPARE TIME

Hundreds of N. R. I. trained men are today making big money—holding down big jobs—in the Radio field. Men just like you—their only advantage is training. You, too, can become a Radio Expert just as they did by our new practical methods. Our tested, clear training, makes it easy for you to learn. You can stay home, hold your job, and learn quickly in your spare time. Lack of education or experience are no drawbacks. You can read and write. That's enough.

MANY EARN \$15, \$20, \$30 WEEKLY ON THE SIDE WHILE LEARNING

My Radio course is the famous course "that pays for itself." I teach you to begin making money almost the day you enroll. My new practical method makes this possible. I give you SIX BIG OUTFITS of Radio parts with my course. You are taught to build practically every type of receiving set known. M. E. Sullivan, 42 73rd Street, Brooklyn, N. Y., writes: "I made \$720 while studying." Earle Cummings, 18 Webster Street, Haverhill, Mass.: "I made \$375 in one month." G. W. Page, 1807 21st Ave., Nashville, Tenn.: "I picked up \$935 in my spare time while studying."

YOUR MONEY BACK IF NOT SATISFIED

"I'll give you just the training you need to get into the Radio business. My course fits you for all lines—manufacturing, selling, servicing sets, in business for yourself, operating on board ship or in a broadcasting station—and many others. I back up my training with a signed agreement to refund every penny of your money if, after completion, you are not satisfied with the course I give you."

**ACT NOW—
64-Page Book Is FREE**

Send for this big book of Radio information. It won't cost you a penny. It has put hundreds of fellows on the road to bigger pay and success. Get it. Investigate. See what Radio has to offer you, and how my Employment Department helps you get into Radio after you graduate. Clip or tear out the coupon and mail it RIGHT NOW.

**J. E. SMITH, President
Dept. 9S
National Radio Institute
Washington, D. C.**

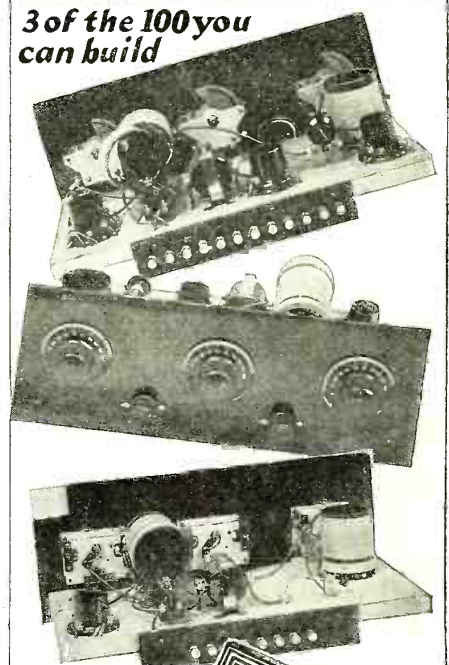

Find out quick about this practical way to big pay

Mail This FREE COUPON Today

**J. E. SMITH, President
Dept. 9S, National Radio Institute
Washington, D. C.**

Dear Mr. Smith: Kindly send me your big book, "Rich Rewards in Radio," giving information on the big-money opportunities in Radio and your practical method of teaching with six big Outfits. I understand this book is free, and that this places me under no obligation whatever.

Name..... Age.....
Address.....
City..... State.....
Occupation.....

**Employment Service to all Graduates
Originators of Radio Home Study Training**

SM

S-M LEADERSHIP means Better Radio



Are you receiving "The Radiobuilder" regularly? Published every month, this little magazine provides you with the earliest information on forthcoming S-M developments, and with operating hints and kinks that will help you to get the most out of radio.

You can't afford to be without "The Radiobuilder," for besides general news of interest to every setbuilder, it gives advance notice and previews of new products, and detailed constructional and operating data on new apparatus before the information appears in the S-M DATA SHEETS.

If you want to keep abreast of the very newest and most practical in radio building developments, be sure to mail today the coupon at the lower left-hand corner of this page.

NOTE: To S-M Authorized Service Stations, "The Radiobuilder" is mailed each month, free of charge, together with all new Data Sheets and Service Bulletins as they come from press. To all others nominal charge is made; see coupon.

FOUR short years ago S-M was virtually an unknown trade mark. Today Silver-Marshall holds the position of dominating leadership in the radio parts and kit field. Such leadership is the positive proof that better radio can be had for less money in S-M parts and kits. Year by year, S-M production facilities have increased along with S-M popularity. Today, as never before, it is overwhelmingly true that, with S-M parts—"You can build it better and cheaper."

Together with one of our many co-operating distributors we take pleasure in announcing for 1929 a number of astonishing new developments, offered at prices that demonstrate the savings which the quantity production methods of America's largest quality parts manufacturer mean for you individually.

A Universal Chassis and Table Type Shielding Cabinet

Both the 720 Screen Grid Six and the "Coast-to-Coast" Four, announced on the opposite page, may be housed in the 700 cabinet, providing the dignified and distinguished appearance seen above. The Universal pierced metal chassis, on which these sets are mounted, as well as this cabinet, are available for use by set builders generally.



700 Shielding Cabinet: with walnut moulding base...\$8.50
701 Universal Chassis... 3.00
809 2-control Escutchcon 2.75

New S-M Audio Transformers

These marvelous new high-gain amplifying transformers, whose tone quality was the sensation of the 1928 Radio Trade Show at Chicago, are offered in two sizes, both of which are unconditionally guaranteed finer than all other types on the market. For the first time in audio transformer history, they actually eliminate hysteretic distortion inherent in all other transformers.

Audio Transformers: 225 First Stage, 226 Second Stage. Each.....\$9.00

S-M Reservoir Power Supplies

No matter what kind of a set you have or are going to build, you will need power for it. In Silver-Marshall Reservoir Power Units you can get, in the 675ABC, full 450 volts to operate 210 or 250 type tubes, and ABC power for the whole set as well. If 180 volts for 171 type tubes is sufficient, the 670B Unit will supply it, with 22, 45, 90, and 135 volts as well. Type 670ABC supplies all these voltages, and 1.5, 2.25, and 5.0 volts "A" as well.

Audio Transformers: 255 First Stage, 256 Second Stage. Each.....\$6.00

S-M Unipac Power Amplifiers

For the man who wants really fine reproduction—who wants to hear an orchestra over the radio just as loudly and clearly as though he were in its presence, the Unipacs are a vital necessity. They make available undistorted output ranging from 1500 to over 13,000 milliwatts. They insure that full tonal range which adds new zest and enjoyment to radio reception. Unipacs are to be had for 210 and 250 tubes, singly or in push-pull, as well as a powerful public-address amplifier type, for outdoor or auditorium use.

675ABC, Completely Wired.....\$58.00
670B Kit.....\$3.00
670B Wired.....\$6.00
670ABC Kit.....\$5.50
670ABC Wired.....\$8.50

685 Public Address Amplifier: Kit.....\$124.00
Wired, Complete.....\$160.00

Silver-Marshall, Inc.
848 W. Jackson Blvd. Chicago, U. S. A.

Please send me, free of charge, the complete S-M Catalog.

For enclosed.....in stamps, send me the following:

(50c) Next 12 issues of THE RADIOBUILDER (\$1.00) Next 25 issues of THE RADIOBUILDER

S-M DATA SHEETS as follows, at 2c each:

No. 1. 670B, 670ABC Reservoir Power Units

No. 2. 685 Public Address Unipac

No. 3. 730, 731, 732 "Round-the-World" Short Wave Sets

No. 4. 223, 225, 226, 255, 256, 251 Audio Transformers

No. 5. 720 Screen Grid Six Receiver

No. 6. 740 "Coast-to-Coast" Screen Grid Four

No. 7. 675ABC Power Supply and 676 Dynamic Speaker Amplifier

(50c) Sargent-Rayment Instruction Booklet

Name.....

Address.....

If you don't wish to build, yet want your radio to be custom-made, with all the advantages that this implies, S-M will gladly refer your inquiry to an Authorized Silver-Marshall Service Station near you. If, on the other hand, you build sets professionally, and are interested in learning whether there are valuable Service Station franchises yet open in your territory, please write us.

SILVER - MARSHALL, INC.
848 W. Jackson Blvd., Chicago, U. S. A.

SM

Better Selectivity and Better Distance

WE take great pride in offering for the first time the latest and newest products of the world's largest quality parts manufacturer. Silver-Marshall's rapid rise to leadership in the American radio parts and kits industry is due to the S-M policy of giving finer quality and greater value in every single part than can be found in competitive products.

The opening of the 1928 season finds this policy carried to new heights, and Silver-Marshall offers new kits and parts of absolutely unprecedented value. A six-tube screen grid receiver, fully shielded, for less than seventy dollars; audio transformers built on an entirely new and superior principle; power amplifying equipment filling every requirement up to public-address use; the Sargent-Rayment Seven—these are but a few of the reasons why S-M will lead this year by a wider margin than ever before: simply because S-M provides newer, finer, and surprisingly "better radio"—for you.

The 720 Screen Grid Six

Unique in the exactness with which it fulfills the requirements of the setbuilder, the new 720 Silver-Marshall Screen Grid Six—successor to the famous Shielded Grid Six of such unparalleled popularity already during 1928—comes with such positive proof of definite superiority as to forestall all comparison. A 720, put together from the regular kit, in two hours of summer tuning in a Chicago apartment building logged forty-one stations, including FIVE distant stations broadcasting on channels adjacent (only 10 kilocycles difference) to powerful local Chicago stations.

Results like this would be remarkable if obtained from the highest-priced ready-made sets using all manner of extra controls. But this record was made by the same identical two dial, six tube, fully shielded screen grid kit which we can offer you for immediate shipment, with full building instructions, at \$69.75 backed by Silver-Marshall's guarantee! The 700 cabinet is \$8.50 additional.

The 710 Sargent-Rayment Seven

A station tuned in for every ten kilocycles—an average of one hundred stations heard in one evening—that is the performance record of the Sargent-Rayment Seven, tested in the heart of Chicago interference on a warm summer evening. To the ultra-skeptical veteran listener, seeking the extreme of radio reception in all respects, we heartily recommend this latest achievement of Messrs. Sargent and Rayment—inventors of the Infradyne.

The 710 is a precision laboratory-type radio receiver, in a thick aluminum shielding cabinet, finished in satin silver and trimmed by black instrument name plates. The set has five sharply-tuned circuits in a four-stage screen grid R. F. amplifier, all tuned by a single illuminated drum, and provided with individual verniers, followed by a detector and two audio stages using the famous S-M 220 transformers. We unhesitatingly offer the Sargent-Rayment approved kit, manufactured exclusively by Silver-Marshall, Inc., as the last word in perfection for custom building.

The 710 Sargent-Rayment Seven: Complete Kit Containing Laboratory-Tested, Inspected and Matched Parts. With knocked-down special aluminum shielding cabinet.....\$120.00

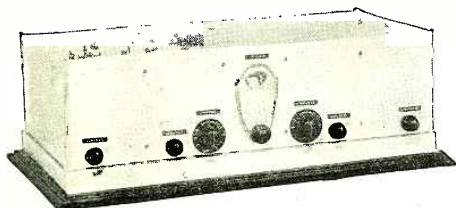

We carry in stock at all times, for immediate shipment, a full line of S-M products—including all the famous Unipacs, and audio transformers and other radio parts, as well as the kits shown on this page. Our catalog is free for the asking.

Liberal discount to dealers

Mail the coupon now!

WHOLESALE RADIO SERVICE CO.
6 Church Street, New York, N. Y.

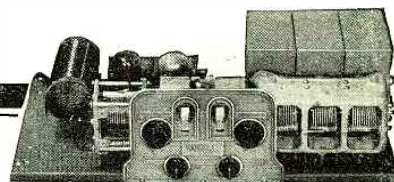

The 720 Screen Grid Six: Complete Kit with Full Instructions for Building, less Cabinet.....\$69.75
700 Cabinet, extra..... 8.50
720 Custom-Built, Complete \$90.00

The 740 "Coast-to-Coast" Screen Grid Four

To the thousands of fans for whom the four tube, R. F. amplifier, regenerative detector and two-stage audio amplifier is the time-tested standard of receiver comparison, the new Silver-Marshall 740 Coast-to-Coast Four offers the finest performance yet attained with this remarkable circuit.

Through summer static, the Coast-to-Coast Four plays on the speaker New York, Florida, Texas and California stations, cutting through local Chicago interference only 10 or 20 K. C. away. Its tone quality is such as only S-M transformers can provide.

Despite this demonstrated superiority over all other sets in its price class against which it has been tested, the complete kit of approved parts costs but \$49.75. The 700 cabinet is \$8.50 additional. We go on record that no matter what set you build or buy, the 740 Coast-to-Coast Four is the best dollar-for-dollar value you can find at anywhere near its price.

The 730 "Round-the-World" Short Wave Kit

Have you had your taste of the "thrill band"—the wave-length band from 17 to 200 meters? Down on these low waves are the Dutch, French, German and other stations. You can hear amateurs in almost every country on the same evening—if you have an S-M "Round-the-World" short wave set. It has an actual record of bringing in five continents in one evening.

The 730 is a complete four-tube regenerative (non-radiating) short wave receiver kit, with a special aluminum cabinet. It has one screen grid R. F. stage, detector, and two high-gain Clough audio stages. It tunes from 17.4 to 204 meters with four plug-in coils fitting a standard five-prong tube socket on top of the cabinet. A two-tube adapter kit, with the same aluminum cabinet but without the two audio stages, is available as the 731 kit. The 732 "Essential Kit" contains the new tuning and tickler condensers, the four plug-in coils, coil socket and three R. F. chokes. Choose the one you prefer—and step out into the "thrill band!"

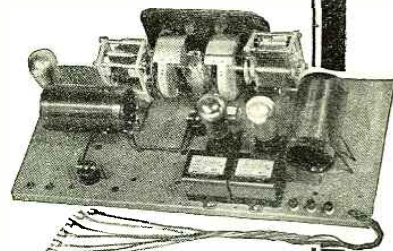

The 740 Coast-to-Coast Four: Complete Kit with Instructions for Building, less Cabinet.....\$49.75
700 Cabinet, extra..... 8.50

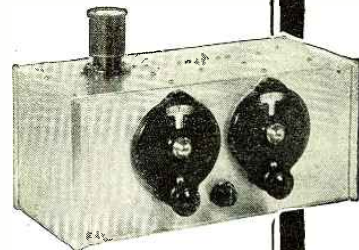

The 730 Round-the-World Four: Complete Kit with Instructions for Building; with Cabinet \$51.00
731 Two-Tube Kit, Complete with same Cabinet.....\$36.00
732 Essential Kit.....\$16.50

Wholesale Radio Service Co.
6 Church St., New York, N. Y.

Please send at once your new free catalog listing S-M and many other highest-quality radio kits, parts, and supplies, as advertised in Sept. "Radio News."

Name.....
Street No.....
Town.....

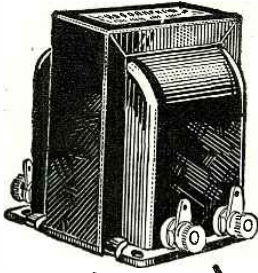

In Most of The Better Radio Receivers

Watch dogs of tone quality safeguarding the musical reproduction of broadcast programs, Thordarson Audio Transformers do their part in making real musical instruments of hundreds of thousands of receiving sets annually.

Among leading set manufacturers, Thordarson transformers have long been recognized for their fidelity of reproduction. Today their use is so universal that it is difficult to find a dealer who does not sell at least one make of receiver so equipped.

Try this simple experiment. Ask your dealer for a demonstration of his receivers. Pick out the instrument with the most natural reproduction, and then look inside the cabinet. You will find, in the majority of cases, Thordarson amplifying and power supply transformers.

You will realize that it is wise to specify Thordarson amplification when buying your receiver, for the manufacturer who is far-seeing enough to equip his sets with Thordarson transformers, may be depended upon to have the balance of his instrument in keeping with this high standard.

new!



THORDARSON
R-300
AUDIO TRANSFORMER

A superior audio transformer that will satisfy the most critical musical ear. The high impedance windings of the R-300 are wound on a core of D-X Metal, a recent development of the Thordarson laboratory. This new core material has an exceedingly high A.C. permeability, and an inductance that is 50% greater than that of the highest grade silicon steel. In performance, this transformer responds exceptionally well to the lower frequencies and provides the same degree amplification to the diapason of the grand organ as to the note of the flute. Ratio 3:1. Dimensions, $2\frac{1}{2}'' \times 2\frac{1}{2}'' \times 3''$ high. Weight, 2 lbs. Price, \$8.00.

THORDARSON

RADIO TRANSFORMERS

*Supreme
in
musical performance*

THORDARSON ELECTRIC MANUFACTURING CO.
Transformer Specialists Since 1895
WORLD'S OLDEST AND LARGEST EXCLUSIVE TRANSFORMER MAKERS
Huron and Kingsbury Streets - Chicago, Ill. U.S.A.



Editorial and General Offices, 230 Fifth Avenue, New York

Vol. 10

SEPTEMBER, 1928

No. 3

The Short-Wave Era

By HUGO GERNSBACK

ONCE more a silent, but nevertheless most important revolution is making itself felt in radio. These periodic revolutions in the art of radio are a novelty no longer, but occurrences to which the careful observer has become quite accustomed. Only a short year ago, the radio art began to turn away from battery operation of sets and started to electrify them. Late last year, still another revolution brought the complete A.C.-operated set.

During the past few months, a new era seems to have opened in what will be known hereafter as the "Short-Wave Cycle."

Not that short waves are something new in radio; quite the contrary. This work goes back to 1908, when amateurs first began to converse with each other, by dots and dashes, below 200 meters. The amateurs have kept at this ever since, without making much, or any, impression upon the general public. The reason for this lack of interest, of course, is that, in order to operate either a short-wave transmitting set or a short-wave amateur receiving set, you had to be conversant with the "code"; and this is something at which the general public has always balked.

To the average radio listener, to the radio fan, and to the set builder in general, dots and dashes are so much noise and "static," not to be taken seriously at all. Of course, these listeners lose the best part of radio through not being able to understand or work code, and miss many of the thrills that the amateur enjoys in deciphering a message that comes from the Antipodes. Yet, the general radio public, in spite of all its love of novelty, is quite apathetic to these possibilities and the amateurs have failed to gain much ground. But of late the broadcast listener is becoming very much interested in short waves; not because he wishes to listen to code and its dots and dashes, but because *he can now receive broadcasts on his loud speaker or headphones* from practically any country throughout the entire world.

A reader in New South Wales, Australia, writes us that while he was writing his letter he was listening to WRNY's short-wave transmitter, 2XAL, on a three-tube set; and had to turn down the volume, otherwise he would wake up his family. All this at a distance of some 10,000 miles! Yet 2XAL, it may be said in passing, uses less than 500 watts; a quite negligible amount of power, as power is rated these days.

The radio set manufacturers for the past few years have claimed vociferously that the day of DX fishing and long-distance records is past. In their hearts, the manufacturers knew that this is not the case, but that the truth is, the average manufactured set is poor for long distance and is constructed primarily to receive local stations and others not more than 100 to 250 miles away. Manufacturers stress an assertion that set owners no longer wish to receive long-distance signals, on the theory that such reception never is good. We might take issue with the manufacturers on that score and point out that, with the average manufactured set, distant reception is usually not good; but, *if you have a really good set, distant reception certainly is good.* Hence, sooth to say, the set manufacturers to the contrary, the public is still interested in bringing into our everyday, humdrum existence the thrill of covering great distance. If this were not so, how otherwise explain

the sudden and tremendous popularity of short-wave broadcast reception?

During the past six months, every time RADIO NEWS ran a constructional article on a short-wave receiver, set builders and radio fans have responded in the ratio of three to one, compared to those following up the regulation broadcast-set articles. In other words, there still is a thrill in getting distance; because no set builder builds a short-wave receiver unless he is interested in receiving broadcasts from distant stations. This should be quite obvious because, within 100 to 200 miles of a short-wave transmitter, the usual short-wave receiver is hopelessly inefficient, on account of the so-called "skip-distance" effect.

It is quite the thing now for the radio fan to own one or more broadcast sets for the usual upper-wavelength broadcasts on 200 to 600 meters, and also a separate short-wave set which brings in broadcasts from 20 meters up to 200.

And as time goes on, the interest in short waves is becoming greater and greater. It may well be said that we have as yet not scratched the surface. Technicians believe that in due time all broadcasting will be done on short waves; everything seems to point that way. Already many stations are operating two transmitters simultaneously; one in the upper waveband, and the other in the lower waveband. These stations in doing so are simply staking out their claims for what is to come in the future; and the recent scramble for short waves for television purposes points unmistakably in the same direction.

Most radio engineers today are convinced that the final solution—unless an entirely new invention comes along—of television rests in the lower-wave spectrum. Companies and individuals have been awarded licenses to broadcast television on the lower wave channels and, unless a new invention does come along pretty soon, most of the television broadcasting will be done on these lower waves. Such developments, of course, like all revolutions of this kind, are slow and orderly; but they are revolutions nevertheless.

It would not surprise me at all if, during the next five years, the broadcasting of both sound and sight will be done completely on short waves; and the upper wave-channels from 200 to 600 meters gradually abandoned, as fast as we learn more about the short waves. At the present time, the only thing that stands in the way of universal adoption of short waves is the skip-distance effect. Take, for instance, 2XAL, broadcasting on 30.91 meters; within 200 miles of New York, the reception is poor. Beyond this distance it becomes better and better, the further you get away from the transmitter. This is one of the problems that has yet to be solved and, when it has been solved, there is little doubt that all stations will move down into the short-wave part of the spectrum.

In the meanwhile, it is encouraging to note that the radio broadcast listener and the radio set builder have become more and more impressed with the importance of the short-wave situation. The movement is assuming greater proportions every month, and it will not be long before the set builder will desert the upper wavelengths entirely, and construct only short-wave receivers, to the exclusion of all others.

Mr. Hugo Gernsback speaks every Tuesday at 9.30 P. M. from Stations WRNY (326 meters) and 2XAL (30.91 meters) on various radio and scientific subjects.



The Stinson-Detroiter plane, which made the coast-to-coast-and-return test of the latest type of radio equipment. Insert shows W. G. Fish, radio engineer in charge of the test during the flight.

Making Radio Easier for Aviators

Increasing Commercial Value of Airplanes and Growing Popularity of Air Travel Promotes Development of Special Radio Apparatus for the Purpose

By Allan K. Ross

WHAT radio means to the navigator at sea today, it will soon mean to the aviator and his passengers. No longer will it be necessary for the long-distance flyer, crossing the trackless ocean or fog-hidden land, to be isolated from those on land and sea as effectively as though he were on a different planet. Long-distance flights, such as those of Lindbergh, Byrd and Chamberlin, during which these daring explorers of the upper regions were out of touch with civilization for hours at a time, will be a thing of the past.

A complete radio transmitting and receiving set, recently developed for use on airplanes, has a total weight of but 85

pounds, and permits two-way radio-telephone communication up to a distance of approximately 400 miles and two-way radiotelegraph communication up to 1,000 miles. These ranges are sufficient to insure contact with ship or shore stations on nearly any conceivable long-distance flight.

While this latest development of science, combining aviation and radio, will be of great value to the aviator in blazing new trails across the sky, it is destined to find

its greatest use in the everyday life of the American business man who desires to take full advantage of the airplane as a means of transportation.

EXPERIMENTAL WORK

On a number of occasions in the past, radio has demonstrated its value on long-distance, non-stop flights. For example, it was used by the NC-1, the first airplane to cross the Atlantic, in 1919, and again by

The new radio transmitting and receiving equipment developed for use on commercial airplanes. The oval receiving set and battery box for "A" and "B" batteries are shown below; while the transmitter unit and control box are shown at the right. This equipment can be used for radio-telegraph and telephone communication from plane to plane, or from plane to ground, and has a normal range of about 400 miles; although much greater distances have been covered.

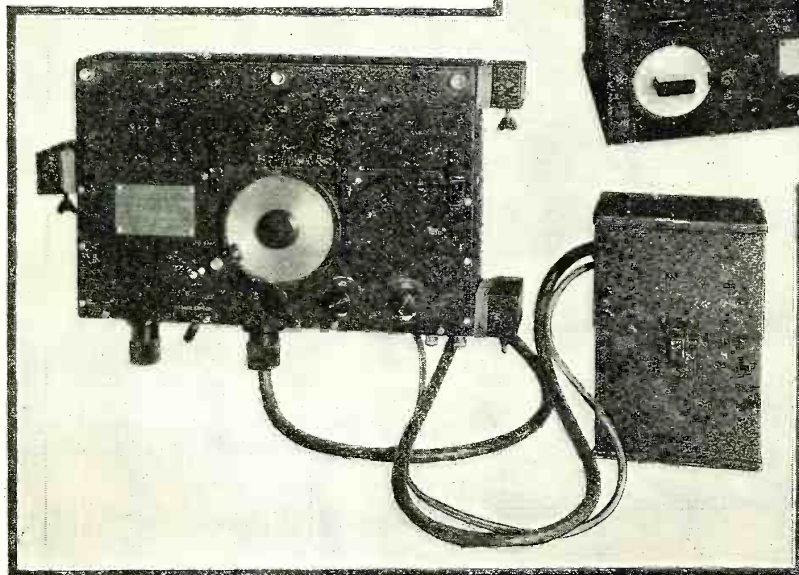
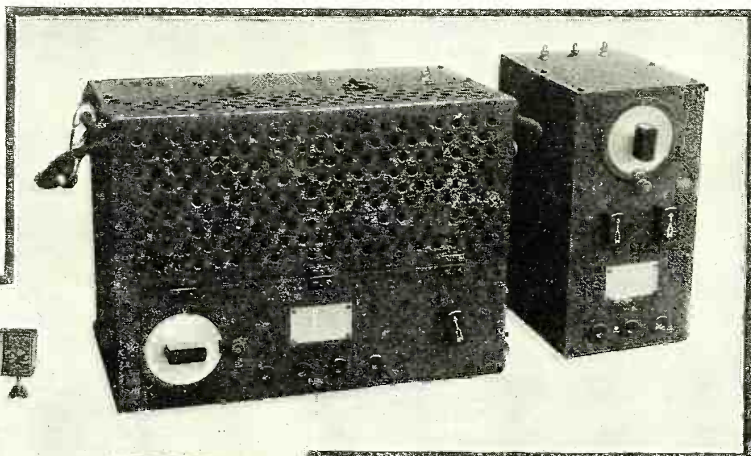

Commander Richard E. Byrd on his dash over the North Pole in 1926. These are only two of a number of history-making flights on which radio has proved its value to aviation. But the use of radio on airplanes has remained more or less of an experimental proposition. There has been a need for some standard transmitter and receiver, light in weight and simple in operation, which would require a minimum of care and attention. The average pilot has only a limited knowledge of radio and, while in the air, has little opportunity to make careful tuning adjustments, such as are required by most of the equipment available heretofore.

To meet this need, there has been developed and tested a complete airplane installation that gives promise of filling this long-felt want. It is exceptionally light in weight, requires but two tuning controls (one for the transmitter and one for the receiver) and can be produced in sufficient quantity to make it worthwhile for the commercial pilot to learn its operation.

ACROSS THE U. S. A.

Early in March of this year a five-passenger Stinson-Detroit monoplane, equipped with the new transmitting and receiving equipment, took off from Curtiss Field, Long Island, on a 10,000-mile coast-to-coast and return flight to demonstrate the complete practicability of radio-telephone and telegraph communication between ground and plane, and to further the cause of practical commercial aviation. The project was sponsored by the *New York American* and

The airplane transmitter was licensed under the call letters 2XKB. A wavelength of 120 meters was selected as the best in the band between 109 and 133 meters assigned to aircraft. Before the take-off at Curtiss Field, arrangements had been made with a number of land stations to co-operate in standing-by for the plane's signals. A selected group of amateur stations also aided in conducting the tests by keeping in constant touch with the plane. In return for this valuable co-operation, the *New York American* will soon award as prizes, three cups: to the amateur who received signals from the aircraft over the greatest distance; to the amateur who conducted two-way communication by telephone or telegraph over the greatest distance; and to the amateur rendering the most valuable general radio service. So effective was the service rendered by the amateurs that the plane was never out of touch with at least

on the regular wavelength of station KPLA. This is believed to have been the first time that such an address has been given from a plane. At a number of times, when special supplies were desired at the various landing fields used by the plane during the trip, communication was established with an amateur station in the vicinity of the field while the plane was still several hundred miles away. The order for the necessary supplies was relayed to the field by the amateur and, in every instance, the supplies were on hand by the time the plane arrived, so that no time was lost on the ground.

APPARATUS USED

The new radio equipment used for the first time on this flight comprises a radio transmitter adapted for either code or voice communication; a wind-driven generator to supply the necessary plate and filament current for the transmitter, and a filter box, containing the necessary filter condensers and chokes. The receiving set consists of the receiving box, in which is mounted a five-tube tuned-radio-frequency receiver and a battery box containing the "A" and "B" batteries. In addition, a small control box was supplied in which was mounted a change-over switch to change the aerial connection from the transmitter to the receiver, and a switch to change from code to voice transmission. Three jacks are provided on this unit: one for the microphone, one for the telegraph key and one for the headphones. Only one other control is necessary, and that consists of a dial for tuning the antenna circuit of the transmitter. This is also mounted in the control box. A duplicate control box was supplied for the pilot, which made possible the control of the set from more than one point in the plane. An eighty-foot trailing aerial was used for both transmission and reception.

The transmitter used is of the master-oscillator, power-amplifier type and employs two 210 tubes and two 211 tubes, having an output of approximately 100 watts when used for telegraph communication. The receiving set employs five tubes in a circuit comprising two stages of tuned-radio-frequency amplification, detector, and two stages of audio amplification. It uses a system of plug-in inductance coils so that

(Continued on page 260)

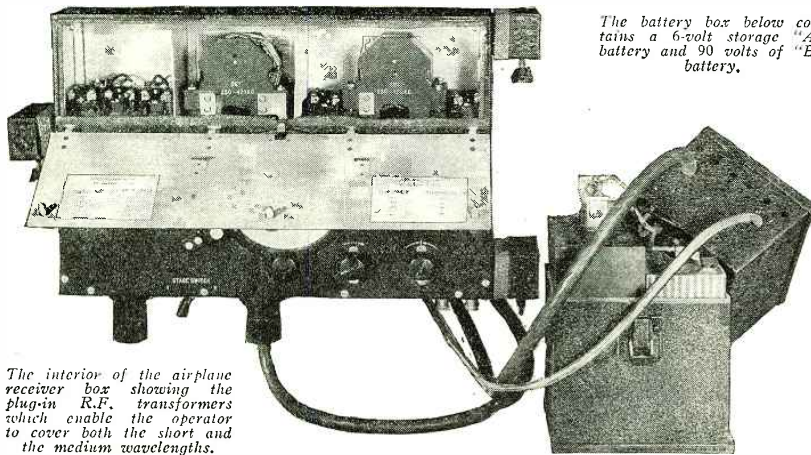

The battery box below contains a 6-volt storage "A" battery and 90 volts of "B" battery.

The interior of the airplane receiver box showing the plug-in R.F. transformers which enable the operator to cover both the short and the medium wavelengths.

was in charge of Captain H. Gordon Smith, head of the aviation activities of that newspaper. Captain Smith was accompanied on the flight by Lieutenant G. W. Hopkins, chief test pilot of the Stinson Aircraft Company, builders of the plane; R. J. Wall, representative of the National Safety Council of Toledo, Ohio, owner of the plane; John C. Ingram of the United Press Service, and W. G. Fisk, radio engineer, representing the Radio Corporation of America.

The trip was arranged to include stops at all aircraft plants in the United States, and sufficient time was allowed so that, on the return flight, a stop could be made at the aviation show held at Detroit, Mich., the week of April 14th.

one of the thirty offices maintained by the Radio Corporation.

DEMONSTRATIONS EN ROUTE

After leaving Curtiss Field, the plane made stops at Philadelphia, Washington, Pittsburgh, Columbus, Dayton, Cincinnati, St. Louis, Dallas, Fort Worth, Midland (Texas), El Paso, Yuma (Arizona), San Diego, and Los Angeles. At Pittsburgh, the voice of the operator in the plane was picked-up and rebroadcast over KDKA. At Los Angeles, Mayor George Cryer of that city was taken up in the plane and an address intended for the people of that city was delivered over 2XKB and rebroadcast

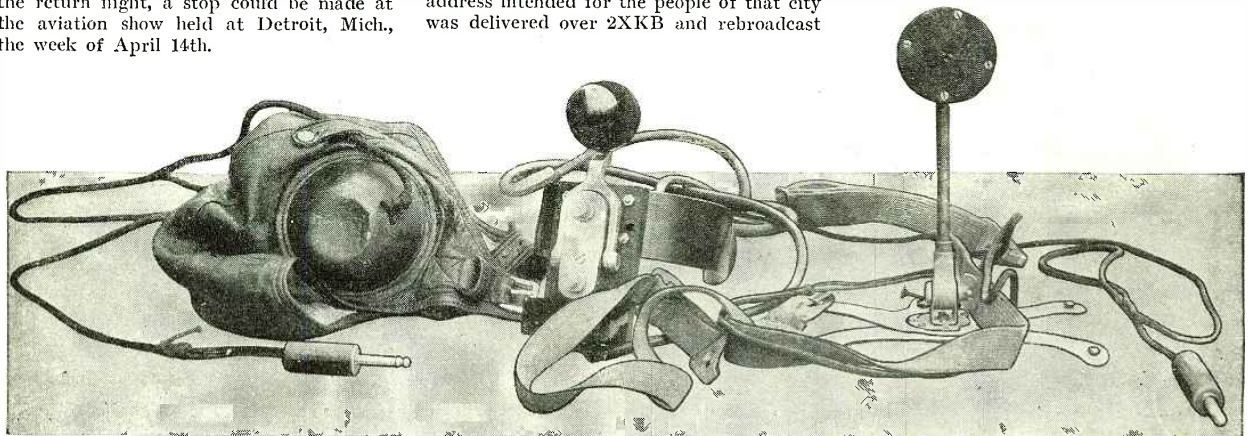

The airplane operator's equipment consists of a sound-proof leather helmet in which the headphones are mounted; a special type of telegraph key attached to a leather strip, so that it can be fastened firmly to the operator's leg just above the knee; and the microphone, which is supported by a metal breastplate.

Some Problems of A.C. Operation

On the Success of Their Solution Depends the Success of the Electric Receiver for Both Home Builders and Owners of Commercial Sets

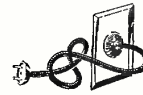
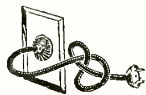

By Charles Magee Adams

THE widespread, not to say sensational, popularity of the A.C. receiver has, of course, been based on its promise of relief from the problems incident to battery operation; and there can be no doubt that it has made good this promise. But the solution of one set of problems often has a way of bringing in other problems all its own; and, as both home constructors and users of commercial sets have by this time discovered, this is true of the electric receiver.

Such a turn of events should not be unexpected. It must be remembered that A.C. operation is still quite a youth, even as age in radio is reckoned. Also, its problems singly are neither serious nor insurmountable; but, together, they constitute the margin between successful and merely indifferent results. So it seems worth while to consider them and their possible solutions.

First—the matter of hum.

When experienced fans listen in on an electric receiver for the first time they note a slight A.C. note in the output and, at the present stage of the art, such a "residual" hum seems inevitable. Some of the more tolerant dismiss it as the price paid for the convenience of A.C. operation, an altogether sensible attitude. Even those who complain at first find that, in a surprisingly short time, they become accustomed to this background and that except on the weakest signals it offers no handicap to enjoyable reception.

OVERLOADING THE "B" UNIT

This is not to say that some receivers do not have an excessive hum; quite a sizeable percentage do. But in only a few cases can this be charged to the heating of the tube filaments with raw A.C.

The most prolific cause of annoying A.C.

component is, oddly enough, an overloaded "B" supply unit. This is particularly (though not exclusively) true of home-constructed or rewired receivers, where the builder has made use of an existing power pack to carry what proves to be a larger load.

It must be remembered that *the indicated rating of a "B" device is the maximum.* It can be worked up to or slightly above this

receiver for A.C. operation, a gratifying improvement on the score of quiet output will be gained.

WIRING AND SHIELDING

Almost as prolific a cause of excessive hum in the "roll-your-own" or rewired receiver is *induction*. Fans whose experience has been entirely with battery sets are prone to forget that *each wire carrying alternat-*

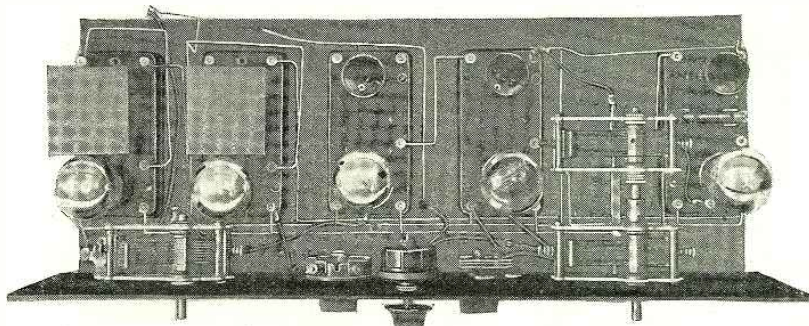

This is an excess of neatness which defeats its end. The nice parallel wires will cause all kinds of pick-up and introduce A.C. hum into the circuits. Point-to-point wiring for R.F. circuits is better, because the leads cross more nearly at right angles, and cabled wiring for filament circuits.

milliamperage without fear of damage, but experience has shown that, as soon as the maximum drain is approached, the filtering efficiency of the unit drops off sharply, because of the magnetic *saturation* of the choke cores and, to a less degree, the overloading of the rectifier tube and filter condensers.

Accordingly, for best results as regards smoothness of output, a "B" unit should be worked at *about half, or not to exceed two-thirds*, of its rated drain. If this rule is observed in constructing or adapting a re-

ceiving current is surrounded by an *electromagnetic field*, which will set up alternating currents in other conductors nearby, particularly if they are parallel to it.

This electrical law makes it imperative that grid leads be run with even greater care than in battery sets. They must not only be as short as possible, but should not parallel the filament lines or, especially, the 110-volt leads to the power transformer. Lack of painstaking care in these details has been responsible for much grief encountered by home constructors.

It will avail nothing, however, if a poorly-shielded power transformer is used. Such a device (and some of the inferior makes are not properly shielded) will blanket the wiring with a field whose results shout for themselves in the loud speaker. So, as generally is the case, economy lies in the purchase of only well-designed equipment; which means a transformer with a substantial case completely enclosing the windings.

It must not be inferred from all this that excessive hum cannot be caused by tubes themselves. In cases where an undesirable A.C. "component" persists, after all these precautions have been taken, it will generally be found that one or more tubes are defective.

While making their first acquaintance with A.C. sets, fans sometimes complain that these receivers are unduly noisy, as regards factors other than hum. It is true that any receiver drawing its power from the lighting circuit is more susceptible to electrical disturbances and static than a set powered by batteries. But it must be noted that this is due to the effect of the lighting

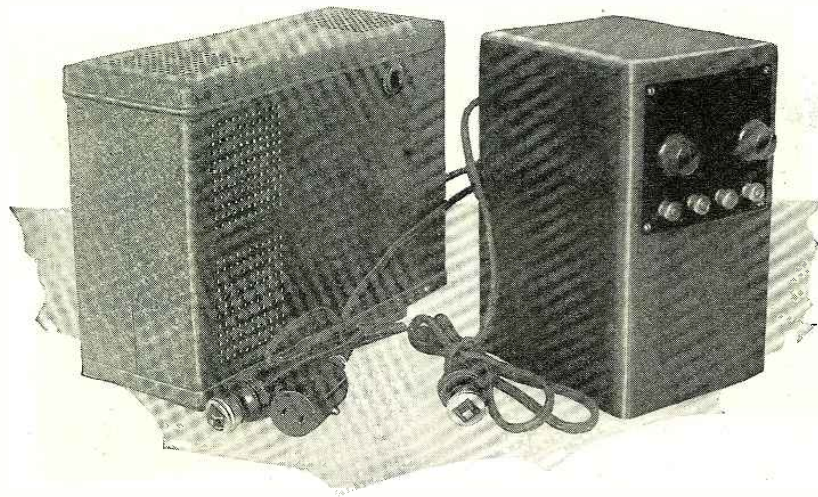

Two power units; that at the left shows the required number of ventilating holes. The one at the right is very handsomely designed, but lacks this very essential feature.

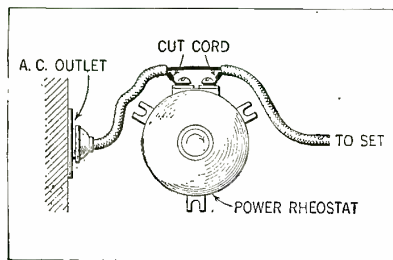

Cutting one wire of the pair which feeds 110-volt current to a set allows insertion of a power rheostat to keep the voltage down to a proper value.

line as an aerial, rather than to the A.C. tubes themselves; and hence, that the same effect will be found in a D.C. set supplied by the conventional socket-power unit.

A.C. sets often appear to be noisy merely because of the manner in which they are operated. Receivers of this type have an audio amplifier of much greater power than most battery sets; and owners, tempted by this power at their fingertips, frequently employ excessive volume, with the result that the amplifier boosts any noisy component in the signal to a high degree. The fact that the receiver is operating on A.C. is, obviously, not responsible for outraged ear drums.

DISSIPATION OF HEAT

Of the various problems involved in alternating-current operation, ventilation is the one which receives perhaps the least serious consideration, particularly from those fans without practical experience. This is true, because with the average battery receiver, using no tube larger than a 112-type, the amount of heat developed is so small as to be ignored. But that cannot be done with the electric set.

Here at least a 171-type will be found in the last audio stage (two, if push-pull is used), which means an appreciable amount of heat. Added to that is the much larger quantity of heat developed by the rectifier tube and the power transformer, as well as that given off by the "B" voltage divider. So there must be some means provided for keeping the whole apparatus at a safe working temperature.

This is accomplished by liberal spacing of this heat-generating apparatus, together with suitable openings in the housing for adequate circulation of air. So it is important that the home constructor carry out specifications as to these features when building an A.C. power pack or receiver. Economy of space can be secured by a more compact grouping of apparatus, but the results after a brief period of operation will be far from desirable.

For the same reasons, the fan installing a commercial A.C. receiver must do so with an eye to ample ventilation.

If its power unit is of the separate type, it must be placed at a point where the flow of air to and about it will be unobstructed by any object; as, for example, a cover intended to enhance its appearance. The same is true when the power unit is built into the receiver and, in both cases, particular precautions must be observed if the complete equipment is being housed in furniture.

Much as consoles and highboys lend to decorative effects, many, especially the home-designed sort, fail to provide sufficient ventilation for an electric receiver; with the result that the temperature about the heat-radiating parts becomes excessive after a

prolonged period of continuous operation.

Fire seldom follows, to be sure. The fuse in the 110-volt lead can be counted on to blow before that happens. But meantime the tubes will be worked at a temperature that materially shortens their lives, the insulation (particularly of windings) will be weakened, and the filter condensers, if of paper construction, damaged. So the matter of ventilation can be seen to be worth considerably more attention than it usually receives.

LINE-VOLTAGE PROBLEMS

However—as is now known only too well—the gravest and most universal problem involved in A.C. operation is that of fluctuating line-voltage.

Theoretically, the current delivered to the primary of the receiver's power transformer over the house-lighting circuit is at 110 volts, with a permissible variation of 5 per cent above or below that figure. But in practice it has been found that the voltage supplied varies all the way from 90 to 130, not only hour by hour according to changes in load and other factors, but constantly because of improper regulation, poorly-designed feeders, etc.

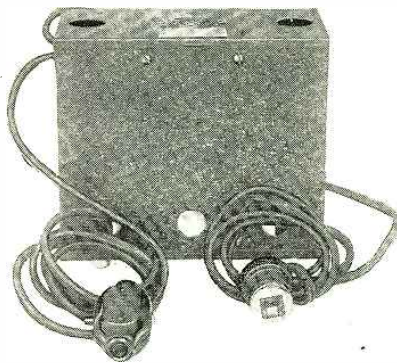

Automatic voltage regulators are now obtainable. This apparatus will take any commercial A.C. voltage between 90 and 130, and deliver exactly 110 volts up to 60 watts.

This situation has a definite and vital bearing on receiver operation; because tube filaments are designed to function at a certain temperature, which, in turn, means a given voltage. If this voltage is exceeded, the result will be too high a temperature and greatly shortened life of the filaments; while, if it is reduced, the result will be too low a temperature and weakened volume. Obviously, the voltage delivered to the vari-

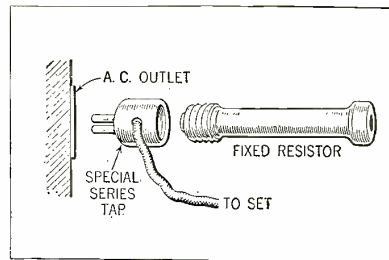

The special tap shown here is so designed that, when the resistor is screwed into the receptacle, it is in series with the power line to the set.

ous tube filaments is directly proportional to that impressed on the power-transformer primary. So the engineers have been busy seeking a solution of this really serious problem.

VOLTAGE REGULATION

The most familiar of the several solutions which have so far been developed is the tapped primary for power transformers. Instead of a winding designed only for 110-volt supply, one with two or more taps for various voltages is provided. For example, a typical transformer of this sort has two such taps, one for voltages from 105 to 115, and the other for voltages from 115 to 125. At the time of installation a voltage reading is taken and the connection made to the proper tap.

It will be seen that, provided the voltage does not rise above the figure indicated by the initial reading, this arrangement offers a simple and satisfactory safeguard and, notwithstanding its limitations, is recommended as a fundamental precaution.

However, the voltage sometimes does rise above the initial figure, and some receivers are not equipped with transformers whose primaries are tapped. In such cases, a suitable resistor connected in series between the receiver and the supply circuit offers satisfactory protection—again within certain limits.

The most convenient form of this resistance is a power rheostat, of which several makes are on the market. But if one is not available, a lamp or two or three lamps in series-parallel, may be substituted. The resistance should be adjusted till the voltage at the receiver is brought down to the proper figure.

This requires, of course, an accurate A.C. voltmeter, which many set owners lack. Also, if the voltage drops after a first setting of the resistance, the result will be loss

(Continued on page 275)

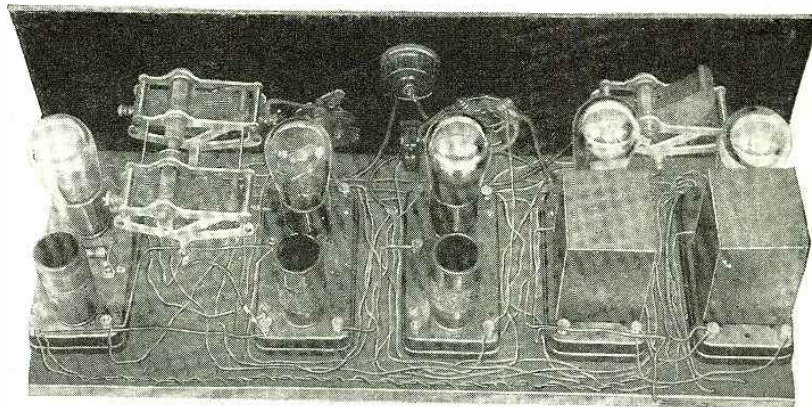

The kit shown neatly wired on the opposite page is illustrated here with too much wire. The parallel leads are avoided, but entirely too much inductance is introduced.

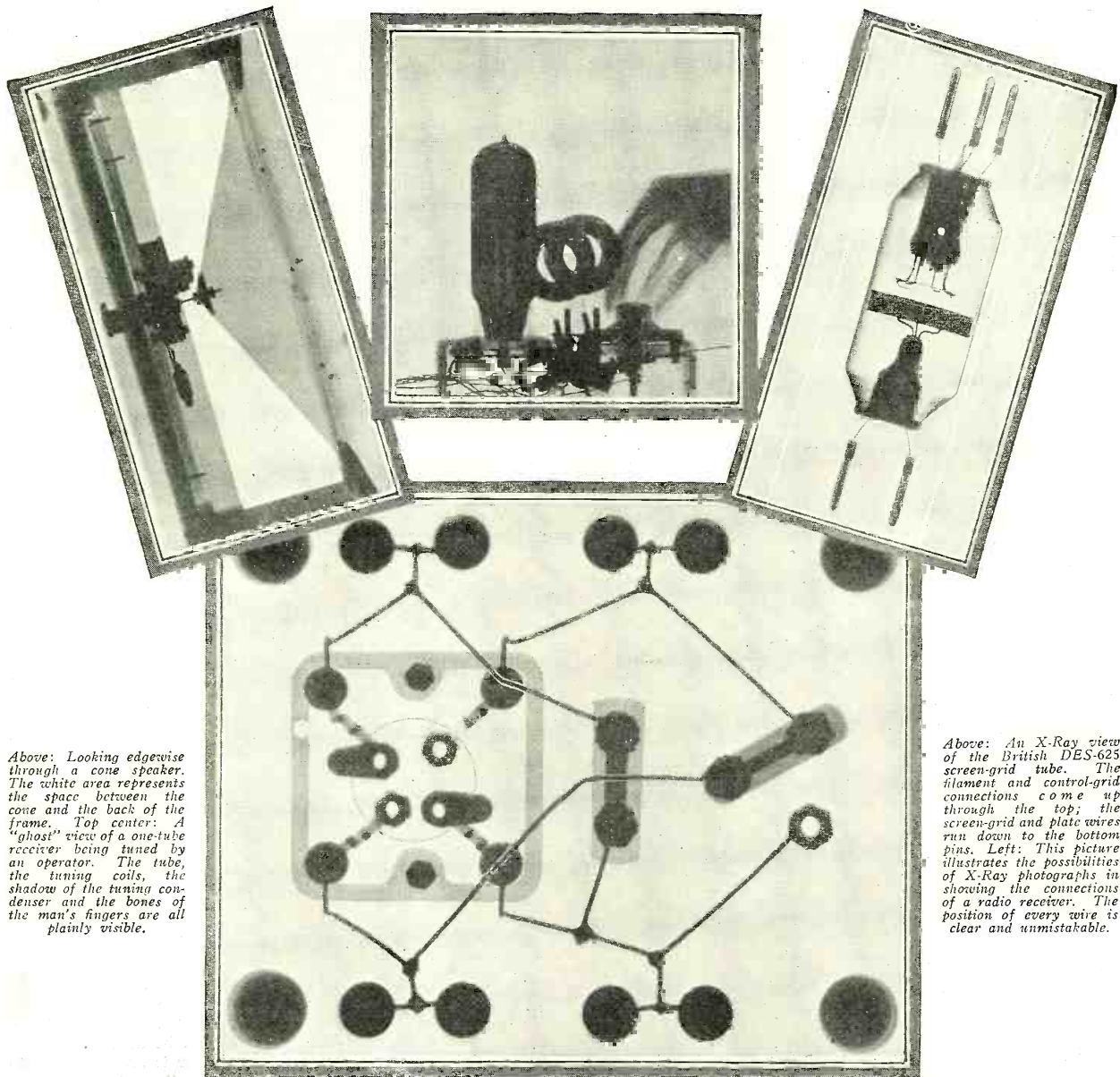

Above: Looking edgewise through a cone speaker. The white area represents the space between the cone and the back of the frame. Top center: A "ghost" view of a one-tube receiver being tuned by an operator. The tube, the tuning coils, the shadow of the tuning condenser and the bones of the man's fingers are all plainly visible.

Above: An X-Ray view of the British DES-625 screen-grid tube. The filament and control-grid connections come up through the top; the screen-grid and plate wires run down to the bottom pins. Left: This picture illustrates the possibilities of X-Ray photographs in showing the connections of a radio receiver. The position of every wire is clear and unmistakable.

X-Raying the Radio Set to Show Its Insides

German Experimenter Replaces Blueprints with "Ghost" Pictures

A NEW use for the X-ray, recently developed by Baron Manfred von Ardenne in his laboratories in Berlin (Germany) makes possible the use of these rays in photographing radio receiving sets, parts and other electrical equipment; thus bringing out constructional details of such apparatus which would be nearly impossible to illustrate by line drawings or diagrams.

A few of the many possible uses of this new development are shown in the accompanying illustrations. Others will doubtless suggest themselves to our readers. At the left is a cone-type loud speaker photographed without being removed from its box or cabinet; note the wood-screws that

hold the sounding board in place. Every part of the unit can be plainly seen. The illustration in the center indicates how such pictures can be used to suggest constructional details of a vacuum-tube receiving set. This particular set is equipped with honeycomb coils. Even the bones in the hands of the man holding the instrument can be seen. The photograph reproduced at the right shows the constructional details of an English screen-grid tube, known as the DES-625, which differs greatly from the American UX-222.

The lower picture shows how the new process can be used to indicate the wiring of a receiving set or other electrical apparatus. The photograph was taken through

the panel of the device, which in this case happens to be a German tube tester. Additional diagrams or blueprints are unnecessary when such pictures are used, as all leads and parts are clearly shown.

At least one German radio publication has made arrangements to illustrate a series of constructional articles with X-ray photographs of the set and parts in place of the usual blueprints and diagrams; and others are expected to adopt this method of instruction in the near future.

An important feature of this method of illustration is that it is a comparatively simple matter to retouch such photographs to bring out important features of the set or apparatus, and soften or omit others,

Novel Indoor Aerial Increases Signals

An Experimenter Obtains Excellent Results with a Coil which Differs from the Horizontal Loop in Having a Considerable Coupling to Ground

By Armstrong Perry



LAURENCE M. LOVELESS, of Bath, New York, is an old-time radio amateur. One of his hobbies is antennas. He has tried them all—L's, T's, trees, umbrellas, bed springs, fans and the rest. After the World War, which interrupted his favorite sport for a time, although he pounded brass for Uncle Sam as long as was necessary, he became a radio dealer in the firm of Loveless & Hamilton.

Antennas became a bread-and-butter affair when he went into the game of selling radio to broadcast listeners. With a "ham," a reasonable amount of interference causes nothing more serious than a blue glow induced by emergency-language output. He has no one at hand to pick on, so why indulge in thoughts of murder? The parts dealer who sells him the gadgets in his set disclaims responsibility because he does not put them together; and the interfering stations are too far away to be reached easily with a stick of dynamite.

But the BCL's insist that any set in which they have invested their simoleons ought to play one concert at a time—no more and no less—which few of them will. A good antenna might help to reduce interference and sell radio and keep it sold. In view of this situation, Mr. Loveless applied himself to the problem of antennas with increased energy and application, reviewing old experiments and trying new ones.

COILS WOUND ON HUGE TUBES

Mr. Loveless began with one of those Eveready battery cartons that look like

overgrown dry cells. He cut off two sections of it, about seven inches long; one was slit from top to bottom and the ends were lapped and glued together. This gave

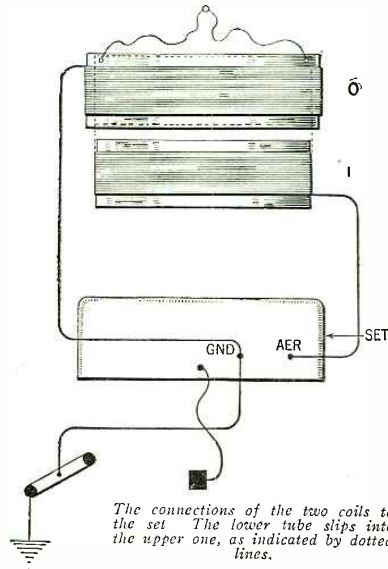

him two cardboard tubes which could be telescoped together, the larger about 13 inches in diameter and the smaller about 12 1/4 inches; on each tube he wound forty turns of bell wire. When he placed the smaller coil inside the larger he had something that resembled a giant loose-coupler of the dear, dead days of the "rock-crusher" and unlimited power and wavelength; but the hook-up was different.

He hung the device from wires in the arch between his living room and dining room. Mrs. Loveless (whose name is very, very different from her nature) has lived with her husband long enough to know that a radio amateur cannot be discouraged by caustic comment concerning the inappropriateness of dismembered cartons in interior decoration, and that it is exceedingly difficult to detach the said amateur's sensory apparatus from his radio hook-up long enough for him even to hear said remarks. She even smiles brightly when Lawrence explains his new aerial. Maybe it is because radio inventors sometimes make money. Seldom, but it has happened, and hope springs eternal.

INVENTOR SURPRISED

Loveless attached the upper end of the outside coil to the ground connection on a broadcast receiver, thus connecting the coil with the ground through a water pipe. The lower end of this coil was not attached to anything except the cardboard tube, and remained a dead end. The lower end of the inside coil was attached to the antenna post of the set; its upper end was free also, a dead end.

The inventor had no reason to expect that this aerial would produce unusual results. He was merely experimenting with a new and unknown device to see what would happen. He was surprised when he found that stations came in with greater volume than they had when the same set was connected with an outside aerial; and that much interference had been eliminated or reduced to negligible proportions.

The outside aerial was 100 feet long and 45 feet high, twice as high as the coils hanging in the arch on the second floor of his house. He installed a switch so that he could shift quickly from the outside aerial to the coils. Every test he made proved the superiority of the coils over the outside wire. He shifted from one to the other during the long notes of violins, saxophones and sopranos. The notes doubled in volume every time he changed from the outside aerial to the coils.

His set seldom brought in Chicago stations satisfactorily in the daytime while he was using the outside aerial. With the coils he picked up WLS, WMAQ and others clearly and strongly. Coast stations usually had been out of the question with the set and aerial that he had been using. The coils brought in even KFSD, a 500-watt station in San Diego, California.

DIFFERENT SETS TRIED

Thinking that the coils might happen to be specially adapted to the set that he was using, Loveless tried them with T.R.F. sets, (Continued on page 267)



Mr. Loveless with his aerial invention. The lower tube is here shown slipped out of the upper one.

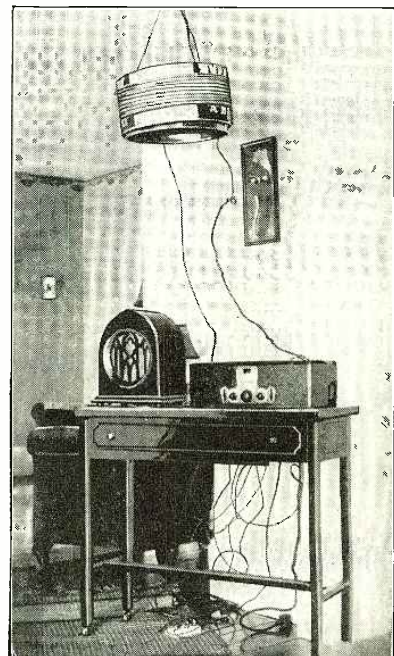

The Loveless aerial in position; it will be seen how compact and easy of installation the device is.



Radio in Newfoundland

Editor, RADIO NEWS:

I have read with much pleasure your "inside stuff" for RADIO NEWS readers, and I certainly do approve of your Editorial Policy Ballot; enclosed find one filled in. I have been a subscriber for several years to your interesting magazine, and do not remember having seen a letter from a listener in Newfoundland. Now, I would like to inform you that Newfoundland has her radio hams and fans. We have a broadcast station located at St. John's, whose call is 8WMC, a 500-watt Marconi transmitter, operating on a wavelength of 400 meters, owned and operated by Wesley United Church. It is on the air on Sundays at 11 a. m. and 6:30 p. m. with church services; and during the past winter was on the air at 8 p. m., E.S.T. (now daylight saving time). It has been heard in England, as well as Canada and the United States. Congratulations are due to the Rev. J. G. Joyce for enterprise in establishing the first station in this country.

JOHN A. ROWE,

Box 33, Carbonear, Newfoundland.

Importance of Location

Editor, RADIO NEWS:

Our club receives many reports of bad and good reception. Usually, our answer to those reporting bad reception is to find a better location. We asked ourselves the question, "why is reception so noisy where we are?" Our answer was, "Probably it's the location." It *was* the location. For the past year DX had been spoiled by noise. We use a 10-tube World's Record receiver. About once a month DX was fine, but usually every time we let our receiver "loose" the hums, crackings, roars, etc., would pour in.

May I we moved to 7263 Coles Avenue. The first night, stations KFI, KPO, WEA, WGHB, WJZ, WGY, KRLD, KLZ, KOA, NAA, WNAX, KUSD, WSB, KFBU, KNRC, KWKH, KFVB, KFWO, and many others rolled in with plenty of volume and not a trace of QRM. Note that we hooked KFWO, Catalina Island, a 250-watter. So far, we have received KFWO seven nights out of ten.

At the old location, a 1-tube Aero short-wave receiver was also in use. The only stations hooked were KDKA, WRNY, WGY, and amateur 9DIM, Hartford City, Ind. (fone). Now our log includes stations 9CWK, Salina, Kan.; 9BWI, Fort Wayne; 9BCH, Joliet; 9BCI, Sheldon, N. D.; 9MM, Converse, Ind.; 8CXL, Dayton, O.; Canadian 3BT, Hamilton, Ont., and 1ABY, Leominster, Mass. All of these hams used fone, on the 80-meter band.

Taking this 1-tuber out to 7847 Euclid Avenue, Mr. J. K. Franklin, vice-president of our league, hooked code stations in districts 2, 6, 7, 8, and 9 (U. S.) Both of us

tuned in one night and made out amateur ej-7DD, Zagreb, Yugoslavia. We are trying to get a verification on this station.

Those are just a few of our own experiences in locations.

LELAND J. GILLETTE,

President Midwest Amateur Radio League,
7263 Coles Avenue, Chicago, Ill.

Why Keep It Secret?

Editor, RADIO NEWS:

Here's an open letter to Mr. Announcer: Did it ever occur to you that much of the enjoyment of the listener comes from knowing to whom he is listening?

Some of you remind me of the darkey who

THIS page belongs to the readers of RADIO NEWS. It is theirs for the purpose of discussing fairly and frankly the needs of broadcasting from the standpoint of the great public who listen in. The letters represent, not necessarily the editorial opinion, but that of the writers; who are, in the editorial belief, fairly typical of groups of opinion among the radio public. Make your letters concise and offer constructive criticism when you can; remembering always that there is something to be said for the other fellow's side. Address The Editor, RADIO NEWS, 230 Fifth Avenue, New York City.

went to the County Fair and got a chance to ride one of the parade horses. He was so clated that when he returned home he told his experience with great gusto.

"Yo, see, Mars' Best had to have some un to ride dat big bay hoss o' his'n in de parade. His spec'l man was sick-a-bed. So, when he see'd me lookin' at de hoss, he ask'd me if I c'd ride a hoss. 'You bet,' says I. So he said 'Come along,' and you bet I come. Dat hoss was de third in de line an' ev'ybody was lookin' at dat partik'lar hoss, but dey couldn't make out who was ridin' it. Dey kep' askin' 'Who is dat nigger on dat big bay hoss?' I never let on dat I he'rd 'em, not me. I jus' let 'em guess who 'twas. Dere I was, ridin' de best hoss in de line, an' I know'd who I was all de time!"

You may know who you are all the time; but many of your listeners do not. They may have just tuned in. Some of us have frequently listened until we were tired, only to hear "The next number will be So and So," and no mention of the station. We finally turned off in disgust; and you have missed letters you might have received if we knew who you were. If we knew we were getting DX, we would try harder to pick you up distinctly, and it would be much more enjoyable.

In other words, what is the objection to

announcing your station clearly and distinctly after each number? It would not offend your old friends, and it would make you many new ones. Respectfully,

LISTENER,

Brooklyn, New York.

(It is evident that this is a sore point with many listeners, from the number of letters received from those who demand that the announcements be made, as the radio regulations provide. Incidentally, letters are published without the writer's name, at times; but they must carry names and addresses for the editorial information, to receive attention.—EDITOR.)

Radio Is For Men Only

Editor, RADIO NEWS:

Of course you want to increase your circulation; but do not by any means turn your valuable magazine into an art gallery of pictures of radio artists and announcers, etc. You cannot make RADIO NEWS appeal to women unless you leave out the radio entirely, and then the men will not buy it. I know whereof I speak.

One fault is this: when describing an old set or a new one, why do you not tell what stations it has received in a test? You entirely omit this for some reason (Not always; unfortunately there is no method of standardizing reports of DX reception. It will differ not only from day to day, in this sunspot period, but also from block to block in this city) and it is very interesting to amateur and professional set builders. Or, if not a complete list, you could easily mention a few of the stations and how easily it separates DX from local stations. (Any modern set, it goes without saying, will separate stations 10 kc. apart; none can be expected to separate completely stations operating on the same wavelength. The point, therefore, on which emphasis is now placed is quality.)

You will have to appeal to radio fans and the young boys who are just starting in. To do this give them a radio course in simple, comprehensive language. I have always bought your magazine and always will, but I hate to see it go to appeal to women.

T. H. HENEKER,

9 Warren St., Newark, N. J.

Wishes Opera In the Original

Editor, RADIO NEWS:

E pluribus unum! Mr. C. Adams has my profound sympathy, and you, Mr. Editor, know who said: "Every one to his taste."

Granting that the different operas were sung in English, I doubt that they would be more understandable. Only this afternoon I tuned in a tenor solo from WCCO—

(Continued on page 277)



TRANSMISSION INTERVAL



CALLER: "Is Mr. Jones in? This is Mr. Smith, who has come to see him."
 BUTLER (a radio enthusiast): "Yes, sir; will you kindly stand by for a moment?"

—Mollie Zacharias.

THE ONLY DRAWBACK

Radio is a wonderful source of entertainment and pleasure. We listen in every night; when we are away, we may miss a concert, but when we are at home — never! Concerts, fights, entertainments, news of the day, in short everything that is broadcast, we get. We sit and listen in, and sometimes late at night we lie in bed and listen to the radio. That's just the trouble—we can't climb across the airshaft and turn it off!

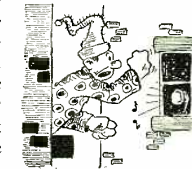

—Virginia Rinker.

FORCE OF ATTRACTION

A Scotchman recently admitted into a London hospital had his head jammed down the horn of a loud speaker. It was afterwards ascertained that, in the church from which the service was being broadcast, the collection box had been upset.



ONE ACCESSORY LACKING



OLD LADY (returning recent purchase): "I've tried every possible way, but I can't get any stations with this loud speaker."

SALESMAN: "I'm sorry, madam. What make of set are you using?"

OLD LADY: "Set? Oh, I haven't got a set!"

RADIOTIC REPARTEE



HAM: "Man, yo gal's so dumb she thinks a plate supply's a dish factory."

SAM: "Go on, fellow; that spade yo' all promenades with ain't got sense enough to squeal when she gets

tickled."—E. H. Foley.

REMOTE CONTROL

A Radio Announcer named Bevan Was motoring with his family of seven; When the steering gear broke He said to his folk— "We're now changing over to Heaven."

—Popular Wireless (London)



ON WHICH THE SUN NEVER SETS

TEACHER: "What country is farthest from us?"

WILLIE (a will-be "ham"): "Why, DX!"

—Manir Mansour.



ONE IZAAK WALTON NEVER HEARD OF

FARMER BOY (returning from fishing): "That city feller must'a been foolin' me when he said he had a lot of luck fishin' for 'DX' up here. I ain't caught one o' the darn things yet."

—H. N. Webster.



A PUZZLING CIRCUIT

NEWLYWED: "Now, dear, I'm sure you can learn to cook by radio."

MRS. NEWLYWED: "All right, Freddie, you hurry and hook up the radio to the range while I run down to the grocer's."



—Robert Schrock.

FOR RAINY MONDAYS

An enterprising housewife puts the clothes-horse in front of the loud speaker whenever political speeches are broadcast. A novel method of drying the washing by hot air.

—Popular Wireless.



RADIO RHYMES.....

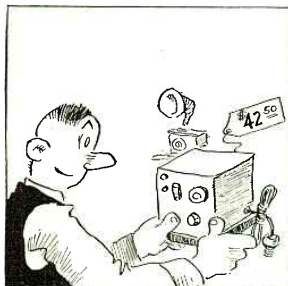

THIS POWER UNIT WE HAVE HERE, I MUST CONFESS, IS VERY DEAR, ---



IT'S GUARANTEED TO GIVE NO NOISE TO SPOIL THE RADIO LISTENER'S JOYS --



AND NOW IT'S HOOKED UP ALL AROUND, - BUT, DARN IT ALL!... THERE'S NOT A SOUND!



SOMEHOW IT'S JUST A LITTLE BIT TOO NOISELESS NOW, I MUST ADMIT!

A Britisher Chats on Radio

Our Cousin Sheds a Few Tears Upon Our Shoulders and Tells the History of the Rise of a Radio Empire, Now Tragically Turned Into a Democracy



By E. Blake

I AM not quite sure whether I have ever met a real American—in even New York or Boston, the only parts of the U. S. A. I have visited. My trouble is that America is such a big, populous country, and contains so many different kinds of people. Assimilation is still in progress, and there is no use of my trying to get at the true American outlook from a person born in Europe and naturalized in America only a few years ago.

Ethnologically speaking, I suppose the true American is the famous Mr. Lo, the tinted inhabitant of an Indian "reservation." Historically considered, the genuine descendant of a "Plymouth (*Pilgrim*) Father," a Dutch settler, or a Virginian colonist is, I presume, the real goods. Politically, the person who is a subject of the American Government, is the American. Which am I to choose? I want to find the man who can tell me he is "plumb" American from skin to spinal cord—and then I know where I am.

Oh yes! I'm talking radio right enough, but I have to work up to it gradually in this article, because I propose to treat of Radio and the Home—which means wives, and daughters, sons and kid brothers, the dog and granny and aunts and parrots, cats and relations and domestic "helpers" and hinderers. A delicate subject, God wot! But first I must separate out (that's a chemical term) the guaranteed, "honest-to-goodness," American "old man" aged anything from 25 to 101. Then he and I can get together and talk 'em all over.

OUR LITTLE DISAGREEMENTS

Two bachelors can be worlds and centuries apart; two husbands and fathers, of whatever nationality, can be blood-brothers—especially if they make radio sets. That's my plank in this campaign.

I met a U. S. A. naval radio man in Boston in 1910, who gave me of his best. But he added a trip to an old hulk in the harbor, and gloated as he told me that she had licked the British frigate—I forget the name ("*Guerrière*"—Error)—in—I forget the date (*August 19, 1812*). I doubted not his word, but I felt that we did not get much forrarder. I would much rather have forgotten the quarrels of our ancestors and have drunk a bumper to the future of the Anglo-Saxon race and its amazing adventures in life. But no doubt he thought he was doing the right thing. What's the use of rubbing it in? After all, battles are not solely a matter of valor, for most men are brave; they depend for their results on luck, on the weather, on the idiocy of the generals,—and on all manner of variable factors. History pursues its inexorable way and philosophic humans have to make the best of it. That's how I see it.

Well, I suppose I must select an average specimen of American manhood, imagine him to be a builder of sets and a keen critic

of programs, and address myself to him. But I want one who does not believe that his "opposite number" over here says "Bai Jove" and "Dontcherknow," or that we customarily add *aitches* to unaspirated words. As a matter of fact, the speech of the English middle-class is appallingly proper, and it is only the aristocracy who dare to take liberties with the language. And it is a tribute to the U. S. A., that many of its common phrases pass as current coin in this country. Witness "hook-up," "dope," "on the air," and many others, all equally atrocious but attractive to the common man. Especially "go-getter."

AND OUR TRIBULATIONS

Now I ask my U. S. A. fellow-fans to follow the dotted line of my domestic radio experiences and to judge thereafter whether we are not fellow-sufferers. One touch of matrimony makes the whole world kin!

I first introduced "wireless" apparatus into my house in 1919. There was no "broadcasting" to be had and, consequently, the family exhibited no glimmer of interest, except my eldest girl, who was "tickled to death" (U. S. A. language, you see!) when the valves (*tubes*) lighted up. She was aged five, and had heard the Zeppelin bombs seeking her life, and the British anti-aircraft cannon defending her sweet baby body.

It was, strange to say, a seven-tube set, commercially made, and was capable of do-

ing wonders on a loop aerial a foot square. At that period daddy was just an eccentric sort of person who made silly noises (*dah dah dee dah*) and spilt acid on the carpet and raved madly when sensible wives and five-year-old kids wanted to read about faires. It was all strictly professional, and "Hush! daddy's busy!" Even signals from a liner at sea failed to thrill that most critical of all critics—the family. No, on balance I was decidedly not popular at home in those days because my radio work was just "shop"—a scandalous extension of business into the sanctuary of home.

One of the biggest disappointments that I have ever had to swallow was the inability of my wife—most intelligent and liberal-minded of women—to appreciate the beauties of the functions and performance of my loop-aerial, which I explained and demonstrated, using Ushant coastal station's signals most successfully. When, like Mark Anthony, I paused till my heart (in the loop aerial) came back to me, my lady remarked, "That cat's got every sign of the mange. If I were you, I'd see about it." What I thought, translated into American, was "Dog my cats!"

Progress continued to progress and, somewhere about 1922, the Marconi Company, by the grace of Providence, the British Post Office and goodness knows what not, was actually allowed to broadcast for—hold your breath—fifteen minutes per
(Continued on page 262)



"The little blighter took a flying leap and landed in Grandma's lap, provoking the old lady to utter tremendous criticisms of 'these new-fangled contraptions!'"

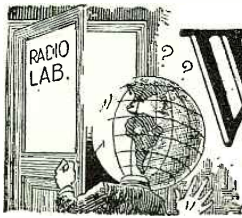

What's New in Radio



A Voltage-Divider for All Power Units

THE design of the voltage-divider of a "B" socket-power unit is one of the most difficult problems for the average radio constructor. In order to operate efficiently, radio receivers must be provided with the proper plate and grid potentials and, if the voltage-dividing resistor has not been properly designed, the voltages are likely to be far from the required values. This is one of the most frequent causes of trouble in home-constructed radio outfits.

In order to provide the proper voltages, a fixed voltage-dividing resistor must be designed especially for the receiver and power unit with which it is to be used. For example, if a given power unit provides 90 volts from one tap of the voltage-dividing resistor when used in connection with a six-tube receiver, the same power unit will provide a much lower voltage from this tap if an eight-tube receiver is used. Also, the voltage would be higher if only four tubes were used.

Fortunately, there is a simple solution of the problem discussed in the preceding paragraph. It is entirely practical to have the total resistance of the voltage-dividing resistor the same for all sets, providing the power unit delivers an approximately constant output voltage; but the taps must be connected at different points on the resistor for each individual receiver. Therefore, a voltage-dividing resistor for use with any type of receiver may be made by providing the resistor with the necessary number of slider contacts instead of fixed points of contact. With this type of device each potential may be adjusted to the required value. A new factory-made voltage-dividing resistor of this type is shown in the diagram and pictures on this page.

From the pictures it may be seen that the voltage-dividing resistor under discussion has five knobs. Three of these are for

adjusting the "B" voltages and the other two for the "C" bias potentials. The diagram shows how the device is connected. It consists of three resistor units (A, 8,000 ohms; B, 2,000 ohms, and C, 1,000 ohms)

potential between 65 and 110 volts; the "B"+ 45-volt knob will provide any potential between 20 and 65 volts; the "C"— 9-volt knob will supply negative potentials from 1 to 20 volts, and the "C"— 40-volt knob will supply negative potentials from 20 to 40 volts.

The voltage divider is 6 3/8 inches square by 1 inch high, and presents a very pleasing appearance. It is made of molded bakelite and is provided with a metal base and four holes for mounting. Also, a bracket is provided for ver-

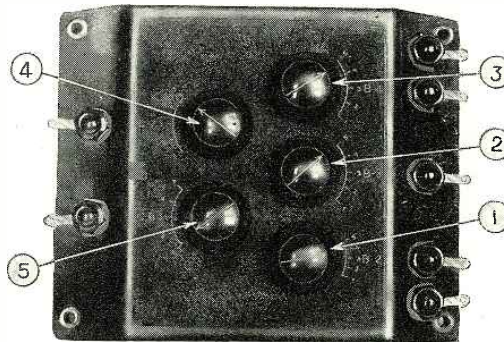

The five knobs on the panel of the voltage divider are for adjusting the various plate and grid potentials. Knobs 1, 2 and 3 control the "B" voltages, and knobs 4 and 5 control the "C" voltages.

connected in series. The free terminals of resistors A and C are connected to binding posts which connect with the output of the

tical mounting in either of two positions. All three resistors are of the wire-wound type. Resistors A and C are each 4 inches long, 5/8 inches in diameter and have a rating of 50 watts. Resistor B is much smaller, as it is required to pass very little current.

Manufacturer: Electrad, Inc., New York.

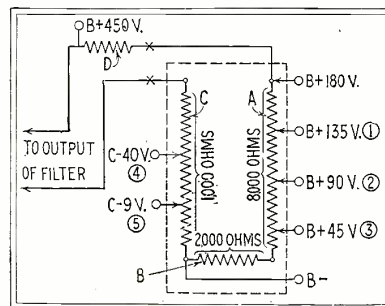

This diagram shows the method used in connecting the sliders and resistors inside the voltage-divider unit.

filter circuit, if the power unit is designed to supply 180 volts at the highest tap. (Where power units with a higher output are used, the resistor D is inserted in the circuit to reduce the voltage across the resistor to 180 volts). Also, the wire joining resistors B and C is connected with a binding post which provides the B minus terminal.

With the resistor connected as shown in the diagram the exact required voltages for the various tubes may be obtained by adjusting the five knobs. The "B"+ 135-volt knob will provide any potential between 110 and 160 volts; the "B"+ 90-volt knob will provide any

Plug-In Coils Easy and Safe to Handle

A NEW design of short-wave plug-in coil, which will be of interest to radio amateurs and experimenters, has been recently placed on the market. The coils are wound on improved forms and are equipped with UY-type (five-prong) bases; thus providing a number of advantages which have not been available previously in interchangeable-coil construction. The coils are distributed in sets of five and will cover the broadcast as well as the short-wave bands.

Tube-base coils for short-wave reception have aroused considerable interest during the last few months among radio amateurs and experimenters. They are very convenient and possess several features not found in the usual design of plug-in inductors. The tube-base forms are necessarily compact and of rugged mechanical

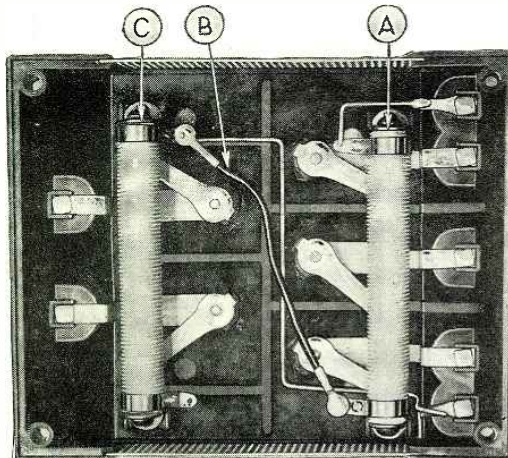

The five sliders shown in this interior view of the voltage divider make contact with the wire-wound resistors A and C, and render it possible to obtain any five desired intermediate voltages.

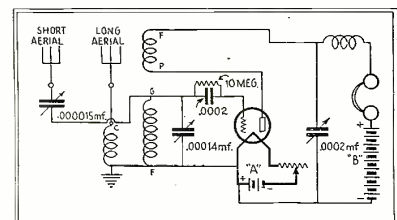

The circuit above has been designed for use in short-wave sets employing plug-in coils of the type illustrated on the following page.

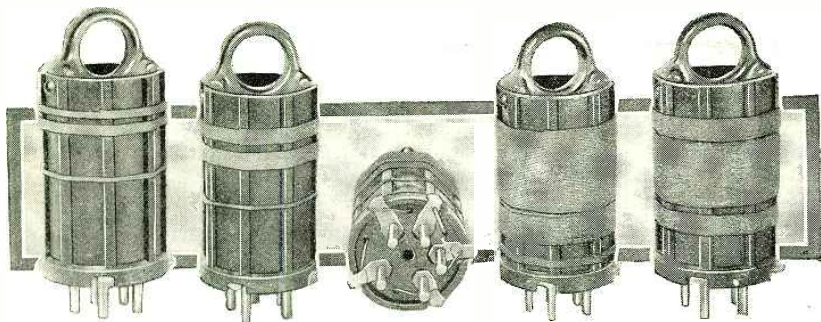

This set of five plug-in coils provides a receiver with a wavelength range of 17 to 500 meters. The coils have three windings each, and the coil forms are equipped with standard UY-tube-base prongs.

construction, and the tube sockets used as receptacles are inexpensive and easily obtainable.

In most of the tube-base coils which have appeared on the market only two windings have been provided, a tickler and a grid coil. The fact that the standard UX tube base has only four terminals makes it impossible to connect a greater number of windings, and in some cases this is a disadvantage; as, frequently, a circuit will require three windings. However, the tube-base coils illustrated here have three windings; primary, secondary and tickler, and the necessary terminals are obtained by using a UY-type five-prong tube base. Connection is made to the three coils through five contacts by connecting together one primary and one secondary terminal. This is not a disadvantage, as practically all circuits require that this connection be made.

Aside from this feature, the coils possess other interesting points of merit; the forms on which they are wound are of ribbed construction, thus decreasing self-capacity and resistance by reducing the area of contact between the wire and the dielectric. The diameter of the form is slightly larger than the usual tube base and, as a result, the coils are of a more practical size and may be wound for broadcast reception. The coils are fitted with colored handles which facilitate their removal from the socket, as well as provide a system of identification. Each coil in the set of five is equipped with a handle of a different color.

The circuit which should be used with these coils, together with the electrical constants of all parts, will be found in a diagram on page 212. When used in this manner the coils make possible reception on all wavelengths between 17 and 500 meters. Their ranges when used with a .00014-mf. tuning condenser are as follows: red coil, 17 to 30 meters; orange coil, 30 to 52 meters; yellow coil, 48 to 105 meters; green coil, 93 to 203 meters and blue coil, 200 to 500 meters.

Manufacturer: Pilot Electric Mfg. Company, Brooklyn, N. Y.

Electrodynamic Speakers for A.C. Operation

GREAT interest is being caused in radio circles at the moment by the electrodynamic speakers which are beginning to appear on the market in large numbers. Speakers of this type possess many features not found in the usual design, and are becoming very popular because of their ability to handle greater volume with less distur-

tion. They are made in a number of different designs, and one of the latest designs presented is shown in an illustration on this

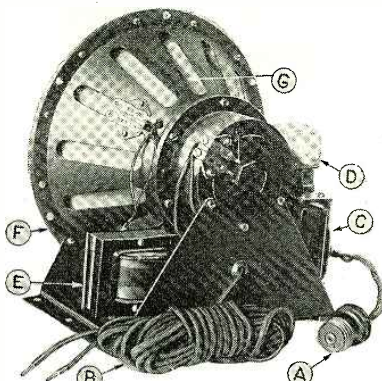
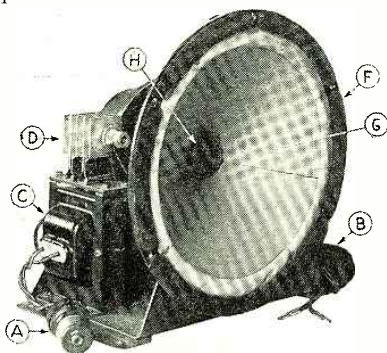

The step-down transformer C and the rectifier D make possible the operation of this electrodynamic loud-speaker unit direct from the 110-volt light socket.

page. The most interesting feature of this unit is that it may be operated directly from 110-volt A.C. without the necessity of an external source of direct current.

In the electrodynamic speaker a large electromagnet is used in place of the usual permanent magnet, and the field coil of this magnet must be supplied with a source of D.C. for its operation. Secondly, instead of employing the usual iron armature to

The A.C.-operated power amplifier shown on the right is entirely self-contained within a sealed metal chassis. For its operation it requires three amplifier tubes and one rectifier.

produce sound vibrations, the electrodynamic speaker has in the field of the electromagnet a moving coil to which a small free-edge cone is attached directly. The output energy from the radio receiver is passed through the moving coil, causing the coil, and with it the free-edge cone, to vibrate with the signal. As the design of the magnets is such that there is nothing to limit the movement of the coil or cone within a wide range, the speaker is able to produce enormous volume without overloading and without appreciable distortion. Therefore, this type of speaker is eminently satisfactory for use with the modern radio power pack which delivers sufficient energy to overload the average permanent-magnet type of speaker.

In the speaker described in this article, provision has been made for operating the field coil directly from a 110-volt A.C. supply. The speaker is equipped with a built-in step-down transformer and rectifier, which converts the A.C. into D.C. of the proper potential, and in this way avoids the necessity of operating the speaker with power supplied by the "A" or "B" socket-power unit. The rectifier used for the purpose is of the dry-electrolytic type, has a very long life and requires no attention whatsoever.

In the pictures on this page the mechanical construction of the speaker is clearly illustrated. It will be noticed that the entire unit is mounted on a metal chassis, and that it is supplied with two outlet cords; "A," for connection to the 110-volt lamp socket, and "B," leading to the loud speaker binding posts of the set. In the picture C is the step-down transformer; D the rectifier element; E is a step-down output transformer for the receiver; F is the metal frame for the cone; and G is the free-edge paper cone with the apex at H. The speaker will be available either as a separate unit or in an attractive cabinet.

Manufacturer: The Rola Company, Oakland, California.

Amplifier Unit Provides Great Output

THE light-socket-operated power amplifier illustrated just below may be employed for many useful purposes. It differs from the usual devices of this type, inasmuch as it provides its own operating power but does not supply current for the operation of the receiver; and this is claimed as one of its most important features. The amplifier consists of an "A-B-C"

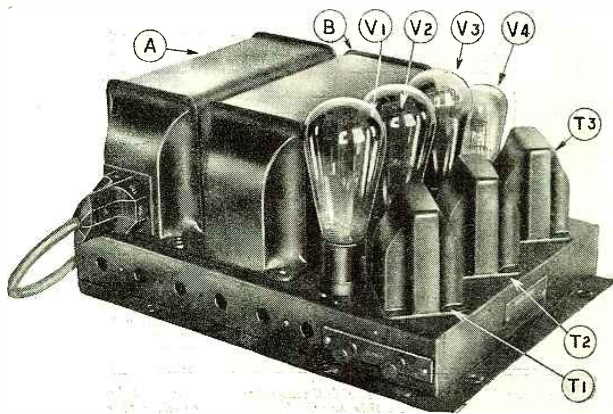

power-supply unit and a standard audio amplifier stage followed by one of push-pull amplification using 210-type tubes. The unit is very compact in size and uses four tubes.

In the power amplifier under discussion, each part has been constructed to work with all other parts of the amplifier. This method of design has made possible many economies in construction; it has also made the circuit simpler and the unit much more compact. As the exact amount of current required is known, the power transformers and the filter choke coils and condensers are made without allowing as large an overload factor as otherwise would be necessary. Also, because all parts of the unit are constant, the potentials provided by the power circuit are the exact values needed.

The appearance of the power unit is clearly shown in a picture on page 213. It will be seen that all parts are mounted on a steel chassis which measures 11 x 15 inches, and that all wiring is concealed within the chassis. The power transformer and filter choke coil are housed in unit "A," which is mounted on the left edge of the chassis. The condensers of the filter circuit and the by-pass condensers in the voltage-dividing circuit are in unit "B." T1 is a standard audio transformer, T2 is a push-pull (input) audio transformer, and T3 is a push-pull (output) audio transformer. V1 is a rectifier tube of the 281 type, V2 and V3 are 210-type power tubes, and V4 is a 227-type tube.

The power unit is made in two different types which are identical in appearance, but which differ slightly in circuit design. Type A may be used with any standard type of loud speaker, and type B is for use only with an electrodynamic speaker having a 100-volt 50-milliamperere field winding. The schematic wiring diagram shows the difference between the two types; in type A binding posts are provided for supplying current to the speaker field winding, and in type B a resistor is inserted in the circuit in place of the field winding.

From the diagram it may be seen that the circuit is standard, aside from the fact that all variable controls have been eliminated,

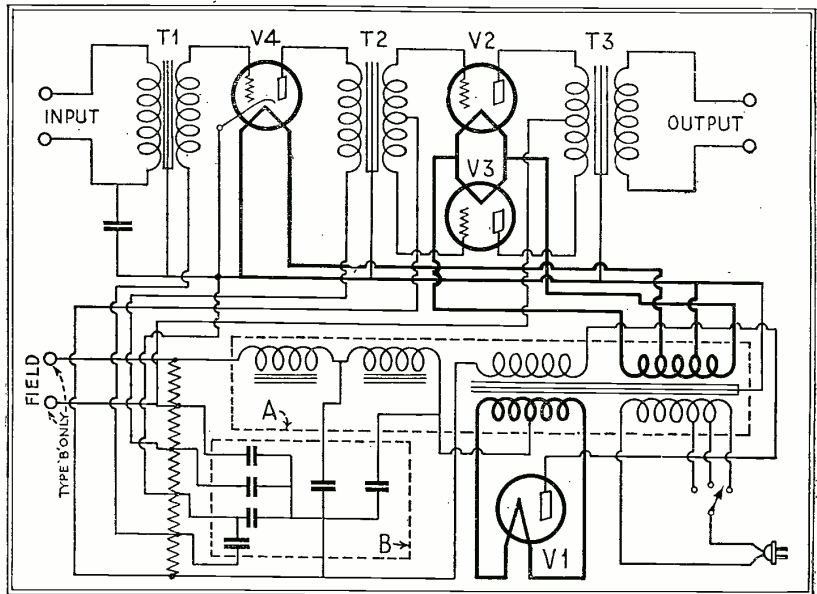

This diagram shows the complete circuit of the new A.C.-tube electric two-stage, push-pull, power amplifier described on this page. It uses a 227-type tube in the first stage, two 210-types in the output, and a 281-type as rectifier.

except one which is a plug switch regulating the power input to the primary of the power transformer.

It is also evident from the diagram that

put the plug in a standard light socket. Manufacturer: Samson Electric Co., Canton, Mass.

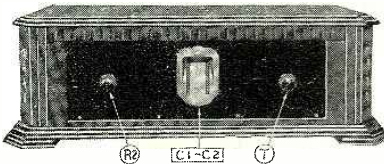

The illuminated-drum dial is the only tuning control of this new A.C. kit set; R2 is a volume control, and T is the regeneration knob.

the power unit is very simple to install. It is necessary only to connect a loud speaker to the posts marked "output," connect two wires from the radio receiver (detector or first A.F. stage) to the posts marked "input," insert four tubes in the sockets, and

An All-Electric Four-Tube Set in Kit Form

THE engineers who designed the new kit set described in this article endeavored to develop an all-electric receiver which would possess operating characteristics measuring up to present-day standards and which could be constructed at low cost. At the same time, they incorporated in the design other modern features such as mounting the apparatus of the receiver and the power unit on the same chassis (thus making the receiver entirely self-contained) tuning the set with a double-drum control and reducing all other adjustments to a minimum, etc.

A glance at the circuit diagram will show that the old Roberts system is used; it has been popular for a number of years because of its simplicity, economy and high efficiency. Essentially, it consists of a stage of tuned R.F. amplification followed by a regenerative detector, and this combination provides excellent selectivity, sensitivity and ease of tuning. Also, a minimum number of parts and controls are required for its operation. Two variable condensers (C1 and C2) are used for tuning, a variable resistor (R2) in the plate circuit of the R.F. tube serves as a volume control, and the knob of the tickler coil (T) adjustment is the regeneration control.

The A.F. amplifier which follows the detector circuit is of the most modern type. It is a two-stage transformer-coupled amplifier with an output transformer in the plate circuit of the last tube. "C" bias for both A.F. tubes is provided by the power unit, and the last stage has been designed for power-tube operation.

In "electrifying" the circuit a socket-power unit of standard design has been employed to furnish the plate potentials, and a filament transformer is used to provide the A.C. supply for the tubes of the

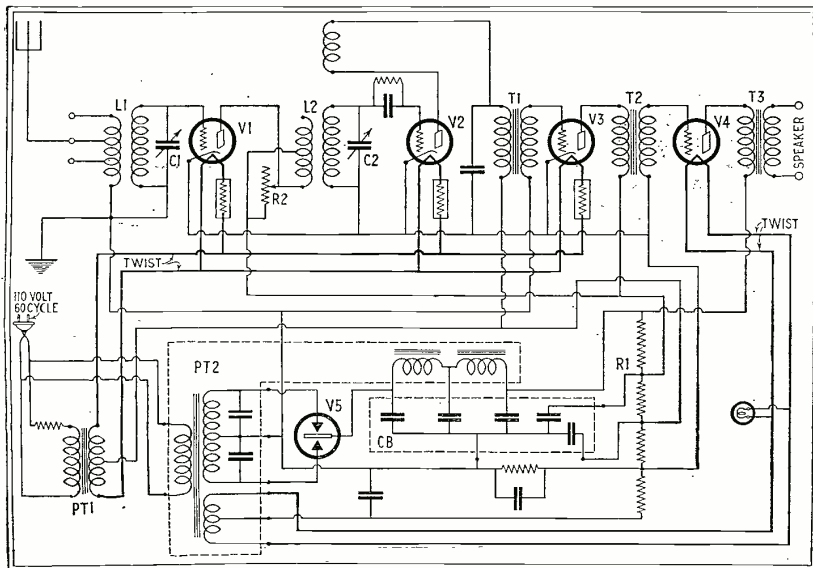

Four receiving tubes and one full-wave rectifier are used in operating the new A.C.-tube electric kit receiver described on this page. The circuit consists of one R.F. stage followed by a regenerative detector and two A.F. stages. Shielding is not required.

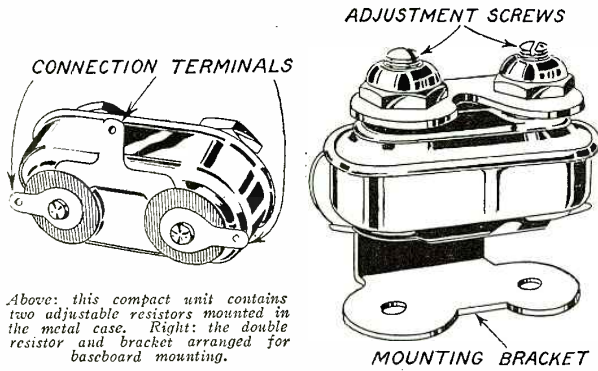

Above: this compact unit contains two adjustable resistors mounted in the metal case. Right: the double resistor and bracket arranged for baseboard mounting.

set. Three 227-type, heated-cathode A.C. tubes are used in the R.F., detector and first A.F. circuits; and a 171-type power tube in the second A.F. stage. The rectifier is a tube of the standard full-wave gaseous type.

The accompanying pictures of a set assembled from this list clearly show the arrangement of apparatus: on the baseboard, the parts used in the receiver circuit are mounted near the front, and the parts of the power-supply circuit are mounted on the rear edge. L1 is the antenna coupler, L2 the detector-circuit coupler, T1 and T2 are the two A.F. transformers and T3 is the output transformer. C1 and C2 are the two tuning condensers, R2 is the volume control and T the tickler knob. V1 is the R.F. tube, V2 the detector tube and V3 and V4 are the first and second A.F. tubes, respectively.

In the power supply circuits, PT2 is a combination unit which houses the plate-supply transformer and the two choke coils of the filter circuit. PT1 is the filament transformer which provides current for the 227-type tubes, CB the bank of filter condensers, V5 the rectifier tube and R1 the voltage-dividing resistor. There are no controls for adjusting the filament current, as this is accomplished automatically by filament ballast resistors.

The construction of the receiver is very simple. All parts are mounted on a wooden baseboard with wood-screws, and all wiring is located above the base. Shielding is not needed and, therefore, has not been used. The receiver is very compact in size, considering the fact that the cabinet houses both the set and the power unit. The front panel is 7 x 21 inches and the cabinet is only 12 inches deep.

Manufacturer: Roberts All-Electric, New York City.

Variable Double Resistor Very Convenient

ONE of the latest parts to make its appearance is a novel variable-resistance unit that lends itself to many important radio applications. Essentially, it consists of two resistors connected in series; each is of the variable carbon-compression type, and has a universal range of resistance (0-500,000 ohms). Three terminals are provided, so that the resistors may be used separately but with one terminal common to both.

A sketch on this page clearly shows the construction of the new resistor unit. It will be seen that adjustment is accomplished

by turning a screw with a screwdriver, thus providing a semi-permanent resistance; as the unit cannot be readjusted without tools. It is of very rugged construction, housed in a metal case, and very compact, the size being 1 x 1 1/8 x 2 inches. It may be mounted on a panel, on the baseboard, or in a number of different ways by means of a metal bracket which is provided.

A number of different ways in which this new device may be employed will imme-

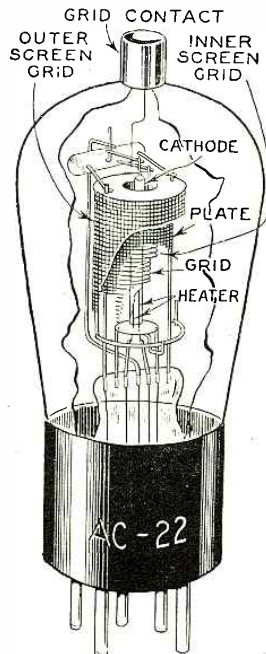

Mechanical construction of the elements in the new A.C. screen-grid tube; it has a standard UY-type (five-prong) base.

diately occur to the experimenter. First, it may be used as two separate and distinct variable resistors with a common connection. Secondly, with the two units in series, it is a variable resistor with an enormous resistance. Thirdly, with the units connected in parallel, it is a variable resistor with a lower resistance but greater current-carrying capacity. Fourthly, it may be used as a potentiometer with both a variable total resistance and a variable midpoint.

In actual practice there are many different ways in which a resistor of this type may be employed in a receiver. In A.C. receivers it may be connected across the filament wires to give the equivalent of center-tap connection. In audio amplifiers it may be used to convert a standard transformer into a push-pull transformer by providing a center connection. Also, in a two-stage resistance-coupled amplifier, it may be employed to replace the plate or the grid resistors. When speakers are operated simultaneously from the same receiver, it will serve to balance the resistances of the units. In "B" power-supply units it is applicable to the voltage-dividing circuit and for the purpose of securing "C" bias for the various tubes.

Manufacturer: Clarostat Mfg. Co., Inc., Brooklyn, N. Y.

New Tubes Present Many Interesting Features

THREE new types of vacuum tubes have been developed and placed on the market recently by a well-known manufacturer, to satisfy a demand which has been existent for some time, and will be welcomed by the experimenter. Two of the tubes are for A.C. operation and the third is a low-current-consuming D.C. tube. The tubes are known as the A.C. 22 type, the A.C. 40 type and the 01-B type.

The A.C. 22-type tube is a four-element screen-grid tube designed for A.C. operation; it is of heated-cathode construction and mounted in a standard UY-type (five-prong) base with the control-grid terminal mounted at the tip in the usual manner.

(Continued on page 273)

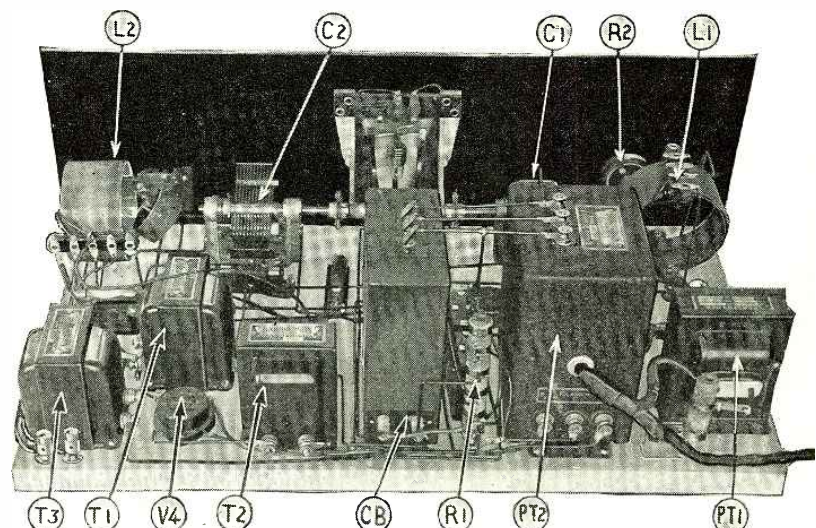

View taken from the rear of the new A.C. kit receiver, showing the arrangement of apparatus on the baseboard. The symbols refer to parts similarly marked in the wiring diagram and text on this and preceding page.

How Much Amplification for the Best Quality?

A Consideration of the Problem of Obtaining Even Reproduction of All Tones with Fidelity in Volume—Complicated Somewhat by the Peculiarities of Our Hearing

By C. Sterling Gleason

WITH the advent of the present great variety of power tubes, and the development of dependable and economical "B" power units, capable of supplying them with the necessary high voltage, increasing the output of any set has become merely a matter of inserting a larger tube in the socket and changing the connection on the "B" unit. Amplifiers are more efficient, less expensive, and capable of better reproduction of sound than ever before.

The application of shielding and the improvement of design have rendered multi-stage radio-frequency amplifiers entirely practicable. With the arrival of the screen-grid tube, through the use of which overall gains in the neighborhood of two million have been achieved, the very ultimate in efficient amplification is at hand.

Indeed, a definite limit to the amount of amplification that can be used is established by the *shot effect*, whereby the actual impact of electrons striking the plate overloads the detector. The fact that this point has almost been attained in the laboratory makes it clear that there is comparatively little yet to be accomplished in development along present principles.

Thus engineering progress has placed at our disposal an almost unlimited reserve of amplification. We are using today in the commonest household receiver, without thinking anything of it, values of gain which yesterday were beyond the brightest dreams of the most optimistic of engineers.

So far as efficiency is concerned, there is little left to be desired. As for quality, that is another matter.

In spite of the tremendous strides that have been made toward distortionless amplification, there yet remains a great deal of room for improvement before the loud speaker's version of a broadcast program shall be identical with the original. In the meantime, the tendency among set-builders is rather to overcome interference and blank out shortcomings by increasing volume; on the supposition that if the set is played loudly enough, deficiencies in reproduction will be unnoticed. If the quality is poor, turn up the rheostats, put on another "B" battery, add a power tube; enough quantity will make up for lack of quality.

THE HUMAN ELEMENT

Aside from the fact that it is poor economy to use eight tubes to do the work of six, there are definite physiological reasons why this policy is wasteful of human energy. The human nervous system is operated by energy discharged through the nerve cells. When a sound vibrates the sensory apparatus of the ear, a certain amount of "nerve current" is released over the circuit which leads to the brain. The louder the sound, the more the vital energy consumed. This energy has to be replenished by the blood. For this reason, life in the city, where the

hearing apparatus is constantly shocked by noise and confusion, involves a strain which drains the system of a great deal of nervous energy. A set which is harsh and jangling, which thunders at all times with ten times what would be a pleasant volume, is a source of fatigue no less actual than the fatigue caused by any mental work.

How much volume is desirable? Obviously, the quantity depends on the size of the room. Ordinarily, however, there is no reason why a loud speaker should supply more volume than is necessary to make it heard distinctly in all parts of the room. Does your set screech and shout? A good radio set is not rude. Teach it manners. It should not try to bring a whole symphony orchestra of a hundred musicians into an apartment hardly large enough for the bird cage and player-piano. How much energy goes into the microphone at the studio, after all? No more than a person standing in the same place would hear. Put yourself in the place of the microphone. If the volume is just sufficient to produce the same distribution of sound energy in your home as prevails in the studio, the illusion of the artist's presence will be at its best.

Even if a set amplified all frequencies equally, it would be impossible for the distribution of sound energy per unit of area (the sound *flux*, as it were) to be increased above the studio level without distortion. To

If the sound is increased above the level that prevails in the studio, the emphasis will be thrown upon the lower notes.

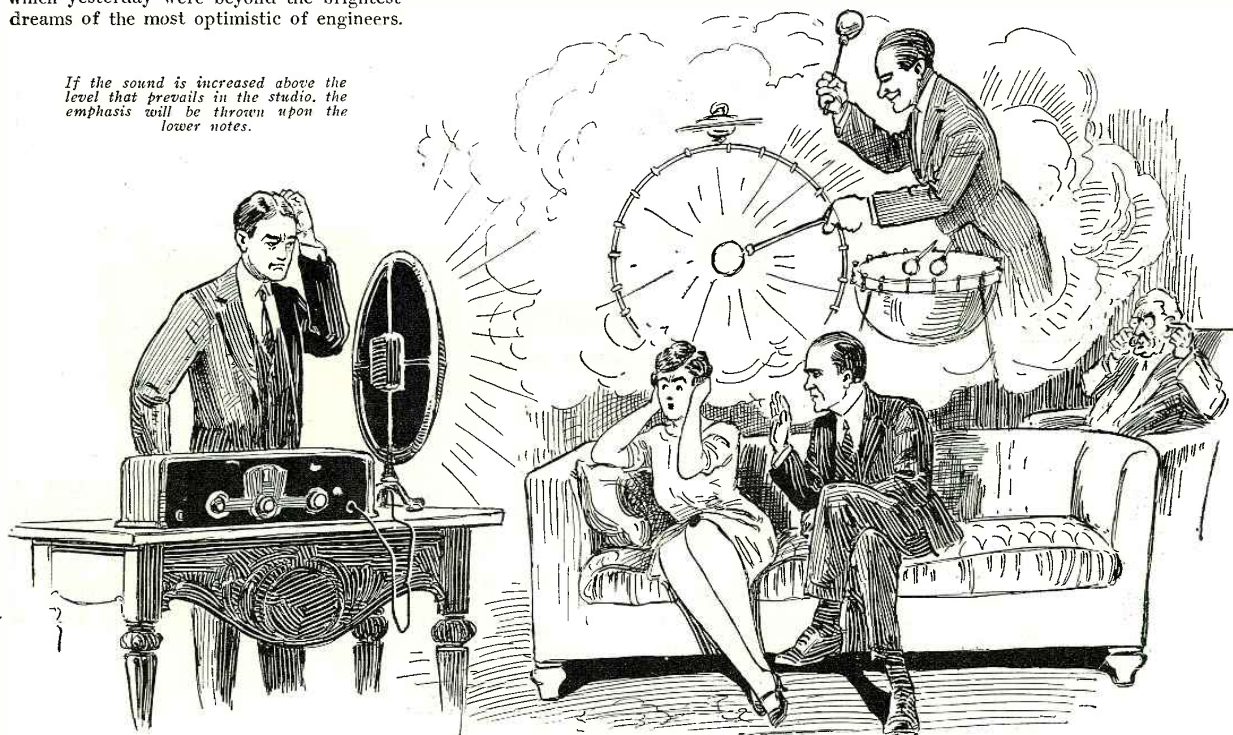

be sure, the various components of the speech currents would be still in the same proportion, and there would be no electrical distortion; but the ear itself is by no means uniformly sensitive over the scale. The variation from a flat characteristic depends not only upon the frequency, but upon the loudness or "sensation level" of the sound.

PITCH AND LOUDNESS

In the accompanying graph (Fig. 1) the frequency of sounds is plotted against a "weight factor," which is a measure of the extent to which the ear favors certain frequencies. Thus it will be seen that, at the lower levels of loudness, the higher frequencies give much greater proportionate sensation than the lower.

At the higher levels, the situation is reversed, the lower pitches becoming predominant in their effect upon the ear. The sensation level is measured in "sensation" units, indicating the strength of the sensation compared with the "threshold," which is the minimum value of intensity that will excite the sense of hearing.

When the speaker is being operated at the same level of sound that prevails in the studio, if the receiver is distortionless the various components of sound will be reproduced in their true relative proportions.

If the volume is increased above this value, the raising of the sensation level will throw the emphasis upon the lower pitches; if it is decreased, the higher notes will be exaggerated. This phenomenon manifests itself in long-distance telephone transmission, where the higher frequencies tend to be accentuated because of the reduction of sound level through attenuation or weakening of the currents on the line.

MR. GLEASON is already well known to our readers as the author of the "Harold Dare" stories, which combine a high degree of subtle humor with a very instructive exposition of the possibilities of many physical phenomena, and thereby form very entertaining, if not too serious fiction. This article, however, is serious as well as true; it is a very instructive discussion of the peculiarities of our hearing, and the necessity of conforming the design and operation of our radio sets and loud speakers to that of our somewhat untrustworthy ears. It brings home the fact that, to a limited extent, volume is quality; but not beyond a slight variation from the loudness of the original sound. It is also explained here why audio amplification alone, no matter how it may be increased in power, can never get away from background noises. We believe that practically every reader can profit by this article.—F.M.R.O.R.

It is one of the reasons why telephone systems are designed with a "cut-off frequency" of about two thousand cycles.

SELECTIVE "FADING"

The fact that there is a "threshold" value, below which a sound is too weak to be detected by the ear, is responsible for an apparent distortion which is, perhaps, often attributed to other sources. Let us suppose that, at New York City, the sound broadcast from a station has, at a particular instant, components in the proportions represented in the diagram (Fig. 2). At a

short distance, let us say one mile from the studio, where the receiver can bring the volume up to the studio level, these components will be audible in their true proportions. But suppose that the set is located at a distance of one thousand miles. If the intensity or radio waves varied no more than inversely with the square of the distance, as, approximately, is the case with other forms of wave motion, the intensity of each component of the wave would now be one million times less than before. If the amplification of the receiver did not overcome this, certain components of the reproduced sound might be reduced to a value that would be below the threshold of audibility. All frequencies in the upper and lower shaded portions of the diagram (Fig. 2) are now missing, so far as the ear is concerned. The quality of the tone has apparently changed.

If the intensity is reduced only one tenth as much, the frequencies of 128, 256, and 2,048 cycles per second will appear above the threshold, but those remaining in the lower shaded portion—the highest and lowest components—are still missing. The quality of the sound still suffers. If it be a piano tone, for example, it will lack resonance and appear flat and dull. If it be voice, it will be unintelligible.

Whereas the vowel sounds are composed largely of medium and low frequencies, the consonants, which are the most important factors in clearness of articulation, owe their characteristic sounds to the higher components. It is said that 50% of the mistakes in interpretation of speech come from the consonants *th*, *f*, and *v*. On the other hand, the short vowels, *u*, *o*, and *e*, carry determining characteristics which are frequencies below 1,000 cycles. As both the higher and lower regions of pitch are clinically

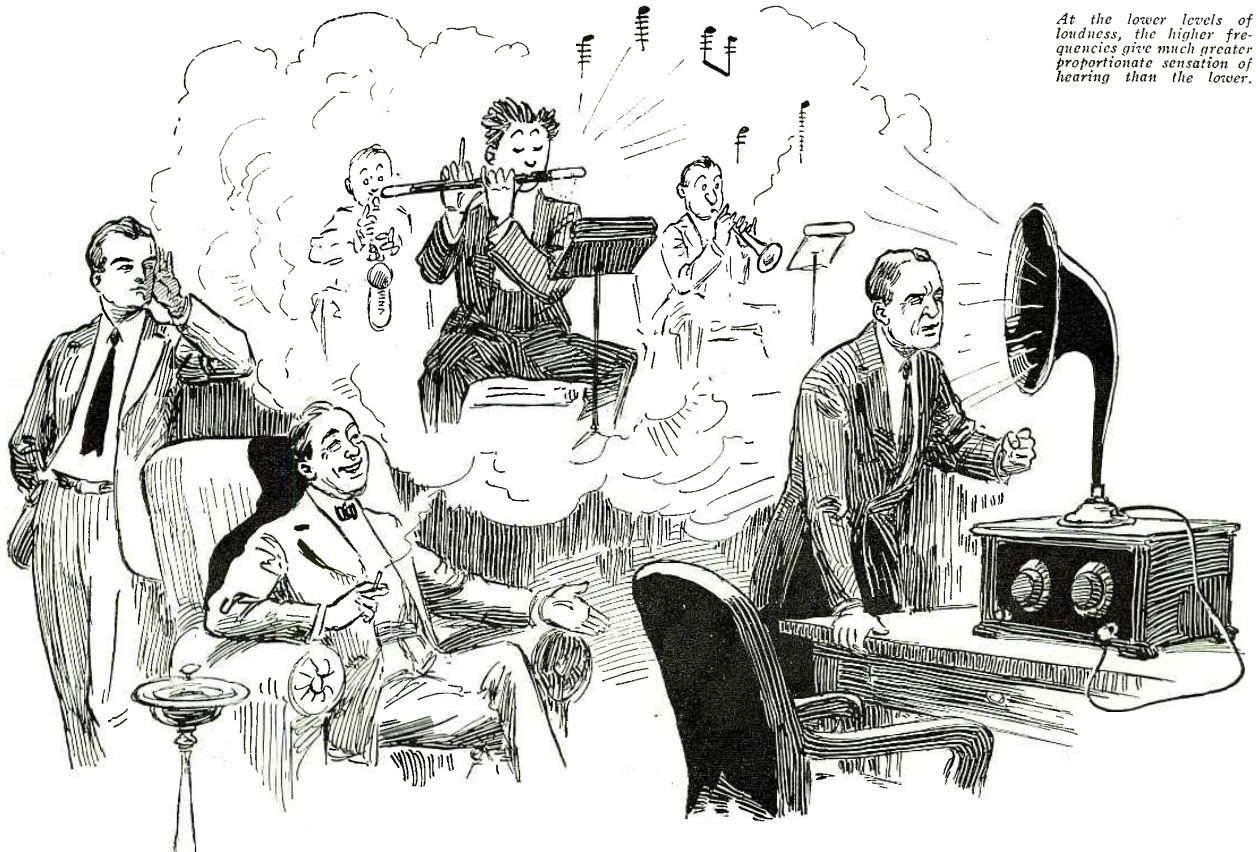

At the lower levels of loudness, the higher frequencies give much greater proportionate sensation of hearing than the lower.

nated, the sound loses more and more of its identity; until it merges into a common jumble of inarticulate vowel sounds and becomes mere noise.

ERRORS OF HEARING

Another aspect of the *non-linear response characteristic* of the ear, which has a considerable effect upon radio reception, is the variation of sensitivity with the intensity. This law, as expressed by the scientists Weber and Fechner, states that the strength of the sensation induced by a sound varies, not *directly* as the physical intensity of the sound, but *logarithmically*. The result of this is that at low sensation levels a very slight change in loudness is easily detected; while in the higher regions of volume a considerable increase is required for perceptibility of change.

Weber found that the same characteristic is approximately operative in the other human senses, such as feeling, sight, etc.; that *the smallest detectable change in a stimulus is proportional to the intensity of that stimulus*.

The range of audible sounds extends from a threshold of an almost infinitesimal fraction of a watt to an intensity a million million times as great, at which value the sensation of pain is excited. Yet the ear can recognize but about four hundred distinct degrees of loudness over the whole spectrum of intensities.

This limitation cannot be looked upon as a defect. The human ear was not intended for an audiometer, any more than the eye was made for a photometer. Primitive man was little concerned with the intensity in sensation units of the sound in the night which sent him scurrying to the shelter of a cave; he was interested wholly in the quality of the sound, which from experience he knew to herald the approach of a hungry dinosaur.

The fourteen thousand fibers comprising the *auditory nerve*, leading from the ear to the brain, must have a value more important than the mere measuring of quantity of sound. Discrimination of quality is the outstanding characteristic of both eye and ear. As few as two complete vibrations are often sufficient for the ear, to recognize a sound as a musical tone possessing pitch, rather than as a noise. In contrast to such sharpness, it may be noted that three sounds which appear to stand in loudness approximately in the ratio of 1, 5, 10, represent actual physical values of intensity of 1, 150 and 22,500. Nature has wisely provided man with a much greater sensitivity to small sounds; for in that range lies the greatest part of aural experience in the normal life of a human being.

THE BACKGROUND EFFECT

The characteristic of *logarithmic response* may have an important effect upon the apparent selectivity of a receiver. Let us suppose that, while listening to station WWWW, we are unable to get rid of a background from WWWW. The former has a signal strength of, let us say, one hundred units; the latter, ten. We add a stage of audio amplification which yields a net gain of 10. The signal strengths are now respectively one thousand and one hundred.

But to the ear, the stations sound in the ratio of the *logarithms of their intensities*, or three to two. WWWW has come up, from an audibility of one half that of

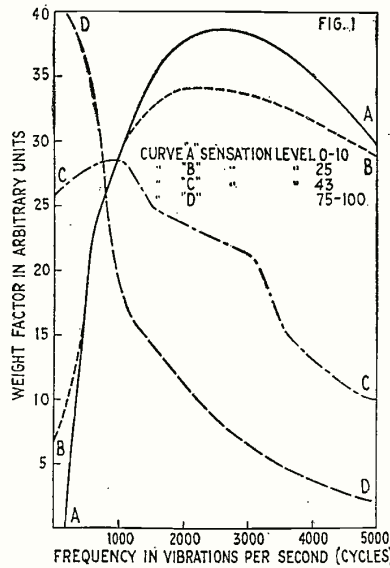

Curve A shows the response of the ear to very slight sounds—principally in the middle range of pitch. Curve D indicates that to very loud notes—the low notes overpower the high ones. The other curves are intermediate.

WWWW, to two thirds. The interference is more pronounced than ever.

Here is the real reason for amplification at radio frequency. If the stage be one of audio frequency, the situation is merely aggravated; but because of its selective effect, a radio-frequency stage can overcome this tendency. For the reason just stated, the background of extraneous noises, being also in the region of relatively small intensity, has the advantages when it comes to amplification. Thus the number of audio-frequency stages is at once limited to two or three.

Within certain bounds, the advantages of greater selectivity obtainable with radio frequency more than offset the ear's discrimination in favor of the weaker static

impulses; but the point eventually is reached where this factor has increased so much as to preclude further amplification. Thus it may be seen that theoretical selectivity, as measured by the ratios of the various receiver currents, is not the same thing as selectivity as the ear hears it. Neither is the much-discussed "noise-level" a background of fixed value, but a relative matter; nor is the so-called "getting down below the noise level" much more than an apt figure of speech. It is not amplification itself which makes this possible, but the properties of a good, sharply-tuned circuit which can select the frequencies which it is intended to amplify.

In the discussion of the noise level with relation to distant reception, the importance of keeping out extraneous noises, simply as a means to better quality, is perhaps lost sight of. The best audio-frequency amplifier is helpless against noises which are introduced into the circuits before the detector. The problem of noise is more serious than that of interference, so far as quality of reproduction is concerned.

How detrimental to satisfactory hearing are extraneous noises is shown by the fact that acoustical experts recommend that, for satisfactory results, the speech energy should be from one thousand to ten thousand times that of any noises. Again, the peculiar properties of the ear augment the distracting effect of interference. Experiments have demonstrated that a noise has twice the interfering effect of a musical tone.

Probably the reason for this is the irregular quality of a noise, which may give it a greater psychological "factor of advantage" in commanding the attention of the listener. And again compounding itself, the interfering effect of noise increases with the intensity, not uniformly, but at a steadily accelerating rate. Once more, it pays twice over to eliminate the noise *before amplification*.

CLEAR UP RECEPTION

The moral of this discussion is one that has been preached since time immemorial, yet its truth is ever timely. Until, at least, some genius gives to the world a successful static eliminator, our salvation lies in selectivity—the selectivity that comes from properly-designed circuits with few losses. True, care must be taken to avoid cutting sidebands; but with circuits on the order of the band-pass filter that is possible. All static eliminators that have had any degree of effectiveness have owed their success chiefly to their great selectivity. And, along with these factors of design, we can always help matters by weeding out noises which originate in the set itself.

Disconnect your aerial and trace down those set noises which add so much more to the background of static. Look at that grid-leak, those resistances, those unsoldered connections. Wipe the soldering paste from between binding posts; sandpaper the prongs of your tubes and brighten the contacts of the sockets. If your set is not shielded, put it into a wash-boiler and give it some protection against wiring pickup. Are the core and shell of your audio-frequency transformer loose? Here is a source of noise which, though rare, may be extremely annoying. Much noise originates in acid-corroded battery terminals and clips. A microphonic tube is an unceasing annoyance. If the loud speaker is placed too near

(Continued on page 262)

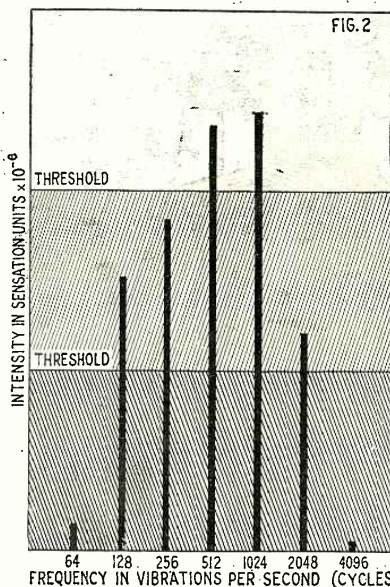

At the lower level, all pitches are audible. If the actual volume of sound is reduced a thousand times, the ends of the scale are lost. If it is reduced a million times, only the middle notes are faintly audible.

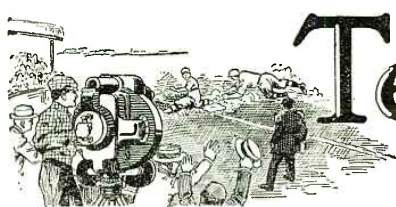

Television

Under this heading, RADIO NEWS publishes each month descriptions of the latest developments in the extremely interesting field of television,

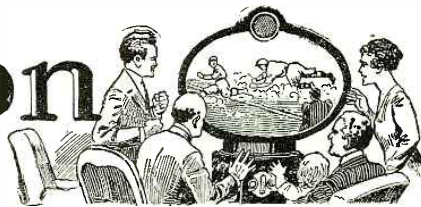

Successful Television Accomplished on Broadcast Band

ALTHOUGH the opinion has been expressed, by many radio engineers and government radio experts, that television on the regular broadcast band is practically impossible of accomplishment because of the 5,000-cycle modulation limit under which all broadcast stations operate, a group of Chicago experimenters has actually performed the feat to the satisfaction of a number of that city's radio experts and leading television skeptics. A highly-successful demonstration was given late in June, the transmitting being done through station WCFL on its regular 620-kilocycle wave. The receiving was done with a commercial neutrodyne installed in a club house several miles from the Municipal Pier, on which WCFL's transmitter is located.

E. F. Nockels, secretary of the Chicago Federation of Labor, was the subject who was "televised." Several of his friends who witnessed the demonstration in the club room had no difficulty in recognizing the image of him that appeared in the receiving apparatus, yet the operators in charge of the equipment stated that not only did the television signals stay within the legal 5,000-cycle limit, but they seemed actually sharper than ordinary voice and music impulses.

The television transmitting equipment used for this demonstration, and also a test receiver employed for experimental work in the WCFL laboratory, are shown in the pictures on this page and the following one. The apparatus was designed by Ulises A. Sanabria, a young experimenter who has been working quietly on television for the past five years, and by his assistant, M. L. Hayes. They have had the helpful cooperation of Virgil A. Schoenberg, chief engineer of WCFL. No pictures were taken of the television receiver actually used for the radio demonstration, but a good idea of its construction may be obtained from Fig. D, which shows a duplicate of the model.

CONSTRUCTION OF THE TRANSMITTER

In general arrangement, the television transmitter used by Sanabria is a development of the well-known Ives system, but it is considerably simpler than the complex machines used by the Bell Telephone Laboratories and the General Electric Company in the demonstrations these companies gave during the past year. Fig. D shows the complete instrument set-up at WCFL. The transmitter, the parts of which are designated by the letters P, L, D and A, is in the background, while the "check" machine, which is a television receiver connected by direct wire to the transmitter for monitoring purposes, is in the foreground.

As shown in Fig. A, the first unit of the television transmitter is a powerful spot-light, A, which may be an arc light but

which in this case is a 1,000-watt mazda lamp inside a protecting case. Revolving in front of the aperture through which the light of this lamp issues is a disc D, drilled with a spiral of tiny holes. The synchronous motor M drives this disc through the belt B. An important feature of the mechanical construction is the weight and rigidity of the parts; the shaft to which the disc

is attached revolves in ball bearings in a heavy cast-iron frame, which in turn is bolted to a massive cast-iron base which also supports the driving motor. The disc itself is of thin metal, but faced with two flanges $\frac{1}{2}$ -inch thick, which overcome any tendencies on its part to wobble. As pointed out in the article on page 222 of this number, a variation of this kind, if allowed to develop, will ruin the transmission.

After the light from the lamp passes through the holes in the disc, it is concentrated by a powerful condensing lens, L, in such a manner that tiny pinhead beams are projected straight forward. One such beam is indicated by the dotted line in Fig. A. Of course, as the disc revolves, a continual series of beams will be thrown forward.

The person to be televised sits in a shaded booth (See Fig. B), facing directly into the lens, but about four feet from it. In front of him is a large wooden box with a square hole in its center to allow the light to pass through. Surrounding this opening is a bank of four photoelectric cells, marked P in Fig. D. A close-up of this booth and the photoelectric-cell box is shown in Fig. B, with Mr. Hayes acting as the subject.

TELEVISIONING A SUBJECT

The operation of the apparatus now becomes evident. As the disc revolves, it



M. L. Hayes, seated before the photoelectric cells of WCFL's television transmitter.

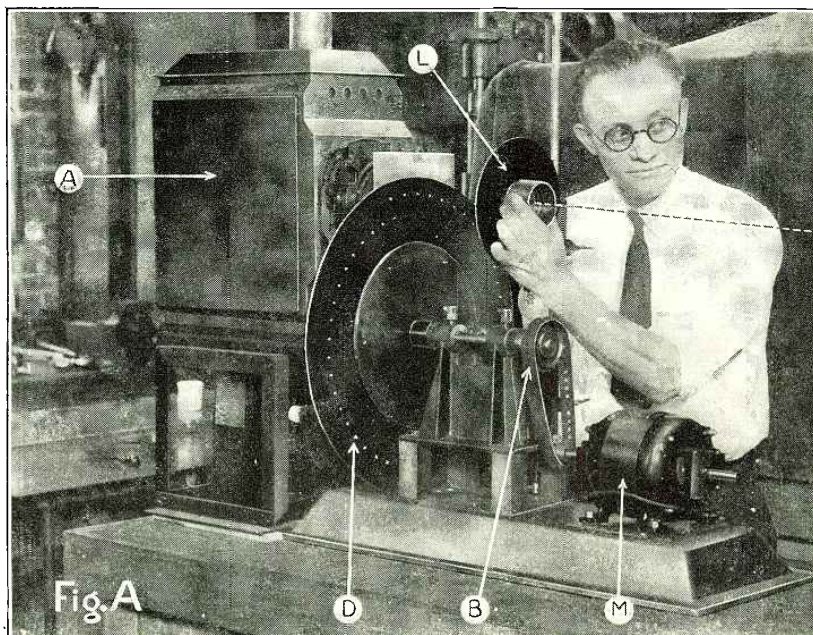

A close-up of the disc assembly: A, 1,000-watt lamp unit; D, scanning disc; B, driving belt; M, driving motor; L, condensing lens. The dotted line represents a beam of light as it is directed upon the subject's face.



U. A. Sanabria, left, and V. A. Schoenberg, right, showing the difference in size between an ordinary photoelectric cell and the large type used at WCFL.

causes beams of light to pass over or "scan" the face of the person sitting in the booth. Because of the spiral arrangement of the holes, (48 holes were used in this particular disc, which is of 24-inch diameter), each beam starts at a slightly lower point than the preceding one; with the result that the face is "swept" by a series of concentric

arcs of light. The light is reflected from the subject's face and falls into the photoelectric cells, which set up varying electric currents corresponding in amplitude to the light and dark portions of the skin, hair, eyes, etc. These currents, which are extremely weak, are amplified by a six-stage resistance-coupled audio amplifier (PA in Fig. D).

For testing purposes the output of this amplifier is carried directly to the checking receiver, which comprises the neon tube T, the revolving disc RD and the driving motor RM. For actual television broadcasting, an additional five-stage amplifier is hooked in before the impulses are allowed to actuate the broadcast transmitter proper.*

The receiver, it will be seen, is a comparatively simple affair. The disc is a duplicate of the one used in the transmitter, while the neon glow-tube T, which responds to the television impulses just as a loud speaker responds to musical impulses, is a standard bulb.

For laboratory demonstrations the transmitting and receiving discs are rather easily synchronized; as both motors run off the same power line. During the radio demonstration, no trouble in synchronizing was

* For more detailed descriptions of television machines of practically identical nature, see Radio News for April and May, 1928, and Television Magazine, issued by the publishers of this magazine.

experienced, because the city of Chicago is fed by one power system. The receiving motor was simply snapped on and off several times until the received picture assumed the proper "frame;" that is, until the positions of the holes in the discs were synchronous, as well as the speeds of rotation.

RESULTS OF HIGH QUALITY

The images visible in the check receiver, as viewed by a member of RADIO NEWS' staff, were really very good. It is difficult to describe the exact grade of their definition, but it can be said that the televised faces are distinctly recognizable. The images are streaked with the fine lines characteristic of television disc systems; but they are distinct enough to show the reflection of eyeglasses on the subject's face and the shadow of smoke from a cigar in his mouth.

THE PHOTOELECTRIC CELLS

Much of the success of this television work at WCFL is due to the photoelectric cells. They measure nine inches in diameter, are of the potassium type and extremely sensitive. The direct output of three of the four cells shown in the illustration, when led through only five stages of resistance-coupled amplification, is sufficient to operate the check receiver quite satisfactorily.

These cells, as well as three twelve-inch (Continued on page 277)

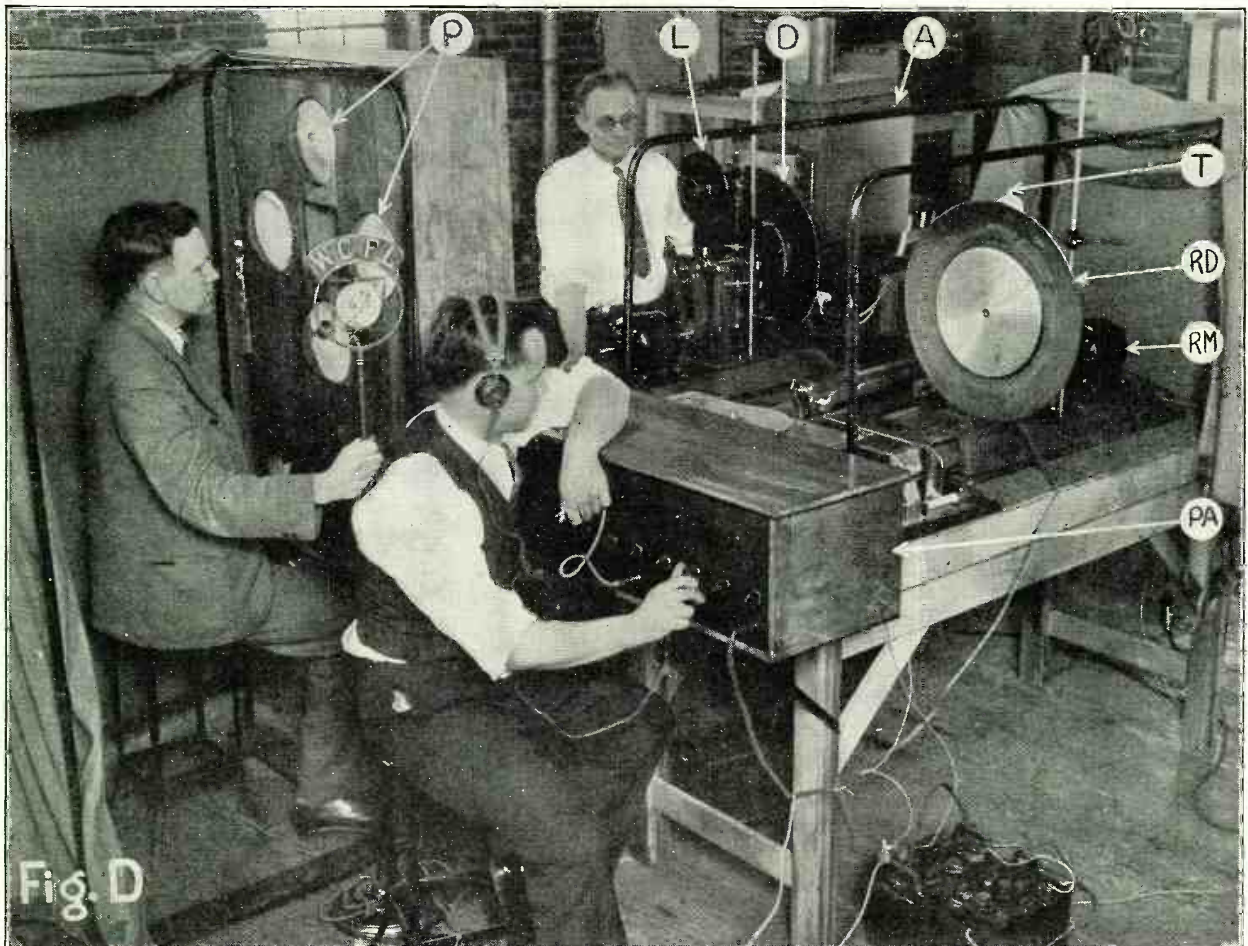

The complete experimental television at WCFL. The parts of the transmitter are: P, photoelectric cells; L, condensing lens; D, scanning disc; A, source of light. Receiver (in foreground):

PA, amplifier; RM, driving motor for scanning disc, RD; T, neon glow tube. M. L. Hayes, left; U. A. Sanabria, wearing phones; V. A. Schoenberg, rear.

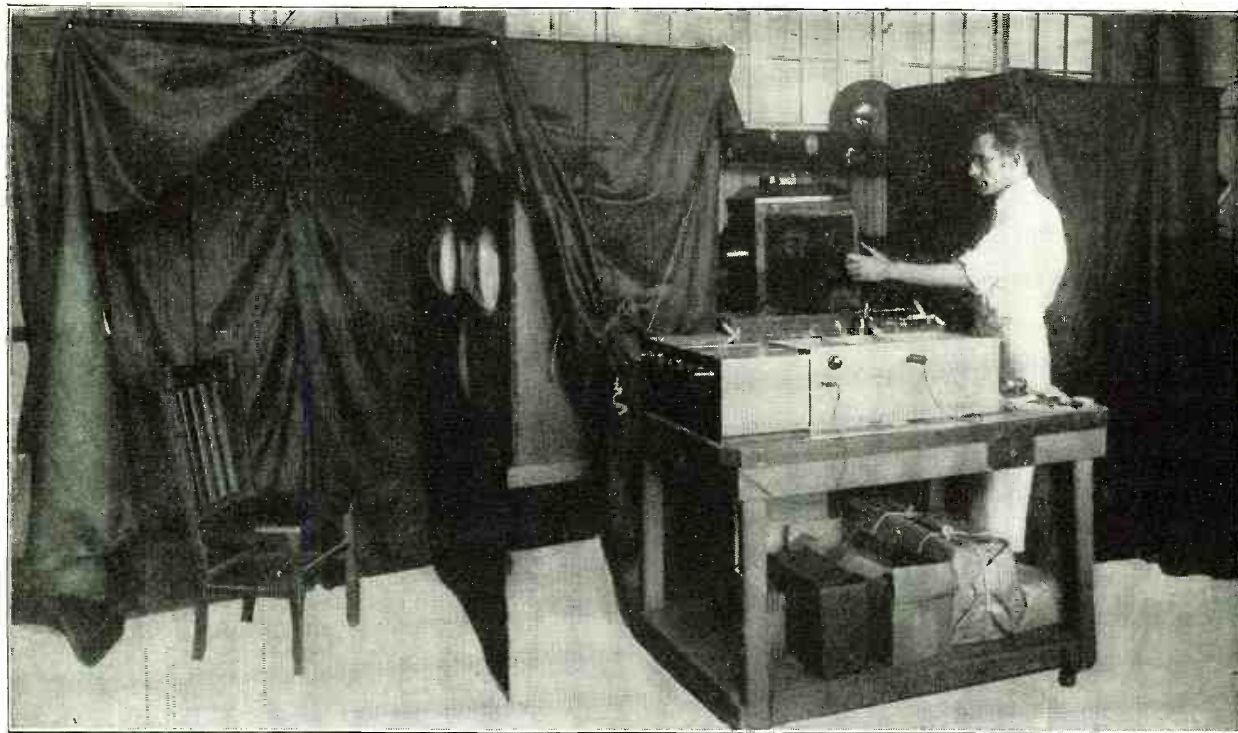

The temporary experimental television machine constructed for WRNY by the Pilot Electric Mfg. Co., of Brooklyn, N. Y. City. Transmitting and receiving discs are on the same shaft. The

subject to be televised sits in the chair at the left; his image is viewed in the booth at the right. The table in the foreground holds a five-stage impedance-capacity amplifier for the cells.

Giant Photoelectric Cells for WRNY'S Television Transmitter

BECAUSE of the unexpected failure of the only available photoelectric cells to produce enough current to operate the audio amplifiers, the television transmitter described in our July number could not be put on the air through station WRNY during June, as promised. The news of the contemplated television broadcasting on the regular broadcast band excited a great deal of interest among radio fans in and around New York, but the delay is unavoidable and will not last long.

A complete change in the design of the apparatus, and the acquisition by **RADIO NEWS** of what are believed to be the three largest photoelectric cells ever made in the United States, now practically assure the

success of the project. The editors are hesitant about naming a definite date for the initial television program; but the results obtained from the new equipment during the briefest sort of trial have been so encouraging that the first experimental transmitting will probably be done about the time this number appears.

The three cells are each twelve inches in diameter through the globular portion, and are about twenty-two inches long overall. They are of the alkaline-metal type, and were made by Lloyd Preston Garner, the same expert who made the nine-inch cells now being used at station WCFL. Robert Hertzberg, managing editor of **RADIO NEWS**, made a special trip from New York to Ur-

hana, Illinois, to obtain them. Mr. Garner made four of these giant cells, entirely by hand, with the assistance of Richard E. Waggner, a student of the University of Illinois. The fourth cell is the property of the university. Their cost is rather staggering, as their construction involved a great deal of complicated glass-blowing and required high-grade air-evacuating machinery and much chemical apparatus.

Aside from their great responsiveness to light, the important feature of these cells is that they are renewable. Should they go dead after periods of service, they can be completely repumped and rejuvenated, not merely once, but twice.

(Continued on page 256)

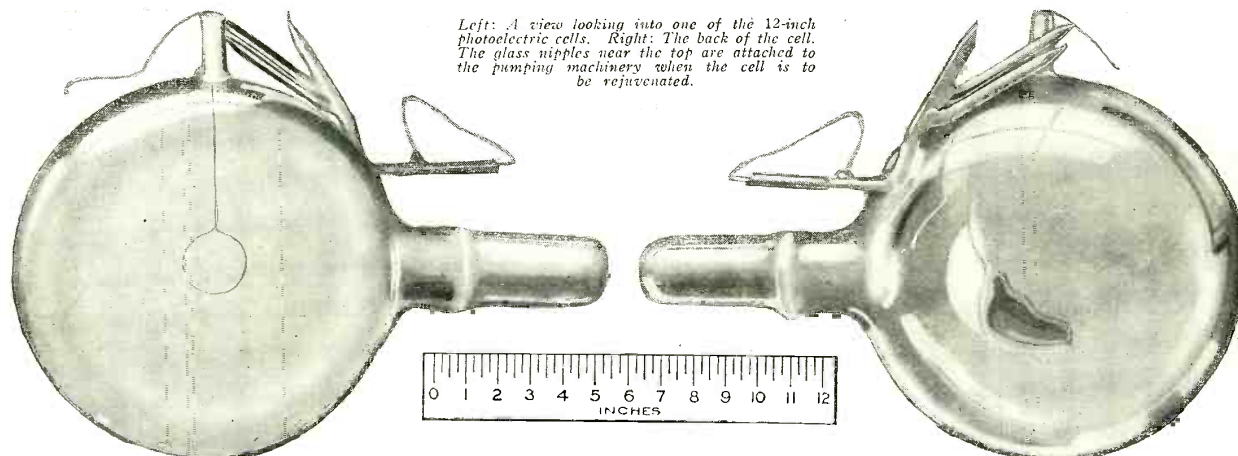

Left: A view looking into one of the 12-inch photoelectric cells. Right: The back of the cell. The glass nipples near the top are attached to the pumping machinery when the cell is to be rejuvenated.

The Scanning Disc, Television's Canvas

The Simple Device by Which a Moving Scene of Action Is Built Out of Radio Impulses Before the Observer's Eyes

By C. P. Mason

OF the four devices which are required to adapt the art of radio to television, two—the photoelectric cell and the neon “flash” lamp—are the “eye” and the “paintbrush,” respectively, of the radio television apparatus. Two others, the scanning mechanisms of the transmitter and the receiver, respectively, must be considered together; for they must perform similar duties, though perhaps in very different ways, mechanically.

While it is very probable that new devices may be invented to take the place of the scanning discs, which will be as much superior to the latter in operation as the vacuum-tube receiver is to the old “coherer,” the work which they perform must be the same—that of breaking up into points the image which is to be televised, and restoring it again, point by point, into a perfect whole at the receiving end.

The reason for this is found in the nature of the human eye. We hear in one dimension—one impulse at a time. A single point, moving back and forth with varying speed, will convey sounds to the ear—as shown by the old, but simple, “string telephone.” The most complex sounds can thus be conveyed in their fullness over a single wire circuit, or a single radio carrier-frequency.

NATURE'S ELABORATE APPARATUS

But our sight demands thousands of simultaneous impulses to build up a picture.

Thousands of nerves carry them from our eyes to the brain, which thus receives at one instant the impressions of form, color and distance.

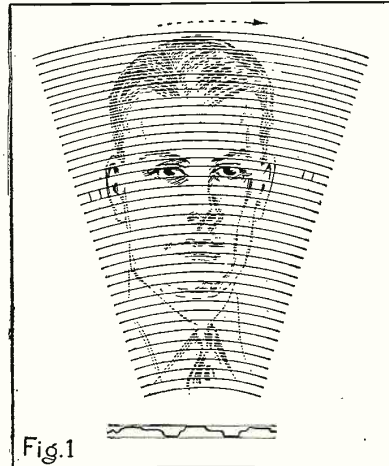

Fig. 1
The fast-flying holes divide the image into slightly-curved strips—exaggerated here. Each dark spot—like the eyes in this picture—causes a drop of current in the photoelectric cell and a darkening of the flash lamp's plate.

It is conceivably possible that, by utter disregard of expense, we might build equally-complicated apparatus for television. Thousands of miniature photoelectric cells, corresponding to the “rods” and cones at the back of the eye, would receive as many fragments of the scene before our transmitting device. Thousands of miniature flash lamps would reproduce them as an enormous whole at the receiving end. But all the radio transmitters now in the world would be needed to send such a picture; all the radio channels at present available would be needed for its transmission; and comparatively few of the complex receivers needed could be assembled out of all now in existence.

We are therefore compelled to break up the picture into little pieces, as we have said before, and send it bit by bit. This is easily done in sending a photograph by radio, when we can take, comparatively speaking, unlimited time; but in television we are limited also by the fact that we must reproduce the entire picture with all its changes as fast as they can occur.

“PERSISTENCE OF VISION”

Fortunately, however, we are aided by the fact that the eye, with all its breadth of vision, is comparatively slow in discarding impressions. A flash of lightning lasts for an imperceptible fraction of a second; but it will leave the impression of its path on the eye for a minute. If, therefore, we can build a picture out of points of light, it is necessary for each one to be in its place but

a slight instant to give the impression that it is standing there. Everyone knows the impression of a continuous curve given by whirling a single spark in the dark.

If, therefore, we could whirl this point over a regular track, one line so close to another that the space between them could not be seen, back and forth from the bottom to the top of a considerable area, we could apparently fill the space, with the effect of an unbroken illuminated surface. This task exceeds the deftness and speed of the best-trained hand, but it is not impossible with machinery. Now then, if we can also vary the brilliancy of this spark, certain parts of our illuminated surface will be darker than others; if we can turn it on and off quickly enough, we will have patches of blackness and patches of light. This is what the television apparatus of the present accomplishes.

THE NATURE OF SIGHT

While we are accustomed to think of the images present to our eyes as even, unbroken, uniform scenes, such is not the case. There are minute holes in our field of sight, which is composed of a multitude of little impressions fitting closely together. At twenty to thirty inches from our eyes a crack 1/100th of an inch wide will vanish, unless it is illuminated much more brightly than its edges.

Advantage is taken of this fact in making illustrations for printing purposes. They are photographed through screens which are ruled at distances of from 1/60th to 1/300th of an inch apart. For ordinary magazine work, such as this, divisions of from 1/110th to 1/120th of an inch are used. The picture thus made presents the effect of surfaces of light and dark grays over an unbroken

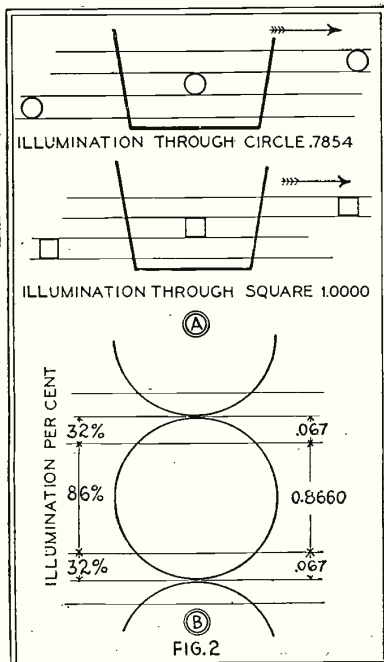

Fig. 2
A circle passes only 78% as much light as a square—at its edges only a third as much. Dark bands are thus caused by the use of circular holes.

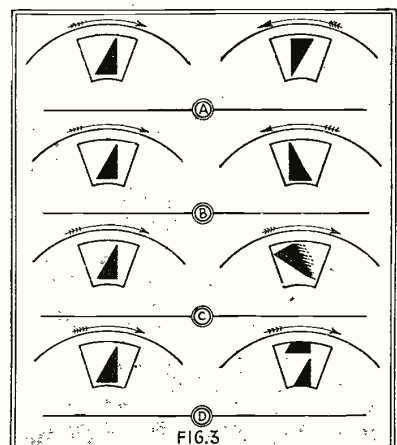

Fig. 3
If the receiving spiral is run backwards, the image is upside down (A); if it is left-handed, the image is mirror-like (B); if its speed is wrong, the image is twisted, blurred and drifts (C); if it is steadily out of phase, the image is out of “frame” (D).

area; but examination of the reproductions of photographs in these pages ("halftones") will show that they are composed of dots of varying sizes, each occupying the same amount of space and separated from its companions. Where they are large and close together, the surface appears nearly black; where they are small it is nearly white. Yet, viewed at ordinary reading distance, no single dot is visible separate from the others.

If, therefore, we can break up a scene before our television transmitter into similarly small dots, and reproduce each according to its corresponding brightness, in the same relative position at our receiver, we can reproduce the picture with such accuracy that it will be acceptable to the eye. If we can do this at the rate of about fifteen times a second, we can present a continuous moving picture at the receiving end. This is television.

THE PERFORATED DISC

We have, in the photoelectric cell, a device which will emit electric current proportioned to the amount of light which falls upon it. We have in the neon flash lamp a device which will emit light in proportion to the current passing through it. We have radio amplifiers, transmitters and receivers which will reproduce small current variations as very large ones, and this through almost unlimited space. We have only to adopt a mechanism which will break up the image—"scan" it—at the transmitting end, and put it together again at the receiving end. It is not necessary that the mechanism at both ends be alike—in fact, in several television systems, it is not—but it is necessary that each part of the picture corresponding to one transmitted impulse shall be reproduced in identically the same relative position as that part of the image which caused the impulse.

Many mechanical systems have been made for this purpose; but the first one proposed, forty-odd years ago, even before the birth of radio, is the simplest and involves the least difficulty in operation. It is simply a disc, perforated spirally by small holes. Each of these holes is as far from the next one as the width of the picture; the distance of each from the center differs from that of the next by the width of the hole itself.

Let us suppose that, with the aid of a camera lens, we reduce the image at the transmitter to an inch wide. The disc is



From a photograph of a subject being televised by the Ives system. The dark bands caused by the edges of the circular holes are visible.

placed between this image and the photoelectric cell and starts to turn. (See Fig. 1.) The hole in the disc which is farthest from the center crosses the image, in almost a straight line, at the top. If it enters upon a part of the image which is bright, a ray of light passes through into the photoelectric cell, which emits a throb of current. This is amplified and transmitted to the receiver, where it lights up the neon lamp.

The scanning disc at the receiver is turning in exact synchronism with that at the transmitter. Just as the hole in the latter crosses the edge of the image, that at the receiver comes into the "frame" at the top of the plate of the neon lamp—and the observer sees a point of light which is moving very rapidly.

"DECOMPOSING" THE IMAGE

The transmitting disc strikes a dark spot in the image; the photoelectric cell, relieved

from the bombardment of light, stops its emission of current, and this reversal is felt electrically all the way to the receiver. The neon lamp goes out, and the moving point of light disappears under the eye of the observer. The process is repeated, and the progress of the hole in the first disc across the televised image is registered in a broken line of alternating light and darkness before the eye at the receiver. The spinning disc is the canvas upon which a pencil of light is painting the received picture.

At the instant the first hole clears the image at the transmitter, the second one starts just below the first, and records the variations of light and darkness in a second line; this is repeated until the last hole has run across the bottom line of the image. If we should take one of the illustrations in this magazine, and cut it across from side to side into many narrow strips, then paste them together end for end, we would have the picture "decomposed" into a single line of light and dark spots which, obviously, could be telegraphed or sent by radio. This is what the scanning mechanism at the transmitter does. We have described here the picture as composed of light and darkness (like a "black-and-white" drawing) but many shadings are possible by varying the current at the neon lamp.

The precisely-corresponding mechanism at the receiver is also passing an endless series of holes over the rapidly-flickering neon lamp, each hole tracing a single line of alternating light and darkness, and the lines are so close together that the eye cannot see between them. Every fifteenth of a second, the picture is completed at the bottom, and the outermost hole starts at the top of the frame to "paint" a second picture, which the transmitter is beginning to send.

It will be noticed that the bottom of each picture is reproduced 1/15th of a second later than the top. This differs from the motion-picture method by which each picture is taken simultaneously, with a perceptible interval between. In the moving pictures, we may see the "stroboscopic" effect by which an automobile's wheels turn backward, apparently. In the television apparatus, we might see the automobile's wheels persistently keep a foot or so ahead of its body—unless some method can be devised of fixing an instantaneous image be-

(Continued on page 270)



The disc whose size is shown at the center has small square holes through the larger white dots, which are the aluminum exposed. (Courtesy of Lexington Television Corp.) Below, the arrangement of the set-up: 1, neon-lamp plate; 2, base support; 3, driving mechanism; 4, rheostat; 5, hood.

An experimental receiving television set-up. The hood before the disc helps to define the image and keeps out side-lights; the rheostat regulates the speed of the motor and disc.

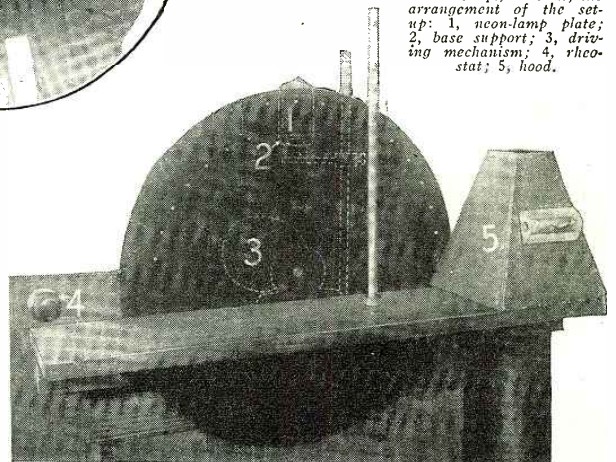
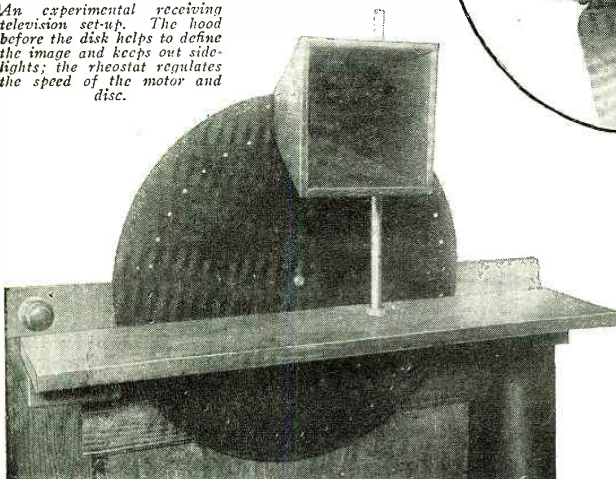

The Standardization of Radio Terms and Abbreviations



How the Confusion Caused by Misuse of Many Common Technical Expressions Can Be Relieved by the Adoption of Standardized Forms



By Robert Hertzberg

THE only authoritative list of standardized radio terms, abbreviations and graphical symbols in existence is the 1926 Report of the Committee on Standardization of the Institute of Radio Engineers. As far as it goes, it is a useful pamphlet; but it is woefully incomplete in its treatment of the numerous radio expressions used in the popular and technical press and by hundreds of thousands of radio enthusiasts of all degrees. Because of this shortcoming, there now exists a widespread confusion, among editors of radio magazines and radio editors of newspapers, as to the proper use, spelling, and particularly abbreviation of these common radio terms. In this respect, the editors of RADIO NEWS have been as perplexed as any of their contemporaries in the publication field.

The editorial practices of some publications suffer from the lack of definite authority to such an extent that they are not consistent even in themselves. Even so accurate an agency as the Bureau of Standards, in its monumental book, "The Principles Underlying Radio Communication," spells *radio telephony* as two words in the table of contents and as one word (*radio-telephony*) in the text. The Institute of Radio Engineers itself, in its *Monthly Proceedings*, has been guilty of the same editorial looseness into which most of the less technical radio periodicals have helplessly lapsed. For example, in the September, 1927, number of the *Proceedings of the I. R. E.* the terms *microfarad* and *micro-microfarad* are abbreviated in no less than five separate and distinct ways; three of these different abbreviations appear within eight lines of each other on the very same page (778). Hundreds of similar quotations from other widely-read sources could be given, but they would be merely repetitious and boring.

WHAT THIS PURPOSES

The aim of this article is to list the most widely-used terms and abbreviations, to indicate their points of variance, and to suggest standardized spellings and other forms. In scope, it confines itself almost entirely to mechanical form, rather than to technical interpretation. It is presented purely as a supplement to the I. R. E.'s unchallenged list of definitions, which is adequate enough for trained technicians, but which simply does not cover the peculiar conditions created by broadcasting—conditions which are perhaps without precedent in scientific circles. It includes only the misused and misspelled expressions whose variation is confusing to the average man interested in radio, and none of the obvious terms whose meaning is not subject to misinterpretation.

It must be stated that the compilation of the following list was not easy; for,

THIS article, prepared by the author after more than a year's research on the subject, marks the inauguration by RADIO NEWS of a reform movement which has two objectives: relief from the confusion which exists among radio fans as a result of the widespread misuse of various radio terms and abbreviations; and the standardization of these terms and abbreviations.

No attempt is being made or will be made to usurp the authority of the Institute of Radio Engineers, the highest technical radio body in the United States. However, because it is the largest and most widely-read radio magazine in the world, RADIO NEWS feels it can do much general good by presenting what it considers some useful and practicable suggestions. You are cordially invited to voice your opinion of this movement and to offer your personal comments on all or any of the points outlined.

paradoxically, the only consistent feature of popular radio terminology is its inconsistency. However, very few compromises with engineering accuracy have been made, and then only in the cases of expressions so immovably fixed in the public (and also the technical) mind that any attempt to change them would be perfectly futile. As sources of material the writer used the aforementioned report of the I. R. E. Committee on Standardization, dated 1926; *Symbols for Apparatus Used in Radio Circuits* and *Radio Terminology*, two private bulletins of the Bureau of Standards, dated March and July, 1920; several well-known technical manuals; and copies of practically every known radio publication in the world. RADIO NEWS, as the most widely-circulated and read radio magazine in the world, is adopting the suggested standardized forms, in the hope of relieving some of the present confusion.

No definite alphabetical order is followed herein; instead, subjects are taken in groups and discussed conveniently together.

RADIO: The Bureau-of Standards (hereinafter referred to as the Bureau), says *radio* is a word and not a prefix; hence, *radio telephone* should be two words and not one. However, its own Signal Corps manual, as mentioned earlier, uses *radiotelephone* as one word in the text. The compound word looks awkward, and is contrary to the general newspaper practice. *Radio telephone* and *radio telegraph* look more readable and are easier to handle. As nouns, these words should be used without hyphens; as adjectives, with them. Thus: "The vessels communicated by radio telephone"; but "They used radio-telephone apparatus of the latest type."

RECEIVING SET, RECEIVER: The Bureau advises against *receiver*, without giving a reason. However, the word is too firmly established to be dislodged, as also *radio set*.

SOCKET-POWER: The ambiguity of the expression *battery eliminator* is recognized. *Socket-power* is, of course, much better, and has been adopted officially by the National Electrical Manufacturers' Association; it is defined as "any device suitable for supplying 'A,' 'B' and/or 'C' battery voltages to a radio receiving set from the house-lighting supply by the throw of a switch." Thus we have "B" *socket-power unit* as a much more descriptive term than "B" *battery eliminator*.

To improve the advertising and merchandising of radio receiving sets, and to aid the public in its purchases of "electric," "socket-powered," and other receiving sets, the Radio Manufacturers' Association, in cooperation with other radio trade associations, has presented a list of radio-receiver definitions.

These were developed by the R. M. A. Engineering Division, of which Mr. H. B. Richmond, of Cambridge, Mass., is director, with the assistance of technical committees of other organizations. They were adopted and approved unanimously by the R. M. A. Board of Directors at its meeting at Buffalo, N. Y., in May, and are expected to receive the official approval of other radio trades associations.

The new and official radio merchandising definitions of the R. M. A., which meet with the approval of RADIO NEWS, are as follows:

BATTERY-OPERATED SET: A radio receiver designed to operate from primary and/or storage batteries shall be known as a *Battery-Operated Set*.

SOCKET-POWERED SET: A radio receiver of the Battery-Operated type, when connected to a power unit operating from the electric-light line, supplying both filament and plate potentials to the tubes of the receiver, shall be known as a *Socket-Powered Set*.

ELECTRIC SET: A radio receiver operating from the electric-light line, without using batteries, shall be known as an *Electric Set*.

A.C. TUBE ELECTRIC SET: A radio receiver employing tubes which obtain their filament or heater currents from an alternating-current electric-light line without the use of rectifying devices, and with a built-in tube rectifier for the plate and grid-biasing potentials, shall be known as an *A.C. Tube Electric Set*.

D.C. TUBE ELECTRIC SET: A radio receiver employing tubes which obtain their filament or heater currents from a direct-current electric-light line without the use of rectifying devices, and with a built-in power plant for the plate and grid-biasing potentials, shall be known as a *D.C. Tube Electric Set*.

This terminates the present list of techni-

cal trade definitions suggested by the R. M. A. To continue:

WHAT IS AN AERIAL?

ANTENNA, AERIAL: Both the I. R. E. report and Lauer & Brown's *Radio Engineering Principles* define the aerial as the elevated portion of the antenna, which is taken to mean the whole system for radiating or absorbing radio waves. The Bureau, on the other hand, makes the words synonymous. Since antenna serves a useful purpose in designating all of an important system, the I. R. E. difference should be observed and aerial used to specify the elevated wire alone. Practically everybody knows that an aerial is a wire on the roof, or sometimes one inside the house; but few will recognize the word "antenna."

For the plural of antenna, antennas is unquestionably easier to use than antennae, the pronunciation of which stumps many a radio man. The Bureau approves of this form, which is a natural one for Americans to use.

WAVELENGTH: Much unnecessary confusion surrounds this simple word. The entire press uses *wavelength*, *wave length* and *wave-length* with little discrimination, although "wavelength" seems to be the preferred form, as it should be. Any daily newspaper furnishes examples of the uncertainty of its proofroom and of its radio editor in its use of this expression.

METER: Should be spelled out at all times. Abbreviation of so short and widely-used a word is senseless.

KILOCYCLE: One word, of course. Should be abbreviated only when used with a number and then into simply *kc.*; hence, 610 *kc.* Abbreviations like *k.c.*, *K.C.*, *KC* are advised against; the first two obviously are wrong, because "kilocycle" is one word. It is the writer's opinion that units, when abbreviated at all, should be dropped to lower-case letters, preceded by the numeral or decimal fraction, and followed by a period; an abbreviation like *kc.*, for instance, seems to impress people as a typographical error, and much more *key*, which is often misread. The presence of the period, however, immediately fixes the letters as an abbreviation. The period has been used for so long with the abbreviation for microfarad (discussed in detail later) that we can easily standardize it for the *kc.*

In general, it is best to avoid the abbreviation altogether and to prevent confusion

by spelling out the full word wherever possible. Radio listeners hear the word *kilocycle* spoken frequently by station announcers, but many would find difficulty in recognizing it in print as *kc.*

SUPERHETERODYNE: The general practice is to make this one word, although the I. R. E. makes it hyphenated. It is so widely used as one that it is easier to leave it as such than it is to change it.

BROADCAST STATION: The common expression is *broadcasting station*, but *broadcast station* is shorter, more convenient and more nearly correct. We speak of telephone stations and telegraph stations, not telephoning stations or telegraphing stations.

LOOPS, NOT COILS

COIL: The Bureau says: "Do not use *loop* for a coil or circuit consisting of more than one turn," and the I. R. E. bolsters this admonition by defining a *coil antenna* as one consisting of one or more complete turns of wire. However, anyone who tries to alter the universal conception of such antennas as "loops" is attempting the impossible. The word *loop* has simply taken root and has been strengthened by the repeated advertisements of scores of *loop antennas*. This is one concession to popular usage that must be made.

A.C. and D.C.: The capital letters are preferable to lower-case, because they are more easily recognized. When written "ac" or "dc," they look like typographical errors; "a.c." and "d.c." are somewhat better, but two lower-case letters with periods look somewhat awkward. When the expressions are used as nouns they should be spelled out to produce a readable sentence; when used as adjectives the abbreviations are more convenient.

R.F., T.R.F., A.F., and I.F.: Radio frequency, tuned radio frequency, audio frequency and intermediate frequency. The abbreviations are unmistakable in capital letters, and should not be made in lower case; for the same reasons given for A.C. and D.C. Also let I.F. be standardized for intermediate frequency (of a superheterodyne). This particular abbreviation is a good argument for the capital letters. Put it in lower case—if or *i.f.*—and the tendency to pronounce it as the word "if" becomes marked.

As with *radio telephone*, the expressions *audio frequency*, *radio frequency* and *intermediate frequency* should be written without hyphens when used as nouns, and with hyphens when used as adjectives. Thus, "The intermediate frequency selected for the superheterodyne was 30 kilocycles"; but "Intermediate-frequency transformers tuned to 30 kilocycles were used."

C.W. and I.C.W.: For continuous waves and interrupted continuous waves. The I. R. E. makes them *cw.* and *icw.*, but these are rather illogical. If a period after the *w*, why not periods after the other letters, which also represent individual words? The capital-lower-case-letters argument applies again. Transmitting amateurs have been using for years the capital-letter form, because it is more easily recognized.

MICRO-, MILLI-: More trouble centers around the units *microfarad*, *micromicrofarad*, *microhenry*, *millihenry*, *microampere*, and *milliampere* than around any others. Of these, the microfarad is used in general radio work more frequently than all the others put together; for, while the sizes of condensers are usually marked on the de-

VICES or can often be guessed through more observation, the electrical values of coils are invariably unknown quantities. Now the most commonly-accepted abbreviation for *microfarad* has been *mfd.*; although occasionally one may see *MFD*, *M.F.D.*, or *m.f.d.*; the last two are foolish, since the periods after the "f" split up a simple two-syllable word. Even *mfd.* is longer than necessary. Why use the final *d* at all? The word is *microfarad*; *micro* meaning one-millionth, and *farad* being the actual unit. By the same reasoning through which kilocycle was derived, we obtain *mf.* for *microfarad*. This form is short, simple, and unmistakable. It has been in use in *RADIO NEWS* now for more than a year, and has proved to be a most logical abbreviation.

Properly speaking, the symbol for "micro" is the Greek letter which we call *mu*; the letter *m* correctly indicating "milli," one-thousandth. A few technical magazines and bulletins use *μf.* for microfarad; but from the standpoint of the radio public and even many experienced radio experimenters, this combination is hopeless. Few people know what the odd Greek letter represents and fewer still can pronounce it. Of course, they eventually learn that it stands for *micro*; they can usually guess that much. However, the general aversion to mathematics in popular radio practice (shared by a past president of the I. R. E., whose open admission of his attitude before a crowded Institute meeting, in 1926, brought forth a rousing round of approbative applause) has completely eliminated the symbol and the abbreviation from ordinary use. We find *mf.* or *mfd.* in almost universal use, except in such precise works as the Bureau of Standards' circulars, in which all the terms are spelled out and confusion is thereby avoided altogether.

Now with *mf.* irrevocably established as one-millionth of a farad, how can we abbreviate millihenry into *mh.*, which it is, properly? We should make microhenry *μh.* and then *mh.* would be millihenry; but the *μ* simply will not be accepted, for reasons already mentioned. The same dilemma arises in connection with *milliampere* and *microampere*.

Publications which run *mfd.* and *mf.* for microfarad, and do not use *μ* at all, also run inductance figures in plain *mh.* and current values in plain *ma.* How is one to know, except by guessing at the latter ab-

(Continued on page 274)

What Dr. deForest Says

New York City.

Dear Mr. Hertzberg:



Dr. Lee DeForest

I have looked over your suggestions regarding radio terminology, and I think that the points you make are in every case well taken. Considerable work remains to be done before the terminology of radio is thoroughly clarified and standardized for international work. I regard what *RADIO NEWS* is attempting in this direction as a valuable step forward.

Cordially yours,

LEE DEFOREST.

(Dr. deForest, the inventor of the vacuum tube, is one of the world's leading radio authorities.—EDITOR.)

An Outside Comment

Ridgewood, N. J.

Dear Mr. Hertzberg:

These examples of misuse and lack of uniformity of various radio terms by recognized technical periodicals are adequate evidence that some kind of reform is generally necessary.

The proposed practices which you suggest are most intelligently selected and I am certain that their general adoption would be helpful to all writers and publishers in the radio field.

Sincerely yours,

EDGAR H. FELIX.

(Mr. Felix is a well-known radio writer and broadcasting consultant.—EDITOR.)



Edgar H. Felix

The Radio Beginner

The Uses and Value of Meters in Radio

By C. Walter Palmer

VERY few people would think of buying a yard of cloth or a pound of coffee without first having it measured or weighed, to be sure that they are getting the full value. Neither would they think of driving a car without the aid of some indicating device, such as a speedometer on the dashboard, to indicate the rate at which they were travelling.

For this reason, it is rather surprising that indicating devices are not used more generally by home radio experimenters. It is not possible to operate a set at its most efficient point, or to obtain the most economical operation from it, without some means of determining the values of the voltages and currents in the filament and plate circuits. The average uninitiated fan considers either that meters are used simply to improve the appearance of a set, or that they are used exclusively by laboratory engineers in order to obtain obscure data.

WHAT THEY MEASURE

However, such is not the case. Although it is not absolutely necessary to install volt- and ampere-meters on the panels of every radio set, they are an essential part of the systematic experimenter's equipment; and even a beginner in radio can use them to advantage. Two good meters, of suitable ranges, will permit the experimenter to operate his set most efficiently and very often will enable him to improve otherwise poor results a great deal. The most useful meters for radio sets are the *voltmeter* and the *milliammeter*; in order to understand their uses, it is necessary to understand just what they do and how they operate.

Electricity is measured much the same as water in a pipe is measured. Electrical *potential* or "voltage" corresponds to the pressure of water in the pipe, and the rate of flow of the water in the pipe corresponds to the quantity of electricity passing a point in the current's path, or *circuit*, in a given time. The unit of potential is the *volt* and the unit of current the

ampere. The product of the numbers representing voltage and current is the number of *watts*, representing the *power* consumed in a circuit. The last unit, though familiar enough on lighting bills, or in transmitting work, is not used very often in measurements on radio reception and it will not be necessary to refer to it frequently.

The ampere is too large a unit to be used for measuring most of the currents used in radio receiving circuits, so it is desirable to subdivide it. Small currents are measured in *milliamperes*; a milliampere is one-thousandth of an ampere; a meter registering in milliamperes is a milliammeter.

VOLTMETERS

For measuring direct current, voltmeters can be divided into two general classes;

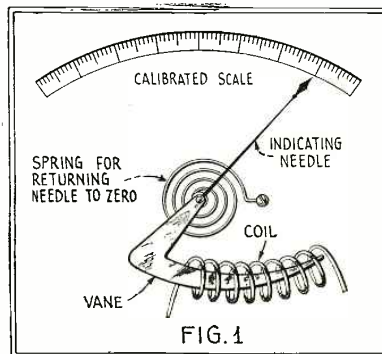

In the most common type of meter, the reading is caused by the pull of a coil's magnetic field, which is proportioned to the current.

the first contains a coil with an open core, in which a magnetic "vane" or strip is suspended (Fig. 1.) The pressure or volt-

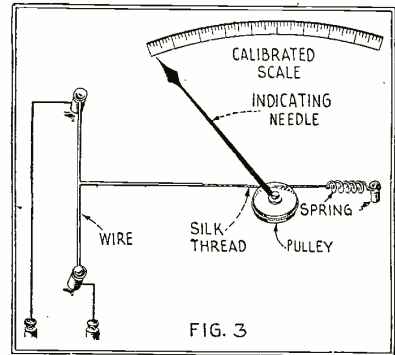

In a "hot-wire" meter, the lengthening of the wire causes the needle to move over the scale.

age across its binding posts is the cause of a proportionate flow of current which determines the position of the vane within the coil; since a greater flow of current in the coils metal causes a stronger pull on this magnetic metal. A needle-like pointer is fastened to the magnetic vane and arranged to indicate the value of the voltage on a calibrated scale. This type of "movement" is found in voltmeters of cheaper variety, and is not very accurate. However, for measuring the voltage of dry cells and other circuits not requiring very great accuracy, it is quite satisfactory.

The other type of meter consists of a galvanometer and a series resistor or "multiplier." (See Fig. 2.) The galvanometer is of the type developed by D'Arsonval in France, and is used for almost all direct-current work. The basic element consists of a moving coil swung between bearings, suspended in an air gap, in the concentrated magnetic field of a permanent magnet. This type of meter is much more sensitive and accurate than the moving-vane type.

Two general ranges are required for voltmeters used in radio receivers; the first for measuring filament voltages and the voltages supplied by "A" power units, "A" batteries, etc. The second type is used for measuring the voltage supplied to the plates of the tubes and the voltages supplied by "B" batteries and "B" power units. In measuring the last-mentioned apparatus, a voltmeter with a very high "multiplier" or series resistor must be used. This is necessary, so that the voltmeter will not draw more current than the power unit is intended to supply. Naturally, the output voltage will be reduced considerably and inaccurate readings will be made if the voltmeter draws too much current. This high-resistance type of meter contains a very sensitive "movement," so that very little current need pass through it. This

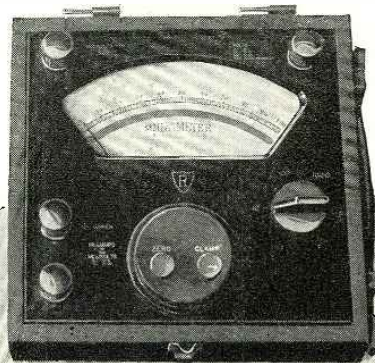
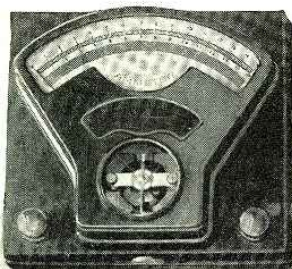

Two high-grade meters, designed for accurate measurements. These are suited to the laboratory, rather than for home use and set operation.

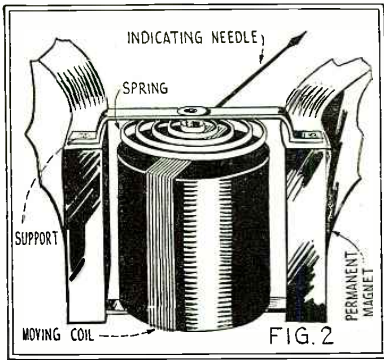

FIG. 2
The galvanometer is much more accurate than the moving vane, because it is more delicately balanced and sensitive.

allows the use of a large resistor and limits the current flowing through the meter. A resistance of about 1,000 ohms per volt is usually considered the best value; this would require a total resistance of 200,000 ohms for a 200-volt meter. By the use of two or more resistors, which can be included at will in the circuit, voltmeters are made

the plate and "B—" battery terminal. To measure the output of a power unit, the voltmeter should be connected between the positive and negative terminals. In measuring a filament voltage, the meter should be connected across the filament terminals at the socket; since, if it is connected to the terminals leading from the battery or "A" supply, it will measure the voltage supplied by the power unit and not the voltage supplied to the filament.

A very slight increase in the voltage supplied to the filament of a tube will result in an enormous decrease in its life. It can easily be seen, therefore, that the use of a voltmeter for checking the filament voltage will quickly pay for its cost, in the lengthening of the tube life.

"B" power units often supply much higher voltages than their rated values and it is rather important to keep the plate voltage at the correct value; especially in audio-frequency amplifiers where distortion might result if this voltage is above normal. The use of too high a plate voltage may also cause trouble from oscillation in a radio-frequency amplifier. The use of a high-resistance voltmeter will indicate the

audio-frequency stages by overloading them; since these tubes are operated at a much higher voltage than the other tubes in the set.

AMMETERS AND MILLIAMMETERS

These instruments are used in receiving sets to measure the filament and plate currents. The common types of these meters operate on the two general principles described for voltmeters. However, instead of using a series resistor to reduce the voltage passing through the windings of the galvanometer movement, a shunt or parallel resistor is used; so that the greater part of the current passes through the shunt instead of through the windings in the indicating device. In this case, more current will flow through the shunt as its resistance is reduced in comparison with that of the indicating unit, and a very low-resistance shunt will provide a meter with a high range. This is just the opposite of the effect noticed in a voltmeter.

The milliammeter is used quite extensively for measurements in radio receivers and is probably the most useful instrument for this purpose. It is always connected in series with the circuit to be measured, and never in parallel with it; since this meter has a very low direct-current resistance and would be practically a short-circuit. When placed in series with the plate circuit of a vacuum tube, it indicates the current supplied to that tube and, when placed in the "B—" lead, it indicates the total current in the plate circuit of the receiver.

This meter has another very important use in audio-frequency amplifier circuits. When an incoming voltage is impressed on the grid of a power tube, the plate current will fluctuate considerably, if the tube is not supplied with the correct grid voltage. By varying the value of the "C" battery voltage, a point may be found at which the plate current does not fluctuate, or has only a slight fluctuation; any increase or decrease in the "C" voltage will increase the amount of fluctuation. This is the point at which the tube will operate with the least distortion. It will be found that, when the correct "C" bias is used on tubes in a receiving set, the plate current is reduced considerably.

While the ordinary ammeter (reading from 0 to 5 or 10 amperes) is not as important as the milliammeter and voltmeter for receiving sets, it is a valuable instrument. If the current consumption of a

(Continued on page 265)

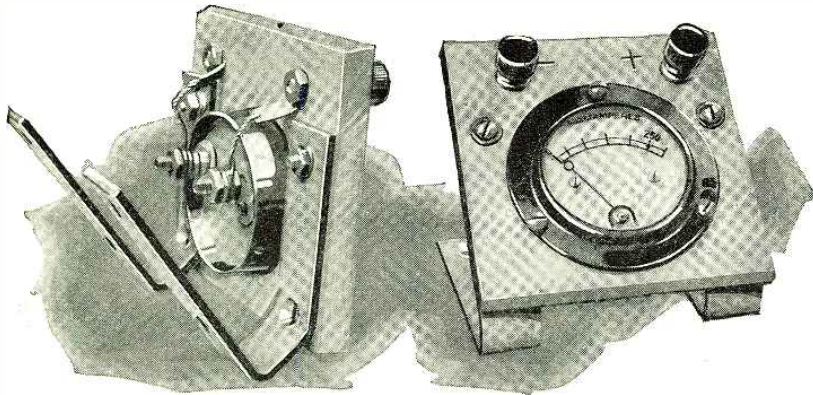

A panel-mounting meter, arranged in a home-made mounting. A device like this will be found very convenient for the experimenter's work bench.

to use two or more ranges of scale, by pressing a button.

USING THE VOLTMETERS

The voltmeter is always used to measure the potential drop across certain apparatus and, in order to do this, it must be connected across or in shunt with the apparatus in question, and not in series with it. In measuring the plate voltage in a radio set, the voltmeter should be connected between

exact voltage that is supplied to the plates of all of the tubes and will indicate just what "C" bias to place on the tube in order to obtain the best results. The manufacturers' tables, which accompany the tubes, should be used to get the correct value of the "C" bias for a given plate voltage; or the system described below for milliammeter measurements should be used. This plate-supply voltmeter will also serve to prevent injury to the tubes in the last

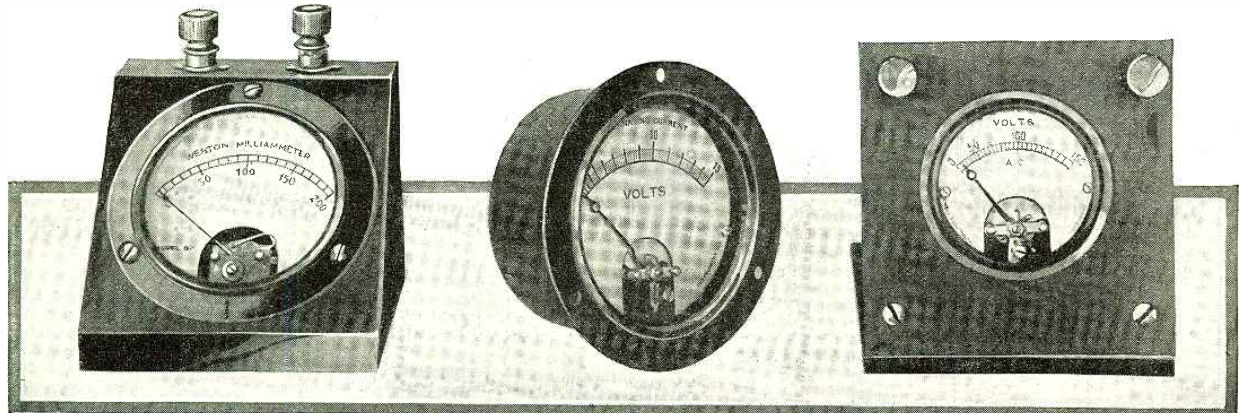

These meters are of the types used by home experimenters; the center one is suitable for mounting in a receiver panel. The introduction of the A.C. tube has made the A.C. voltmeter a necessity for proper regulation.

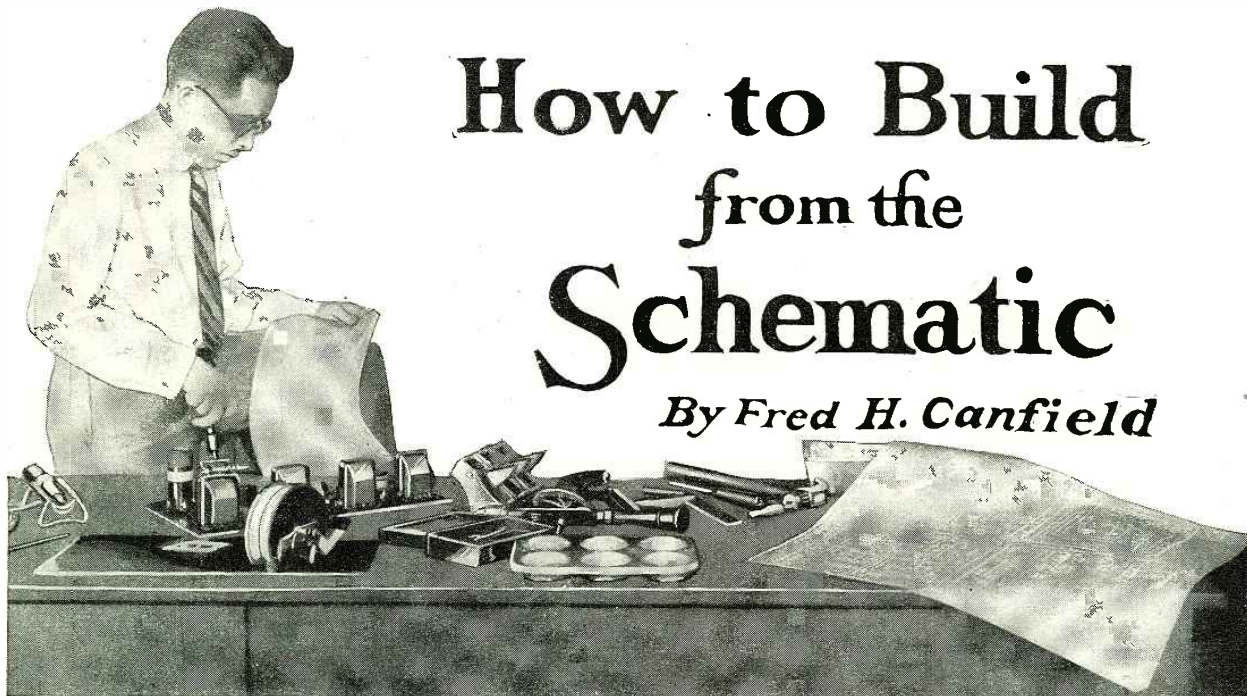

How to Build from the Schematic

By Fred H. Canfield

SCHEMATIC circuit diagrams provide practically the only accurate and easily-read method of presenting graphically an electrical system, especially of the type used in radio receivers. Schematics may be described as abbreviated picture diagrams of the simplest type; they possess many advantages not found in the usual form of pictorial wiring drawings and are very easily understood. If properly drawn, these diagrams are not ambiguous, and they may be interpreted equally well by all engineers, regardless of the language they speak.

Before continuing further with this discussion, in order to prevent any confusion of terms, it is desirable to consider the differences between the two types of diagrams mentioned above. The *schematic* circuit diagram of a receiver, for example, is made up of "conventional" symbols, which do not bear any direct relationship to the physical appearance of the parts used in the set. These diagrams show only the essential *electrical* circuit, and disregard the mechanical construction wherever it does not effect the electrical design.

On the other hand, pictorial wiring drawings are based on the appearance of the completed receiver, and the wires leading to the various terminals of the parts are indicated by solid lines. These drawings do not show the electrical circuit of the set, but merely indicate how the wires are connected with the component apparatus. When drawn to scale, they are entirely accurate if the parts specified are employed; but when important substitutions have been made from the specifications, the drawings have little value.

Many radio fans will take exception to some of the statements contained in the preceding paragraphs, and they will desire to dispute particularly the fact that schematics are pictorial diagrams of the simplest type. However, this does not indicate that schematic diagrams are imperfect, but merely shows that the critics have not taken the trouble to investigate the principle on which these drawings are constructed.

STARTING "ON HIS OWN"

When starting in the radio field, the average beginner is impatient for knowledge on the subject, and anxious to secure all information possible in the quickest and easiest way. Usually, he will start by reading the general articles on radio subjects, in newspapers and current magazines. In this way, he will discover the type of receiver which appears best to satisfy his requirements; he will find an article describing the construction of such a set. When reading articles, the average beginner will always avoid anything of a technical nature; that is, he will not read articles which are illustrated with schematic diagrams or study the mathematical formulas. This is because he either lacks the previous education or the ambition to study these articles, or he suffers from an inferiority complex. Nevertheless, by limiting himself in this way, he also limits the satisfaction which he may gain by building a radio receiver.

The writer does not wish to give the impression that the beginner's articles illustrated with pictorial wiring drawings are not usually accurate, for this is not true. Many excellent receivers are described in articles of this type. However, the person who finds it necessary to follow the pictorial diagram and is unable to understand the schematic, has no choice but to construct the receiver exactly as it is described; whereas, if he were able to understand the schematic diagram, it would be possible for him to make changes in the parts and the design of the set as he prefers.

Understanding schematic diagrams may be compared with learning the radio "code." In the case of the latter, there are 26 symbols which represent the 26 letters of the alphabet; these symbols may be used in hundreds of thousands of different combinations, each of which represents a different word. In order to understand "code," it is necessary only to memorize the 26 symbols and, after these have been learned, all of the combinations may be understood.

With schematic diagrams, there is also a set of symbols, and these are combined in different ways to make different circuits. Each piece of electrical apparatus is given a symbol, and in diagrams the symbols are connected by lines which represent the wires of the set. After the symbols have been memorized, all diagrams may be understood without difficulty. In reality the symbols used in schematic diagrams are much simpler to memorize than the "dots and dashes" of the radio code, and in a very short time anyone should be able to familiarize himself thoroughly with diagrams of this type.

THE SYMBOLS

The full-page chart which accompanies this article shows the symbols for schematic diagrams which have been adapted by *RADIO NEWS*, 1928, issue, and an amplified list is shown here. With the symbols shown in this drawing all diagrams, including those used for television receivers, may be drawn. The symbols closely resemble those used by other publications throughout the world, although slight changes in design have been instituted to make diagrams easier to follow.

A careful study of the chart of Standard Radio Symbols will show that there are very few basic symbols; although there are several variations of each to illustrate different types of apparatus. For example, all condensers are indicated by two parallel black lines, separated by a narrow space. Coils of all kinds are represented by a spiral line and all resistors are shown as zigzag lines. These are the three basic symbols. However, there is a particular method of drawing the symbol for each type of condenser, coil or resistor. A variable condenser, for example, is shown with an arrow drawn through the two parallel lines. A triple variable condenser is one long curved line terminating in an arrowhead with three short lines parallel to it, thus indicating that the three sections of the condenser have one set of plates in common.

With coils, there are any number of

variations in design to indicate the various types in use. A simple coil is shown as a spiral; if it has two windings, such as those of an R.F. transformer, two spirals are drawn parallel to each other. If the coil is one of variable inductance, such as a variometer, two spirals are crossed at right angles and connected in series. If there is a variable coupling between two coils, as in a variocoupler, the two coils are drawn parallel to each other (or one above the other) with an arrow connecting them. When a coil has a variable number of turns, this is indicated by a line connecting the spiral to an arrowhead, on the lead whereby the connection is made.

The symbol for coils is used also for such parts as intermediate-frequency transformers, audio-frequency transformers and power transformers; in each case, as with the R.F. coils, one spiral represents the primary and the other represents the secondary. Intermediate-frequency transformers are frequently wound over a core of iron filings and this is indicated by a single line between the two spirals. In the case of audio-frequency transformers and power transformers, three lines are drawn between the two spirals to indicate an iron core. Another interesting thing regarding coils in schematic diagrams is that the comparative size of the windings may be indicated by the number of loops in the spiral. For example, in a step-down transformer the primary spiral may be made twice as long as that of the secondary, thus indicating that the primary has more turns of wire.

A resistor in a radio circuit is indicated by a zigzag line. If a resistor such as a rheostat has a variable resistance, an arrow is drawn through the line, or a line joins the zigzag line near the midpoint to an arrow head on the connecting lead.

NEW DEVICES FOUND

Tubes of all kinds are indicated by circles, in schematic diagrams, within which the various elements of the tube are shown schematically. The grid is always shown as a zigzag line, the plate as a four-sided figure, and the filament as a continuous line passing through the tube. This covers the usual three-element vacuum tubes; but there are many special types having different symbols which must be memorized, such as gaseous rectifiers, voltage regulators, neon lamps, photoelectric cells, screen-grid amplifiers, etc., for which modifications of the symbol are devised as they are brought out.

The four types of symbols thus far discussed cover most of the apparatus shown

in an ordinary schematic diagram. However, there are many other symbols for individual parts, which must be learned. Among these, the most common are those indicating the aerial, ground, loop, counterpoise, batteries, headphones, etc. Solid lines in the diagrams always indicate wire connections; where solid lines cross there is a connection between the two wires if a dot is placed at the point of intersection, and there is no connection if one of the lines loops over the other. Dotted lines represent either shielding or mechanical construction. If heavy dotted lines enclose a circuit it shows that the parts within the lines are enclosed in a shield; where light dotted lines enclose one or more parts it shows that these parts are one unit within a case. Dotted lines are used also to indicate mechanical coupling, such as a link motion used to gain one-control operation of several condensers.

WORKING WITHOUT SPECIFICATIONS

An interesting thing regarding schematic circuit diagrams is that, after the fan has familiarized himself with radio circuits, he will find it possible to build a receiver from the diagram without even a list of specified apparatus. Of course, where the schematic diagram is accompanied by a list of parts the problem of building the set is somewhat simplified for the beginner; but the more advanced set constructor seldom finds it necessary to look for more data than is furnished with the usual article on a new circuit. Even when a complete novelty is presented, it is possible to estimate the values of the apparatus needed rather accurately.

On the other hand, this is not true of pictorial wiring diagrams, for they are of no value whatsoever without a list of the exact apparatus used in the original model of the receiver. This is because they indicate only the mechanical connections, and it is impossible to trace the circuit unless one is familiar with the construction of the parts. For example, in a pictorial diagram wires may be shown connected to eight terminals of a transformer which are marked 1, 2, 3, 4, etc.; but this does not aid the builder in connecting a substitute piece of apparatus in the circuit, if its terminals are marked A, B, C, D, etc.

A typical example of the value of schematic diagrams was found in the mail received by RADIO NEWS after the publication of its July, 1927, issue. At this time a number of readers wrote to the effect that they were greatly interested in the article

describing the theory of the new Strobodine circuit and were impatient to build a similar receiver for themselves. Several explained that they were unwilling to wait for the constructional data, which were scheduled for publication in the following month, and that they had built the set from the data contained in the first article. Although these readers were working on a new circuit, and were entirely without information as to the components used by its designer—not even the values—they were successful in securing excellent results!

In reality, there is much similarity between all radio circuits. Even if a circuit is described as entirely new it will be found that a majority of its features are commonly used in other set. For example, in a new, "revolutionary" tuned-R.F. receiver it may be found that all connections in the set are exactly the same as in a standard R.F. receiver with the exception of an automatic grid-biasing control, which constitutes the revolutionary feature. Therefore, upon examining the circuit the fan would know the proper value for practically all of the parts, and it would be necessary only to experiment slightly with the biasing control.

In order to fully appreciate the similarity between radio circuits it is necessary to study carefully a number of circuits and then compare their various parts. Often it will be found that two receivers which are considered very different have many points in common, such as identical audio amplifiers, similar detector circuits, etc.

PRACTICAL POINTS

In looking over a number of circuit diagrams, the first thing that will strike the beginner will be the similarity between the antenna connections of the various different types of sets. In most sets these are practically the same and the differences between the various types is very slight. Fig. 1 shows six different antenna-circuit arrangements and these include all the systems which will be found in the usual receiver.

The circuit shown in diagram A of Fig. 1 is the usual arrangement, and may be used with practically any receiver operated from an outside aerial; L is a standard antenna coupler with the primary (p) in series between the aerial and ground, and the secondary (s) connected to the grid and filament of the first tube. The secondary coil is tuned to the desired wavelength by a variable condenser connected in shunt with this winding, and the primary winding is tuned aperiodically, because of its prox-

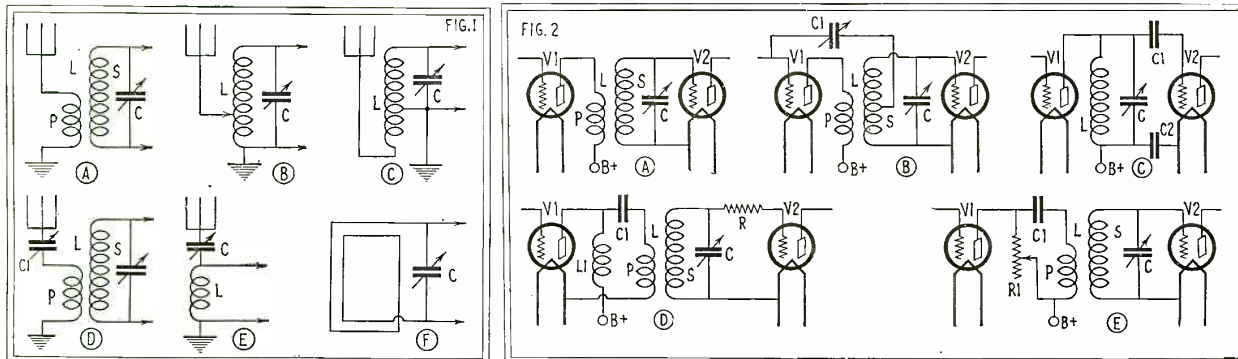

































































Fig. 1 shows the six popular methods of coupling the antenna circuit with a radio receiver. Circuit A is most often employed in broadcast sets. Fig. 2 shows five systems of interstage coupling in R.F. circuits. Circuit A is standard; B is the neutrodyne arrangement and C is most desirable for use in screen-grid sets. D and E are special stabilizing methods.

STANDARD RADIO SYMBOLS

AS ADOPTED BY "RADIO NEWS"

	AERIAL		AUDIO-FREQUENCY INDUCTOR (USUALLY A.F. CHOKE)		TWO-ELEMENT VOLTAGE-REGULATOR TUBE		BATTERY (POLARITY INDICATED)
	COIL ("LOOP") AERIAL		IRON-CORE TRANSFORMER		THREE-ELEMENT VOLTAGE-REGULATOR TUBE		FUSE
	GROUND		PUSH-PULL AUDIO-FREQUENCY TRANSFORMER		PHOTO-ELECTRIC CELL		BINDING POST
	COUNTER-POISE		FREQUENCY METER (WAVEMETER)		NEON GLOW TUBE		MICROPHONE/TRANSMITTER
	VARIABLE CONDENSER		FIXED RESISTOR		CONNECTION BETWEEN WIRES		D.C. GENERATOR
	VARIABLE CONDENSER (MOVING PLATES INDICATED)		VARIABLE RESISTOR		NO CONNECTION		ALTERNATOR
	TRIPLE VARIABLE CONDENSER (SAME STYLE FOR DOUBLE OR QUADRUPLE)		VOLTAGE DIVIDER (POTENTIOMETER)		TELEPHONE JACKS		TRANSMITTING KEY
	SEPARATE VARIABLE CONDENSERS OPERATED TOGETHER		FILAMENT BALLAST		FILAMENT SWITCH (S.P.S.T.)		LAMP
	FIXED CONDENSER		THREE-ELEMENT VACUUM TUBE		LIGHTNING ARRESTOR		ARC
	CONDENSER BLOCK		THREE-ELEMENT VACUUM TUBE, A.C., HEATED-CATHODE TYPE		ELECTROLYTIC RECTIFIER		BUZZER
	R.F. INDUCTOR (MAY BE R.F. CHOKE)		SCREEN-GRID TUBE		VOLTMETER		THERMO-ELEMENT
	R.F. INDUCTORS, COUPLED. (R.F. TRANSFORMER)		SCREEN-GRID A.C. TUBE		AMMETER		PHONOGRAPH PICK-UP, MAGNETIC TYPE
	INTERMEDIATE-FREQUENCY TRANSFORMER OF A SUPER-HETERODYNE.		HALF-WAVE RECTIFIER TUBE, FILAMENT TYPE		CRYSTAL DETECTOR		LAMP-SOCKET PLUG, 110-VOLT TYPE.
	CONTINUOUSLY VARIABLE INDUCTOR ("VARIOMETER")		FULL-WAVE RECTIFIER TUBE, FILAMENT TYPE		PIEZO-ELECTRIC CRYSTAL		PLUG RECEPTACLE 110-VOLT TYPE
	TAPPED INDUCTOR		FULL-WAVE RECTIFIER, FILAMENTLESS TYPE		FULL-WAVE DRY-ELECTROLYTIC RECTIFIER		HEAVY DOTTED LINES TO INDICATE GROUNDED SHIELDING
			TELEPHONE RECEIVER		ELECTRO-DYNAMIC SPEAKER		PERIDYNE SYMBOL

(An additional proof of this symbol sheet will be mailed to any reader requesting it.)
(Copyright, 1928, by E. P. Co.)

imity to the secondary coil. In mechanical design the antenna coupler usually is wound on a bakelite tube approximately three inches in diameter. The secondary coil consists of approximately 60 turns of No. 24 to No. 28 gauge wire, and the primary winding has from 10 to 15 turns of the same size wire. The coil may be made with the primary and secondary windings on the same tube and separated by a space of 1/4-inch, or with the primary on a slightly smaller tube which is placed inside the secondary. In either case the primary winding is located near the filament end of the secondary.

DESIGN OF COILS

The exact number of turns of wire to be used on the secondary winding of an antenna coupler, or of any R.F. inductor, is dependent upon a number of conditions; including the waveband to be covered, the capacity of the tuning condensers used, the diameter of the coil form, and the thickness of the insulation on the wire. The most important consideration is the capacity of the variable condenser; for the broadcast waveband condensers having a maximum capacity between .0003-mf. and .0005-mf. may be employed, but an .00035-mf. condenser is now selected as being generally most satisfactory. If manufactured coils are used it is possible to buy a set designed for use with condensers of the particular capacity which has been selected. However, if the coils are homemade, it is best to wind more than the required number of turns on the secondary and then, after the coupler has been connected in the circuit, turns of wire may be removed until the coil tunes to the highest desired wavelength when the condenser is adjusted to its maximum capacity.

The number of turns on the primary winding of the antenna coupler is determined by the desired selectivity and sensitivity of the circuit. As the number of turns on this winding are increased the sensitivity is increased and the selectivity is reduced, and *vice versa*. Therefore if, with 15 turns of wire on the primary winding, the circuit tunes broadly, a few turns of wire should be removed, and if ten turns of wire does not permit the reception of distant stations the addition of a few turns will improve the sensitivity.

In connection with aerial circuits of the type shown in Fig. 1A, the important thing to remember is that the coil and condenser must be designed to work together in order to cover a desired waveband. The specifications of a circuit may call for a .00035-mf. condenser with a given coil; but practically the same results may be secured by using a .0005-mf. condenser and removing the required number of turns of wire from the coil. Also, when coil specifications call for a three-inch tube with 60 turns of No. 26 D.C.C. wire on the secondary, it should be understood that these are not all absolutely unbreakable rules. If a 2 1/2-inch diameter tube and No. 24 D.C.C. wire are available, these may be used with satisfaction, provided a greater number of turns of wire is used for the winding.

AERIAL CONNECTIONS

Diagrams B and C in Fig. 1 show two common variations of the circuit shown in diagram A. At B the coil has the same number of turns of wire as the secondary coil in diagram A, and a tap is provided between the 10th and 15th turns (from the filament end of the winding) for connection

to the aerial. At C the portion of the coil tuned by the condenser is the same as the secondary coil of diagram A, and an additional 10 or 15 turns is wound for the aerial circuit. All three of these circuits produce practically the same results.

At D the antenna coupler is exactly the same as that used in diagram A, and a condenser shown connected in series with the aerial is a *sensitivity* control. This system is frequently used in factory-made receivers, to facilitate increasing the selectivity without reducing the number of turns on the primary winding. The condenser may be variable or fixed, but in either case it does not require frequent adjustment. In sets which tune broadly, a .00025-mf. condenser connected in this position frequently will correct the condition.

Diagram E shows a method of aerial tuning which was popular in the early days of broadcasting; but this circuit is now unsatisfactory as it is not sufficiently selective for present conditions. The condenser C tunes the aerial and grid circuits simultaneously. The coil has the same number of turns as the usual antenna-coupler secondary, and the condenser a capacity of .0005-mf.

The circuit in diagram F shows the method of connecting a loop aerial to a receiver. In this circuit the loop acts as an inductor and it replaces the usual secondary winding of the antenna coupler. The condenser should have a capacity of .0005-mf. and the loop should have enough turns to permit tuning over the entire wave band. The number of turns on a loop aerial may be determined in the same manner as the turns on the secondary winding of an aerial coupler.

R.F. TUBE COUPLING

A more careful study of circuit diagrams will show that there is a great similarity between practically all interstage R.F. coupling circuits. Fig. 2 shows the five most popular systems in use; in circuits A, B, D and E a radio-frequency transformer (L), the secondary winding of which is tuned by the variable condenser C, is used for coupling the plate circuit of one tube with the grid circuit of the following tube. This radio-frequency transformer and its tuning condenser are of exactly the same design as the antenna coupler and its tuning condenser, shown at A in Fig. 1.

A shows the usual method of connecting the R.F. transformer in the circuit; at B the R.F. transformer is connected in exactly the same manner, except for a small neutralizing condenser (C1) connected between the grid of the first tube and a tap at the midpoint of the secondary winding. This is the system used in the neutrodyne receiver for the prevention of oscillations. The neutralizing condenser is adjustable and has a capacity range of 2 to 20 mmf.

At D another method of preventing oscillations is used; in this circuit a fixed resistor (R) is connected in series with the

wire to the grid of the second tube. If the set employs two stages of R.F., a 700-ohm resistor is connected in the grid circuit of each R.F. tube; while, if three stages are employed, a 1,500-ohm resistor is used in each grid circuit. These resistors are known as grid suppressors. Another unusual feature of the circuit shown at D is that the plate current for the tube does not pass through the primary winding of the R.F. transformer. As shown in the diagram, an R.F. choke coil (L1) is connected between the "B+" binding post and the plate, and an R.F. by-pass condenser (C1) is connected between the plate and the primary of the R.F. transformer. The choke coil helps to prevent coupling between the R.F. stages and in this way reduces the tendency of the circuit to oscillate; while the by-pass condenser allows the R.F. signal to pass to the primary of the R.F. transformer. The choke coil may be of the usual 85-millihenry type and the by-pass condenser has a fixed capacity of .006-mf.

A third method of preventing oscillations is used in the coupling circuit illustrated at E. In this circuit a variable resistor is connected between the "B+" side of the R.F. transformer and the plate of the tube, and a by-pass condenser is connected between the plate of the tube and the "P" terminal of the R.F. transformer primary. The variable resistor has a maximum resistance in the order of 10,000 ohms and the by-pass condenser a capacity of .006-mf.

An impedance-coupled R.F. circuit is shown in diagram C. This type of circuit is more efficient than the transformer-coupled type for certain types of tubes, such as the "hi-mu" and "screen-grid" types, but is unsatisfactory with the usual 201A-type tube. In this diagram the coil L has similar characteristics to the secondary winding of an R.F. transformer and the variable condenser (C) has the usual capacity. The unusual characteristics of the arrangement are that the plate and grid circuits of the two tubes are coupled in the same coil; and that two R.F. by-pass condensers must be connected in series with the wires to the grid and filament of V2 to prevent the "B+" potentials from being applied to these circuits.

DETECTION SYSTEMS

In progressing from left to right in a receiver's schematic diagram, after passing the aerial circuit and R.F. stages, the de-

(Continued on page 276)

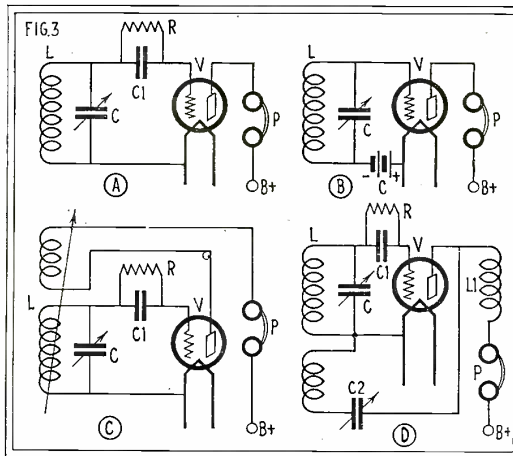

Four methods of connecting the detector tube are shown at the right. Circuits A and B are non-regenerative, while C and D are regenerative. A majority of all receivers in use employ the system indicated at A.

Making Serviceable and Efficient Coils



Some Practical Advice on the Design and Home Construction of R. F. Transformers, Especially When They are Frequently Required



By Philip H. Greeley

ALTHOUGH numerous articles describing the construction of coils suitable for use in radio receiving sets have appeared in the different radio publications, and many suggestions of considerable value have been offered, few writers have boiled down their ideas and shown how efficient and serviceable coils may be constructed with a minimum of equipment and with the least difficulty. Of course, good coils may be purchased and there is no particular economy in making coils for only one or two receivers if suitable coils are commercially available; but if the set builder wants to try any ideas of his own or do his own circuit designing, or even adapt standard circuits to different tubes, it is important to be able to make good coils.

The simple single-layer *solenoid* is about the easiest coil to make and is generally considered to have about the highest efficiency attainable. The spaced type of single-layer winding, in which the spacing between each turn is about the same as the diameter of the wire used, is often recommended as the ideal for tuned secondary coils, but the spacing provided by double cotton insulation gives very good results. For tuning in the broadcast waveband, and keeping coils to a diameter of two or two and a half inches so that several tuned stages may be used advantageously in a receiving set of moderate dimensions, secondaries wound with No. 26 D.C.C. wire will be found to give results not easily surpassed.

INSTANCE OF SPACING

Winding a single-layer coil appears to be a very simple matter, yet minor differences in the winding will often make considerable difference in the inductance value

obtained. Coil specifications are given with the understanding that the winding will have a *definite diameter, a definite number of turns, and a definite number of turns per inch of coil length*. A good many home-made coils are correct as to diameter and number of turns, but have the winding spread out over a greater length than intended. For example, No. 26 D.C.C. wire is ordinarily expected to wind 41 to 42 turns for each inch of coil length and, if the winding is somewhat looser, giving only 38 or 39 turns per inch, the coil and its specified tuning condenser may fail to tune in the higher wavelengths intended to be covered.

Where a coil is wound on the usual hard-rubber or bakelite tubing, it is difficult to put the winding on closely enough to meet specifications; especially if the wire purchased does not come off the spool perfectly even. So it is best to wind on the wire without attempting to get it perfectly even and close, and then work the winding down smooth and even with the fingers after a sufficient number of turns have been put on the form. In order to permit moving the wire after winding, it should not be put on under too great a tension; the tension should be just moderately firm, for best satisfaction.

CEMENTING THE COILS

In order to make coils that are durable and can be handled or altered without the windings getting loose, the use of a good coil dope is recommended. About the best dope for general radio purposes can be made up readily by dissolving celluloid in a mixture of acetone and amyl acetate. Some prepared cements are suitable, but it is difficult to get the right consistency for different purposes unless the user is pre-

pared to thin or thicken the cement as desired.

For doping coils, the cement should be thin, so that it will penetrate and wet the wire's insulation, rather than just smear on the surface. Just three or four square inches of celluloid sheet (such as is sold for automobile side curtains) with about an ounce each of acetone and amyl acetate will be required for such cement. Acetone evaporates very rapidly and the bottle containing it should be kept closed; amyl acetate evaporates much less quickly, so the cement may be made quicker or slower in drying by changing the proportions of acetone and amyl acetate. The thickness is regulated by the amount of celluloid dissolved, and a thick cement may be used for work on cone speakers and other paper work. The cement is best made in a rather wide-stoppered bottle of two- or three-ounce capacity.

For applying the cement, a supply of pipe cleaners, which may be doubled over at the end, is desirable; because it is rather difficult to soften a brush that has been used and then dried and the pipe cleaners are cheap enough to use fresh ones from time to time.

In purchasing acetone and amyl acetate, it is best to go to a drug store that handles chemicals in moderate quantities or to a regular chemical supply house; because the usual drug store is apt to charge rather a fancy price for the liquids. Four to eight ounces of each should make a supply of cement sufficient for a considerable number of coils and other radio applications, though it is advisable to make up only two or three ounces of the cement at a time as needed. A half a dollar to a dollar should be sufficient to buy the necessary solvents.

SELF-SUPPORTING COILS

Coils wound on plain hard rubber or bakelite tubing may be cemented in place and will hold quite well; but holding may be made much more certain and permanent by putting a piece of celluloid sheet around the tube before the wire is wound on and cemented in place. Celluloid sheet for this purpose may be obtained from automobile accessory stores; and should, preferably, be of the lighter weight used for automobile curtain lights. Only enough of the celluloid sheet is required to go around the winding tube and overlap about an eighth of an inch; the overlap should be cemented, using the cement sparingly. The overlap should not be great, because too wide a joint and the use of too much cement has a tendency to make the celluloid buckle out of shape.

Although coils wound on celluloid and cemented thereto are self-supporting with the winding form removed, a thin bakelite or hard-rubber tube affords considerable mechanical strength and makes coil mounting easy.

According to published tests, the presence of a thin bakelite or hard-rubber tube

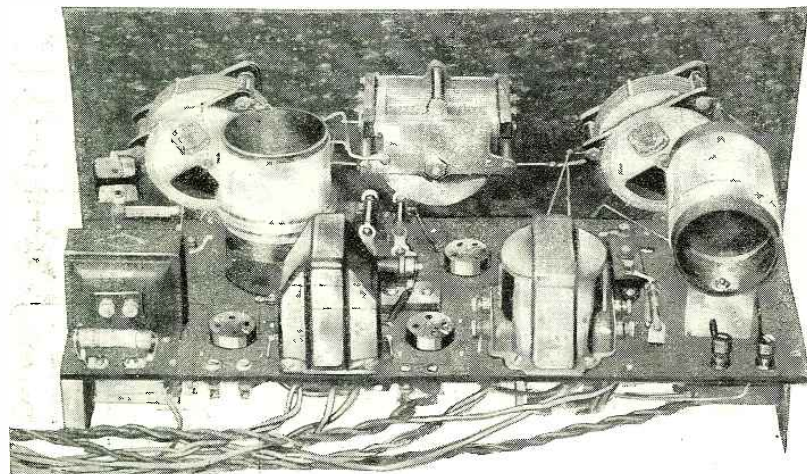

Fig. A. The coils illustrated opposite are here shown in a receiving set. No terminals are used on the coil forms, the ends of windings being soldered direct to wiring or the terminals on tuning condensers or sub-panel.

does not decrease coil efficiency enough to show any appreciable difference in radio set performance. Also, doped coils, when the dope used is well suited for radio purposes, are not inferior to undoped coils of similar construction under average conditions. Probably the doped coils will not absorb much moisture and will therefore show slightly greater efficiency than undoped coils unless the atmosphere is very dry.

There has been considerable hair-splitting in the matter of coil construction, yet it is quite certain, in the writer's opinion, that the presence or absence of coil form or coil dope does not make anything like the

as a thick gummy mass; but shaking or stirring with a wire, and a little time, will give a uniform solution of a consistency depending upon the amount of celluloid dissolved. The dope should not be thick enough to string out like syrup when intended for coil purposes; but it should be quite thick for paper work, such as cementing speaker cones.

A COIL WINDER

Coils may be wound entirely by hand, but it is worth while to rig up a winding machine if any considerable number are to be made. One of the small high-speed grinding wheels, in which the wheel shaft

and then will be mounted on the end of the quarter-inch rod. Two more old tuning dials (B and C) will be drilled through the end and will be fitted on the other end of the quarter-inch rod to hold the winding tubes between them. One dial will be locked by a set screw and the other will be made to clamp the winding tube by means of a nut on the threaded end of the rod. Cardboard disks, cut to fit just within the ends of the winding tubes used, may be necessary for centering the winding tubes.

MOUNTING THE COILS

Coils may be mounted either vertically or horizontally, as desired. For a vertical mounting, it is necessary only to drill the coil form, about $\frac{1}{4}$ -inch from one end, on opposite sides (using a $\frac{1}{16}$ -inch drill); then bend small hooks from bus bar so that the coil may be clamped down by means of small screws, as shown in Fig. 2.

For a horizontal mounting, it is desirable to whittle out of soft wood a pair of small blocks about a half inch thick, so that the top edges are hollowed to fit the coil tube; sanding the block with sandpaper held on the tube will give a perfect fit. By drilling through the wood block and coil tube, long machine screws may be used to hold the finished coil in place. A mounting of this type is substantial and will prevent breaking the coil tube at its support. Figure 2 shows both types of mounting.

In wiring coils of this construction into a circuit, it is satisfactory to drill small holes where the coil terminals would be placed; then hook the busbar connecting leads in said holes and solder coil ends direct to the bus bar. This affords a reliable electrical construction together with good mechanical strength and appearance.

The method of starting a coil winding has not been mentioned above; but the end may be put through a small hole in the coil form, or else about one turn may be cemented on the celluloid before continuing the winding, the latter method being best when the wire is fine.

COIL DESIGN

The present article is intended mainly to help the reader with constructional details, but a few points on coil design are important to discuss.

The coil which is to be tuned, usually the

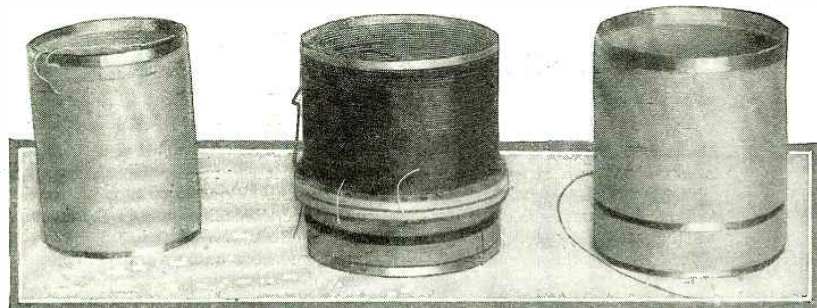

Fig. B. A group of self-supporting coils that have been used. The celluloid surface and dope hold the windings positively. The celluloid is easily cut with scissors, or it may be marked by a sharp knife and then broken on the marked line.

difference that coil shape, dimensions, and relative placement of secondary and primary windings make.

If it is desired to make celluloid-bound, self-supporting coils, there is really no need to make specially-split winding forms, as some writers have recommended. If an ordinary smooth tube of bakelite or hard rubber with a band of celluloid over it is used as the winding form, coils wound with the finer sizes of wire, such as No. 25 D.C.C. without using too great tension when winding, can usually be removed from the winding form after the coil cement has dried thoroughly.

To facilitate the removal of the coil from the form, a thin sheet of brass (such as is used for automobile shim stock and may be had about .005-inch thick) may be wound on the coil form before the celluloid band is put on. This will prevent any sticking of the celluloid to the form and the thin brass can be peeled away from the celluloid even though there is some sticking; the brass, of course, being removed from the form with the coil.

Space-wound coils may be made in the same general way if desired. It is necessary only to wind on simultaneously two wires; one preferably cotton- or silk-insulated, and the other enameled and about four sizes finer than the first. This double-wound coil is cemented and, when it becomes dry, the enameled wire is unwound; leaving the cotton- or silk-covered wire spaced on the celluloid.

Very little practice should be required before the constructor will become familiar with the handling of the materials mentioned and will be able to make neat and efficient coils of such types as may be desired. Celluloid dope is nothing like as messy to use as some cementing materials and its quick drying is an advantage. Making the dope is a little slow, since the celluloid tends to soften and sink in the solvent

is geared to turn about fifteen times to each turn of a hand crank, can be adapted for coil-winding purposes without great trouble. A suitable rigging is indicated in Fig. 1.

The grinder is mounted on a baseboard about six inches wide, a foot long and about an inch thick. Two hardwood uprights are mounted and braced about four inches apart, and are drilled in line with the grinding-wheel shaft for a piece of $\frac{1}{4}$ -inch rod, preferably threaded at one end. This rod is coupled to the grinding-wheel shaft in any way that is easiest; perhaps it will be found best to drill the usual cast-iron plate or nut holding the wheel, so that a projecting driving stud made from a machine screw can be held tightly, as shown. An old tuning dial (A) may be slotted radially to engage this driving stud

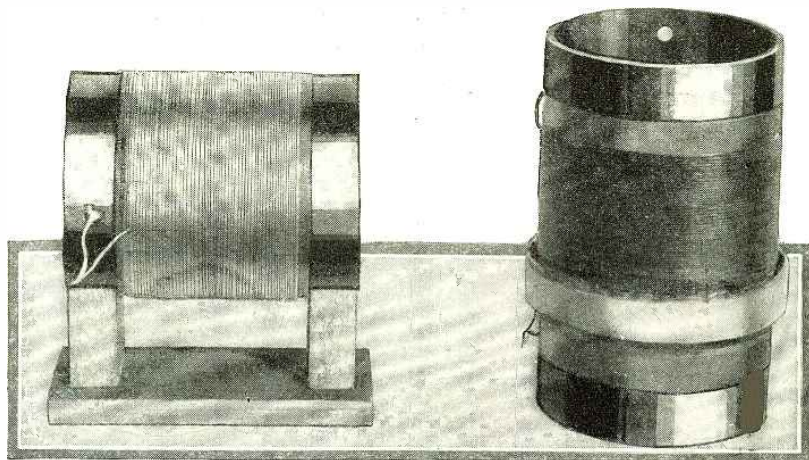
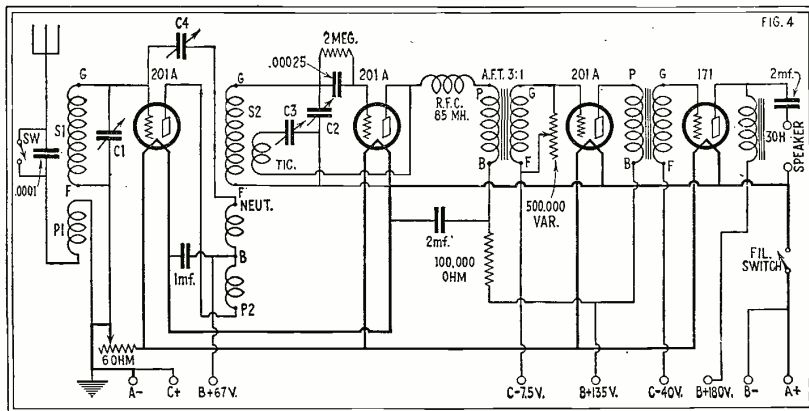

Fig. C. These coils, wound on tube forms, are mounted in the method shown in detail on the following page. The band around the detector coupler, at the right, is a fixed tickler; the primary is on a smaller tube, fitted tightly inside the secondary with the aid of heavy paper.

secondary coil, is generally the only one which must be constructed so as to have low radio-frequency resistance; the other coils are important only as they affect the secondary. It has been shown that coils having a diameter about two and a half times the winding length are most efficient; but that there is little decrease in efficiency caused by changing the coil shape, up to the point where the diameter and winding length are equal. Because small coils give less trouble from stray magnetic coupling, and are better adapted to work in shields of moderate size, it is well to use a coil shape that makes the winding length of the secondary nearly equal to its diameter.

Primary coils and windings other than secondaries are usually connected in circuits of considerable resistance, and a little resistance more or less in such coils will not make much difference. It appears very important, however, to keep from using more turns than are absolutely necessary on such a coil, and, furthermore, to make every reasonable effort to keep capacity effects between it and the secondary coil at a minimum. Capacity between the grid end of a secondary and a primary having a relatively large inductance and number of turns is particularly bad; since the tuned circuit so formed will have a considerable



Circuits similar to the well-known Roberts are still popular and capable of good work. This modification can be made to control smoothly, and is unusually good mechanically.

is to use a winding tube that is 1/4-inch smaller in diameter than that on which the secondary is wound. Use a strip of celluloid wide enough so that the primary can be wound and located just under the filament end of the secondary coil, as indicated in Fig. 3. To make the celluloid strip

an appreciable distance to prevent serious capacitive coupling; but too-great separation may seriously reduce the effective magnetic coupling. Space-wound coils, particularly where the diameter is small, often have the effect of decreasing the coupling between primary and secondary; since the

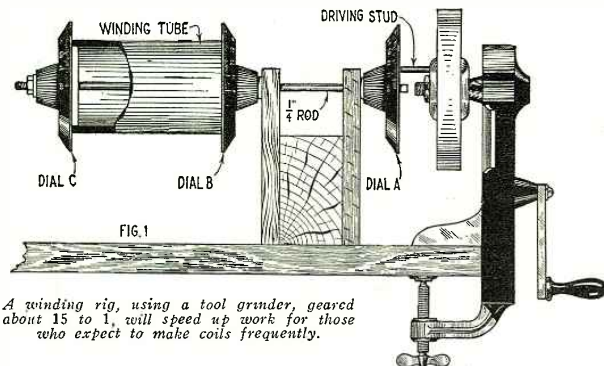

A winding rig, using a tool grinder, geared about 15 to 1, will speed up work for those who expect to make coils frequently.

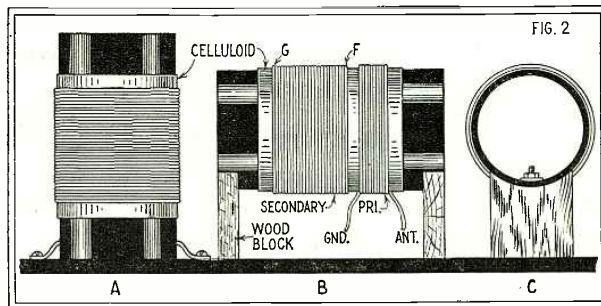

Unless completely shielded, coils should be mounted at right angles to each other and several inches apart.

effect on the tuning of the secondary and may greatly increase its resistance.

Fine wire, from No. 34 to No. 36, S.C.C. or D.C.C., has a marked advantage for use in primaries and the like; because such wire may be so located that capacity to the secondary is small and the desired value of mutual inductance can be obtained without requiring an excessive number of turns. A good way to make and locate a primary

supporting the primary fit exactly the inside diameter of the secondary tube, a strip of paper about 1/2-inch wide may be cemented and wrapped over the end as indicated in the figure. The winding tube is, preferably, removed from the primary winding since its mechanical strength is not needed.

Wherever coils are to be inductively coupled, the windings should be separated

spread-out secondary is further away from the primary than is the case with a close-wound coil. Coupling difficulties will often nullify, to some extent, the apparent advantage of low resistance in a spaced secondary coil.

Tunable transformers or coils should have correct inductive values and coupling values to afford correct tuning and set balance; and it is not advisable to look at only one feature when selecting a design or type of winding. It is easy in making coils to improve one feature at the expense of others, but it is the total merit of all coil features in combination that counts.

DESIGN OF A TUNING UNIT

In order to illustrate coil construction by a practical example, a four-tube circuit, similar in plan and performance to the well-known and popular Roberts, is shown in Fig. 4 with coil details in Figs. 2 and 3. The circuit diagram is practically self-explanatory, all coils being wound in the same direction and the correct end connections being indicated. Secondaries S1 and S2 may be wound on a 2-inch form and will have 66 turns each of number 26 D.C.C. wire, giving a winding length of an inch and a half; such secondaries being tunable by .0005-mf. tuning condensers. If .00035-mf. tuning condensers are to be used,

(Continued on page 260)

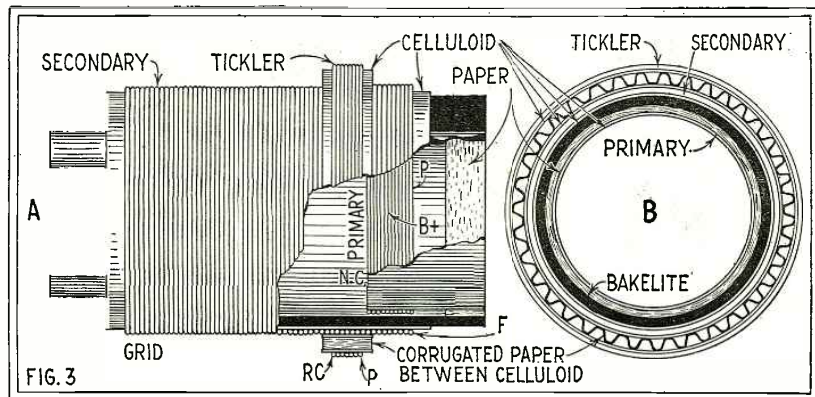

Details of the detector coupler; the turn specifications are given in the text at the right. There are four windings with fixed coupling; the neutralizing coil and the primary are one tapped coil.

The Screen-Grid Stroboddyne Receiver[★]

A Supersensitive Set Utilizing an R.F. and Two Intermediate Stages of High Amplification and Push-Pull Audio Output



By R. E. Lacault

EXACTLY one year ago the Stroboddyne circuit was presented for the first time to American radio experimenters by the writer, in the columns of RADIO NEWS. The original American Stroboddyne receiver was described fully, with all necessary details for its construction, and it quickly gained great popularity. Reports were received from set builders in all parts of this country, and others as well, describing the excellent performance secured and the remarkable long-distance records established.

Regardless of how much satisfaction a receiver may have given, radio fans are always anxious to make improvements whenever possible. This is evidenced by

1928's Most Sensitive Circuit

LAST year the Stroboddyne was presented by RADIO NEWS as the "Greatest Circuit of the year." The receiver which was described out-performed the best superheterodynes, and was unexcelled for distance with great selectivity. Since that time the only receiver which has been found superior in the respect to the original Stroboddyne is the Screen-Grid Stroboddyne, which is described in these pages. The new model of the receiver operates on the same principle, but uses screen-grid tubes in one R.F. and two I.F. stages, and push-pull amplification with power tubes in the A.F. circuit, thus providing the set with even greater sensitivity, volume and quality of reproduction.

It is possible to appreciate fully the great sensitivity of the Screen-Grid Stroboddyne only by testing it in direct comparison with other receivers. In the new Stroboddyne the R.F. circuits are totally shielded and, when the shield covers are securely shut by tightening the corner screws, it is impossible to receive signals if the aerial and ground wires are disconnected. However, if the screws are loosened slightly, the shield will "leak" sufficiently to allow the sensitive circuits to pick up the signals of local stations. Also, under favorable conditions, the receiver will intercept the programs of stations within a twenty-mile area while using an aerial only one foot in length and, while under test in New York City, it consistently received the signals of Philadelphia stations during daylight hours while using a four-foot aerial.

the fact that, as soon as the new screen-grid tubes made their appearance on the market, hundreds of letters were received from Stroboddyne owners requesting instruction how to adapt their sets for use with these tubes. The screen-grid tube, it may be repeated, is a special four-element vacuum tube which is capable of providing far greater amplification than the standard types of tubes; it requires high plate potentials for its operation, and it may be used only in special circuits. When efficiently employed, it will give an amplification of from 30 to 50 per stage, as compared with the 7 which is the amplification constant of the 201A-type tube.

It has been stated above that the new

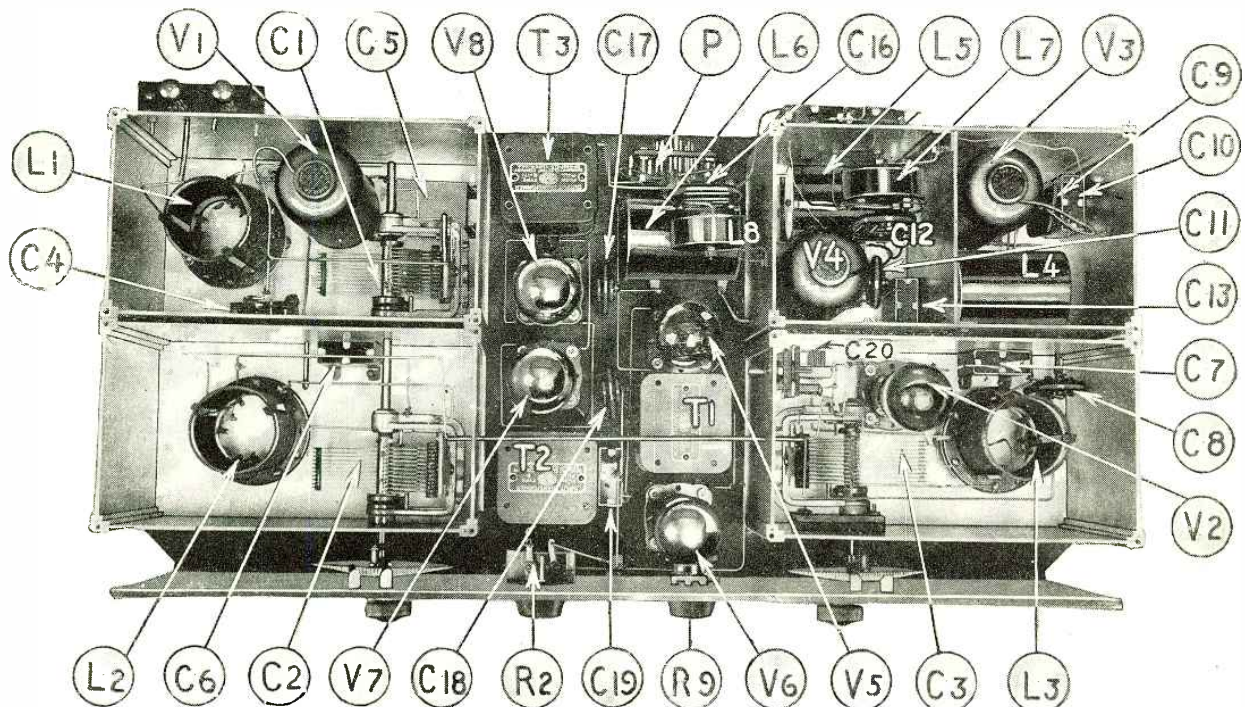

Fig. C. In this view of the Screen-Grid Stroboddyne, the set, with the shield covers removed, is viewed from the top. Practically all of the parts may be located in this picture; the symbols used correspond to those employed in the other illustrations, text and list of parts.

* RADIO NEWS Free Blueprint Article No. 63.

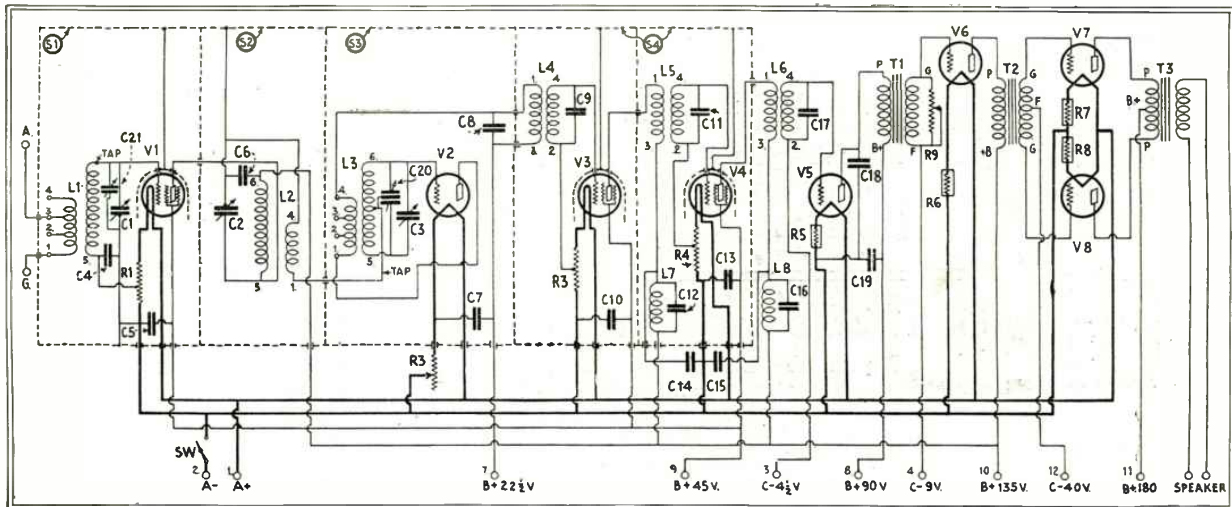

Fig. 1. The complete schematic circuit diagram of the Screen-Grid Stroboddyne is given above. The dotted lines indicate shielding, and the parts shown within the dotted lines are located in the shield compartments.

screen-grid tubes may be used only in special circuits. Because of this fact, it was considered inadvisable to attempt to adapt the original model of the Stroboddyne to these tubes. It would be possible to make elaborate changes in the set which might permit the incorporation of screen-grid tubes; but the circuit would not be highly efficient, and therefore little or no advantage would be gained by the change. On the other hand, these additions and alterations to the original Stroboddyne would complicate the receiver to such an extent that, probably, it would not be as satisfactory as with 201A-type tubes.

REDESIGNING THE RECEIVER

However, experimenters may avail themselves of the combined advantages of the Stroboddyne circuit and of screen-grid tubes by another method. The writer has developed a new model of the Stroboddyne, which has been designed especially to take full advantage of the high amplification factor of screen-grid tubes; this new receiver, which is fully described in this article, is

known as the "Screen-Grid Stroboddyne," and is believed by the writer the most sensitive receiver of its kind in existence.

When designing the Screen-Grid Stroboddyne, the writer's chief desire was to build a receiver possessing maximum selectivity. Secondly, he endeavored to make the construction as simple as possible. Thirdly,

noise level at all times, and therefore, nothing more can be expected or desired in this direction. By virtue of the screen-grid tubes, the intermediate-frequency amplifier provides enormous amplification, the selectivity is more than enough to satisfy all conditions, and excellent quality of reproduction is obtained by using push-pull audio amplification with power tubes in a transformer-coupled circuit.

IMPORTANCE OF DETAILS

A glance at the diagrams on these pages may cause the reader to think that the construction of the set is unnecessarily complicated. However, it must be remembered that, because of their great amplification, in circuits using screen-grid tubes special precautions must be taken which are not necessary in the average set. Each circuit and each screen-grid tube must be shielded very carefully. R.F. choke coils and by-pass condensers are needed in many positions in the circuit, and the arrangement of apparatus must be considered very carefully in order to prevent undesired coupling. Therefore, it will be necessary for the set builder to endeavor to duplicate in every particular the receiver illustrated here, if he is desirous of taking full advantage of the high amplification obtainable from screen-grid circuits.

In order to perfect the design of the Screen-Grid Stroboddyne as much as humanly possible, two receivers of the new model were constructed. The two have been tested in various locations in New York City and in several laboratories. In this way the author was able to assure himself that the Screen-Grid Stroboddyne will perform satisfactorily under various operating conditions, and also that it can be duplicated easily. While it is not possible to state what any set will do in any particular location, because local conditions even over a small area affect results, it has been proved by these tests that, as far as sensitivity is concerned, this receiver far outperforms many eight- and nine-tube receivers which previously were considered of the highest sensitivity.

In test at one location in New York City, it was found that, with the shielding securely in place and the aerial and ground wires disconnected, it was impossible to

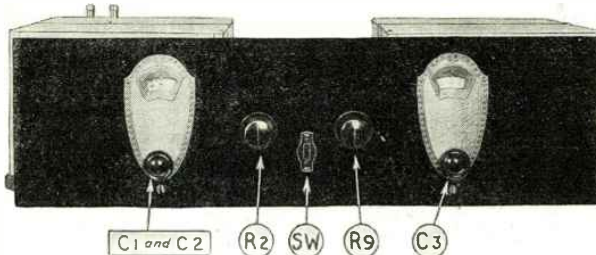

Fig. D. The two illuminated vernier dials are the only wavelength tuning controls of the receiver. R2 is a filament rheostat and R9 the volume knob. The battery switch (SW) is the only other control mounted on the front panel.

selectivity, tone quality and ease of operation were considered. The design which is presented herewith measures up to expectations in every way. It is believed that the receiver has been built in the simplest manner possible, and that it is no more difficult to operate than the average superheterodyne; in fact, much simpler than most. The sensitivity is sufficient to reach the

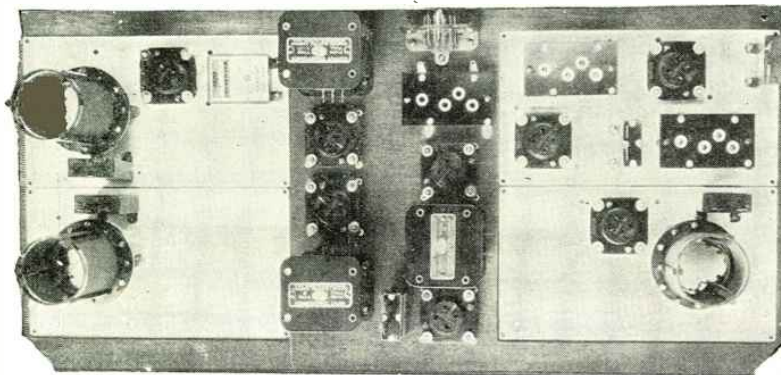

Fig. A. This picture shows the completion of the first step in constructing the receiver. The apparatus illustrated is mounted on the baseboard and then the wiring is started in the A.F. amplifier and from the cable plug to various points in the set.

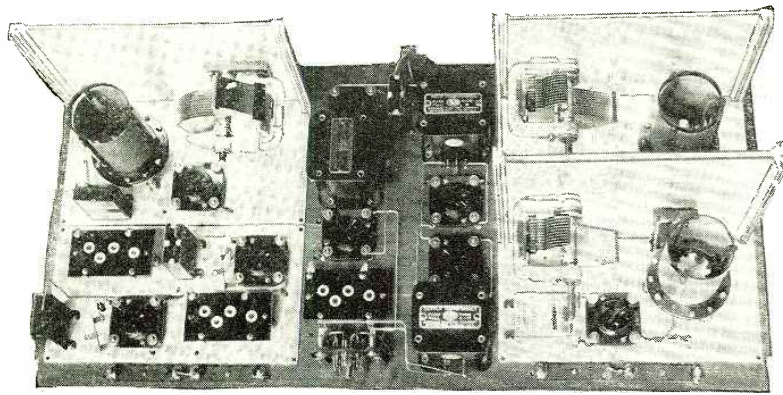

Fig. B. The second step in the assembly of the receiver is shown above; the front sections of three of the shield compartments are erected and the variable condensers are mounted in their proper positions. With the set in this condition it is possible to practically complete the wiring.

pick up any trace of signals. However, with a piece of wire less than one foot long connected to the aerial binding post, it was possible to receive all New York City stations with good volume. When using a wire four feet long as an aerial, and without a ground connection, Philadelphia stations were received at noon with good volume.

With the Screen-Grid Strobodine, the word "Sensitivity" takes a new meaning and a new radio realm is opened to the owner of one of these new sets; provided it has been constructed carefully and as described in this article. To tell the truth, the writer was himself astonished at the results obtained with the set, although he had worked on the design for several months in order to make every detail perfect and to secure the maximum efficiency from each circuit. Therefore, he feels sure that the results from the receiver will surprise agreeably any experimenter who builds it.

COMPONENTS NEEDED

The following is a complete list of the parts required for the construction of the Screen-Grid Strobodine receiver:

- Three variable condensers, .0005-mf., removable-shaft-type (C1, C2 and C3);
- Three R.F. transformers, screen-grid-type (L1, L2 and L3);
- One A.F. transformer, standard-type (T1);
- One A.F. transformer, push-pull input-type (T2);
- One A.F. transformer, push-pull output-type (T3);
- One volume-control resistor, 0-100,000-ohm (R9);
- One filament rheostat, 0-20-ohm (R2);
- One battery switch, toggle-type (SW);
- Four aluminum shields, 5 x 6 1/4 x 9 inches (S1, S2, S3 and S4);
- Two filament-ballast resistors, 201A-type (R5 and R6);
- Two filament-ballast resistors, 112-type (R7 and R8);
- Three tapped fixed resistors, 10-25-ohm (R1, R3 and R4);
- Two R.F. choke coils (L7 and L8);

- One intermediate-frequency transformer (L4);
- Two intermediate-frequency transformers, screen-grid type (L5 and L6);
- Six fixed condensers, matched, .00025-mf. C8, C9, C11, C12, C16 and C17);
- One fixed condenser, .002-mf. (C18);

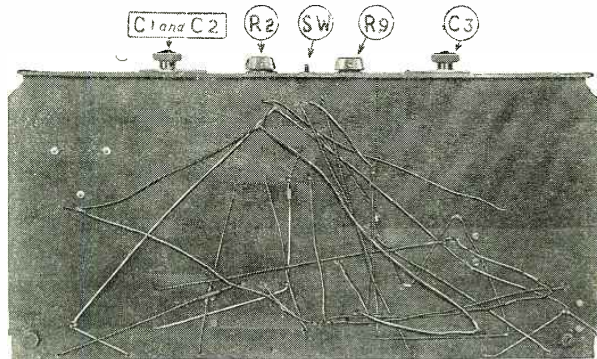

Fig. E. A large part of the wiring is located under the baseboard of the receiver, as shown in this picture. A majority of these wires are battery connections direct from the cable plug.

- Nine by-pass condensers, 0.5-mf. (C4, C5, C6, C7, C10, C13, C14, C15 and C19);
- One double-stator balancing condenser, maximum capacity 50 mmf. per stator (C20);

- One equalizing condenser, 2-20-mmf. (C21);
- Eight vacuum-tube sockets, UX type;
- Two tuning controls, vernier illuminated type;
- Three copper tube-shields, screen-grid type;
- Three adapter rings for tube-shields;
- One battery cable and plug, 12-wire type (P);
- One extension condenser shaft 10 1/4 inches long, 1/4-inch diameter;
- One wooden baseboard, 1/2 x 12 x 25 1/4 inches;
- One front panel, 3/16 x 7 x 24 inches;
- Two insulating mounting plates for variable condensers, 2 1/4 x 1 1/2 x 3/16 inches;
- One binding-post strip, 3 x 3/4 x 3/16 inches;
- One binding-post strip, 3 1/2 x 1 x 3/16 inches;
- One 1/4-inch bakelite rod, 4 inches long;
- Forty feet of flexible insulated hook-up wire;
- Twenty feet of No. 16 gauge bus bar;
- Three clips for screen-grid tubes;
- Three screen-grid tubes (222-type) (V1, V3 and V4);
- Two standard amplifier tubes (201A-type) (V2 and V5);
- One semi-power tube (112A-type) (V6);
- Two power tubes (171-type) (V7 and V8).

In addition to the radio parts described above, the following hardware is needed in building the receiver:

- Eighteen 6/32 round-head brass machine-screws 3/4-inch long;
- Twenty-two 6/32 round-head brass machine-screws 1/2-inch long;
- Three No. 8 flat-head brass wood-screws, 1 inch long;
- Nine No. 6 round-head brass wood-screws, 1 1/4 inches long;
- Thirty-three No. 5 round-head brass wood-screws, 1/2-inch long;
- Six No. 6 flat-head brass machine-screws, 1 1/4 inches long;
- Ten No. 5 round-head brass wood-screws, 1 inch long;
- Six No. 5 round-head brass wood-screws, 1 1/4 inches long;
- Nine spacers, 1 inch high;
- Four dozen 6/32 nuts;
- Two pieces of angle brass, 1/2 x 1/2 x 6 inches, to support partition in shield S4;
- One aluminum sheet, 4-21/32 x 6 x 1/16 inches for shield partition;
- Two brackets to support coils L7 and L8.

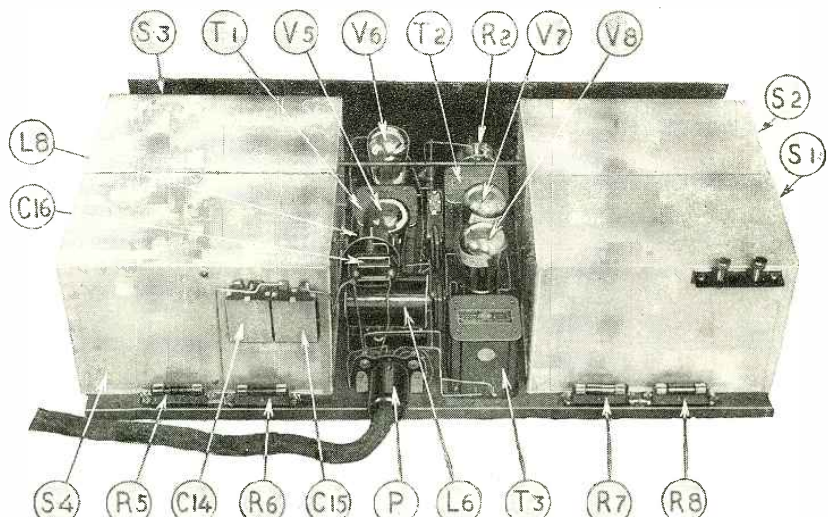

Fig. F. This rear view of the Screen-Grid Strobodine shows the appearance of the set after the construction has been completed.

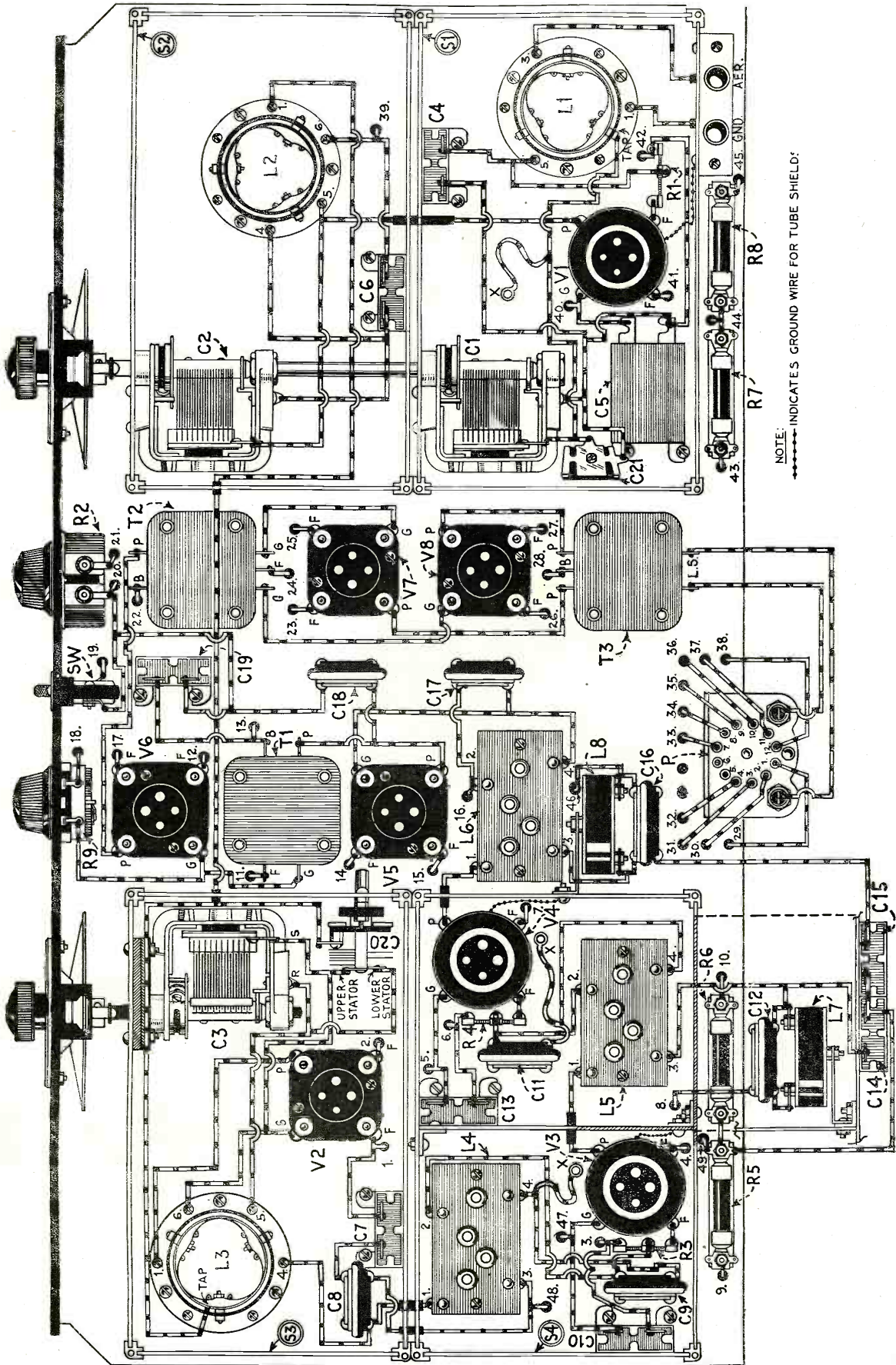

Fig. 2. This pictorial diagram of wiring above the baseboard, together with Fig. 3, the diagram of wiring under the baseboard, give complete details of all electrical connections in the Screen-Grid Stroboddyne and indicate the relative position of all parts. In these two diagrams, wherever a wire passes through a hole in the baseboard, it is identified by a number, and these numbers correspond in the two diagrams, thus making it easy to follow the wiring.

HOME WORK REQUIRED

The Screen-Grid Stroboddyne is *not* a kit receiver, and its construction cannot be described in the same manner. Fans build-

ing the usual kit receiver will find that drilled panels, shields and chassis are available to facilitate the construction, and the directions for the assembly of such set are,

therefore, very simple. However, with the Stroboddyne, the builder has to drill his own panels, shields and baseboard; and he will find that parts of the mechanical construction require some skill with tools. In this article, therefore, the writer will attempt only to suggest ways of assembling the various parts of the set, but, without doubt, in many cases the builder will find it necessary to work differently.

The first problem which confronts a prospective owner of a Screen-Grid Stroboddyne is obtaining the various coils. All of the coils used in the original model are factory-made products; but it is possible to make such coils at home, and complete details are given in Fig. 5.

Coils L1, L2 and L3, as shown in the drawing, are of skeleton construction. This design makes possible the highest electrical efficiency, but often taxes the ability of the home constructor. If it is found too difficult to employ this method of construction, a standard bakelite tube may be used as a coil form. This change may make necessary a reduction of one or two turns on the windings of each coil, but this is best determined after the receiver has been constructed.

Coils I4, L5 and I6 are the intermediate-frequency transformers. These are wound on wooden bobbins of the dimensions shown in the diagram. The primary and secondary windings are of exactly the same size, and should be wound simultaneously. After the coils have been completed, they *must* be matched carefully with a laboratory oscillator. (The method to be followed is described fully in the *RADIO NEWS* Superheterodyne Book in an article by Prof. Grover Ira Mitchel, entitled "Matching Intermediate Transformers." This article was also published on page 51 of the July 1924 issue of *RADIO NEWS*.) *The experimenter who does not possess the facilities of matching these coils is advised not to attempt their construction.* Also, if home-made coils are used, the condenser C9, which is connected across the secondary of the first intermediate-frequency transformer (I4), is not required and should be omitted from the circuit when building this set.

ORDER OF ASSEMBLY

The illustrations which accompany this article clearly show the construction of all parts of the receiver. In building the set, the parts mounted on the baseboard are fastened in place before starting wiring, as shown in Fig. A. Next the wiring is completed as far as possible, and then the parts shown in Fig. B are mounted. After the set has reached this stage of completion, the remainder of the wiring is put in. The front panel is then fastened in place and the receiver is practically completed. Fig. C gives the appearance of the completed receiver, with shield covers removed, when viewed from the top; Fig. D shows the arrangement of controls on the front panel of the set; Fig. E, the method of concealing battery wires under the baseboard, and Fig. F, the completed receiver with shields in place.

Those who wish to build the set from the schematic diagram, will refer to the complete circuit in Fig. 1. However, those who prefer to work from pictorial drawings, will find the wiring layout in Figs. 2 and 3. In addition to these illustrations, Fig. 4 shows the exact location of all parts on the sub-base, and Fig. 6 is the drilling layout for the controls on the front panel.

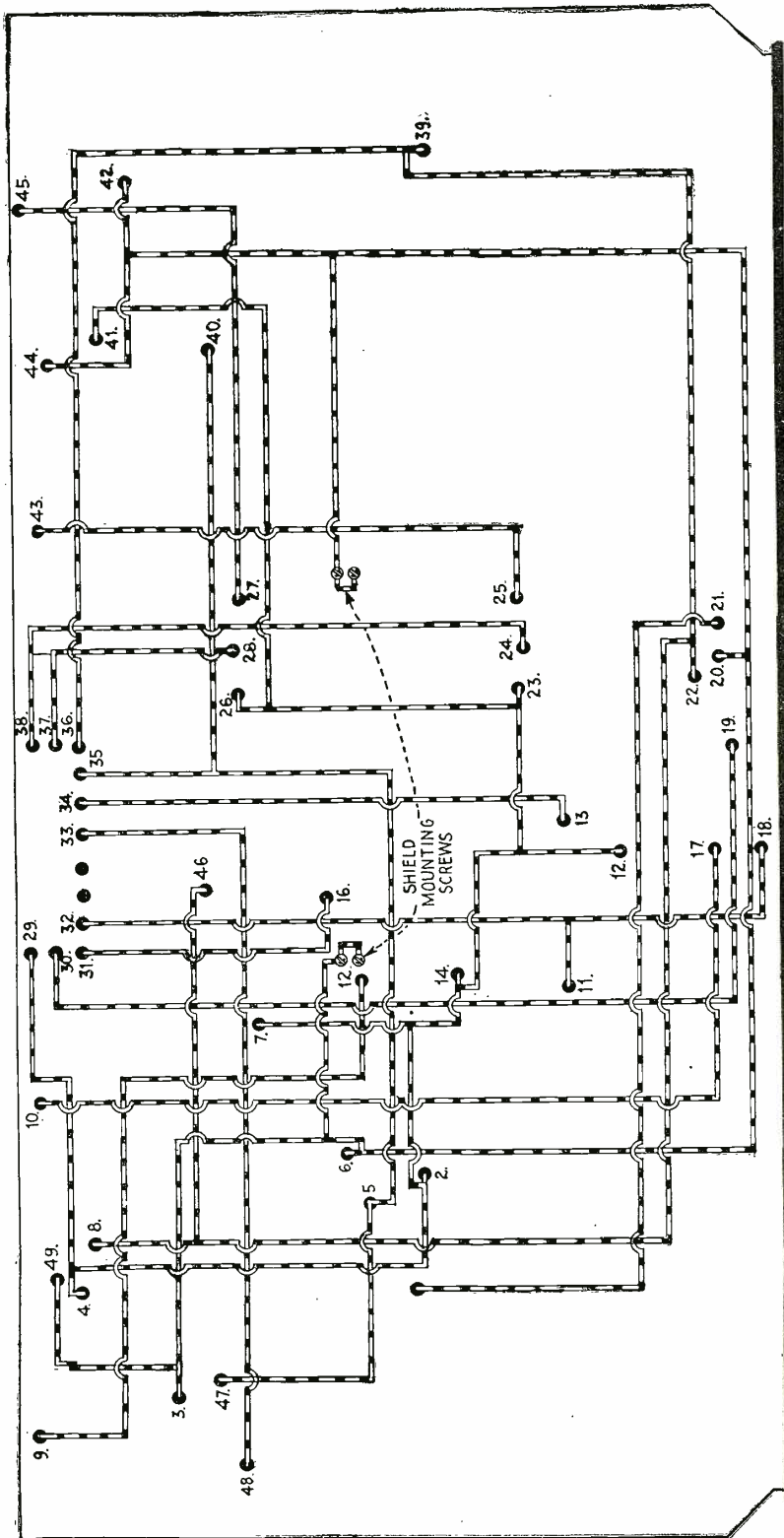

Fig. 3

Pictorial diagram of wiring under the baseboard of the Screen-Grid Stroboddyne.

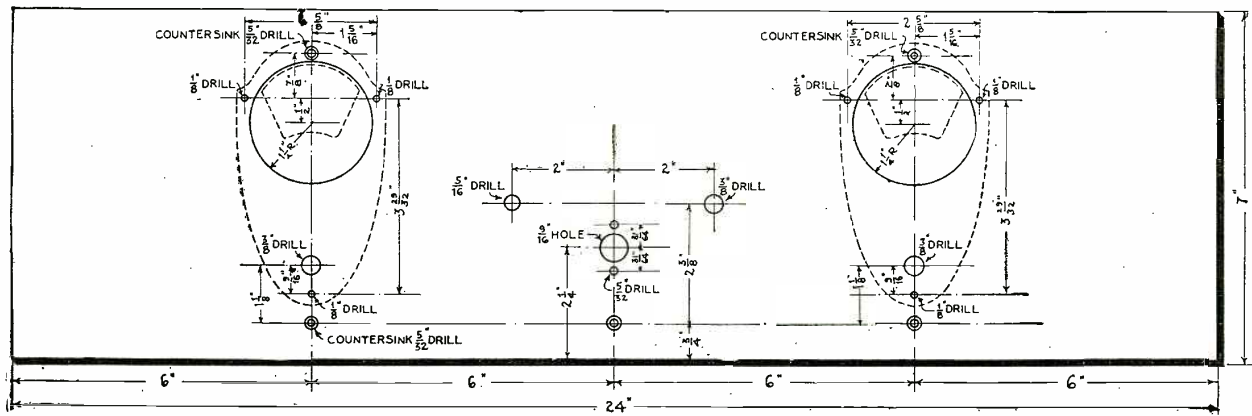

Fig. 6. This drilling layout shows the exact position of all holes in the front panel required for mounting the tuning controls of the set with the apparatus originally used.

More detailed information on building the set follows.

ASSEMBLY AND MOUNTING

After all of the required parts have been purchased or made, the first step to take in building the receiver is to lay out the wooden baseboard, which is 1/2 x 25 1/4 x 12 inches. It is important that the baseboard be exactly this size; as a smaller base would cramp the apparatus, and a larger base would not fit into the standard radio cabinet. Before mounting parts on the baseboard, draw a line through the center, running from front to back of the board. Then draw two more lines; one on each side of the center, parallel to the center line and 3 1/2 inches away. Now draw a line 1 1/4 inches from the front edge of the baseboard and parallel to it from one end to the other. These lines should be drawn accurately with a ruler.

The first parts to be mounted on the baseboard are the bases of the four shield sections. However, before the shields are mounted, they should be accurately drilled for the apparatus which is to be mounted on them. The two front shields (S2 and S3) are mounted first, and so placed that

their front edges fall upon the line which was drawn 1 1/4 inches from the front of the baseboard, and their inner edges upon the lines which were drawn 3 1/2 inches from the center line. With the shields in this

at the wrong angle. The bases of the shields are temporarily fastened in place by mounting the tube sockets or some other pieces of apparatus.

TUBE-SHIELD BASES

Before mounting the rear-shield bases S1 and S4) on the baseboard, it will be well to adjust the insulating rings of the shields for the screen-grid tubes, on the three sockets (V1, V3 and V4) which are mounted at the back. To do this, remove the screws and nuts which hold the springs of the sockets, and use instead of these screws the threaded pins which are fastened in the bakelite ring used to support the tube shield. (See Fig. 7.) This is accomplished easily and should be done now in order to fasten the sockets on the rear shield and hold them in place. However, before fastening the rings on the base of the sockets, the two mounting holes in the socket-base proper should be countersunk; so that flat-head machine screws may be used to fasten the sockets down on the baseboard.

The proper order is, therefore, to countersink the holes in the socket-base, introduce the two machine-screws in the holes of each socket and, after the screws and nuts

No. 63

A set of large blue-prints and a list of the parts used in the construction of the Screen-Grid Strobodome receiver shown here will be sent postpaid to any applicant. See that your name and address are written or printed legibly. Ask for Blueprint No. 63.

position there is between them in the center of the baseboard a space of 7 inches which is available for mounting the amplifier apparatus. In mounting the front shields it is highly important that they be placed accurately; because they support the variable condensers and, if the shields are not straight, the condenser shafts will be

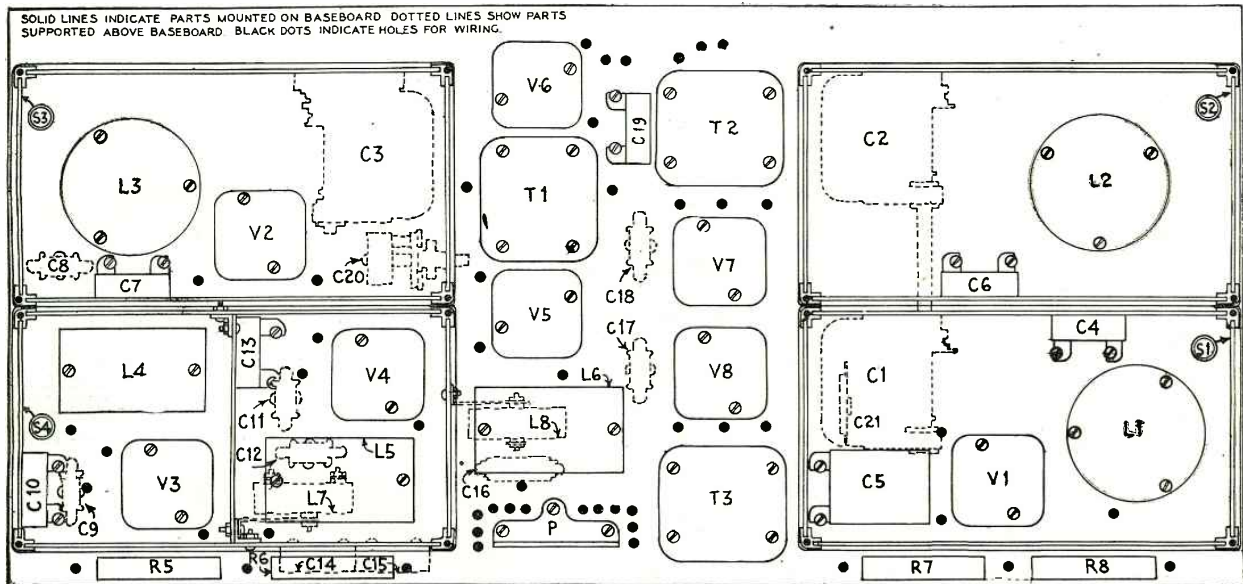

Fig. 4. In the above parts-layout each piece of apparatus is shown on the baseboard in exactly the correct position; and the sizes of the parts are in proportion to the size of the baseboard. Parts shown in dotted lines are supported above the baseboard.

are removed from the four corners of the socket-base, the ring is placed in their stead and the four blades of the socket are held in place by the nuts which fasten on the threaded pins of the bakelite ring.

Next, line up the rear shields (S1 and S4) so that they will be exactly straight with the front one, as shown in the parts layout, Fig. 4. Again, it will be of advantage to use a square and ruler in order to have the shields lined up exactly parallel to the front of the baseboard. These may be held in place by the three sockets upon which the bakelite rings have been mounted.

Once the sockets are holding the bottom of the shields tight, you may drill all the holes through which the wiring is to pass, as well as the four holes in the corners of each shield for passing the long screws which hold the corner posts of these shields.

Next mount the audio amplifier apparatus on the baseboard and all the other parts on the bottom of the shield. In mounting the coils (L1, L2 and L3), spacers one inch high should be used to place the coil exactly in the center of the shield; that is, equidistant from the top and bottom.

If manufactured coils are used, it will be necessary also to remove 8 turns from the top of the coil (L3) and to take a center-tap connection in the middle of this coil. Connection to this tap, however, is made later when wiring the inside of the shield. Also, the connection from the grid of V1 to the secondary of L1 is made at the top of the coil, and the wire connecting this end of the coil with terminal 6 at the base of the coil is cut off.

Drill the holes in the plug (P) for the two phone-tip jacks, which are used for the output, and into which the loud-speaker tips

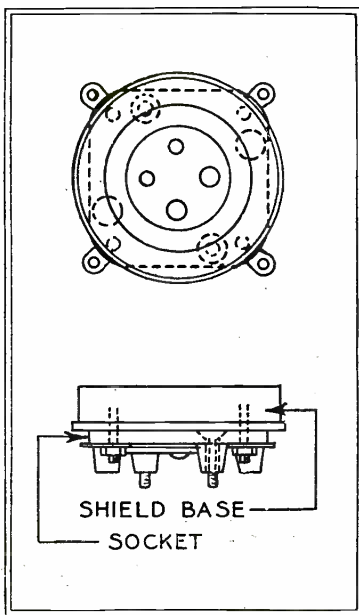

Fig. 7. Shields are required in connection with the screen-grid tubes (V1, V3 and V4) of the receiver; and the bases which support the shields must be attached to the sockets as shown.

are plugged. Holes are provided in the panel of the plug for mounting such jacks; but they are not of the correct diameter, and it is necessary to enlarge them to mount the phone-tip jacks which will be used in the set. The jacks should not, however, be mounted at this time; for it is necessary to

leave free access to the pins behind the small panel of the plug base, in order to solder the various leads to the pins.

The wiring may then be done; this is started by running wires from each one of the pins on the plug (P) to the various points where they should connect, and this is kept under the baseboard as much as possible. The wiring above the baseboard may also be started in the audio amplifier as well as inside the shields, where several connections may be put in at this time. Such connections are easily found by looking over the schematic and pictorial diagrams (Figs. 1, 2 and 3) which clearly show all the wires of the receiver. Also, at this time it should be explained that the various fixed condensers are held in position by the wiring, and that bus-bar wire is used for this purpose.

The three tapped filament resistors (R1, R3 and R4) should be connected so that the shortest (10-ohm) section is connected to the socket in each case.

The leads which are to be connected to apparatus on the panel may be left long enough to reach to these controls; so that, once the panel is fastened against the baseboard, they can be soldered easily to the lugs where they should be connected.

It is advisable to place a piece of spaghetti tubing over the wires wherever they pass through the shields, in order to prevent any possibility of the insulation being cut off by the edge of the metal. This is a precautionary measure which is worth while; as if the wire is pulled accidentally against the edge of the aluminum shield it may cause short circuits.

The next step is to drill the sides of the shields and to mount the variable condensers (Continued on page 278)

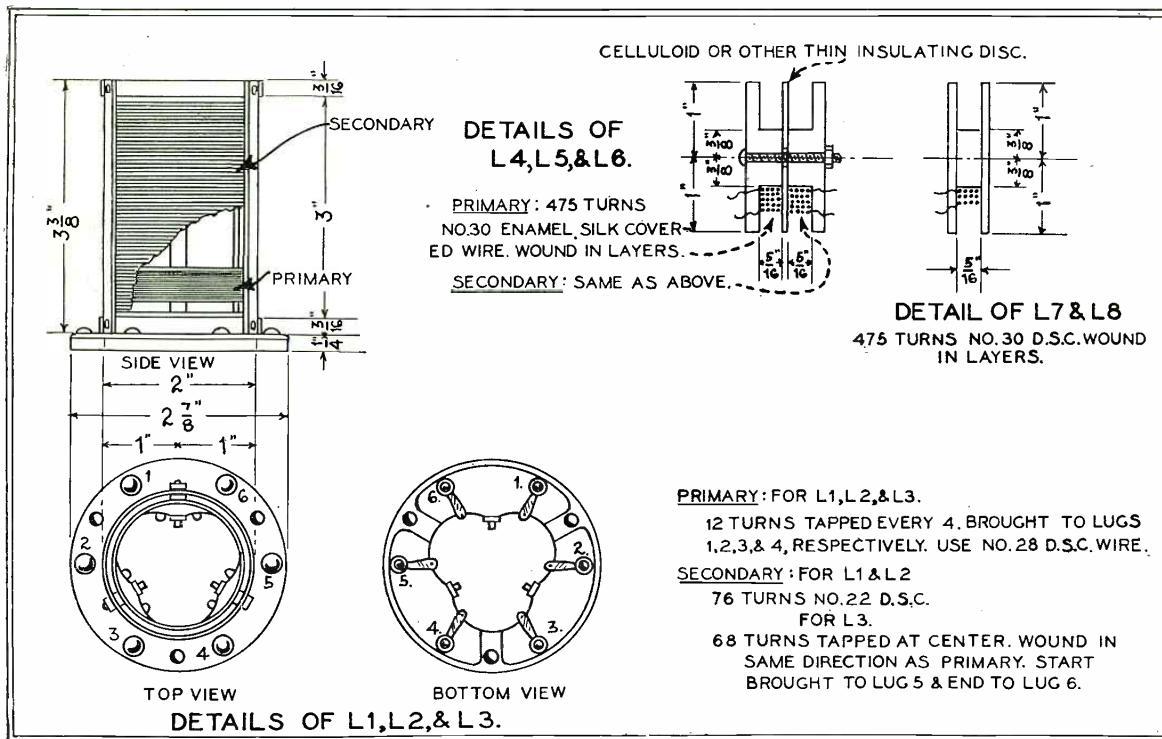

Fig. 5. These drawings give complete details for winding the various coils of the receiver. Coils L1, L2 and L3 are of air-core construction and the others are wound on wooden bobbins. If best results are desired, the coils must be wound accurately and the intermediate-frequency transformers must be carefully matched.

Radio Wrinkles

Convenient Indoor Aerial

MANY people who are planning to erect an indoor aerial will find the following an efficient substitute. Run a wire from the aerial binding post of the receiving set to the nearest electric-light fixture box, and connect it under the small screw which holds the cover or outside brass plate to the box, in the case of the plate usually found on the wall or baseboard for an extension plug. In making this connection, care should be taken not to connect the aerial lead to the lighting wire or to the extension plug; but only to the metal face plate, which in turn is connected to the conduit. In cases where the screw holding the plate or cover is not connected to the box, as on some old-style fixtures, it is a simple matter to drill a hole in the box large enough for a screw to be inserted.

This plan makes use of the conduit as an aerial and in many cases has been found to be more efficient than the usual type of indoor aerial, at the same time eliminating a lot of hard work.—Edmond Greenhaw.

An Easy Way to Twist Leads

IN building a receiver using A.C. tubes, it is essential that the filament wires be twisted. Some radio fans may be of the opinion that this practice has come into common use because twisted wires improve the appearance of the receiver, and, at the same time, make it easy to locate the wiring in the filament circuit when shooting trouble. However, this is not the primary reason. By twisting the wires the stray field of the alternating current is reduced greatly and this prevents considerable hum in the output, which would otherwise be picked up by the various other circuits of the receiver. In other words, twisting A.C. wires together gives the effect of partial shielding.

To the radio constructor who is particular about the appearance of his receiver, the twisting of filament wires presents a problem. Of course, twisted wire may be purchased at most radio and electric stores, but it is not always available in the desired size and color. Because of this fact many fans find it necessary to make their own twisted filament wires from ordinary radio hook-up wire, and it is difficult to twist the wire uniformly so that it presents a good appearance.

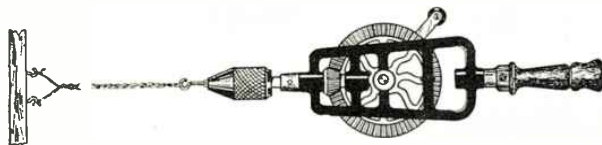

This problem may be solved by using an ordinary hand drill. First, take a piece of hook-up wire with a length slightly greater than twice that of the desired twisted pair, and fasten its ends to two nails placed

about one inch apart in the wall. Now take a hand drill, insert a hook in the chuck in place of a drill, loop the wire over the hook and crank the drill. In this way uniformly twisted wire may be made in a few minutes' time.

The use of a color code is another excellent plan to follow when building an A.C. receiver. All 1½-volt wires should be black, 2½-volt wires should be yellow, and 5- or 7½-volt wires should be red. This makes it easy to identify each wire after the set has been constructed.—C. E. Stoodley.

A Handy Speaker Switch

AN ordinary UX-type tube socket makes an excellent device for connecting loud speakers to radio receivers. Where there are two loud speakers of different characteristics (such as a horn and a cone) the tube socket may be used as a switchboard for instantly connecting either speaker with the receiver, or for connecting both speakers for simultaneous operation. This is also very convenient when it is desired to

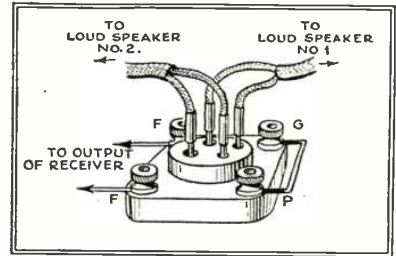

Here is a common tube socket turned into a control board for the operation of two loud speakers from a set. Several combinations are possible.

operate in different parts of the house. connected in series, as this arrangement usually provides most satisfactory results. However, if it is found that better results may be obtained by connecting the loud speakers in parallel, it is a simple task to change the wiring of the socket to make this possible. The wire connecting the grid and plate binding posts of the tube is removed, and two wires are substituted. One wire connects the grid post to the filament post on the same side of the socket, and the other connects the plate post to the remaining filament post. In order to connect two speakers for simultaneous operation, with this system, the tips of one loud-speaker cord are plugged into the two filament holes and the tips of the other cord are plugged into the grid and plate holes. If it is desired to disconnect one of the speakers, it is necessary only to remove the tips from the socket.

Fans who wish to experiment with speakers and try various connections may find a need for two tube sockets, one connected for operating speakers in parallel and the other for operating speakers in series. This arrangement will also make possible the simultaneous operation of as many as four speakers.

Sometimes it may be found that, when a speaker is first plugged into the tube socket, it does not make a good contact. This trouble may usually be corrected by cutting off a small amount of the small end of the tip. Also, it may be found necessary to slightly ream the smaller holes of the socket; i.e., the grid and plate holes.—L. K. Sherman.

RADIO NEWS has received from readers so many letters and ballots requesting more "Wrinkles" that it has been decided to re-establish the department. A year's subscription to RADIO NEWS will be given in compensation for each accepted item. If the author of the wrinkle is already a subscriber, his subscription will be extended one year or he may accept a one year's subscription to Science and Invention or Amazing Stories, both published by the Experimenter Publishing Co.

operate the speakers in different parts of the house.

In connecting the socket with the set, the two wires from the jack, or output binding posts, are connected with the filament terminals of the tube socket, and the grid and plate terminals of the socket are connected together. Now, the tips of the loud-speaker cords may be plugged into the four holes in the socket designed to receive the tube prongs. In order to connect both speakers for simultaneous operation, one tip of each speaker cord is plugged into one filament hole, and the two free tips are plugged into the two remaining holes. In

The experimenter's hand drill is a very convenient tool for many purposes beside that for which it is designed. Here we see how A.C. leads are quickly twisted to prevent hum.

order to connect one speaker, the two are plugged into the two filament holes.

With the connections described in the above paragraph, the two loud speakers are

Glass-Tube Insulation

AN excellent insulating tubing that gives the receiving set an attractive appearance is the ordinary glass tubing used extensively in physics experiments in high schools and colleges. This may be secured at small cost at most supply stores. When this is used, it is best to employ the round type of bus bar for wiring; since the tubing is round. The glass tubing selected should just fit the wire used for wiring the set. The bending of the glass is quite simple and can be done with a small blow

torch. The bus wire should be placed inside of the tubing, and held over the blaze from the torch at the point where the bend is desired. The glass is turned gently to distribute the heat. When the tubing and bus bar become sufficiently hot, they can be bent to shape very easily.

In order to break the tubing at a right angle, it should be placed against a sharp piece of metal and struck gently with a small hammer or similar tool. If a certain wire rattles after being placed in the tubing, it can be placed over the torch and the glass softened until it is close to the bus bar. If two wires pass so close together that the tubing on them strikes together, they can be heated until the tubes are fused together. This type of connection gives the completed set a neat appearance and, at the same time, furnishes about the best possible insulation for the wiring.—*Jean P. Conner.*

Sounding Box Improves Cone's Tone Quality

THE tone quality of a cone-type loud speaker can frequently be improved by using a sounding board, which can take almost any shape or size to suit the listener's taste. However, where the available space is limited the sounding box described below will be found to give good results.

The box is five inches high and a little longer and wider than the base of the

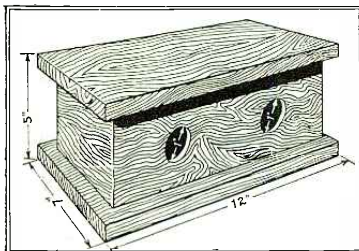

Mounting a speaker upon a suitable box of this type will often soften its tone.

speaker. The exact size, of course, depends upon the speaker with which it is to be used. It should be constructed of pine, as this seems to give better results than a harder wood. The model used by the writer measured 5 inches high, 12 inches long and 7 inches deep, with two one-inch holes drilled in the front of the box 4 inches from each end.

Besides improving the tone it has been found that such a sounding box tends to absorb considerable of the tube noise sometimes heard in the loud speaker.—*Contributed by A. F. Haviland, Associated, Calif.*

Use of Phonograph as Loud Speaker Easy

THE phonograph of the latest type, with its exponential horn, tapered tone arm, and perfected unit, is without doubt a paramount reproducer of music. Many radio fans are making use of the horn and tone arm by attaching a loud-speaker unit in place of the phonograph reproducer. This method has the disadvantage of requiring the removal of the reproducer and the attachment of the radio unit whenever used. Then, too, the phonograph reproducer is designed with an opening such that the horn

is properly "loaded" to bring out all frequencies within the range of the human ear.

Exceptional reproduction, using the phonograph reproducer—without inconvenience—can be had by arranging the phonograph unit as shown in the illustration. The unit is fastened to a small base of wood, bakelite, or metal by means of the strap. The phonograph needle rests on a small brass arm which is soldered to the diaphragm of the unit. In order to support the weight of

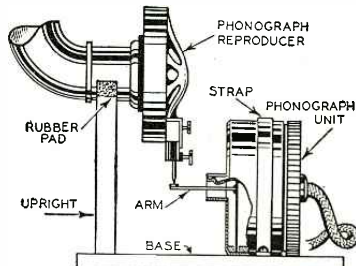

The needle of the phonograph is simply allowed to rest upon the vibrating unit in the receiver's output.

the phonograph reproducer, it is advisable to fasten an upright to the base upon which the neck of the tone arm may rest. A rubber pad between the upright and tone arm will prevent any possibility of mechanical vibration.

Cone-speaker units, which are very inexpensive, may also be used in a like manner. When such units are used, there are no artificial tones, as neither the phonograph reproducer nor the cone unit has an appreciable frequency of its own.—*Dana S. Greenlaw.*

A Home-Made Battery-Switch Relay

A REMOTE-CONTROL box is a handy accessory to the receiving set, especially during the summer months, when it is often desirable to move the loud speaker out of doors or from room to room in the house. By using the unit described below, it is possible to accomplish this with the least possible effort on the part of the operator.

The control unit consists of two parts, the control switch or relay and the control box. In using this method of operating the receiving set, only the control is moved with the loud speaker; the control switch being placed in or near the set.

The control switch consists of two electro-magnets, which are mounted on the back of a small box about three inches apart. The armature of the relay is mounted just above the magnets, as shown in the diagram. A small bottle, about 3

The tilting back and forth of a tube containing mercury—hardly more than a drop required—opens and closes the filament circuit from a distance. Heavy house wiring is not required.

inches long and 1 1/4 inches in diameter, is fastened to a piece of light wood, 4 by 1/2 inches. Two small pieces of iron are fastened on the under side of the wood, so that each is directly over a magnet core to form the armature. Enough mercury is poured into the bottle to cover the points of two pins, which project through the cork in the bottle, about 1/8-inch. Flexible wire should be soldered to the pins and brought out to two binding posts, which are connected in series with the negative "A" battery lead as shown in the diagram.

The control box contains a jack or binding posts for the loud speaker connections, a 50,000-ohm variable resistance for controlling the volume and two small push buttons for operating the control relay. These may be purchased or home-made as shown in the illustration.

A five-wire flexible cable is used to connect the control box and the receiving set and relay. This may be of any desired length and may consist of rather fine wire since it is not required to handle a large amount of current.

When the "On" button is pressed, the magnet causes the armature to tilt and the mercury runs down and covers the pin points, closing the circuit. The reverse action takes place when the "Off" button is pressed.—*Contributed by Alvin Porter, Highland, Ill.*

Rejuvenating Old Tubes a Simple Task

AFTER months of service it is frequently found necessary to rejuvenate 201A-type vacuum tubes. This can be easily accomplished by the following method. The only materials required are a UX tube socket, an old "B" battery and two short lengths of wire.

The tube is placed in the socket and two wires from the filament binding posts are connected across 22 1/2 volts on the "B" battery for a period of 45 seconds. The tube is then taken from the socket and replaced in the set, from which the "B" battery has been disconnected, and the filament rheostat is turned on full for a period of about ten minutes. Great care should be taken to see that the tube does not remain connected across the 22 1/2-volt battery more than 45 seconds, or it will be burned out.

An old tube rejuvenated in this manner will frequently give as good results as a new one.—*Contributed by E. E. Youngkin, Altoona, Penn.*

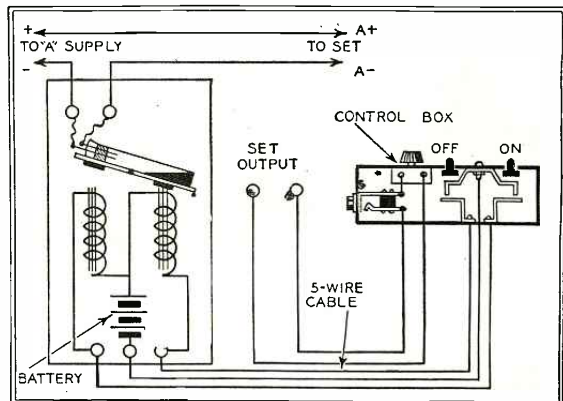

Screen-Grid Tubes as A.F. Amplifiers

Considerations Necessary in the Design of Circuits Employing 222-type Tubes Effectively at Low Frequencies

By William H. Fortington



THE screen-grid tube has been well exploited as an amplifier at super-sonic ("intermediate") and radio frequencies, in which capacities it has met with considerable success. Articles devoted to the application of the screen-grid tube, now known in common parlance as the "222" type, have appeared in many magazines throughout this country; tubes performing similar functions have been in use for nearly two years in Europe.

The use of the screen-grid tube as an audio-frequency amplifier has been somewhat restricted, however, because of many of the inherent characteristics of the tube; the chief of which calls for an extremely high external-load impedance to produce good tonal quality.

While resistance coupling might seem to be an easy solution to the problem, it appears that, after all matters have been weighed with due consideration, the disadvantages of resistance coupling in this respect outweigh its advantages. The output impedance of the 222-type tube varies considerably, such variation being dependent upon the particular application of the tube. As a radio-frequency amplifier, in which the tube is used essentially for its screen-grid character, the output impedance is liable to run as high as 1,000,000 ohms or 1 megohm. This calls for an external load of at least 2 megohms and, when such an external load takes the form of pure resistance, it requires an enormous plate potential to compensate the drop across the resistance, in order that the tube shall operate under its normal characteristic voltages.

Under the above conditions, the ampli-

fication constant of the tube is in the region of 300—theoretically, if not practically.

SPACE-CHARGE AMPLIFIER

When it is used as an audio-frequency amplifier, the output impedance of the tube will run to a value anywhere between 150,000 ohms and 600,000 ohms, dependent upon the manner in which it is employed. The most satisfactory method with which the writer is familiar is to operate the tube as a space-charge amplifier, in which the screen-grid—that is, the external grid shielding the plate—is used as the control grid, and the control-grid is used as a "screen." The amplification constant of the tube, when used as a space-charge amplifier, is usually between 50 and 100.

In view of the above considerations, the problem of utilizing the 222-type tube as an audio amplifier would seem to be somewhat simplified; but, although this is easy, the problem as to the external load is by no means easily solved, if the experimenter is desirous of obtaining really good tonal quality together with the volume that this tube is capable of giving.

Returning to the question of load impedance, the external load in the plate circuit of the tube must be equal to at least twice the internal impedance of the tube at the lowest frequency to be amplified, in order to secure good tonal quality. This rule holds good where an inductive method of coupling is used.

Assuming the output impedance of a 222-type tube used as a space-charge amplifier to be, say, 200,000 ohms, at an amplification constant of 70, it is obvious that the load-

impedance problem becomes greatly simplified. Tubes having such a high μ as this are suitable only as voltage amplifiers.

VOLTAGE, NOT CURRENT

A "voltage amplifier" is essentially a tube which handles only a small amount of power, but which is capable of producing enormous "gain" (amplification) upon weak signals. It has been the practice in the past to use a high- μ tube having an amplification constant of around 30, as a first-stage amplifier immediately following the detector. With such a tube, operating under the best conditions in an impedance-coupled circuit, it is possible to obtain a voltage amplification of around 28 or 29. With the 222-type tube, under the same conditions, it is possible to obtain an amplification factor of twice that value with equally good tonal quality. All of this is due to the inception of a newly-developed coupling device known as a 222-type audio coupler, a brief description of which would perhaps not be out of place.

The coupling device used in conjunction with the 222-type tube as a space-charge amplifier utilizes the principle commonly known as "double-impedance coupling," which makes use of inductively-loaded plate and grid circuits; coupling being accomplished by means of a suitable capacity between the plate and grids of the two successive tubes.

From previous consideration of the output impedance of the tube, it is obvious that the load in the plate circuit should be equal to at least twice the output impedance of the tube at the lowest frequency to be amplified.

Assuming the output impedance of the tube to be in the region of 200,000 ohms, it is necessary to secure an inductive load of at least 400,000 ohms in order that a reasonable amount of amplification may be secured at, say, 50 cycles. It is also obvious that, since the load is inductive, the external impedance will be a function of the frequency. In order to produce an external load of 400,000 ohms at 50 cycles, an inductance of nearly 1,500 henries is necessary. The problem of securing this amount of inductance in a confined space will immediately be realized as not so simple. The design of such an inductor entails considerable forethought and engineering skill; to satisfy the predetermined conditions, it must conform rigidly to the following requirements:

DESIGN OF COUPLER

(1) The inductance must be sufficiently high to satisfy the conditions outlined as regards to proper loading of the plate impedance.

(2) The iron content of the coil must not suffer saturation due to the steady D.C. component flowing into the plate circuit; neither may the superimposed A.C. voltages produced across the impedance have any

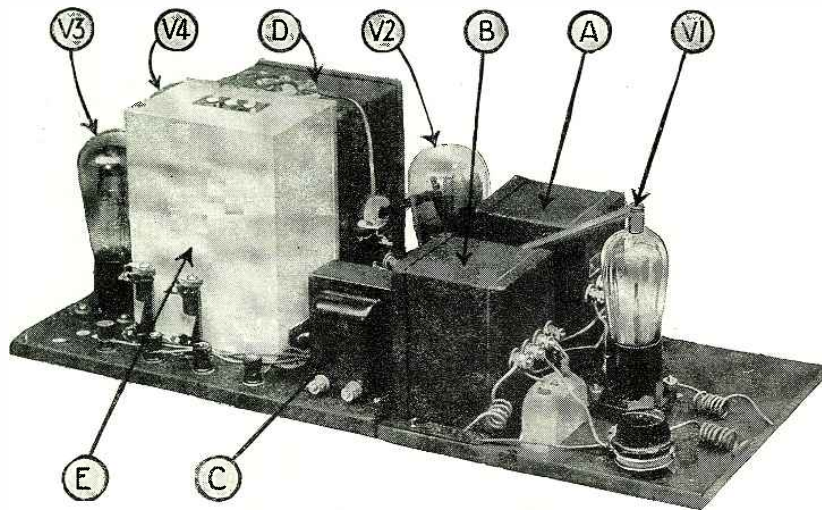

This power pack and amplifier, constructed by the writer, embodies the new 222-type dual-impedance audio couplers which are essential to its efficient performance. Home construction of such devices, because of the enormous inductance required, is practically impossible; but they are now becoming commercially available. Blueprints of this device have not been made; but its circuit is simple, and values of the parts required are given with the circuit diagram on the following page.

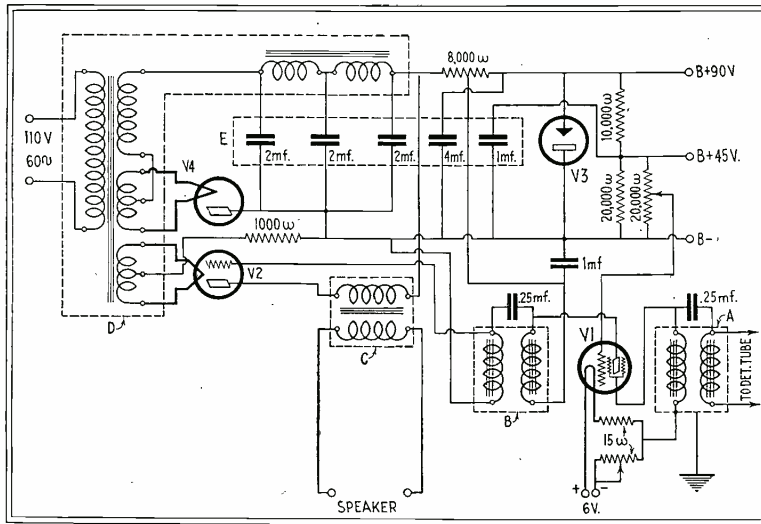

Schematic diagram of the power unit and two-stage amplifier, using one 222-type (V1) and one 210-type (V2) tubes, pictured on the preceding page. V3 is an 874-type regulator, V4 a 381-type (half-wave) rectifier, A and B 222-type coils of very high inductance, designed for screen-grid circuits; C is an output transformer of good characteristics, capable of carrying the high plate current; D is a power unit with two 7½-volt windings for the filaments of V2 and V4, a high-voltage winding supplying an A.C. maximum of 700, and two built-in chokes for the filter circuit. Other values are given in the diagram.

considerable effect upon the normal conditions of inductance. The D.C. resistance of the coil must be sufficiently low to maintain the proper D.C. potential at the plate of the tube.

(3) The distributed capacity of the inductance must be kept at a minimum, in order that the shunt-capacity effect across the choke shall not cause a serious loss of amplification at the higher frequencies.

The application of such an impedance is restricted to use in circuits where the direct-current component flowing through the winding is of the order of 0.5 to 2 milliamperes. It must, however, be capable of standing at least 30 volts of A.C. across the winding without variation in inductance. The maximum permissible input voltage at the grid circuit of the 222-type tube, when used as outlined in previous paragraphs, is of the order of one volt. Assuming the μ of the tube to be around 50 when the output impedance of the tube is properly loaded, it will be seen that a voltage of at least 40 volts can be produced across the choke. The amplification factor of the tube can be considerably changed, however, to suit varying conditions, by the systematic adjustment of the voltage applied to the inner grid.

The next problem in mind is to find a suitable load for the grid circuit of the next tube. Almost all of the voltage produced across the impedance in the plate circuit of the 222-type tube will be reproduced in the grid circuit. The voltage drop at any frequency across a condenser of 0.25 mF. will be very small, at even the lowest frequency on the musical scale. For this reason the grid reactor must be capable of standing at least 50 volts of A.C. without "swinging" in inductance, as must the choke in the preceding plate circuit; it is not, however, subject to the D.C. magnetizing component encountered in the plate circuit. The D.C. resistance must be sufficiently low to maintain a constant negative potential at the grid of the next tube, and for this reason the D.C. resistance should be extremely low when compared to its reactance.

A reactor to fulfill the above conditions

may be, satisfactorily, composed of several thousand turns of No. 40 wire on an interleaved core. The distributed capacity of the grid reactor must be kept extremely low, for the reasons outlined in the case of the choke in the plate circuit.

CHOICE OF POWER TUBE

Regarding the tube question, as to which is the most suitable amplifying tube to follow the 222-type tube when used in the form outlined, it is quite obvious that the grid-swing of the amplifier tube must be capable of handling at least 40 volts without encountering plate distortion. Since the maximum permissible A.C. grid voltage is approximately 70% of the effective grid bias, it is quite obvious that there are only three tubes which will comply with the conditions of satisfactory operation; these are the 171, 210 and 250 types. The 210 type, probably, is the most satisfactory, and when the arrangement depicted in the accompanying diagram was used with 22 volts positive on the inner grid, it was found that both the 210 tube and the 222 type began to distort at just about the same time. By decreasing the positive bias on the inner grid the distortion of the 222 tube was increased, which was accompanied by a decrease in amplification.

By increasing the positive bias the amplification of the 222-type tube was considerably reduced; the distortion, however, was decreased. The design of the output transformer to couple the 210-type tube into the reproducer is, of course, dependent upon the type of load into which it is to operate, and the proper transformer to suit the loud speaker should be chosen. The use of an amplifier of the type illustrated in the schematic diagram proves to be very satisfactory for the amplification of weak signals upon sets in which the detector output is fairly low. It performs the maximum of amplification with the minimum of equipment and at the same time furnishes a highly-satisfactory "B" supply device for the radio receiver itself.

The input coupling device to the grid circuit of the 222-type tube should be chosen

to suit the volume obtained in the detector plate circuit. Where the detector output is extremely low and the output impedance of the detector tube is likewise low, then a transformer having a low primary inductance and a high turns-ratio might well be used for the purpose. Where the detector output is high and the output impedance is high, then impedance coupling is to be well recommended if quality is to be the prime factor. This method of coupling will, of course, keep the voltage ratios unity; bearing in mind all the time that the maximum permissible voltage on the grid of the 222-type tube is of the order of one volt.

The fact that the 222-type tube, when used as an audio-frequency amplifier, is overloaded if potentials greater than one volt are applied to the grid, has an important effect upon the design of receivers using a tube of this type as an A.F. amplifier. In the first place, it is absolutely necessary that the volume control be located ahead of the detector tube in the circuit, and the use of a volume control in the audio or loud-speaker circuit is entirely out of the question. If this suggestion is not observed, the music and speech from all loud local stations is apt to be distorted. Secondly, a R.F. choke coil and small by-pass condenser should be connected in the plate circuit of the detector tube to prevent R.F. currents from overloading the grid of the 222-type tube. Also, if a phonograph pickup unit is used, a variable resistor should be connected in shunt to reduce the output.

From the above paragraph it may be seen that the 222-type tube is much more sensitive than the 201A type, and that it cannot be used to replace a 201A stage unless some means is provided for reducing the input energy. However, the fact that the input energy is low does not indicate that the output is also low; for this is not the case. In most cases the 222 stage will amplify a weak signal to a much greater volume than a 201A stage could amplify a comparatively loud signal. Because of this feature the amplifier under discussion in this article is ideal when listening in on distant stations.

CHOICE OF VOLUME CONTROL

Locating the volume control ahead of the detector may present a problem to some readers, and for this reason several suggestions will be made. A suitable volume control for a battery set may consist of: a 75-ohm rheostat connected in shunt with the primary of the R.F. transformer in the plate circuit of the second R.F. tube; a 10,000-ohm variable resistor in shunt with the aerial and ground; a 100,000-ohm resistor in series with the plate-supply wire to the R.F. tubes or a rheostat in series with the filament supply to the R.F. tubes. However, if the receiver uses A.C. tubes, only the first two methods are satisfactory.

The selection of the proper input transformer must be left to the user himself; and it is obvious that the type of transformer selected will be dependent upon the number of stages of radio-frequency amplification employed.

For the amplification of weak signals and for good reception, the 222-type tube might well be used in the screen-grid method—that is with the inner grid as the control. For broadcast reception the use of the tube as a space-charge amplifier is certainly to be recommended; otherwise a much higher load will be necessary in the output circuit of the 222-type tube.

Letters from Home Radio Constructors

A CONE ENTHUSIAST

Editor, RADIO NEWS:

I have just digested the contents of your June issue, and must say that it is money well spent. I read with great interest the correspondence in regard to good results obtained with 3-tube regenerative receivers, and as I am in that class now, I think I will bring up the subject of speakers. For two years past I have been building horn-type speakers up to 17 feet in length, until I became a nuisance about the house; and also three cone speakers of different styles. I tried all kinds of materials in the horns; the latest cone is a 24-inch one of parchment paper.

Pardon me for expressing my opinion so strongly, but from the harmony standpoint a cone speaker with a good unit will outclass any horn that ever was built, and I have proved it to my satisfaction over and over again. The only advantage a horn speaker has is that it takes less power to operate it, while a cone speaker requires a strong unit and a receiver with a power tube of the 171A-type, with necessary "B" and "C" voltages for best results.

I have tried the regular cone paper sold for that purpose; but the best for musical results is the parchment paper well dried. I dried mine all winter in a warm place at home. Parchment paper gets better with age and needs no varnish of any kind. (Depends somewhat on the climate—Editor.) I might say that, for a very powerful set, the linen-diaphragm cone will stand up well but, for a nice round tone, the parchment paper can't be beat. I would advise all set builders to equip their radios with a special detector and power tube, with the necessary voltages; then try the horn and cone speakers and let their ears decide. I would like to see more of them express their opinions on horns and cones and linen-diaphragm speakers; that is what makes the paper interesting.

The accompanying drawing shows a cone speaker in combination with a piano. To perfect the cone speaker is, I believe, beyond the average home set builder. But most of us, like the writer, have a piano about the house, which will become very effective when hitched up with a good speaker, supplied from a good-toned radio receiver.

All that is necessary is to remove the panel from the front lower half of the piano; this is readily done, as it is made detachable for repairs, etc. If you choose to tack a piece of cloth over the opening, it may be selected with a regard to the finish of the piano. Attach a 20-inch cone to a low stool, so that it will slip under the key-frame. This places the cone fairly close to the sound-board, which gives the reproduction excellent tone. A 24-inch cone may be used by placing it on the floor without a support. The writer is more than pleased with the quality of the combination, and recommends it to radio music lovers. The cone is quickly removed to one side when it is desired to play the piano in the usual way.

LESLIE ELDRIDGE,
89 Rea Ave., Hawthorne, N. J.

SIMPLE, BUT GOOD

Editor, RADIO NEWS:

When it comes to small sets, the "Extension" two-tube set has them all beat a mile. It is the best that I have ever built. I have had it only

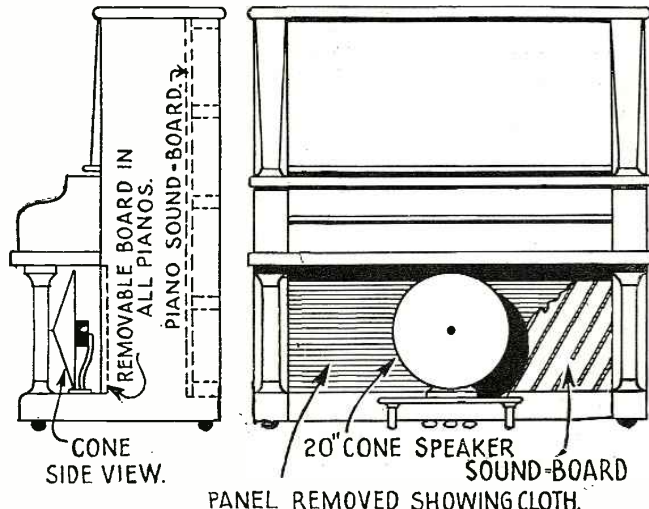

a short while, and have brought in over a hundred stations; including CZE, KFI, PWX, KPOF, KGBZ and KLZ. I have brought in several using under fifty watts power. I would recommend this circuit to anybody.

ROBERT ZEIGLER,
Box 436, St. Augustine, Florida.
(Free blueprints of the "Extension" receiver can be obtained from RADIO NEWS. Simply ask for Blueprint No. 53.)

WANTED, A THOUSAND-PERCENTER

Editor, RADIO NEWS:

I hope you will find time to read a few words of appreciation for your magazine, coming from Ireland. I wonder if the fans "over there" are really so advanced as one would gather from the suggestion that the crystal as a rectifier is in use in the majority of sets outside the U. S. A.? If that be so, why did your magazine bewail the backwardness of your countrymen *re* the two-grid tube some twelve months ago. (It's a long, sad story—Editor.) and why do you continue to receive whole-hearted praise of your Interflex circuit? (The quality of the crystal as a detector has not been surpassed; but Americans require multi-tube sets to meet conditions here, and the general use of the vacuum-tube detector followed, even at the price of some distortion.)

That RADIO NEWS is on the right lines goes without saying. Don't change its general tone; you

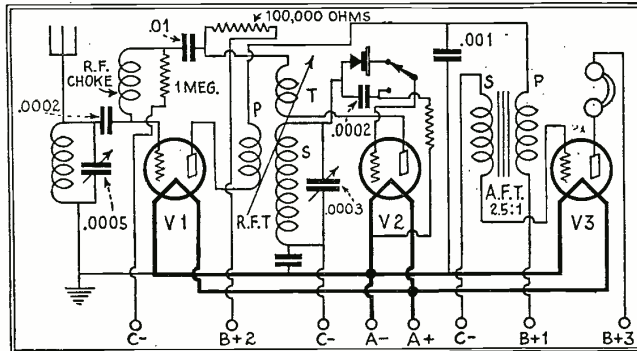

Mr. O'Neill's Interflex uses three "B" voltages (not given) on his 3.5-volt tubes. V1 and V2 draw .06 amperes, and have 20,000 and 30,000 ohms impedance, respectively. V3 takes 0.1-ampere and has a 6,000-ohm impedance.

LOADING THE STROBODYNE

Editor, RADIO NEWS:

I have been doing some experimenting with the Strobodyne receiver, which I built last October; I find that, by omitting the cam in the R.F. circuit which the hook-up calls for, to operate the antenna coil when the condenser is tuned, equal amplification is received on all wavelengths. When this coil meshes with the condenser, amplification is cut more than 50 per cent, and amplification is the paramount issue for which we are all striving. (One of them; all circuits must involve some compromises, and all fixed adjustments be set to give average best results.) I have installed three screen-grid tubes in this receiver and am experimenting with a fourth ahead of the oscillator. The amplification is terrific with three stages of straight audio-transformer amplification. No distortion is present with two volume controls turned on full. People come from all parts of the city to hear this set perform.

I have used various forms of tube shielding; bronze on the coils and tubes (a lot of the "bronze" now on the market is not a conductor of electricity, as I have found by tests) tin foil and "metalized." The latter is a process by brushing lacquer on the tube to the "A—" prong, sprinkling graphite on it before it dries, and copperplating it. Now I have discarded all of the shielding on the coils and tubes and I get stable operation, the same tonal quality and high amplification as before. Here is a mystery to fathom out.

WILLIAM BROOKS,
735 Marshall St. Milwaukee, Wis.
(Some experimenters are just naturally lucky. As a general rule, however, it will be found wise to follow the standard practice more closely. With the layout described in this issue, working at full efficiency, all the amplification is obtained that can be used.)

Editor, RADIO NEWS:

A convenience can be added to the Strobodyne by taking two filament switches, such as are specified, and run the aerial to one side of each. Run the other sides of the switches to the long and short aerial taps on the set, respectively. Mount

Mr. Eldridge uses the ample sounding-board of his piano to reflect the notes of his favorite cone. A cloth covers the opening; presumably it is not heavy; or a circular hole immediately behind the cone might seem desirable.

the switches at a convenient point on the side of the panel, spacing them about two inches apart vertically. If a Fritts cabinet is used, they can be mounted on the wooden panel. This arrangement permits cutting in part or all of the antenna coil at will.

C. S. COSGROVE,
Box 404, Brewster, Ohio.

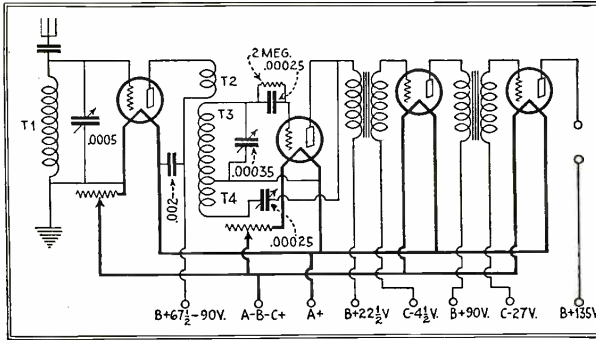

GOOD DX WORK

Editor, RADIO NEWS:

I would like to tell about a four-tube set that is a world-beater. It is composed of one R.F. stage, regenerative detector, and two of audio. It is cheap to build and has fine tone. The real accomplishment is its DX ability.

During five months last winter I played stations

in 25 states, 13 in Canada, Havana, in Cuba, Port au Prince in Haiti, and Honolulu. I have verified

2BL, Sydney, Australia; have heard 4QG and 5CL in Australia, as well as Japan. I have had Salt Lake City several times in daylight, as well as San Francisco.

ELLIS E. MCCORMICK,
10206 Greville St., Inglewood, Calif.

(Very good distance has been made with four-tube sets of essentially the same character. However, a great deal of extreme DX-getting ability lies in location, as well as in patience, and builders who fail to get Haiti or Australia should be slow to blame the circuit for their failure.)

A THOUSAND-DOLLAR SET-CHEAP

Editor, RADIO NEWS:

After reading your article on the "Junk Box," short-wave receiver, I constructed the set in a very short time. When I tried it out, the signals were very weak and the set would go in and out of oscillation with a loud squawk. Thinking the trouble might be in my tubes I tried several other pairs of new 201A's. The results were no better. Finally, as an experiment, I tried an old pair of WX-12's. Much to my surprise, the set went in and out of oscillation very smoothly. Almost

(Continued on page 280)

List of Broadcast Stations in the United States

(Continued from page 210)

Table listing broadcast stations across the United States with columns for Radio Call Letter, Broadcast Sta. Location, Wave (Meters), Power (Watts), Radio Call Letter, Broadcast Sta. Location, Wave (Meters), Power (Watts), and Radio Call Letters. Stations include WJBU, WJEW, WJBY, etc., covering various regions and power levels.

*Allowed higher daylight power. **Standard or constant-frequency transmission. †Remote Control.

LIST OF CANADIAN BROADCAST CALLS

Table listing Canadian broadcast calls with columns for Call Letter, Location, Wave (Meters), and Power (Watts). Stations include CFAC, CFBO, CFCA, etc., from Calgary, Alberta to Red Deer, Alberta.



Radio News Laboratories



RADIO manufacturers are invited to send to RADIO NEWS LABORATORIES samples of their products for test. It does not matter whether or not they advertise in RADIO NEWS, the RADIO NEWS LABORATORIES being an independent organization, with the improvement of radio apparatus as its aim. If, after being tested, the instruments submitted prove to be built according to modern radio engineering practice, they will each be awarded a certificate of merit; and that apparatus which embodies novel, as well as meritorious features in design and operation, will be described in this department, or in the "What New in Radio" department, as its news value and general interest for our readers shall deserve. If the apparatus does not pass the Laboratory tests, it will be returned to the manufacturer with suggestions for improve-

ments. No "write-ups" sent by manufacturers are published in these pages, and only apparatus which has been tested in the Laboratories and found of good mechanical and electrical construction is given a certificate. As the service of the RADIO NEWS LABORATORIES is free to all manufacturers, whether they are advertisers or not, it is necessary that all goods to be tested be forwarded prepaid, otherwise they cannot be accepted. Apparatus ready for, or already on, the market will be tested for manufacturers free of charge. Apparatus in process of development will be tested at a charge of \$2.00 per hour required to do the work. Address all communications and all parcels to RADIO NEWS LABORATORIES, 230 Fifth Avenue, New York City. Readers will be informed on request if any article has been issued a Certificate of Merit.

FILTER AND BY-PASS CONDENSERS

The "Parvolt" condenser shown, submitted by The Acme Wire Company, New Haven, Conn., is designed for general use in the filter systems of radio power supply units. It is of the paper-dielectric type and enclosed in a metal housing equipped with mounting feet. This type of condenser is available in capacity values of 1, 2, and 4 mf. and in working-voltage ratings of 200, 400, 600 and 1,000. The 1,000-volt type is especially suitable for the "B" power units of radio receivers employing power tubes of the UX210 or UX250 type, where high plate voltages up to 450 are required. For



convenience of mounting and economy in space, all condensers of this type, whatever the capacity value and working voltage, are made of the same height and width (namely, 3 x 3 3/4 inches), and differ only in thickness. A capacity test of a series of 12 condensers of this type showed that the measured values are very close to the rated, the average difference was less than 3%, and the maximum did not exceed 4 1/2%.

AWARDED THE RADIO NEWS LABORATORIES CERTIFICATE OF MERIT NO. 2378.

The by-pass condenser submitted by the same company is, like their filter condenser, of the paper-dielectric type, and housed in a metallic



casing provided with mounting brackets. As it is intended for use as a by-pass condenser, it is designed for lower operating voltages.

AWARDED THE RADIO NEWS LABORATORIES CERTIFICATE OF MERIT NO. 2379.

HOOK-UP WIRE

The flexible "Celatsite" wire shown, submitted by the same company, is made of several stranded,



tinned No. 30 copper wires and covered with two layers of cotton; of which the outer is impregnated with an incombustible insulating compound. This wire is very convenient for wiring radio receivers, as it is flexible, well insulated and is easy to solder; it is available in various colors in coils of 25 feet long.

AWARDED THE RADIO NEWS LABORATORIES CERTIFICATE OF MERIT NO. 2380.

A. C. VACUUM TUBE

The vacuum tube shown, submitted by the Wireless Corporation of America, 1744 No. Robey St., Chicago, Ill., is of the heated-cathode



(227) type, and similar in construction to the standard tubes of the same type. The filament operates normally at 2 1/2 volts and requires approximately 1.15 amperes. The average values of the dynamic characteristics of this tube, taken from the measurements of a set of eight, are:

- Amplification constant.....9.8
- Plate impedance.....6200 ohms
- Mutual conductance.....1350 micromhos (measured value)

The measurements were made with 90 volts on the plate and the center tap of the resistor across the filament connected to "plus 22 1/2." This tube operates very satisfactorily as a detector or amplifier (radio or audio).

AWARDED THE RADIO NEWS LABORATORIES CERTIFICATE OF MERIT NO. 2381.

TUBE SOCKET

The tube socket shown, submitted by the Pilot Elec. Mfg. Co., Inc., 323 Berry St., Brooklyn, N. Y., is of the UY type, into which any standard tube of the 227 type will fit. This socket is of simple and efficient construction. The five contact springs are made of phosphor bronze and are riveted to a small bakelite disc, which in turn is riveted to the black bakelite base. The springs have protruding lugs for the wiring and insure good contact with the prongs of the tube. This socket



is adaptable to mounting in different ways on a baseboard or sub-panel.

AWARDED THE RADIO NEWS LABORATORIES CERTIFICATE OF MERIT NO. 2382.

ADJUSTABLE RESISTOR

The "Peerless Varistor" (No. 706) shown, submitted by the Bedford Electric & Radio Co., Ltd., 22

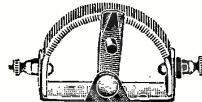

Campbell Road, Bedford, England, is an adjustable resistor of the air-cooled type, for use in controlling filament current. It has a resistance value of approximately 3 ohms and is built for baseboard mounting. Although very simple in construction, this resistor is sturdy and provides a good contact between the sliding arm and resistance strip.

AWARDED THE RADIO NEWS LABORATORIES CERTIFICATE OF MERIT NO. 2383.

RESISTOR

The "Letzo-Stat" resistor shown, submitted by Einar Letzen, Nordana, Sweden, is an adjustable resistor

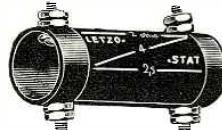

which consists of a small bakelite tube 2 1/8 inches long, 3/4 inch in diameter, inside which are mounted three resistance wires, having the values of 4, 2 1/2, and 2 ohms. These wires are connected in series and to the four terminals mounted on the bakelite tube. This resistor can be used as a current-controlling device; as it provides 14 different re-

sistance values, varying from 8.5 ohms to .87-ohm, which are obtained through series, parallel or series-parallel combinations.

AWARDED THE RADIO NEWS LABORATORIES CERTIFICATE OF MERIT NO. 2384.

FILAMENT SWITCH AND BALLAST

The Letzen "Combinator" shown, submitted by the same manufacturer, is a filament switch which contains four ballast resistors having values of 7, 3 1/2, 2 1/2 and 1 1/2 ohms. It is constructed of bakelite tubing 2 1/2 inches long and 1 inch in diameter, into which are built a small plug jack and 2 contact springs. Each of the four resistors is connected at one end to one of the contact springs. The other end of each is attached to one of the four binding posts



mounted on the same tube. This switch is designed for use in receivers in which tubes of the 199 or other low-consumption types are used, and which are operated from a 4-volt storage battery. According to the number of tubes, choice is made of the resistors to be included in the filament circuit.

AWARDED THE RADIO NEWS LABORATORIES CERTIFICATE OF MERIT NO. 2385.

VARIABLE CONDENSER

The variable condenser shown, submitted by the Karas Electric Company, 4040 North Rockwell Street, Chicago, Illinois, is of the S.L.F. one-hole type. This instrument is of excellent mechanical and electrical design, and along its general lines is similar to the well-known previous models of the same make. To facilitate gang mounting, the rotor is of the floating type; and the end plates are equipped with brackets for baseboard mounting.

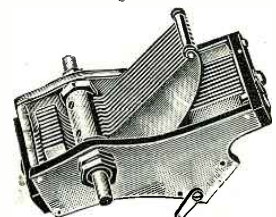

AWARDED THE RADIO NEWS LABORATORIES CERTIFICATE OF MERIT NO. 2386.

ANTENNA COUPLER

The "Exact" aerial tuner shown, submitted by The Exact Manufacturing Company, Croft Works, Priory Street, Coventry, England, is of the variocoupler type. The coupling between the primary and secondary may be varied by changing the angle between them from 0 to 90 degrees. The primary is wound on a hard-rubber form which is in the shape of a slotted disc and the dimensions of which are: 2 3/4 inches exterior, 1 1/2 inches interior diameter, and 5/8-inch in width. The winding has 7 taps, the connection of which to the circuit is controlled by a built-in switch. The coil form is forced into a hard-rubber ring, which in turn is mounted on one of the blocks

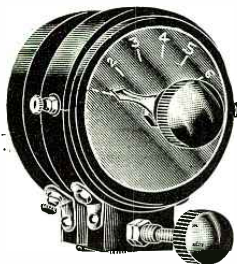

forming the coupling device. The secondary is wound on another hard-rubber disc, of the same diameter, but only 1/2-inch wide, and mounted on the other block. The two blocks are held together by a hinge and spring; the first is equipped with a threaded rod which controls the angle of coupling by pressing against a bronze cap mounted on the other block. For the mounting of this coupler on the panel, only two holes are required. The measured inductances are: primary, 1550 microhenries; secondary, 585 microhenries.

AWARDED THE RADIO NEWS LABORATORIES CERTIFICATE OF MERIT NO. 2387.

POTENTIOMETER

The "Dralowid Divisor" shown, submitted by Steatit-Magnesia Akti-

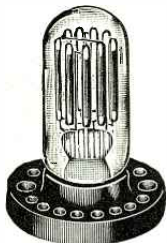

engesellschaft, Berlin, Werke Tempelhof, Germany, is a wire-wound resistor, which is designed for use as a voltage divider. It comprises nine individual resistors wound on glass rods, which are mounted and sealed in an evacuated glass tube. The resistance values of these elements are: two of 300 ohms; one of 600 ohms; five of 1,200 ohms and one of 1,800 ohms. All resistors are connected in series and their common points are connected to the tip jacks molded in the bakelite base of the unit. A load of approximately 36 watts has been applied to this receiver for a period of approximately 1 hour. The glass container became relatively warm, but no appreciable changes in the values of the resistors occurred.

AWARDED THE RADIO NEWS LABORATORIES CERTIFICATE OF MERIT NO. 2388.

AERIAL MAST

The "Midget" aerial mast shown, submitted by H. A. Solter, 418 Boston Block, Minneapolis, Minn., is



made of three galvanized-iron rods, 1/4-inch in diameter. These rods are partly twisted together and their free ends have screw-eyes. Since the

ends of the rods may be bent in various directions, this mast is very adaptable to mounting in different positions. It is approximately 20 inches high and has on its upper end a porcelain insulator. It is neat in appearance and easy to install.

AWARDED THE RADIO NEWS LABORATORIES CERTIFICATE OF MERIT NO. 2389.

VACUUM TUBE

The vacuum tube (type H.L. 210) shown, submitted by the Marconiphone Co., Ltd., 212, Tottenham Court Rd., is of the "dull-emitter" (low-heat) type. It operates from a 2-volt storage battery and requires approximately 100 milliamperes for normal operation; under which conditions the voltage across the filament has been found to be approximately 1 1/2. Plate voltages up to 150 may be used. The dynamic characteristics of this tube are rated at: amplification constant, 15; plate impedance, 25,000 ohms. The measured values are close to them. This tube can be used as an amplifier (radio or audio) or a detector.



AWARDED THE RADIO NEWS LABORATORIES CERTIFICATE OF MERIT NO. 2390.

GROUND-CONNECTION DEVICE

The "Per-Con radio ground" shown, submitted by the Per-Con Mfg. Co., 310 North Third St., Richmond, Indiana, consists of three iron pipes, each 18 inches long, 1 inch in diameter, and 1/2-inch thick; together with a bronze point with an attached copper wire, and a hardened cap. The bronze point fits into the lower end of the first section of pipe; while the cap, and the lower ends of the two other sections, fit into the upper end of any of the sections. The cap, which is used

while driving a section into the ground, is provided with a slot to protect the connecting wire from breaking. This "ground" has many advantages in installation, and provides a good ground connection.

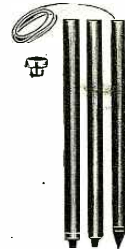

AWARDED THE RADIO NEWS LABORATORIES CERTIFICATE OF MERIT NO. 2391.

RECTIFIER TUBE

The rectifier (L.S. 281) shown, submitted by the Matchless Elec. Co., 143 W. Austin Ave., Chicago, Ill., is of the half-wave type, and designed to be used principally in "B" power-supply units operating from the A.C. house-current line. It has an oxide-ribbon filament which requires for normal operation 1.25 amperes at 7.5 volts. Plate voltages

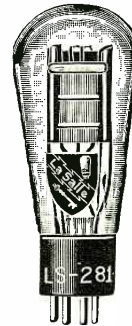

up to 700 may be used. Its maximum output is approximately 100 milliamperes.

AWARDED THE RADIO NEWS LABORATORIES CERTIFICATE OF MERIT NO. 2392.

Reviews of Recent Radio Literature

By A. K. Ross

THE ELEMENTS OF RADIO COMMUNICATION, by O. F. Brown. Published by the Oxford University Press, London, England. 5 3/4 x 8 3/4 inches; 216 pages, illustrated with charts and diagrams, cloth. Price 10s. 6d. (\$2.55 in England.)

As its title implies, this book is devoted to a discussion of the fundamental principles of radio communication; it is of interest to the American radio engineer or advanced student in radio especially because of the picture it gives of British methods and the British point of view.

The book is intended to give the student, the electrical experimenter and the public a general knowledge of the fundamental principles governing the propagation of electromagnetic waves and their effect on various types of receiving circuits. The first few chapters are devoted to a discussion of the properties of high-frequency alternating currents, the transmission of damped waves, and the transmission of continuous waves produced by arcs and high-frequency alternators. The remainder of the book is, for the most part, given over to consideration of various types of receiving circuits and the theory and application of vacuum tubes. An interesting feature, of that portion of the book which is devoted to receiving circuits, is the author's frequent reference to American circuits and equipment, and his comparisons of American and British methods.

The book is well written, with a generous sprinkling throughout of diagrams showing some of the more or less standard English transmitting and receiving circuits. However, the author's frequent use of British terms for the various parts of the sets illustrated in the diagrams may be rather confusing to the average American broadcast listener, who would find one of the numerous books covering the same subjects, which have been published in this country, easier to follow.

A LABORATORY TREATISE ON "B" BATTERY ELIMINATOR DESIGN AND CONSTRUCTION, prepared by John F. Rider and issued by the Radio Treatise Co., 270 Madison Avenue, New York City. 8 1/2 x 11 inches, 88 pages, loose-leaf, paper covers, illustrated with rough diagrams. Price \$1.

The subject of light-socket-power supply for the receiving set is of considerable interest at this time, not only because so many new A.C.-operated sets have recently made their appearance on the market, but also because a large number of parts manufacturers have placed upon the market complete kits for the construction of various types of power-supply units. The wide variety of tubes, transformers, choke coils, filter condensers, etc., now available to the home constructor offers an almost unlimited number of possible combinations

to suit every conceivable type of receiving set and power amplifier.

It is for the benefit of the large army of technically-inclined set builders and set owners that the author of this book has undertaken to cover the subject of power-supply units more fully than is usually done in how-to-build-it articles and pamphlets issued by the manufacturers of the parts. The book discusses the design, operation and construction of power-supply units, explaining the various types of rectifier tubes, power transformers, filter-condensers and chokes in a manner which can be easily understood. A few simple mathematical formulas are given, to enable the reader to understand fully the various factors which must be considered in designing or selecting parts for any given type of power-supply unit.

"Wire," to quote the author, "is the most frequently-used item in a 'B' eliminator, being found in transformers, filter chokes, voltage-distributing resistances and as a means of connecting the various units;" and he has, therefore, devoted the first portion of his book to a consideration of this subject. The design, construction and operation of the power transformer also receives thorough treatment; for, while most set builders and experimenters will doubtless prefer to purchase one ready-made, a knowledge of its design and construction is necessary in choosing the proper one for use with a given combination of parts.

Rectifier tubes are next discussed and the advantages of each of the several types now available

(Continued on page 284)

Radio News

IT'S A CRUEL WORLD!



Fair warning from the *Cleveland Plain Dealer* of June 3: "Edwin Franko Goldman, whose band concerts will be HARD on NBC networks this summer"—Well, we suppose the wearied telephone engineer will have to get out and patch up the lines of communication again. Wear and tear is all in his day-and-night work.
—C. H. Shipman.

WATCH OUT FOR YOUR PEP!

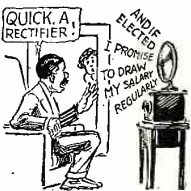

Now that the spell-binder is on the air, to say nothing of lecturers on all subjects from the "Intellectual Life of Epizoa" up and down, fans will welcome the relief advertised by the *Park Radio Service* of New York: "DULL wave rectifier for most eliminators and Electric sets." Book our order for a dozen.
—E. O. Dumas.

INTERIOR DECORATION

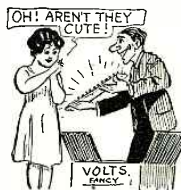

Purchasers have now a choice in electrical supplies, as *W. C. Braun Co.'s* catalog describes appliances "designed to operate on 5 1/2 IN. to 18 1/2 IN. volts." We want to buy 110 sixteen-inch volts to fit our new console cabinet; and the Missus tells us to be sure and get black-and-gold ones in the Chinese style.
—K. R. Sipple.

RECOMMENDED TO LIGHTHOUSE KEEPERS

Static discourager described in the *Cincinnati Enquirer* of June 17 incorporates an old-fashioned variometer, which "may be mounted near the SEA." Would a Great Lake do instead? If not, we fear it will be of little use to the Chicago man trying to tune in Denver on a summer night.
—Joseph Sheehan.



FATHER, DEAR FATHER—

Victory of radio over time and space predicted in the *Seattle Times* of June 11: "The entertainment at the Radio Manufacturers' Association banquet" will last two YEARS." Oh, well, it's a great life if you don't weaken; but we'd hate to meet the trunk-line tolls—or the grape-juice bill.
—E. L. Brennan.



THE AUTOMATIC SET

Newest in radio sets heralded in the *Boston Globe* of May 23: "Batteryless and battery-OPENED receiving sets will be marketed by this company," thus giving the battery a chance to demonstrate its versatility. Not only can it supply the necessary electric fluid, but it will dust off the console, open the doors and tune in the Eveready Hour.
—Stedman F. Arnold.



TELEVISION IN "BANANALAND"

Advertisement in the *Brisbane* (Queensland) *Telegraph* of May 1 announces: "Splendid 3-valve for sale; southern stations, can be SEEN and heard any night on phoning M1369." Mike, our special investigator, left at once on the airship *Northern Crown* to get the latest specifications on this new telephone attachment.
—O. J. Blakely (Australia).



IF you happen to see any humorous misprints in the press we shall be glad to have you clip them out and send to us. No RADIOTIC will be accepted unless the printed original giving the name of the newspaper or magazine is submitted, with date and page on which it appeared. We will pay \$1.00 for each RADIOTIC accepted and printed here. A few humorous lines from each correspondent should accompany each RADIOTIC. The most humorous ones will be printed. Address all RADIOTICS to

Editor, RADIOTIC DEPARTMENT,
c/o Radio News.

THIS IS DISCRIMINATION



High living means trouble in running an electric set; if we are to judge by the announcement of a transformer furnishing "Current Supply for AC VALES" only, in *Popular Radio* for May, That's all right for some; but us homesteaders on the hill-side have to tote the old battery up and down, just the same.
—R. Chass.

NO AID TO BEAUTY

Cromwellian gesture in the *Boston Post* of June 17: "The power input to the (television) motor is a pair of a t e l y 100 WARTS." Catch us being televised; We might take a chance if the worst to be anticipated was a crop of freckles; but warts are too serious, and we might not find a boyhood chum to sell them to.
—George Danforth.



"SPARKS" SHOULD STRIKE

All is not rosy among the sky-going operators, according to the *Richmond Times-Dispatch* of June 11, which tips us off that James Warner of the *Southern Cross* employed "an aerial 26 feet long for short W A G E S." Heroes often have to take their pay out in glory, we fear; but we hope that Jim gets a speedy raise.
—Warren Wooten.



ANOTHER HOOK-UP, OSCAR

Radiodynamic offering in the *Fort Wayne* (Ind.) *Journal-Gazette* of May 27: "One 5-tube distance-getter CABLE PIPE, walnut cabinet 135-volt outfit cheap." We have suspected some of these DX hounds of possessing pipes. Perhaps you shred the cable into fine-cut, put it in your pipe and smoke it—and get Pekin.
—Donald Hill.



IN THE SWEET BY-AND-BY



Commercial candor in an advertisement of *Hartman's* in the *Madison* (Ky.) *Messenger* of April 15: "Buy from us; we guarantee delivery SOME day." Truth, crushed to earth, will rise again; and all things come to him who waits—if he doesn't die of old age while waiting. (We know; we've tried it!)
—Ollie Meloy.

PAGE DR. NIKOLA TESLA



The army air service has quietly solved the problem of radio power transmission, says the *Chicago News* of June 8; from airplane generators at Dayton, "they obtain a supply of 1,000 volts at 500 MILES." With heavier wire in our set, at this distance we should be able to tune in enough juice to light the house.
—O. A. Ennis.

WE RECOMMEND MORE COURTESY



Directions for building a 7-tube set in the *B. of L. F. & E. Magazine* for May: "The short strip of INSULTING material is mounted on small blocks." Personally, we wouldn't want to insure a set that would give too much impolite back-talk to some of those husky railroad hotheads. It might be returned to the junkbox before its time.
—Frank T. Porter.

SPEED UP, SAMMY!

Influence of the six-day races revealed by the *Elmira* (N. Y.) *Telegram* of June: "Even the slightest crackling of paper held by speakers before the BIKE has been eliminated in the studio of KFL." Yes, we thought we could see the wheels going round, when we got into the studio the first time.
—Teddy Casterline.



WE DON'T QUITE GET IT

The theological editor is on his vacation, and the rest are still puzzling over a service described in the *Auburn* (Ind.) *Dispatch* of April 10. "Six new members of the Hill Top Church were BAPTIZED Sunday evening, and two by RADIO." Radio waves are versatile, indeed, but we don't know how to use them in place of water.
—Ollie Meloy.



EVERYTHING UP-TO-DATE

Bargain offer in the *Cleveland Press* of June 8 intrigues us: "Splitdorf Brand New Sets, equipped with superpower switches, wired for LOWER tube, \$18.80." Well, if they can pipe a house nowadays for radio and lights, why can't they wire a set for water, gas and sewer pipes? We want all the modern attachments.
—Milton Cousin.

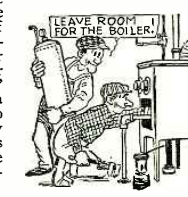



Conducted by C. W. Palmer

RADIO NEWS readers send in every month an average of 5000 letters asking information on every phase of radio theory, construction and operation. We can only print the five or six replies which are of widest general interest.

Other letters will be answered by mail, if inquirers observe these rules: BE BRIEF: TYPEWRITE OR WRITE LEGIBLY IN INK ON ONE SIDE OF THE SHEET ONLY: ENCLOSE A STAMPED ENVELOPE ADDRESSED TO YOURSELF. Many letters are not readable. Simple questions will be answered free;

those asking for sketches, diagrams, data, etc., should send TWENTY-FIVE CENTS FOR EACH QUESTION: failure to enclose this will cause delay. We cannot answer for this sum questions requiring original research, intricate calculation, or patent investigation; we cannot compare the merits of trademarked apparatus, or give constructional data on apparatus whose makers withhold it. We cannot undertake to answer more than THREE QUESTIONS in each letter. If you inquire concerning a circuit which is not a standard, published one, enclose a diagram to save delay.

DRY RECTIFIERS

(2298) Mr. R. R. Russell, Syracuse, New York writes:

(Q.) "I would like to obtain some information about dry rectifiers of the cupric-oxide type. What chemicals and electrodes are used in this rectifier, and what pressures are employed to hold the various plates together?"

(A.) The operation of dry rectifiers of this type is based on the fact that when (relatively) highly electropositive and electronegative bodies are brought together and an alternating current passed through them, there is formed at the junction a "rectifying" film, which permits the passage of current in one direction much more freely than in the opposite direction. In order to maintain a continuous film, the electrodes are held tightly together, with a relatively high pressure, by a suitable clamp or other means. In each unit (cell) of the ordinary type of commercial rectifier two plates are used; one of magnesium and the other of cupric sulphide (a compound of sulphur and copper), united by a pressure of about 200 pounds per square inch. With this combination of cupric sulphide and magnesium, held under sufficient pressure, and an alternating current of proper value applied across the two plates, the rectifying film is formed almost immediately and is maintained indefinitely.

If the rectifiers are temporarily overloaded, the rectifying film is broken down. However, as soon as the excess current is removed, there is a chemical reaction which produces a new film almost immediately. With a rectifier of this type, comparative resistances of about 75 to 1 will be found when currents are sent through the rectifier from opposite directions. In other words, a rectifier having a resistance of half an ohm to currents in one direction will have a resistance of 37.5 ohms in the opposite direction.

In Fig. Q2298 will be found the relative positions of the parts used in a single cell of one of these dry rectifiers. It consists of a bolt, an insulating tube, a disc of cupric sulphide, one of magnesium and two radiating discs; the last named are used to separate the various cells and to conduct away excess heat. In actual practice, a number of these individual cells are connected in

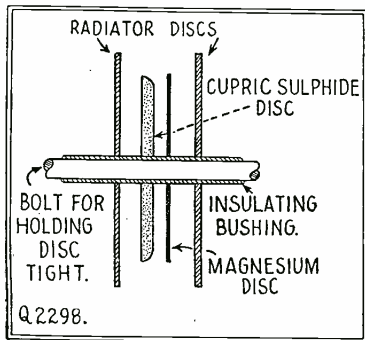

The discs used in the cupric-sulphide rectifier are compressed by the bolt to a pressure of about 200 lbs. per square inch.

series to compose a rectifier, so that higher voltages may be employed. It is usually considered that a voltage of about 4 is correct for each cell; although voltages up to about 4% may be used without injuring the rectifier.

Commercial Devices

A number of these rectifiers have been placed on the market in both half- and full-wave arrangements. In the half-wave rectifiers, a number of rectifying cells are connected in series; the number of cells depending upon the voltage at which the rectifier is to operate. The full-wave rectifiers are so arranged that a full-wave rectifying action is obtained with a half-wave transformer; in other words, a transformer with a single secondary winding is used for full-wave rectification. This is accomplished by using a bridge circuit in which two of the rectifiers are operating on each half-cycle, while the other two operate on the other half. While two of the sections are in operation, the other two, which are connected in the opposite direction, have naturally 75 times the resistance of the rectifier elements in operation. This system is particularly advantageous in "A" power units, since it is much easier to filter the output of a full-wave rectifier than one of the half-wave type.

The sulphide rectifier, under normal conditions, is operated at a temperature of about 90 degrees centigrade (194° Fahrenheit) and will operate at temperatures up to 150° C. (302° F.) for short periods without any injurious effects.

In designing apparatus to be used with these rectifiers, sufficient ventilation should be provided to maintain a temperature of about 90 degrees under normal load conditions. The life of the rectifier depends to a great extent on the current which is passed through it. For battery chargers and other apparatus not operated constantly, the life is much greater than when it is used for "A" power units and other apparatus requiring a steady output. A life of about 1500 hours can usually be expected from the latter type of apparatus when the rectifier is not overloaded.

A SHIELDED WAVETRAP

(2299) Mr. F. E. Potter, Hamilton, Ohio, writes:

(Q.) "I have recently read about a shielded wavetrapp, which will satisfactorily increase the selectivity of a radio set under adverse conditions. If possible, I would like to obtain constructional details for building a unit of this type; since I am having some difficulty with interference from nearby broadcast stations."

(A.) Wavetraps were originally designed to increase the selectivity of inefficient tuners and, although some of them accomplish this to a greater or less extent, they are usually unsatisfactory. If the coils in a receiving set pick up stations when the aerial and ground are not connected, it is impossible for a wavetrapp of any type to operate. This is due to the fact that the wavetrapp increases the selectivity only in the aerial circuit and, naturally, has no effect on the selectivity of the other tuned circuits in a receiver. Unshielded wavetraps are usually unsatisfactory, for the reason that the coils in the set will pick up the signals from the coils in the wavetrapp.

The function of a wavetrapp is to eliminate undesired stations and pass desired signals. To do this properly and without a loss in signal strength, it is necessary to use good apparatus and employ

a system which is tuned to the particular station to be received. The diagram of a wavetrapp of this type, which is entirely enclosed in a metal shield, will be found in Fig. Q2299.

There are incorporated in this trap two filters of different types. The shunt circuit L1 operates as a drain for all frequencies other than those to which the circuit is tuned; in other words, this filter has an infinite impedance to the tuned frequency and almost no impedance to other frequencies. In operation, this part of the circuit is tuned to the frequency of each signal to be received, and serves to pass all other signals to the ground.

The series part L2 of the wavetrapp is used to

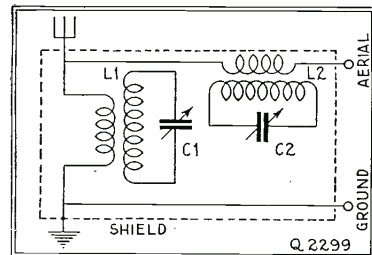

Shielding prevents interaction between the coils in the set and the wavetrapp, thus increasing effectiveness.

eliminate any particularly undesired station which is causing interference; this circuit possesses infinite impedance to the frequency to which it is tuned, and practically zero impedance to all other frequencies.

By the use of these two circuits, the deficiencies of each are overcome. Without the shielding, the reaction of the entire wavetrapp upon the receiver will defeat the purpose of the unit; since a signal will pass from its tuned circuits to the set. The shield may be any of the commercial box shields employed in modern radio receivers, or may be made by taking sheet copper or aluminum and bending it to the correct shape.

The coils employed in this unit are of the spiderweb type and each consists of 65 turns of No. 26 D.C.C. wire for the secondaries and 5 turns for the primaries. They are wound on circular forms two inches in diameter with 9 pegs around the circumference. Straight-line-frequency condensers, having a capacity of .00035-mf., should be used with such coils.

It is possible to separate stations a few kilocycles apart with this wavetrapp, if it is well shielded and the coils in the set do not pick up signals from the interfering station when the aerial and ground are disconnected. It must be remembered, however, that no wavetrapp will function if a coil pick-up is noticeable in the receiver.

A SET TESTER

(2300) Mr. T. B. Riley, Springfield, Mass., writes:

(Q.) "I am a set constructor and dealer. In testing receivers, I often find it difficult to obtain a satisfactory signal from a broadcast station in order to test their operation. I believe that it

would be a very simple matter to build an oscillator to be used with a portable phonograph for doing this test work. Can you supply me with the diagram or any other information on the subject?"

(A.) You will find the diagram of a modulated oscillator of this type in Fig. Q2300. As you will notice, it consists of an ordinary oscillator circuit L1-L2-C1 with a modulator tube coupled to the plate circuit. The transformer T1 should be a modulation transformer or a low-ratio audio-frequency transformer. The battery "B" depends in its value upon the type of pick-up employed, and the best value will have to be found by experiment. The choke coil L3 should be of the ordinary audio-frequency variety and, if desired, the secondary of an audio-frequency transformer can be used for this purpose.

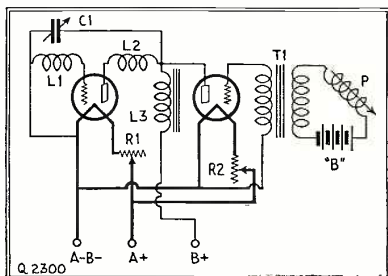

The use of a modulated oscillator for testing receivers will save a lot of time when there are no strong stations "on the air." P is the phonograph pick-up.

The oscillator coils, L1 and L2, are wound on a 3-inch tube. Coil L1 contains 32 turns of No. 22 D.C.C. wire and coil L2 contains 34 turns of the same wire; both of these coils are wound in the same direction with a space of about 1/4-inch between them. The condenser C1 tuning the two coils should have a value of .00035-mf. It will be necessary to use a well-constructed condenser for this purpose, since the "B" battery will be short-circuited if the condenser plates touch.

The two tubes employed in this test circuit may be of either the 201A or the 199 type. If desired, the complete unit can be built in a small portable-phonograph cabinet with dry-cell tubes, so that the batteries and all apparatus can be placed in a small space. If 201A-type tubes are used, the filament resistors R1 and R2 should have a value of about 10 ohms each. If 199-type tubes are employed, these resistors should have a value of 30 ohms each.

Operation

When the complete unit has been finished, it should be tested to make sure that it will operate over the complete broadcast waveband. If the oscillator is not operating correctly, the plate coil L2 should be reversed. The plate voltage should be varied until the correct value is found; but usually one between 60 and 90 volts will be satisfactory. If the transmission is distorted when picked up with a receiving set, the value of the battery "B" should be varied, and the plate voltage on the modulator should also be varied. This can be accomplished by placing a variable resistor in series with the plate lead of the modulator tube; one of about 10,000 ohms will be suitable.

A unit of this type will be satisfactory for neutralizing receivers, testing sets, etc., when convenient broadcast stations are not available for this purpose. The unit should be placed about 10 or 15 feet away from the receiver with the coils facing it. When testing a receiver, the oscillator should first be tuned to a low wavelength and then picked up in the receiver. The operation should then be repeated for the middle and the upper end of the band. If the oscillator cannot be picked up on any part of the wavelength band covered by the receiver, or if whistles are encountered when tuning the set to the wavelength of the oscillator, the set is not operating correctly and the usual methods should be employed for adjusting it. Of course, there are a number of tests for which this oscillator can be used and they will suggest themselves quite readily to the experimenter.

SHORT-WAVE TRANSMITTER

(2301) Mr. R. S. Bower, Galveston, Texas, writes:

(Q.) "I would like to obtain the diagram and instructions for building a transmitter for the 40-meter band, using a 210 tube and crystal control. This transmitter is to be used for amateur trans-

mission and should be as efficient as possible. A 400-volt rectifier-and-filter system will be employed for supplying the plate voltage to the 210 tube, and the filament will be supplied with alternating current."

(A.) You will find the diagram of a transmitter of this type in Fig. Q2301. As you will notice, the transmitter consists of two tubes, one a 112 type for an oscillator, and the other a 210 for the amplifier. The first tube is controlled by a quartz crystal tuned to 160 meters, or 1,874 kilocycles. In operation, the second harmonic of the oscillator (3,748 kc.) is picked up in the grid circuit of the amplifier; and this frequency is again doubled in the plate circuit of the amplifier, producing a frequency of 7,496 kc. or 40 meters. With an arrangement of this type, it is possible to transmit on either 20, 40 or 80 meters without any difficulty. For 20-meter transmission, the plate circuit of the amplifier tube is tuned to the 20-meter band. For 80-meter transmission, it is tuned to the 80-meter band. In this case, however, the 160-meter circuit is eliminated and the amplifier input circuit is tuned to 160 meters.

The coil L1 in the plate circuit of the oscillator is constructed so that the crystal operates correctly without placing a tuning condenser across this coil. No data can be given for the exact dimensions of this coil, since it depends upon the individual crystal. With a crystal tuned to 160 meters, it will consist of about 40 turns of No. 20 D.C.C. wire on a tube 2 3/4 inches in diameter. The best way to adjust this coil is to place a few extra turns on it, and then gradually remove turns until the correct value is obtained. If a 1/2-ampere ammeter is placed in the lead to this coil, a gradual increase in current will be noticed as the correct coil value is reached. Wire should be removed from this coil until the resonance point is passed. This will be indicated by a sudden drop in current. The inductance should then be increased slightly, so that the correct resonance point is obtained.

The next point in operating the transmitter is to tune the 80-meter circuit, consisting of L2 and C2, to resonance. Finally, the 40-meter circuit should be tuned to resonance and the transmitter is ready for operation. The best way to tune the last two circuits to resonance is to use a wavemeter; since in this way the actual wavelength is obtained that is desired for operation. A milliammeter in the amplifier plate lead and a radio-frequency ammeter will indicate the resonance point for each circuit. When operating correctly, the amplifier tube will be drawing about 60 milliamperes and the oscillator about 25 milliamperes. A good way to check the circuit is to remove the crystal from the circuit and notice whether the output of the amplifier drops off to zero. If the transmitter is adjusted correctly, the amplifier plate current will drop to almost zero when the crystal is removed from the circuit.

As you will notice, a key-filter system is used to prevent key clicks and thumps when operating the key. These noises are particularly noticeable with a system of this type, and unusual care should be exercised.

Apparatus Specifications

Coils L2 and L3 should both be wound with No. 14 wire on a 3-inch tube, with 8 turns of wire to every inch of tubing. A satisfactory way to do this is to place the tubing in a lathe and thread it, 8 turns to the inch. Coil L2 contains 28 turns and

coil L3 contains 20 turns. The tuning condensers used with these coils (C2 and C4) have a maximum value of .00025-mf. The radio-frequency choke coils, L4 and L5, should be wound with about 100 turns of No. 30 D.C.C. wire on a 1-inch bakelite tube. These coils may be wound jumble fashion or layer wound, as desired.

The center-tapped resistors placed across the two filament circuits should have a value of about 200 ohms, with a tap at the center. Condensers C6, shunted across these resistors, should have a value of .001-mf. The resistor R1 is a grid leak with a value depending upon the plate voltage used on the oscillator tube. The resistors R3 and R4 are ordinary rheostats of about 10 ohms each. They should have sufficient current-carrying capacity so that they will not be overheated. Resistor R5 has a value of about 12,000 ohms, and is used for reducing the plate voltage applied to the oscillator tube. The bypass condensers, C1 and C7, should have a value of .01-mf., and be capable of standing the plate voltage supplied to the tubes.

The condenser C8 in the key filter has a value of 1 mf., and the choke coil employed in this filter system should have an inductance of about 3 henries. If desired, a 150,000-ohm resistor may be shunted across the key in order to increase the filtering action. The condenser C3 should have a value of .001-mf. You will notice that no "C" bias is supplied to the oscillator tube; this is due to the low plate voltage which is employed, so that the crystal will not be injured. A "C" bias is employed on the amplifier tube and should have a rather high value. A bias of between 50 and 125 volts will give the best results. This comparatively high "C" bias is used so that there will be obtained a rather distorted output, which will tend to increase the value of the harmonics and naturally will increase the output of the transmitter.

Several meters should be connected in the circuit in order to obtain the correct results. An alternating-current voltmeter should be used to measure the filament voltage supplied to the tubes, and a plate voltmeter with a scale deflection of 1,000 volts should be used for measuring the plate voltage. An 0-to-200 milliammeter should be used for measuring the plate current and also to adjust the various circuits to resonance as described above. The input filament voltage should be 8 volts and the plate voltage should be about 500.

The quartz crystals used in this transmitter are manufactured commercially and are ground quite accurately, so that the exact frequency can be obtained. However, if the experimenter desires to try making these crystals, detailed data on this subject will be found in QST Magazine for May, 1928; January, 1928, and May, 1927.

OSCILLATION CONTROL IN RECEIVERS

(2302) Mr. J. White, Savannah, Georgia, writes: (Q.) "I would like to obtain some information about the various systems used commonly in modern receivers for controlling oscillation in radio-frequency amplifiers. I would appreciate any information on the subject, as I am contemplating building a receiver and do not know which system will be the simplest and most efficient. Several of the systems that I refer to are plate-voltage control, grid suppressors, potentiometer control, phase-shifting devices and tuned absorbing systems."

(A.) The whistles that are encountered, when an

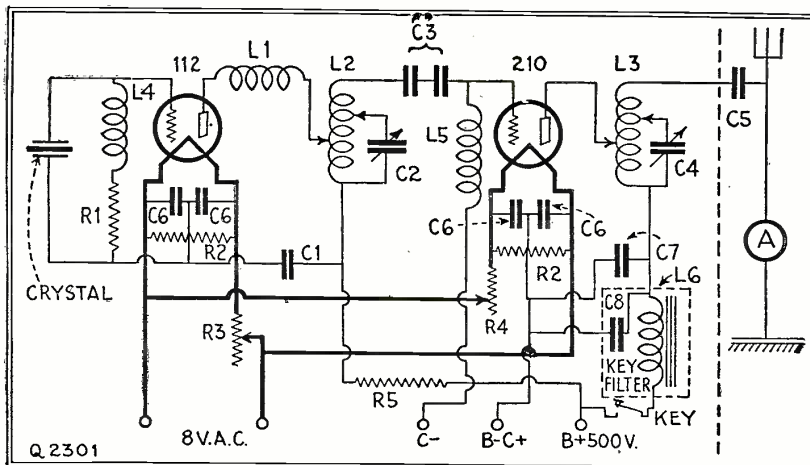

The piezoelectric crystal regulating the frequency of a transmitter will serve to govern its operation on any of the harmonics of the crystal's fundamental frequency; as, for instance, with a 160-meter crystal, the transmitter may be operated on 80 or 40 meters.

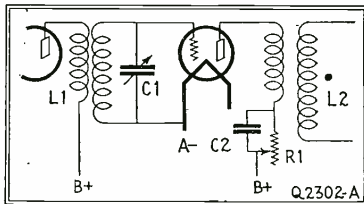

Controlling the plate current in a radio-frequency tube will also control the oscillations.

unbalanced T.R.F. receiver is tuned, almost invariably indicate instability and poor operation. As a general rule, all T.R.F. receivers not employing a balancing method of stabilizing should have some variable means of controlling the oscillation. This is necessary, since the tendency to oscillate increases as the dials are tuned to the lower-wave stations and, if a receiver is designed to operate efficiently on the long wavelengths, it will almost invariably oscillate on the low wavelengths. By using some variable control, the receiver can be kept just under the oscillation point, which of course supplies the greatest efficiency.

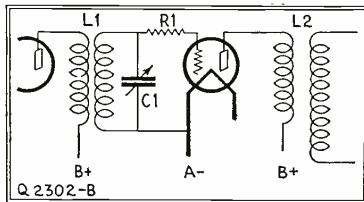

The "grid suppressor" provides an easy way of stabilizing a receiver.

A variable resistor in the plate-supply lead to the R.F. amplifier tubes is a simple and effective method of controlling the oscillation. This acts also as a volume control; since on the powerful local signals, the resistance can be increased and the sensitivity of the receiver reduced. (See Fig. Q2302A.) A by-pass condenser is usually connected across this plate resistor; so that the radio-frequency resistance will not be increased. A resistor of about 200,000 ohms and a condenser of about .006-mf. will be satisfactory. A very similar effect can be obtained by employing a rheostat in the filament circuit of the R.F. tubes and increasing or decreasing the filament current to control the oscillation. However, this system causes a certain amount of distortion, since the undistorted output of the amplifier is reduced considerably when the filament current is cut down below the rated point.

Resistors connected in the leads to the grids of the radio-frequency tubes supply another simple and

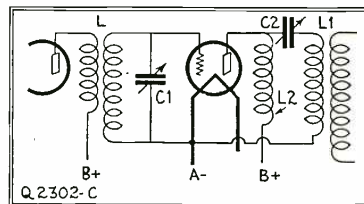

One method of "phase-shifting" in a radio-frequency amplifier, to prevent interaction between stages, is shown here.

effective means of stabilizing an amplifier. These resistors should not have sufficient value to entirely stop the oscillations; since this will reduce the efficiency of the amplifier. A better method is to use a resistor of between 200 and 400 ohms, connected as shown at R1 in Fig. 2302B. A variable adjustment should be provided to bring the receiver below the oscillation point, so that it can be kept at the maximum efficiency. In operation, this resistor limits the energy feed-back from the plate to the grid circuits of these tubes, sufficiently to suppress the oscillation. The resistor used for this purpose should never be connected between the coil and condenser; since this will decrease the selectivity of

the set to a great extent, and will also reduce the amplification.

Phase-Shifting Systems

Another very good stabilizing system is one which shifts the voltage phase in the plate circuit of the R.F. tubes, so that the plate voltage will be out of phase with the grid voltage, thus preventing a feed-back. In this method, a variable condenser is connected in the plate circuit of the radio-frequency tube, and the plate current is supplied through a choke coil or resistor instead of through the primary of the succeeding coupling coil. The primary is then connected to the negative filament terminal instead of the "B+" terminal; since no direct plate current flows through this coil. The condenser used for this purpose should have a maximum value of about .001-mf. (See Fig. Q2302C.)

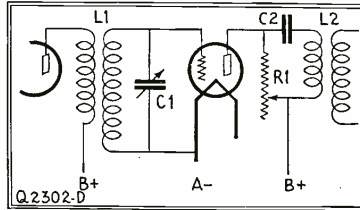

A variation of the "phase-shifting" system of stabilization varies the resistor, instead of the condenser.

Another variation of this system is to use a fixed condenser and a variable resistor. In this case, the condenser C2, in Fig. Q2302D, should have a value of about .002-mf., and a resistor of about 100,000 ohms should be used as R1.

Methods of controlling oscillation which employ resistors, such as the potentiometer, to increase the resistance of the tuned circuit or place a positive bias on the R.F. tubes, are not very efficient; since a positive bias allows a current to flow in the grid circuit, which acts as a leak, thus cutting down the signal strength. The grid returns of the R.F.

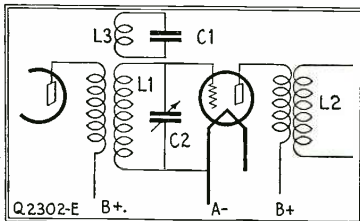

An absorbing circuit, shown at L3-C1, will allow even amplification over the complete band, as explained in the text.

tubes should always be connected to the negative filament line between the filament resistor and the filament, so that the voltage drop across the latter will be impressed on the grid of this tube.

Another very common and simple means of controlling oscillation is to couple to the secondary of the radio-frequency transformer an "absorbing" circuit, which consists of a coil and condenser connected together as shown in Fig. Q2302E, at L3-C1. Since the absorbing action of a circuit of this type is greater on the higher frequencies, the stabilization tends to be constant over the complete band covered by the coils. A coil for this purpose can be wound on a tube slightly smaller than that of the secondary of the R.F. coupling coil, and should contain about 30 turns of No. 28 wire. The condenser should have a value of about .00025-mf. This absorbing coil should be so arranged that the distance between the secondary coil and absorbing coil can be varied to obtain the greatest sensitivity over the complete wavelength range. If the coil is coupled too closely to the R.F. transformer, the amplification will be reduced and, naturally, the sensitivity will also be reduced. A little experiment, however, will soon determine the correct value and position of the absorbing coil, so that each R.F. stage is just slightly below the oscillation point.

Combinations of the methods described above can be made which will result in high efficiency. As an example, you can use grid resistors which will allow each R.F. stage to oscillate slightly, and then use either filament resistors or plate resistors for bringing each of these circuits just below the oscillation point. A single plate resistor may be satisfactory, and allow a continuous variable adjustment over the oscillation at any point on the dials; it will act also as a very convenient volume control for the receiver.

250 POWER AMPLIFIER DATA

(2303) Mr. J. A. Keller, San Diego, Calif., writes:

(Q.) "If possible I would appreciate your publishing the diagram and constants for making a power amplifier using the new 250-type power tube and a "B" power unit with a half-wave rectifier using the 281-type tube. I would like to have the output circuit arranged with resistors to supply variable taps for a five-tube receiver. I intend to use a half-wave transformer with a secondary voltage of about 600 for the plate supply and two filament windings of 7½ volts each. I would like also to obtain "C" bias for the 250 tube from the power unit so that no extra "C" battery will have to be used.

(A.) You will find in Fig. Q2303 the diagram of a power unit of the type that you require, employing one 281-type rectifying tube and one 250-type as a power amplifier. The transformer supplying current to this rectifier should have an output rating of about 200 watts and the output leads should be very carefully insulated to prevent any danger due to short circuits. The two choke coils L1 and L2 should have an inductance of about 15 henries each and be provided with an air gap, because of the high current which is passed through them. The filter condensers C1, C2 and C3 should have a working voltage of at least 800 or 1,000 volts D.C. C1 and C3 should have a capacity of 4 mf. each, and C2 a capacity of 2 mf. The output resistor R1 should have a total resistance of 30,000 ohms and be capable of passing at least 125 milliamperes without overheating. A wire-wound resistor with sliding contacts will probably be the most satisfactory. The

(Continued on page 287)

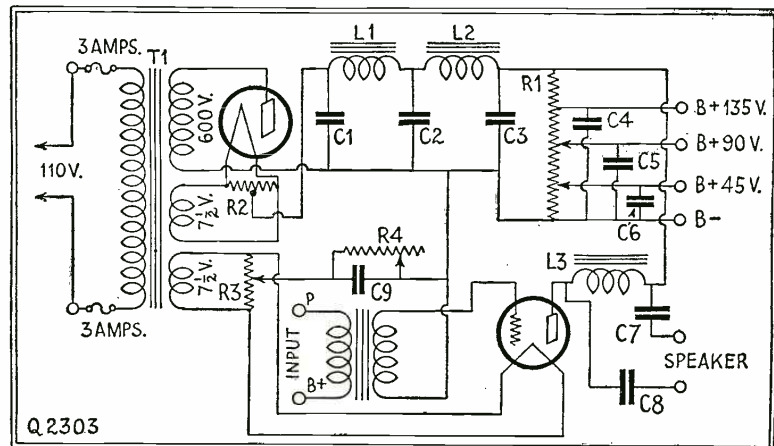

A UX-250 tube, used as a power amplifier with a suitable plate supply, will improve most receivers. The plate supply can also be arranged to operate the other tubes in the set.



On the Short Waves

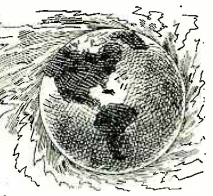

SIBERIA'S HIGH-POWER STATION

Editor, RADIO NEWS:

In a recent issue of RADIO NEWS, I noticed a discussion on Russian broadcast stations, and wish to supply you with the following information:

The station RFN is installed at Khabarovsk, Siberia, which is approximately 400 miles north of Vladivostok. This station, at the time the engineer left there, was operating on 60 meters with a power of approximately 10 to 12 kilowatts in the antenna. This station is crystal-controlled and has been in service for about one year. As far as I know, this is the only high-power broadcast station operating on short waves in Russia and Siberia at the present time.

C. J. MADSEN,
Radio Engineering Dept.,
Westinghouse Electric & Manufacturing Co.,
Chicopee Falls, Mass.

LEAGUE OF NATIONS BROADCASTS

Reports on the international broadcasts of the sessions of the League of Nations, which are now being tabulated, may lead to the establishing of a regular short-wave radio service for the broadcasting of these meetings. As an experiment, the sessions of the last meeting of the League were broadcast over station PCLL, Kootwijk, Holland, on a wavelength of 18.4 meters, using a power of 25,000 watts. The announcements were made in English, French, Dutch and Japanese and all listeners were asked to send a postcard and describe the strength and clarity of the signals. So far the success of this test is not known, for reports continue to be received from listeners at distant points; but it is thought that there is sufficient interest in these broadcasts to justify the construction of a special high-power short-wave station which can be used for broadcasting and for carrying on the League's own business.

While this is not the first time that addresses in these meetings have been broadcast, it was the first time that short waves have been employed for the purpose. Radio was first used by the League of Nations in 1925; in 1926 an opening address was sent over long-distance lines from Geneva to Prague and there broadcast. Later, English, Danish, German and French stations joined in broadcasting other important speeches from the meetings. All this was done on the regular wavelengths used by these stations and reception was limited to a comparatively small area.

The Dutch short-wave station at Kootwijk, which is frequently heard in this country, was originally constructed to carry on radio-telephone experiments with Java.

RADIO MOVING PICTURES

A regular radio-picture program, it is announced, will be broadcast on Monday, Wednesday and Friday nights by C. Francis Jenkins of Washington, on 6,420 kilocycles (46.72 meters) under the station call letters of 3XK. The transmissions are purely experimental but, if a sufficient number of persons install picture receivers, it has been announced by Mr. Jenkins, pictures will be broadcast daily.

TEN-METER EXPLORATION

An international short-wave radio "party" is planned by the American Radio Relay League for August, when amateurs in every civilized country will attempt to carry on two-way communication on a wave length of 10 meters. The dates of the tests will be Aug. 11 to 12; 18 to 19 and 25 to 26. The purpose of the experiments is to determine, if possible, just what can be expected of the comparatively low-powered transmitters used by the amateur stations when operating on the newly-assigned ten-meter wavebands.

The unsettled and rainy weather encountered in the A. R. R. L.'s May tests was believed to be in some way connected with the unexpected "dead" period which was then obtained. However, the ardor of the ten-meter experimenter was by no means dampened. To cover all possible weather conditions, and obtain a comparison of results at different places on different dates, it has been decided that the August test shall cover three week-ends. Several experimenters have investigated local transmission conditions about their ten-meter stations, using portable receivers in automobiles.

The results of these tests, according to records obtained by the League, show that the "ground-wave" of ten-meter transmission can be used for communication within about 30 miles of the transmitting station; but beyond that distance the normal skip-distance effect of short waves is not manifested again for nearly 1,000 miles. Cold, rainy weather has been found to hamper greatly communication on this waveband.

The new tests are expected to clear up much of the uncertainty which now exists in the minds of many radio experimenters as to the value of

the very short wavelengths for reliable communication.

EINDHOVEN'S SPANISH PROGRAM

Editor, RADIO NEWS:

Since writing you last I have received station PCJJ, Eindhoven, Holland, about eight times; they are now operating on 31.4 meters. Using the eight-turn Aero coil and 7 plate condensers, the following are the dial readings on my set: 12, 15 and 9. Station WGY, (2XAF), at Schenectady, comes in about a point and a half above this with loud volume.

In your last issue Robert M. Sprague of Hanover, N. H. asks for information on a short-wave station. My records show that on April 12, between 8 and 9 p. m., E.S.T., PCJJ was broadcasting to Cuba on a wavelength of 30.2 meters with announcements in Spanish. Each announcement ended with "Uno Momento" and at 8:25 P.M., they played a phonograph record, "I Want to be Happy," with a tenor and soprano duet. I hope this information will be of interest to your readers.

WALTER E. HEDMAN,
Jentland, Maine.

CANADIAN SHORT-WAVE BROADCASTS

Editor, RADIO NEWS:

Station CKY, Winnipeg, Canada, has a short-wave station operating on about 25 meters with a power of 2 kw. This station is on the air every afternoon from 2:15 o'clock on.

NORMAN WISWELL,
Colebrook, N. H.

SAINTE ASSISE?

Editor, RADIO NEWS:

Could any of your readers tell me through your columns the call letters of the French station transmitting on 23 or 24 meters on June 8 and 9, at 7 o'clock, Eastern standard time?

H. J. LOISELLE,
Worcester, Mass.

Editor, RADIO NEWS:

Can you inform me or at least direct me to some source from which I can get the call letters and location of a French radio station transmitting on a wave of about 25 meters?

I first picked up this station on June 5th. I also had it on June 6th, 7th and 8th, but the announcements that I have received have been made in French. I have not been able to understand much of it, but from my meager knowledge of the language, I would say that the announcer was reading news dispatches or else he was an amateur; but because of the strength and steadiness of the signals, I rather doubt the latter. It seems as if one man was doing all the reading, but I am not sure of this. On the 7th I heard him sign off by saying in French that it was thirteen hours, Greenwich time.

Outside of a few simple words, I have so far been unable to understand the announcements. About every fifteen minutes he calls "Hello, hello." I have picked him up as early as 4:45 P. M., Eastern daylight-saving time, and have heard him clearer and louder than 5SW.

I would appreciate any help that your readers may be able to give me.

JOHN K. UHLER,
Easton, Pa.

SHORT-WAVE RECEPTION ON A STANDARD ULTRADYNE

Editor, RADIO NEWS:

Some time last winter, I think in November, I wrote you telling you that I had, and could regularly receive the 60-meter short-wave station at Khabarovsk, on my 8-tube Ultradyne receiving set, and expressed the opinion that this was due to a harmonic of the transmitter.

You later favored me with your reply in which you stated that all harmonics of a transmitter are below the fundamental wave. You further said that this reception was evidently due to some kind of re-radiation from a metal structure in my neighborhood. At that time I was contented with your explanation, as my house is located on the very edge of the city and only about a mile from huge oil tanks of the Standard Oil Company.

Since then a friend of mine has built an Ultra-

(Continued on page 281)

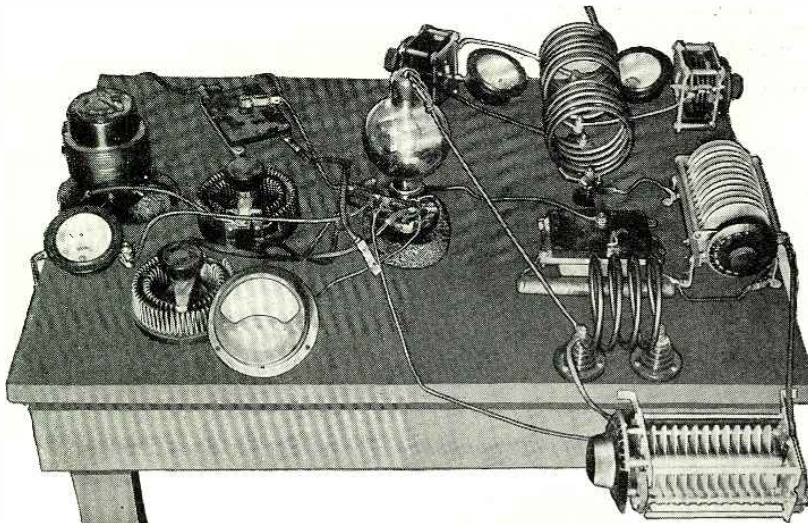

The amateur experimental short-wave transmitter pictured above is one of the first to demonstrate the value of the ten-meter waveband. With it Charles K. Atwater, of Upper Montclair, N. J., has been successful in holding two-way communication with two amateur stations on the Pacific Coast, on ten meters with low power; the first time these waves had been used for transcontinental communication. Atwater's station operates under the call letters 2JN, and has been credited with many other achievements, including transatlantic two-way communication on ten-meters with 8CT, Arcachon, France. For his short-wave receiver Atwater uses a three-tube screen-grid set; and a receiver modeled after his design will be described in next month's RADIO NEWS.

WHOLESALE PRICES

for Dealers, Community Set Builders, General Repairmen and Agents!



New 75 HOOKUPS
500 ILLUSTRATIONS

Be sure to get this great 144-page book with net prices to the radio trade.

Radio Specialty Company is radio's oldest radio parts mail order house in the country, and the new confidential prices on standard radio merchandise are the lowest of any radio house.

We are ready now to appoint additional agents in all parts of the country. If you are contemplating making big money in radio merchandise, be sure to get in touch with us at once.

Television is here!

Radio Specialty, as usual, is first with all new things. Send at once for free booklet for lowest prices on all television parts which have been put on the market so far. (If you have Catalog No. 18, just ask for the Television Supplement.)

THIS 144 PAGE RADIO CATALOGUE FREE

BUY from Radio's Oldest Mail Order House!

We are the oldest established, exclusive radio mail order house in the country. All orders are positively shipped within twenty-four hours; quick, prompt, courteous service. We carry a larger variety of radio parts, radio instruments, accessories and radio findings than any other radio house in the country.

You will find in Catalog No. 18 the largest assortment of radio merchandise in this country. Radio Specialty carries more radio parts and radio material than any other house in the country. You will find in this catalog positively the largest variety of radio merchandise.

If you are in need of certain small radio parts that other radio and mail order houses do not bother to carry get the Rasco Catalog and you will find the small parts there, anything from a screw to copper ribbon, telephone diaphragms, as well as thousands of other small radio findings. Just to mention a few:

Lugs, nuts, jacks, plugs, all kinds of knobs, cords, panels, screws, sliders, washers, selenium, tinfoil, switches, crystals, cap nuts, Litz wire, cord tips, brass rods, resistances, binding posts, switch parts, carbon balls, switch points, lock washers, carbon grains, ground clamps, metal pointers, insulated tubing, low melting metal, antenna connectors, as well as thousands of other articles. We carry the Largest Variety of Small Radio Parts in the World, BUT We also carry All Standard Radio Merchandise.

"RASCO" has it

ANYTHING IN RADIO

Radio Specialty Co.

98W PARK PLACE, NEW YORK



Build THE STROBODYNE

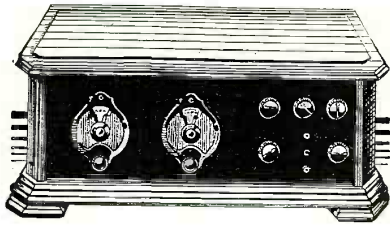

*The Greatest Super
Heterodyne*

Enjoy Good Reception
the Year 'Round

For fine, clear, undistorted reception month-in, month-out, the year 'round, build yourself a STROBODYNE, the greatest Super-Heterodyne of the age. The STROBODYNE employs a new principle in Super-Heterodyne construction. This principle, known as the Stroboscopic Phenomenon, applied to the basic principles of Super-Heterodyne construction, is what has placed the STROBODYNE so far ahead of all other receiving circuits.

The STROBODYNE employs eight tubes and is a marvel from the standpoint of selectivity, accurate tone reproduction, and as a DX set.

In building the STROBODYNE the only available full-sized, authorized blue prints are published by CONSRAD, famous old pattern publishers of radio. THIS IS THE ONLY OFFICIAL PATTERN PUBLISHED. It contains four full-sized blue prints and a special 16-page instruction book that answers, fully, all questions relating to the STROBODYNE and its operation. Also, this book gives step-by-step instruction for building.

Write today. Get a full set of STROBODYNE patterns from CONSRAD. Build this wonderful set and insure the best year-'round reception.

Complete Constructional Data

only **50c**

THE CONSRAD CO., Inc.
230 FIFTH AVE., NEW YORK, N. Y.

THE CONSRAD CO., INC.,
230 Fifth Ave., New York, N. Y.

Gentlemen:
Kindly send me a full set of STROBODYNE patterns. Enclosed find 50c.

Name.....
Address.....
City..... State.....

Giant Photoelectric Cells for WRNY

(Continued from page 221)

glass stems projecting from the sides of the bulbs (see illustrations on page 221 and below) are nipples to which the pumps may be attached.

test machine is very simple, and corresponds almost exactly with that of the WCFL apparatus. The subject sits in a shaded booth facing the photoelectric cells. His



The three giant photoelectric cells, in the hands of (left to right) Robert Hertzberg, managing editor, RADIO NEWS; I. Goldberg, president, and John Geloso, chief engineer, of the Pilot Electric Mfg. Co. Mr. Goldberg is holding also a small photoelectric cell, of the ordinary size.

SETTING UP THE CELLS

As soon as the cells reached New York, they were mounted in a temporary frame, practically identical with the one shown in Figs. B and D on pages 219 and 220. An experimental television outfit, with transmitting and receiving discs attached to a common shaft, was constructed in the laboratories of the Pilot Electric Company, in Brooklyn, merely for the purpose of studying the behavior of the cells in actual operation. The appearance of this

face is "scanned" by the rays of light from an arc light, which are broken up by a disc with the usual spiral of holes. This disc is attached to one end of a long steel shaft, (the left end, as the picture shows the machine), while the receiving disc is attached to the other. Behind the latter disc is a neon glow tube, connected to the output of the amplifiers which are operated by the photoelectric cells. The arc light is between the transmitting and receiving booths. The table in the foreground holds a five-stage amplifier, for the cells. The received

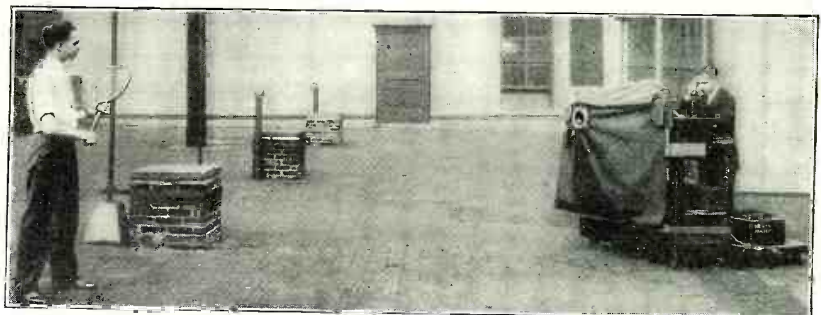

The new television camera (see page 258) on the roof of the Bell Telephone Laboratories, New York City.

necessarily crude affair is shown in the picture at the top of page 221.

The arrangement of the parts in this

images are observed in a shaded compartment, directly behind the man shown in the picture on page 221. The person to be tele-

Please say you saw it in RADIO NEWS.

What These Have Done YOU CAN DO!

"Since I have been studying with your school I have been appointed chemist for the Scranton Coal Co., testing all the coal and ash by proximate analysis."
—Morlais Couzens.

"I also have some news for you. I have been made assistant chemist for the concern I am working for."
—A. G. Delwarte.

"I am now cleaner and dyer for the above named company. My salary is almost double what it was when I started the course."
—E. H. Lasater.

"Your training has opened things to me that otherwise I would probably be years in acquiring. I now enjoy comforts that before I had to do without. It enabled me to have a wonderful little home, a fine laboratory of my own, and gave me a respected position in one of the foremost textile concerns in the country."
—J. J. Kelly.

"If it weren't for your course I wouldn't have the job I've got now."
—George Daynes.

"Since beginning your course of study I have received an increase in my pay check, and as I progress my work becomes lighter through a better understanding."
—M. G. Cole.

"I am mighty glad I took this course. My salary has been increased several times, and different industrial plants are coming to me for a little advice on different things, netting me a fair side income."
—M. E. Van Sickle.

IF you are dissatisfied with your present work, if you wish to earn more money, if you want to get into a profession where the demand for trained men is increasing as the Chemist plays a more and more important role in the industrial life of this country, let us teach you Chemistry.

You, Too, Can Learn CHEMISTRY AT HOME

To qualify for this remarkable calling requires elaborate specialized training. Formerly it was necessary to attend a university for several years to acquire that training, but thanks to our highly perfected and thorough system of instruction, you can now stay at home, keep your position, and let us educate you in Chemistry during your spare time. Even with only common schooling you can take our course and equip yourself for immediate practical work in a chemical laboratory. Dr. Sloane gives every one of his students the same careful, personal supervision that made him celebrated throughout his long career as a college professor. Your instruction from the very beginning is made interesting and practical, and we supply you with apparatus and chemicals for performing the fascinating analyses and experimental work that play such a large part in our method of teaching, and you are awarded the Institute's official diploma after you have satisfactorily completed the course.

FORTUNES HAVE BEEN MADE THROUGH CHEMISTRY

Alfred Nobel, the Swedish chemist who invented dynamite, made so many millions that the income alone from his bequests provides five \$40,000 prizes every year for the advancement of science and peace. C. M. Hall, the chemist who discovered how to manufacture aluminum, made millions through this discovery. F. G. Cottrell, who devised a valuable process for recovering the waste from flue gases; James Gayley, who showed how to save enormous losses in steel manufacture; L. H. Baekeland, who invented Bakelite—these are only a few of the men to whom fortunes have come through their chemical achievements.

NOW IS THE TIME TO STUDY CHEMISTRY

Never before has the world seen such splendid opportunities for chemists as exist today. In factories, mills, laboratories, electrical shops, industrial plants of all kinds, chemistry plays a vital part in the continuation and expansion of the business. In every branch of human endeavor the need for chemists has arisen. Those who have the foresight and ambition to learn chemistry now will have the added advantages and greater opportunities afforded while the chemical field is growing and expanding.

EASY MONTHLY PAYMENTS

You do not have to have even the small price of the course to start. You can pay for it in small monthly amounts or earn it as many others are doing. The cost is very low, and includes even the Chemistry outfit—there are no extras to buy with our course. Write us and let us explain how you can qualify for a trained technical position without even giving up your present employment.

COMPLETE LABORATORY EQUIPMENT

We give to every student, without additional charge, his chemical equipment, including fifty-two pieces of laboratory apparatus and supplies, and fifty-two different chemicals and reagents. The fitted heavy wooden box serves not only as a case for the outfit, but also as a laboratory accessory for performing countless experiments. Full particulars about this special feature of our course are contained in our free book, "Opportunities for Chemists."

DIPLOMA AWARDED TO EACH GRADUATE

Upon graduation each student is awarded our Diploma in Chemistry, certifying that he has successfully completed his studies. Your name on this certificate will be a source of pride to you all your life, as well as an aid to obtaining a position in Chemistry.

MAIL THE COUPON FOR FREE BOOK

Clip the coupon below and mail it at once. Your name and address on the coupon will bring you by return mail our interesting free book "OPPORTUNITIES FOR CHEMISTS" and full particulars about the course and what it will do for you

CHEMICAL INSTITUTE OF NEW YORK, Inc.
Home Extension Division 9
16-18-R-East 30th St., New York, N. Y.

Please send me, without any obligation on my part, your free book "Opportunities for Chemists" and full particulars about the Experimental Equipment given to every student. Also please tell me about your plan of payment.

Don't Wait—Mail the Coupon NOW!

CHEMICAL INSTITUTE of NEW YORK, Inc.

16-18-R-EAST 30th ST. Home Extension Division 9 NEW YORK, N. Y.

NAME
ADDRESS
CITY STATE

Centralab Modu plug

Puts-
your set in the
high price class

WITH Modu-Plug replacing your speaker plug you can enjoy the tone volume of this year's best sets for only **\$2.50**.

One knob on Modu-Plug gives full tone volume control from whisper to maximum. Helps match impedance of speaker to the set.

CENTRAL RADIO LABORATORIES
19 KEEFE AVE.
MILWAUKEE, WIS.

Write for New Booklet on applications of variable resistances.

\$2.50
standard or cord type at your dealer's.

Standard Type



Your Set Can Now Get Short Waves

Sent anywhere in the U. S. post paid upon receipt of price. Canada and Foreign, 60c additional. Money order only. Also sent C. O. D. plus postage in U. S. If \$1.00 accompanies order to insure carrying charges. In ordering be sure to name set and tubes used, such as UV199, UX199, WD11, 201A, UX226 or UY227. Price \$15.00 or \$17.50 for A. C. Sets.



The SUBMARINER

will convert your regular set into a short-wave receiver by simply inserting a plug in place of one of the tubes. This takes but a few seconds. With "Submariner" it will enable you to tune between 26 and 68 meters.

This device operates with all sets, such as T.R.F., Neutrodyne, Super-Heterodyne and others A C or D C operated. No additional tubes, batteries, or coils required. If set operates a speaker it will do so with "Submariner" attached. Operates a wave changer with Super-Heterodyne and as detector unit with others.

SHORT-WAVE RECEPTION

is practical, and especially in summer, as they penetrate better and there is less static. The "Submariner" waveband includes practically all powerful stations which broadcast programs. You may also listen to amateurs from all parts of the world who transmit code messages. You will have one of the most efficient short-wave receivers when the "Submariner" is attached to your set. Get a "Submariner" so you may have command of the short-wave activities as well as the broadcast band. If your Dealer does not carry

ORDER TODAY DIRECT

This device has been nationally advertised, and sold in all parts of the world for the past two years

J-M-P MANUFACTURING CO., INC.
Department 53 Milwaukee, Wis., U. S. A.

SET BUILDERS BIG DISCOUNTS

Big New Fall Catalog — Shows latest A-C circuits, newest ideas. 4000 leaders. Get sets and parts you want here. Save money. Parts, kits, complete factory-built sets, supplies. Quick service. Write for free copy. Standard discounts to dealers, set builders, agents. Barawik Co., Dept. 899G Chicago, USA.



vised merely sits in the chair shown at the left.

As the transmitting and receiving discs are on the same shaft, they are perfectly synchronized. The set-up was completed just before this number of RADIO NEWS went to press, and the editors had the opportunity of observing very good images in it. The discs used were made hurriedly and did not run too smoothly, but in spite of their imperfections showed definite promises of success.

Separate transmitting and receiving units are now under construction, as are improved discs with square holes and heavy flanges. Further details of this interesting work, which is being done for WRNY under the supervision of John Geloso, chief engineer of the Pilot Company, will be described in our next number. If things develop as rapidly as they promise, an article telling how to make your own television receiver will also appear.

Television Out of Doors

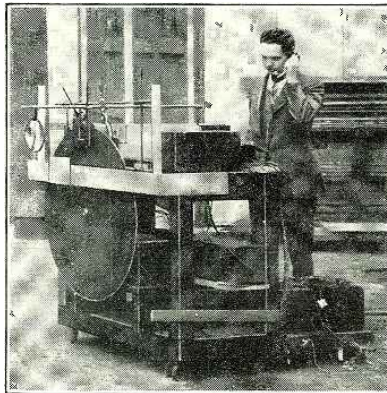

The new outdoor television camera, with its hood removed to show the scanning disc. A white spot on this disc operates a second photo-electric cell, which sends a synchronizing impulse.

AS this issue of RADIO NEWS goes to press, an important development in the transmission of television is being demonstrated by the Bell Telephone Laboratories in New York City. The engineers of these laboratories, who in April of last year gave the first American demonstration of television, have disclosed the important details of a new television camera which represents the progress they have made during their continued research. This camera is capable of scanning an object in ordinary daylight without the necessity of artificial illumination. The subject may be of any size and at any desired distance from the camera; the only limiting factor being the loss of detail as the size of the televised area is increased.

The importance of this development can be appreciated best by comparing the results obtained with those secured when using older methods. Previous to this, the only television pictures which have been transmitted successfully have shown the head and shoulders of a man, or some other image of equivalent size, and in taking these pictures the subject is placed under intense artificial light within two or three feet of the camera. On the other hand, with the new system, the actions of two men engaged in a boxing match may be shown; and the pictures may be taken out-of-doors with the camera at a distance.

Learn ALL ABOUT AVIATION

EVERYBODY'S AVIATION GUIDE is a complete discourse on practical aviation, by MAJOR VICTOR W. PAGE, one of the leading men in the field. Unlike most books of instruction, EVERYBODY'S AVIATION GUIDE is written in a unique question and answer fashion, which makes the subject far easier to study and a great deal more attractive as an instruction course.

This book was recently published and is absolutely up-to-date in every way. It has had very favorable criticism throughout country-wide aviation circles and has been highly recommended by all those in a position to pass judgment.

We list here the contents in order that you may see for yourself how completely the field of Aviation is covered.

Contents:

- Early Aeronautic History—First Flying Machines—The Atmosphere
- Forms of Aircraft—Airplanes and Airships
- Lighter-Than-Air Craft—Balloons and Dirigibles
- How An Airplane Flies—Elementary Aerodynamics
- Airplane Parts and Their Functions
- Fuselage Forms and Landing Gears
- Wing Arrangement and Construction
- Power Requirements, Engine Types and Engine Location
- Aircraft Propellers. Design and Application
- Airplane Equilibrium and Control
- Official World and American Air Records

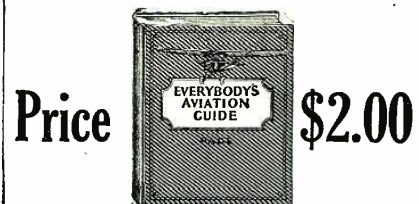

Over 248 pages
Beautiful red cloth binding—Title in gold
Replete with illustrations

WRITE DIRECT TO

CONSRAD CO., Inc.

230 Fifth Ave. New York, N. Y.

CONSRAD COMPANY, Inc.
230 Fifth Ave., New York, N. Y.

Gentlemen: Kindly send me one copy of your book, EVERYBODY'S AVIATION GUIDE Enclosed find \$2.00.

Name.....

Address.....

City..... State.....

of twenty feet or more from the scene. In other words, the new invention removes television from the studio and permits the transmission of larger scenes.

There are three important differences between the new television camera and the old design. First, a new photoelectric cell of greatly increased sensitivity is used. Second, the scanning disc is much larger in diameter and has larger holes, thus providing the photoelectric cell with a greater amount of light. Third, a new optical system is used which employs a six-inch lens to project the image on the disc, thus providing the cell with a still greater amount of light. These three improvements make it possible for the cell to attain sufficient output for the operation of a sensitive amplifier even on a cloudy day. Another feature is that the camera may be focused by moving the lens back and forth.

In the New York demonstrations the pictures are taken on the roof of an office building, while the receiving equipment is located in a darkened room on the seventh floor of the same building. The connection between the television camera and the receiver is as yet by telephone wires; although it is explained that the signals can be sent and received by radio just as easily. The camera is portable, being assembled on a wooden frame which is mounted on four wheels, as the pictures show.

The picture on page 256 shows clearly the appearance of the camera; when it is viewed from the front, the large lens is visible, as well as a black cloth hood which covers the frame and prevents stray light from reaching the photoelectric cell. The scanning disc is of aluminum which has been painted black; it is three feet in diameter and provided with 50 holes, 1/16-inch in diameter, which have been drilled in a spiral path along the outer rim of the disc. The photoelectric cell, which is approximately two inches in diameter, is located in a box mounted directly behind the disc. To turn the disc a D.C. motor is used, which operates also the generator of a synchronizing current used to control the speed of the motor turning the receiving disc. The amplifier equipment is located in a long box at the rear of the frame. Five stages of amplification are used, and distortion has been reduced to a minimum. The images seen by a Radio News representative, though taken just after the sky had clouded over before a violent storm, were remarkably clear and distinct in their movements.

SHORT-WAVE TELEVISION BROADCASTING

Licenses for experimental television transmission which have just been issued by the Federal Radio Commission authorize television transmission by the Radio Corporation of America, New York, under the call 2XBS; Westinghouse Electric and Manufacturing Company, East Pittsburgh, Pa., under the call 8XAV; J. Smith Dodge, Lexington, Mass., under the call 1XAY; Harold E. Smith, Beacon, N. Y., under the call 2XBU; P. S. Lucas, Los Angeles, under the call 6XBW; F. L. Carter, Long Island City, N. Y., under the call 2XBT, and the Aero Products, Inc., Chicago, under the call 9XAG. These licensees are authorized to transmit in the channels between 4,700 and 4,900 kilocycles (63.79 to 61.19 meters.) The Jenkins Laboratories, Washington, also have been licensed to undertake television transmission, under the call 8XK, on 2,140 and 4,280 kilocycles (140.1 and 70.05 meters.)

THE AMRAD MERSHON CONDENSER

Send for
YOUR FREE COPY
of our new book
on the
MERSHON CONDENSER

One of the most sensational devices in the history of radio engineering — the Mershon Condenser has revolutionized the building of electrical sets, B Eliminators, Power Packs, and has a score of other important uses in radio. Unaffected by moisture; tremendous capacity in small space—and lower priced than paper condensers.



Self-Healing
in case of
Puncture.

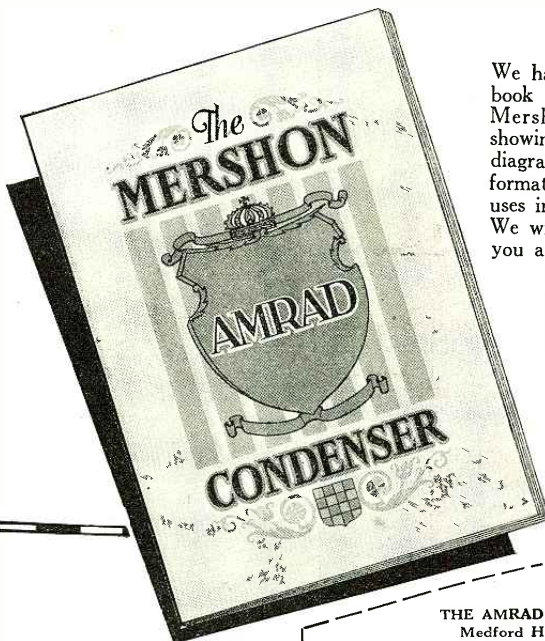

We have issued a new book describing the Mershon Condenser, showing hook-ups and diagrams, and giving information about its many uses in the radio field. We will be glad to send you a copy if you will address Department 18, or use the coupon below for quick action.

The—
AMRAD CORPORATION
Medford Hillside, Mass.

J. E. HAHN *President*

POWEL CROSLY, JR., *Chairman of the Board*

Please say you saw it in RADIO NEWS.

THE AMRAD CORPORATION
Medford Hillside, Mass.

Gentlemen:
Please send me a copy of your new booklet describing the Mershon Condenser.

Name.....

Address.....

City..... State.....

Saves tubes -sweetens reception

A-C tubes, filters and step-down transformers are built to operate on 110 volts. In many places the normal line voltage is from 112 to 118 volts. In most places the voltage varies, so that sometime during day or night there are "surges" which burn out tubes and harm sets.

Wirt A-C Voltage Regulator

protects set and tubes, eliminates extraneous line noises and thus improves the tonal quality of your set. The speaking voice comes in truer and clearer, music is sweeter and more pleasing, and the harmony perfectly balanced.

Only \$2.25. If your dealer cannot supply you, send direct. Get yours today.

THE WIRT COMPANY
5221 Greene St., Philadelphia, Pa.

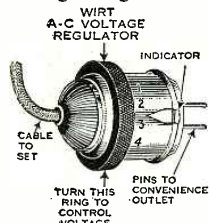

Making Efficient Coils

(Continued from page 234)

the secondaries should have 84 turns of No. 26 D.C.C. wire; giving a winding length just about two inches.

The antenna primary P1 will have 18 turns of the same wire, wound starting just about 1/8-inch from the filament end of S1 and on the same winding form (See Fig. 2B.)

Primary P2 will have 14 turns of about No. 35 S.C.C. wire wound on a 1 3/4-inch form; and this winding will be continued for another 14 turns for the neutralizing coil NC.

To avoid the difficulty of making a movable tickler, a fixed tickler with a variable condenser C3 is used to control regeneration; the variable condenser should have a capacity of .0005- or .00035-mf. It will be satisfactory to wind the fixed tickler just over the filament end of S2; cementing a narrow band of celluloid and then a strip of corrugated paper, cut from a vacuum-tube wrapper, over S2 to provide spacing between the windings (See Fig. 3B.) This tickler will require only 5 or 6 turns of fine wire for satisfactory regeneration of a detector tube such as the 201A.

The antenna and detector tuning coils should be separated six or seven inches and should be mounted at right angles. Mounting the coils just behind the tuning condensers, away from the panel, will generally prevent any trouble from hand capacity.

Radio for Airplanes

(Continued from page 203)

the operator may cover the entire range of wavelengths now in general use, including the 600-meter band, if he so desires.

The generator of current for the airplane transmitter, showing the single vane which rotates it, by air pressure, when the plane is flying.

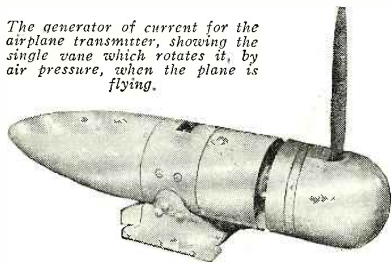

The wind-driven generator was mounted in an exposed position on one of the wings of the plane. It has an output of 1,000 volts, which feeds through the filter box to the 211 tubes. This supply is used also to feed the plates of the two 210 tubes after passing through suitable resistors to reduce it to the required 350 volts.

AID FROM AMATEURS

At frequent intervals throughout the trip, 2XKB broadcast requests for data on the reception of its signals and, from the reports thus obtained, much valuable information was gained. One of the first reports to reach the office of the Radio Corporation after the start of the flight was sent by A. W. McAuly, of Oakmont, Pa., operator of amateur station SCEO. This report, which is typical of those received from amateurs in all parts of the country, reads in part as follows:

Please say you saw it in RADIO NEWS.



Complete instruction course in three volumes. Every point of aviation efficiently and thoroughly treated. Subjects covered in these volumes—

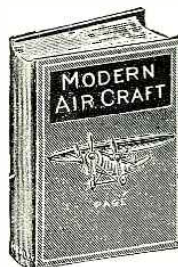

MODERN AIR CRAFT

700 Pages
500 Illustrations

Contents of each chapter—
I. Aircraft Types. II. Lighter-than-Air Craft. III. Early Airplane Designs. General Design Considerations. IV. Design and Construction of Aerofoils. V. Arrangement, Fabrication and Bracing of Airplane Wings. VI. Airplane Fuselage and Landing Gear Construction. VII. Airplane Power Plant Types and Installation. VIII. Aviation Engine Design and Construction. Air-Cooled Engines. IX. Aviation Engine Design and Construction. Water-Cooled Engines. X. Aviation Engine Auxiliaries. XI. Aircraft Propeller Construction and Action. XII. Airplane Equilibrium and Control Principles. XIII. Lifting, Setting Up and Aligning Airplane. XIV. Inspection and Maintenance of Airplanes and Engines. XV. Details of Modern Airships and Airplanes. XVI. Seaplanes, Flying Boats, Amphibians and Other Aircraft. XVII. Some Aspects of Commercial Aviation. XVIII. Aircraft Instruments and Aerial Navigation. XIX. Standard Nomenclature for Aeronautics Report No. 240, Part I.

This book is written in simple, understandable language.

PRICE \$5.00

AVIATION ENGINES

This treatise, written by a recognized authority on all of the practical aspects of internal combustion engine construction, maintenance, and repair, fills the need as no other book does. The matter is logically arranged; all descriptive matter is simply expressed and copiously illustrated, so that anyone can understand airplane engine operation and repair even if without previous mechanical training. This work is invaluable for anyone desiring to become an aviator or aviator mechanic.



274 PAGES

PRICE \$1.25

A. B. C. OF AVIATION

This book describes the basic principles of aviation, tells how a balloon, or dirigible is made, and why it floats in the air. Describes how an airplane flies. It shows in detail the different parts of an airplane, what they are, and what they do. Describes all types of airplanes and how they differ in construction, as well as detailing the advantages and disadvantages of different types of aircraft. It includes a complete dictionary of aviation terms and clear drawings of leading airplanes.

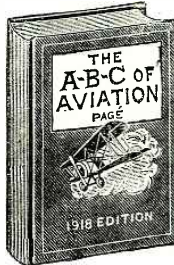

PRICE \$1.25

Remit by cash, stamps, check, or money order
No C.O.D.'s

We Pay Postage On All Books

CONSRAD COMPANY, Inc.
302 FIFTH AVENUE NEW YORK



Push-Pull Power Stage for Dynamic Speakers

For best results, every dynamic type speaker should be preceded by a push-pull amplifier. This is particularly true because they reproduce frequencies as low as 30 cycles and the attendant hum from raw AC on the filaments of power tubes is greatly pronounced unless filtered out by a push-pull amplifier. The AmerTran completely wired push-pull power stage has been specially designed for dynamic speakers. Consists of type 151 input and output transformers (200 for working out of 210 type tubes or 362 for 171 type tubes). Completely wired with sockets and resistances. Also available for cone type speakers and for both 210 and 171 tubes.

Licensed under Patents owned or controlled by R. C. A. and may be bought with tubes
Price complete (without tubes) \$36.00
(slightly higher west of Rocky Mountains)

Write us for hook-up of this remarkable instrument.
AMERICAN TRANSFORMER COMPANY
Transformer Builders for more than 25 Years
262 Emmet Street, Newark, N. J.

FOLLOWING SIGNALS 200 MILES

"Radio Corporation of America, New York City. Gentlemen: The following is a report of reception from the airplane radio station 2XKB by amateur station 8CEO. The signals of 2XKB were first heard here on March 17th at 5:25 P. M. The operator was using voice and announced that they were flying over the Potomac in the vicinity of Washington. He asked someone for a report on the modulation and signal strength. Signal strength here about R4 to R5; modulation slightly rough but easily understandable. At 5:34 the operator was using code and announced that they would land at Bolling Field in a few minutes. Note somewhat wavery but readable, signal strength about R6, weather cloudy. I heard him well until he was ready to land.

"March 19th. At 5:23 P. M. heard 2XKB calling NSF with voice. The signals were fine, about R7. I heard him well until he was ready to land. He spoke about the equipment he was carrying and said that they were flying over the city of Washington. He also gave some instructions regarding landing.

"March 20th. Heard 2XKB calling KDKA on code at 2:37 P. M. The signals were hard to copy on account of rapid swinging. At that time the plane was 5,000 feet up over the Allegheny Mountains according to the contents of a number of messages copied here. From that time until 3:14 P. M., when he suddenly stopped transmitting, the copy was disconnected, but enough was obtained to show that they are giving an account of their experiences, flying conditions, and other information which would be extremely valuable information from some planes under certain conditions even though the reception is not complete. At 3:56 P. M. transmission started again with the announcement that they would continue sending press.

"At 4:05 P. M. 2XKB was heard calling KDKA on voice. Signals R7 to R8, the voice better than code. At 4:25 P. M. the operator in the plane announced that they are circling Bettis Field, Pittsburgh, and concluded by saying that he was reeling up the antenna in order to make a landing.

"March 22nd, 5:45 P. M. 2 XKB heard calling WNY in code. Weather clear, signals R5. Six messages copied complete. This was the last heard from the plane at this station."

Many other amateurs showed their interest by similar letters, which give a record of points at which the plane's signals were heard.

Radio Terms Illustrated

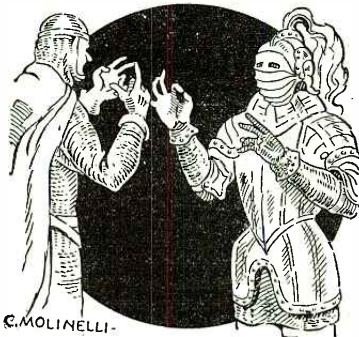

C. MOLINELLI.

"Silent (K) Nights"

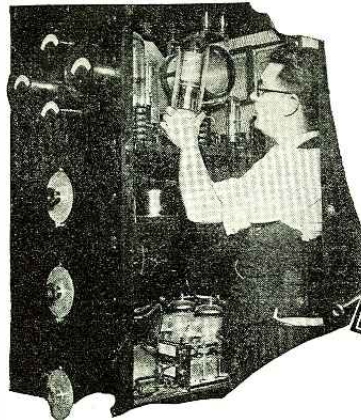

FREE RADIO BOOK~
describes many opportunities
to make big money
in the Radio field.

Here's a book that's shown man after man the way to "cash in" on the big opportunities in Radio. I'm not asking \$5 or \$6 for this book—it's FREE. If you're earning a penny less than \$50 a week clip the coupon below and get a copy of this free Radio book for yourself.

Salaries of \$50 All the Way Up to \$250 Weekly
Not Unusual

Radio—the NEW, speedy, growing, live-wire profession—needs *trained men* for its good jobs. Television, trans-Atlantic Radio telephony, many other wonderful inventions and developments are being made constantly in this field! Each one means more big-money opportunities for a *trained Radio man*. My book gives the facts about these Radio opportunities. And more—it tells how you can get all the training in Radio you need, quickly and easily in your spare hours at home, by my new and practical methods. In a short time you, too, as have hundreds of others, can be prepared to take advantage of these big-money Radio opportunities—salaries of \$50 all the way up to \$250 a week not unusual. My Free Book will give you all the Facts and Proof.

Extra Dollars for You Almost At Once

Think of making \$15, \$20, \$30 extra each week "on the side," without interfering with your regular job! I'll show you how to do that, too, by using spare time that you're wasting now. I'll show you how to turn what I'm teaching you into cash almost at once, when you and I get started together. My Free Book tells you all about it. If you send for the book today, and if you have the average man's ability, it's possible for you to be making extra money thirty days from now. And you'll be ready for a good full-time Radio position after eight to twelve months' of spare-time training.

I'll Send You this Big 64-Page Book FREE

My book is filled with photos and facts—the pay-raising facts you want to read. If you're interested in Radio, or if you're interested in making more money, you owe it to yourself to read this book. The book absolutely won't cost you a cent, and you place yourself under no obligation by sending for it. No previous Radio experience needed to take advantage of this offer. No special schooling required. Send coupon today.

Address J. E. SMITH, President
National Radio Institute, Dept. 9-SS, Washington, D. C.

J. E. SMITH, President,
National Radio Institute,
Dept. 9SS, Washington, D. C.

Dear Mr. Smith: Kindly send me your free 64-page Radio book, with all information about learning Radio for bigger pay. I understand this places me under no obligation.

Name.....
Address.....
Town..... State.....

HUNDREDS OF MEN HAVE WON SUCCESS THIS WAY

The National Radio Institute is the oldest and largest Radio home-study school in the world. It has prepared hundreds of men for the Radio profession—some of them now holding leading positions in this industry. You'll find N.R.I.-trained men in practically every Radio organization of any importance throughout the world. The same practical tested training that enabled these men to get ahead is now open to you. And this training has been improved, enlarged greatly to keep up with the constant expansion of Radio opportunities.

Executive with Big Corporation

"Am now Secretary and Treasurer of big Hammam-Lund-Roberts organization. My success here and in my former position as Editor of Radio Home due to the splendid training I got from you."



Leslie G. Biles, 1182 Broadway, New York City. Earns \$1000 by Spare Time Work

"In spare time in the evening I have made about \$1000 since starting your course. I am going right ahead with the lessons and work hard, for Radio sure is a field of unlimited opportunity."

Delores Brown, South St., Foxboro, Mass. From Miner to Over \$5000 Yearly

"Two years ago I enrolled for your training—a coal miner—by trade. Now I'm manager for the entire state of Michigan for the National Lead Battery Co., salary \$3480, bonus \$360, and commission on sales that boosts it over \$5000. Your training gets all the credit."



Win. H. Wilson, 429 S. Michigan Ave., Chicago, Ill.



J. E. Smith



Please say you saw it in RADIO NEWS.



The funniest comic in America, 'Smatter Pop' will keep you in stitches from the moment you open it until you have read and reread every page time and time again. Fifty full-page comics in this edition of 'Smatter Pop'—Hundreds of real laughs. C. M. Payne sure knows how to get under your skin and bring out every laugh in your system.

Meet "Pop," "Desperate Ambrose," and Pop's little family. They can make you laugh when everything else has failed. Ask your newsdealer or, if he can't supply you, fill in the coupon and mail to us. The funniest comic ever written. Don't miss it! Get your copy now! Barrels of FUN!



APLOGIES TO C. M. PAYNE

EXPERIMENTER PUB. CO.
230 FIFTH AVE.
NEW YORK CITY

LISSEN---'SMATTER POP IS WHAT I'M
LOOKING FOR. 'SMATTER POP I SAY! SO
DONT HOLD ME UP. DONT HOLD ME UP
MAIL, MY COPY NOW---NOW I SAY---
HERES MY QUARTER---MY TWENTY-
FIVE CENTS-----SO RUSH.

NAME.....
ADDRESS.....
CITY..... STATE.....

How Much Amplification?

(Continued from page 218)

the set, an oscillation may be set up which, although even possibly above the audible limit, may cause a subconscious feeling of distortion.

Trace down every one of those parasites which suck the very lifeblood of distant signals. Be not too anxious to add another stage of amplification, until you are sure that the amplifier you already have is working at the absolute peak of efficiency. *A little clarity is worth volumes of loudness.* Strive for quality, not quantity. Remember that a good amplifier is more greatly to be desired than rubies, or a shining panel, or even a full log-book itself; for therein lies enduring satisfaction.

A Britisher Chats on Radio

(Continued from page 211)

week. About the same time, Mr. W. W. Burnham, a clever amateur, who later was boss of Burndept, Ltd., makers of radio sets, was letting fly with gramophone records transmitted from his private station. Oh, the work I scamped at the office so that I might not be too late for Burnham's shows! I had put in a one-tube set, with reaction (I should say feed-back) ("regeneration"—ΕΠΙΤΟΡΑ) by this time, and a couple of pairs of telephones for self and wife (or visitor).

The kids still took no notice, except at bedtime, when they exhibited a wild interest in radio. But I was an experienced parent by then and was not to be caught. I had been a kid myself and had grasped at any straw to put off the evil moment of retirement to a bed completely surrounded by bears, giants, wicked uncles, hobgoblins and ogres.

A FAMILY COUNCIL

I will admit that the wife consented to wear the telephones on occasion, though I realized that they sadly interfered with my mother's grim tales of how the doctor said that there was no hope for the vicar's aunt except nourishment and *complete rest*. Moreover, it is a fact that when my wife donned the phones they undid a dollar's worth of the barber's work, and when she quitted them they pulled out numerous irreplaceable hairs. But she had plenty to spare, I argued. That was before bobbing and shingling had begun. Now that the hair ain't there to speak of—we have a loud speaker. That's just like life and luck.

Sometimes, when Burnham was putting over Shubert's "Unfinished Symphony," or Marconi's had roped in Melba, I got the phones clamped on Mrs. B., who kindly consented to drop her book, put on the "loving, patient wife" look and sit with them as a martyr's crown. Then my pride in the set, my enjoyment of the music and my lecture on the theory of radio were completely spoiled by the knowledge that (a) the lady was just obliging me—being "pally," as we say here; (b) thinking about tomorrow's dinner—"toad-in-the-hole" or stewed mutton; and (c) should she wash the drawing-room curtains and have them dyed lemon-



Radio Convenience Outlets

Know the greater convenience of a home wired for radio. Every connection to loud speaker, aerial and ground, A. C. outlet, and batteries taken care of in a neat, efficient way. Fit any standard switch box.

- No. 135—For Loud Speaker.....\$1.00
- 137—For Battery Connections. 2.50
- 136—For Aerial and Ground.... 1.00
- 138—For A. C. Outlet..... 1.00

With Bakelite Plates
Rich satin-brown Bakelite plate, with beautiful markings to harmonize, at 25 cents extra. See illustration.

At Your Dealers

YAXLEY MFG. CO.
Dept. N, 9 So. Clinton St.
Chicago, Ill.



BUILD YOUR OWN EXPONENTIAL HORN



This marvelous 17x21-in. exponential horn with a 96-in. air column can be easily built by any amateur of 1/4-in. soft wood, which produces the most wonderful tone quality. We furnish you with a set of **FULL-SIZED PATTERNS**, which have been accurately and scientifically worked out according to the exponential principle. Simply saw out the wood to the size and shape of the patterns and nail and glue together and you have the latest and

MOST EFFICIENT TONE PRODUCER
Send \$2.00 for a set of these full-sized patterns and complete instructions, or we can furnish you the **COMPLETE KIT**, which includes the wood cut to fit, the nails, the glue, our large-sized **CONCERT UNIT**, and full instructions. All complete with postage prepaid for \$11.75 in the United States and \$12.75 in Canada.
RADIO PRODUCER COMPANY
1245 Jefferson Bldg. Peoria, Ill.

yellow or stick me for seven and a half dollars and get new ones?

Inevitably, in the middle of the show my kid daughter would pipe from her cot, "Mama! ma-MA!" And when mamma said, "What is it, doodlums?" the reply would be, "Ze bikkit has made nasty crumbses all over ze bed an I'se so hot and can I have a dink of wa-er?"

"The precious lamb." "The naughty biscuit." "Of course she can have water—gallons of it, if she likes," etc. Meanwhile, Melba's golden notes were clean wasted. You can't enjoy Melba alone. It's like secret drinking!

THE LOUD SPEAKER

In December, 1922, the British Broadcasting Company began its operations and regular daily programs were radiated from ZLO. Corn in Egypt! Loud, hefty signals on the merest bit of galena! But I added one stage of audio-frequency amplification and bought a loud speaker. "That," I muttered, as I paid the money, "will fetch the family!" I was in grievous error. I must tell you about my first loud speaker.

It had bronchial trouble and hereditary epilepsy when they sold it to me, besides not having got over the distemper. It was of a diminutive breed, three hands high, bowed in the leg and docked in the tail. The horn part was made of a material which looked like black cardboard sprinkled over with coarse gunpowder, and when tapped sounded like a cracked dinner-plate. The working part apparently contained the essentials, but evidently housed in addition a collection of small loose pieces of metal and glass. Moreover, I believe it gave hospitality to a buck Mexican jumping-bean.

When the set was dead this strange pet used to stand around in a sullen sort of way, breathing hoarsely with its mouth open; but when the juice was turned on it cracked something like a bonfire when it has just begun to catch hold properly. The superimposition of a throaty tenor broadcasting "Songs of Araby," upon that basis, resulted in a sound which I may fairly describe as the combination of a flute solo and the asthma ward of a hospital.

This particular animal refused to recognize human speech. One evening it gave us a fifteen minutes' imitation of a bullfrog trying to shout down a buzz-saw, and the next morning we found that we had been hearing an appeal by the Lord Mayor of London for donations to Guy's Hospital.

The louder and brisker the music the more our "dumb friend" became excited. When a really virile military band was put over, the little blighter hopped about the table like a sparrow on a string; and I remember that one Christmas Sunday, during a performance of the "Hallelujah Chorus," it took a flying leap and landed on Grandma's lap, provoking the old lady to utter tremendous criticism of "these new-fangled contraptions."

Nobody loved him, except me, and whenever I suggested giving him a little try-out the domestic temperature raced to zero as fast as a rat moves in front of a bull-pup. And then some.

After that phase I reverted to telephones, and in my solitary despair spent many months in wild adventures with "quack" circuits. I was no better than a childless widower. Meals came and went. Children had mumps and parties and toothache and prizes for Scripture Knowledge; while I,

LONGER LIFE



CECO

MEMBER
RMA

PRONOUNCED
SEE - CO

Radio Tubes

WHEN you install a set of CeCo Tubes in your radio, you immediately notice a greater clarity in reproduction—a marked increase in sensitivity, so noticeable on distance reception and better volume. But your greatest satisfaction will be in the longer life they give, making them truly the most economical tubes to buy.

These outstanding features are characteristic of all CeCo Tubes, both in the A. C. and battery types, and are partially due to the CeCo exclusive method of evacuation.

With the tubes (the heart of your radio) there is no substitute for quality—it pays to buy proven performance, as demonstrated by CeCo Radio Tubes.

Write for a copy of our booklet, "Getting the Most Out of Your Radio." CeCo Tubes are for sale by the best dealers everywhere.

CeCo MANUFACTURING CO., INC.
PROVIDENCE, R. I.

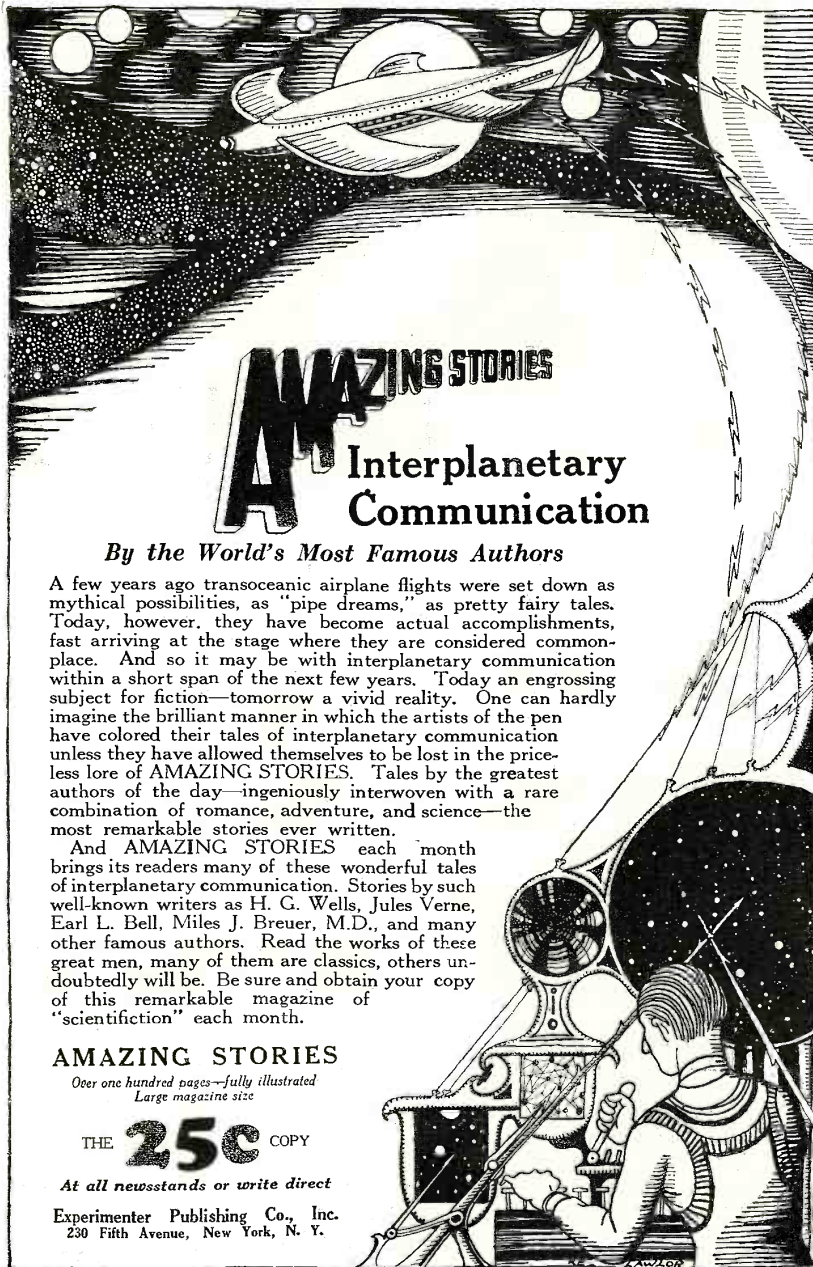

AMAZING STORIES

Interplanetary Communication

By the World's Most Famous Authors

A few years ago transoceanic airplane flights were set down as mythical possibilities, as "pipe dreams," as pretty fairy tales. Today, however, they have become actual accomplishments, fast arriving at the stage where they are considered commonplace. And so it may be with interplanetary communication within a short span of the next few years. Today an engrossing subject for fiction—tomorrow a vivid reality. One can hardly imagine the brilliant manner in which the artists of the pen have colored their tales of interplanetary communication unless they have allowed themselves to be lost in the priceless lore of AMAZING STORIES. Tales by the greatest authors of the day—ingeniously interwoven with a rare combination of romance, adventure, and science—the most remarkable stories ever written.

And AMAZING STORIES each month brings its readers many of these wonderful tales of interplanetary communication. Stories by such well-known writers as H. G. Wells, Jules Verne, Earl L. Bell, Miles J. Breuer, M.D., and many other famous authors. Read the works of these great men, many of them are classics, others undoubtedly will be. Be sure and obtain your copy of this remarkable magazine of "scientifiction" each month.

AMAZING STORIES
Over one hundred pages—fully illustrated
Large magazine size

THE **25c** COPY

At all newsstands or write direct

Experimenter Publishing Co., Inc.
230 Fifth Avenue, New York, N. Y.

the scape-goat, the pariah, the prodigal parent, "footled" about with my absurd gadgets. The scorn of a six-year-old for the senilities of its male parent makes the serpent's tooth look as blunt as Table Mountain, believe me!

Presently I began to realize that I was an outcast and that even the triumph of receiving 40 stations, on a circuit designed in defiance of all the orthodox principles, was not worth the approbation of those strange apparitions, wife and children. Where were the jokes and smiles of yester-year? Where the genuine wifely smile at the boyish pranks of the husband who would never grow up? Gone! Vanished like a volt when the fuse has blown!

THE TAMED LION

Solemnly I sold the junk! Soberly I purchased—at trade terms, as befits the prudent householder—an honest-to-goodness, household, guaranteed, two-control, perfectly uninteresting walnut-cased, horror of a genuine "home-joy" radio-receiver, coupled to a loud speaker patented in every country in the world, and the U. S. A. Sadly, yet hopefully, I hooked it up. I provided an easy, simple method of charging the "A"—or perhaps it is the "B"—battery and a perfectly harmless means of providing for the needs of the anode (*plate—Error*) from the house electric-lighting mains. All very religious, unexciting, orthodox, safe, easy, simple and guaranteed.

The result was a miracle. The family sat up sharply and took notice. The new loud speaker, a pleated cone, aroused their curiosity. How could a piece of parchment do it? Clever daddy! Daddy thawed slightly and explained. They did not understand the explanation, but they understood there was a great advance! Near bedtime there were vociferous demands for the wireless. Mrs. B. said she didn't mind hearing the "wireless," if there was anything decent ("decent" means "good") on. So on it went, and the kids heard it through the ceiling till Morpheus took them, unawares.

Even that set went, in favor of "the latest model." And now, when I want to pass the lawn-mower over the lawn—my only exercise—the cry is, "Oh, daddy, isn't there anything nice on the 'wireless'?"

And so I have to give up field-sports, wipe my boots carefully and turn on the latest thing in orchestras. It's music they want. Radio *qua* (*as—Error*) radio has been abolished in my home.

That's my history. Any parallels, in the U. S. A.?

RADIO SCHOOL
Term Sept. 10. Catalogue Free
MASSACHUSETTS RADIO and TELEGRAPH SCHOOL
18 Boylston St. Boston, Mass.

HOOK-UP BOOK FREE
Improve your reception with **CARBORUNDUM** Stabilizing Detector Units, Grid Leaks and Resistors
THE CARBORUNDUM COMPANY
DEPT. D-1, NIAGARA FALLS, N. Y.

RADIO TERM ILLUSTRATED



"Body Capacity"

FREE RADIO GUIDE
BIG NEW FALL CATALOG—4000 items Shows the latest A-C circuits, the newest ideas in radio at startling low prices. Get the sets and parts you want here. Save money. The best in parts, kits, complete factory-built sets and supplies. Orders filled same day received. Write for free copy now.
Standard discounts to dealers, set builders, agents
BARAWIK CO., Dept. 809A CHICAGO, U. S. A.

AEROVOX Makers of high quality resistors and condensers that are Built Better — to endure.
Write for The Research Worker. A free monthly publication.
AEROVOX WIRELESS CORPORATION
68 Washington Street, Brooklyn, N. Y.

Please say you saw it in RADIO NEWS.

The Uses of Meters

(Continued from page 227)

receiver is known, it is an easy matter to service a storage battery or dry battery supplying currents to the filaments. Supposing a set is found to draw two amperes; the set is used on an average for three hours a day and a storage battery with a serviceable current-capacity of 80 ampere hours is used. The current rate is then multiplied by the number of hours of use and the product is divided into the ampere-hour rate of the battery. In this particular case, the battery will last a little over 13 days before it is necessary to recharge it. It is desirable to know that the battery is actually delivering its proper voltage during this period; regardless of its nominal rating, it should be recharged before any serious drop is shown. In figuring the life of dry cells; the large ones used for lighting the filaments of vacuum tubes of the 199 type have a life of about 30 ampere hours.

ALTERNATING-CURRENT METERS

Besides these common types of meters used for radio receivers, there are a number of other indicating devices used for test purposes. One of these meters which is being used at present to an increasing extent is the A.C. voltmeter. For practical measurements of alternating currents and voltages, iron-vane systems are used almost exclusively. The principle of this type of meter (both for current and voltage) is that of the *repulsion* of two similarly magnetized pieces of iron, one of which is fixed and the other arranged to rotate. These iron vanes are magnetized by a coil which surrounds them, containing heavy wire in the case of an ammeter, and fine wire for a voltmeter.

Since alternating-current tubes are gaining such favor, it is found that an alternating-current voltmeter with a low range is essential for correct operation of sets employing these tubes. The use of a series resistor in the filament circuit of each tube and a suitable A.C. voltmeter for measuring the voltage supplied to each of these tubes will enable the fan to operate them correctly and obtain much longer service and greater satisfaction.

There are also a number of meters designed for measuring currents of very high frequencies. Most ammeters and milliammeters used for low-frequency (60-cycle) alternating-current work are entirely unsuitable at higher audio and radio frequencies. This is due to the fact that the circuit within the high-frequency meter must have a very low capacity and inductance; otherwise, part of the current may flow through or be lost in heating the *dielectric* (the amount depending upon the frequency of the current) and the meter will not be correctly calibrated for all frequencies.

There are two types of meters employed for these high-frequency currents; the most common is the hot-wire meter, consisting of a piece of resistance wire which increases its length when heated. (Fig. 3.) This wire is attached to the indicating needle, which is moved around as the heat increases and the wire bends. The difficulty with this type of meter is that it is affected by changes in the room temperature and the wire has a tendency to stretch when no current is passing through it.

Your Present Radio

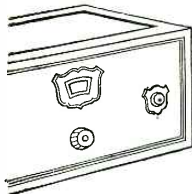

... can be made an Electric A.C. Set *without changes in wiring or even the cost of new tubes*

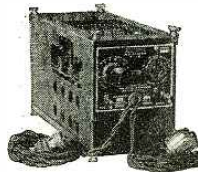

Kuprox A.C. Power Pack. Makes any battery set an electric A.C. receiver. \$32.50 up.

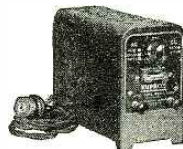

Kuprox Multi-rate Rectifier, for trickle charging, dynamic speaker operation, etc. \$11.50



Kuprox Replacement Unit eliminates acids, liquids, bulbs from trickle chargers \$5.00

THERE'S no necessity for discarding a good battery operated receiver to get the convenience of A.C. operation. The Kuprox A.C. Power Pack converts any good set into an electric A.C. set, without changes of any kind in wiring, without the use of harnesses or adapters.

Kuprox equipped, your present set, using your present tubes will give you super-fine A.C. operation. Everything your radio did before, it will do even better. And there's nothing to bother about... the entire set turns on and off at your light socket. The Kuprox A.C. Power Pack is a permanent addition to your set that will double your radio enjoyment.

Several models are offered. One that supplies all radio power for any size set. Or separate filament and plate models for those who desire this form. And an efficient "A" model that supplies filament current and will operate in conjunction with any good "B" eliminator. Priced from \$32.50 up. See the various models at your radio dealer's. Or, if you first desire more information, we'll be glad to send it if you will write.

THE KODEL ELECTRIC & MFG. CO.
Formerly The Kodel Radio Corp.

501 E. Pearl St. Cincinnati, Ohio

KUPROX A.C. POWER PACK

Please say you saw it in RADIO NEWS.

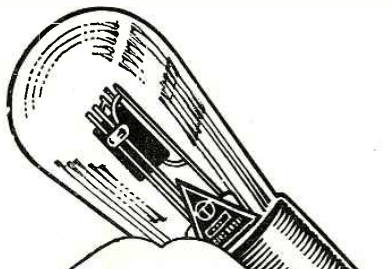

Thousands use Televocal Quality Tubes . . . there must be a difference! All standard types. Ask for them at your dealers.

Televocal Corporation
Televocal Building
Dept. A-2
588 12th Street
West New York, N. J.

Televocal
Quality Tubes



Your Tubes
STEADY AS THE STARS
When **AMPERITE**-Controlled

Don't let "A" battery current fluctuations spoil your radio reception or ruin your tubes. Install Amperites and automatically keep the filament temperature constant according to tube rating. Entirely unlike fixed resistors. With AMPERITE control tubes last longer and your set sounds better. Panel arrangement improved and wiring simplified. Tuning is easier and volume is increased. A type for every tube—battery or A. C.

\$1.10, with mounting (in U. S. A.), at all dealers. **Radiall Company**, 50 FRANKLIN ST., NEW YORK



FREE "Amperite Blue Book" of latest circuits and construction data. Write Dept. R. N-5.

AMPERITE
The "SELF-ADJUSTING" Rheostat

BIG DISCOUNTS
TO SET BUILDERS

Big New Fall Catalog—4000 Bargains—Latest A-C circuits, newest ideas in radio, at startling low prices. The sets and parts you want. Save money. Best parts, kits, complete factory-built sets, supplies. Orders filled same day. Write for free copy. Standard discount to dealers, set builders, agents.
Barawik Co., Dept. 809E Chicago, U.S.A.

Quality Apparatus
Our latest bulletin No. 929 describing our complete line of quality apparatus is yours for the asking. Write for it today.
GENERAL RADIO CO.
30 State St., Cambridge, Mass.

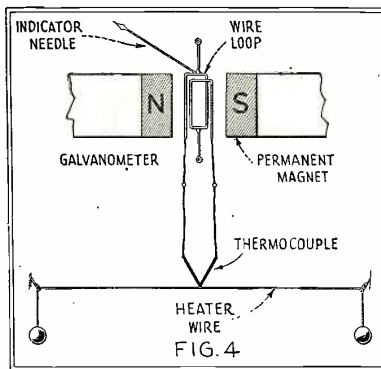

The thermocouple is composed of two different metals, which generate current with a slight degree of heat. This current is registered by the ultra-sensitive galvanometer, the loop of which twists in its permanent field.

The other type of meter used for high-frequency currents is the thermocouple type; this consists of two dissimilar metals welded together and attached to a heater wire through which the alternating current passes, as shown in Fig. 4. A small current is produced by this thermocouple and applied to a standard galvanometer movement with the correct calibration. Of course, the greater the heating effect of the wire, the greater the current produced at the thermocouple and the greater the deflection of the indicator resulting. This generation of current in a thermocouple is a well-known phenomenon and the explanation of its operation will be found in any good treatise on physics.

Ameters of this type are used principally to measure the radio-frequency current produced by radio transmitters. They have very little use in radio receivers; although they are used in some cases to indicate the radio-frequency current produced by the oscillator in a superheterodyne.

40 Non-Technical
Radio Articles

every month for the beginner, the layman and those who like radio from the non-technical side.

SCIENCE AND INVENTION, which can be bought at any newsstand, contains the largest and most interesting section of radio articles of any non-radio magazine in existence.

Plenty of "How to Make It" radio articles and plenty of simplified hook-ups for the layman and experimenter. The radio section of SCIENCE AND INVENTION is so good that many RADIO NEWS readers buy it solely for this feature.

Radio Articles Appearing
in September Science and
Invention Magazine

- RADIO VIA TELEPHONE LINES
- DIRECTION FINDING FOR PLANES
- RADIO SAFETY CODE
- NEW RADIO DEVICES
- RADIO ORACLE
- LATEST PATENTS
- REBROADCASTING A RADIO "ECHO"

CARE SHOULD BE
TAKEN
IN CHOOSING
LOUD SPEAKER

Acoustic Engineers Recommend
Use of Book by Well-known
Authority for Instruction

"The necessity for care in choosing a loud speaker cannot be over-estimated," say acoustic engineers. A radio is but the vehicle used to bring in broadcast entertainment, the true reproduction of sound depends almost entirely on the speaker. It follows, if the loud speaker does not meet the requirements of the receiver, reception will not be at maximum. Consequently the entertainment of the listener-in is often unwittingly spoiled by failure to recognize the importance of a good speaker in getting maximum results from his set.

Education of the public in speaker construction and design is necessary according to these experts. They recommend "HOW TO BUILD MODERN LOUD SPEAKERS," written by Clyde J. Fitch, as being the most efficient source from which this information may be obtained. The book is written in a style that is not only tremendously interesting but also decidedly easy to read. "HOW TO BUILD MODERN LOUD SPEAKERS" is the most complete treatise of its kind available. It thoroughly explains every known type of speaker and gives full instructions for building. It is well to remember that if the proper speaker is not used the enthusiast leaves himself open to all manner of distorted reception. Crackling noises, fryings, whistles and squeals—these disturbances, often laid to the set, can in reality usually be traced to the speaker. Also the fact that a speaker works well with one set and not with another is no reason to lay faulty reception to the set. "So," the experts point out, "you must understand the speaker if you are to receive the maximum results from your receiver." "HOW TO BUILD MODERN LOUD SPEAKERS," by Clyde J. Fitch, is not only the best source from which to obtain this essential information, but also probably the cheapest. Complete, dependable data on every speaker known in radio—full instructions for building. All this for only twenty-five cents, the price per copy of "HOW TO BUILD MODERN LOUD SPEAKERS," by Clyde J. Fitch. Mail this coupon to Consrad Company, Inc. 230 Fifth Avenue, New York, N. Y.

CONSRAD COMPANY, INC.,
230 Fifth Avenue, New York, N. Y.

Gentlemen:
Enclosed find twenty-five cents, with which please send me a copy of "How to Build Modern Loud Speakers," by Clyde J. Fitch.

Name.....
Address.....
City.....State.....

Please say you saw it in RADIO NEWS.

Another meter which is used extensively in radio transmission is the wavemeter. This meter, however, is not usually considered in the same sense as the common indicating meters, but is more like a yardstick in its use. It usually consists of a tuned circuit of coil and condenser which is calibrated in wavelengths or frequencies. A number of other special meters have been developed, including grid-leak testers, power-factor meters, watt-hour meters, etc. These meters, however, are not of interest to the average radio fan, as they have no use in radio receiving circuits.

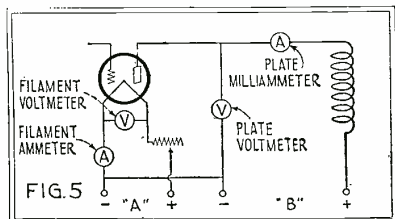

The positions of voltmeters and milliammeters in a receiving circuit. Filament voltmeters usually have a 0-to-6-volt scale; plate voltmeters must be suitable for the largest "B" voltage employed.

Novel Indoor Aerial

(Continued from page 207)

neutrodyne, and with both tuned and untuned aerial circuits. The coils gave equally good results with sets of all these types; they increased the volume of broadcasts and reduced interference.

Then he began to wonder how these coils, used inside the house and at half the height of the outside aerial, produced the results that he had observed. He tried other connections; when the dead ends of the two coils were connected to each other, the signals dropped in volume. When the ground wire was connected with the dead end of the inside coil, the signals stopped altogether. The outside coil could be grounded at either end without any appreciable change in the signals, provided the inside coil was connected with the set at the *opposite end*; if the upper end of the outside coil was grounded, the lower end of the inside coil had to be connected with the set, and *vice versa*.

PATENT RESEARCH

A careful examination of similar patents by radio men showed that none of them was based on exactly the same principles. Patent No. 1,649,729 employed coils but did not embody the principle of grounding one

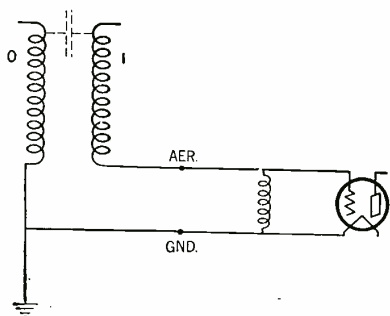

A schematic diagram of the Loveless antenna.

REL REL REL REL REL REL REL REL REL

SCAN THE ETHER WITH The New "222"

★ STROBODYNE

Combining the proven, hyper-sensitive STROBODYNE system with the tremendous amplification obtained through the use of the new shield grid tubes, in a special circuit making full use of their extra high amplification factor.

The "222" STROBODYNE
Latest Design by
R. E. LACAULT, E.E.

leaves far behind all other types of sets. Its performance has amazed experienced engineers and it has come through hard tests with flying colors.

SPECIFICATIONS

- 1—QUALITY OF REPRODUCTION
Through the use of high grade audio transformers combined with a push-pull amplifier and the best method of detection, the most remarkable fidelity is obtained. The results will amaze the most critical musicians.
- 2—VOLUME
The tremendous amplification of the shield grid tubes produce unusual volume which may, however, be regulated to any desired value through a special control.
- 3—SELECTIVITY
The very high impedance of the shield grid tube, combined with the special circuit used, makes the tuning very sharp without affecting the quality.
- 4—SENSITIVENESS
The sensitiveness of this receiver is so much greater than that of any existing set that it is beyond comparison. There is **NO LIMIT** to the range. The noise level is the only factor affecting it.
- 5—SHIELDING
Entire R.F. system completely shielded.
- 6—EASE OF CONTROL
Only two dials, a volume control and sensitiveness control are used—making the set easy to operate.
- 7—STROBODYNE SYSTEM
The STROBODYNE method of reception—a time-tested and proven circuit—is incorporated in the set, causing very weak signals to produce a tremendous response.
- 8—MATERIAL
Only the very best of tested parts are used in the entire set, insuring permanent high efficiency.
- 9—DESIGN
The new "222" STROBODYNE is designed by R. E. Lacault, E.E., well known creator of several famous circuits, whose reputation is a guarantee of the high grade radio engineering incorporated in this set.

BE THE FIRST TO BUILD IT!

We are equipped to give you

PROMPT MAIL ORDER SERVICE

All genuine parts carried in stock

ORDER DIRECT from

R. E. LACAULT

116 West 65th Street, Dept. 405, New York City

Cable Address
LACRAD NEW YORK

Long Distance Phone
SUSQUEHANNA 2095



New!

EDITION

TELEVISION

A Magazine for the Experimenting Fan

"TELEVISION" is a magazine pledged to further the art of the infant industry for which it is named, and to supply the "fans" with the latest information and developments in this fast-growing field. Television, as a science, occupies the same position today as radio did ten years ago. Like the radio fans of years back, enthusiasts of this new field have had to fight for whatever meager knowledge they have been able to obtain. This magazine, then, comes as manna to the information-hungry fan. It is our purpose to keep these enthusiasts constantly informed, through "TELEVISION," of each new development. The second issue of "TELEVISION" is now on the newsstands. You will find below a partial list of its interesting contents



In the Television field there are all of the thrills that the radio fan knows so well. Get on the band wagon with your fellow enthusiasts. Be the first in your neighborhood to own a television set. Obtain a copy of "TELEVISION"; it will show you how to build a real Television receiver.

list of its interesting contents

The first Television magazine was published by the EXPERIMENTER PUBLISHING COMPANY about a year ago. Over 50,000 copies of this magazine, "TELEVISION," have since been sold. This, alone, is sure proof of the popularity of this interesting new art.

Partial List of Contents

New Jenkins Radio Movies
New Belin Photo Transmitter
Vacuum Cameras to Speed Up Television
Infra-Red "Eye" Sees at Night
Valensi Television
Connection of Photo-Electric Cell

Practical Demonstrations Scheduled for Station WRNY
Campbell Swinton Television System
Quartz Crystals Synchronize Television Sets
Baird Optical Lever Increases Speed
Recording Pictures with Air Jet
How to Build a Radio Photo Recorder

and many other articles of equal interest

AT ALL NEWSSTANDS

THE **25c** COPY

OR WRITE DIRECT

EXPERIMENTER PUBLISHING CO., INC., 230 Fifth Ave., New York, N. Y.

EXPERIMENTER PUBLISHING COMPANY, INC.
230 Fifth Avenue, New York City, N. Y.

Gentlemen: Please forward to me a copy of TELEVISION. Enclosed find 25 cents.

Name.....

Address..... City..... State.....

coil. Patent No. 1,530,684 employed only one coil instead of two. Patent No. 1,567,542 employed a loop, a coil enclosed on itself. Patent No. 1,379,262 consists of a variable inductance and capacity together with a multiplicity of aerial systems. The Loveless device consists of the fixed inductance and fixed capacity of two coils which are not conductively connected together.

Loveless claims for his device: first, a greater signal strength delivered to the receiver; second, greater freedom from outside interference; third, the ability to obtain greater selectivity between signals having nearly the same wavelength; fourth, ease of installation and the fact that it can be installed either indoors or outdoors.

He states that reversing the winding of one coil with respect to the other prevents signals from being received, and believes that this proves that waves are received from both the air and the ground. The two waves neutralize each other when the wire of one coil is wound in a direction opposite to that of the wire in the other.

HOW DOES IT WORK?

Mr. Loveless' tests prove that his new type of aerial works better than a 100-foot single-wire aerial 45 feet above the earth. Those who have seen it are wondering how it produces the results that are obtained.

Obviously, there is a greater length of wire and much more wire surface in the coils than in the 100-foot aerial. The coils have an average diameter of 12 1/8 inches; the circumference of each turn, therefore, is 38 inches, on the average, and the total length of wire in the eighty turns is nearly 254 feet, which is two and one-half times the length of the outdoor aerial.

Coils pick up much energy from radio waves. During the World War a young operator assigned to a station at Belmar, New Jersey, told how he had seen a professor in a western college bring in European high-power stations by connecting a single-tube receiver to a spool of wire that happened to be lying on his desk. The older operators thought the young fellow was stretching the truth. He suggested that they try it and they found that they could bring in the European stations themselves by the same method.

There are devices on the market that frequently increase the volume of sound delivered by a receiver, by tuning the antenna. A set connected with such a piece of apparatus has been known to bring in signals after the antenna switch was opened; so some of the energy in the antenna must have jumped the gap in the switch or else the coil alone picked up enough energy to show results in the receiver. Various types of "interference eliminators" are antenna tuning devices.

One difference between the Loveless antenna and such devices is that it does not need to be used in connection with any other antenna. The results may not be as good when it is connected with an outside aerial. It differs from the loop, or coil, antenna too, for each of its coils has a free end. The outside coil is connected only with the ground and set and only at one end. The inside coil is connected only with the set and only at one end.

Such a compact antenna has many possible uses. It might take the place of the trailing-wire antenna on airplanes, which sometimes has been a source of danger

because of its whipping about and the chance of its catching on other objects. It might prove satisfactory on police cars such as those used by Scotland Yard, the London police headquarters, and on other radio-equipped automobiles.

The tests indicate that it brings in more energy than loop, or coil, antennas that have both ends attached to the receivers; so it may be used wherever long and high aerials are not wanted, but ground connections are possible.

A study of its possible directional effects may reveal that it will be effective when used with a direction finder or radio compass.

It can be built into a radio cabinet. Smaller coils may be used where space was limited. Coils small enough to be enclosed in cabinets of the ordinary sizes might give satisfactory volume and eliminate much interference when employed with receivers used in cities where listeners depend mainly on local broadcast stations for programs.

Mr. Loveless is continuing his experiments with the new aerial, and hopes to make it available to radio users. Radio amateurs probably will give their brother "ham" much assistance by experimenting with home-made Loveless antennas in many locations.

Fixing "Sticky" Radio Tubes

THE solder on the ends of the contact pins of some radio tubes is slightly lumped, and prevents the tubes from sliding easily in and out of their sockets. To remedy this trouble, simply pare off the lumps with a sharp knife, or file the pins smooth with a fine file.

IT SOUNDED LIKE DX

DOCTOR: "Have you ever had Coryza*?"
 RADIO HAM: "No, but I've worked Australia lots of times."
 —N. H. Webster.

* Coryza, a common cold in the head.—Dictionary.

AFTER THE STORM

In Our September Issue:

Unlocking the Past, by David H. Keller, M.D. Just how much the sub-conscious is capable of retaining and how far back its retention begins has been a point of conjecture and experiment for a good many years—at least since the beginning of psychiatry. Dr. Keller, in his individual style, treats this subject in a distinctly absorbing manner.

The Ambassador from Mars, by Harl Vincent. If some means of interplanetary travel could be devised, what would be the method of communication between, say, Mars and the Earth? Obviously, the spoken word will not be possible; because we have no basis of contact. The author suggests a very logical plan.

The Skylark of Space (a Serial in Three Parts), Part II. This instalment not only retains its high degree of interest, but becomes increasingly fascinating with each chapter, and explains many things.

The Invisible Bubble, by Kirk Meadowcroft. If you know even a little about the ultimate stage of matter, this story will seem quite plausible to you. At any rate, it contains a good bit of science and an ingenious idea, beautifully worked out.

And Others.

NORDEN-HAUCK

NEW 8 TUBE

AC ELECTRIC MODEL



ELECTROPHONIC

FOR
1929

Size 8x11x22
Weight 35 lbs.
Wave length range 200 to 550 meters.

The Norden-Hauck Electrophonic is an entirely new and superior broadcast Receiver operating directly from house current. It is well built, handsomely finished and compact. Truly it represents the highest type of efficiency obtainable in point of range, selectivity and simplicity combined with utmost quality of reproduction.

10 OUTSTANDING FEATURES

ELECTRIC. The Electrophonic is all electric operated and self-contained. No Eliminators or batteries whatever. Employs standard Radiotron or Cunningham alternating current tubes.

CIRCUIT. The Electrophonic employs an 8-tube circuit; three stages direct tuned radio frequency amplification fully neutralized, detector, and three-tube power audio amplifier push-pull type.

SHIELDING. The Electrophonic is totally shielded. Complete inter-stage shielding permits high amplification not obtainable otherwise.

SIMPLICITY. The Electrophonic has but one control for wavelengths, one control for volume. Illuminated drum dial calibrated in degrees and in kilocycles.

SENSITIVITY. The Electrophonic has carefully balanced radio frequency tuning circuits which with superior quality of materials and workmanship combine to make the Norden-Hauck Electrophonic a long distance Receiver.

SELECTIVITY. In the Electrophonic total shielding and carefully balanced circuits and quality permit unusual selectivity so necessary in congested districts.

QUALITY. The Electrophonic is of the highest quality of construction and design throughout. Comparable only with costly custom built Receivers.

FINISH. The Electrophonic has an exquisite solid mahogany cabinet, brown finish. Heavy cast bronze escutcheon plate and tuning knobs lend to the rich appearance of the Receiver which will fit in any surroundings. Cabinet high French polish and full piano hinge. Back removable and ventilated.

GUARANTEE. The Electrophonic material and workmanship are fully warranted against any defects whatsoever.

PRICE. The Norden-Hauck Electrophonic Receiver is moderately priced at \$125.00. Packed for shipment.

\$125⁰⁰

List Price f.o.b. Phila.

COMPLETE illustrated literature gratis. Write, telegraph or cable today.

NORDEN-HAUCK, INC., ENGINEERS

MARINE BUILDING, PHILADELPHIA, PA.
 Builders of the Highest Class Radio Apparatus in the World.

Pathfinder

TRIAL
EVERY WEEK 13 WEEKS
\$1 A YEAR 15 CENTS

Your neighbors know the Pathfinder and you will like it—the every-week news digest from the Nation's Center. Bright, interesting, dependable, different—nothing else like it. Washington gossip, politics, science, travel, fun, lots of pictures, instruction, entertainment. Trial 13 weeks—13 big issues—only 15 Cents—or \$1 for full year. Send now. Address: Pathfinder, Dept. 17, Washington, D. C.

DEALERS AND SET BUILDERS

Complete descriptive literature of the entire NEW TYRMAN line is now ready. Many new features described. Write for it today, using your letterhead.

TYRMAN ELECTRIC CORP.
 Dept. 103, 314 W. Superior St., Chicago, Ill.

WRITE for NEW 1929 CATALOG!

[DEALERS—SET BUILDERS]

Our new 1929 Catalog is ready. Save money on newest hook-ups, sets, kits, parts. Accessories at lowest prices.

The Big Friendly Radio House
WESTERN RADIO MANUFACTURING CO.
 126 West Lake St., Dept. 19, Chicago, Illinois



Getting the Most Out of Your Radio? No matter if your set is home-made, custom or factory built, there are dozens of little items that make the difference between average results and wonderful results. Invest 25c in "The Gateway to Better Radio" and know you enjoy the best. Your dealer has your copy or direct from

CLAROSTAT MFG. CO., INC.
 Specialists in Variable Resistors
 285-7 N. Sixth St., Brooklyn, N. Y.

8 POPULAR MODERN MOVIE NOVELS \$1.00

GREATEST OFFER EVER MADE

Take Advantage of This Amazing Bargain

Eight full size books for one dollar. Never before has an offer of this kind been made. Only quantity production permits us to make this astounding offer now. Take advantage of it while you have the opportunity. Needless to say these modern up-to-date movie hits cannot last long at this tremendous bargain price. Each book contains at least two color "stills" of an actual scene from the photoplay. Don't hesitate. Mail this coupon now. Every story based on an actual moving picture triumph. The greatest book bargain of the age.

Titles of This Tremendous Bargain Offer

1. New York
2. The Campus Flirt
3. Almost a Lady
10. Sensation Seekers
11. The Rambling Rangers
12. Don't Tell the Wife
14. Tracked by the Police
15. Tell It to the Marines
19. Irresistible Lovers
20. The Cohens and Kellys In Paris
21. The Divine Woman
22. Jazz Mad
23. The Crimson City
24. You Can't Beat the Law
25. Tillie's Punctured Romance
26. Forbidden Hours

8 BOOKS FOR \$1.00
Your Choice

An Addition To Your Library

These books will be a worthwhile addition to your library. You will find many hours of truly enjoyable reading in each beautiful volume. Printed on fine paper with large clear type. Beautiful colored covers of flexible durable material. These books are undoubtedly one of the greatest values ever offered at this amazingly low price.

Write Now! Don't Wait! This bargain cannot last long at this price

CONSRAD COMPANY, INC.

230 FIFTH AVENUE

NEW YORK, N. Y.

CONSRAD COMPANY, INC., 230 Fifth Avenue, New York, N. Y.

Gentlemen: Enclosed find \$1.00. Kindly send me the books listed by number herewith:

Numbers.....

Name.....

Address.....

City..... State.....

A REAL SPECIAL OFFER!



UNI-RECTRON POWER AMPLIFIER

(Ideal for use with Dynamic Speakers)

Model AP-935

As the Uni-Rectron stands it is a super power amplifier, which can be used in connection with any radio set and loud speaker. Binding posts are provided for input to the Uni-Rectron and output to the speaker.

Requires no batteries for its operation. It obtains its power from the 110 volt, 60 cycle alternating current lighting circuit of your house.



List Price \$88.50

(Without tubes)

Special \$19.75 ea.

Every one new and packed in original factory carton

AMERICAN SALES CO., 19-21 WARREN ST., NEW YORK CITY
SEND FOR OUR LIST OF RADIO BARGAINS

The UX-210 super power amplifying tube and the UX-216B or 281 rectifying tube are used with this amplifier, which cannot overload.

From the faintest whisper to the loudest crash of sound—R. C. A. Uni-Rectron amplifies each note at its true value. High and low notes are all treated alike. The volume and quantity delivered will be a revelation.

The Scanning Disc

(Continued from page 223)

fore the television transmitter for the period necessary to transmit it.

PROBLEMS OF THE APPARATUS

So far as we have dwelt on the simple theory of the television apparatus; but there are many practical problems which make its operation more difficult, or the theory would have been put into practice many years ago.

If we should adjust the scanning disc at the transmitter to the object glass of a telescope, with proper precautions, we could transmit very readily an image of the disc of the sun, with a large sunspot or two, if they were in sight. With a very large telescope, we could send pictures of a region of the night sky, with its stars. But scenes on the earth are not lit as brightly as the sun or stars, and it is exceedingly difficult to get enough reflected light from a spot a quarter of an inch in diameter, through a hole 1/48 of an inch in diameter, to produce the slightest effect on a photoelectric cell.

It is true that we are not limited to a small disc at the transmitter; we can use a larger one than is possible for reception, if it is magnified *exactly in proportion*. But the amount of energy sent out from the photoelectric cell is exactly proportioned to the amount of light falling on it; and is very small at the best.

Enormously-powerful lights have been turned on the objects to be televised; but if they are human beings, there is a limit to the amount of light and heat they can endure, and they are poor reflectors at best. Another solution of the difficulty, which is meeting with much favor, is that of using the scanning disc to pass a beam of very intense light, which travels over the object televised. It dwells on a single spot only 1/35,000 of a second at a time, so that it can be borne by a human subject; and its reflection can be received by several very large photoelectric cells at once. The problems, however, which would arise if this method were to be used on objects at varying distances from the photoelectric cell are many; because of the various angles of reflection of the light. It is probable that the apparatus which will be necessary to take outdoor and moving scenes will be electrically, if not mechanically, far more complicated than that at the receiver.

DESIGNING THE DISCS

We are also faced with the problem of the size of the holes in our scanning mechanism. The smaller they are, the finer the picture which we will produce, and the better its detail—IF they will pass the needed amount of light to register on the photoelectric cell. But, as we increase the number of these holes, we increase the number of impulses per second which our apparatus must register, we increase the speed which is required of our photoelectric cell—and we increase the width of our radio channel. A 200-kilocycle channel has been authorized for television; this gives us 13,333 modulating vibrations for each television image, or about the number of distinct impulses that are required for dots in one square inch of a halftone in RADIO NEWS.

It would also require, for an image one inch square, 116 holes in a scanning disc 37 inches in diameter at the receiving end; and

this revolving at 900 revolutions per minute, to take full advantage of this channel with the system we have mentioned. Such an image, of course, could be magnified several times, if the neon lamp gives sufficient light.

It is difficult to make very small square holes in a metal plate; nevertheless, the value of a square hole, as compared with a round one, may be seen by comparing their area. A square hole contains 27 per cent more area than a circle of the same width, and will pass, therefore, 27 per cent more light. (See Fig. 2.) With circular holes, dark bands are visible on the enlarged images. On page 223 they may be seen on the face of a young woman who was being televised in demonstrations at Schenectady; this is reproduced from an unretouched photo. With square holes, this defect would be overcome; and some experimenters make round holes slightly oversized, so that they will lap. This, however, to some extent confuses the distinctness of the various lines, if the overlap is sufficient to compensate for the loss of light by the roundness of the holes.

It will be seen that both discs must revolve very truly on their centers, and that the holes must be bored very accurately. A vibration of as much as a hundredth of an inch, in a 50-hole disc, would be fatal to the picture. For that reason a home constructor cannot attempt to drill his own disc, unless he has measuring tools of great precision. A motor of great steadiness, also, must be used.

GETTING THE DISCS INTO PHASE

It is necessary, not only that the scanning mechanisms shall be constructed with similar proportions, but that they shall be operated exactly alike, with reference to the television impulses.

For instance, suppose that our receiving disc, with the same spiral of holes, is run backward compared with the sending disc. The image will not be reversed from right to left, as in a mirror—it will be reproduced upside down! The backward-running disc builds up the picture from the bottom to the top. (Fig. 3A.)

Suppose that we have a counter-clockwise spiral of holes in the sending disc, and a motor turning it accordingly. The motor at the receiving end runs clockwise—as common motors do—and its disc is drilled accordingly. Then the picture will be reversed, as in a mirror—from right to left.

In fact, this is just what happens if the discs are alike on the side turned toward the person being televised and the side turned toward the observer. The photoelectric cell is the electric eye, which takes the place of the observer's; and if it is placed back of the disc, instead of in front of it, the image will be reversed. (Fig. 3B.)

Suppose that our two discs are both properly placed, at the beginning of a transmission, but that the receiving disc is running very slightly faster toward the right. The image in reproduction will be shifted to the right and down; it will be twisted out of shape toward the lower right, and it will move downwards to the right at a rate depending on the extent to which the motors differ in speed. This is because the series of points which reproduce the image is moving further and further along in their course down the image, and toward its right, at every revolution. (Fig. 3C.)

When the image drifts down to the bottom, and sinks below it at one corner, the

Carefree Reception

With a **TOWNSEND "B" Socket Power**

A.C.-D.C. Any Cycle

Delivers up to 100 volts on any set. Full tone, Clarity, Volume, Distance.

Logs 380 Stations From CUBA to CANADA!

Never in the history of Radio has there been anything that gets such sensational results at this astounding low price. Just read this letter received April 26th, 1928: "Your Townsend does its work, and more besides. I have it working about six or seven hours every day. I have tuned in 380 Stations all over the country, and Canadian, Cuban, Mexican, and Haiti Stations—all on a 5-tube Atwater-Kent. And besides, only a 60-foot Antenna. Yes sir, it is a dandy! Nobody can beat it."

(Signed) W.M. SCHULTZ, 72 Seventh Ave., N., Tonawanda, N. Y.

Just plug a Townsend "B" into light socket and get your share of these radio thrills.

SEND ONLY \$1.00

Simply fill out coupon and slip it into an envelope with only \$1.00 and mail at once. Your Townsend "B" Socket Power Unit will be sent promptly. Deposit only \$5.85 plus postage with the postman. Try out 10 days—then if not more than pleased return it, and purchase price will be refunded.

TOWNSEND LABORATORIES

713 Townsend Street Dept. 25 CHICAGO, ILL.

Money Back Guarantee

Approved and passed by the rigid laboratory tests of Popular Radio and Radio News

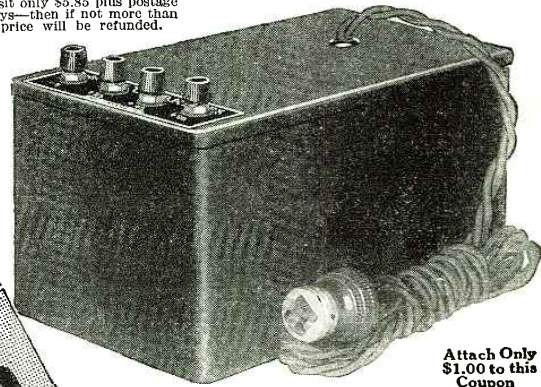

Attach Only \$1.00 to this Coupon

Complete \$6.85 10 Days' FREE TRIAL Balance C.O.D.

Send for Literature

TOWNSEND LABORATORIES 9-28 713 Townsend St., Dept. 25 Chicago, Ill. Gentlemen: Attached find \$1.00. Kindly send at once Townsend "B" Socket Power Unit, C.O.D. for \$5.85, plus postage, on guaranteed 10-day free trial.

Name
Address
City..... State.....

The Soul of Radio

Golden Bear AIR COLUMN SPEAKER

GOLDEN BEAR SPEAKERS embody the most advanced principle of air column construction. They reproduce both music and voice with full and natural tone values. They afford greater amplification without distortion and have the full range of reproduction. Made especially for manufacturers, being very compact, with long tone travel. Write for catalogue. Manufactured by M. J. CARLS, 1929 South Los Angeles St., Los Angeles, Calif.

VICTOREEN Super Coils

Send for Folder and our Blue Print of the new A. C. circuit.

Geo. W. Walker Co. 2825 Chester Avenue Dept. B Cleveland, Ohio

FREE RADIO GUIDE

BIG NEW FALL CATALOG—4000 Items Shows the latest A-C circuits, the newest ideas in radio at startling low prices. Get the sets and parts you want here. Save money. The best in parts, kits, complete factory-built sets and supplies. Orders filled same day received. Write for free copy now. Standard discounts to dealers, set builders, agents.

BARAWIK CO., Dept. 803A CHICAGO, U. S. A.

Please say you saw it in RADIO NEWS.

NATIONAL

TUNING UNIT TYPE 222

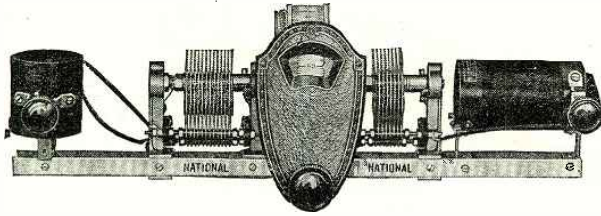

For Experimental Use with the New Screen Grid Tube

A NEW NATIONAL Browning-Drake Transformer, together with the new and beautiful Velvet Vernier Drum dial, Type F, brings out the good qualities of this highly efficient tube in a manner that is both pleasing and inspiring to the experimenter. Perfectly stable operation obtained without use of shields or other energy-absorbing devices. Rigid workmanlike construction makes installation simple and permanent. No cutting of sub-panel required.

List Price, type 222, \$25.00. Two other types also available.

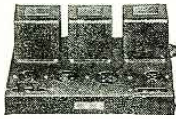

NATIONAL PUSH-PULL AMPLIFIER
For 210 or 250 Tubes
For the fidelity and volume of distortionless audio reproduction now required by modern radio standards with Dynamic Speakers. The curve is "flat" over practically all audio-frequencies, the power output sufficient for the largest hall.



NATIONAL SHORT-WAVE EQUIPMENT
For Use with 222 Tube
New NATIONAL Velvet Vernier Dial, Type E, and special Equeicycle Short-Wave Condenser for experimental work in short-wave reception of broadcast, code and television signals. Also 4 new short-wave R. F. Transformers, 15 to 115 meters.—R. F. Choke, H. F. Impedance, Panel and Sub-Panel with sockets and clips.

Send for New Bulletin 130-N

We shall be at the Pacific Radio Show, San Francisco, Don Wallace in charge. Look us up
NATIONAL CO., INC. W. A. READY, Pres. MALDEN, MASS.

bottom of it will reappear at the opposite corner above. It is obvious that if the sending disc were just beginning on the top of the image when the middle holes of the spiral on the receiving disk were passing the plate of the neon lamp, the received image would be like a moving picture out of its "frame"—the top half and bottom halves reversed.

ADJUSTMENT OF SPEED

In the early experimental transmission of photographs by wire, very odd results were obtained before the synchronization of the apparatus was accomplished. The upper right corner of a photograph would be reproduced in the lower left corner and *vice versa*, before the correct adjustment was made. Similar effects must be expected at first in television. While it is possible to send synchronizing impulses which will automatically regulate the receiving machinery (mechanism suited to this purpose will undoubtedly be a feature of the finished commercial receiver) the complicated controls which it involves are unnecessary for the experimenter in these early days of television.

It is apparent that it will be desirable to establish some standard geometrical image to be transmitted for preliminary adjustment of the receiver. An excellent one for this purpose would be a white X, running from corner to corner of the field and crossed at its center. Practice will very quickly teach a "looker-in" to adjust the speed of his motor to bring such a figure back to shape.

It is probable, however, that each broadcast station will adopt its own special figure for this purpose; such a figure gives a characteristic note during its transmission, which would identify the station for a listener-in through a loud speaker. After a reasonable period for adjustment of the image, which will enable the receiving operator to bring his motor into phase with that of the transmitter, the reflecting surface carrying the figure at the studio will be withdrawn, and the "program" acted before the "electric eye." It will be transmitted through the ethereal medium, received, and the "electric paintbrush" will write it in rosy fire on the black rim of the scanning disc—the canvas of television.

HE TUNED IN CUBA INSTEAD

TEACHER (to geography class): "What was Columbus trying to find in 1492?"

BRIGHT PUPIL: "A short-wave hook-up to get India."—A. E. Hauser.

A NEW and BETTER SHORT WAVE RECEIVER THE AERO INTERNATIONAL FOUR

THIS new Aero Receiver embodies many noteworthy improvements. Uses latest design Aero Interchangeable Coils that provide increased efficiency of operation. Sensitivity has been increased, control made easier, noises eliminated. Particularly adapted to musical broadcast.

Uses New Kit

The coils illustrated are the L.W.T., 10 Kit, price \$10.50. Designed for use with special foundation unit which includes mounting base. These new coils are only 2 in. in diameter, insuring smaller external field and better performance.

Get Literature

Investigate this set today. Write for complete descriptive literature NOW. Address:

Aero Products, Inc.
Dept. 105
4611 E. Ravenswood Ave., Chicago, Ill.

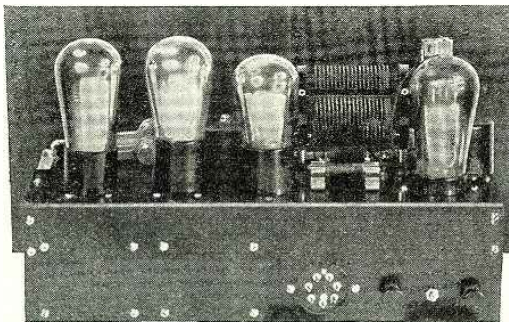

(Rear Panel View)

NOTICE

Your dealer can supply you with complete parts in knockdown form. All parts packed in cabinet, sealed at factory. If your dealer can't supply you, order direct.

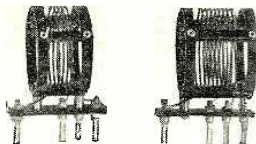

WRITE for information on the New DYNATONE
MAGNETIC 40 - CYCLE REPRODUCER
Brings out bass and depth from any set. Complete with 7-inch cone and baffle. **\$15**
FANSPEAKER RADIO COMPANY
74 Dey Street - - - New York, N. Y.

AIRPLANE CLOTH SPEAKERS

Send for Free Catalog

It contains many bargains in all types of Cone Speakers, Units, complete parts to build all types of cone speakers. Also the latest parts of the New AIRPLANE Cone Speaker. Accessories.
ACCUSTI-CONE, 1 No. 7th St., Phila., Pa.

Station
WRNY
NEW YORK
326 METERS — 920 KILOCYCLES
and 2XAL, 30.91 METERS
is owned and operated by the
publishers of this magazine
Our Editors will talk to you
several times every week—
See your Newspaper
for details
**TUNE IN ON
WRNY**

What's New in Radio

(Continued from page 215)

The characteristics of the heater of the new tube are identical with those of the 227 type; i.e., the heater requires an A.C. potential of 2.5 volts at 1.75 amperes.

In general, the characteristics of this tube follow closely those of the standard 222-type screen-grid tube; the chief difference being that the new tube may be used in A.C.-operated sets. When used in R.F. circuits, it is capable of providing a voltage amplification per stage of from 30 to 60, dependent upon circuit design. It may be employed also in an audio-frequency amplifier, and will be found highly satisfactory in resistance-coupled circuits. In addition, it may be used as a space-charge-grid tube.

The construction of the new tube is shown in the illustration on page 215. A cathode enclosing a heater element replaces the filament of the 222-type tube; but otherwise the arrangement of the elements has not been changed. Another interesting feature of the tube is the design of the plate and the outer screen grid, which are of wire-mesh construction, instead of being the usual metal cylinder and spiral coil of wire. The base connections of the tube are identical with those of UY-type tubes, except that the screen-grid instead of the control-grid is connected to the "G" post.

The A.C. 40-type tube is a "hi-mu" amplifier designed for operation with raw alternating current on the filament; it is mounted in a standard UX-type base, and its external appearance is similar to the D.C.-operated 240-type tube. The filament requires an A.C. supply of 1.05 amperes at 1.5 volts. Plate potentials up to 180 volts and grid-bias potentials up to 13.5 volts (negative) may be used.

In practice the new A.C. hi-mu tube may be used to replace the 240-type tube in R.F. or A.F. circuits; but it must be connected in the circuit in the manner employed for A.C. 226-type tubes. That is, the grid return must be brought to the center of the A.C. filament supply.

The 201B-type tube is a general-purpose detector and amplifier which has been equipped with a filament designed to function with a low consumption of current. The tube may be operated with the usual 6-volt storage battery or with four dry-cell batteries, and it requires a current of 0.125 amperes (at 5 volts) which is only half that drawn by the 201A-type tube. The plate potentials may range from 20 to 135 volts, depending upon the circuit in which the tube is used.

The purpose of this tube is to replace the 201A-type and make possible a 50 per cent reduction in filament current. This change will often make it economically possible to operate a receiver with dry-cell batteries, or allow series-filament operation with the filament current provided by the "B" unit. The other characteristics of the tubes are very similar to those of the 201A-type.

Manufacturer: The C. E. Manufacturing Company (CeCo) Providence, R. I.

WHAT WE SHALL SEE

It is announced that television has been definitely established between England and America. Stay-at-home Americans are said to be very curious to see their friend, the British taxpayer.—*London Opinion.*

The Ultimate in Controls!

ELECTRAD Resistances are specifically designed to assist the builder of eliminators and receivers in solving the important problem of control in all its phases.

Exhaustive tests for mechanical and electrical exactness assure the unsurpassed accuracy and dependability of these units.

Electrad Specializes in a Full Line of Resistances for All Radio Purposes



PHASATROL
Reg. U. S. Pat. Off.

A True Balancing Device for Radio Frequency Amplifiers

Phasatrol is an unusually efficient device for controlling radio frequency oscillations and thus eliminating the disturbances to reception which they cause. Adapted to any type of receiver using R. F. amplification. A wonderful improvement for the new A. C. circuits where the elimination of noise is often a problem. Price \$2.75 each.



ROYALTY

VARIABLE HIGH RESISTANCES

Recommended for use wherever variable high resistances are required in high frequency circuits. Superior in design and construction. Made with only the best insulating materials. No harmful capacity or inductance effects. 11 Types, Type A to L. Potentiometer in all sizes, \$2.00. All other types, \$1.50.

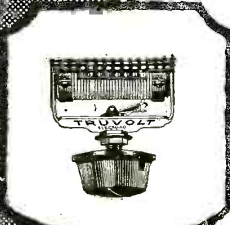

TRUVOLT

ALL - WIRE RESISTANCES
Reg. U. S. Pat. Off.

Truvolt Variables simplify B-Eliminator construction by eliminating difficult calculation and making all adjustments easy. 22 stock sizes, \$3.50 each. Truvolt Fixed Resistances are adjustable to different set values by the use of sliding clip taps—an exclusive Truvolt feature!

TEAR OUT AND MAIL COUPON FOR FULL INFORMATION

Electrad Inc. Dept. N-3, 175 Varick St., New York, N. Y.



Please send me descriptive circulars on Electrad Resistances. Control. I am particularly interested in:

Name _____ Address _____ City _____ State _____

ELECTRAD Inc.

\$75 to \$125 Weekly

Charging Batteries Starts You

Let me show you how to make big money right from the start. I've prepared a FREE book explaining all details. First week's profit pays for all equipment. You can get all the battery charging business in your community with my Service Station Charger—it's years ahead of ordinary chargers—handles 50% to 70% more batteries. I explain everything—start you in a business of your own and put you on the way to big money. Write for FREE BOOK.

C. F. HOLMES, Chief Engineer, Dept. R.N.
Independent Electric Works
5116 Ravenswood Ave. Chicago, Ill.

FREE BOOK—Just Out

"CHI-RAD"

Complete Parts
for the NEW

HFL ISOTONE and New KNAPP "A" ELIMINATOR

Send for Special Bulletin. Discounts to Set Builders.

Chicago Radio Apparatus Co.
415 S. Dearborn St., Dept. RN, Chicago

Please say you saw it in RADIO NEWS.

Transmission of Photos by Radio

TRANSMISSION OF PHOTOGRAPHS BY RADIO—Various methods have been devised and are now in use for the transmission of photographs by radio. Among these may be mentioned the systems of *Belin* (q.v.), *Baird*, and *Jenkins*. The principles underlying the Jenkins system are explained under the heading of *Television*. Using the system developed by Capt. R. H. Ranger, photographs were transmitted by radio from Honolulu to New York, a distance of 5,136 miles. Recently commercial picture transmission service has been inaugurated between New York and London using the Ranger apparatus. Two distinct methods have been applied for analyzing the picture in the process of trans-

the electron flow constitutes a discharged circuit, so that the grid becomes less negative. The first amplifying tube is a direct current potential amplifier, and is resistance coupled. The grid and plate connections of the amplifier are connected across a condenser which becomes discharged with the fall in the grid to plate resistance of the valve brought about by the grid potential fluctuations. A charging circuit is connected to the condenser and is controlled by a valve, the grid circuit of which operates by variations of the potential across the condenser. The charging current is fed through the plate circuit of this valve, in which a relay is connected, which working through other mechanical relays in

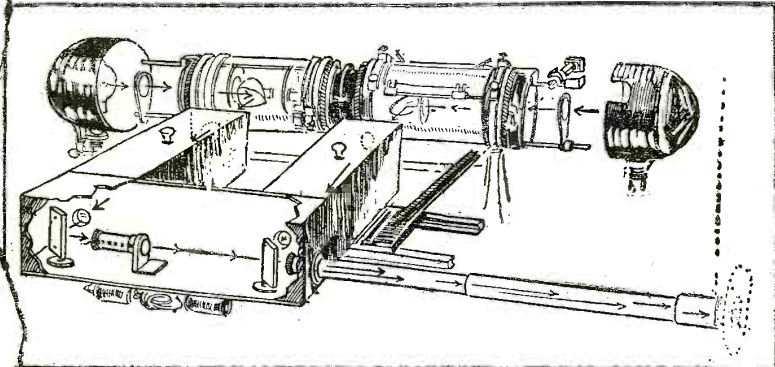

A pencil of light traverses the picture which is attached to the glass drums and is analyzed by a slow rotating action as well as a backwards and forwards movement of the carrier.

mission. One arrangement consists of producing an image as a non-conducting deposit upon a metal foil which is traversed by a stylus, while the other method makes use of an opaque image deposited upon a transparent film which is traversed by a beam of light, the light interruptions being recorded by a light sensitive cell. The Ranger system makes use of this latter method. The image is photographed and recorded upon a cell.

cascades, controls the radio transmitter. Wave trains from the transmitting station after detection and amplification, are applied to the picture recorder. The recording mechanism, in order that it may be sensitive to exceedingly small currents, comprises a small moving coil, in a magnetic field created by three electromagnets. The coil of wire, in moving in the field, as the received fluctuations

The Standardization of Radio Terms

(Continued from page 225)

briefiation from the nature of the circuit conditions, whether the *m* stands for micro or for milli?

The most practical idea is to use *mch.* and *mca.* for *microhenry* and *microampere*, respectively; and *mlh.* and *mlla.* for *millihenry* and *milliampere*, ditto. The presence of the extra *l* and *c* identifies the abbreviations beyond mistake. Of course, the best thing to do is to spell out the units altogether, but it is frequently expedient to use abbreviations; for instance, in mentioning a number of different current or inductance values in the same paragraph. Discussion on this subject is highly in order. (Note: a *mil* is one one-thousandth of an inch; do not use it for milliampere. Also: the plural of *henry* is *henries*).

"A," "B" and "C": Batteries or circuits. The quotation marks should be used at all times. Without them, the letter "A," in particular, is often mistaken for the indefinite article. I. R. E. listing agrees.

CONFUSION WORSE CONFOUNDED

INDUCTANCE, RESISTANCE, CAPACITANCE, IMPEDANCE: All four terms are definitely defined as certain properties; the first three of electrical circuits and devices, and the fourth as a resultant of the other properties in combination under certain circumstances. Now, is it certainly not more correct to call a coil possessing the property of inductance an "inductor," rather than an "inductance"? How can it be "an inductance," if inductance is rigorously defined as an intangible property or quality? And why not "resistor" to designate a device possessing the property of resistance? "Inductor" and "resistor" are rapidly increasing in favor; they should be encouraged heartily.

Instruments possessing the property of capacitance most logically would be designated as *capacitors*. This term is being used in the advertisements of one condenser manufacturer, but it is unlikely to become anything more than a good second to *condenser*; because the latter word is much too firmly entrenched in our common vocabulary to yield to change.

For the common use of the word *impedance* as a designation for a specific inductor, usually of comparatively high value, there is little excuse; since the definition of impedance is iron-bound. Impedance is the property of A.C. circuits that corresponds to the plain resistance of D.C. circuits. It may comprise resistance and inductive reactance, resistance and capacitive reactance, or resistance and both varieties of reactance; in view of this, how can the word be used for a single piece of apparatus? If an inductor is an impedance, so is a condenser, and so, for that matter, is a resistor.

However, the practice of designating iron-core choke coils as "impedances" is so common that there is little hope of reform in this particular direction. The use of these choke coils in "impedance"-coupled A.F. amplifiers is rapidly increasing, and along with it the use of the term *impedance coupling*.

FILAMENT BALLAST: For mechanically fixed resistors of various kinds (that is,

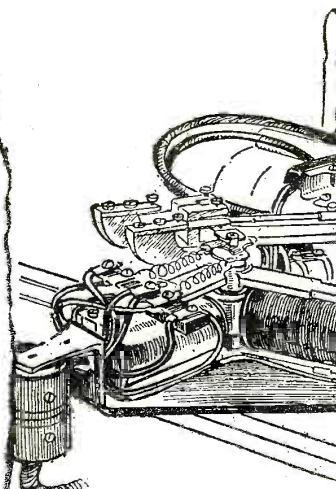

recording mechanism of the receiver. The stylus traverses the surface of the paper. The recording mechanism of the receiver. The stylus traverses the surface of the paper. The recording mechanism of the receiver. The stylus traverses the surface of the paper.

applied through its windings, creates a stylus while travelling across the surface of the paper. The stylus traverses the paper in perfect synchrony with the carriage of the transmitter, the paper being lifted

S. Gernsback's Radio Encyclopedia

A facsimile of a portion of a page from S. Gernsback's Radio Encyclopedia is reproduced herewith. A glance at the thorough manner in which each item is treated cannot fail to instill a true appreciation of the value of the remarkable book. S. Gernsback's Radio Encyclopedia is the first ever published. It is not a dictionary. It covers every possible phase of radio. Every circuit, each piece of apparatus, all the leading characters of the industry, broadcasting, receiving, television, telephoto, everything connected even in the slightest way with the growth of radio or its kindred sciences, is most authentically explained. There are over 1930 separate definitions, 549 illustrations, a complete cross index, and many other special features. S. Gernsback's Radio Encyclopedia comes in two beautiful bindings, large 9 x 12 in. size.

Cut here COUPON Cut here

- Beautiful Limp Suede Edition (de luxe) \$5.00
- Keratol-Leather Stiff Binding..... \$2.00

Write your name and address in the margin below, mark which binding you prefer, and the book will be sent to you C. O. D. plus postage.

S. GERNSBACK

230 FIFTH AVE. NEW YORK, N. Y.

devices not manually controllable) used to regulate the current to the filaments of vacuum tubes. This is the only expression that covers all existing devices of the kind; the term "automatic rheostat" being the exclusive legal property of the company that manufactures the well-known "Amperite."

The foregoing statement is by no means complete, and was compiled merely to emphasize the more outstanding irregularities of radio nomenclature. RADIO NEWS will be pleased to learn the opinion of its readers on the general subject.—EDRORR.

A. C. Operation Problems

(Continued from page 205)

of volume; while, conversely, a further rise will leave the voltage still excessive, all requiring frequent checking and readjustment.

AUTOMATIC DEVICES

For these reasons, some form of automatic voltage control becomes highly desirable. One such is the A.C. filament ballast. Operating on the same principle as the familiar ballasts for D.C. tubes, they are connected between the power-transformer secondary and the filaments of the various A.C. tubes. With a suitable ballast for the power tube, a comforting degree of protection can thus be attained. Such equipment can, of course, be applied to best advantage only in home-constructed sets or to those commercial receivers with separate units, permitting the insertion of ballasts in the proper circuits without disturbing the wiring.

The same protection can also be secured, without change in internal connections, by use of a ballast device, several makes of which are available, employing the filament-ballast principle but designed to be inserted between the receiver and the power supply circuit. These are intended to hold the potential across the power-transformer primary at 110 volts, regardless of fluctuations up to 120 or 125, and their installation is simple. But in selecting one, a size adequate for the receiver's wattage must be chosen.

It is clear that, save for the tapped primary, the measures so far mentioned are designed to guard only against excessive voltage. To be sure, this is much the worse of the two possible evils; but there are many locations in which, due to the overloading during the evening hours, low voltage proves quite as annoying. For these cases, as well as those in which excessive voltage is the problem, automatic voltage-regulators recently placed on the market seem to offer material relief.

Designed to be plugged in between the receiver and the lighting circuit, and operating on the inductive principle, these regulators hold the current delivered to the set within one or two volts of the prescribed 110, regardless of fluctuations in the supply from 90 to 130 volts. In addition, they have the merit of requiring no further accessories.

So it would appear that, with all these alternatives available, even the formidable problem of voltage control should be well on the road to solution. The same holds for the other problems of A.C. operation; they have already been carried well toward solution, and a frank recognition of their existence should have the effect of making their complete conquest still easier.

Now-Make Your Radio Clear as a Bell—with Marvelous New GROUND AERIAL!

SUB-AERIAL ENDORSED BY EXPERTS

May 8th, 1928
 "I am very glad to state that after testing many Aerials in my Laboratory I find your Sub-Aerial is the best for clarity of tone and elimination of static, also for greater volume and selectivity.
 Your Sub-Aerial will fill a long-felt want among the Radio Fans."
 —A. B. JOHNSON, Radio Engineer.

Get Amazing Distance
 Greater Volume and Finer
 Selectivity without Distortion

Why go on listening to terrible static and other maddening outside noises? Now you can get the real music your present Radio is capable of giving, by hooking your set on to the clear, practically static-free ground waves with Sub-Aerial. The air is always full of static and your overhead aerial picks it up and brings it to your speaker. So why stay in the air—when you can use the whole earth as a static and noise filter with Sub-Aerial?

LOW ORIGINAL COST—NO UPKEEP COST

SUB-AERIAL costs no more than an overhead or loop aerial and less than many. It's first cost is the only one. SUB-AERIAL is permanent. No trouble—no hard work, or risking your neck on roofs.

TRY IT FREE! We know so well the surprising results you'll get that we'll let you put in a Sub-Aerial entirely at our Risk. You be the Judge. Don't take down your overhead Aerial. Pick a summer night when static and noise interference on your old Aerial are "Just Terrible." If Sub-Aerial doesn't Sell Itself to You Right Then on Performance—you needn't pay us a cent. Send for "all the Dope on Sub-Aerial." You'll be surprised. Do it NOW.

25-YEAR GUARANTEE

UNDERGROUND AERIAL SYSTEMS
 St. Clair Bldg., Dept. 9-M,
 Cor. St. Clair and Erie Sts., Chicago, Ill.

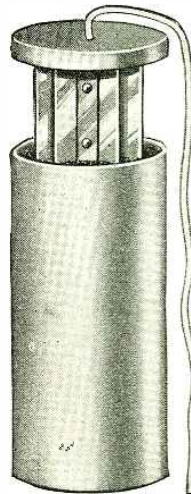

Ground Out Static with SUB-AERIAL

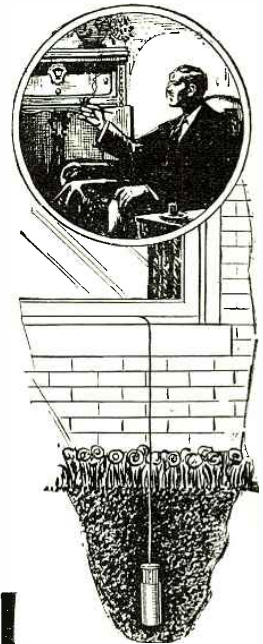

Can be installed in a few minutes

UNDERGROUND AERIAL SYSTEMS, Dept. 9-M
 St. Clair Bldg., cor. St. Clair and Erie Sts., Chicago, Ill.
 Send me complete information on Sub-Aerial, Proof and Free Trial Offer
 No obligation.
 Name.....
 Address.....
 City..... State.....

The ELECTRIC Radio
Freshman
EQUAPHASE
 at All Authorized Dealers

FOR CUSTOM BUILT SETS
ROSS
 Box 112, MASSILLON, OHIO

C. R. LEUTZ, Inc.
 195 Park Place
 ASTORIA, L. I., NEW YORK

FREE RADIO GUIDE
 BIG NEW FALL CATALOG—4000 items
 Shows the latest A-C circuits, the newest ideas in radio at startling low prices. Get the sets and parts you want here. Save money. The best in parts, kits, complete factory-built sets and supplies. Orders filled same day received. Write for free copy now.
 Standard discounts to dealers, set builders, agents.
BARAWIK CO., Dept. 809A CHICAGO, U. S. A.

6-TUBE RADIO COMPLETE
 534.75 to 566.66
 Licensed R.C.A. Circuits. Shielded. One Dial
 Write for catalog. Big discounts to agents
ConsumersRadioCo., Dep. 149, 4721 Lincoln Av. Chicago

EVERYTHING IN RADIO
 AT ATTRACTIVE PRICES. SETS OR PARTS.
 Orders shipped exactly as ordered. Prompt Service.
 Write for Prices. Mail Order Only. Send Your Address.
ALL RADIO COMPANY, 417 North Clark St., Chicago

**Make Your Set a Modern
A. C. Power Receiver**

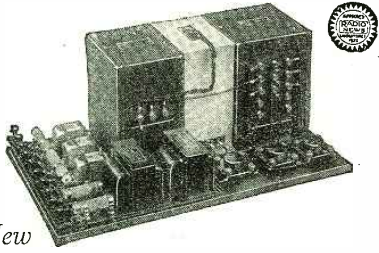

AMPLIPACK

A Complete A. C. Power Supply—"A" and "B" and "C"—Makes any D. C. Set into an Ultra-Modern A. C. Receiver. Uses two 210 type tubes in Push-pull; or one of the new 250 type tubes. Power Amplification gives perfect reproduction over the entire musical scale range.

QUICKLY ASSEMBLED

You can assemble an AmpliPack easily in one evening. We supply complete layout diagrams. Simple to install. Attached to set in three minutes. Consumes no more current than an ordinary 50-watt light. Cool, quiet, dependable.

ASK YOUR DEALER

Leading dealers can give you full details and our simple assembly diagrams. Don't be satisfied with out-of-date reception—build an AmpliPack tonight!

FREE Booklet

Write for our new Free Booklet—the latest word on Power Amplification and A. C. Conversion.

TRANSFORMER CORP. OF AMERICA

1428-1432 Orleans Street, Chicago, Ill.
Manufacturers of the T. C. A. Line of Power Transformers, Audio Transformers, Chokes, Power Packs and Power Amplifier Packs.

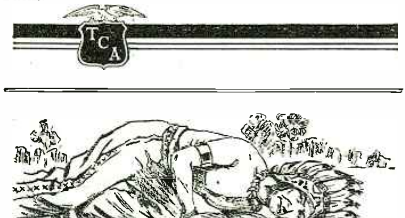

**Listen in to Mother Earth's
Clear "Constant Potential"
GROUND WAVES**

Even the primitive Indian knew the greater carrying power and absence of interference in sound waves transmitted through the ground. The same is true with radio—ground waves are stronger, clearer, less subject to interference.

VIAGROUND, the new Radio Wave Collector, offers you science's latest development in the field of ground wave radio reception. Gives you amazing distance, clarity and wonderful reduction of static—an entirely new kind of radio reception. In Summer, during storms and other disturbances. Remarkable achievement of the famous radio cable-system inventor, Earl C. Hanson.

Compact, easily installed; no unsightly aerial or lightning hazard; no reduction in volume. Less than the cost of installing aerial; half the price of ordinary underground antennas of comparable quality—due to our manufacturing facilities and large volume. For complete details, see our literature.

DEALERS—Ask for full details of our attractive dealer proposition.

GENERAL ANTENNA CO.
4508-14 Drexel Blvd., Chicago, Ill.

**VIAGROUND
RADIO WAVE COLLECTOR**
"In Tune with Mother Earth"

\$1 WITH ORDER
Balance C. O. D. Try VIAGROUND on your set. If not checked by your dealer, order direct. Price, \$5.00. Send \$1.00; balance C. O. D. Use on A. C. and D. C. sets. Furnished with 12 ft. of flexible armored lead-in wire—additional lead-in wire 5c per ft. Order today!

LEARN CODE

At Home with the Teleplex Code Sender. Reproduces actual sending of expert operators. Sends messages, radiograms, etc.—regular code traffic at any speed. You "listen and learn." No experience necessary. Endorsed by U. S. Navy and leading schools. Complete set of Record-Tapes (Wireless or Morse) furnished. Remember only code brings you the thrill of real DX. Write for Booklet NTR.



TELEPLEX COMPANY
76 Cortlandt St., New York, N. Y.

**How to Build From the
Schematic**

(Continued from page 231)

tor circuit is reached. The diagrams in Fig. 3 show the four systems most generally used; A and B are non-regenerative circuits of the type used in sets employing two or more R.F. stages, and C and D are regenerative circuits which are used in sets employing not more than one R.F. stage.

Probably ninety per cent of the detector circuits in broadcast receivers of the average type are of the type shown at A. In this circuit the grid method of rectification is employed, and this is indicated by the presence of the grid condenser (C1) and grid leak (R). The coil L is the secondary of an R.F. transformer and the variable condenser is the usual tuning instrument. As may be seen, the only way in which this circuit differs from the usual R.F. stage is the presence of the grid leak and grid condenser. The grid condenser has a capacity of .00025-mf. and the grid leak a resistance of 2 to 9 megohms, dependent upon the tube employed. This is the most sensitive type of non-regenerative detector circuit known.

The circuit shown at B is known as a plate—"anode" rectification detector. This type of circuit is not so easily overloaded as the leak-and-condenser (grid-rectification) circuit shown at A and, therefore, it is used in large sets such as three-stage tuned R.F. sets and superheterodynes; however, the method is not as sensitive as the other. The plate-rectification circuit is practically the same as the usual R.F. amplifying circuit, except that a grid-biasing ("C") battery must be connected in the grid-return lead. This battery is shown at "C" and it has a potential of 4.5 volts when 45 volts of plate potential is used.

The two regenerative-detector circuits are similar to the non-regenerative circuit A, except that an additional ("tickler") coil is connected in the plate circuit to cause regeneration, and this coil is coupled to the grid circuit. In the circuit C the coil L shows the secondary and plate windings of a detector-circuit tuner. The detector-circuit tuner has a primary and secondary similar to the usual R.F. transformer, but an additional plate or tickler winding has been added. The important feature of such a detector-circuit tuner is that the plate coil is mounted on a shaft in such a way that it may be rotated. By turning the shaft the coupling between the secondary and the plate coil is changed and regeneration is increased or decreased, as desired. The number of turns of wire on the plate coil is not critical, as just enough turns to produce regeneration on the highest wavelength are required. Usually 50 turns of wire on a two-inch tube are sufficient. Also, in the circuit of C, a by-pass condenser with a capacity of .002-mf. should be connected between the filament and the plate side of the phones.

At D we have the Reinartz regenerative circuit; in this the plate coil is fixed and regeneration is controlled by the variable condenser C2, connected between the plate of the tube and the plate winding. In this case the number of turns on the plate winding is determined by the size of the condenser. Any condenser with a maximum capacity between .0003- and .0005-mf. may

**Science and
Invention**

**A New Issue Just Out!
Do Not Miss These Articles**

The following are just a few of the many interesting articles that appear in the September issue of SCIENCE and INVENTION.

ARTICLES

TRICK MOVIE PHOTOGRAPHY IN "SPEEDY"—Explained by Edwin Schallert.

HOUDINI'S LAST MASTERPIECE—An explanation of the last trick of the world's greatest magician—freezing a man in a cake of ice before a theatre audience. How it's done.

NEW STARS — HOW NATURE MAKES THEM—Explained by Prof. W. J. Luyten of Harvard College Observatory.

NEW MOON ROCKET—An article dealing with a topic that in the last few years has called forth much discussion—a trip to the moon. This article gives full explanation of how the Opel Rocket Car and Rocket Airplane operate.

**Big Prize Contest for
Readers**

\$500.00

in Cash Prizes

The pictorial cover of the September issue of SCIENCE and INVENTION contains a number of scientific errors. \$500.00 in cash prizes will be given for the best answers to the question, "What's Wrong with this Picture?"

Don't miss this big issue of SCIENCE and INVENTION. Over 100 pages. Fully illustrated. Large magazine size.

THE 25¢ COPY

AT ALL NEWSSTANDS OR WRITE DIRECT

EXPERIMENTER PUBLISHING CO., INC.
230 FIFTH AVE., NEW YORK, N. Y.

be used and enough turns should be placed on the plate winding to cause regeneration at the highest desired wavelength. The plate winding may be located on the same coil form as the secondary and should be placed at the filament end of the latter coil. Also, in regenerative circuits of this type, an R.F. choke coil must be connected in series with the output circuit, to prevent the R.F. current from returning to the filament through the phones rather than through the plate coil.

(To be continued next month)

Successful Television on the Broadcast Band

(Continued from page 220)

bulbs acquired by Radio News for use at its own broadcast station, WRNY, were made by Lloyd Preston Garner, a graduate of the University of Illinois, in the laboratories of that institution. They represent an enormous amount of technical experimentation and constructional skill, and are probably the finest devices of their kind in existence to-day. Some idea of the size of these cells may be obtained from Fig. C, on page 220, and the illustrations on pages 221 and 256.

The radio television demonstration given in June was intended merely to show the feasibility of television transmissions on the regular broadcast band. At the present writing neither Mr. Sanabria nor the officials of WCFL have any definite plans for television broadcasting on regular schedules; but they have stated that they will make plans of this kind in the near future.

Sanabria is working on a number of ideas which, he claims, will materially improve television transmission without widening the modulation channel of the transmitter. One of these involves a disc having three sets of spirals, each covering an arc equal to 120 degrees. Another deals with the use of a local oscillator, which improves what he calls the "vertical definition" of the transmission. It is too early now to report on the success of these projects, but as the results of the experiments become known, then.

The Listener Speaks

(Continued from page 208)

"In the *Ti may Rosus*," This, of course, isn't grand opera, but it serves to illustrate my meaning.

I wonder, Mr. Adams, if you know that all the operas, with the exception of a very few, were composed and written in Europe? One would hardly expect an Italian, German, Frenchman or any other foreigner to write in any but his native language.

No doubt you'll say that the various operas could be translated into English. Possibly they could, but not without impairing the original beauty. To my mind, the translation is coarse and harsh, and I believe the great majority will agree to this.

That's off my chest now; let's have some more "grand uproar."

F. W. LOVGREN,
Box 649, Virginia, Minn.

Build
Your
Power
Pack
Around
the

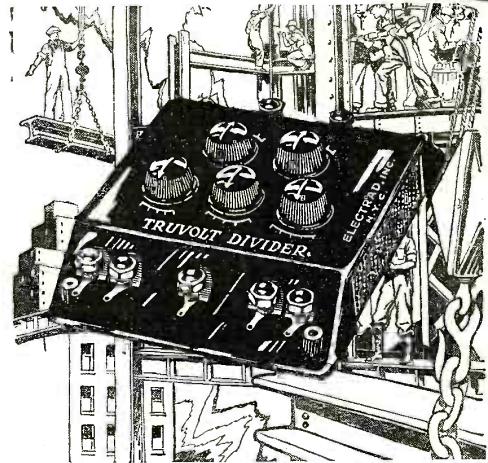

TRUVOLT DIVIDER

A Universal Voltage Separator

This new Truvolt Divider offers you the complete resistance combination for constructing with utmost ease a remarkably efficient power pack suitable for operating any type of receiver up to 12 tubes.

By dividing the filtered voltage into usable values, it eliminates all necessity of mathematical calculations in constructing a power pack. It does away with a great deal of wiring and the need of voltage regulator tubes. It makes it possible to build a power supply device which is universal in its application.

Case made of genuine bakelite, it will add a smart appearance to any unit. Five potentiometer type control knobs show values on a scale of high visibility. Can be mounted on base-

board or sub-panel, or used as the front panel on a metal cabinet, at the same time providing binding posts for all "B" and "C" voltages.

Price—\$12.50

Electrad Specializes in a Full Line of Controls for all Radio Purposes

ELECTRAD, INC.
Dept. NA-9, 175 Varick Street, N. Y.

Please send me descriptive circulars on the following products and put me on your mailing list for similar literature.

- General Circular
- Tonatrol Volume Controls
- Royalty Variable Resistors
- Phasatrols
- "Electrad Control Manual" (Enclose 10 c. for mailing)
- "What B Eliminator Shall I Build" (Enclose 10 c. for mailing)

I am particularly interested in

Name

Address

Write for Free Circulars and Full Information

ELECTRAD Inc.



Use
Your
Radio
More!

THOUSANDS of homes get more use of their radio because of the exceptional economy and dependability of our "B" and "AB" equipment. A safe investment in tone quality, selectivity, extreme dependability and economy. For heavy duty service on all types of receivers. Write for free trial offer and guarantee. Made for all power lines, including farm plants. **WRITE!**

KIMLEY ELECTRIC CO.
441 East Ferry St. Buffalo, N. Y.

'Round the World with New Karas Short - Wave Receiver

Enjoy the thrills of hearing stations thousands of miles away. Karas engineers have developed short wave equipment to highest point. Easy to build. Easy to tune with Karas Micrometric dials. 63 to 1 ratio. Uses Karas condensers, built like a fine watch. Karas coils and audios—standard of the world. Send today for complete information and construction blue print. Free.

KARAS ELECTRIC COMPANY
4038 JB-North Rockwell St., Chicago, Ill.

NAME.....

St. and No.....

City and State..... 4038JB

The Screen-Grid Strobodyne

(Continued from page 241)

on the partitions where they belong. Full-sized drilling layouts are included among the free blueprints, and may be used for this purpose if the constructor feels the necessity of doing so. It is necessary to cut a piece of aluminum and two pieces of angle brass in order to form an extra partition in the rear right shield (S4) to provide two compartments of equal size for the two stages of intermediate amplification.

When preparing the aluminum shields, it is important to drill the holes accurately; especially those for the mounting of the variable condensers, so that they will accurately match the dials which are fastened on the front panel. A very small variation in the drilling of one will, of course, affect the others; and it may happen, if the holes have not been drilled carefully, that the shaft of the condenser will not fall exactly in front of the bushing of the dial. Therefore, we urge the builder of this receiver to be very careful when drilling the aluminum shields, to trace them with a square and ruler and drill each partition *separately*. The last is to avoid the drill's biting sideways and traveling obliquely through the aluminum; the results of which would be that the holes would not center in the right places, where they had been indicated. It is not recommended that two or more partitions be placed on top of each other to drill at one time, for this reason. Be sure to use sharp drills.

MOUNTING THE CONDENSERS

It will be seen that, in shield S3, the variable condenser C3 is not mounted directly on the shield, but on a piece of bakelite which is itself fastened on the aluminum shield. This is done to insulate the frame of the condenser from the shield, because both sides of the condenser are at high potential and the whole instrument must be insulated from the shield which is itself connected to the "A—." The size and drilling layout of the bakelite plate which insulates the condenser from the shield is given in one of the blueprints.

The two other variable condensers, C1 and C2, which are mounted on shields S1 and S2, should be attached to the shields without their shafts, which are removed by loosening the two set screws on the rotor. In place of these, a 10¼-inch shaft is introduced through both rotors, in order to turn the two condensers at the same time, with a single dial.

The next step is to put in place the partitions supporting the variable condensers C1 and C2, in order to connect them to the rest of the circuit. These partitions are supported by the corner post, made also of aluminum, which should be fastened with 6/32 machine-screws, ¾-inch long. These screws pass through the wooden baseboard and hold the whole shield flat on the baseboard, as well as support the corner posts.

After all the condensers have been placed in their proper locations the insides of the shields may be wired; that is, all the wires connected to the condensers and other accessories inside of the shields may be put in place before the partitions are set up, in order to have better access to all the various pieces of apparatus. Also, the condenser C21 is mounted on the stator of C1 by fastening the brass lug of C21 under the terminal screw of C1.

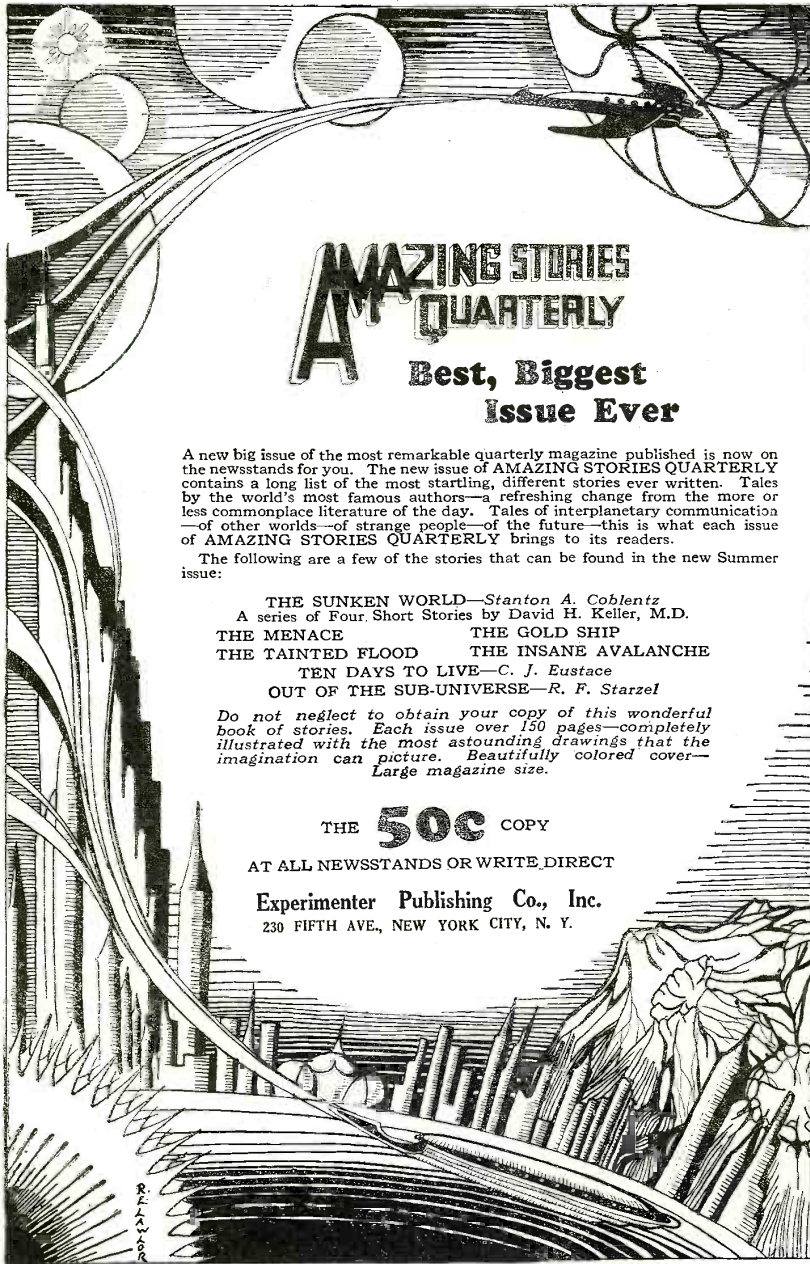

AMAZING STORIES

A QUARTERLY

Best, Biggest Issue Ever

A new big issue of the most remarkable quarterly magazine published is now on the newsstands for you. The new issue of **AMAZING STORIES QUARTERLY** contains a long list of the most startling, different stories ever written. Tales by the world's most famous authors—a refreshing change from the more or less commonplace literature of the day. Tales of interplanetary communication—of other worlds—of strange people—of the future—this is what each issue of **AMAZING STORIES QUARTERLY** brings to its readers.

The following are a few of the stories that can be found in the new Summer issue:

- THE SUNKEN WORLD—Stanton A. Coblenz
- A series of Four Short Stories by David H. Keller, M.D.
- THE MENACE THE GOLD SHIP
- THE TAINTED FLOOD THE INSANE AVALANCHE
- TEN DAYS TO LIVE—C. J. Eustace
- OUT OF THE SUB-UNIVERSE—R. F. Starzel

Do not neglect to obtain your copy of this wonderful book of stories. Each issue over 150 pages—completely illustrated with the most astounding drawings that the imagination can picture. Beautifully colored cover—Large magazine size.

THE **50c** COPY

AT ALL NEWSSTANDS OR WRITE DIRECT

Experimenter Publishing Co., Inc.
230 FIFTH AVE., NEW YORK CITY, N. Y.

FREE RADIO GUIDE

BIG NEW FALL CATALOG—4000 items Shows the latest A-C circuits, the newest ideas in radio at startling low prices. Get the sets and parts you want here. Save money. The best in parts, kits, complete factory-built sets and supplies. Orders filled same day received. Write for free copy now.

Standard discounts to dealers, set builders, agents.

BARAWIK CO. Dept. 809-B CHICAGO, U. S. A.

Mail This Coupon Now! For Free Copy

Name.....

Address.....

This handy book should go with every Radio!

It is concerned with radio parts—their functions—where they are—and their names. It gives the symbols used in radio hook-ups, so that you will be able to read any diagram and understand it. It discusses air waves—the aerial—then takes you through every radio part—and finally the actual reproduction of sound.

This is a book that will give you a full understanding of your set.

ALL ABOUT RADIO PARTS
5¼ x 7¼ inches, fully illustrated
Get it from any newsstand or direct
THE CONRAD COMPANY, INC.
230 Fifth Avenue New York City



Please say you saw it in RADIO NEWS.

The two R.F. choke coils, L7 and L8, are mounted on the shield, S4; L7 is located on the inside of the shield and held in place by a bracket which is fastened to the assembly bolt which holds the central partition of the shield. This bolt is 1 1/4 inches below the top of the shield. L8 is located outside the shield, directly over the coil L6; it is mounted in place by a bracket fastened to the left side of the shield with a bolt passing through the shield.

The aerial-and-ground binding-post strip is fastened on the back of the shield S1 by means of 6/32 screws and nuts, and angle brass, as shown in the back view of the set (Fig. 5). The two by-pass condensers (C14 and C15) are also mounted on the back of the shield S4 with screws and nuts as shown in the picture.

If the shield partitions do not slide easily down the grooves of the corner posts, unscrew the fastening screws under the baseboard until the posts are loose, and then the partition should slip down easily. After the set has been completed, the corner posts may again be screwed tightly in place; this will hold the partition securely in the proper position.

THE TUBE SHIELDS

The 222-type tubes are so sensitive that it is necessary, in order to avoid direct pick-up of energy by the elements of the tube, to shield the tube itself, although it is already enclosed in the shielding compartment.

If the metallic shields used to cover the tubes are too long, they may be cut at the bottom; so that, when the tube shields are placed in position inside the aluminum shields, they permit the covers of the boxes to be screwed down. After they are cut to the proper size, a wire should be soldered at the bottom of each tube shield; the other end of this wire being fastened to one of the screws on the aluminum box, thus connecting the tube shield to the "A—" battery. This is to ground the shield to the rest of the circuit. Connection to the control-grid terminal on top of each 222-type tube is made easily by using some flexible wire, which may be twisted around the top of the tube to form a loop which may be slipped on the tip after the tube shield has been placed over the tube.

After all the front and back partitions of the shields have been put in place, the side partitions may be placed in the slides and the wiring may be completed; that is, the wires passing through the side partitions are put in place and connected as shown in the pictorial wiring diagram.

FRONT-PANEL WORK

The drilling of the front panel does not present any difficulty. It is required only to have it traced very accurately and drilled with a sharp tool, so that the holes will be exactly where they are required for the dials. This is important in order to align the dials with the condensers, which are fastened on the aluminum shield.

In order to have the dials placed at exactly the right places on the panel, so that they will fit exactly over the shafts of the condensers without binding, proceed as follows:

With a square, draw a perpendicular line passing through the center of each of the shafts and trace this line on the edge of the baseboard. Then measure the distances between the center of each shaft and the center of the baseboard, in order to obtain the exact location of the shaft. In

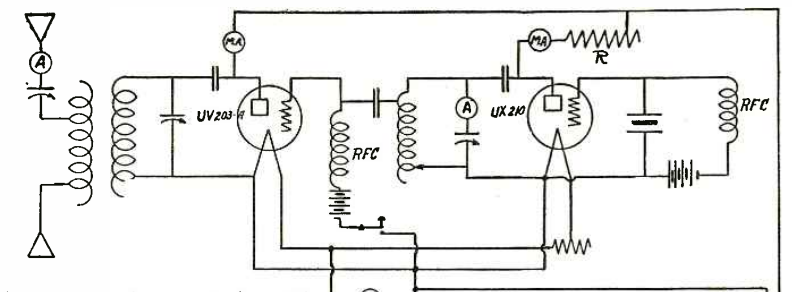

THIS shows a medium power crystal controlled transmitter using UX210 crystal controlled tube feeding a UV203-A power amplifier. Filament and plate voltages are to be obtained from Item 34, operating from either DC or AC house mains. The voltage to the filament of the tubes is variable, either by the field rheostat in the filament generator circuit [not shown] or by the resistance in the filament circuit of the UX210 tube. Keying is done in the bias circuit of the 203-A power amplifier. As the amplifier is NOT neutralized, the power amplifier must work on some harmonic of the crystal tube (preferably the second), for all operations in the 20, 40 or 80 meter bands. A crystal having a fundamental of 160 meters will allow operation in all bands with best output in the 80 meter one. An 80 meter crystal is best for 40 meter operation and, in like manner the 40 meter crystal would be best for 20 meter operation. Forty meter crystals are hard to get and blow up easily, so for 20 meters the 80 meter crystal is used again. Both tubes obtain plate supply from the plate end of Item 34, the UX210 being supplied with not over 350 volts through resistance R, and the 203-A taking the full 1000 volts.

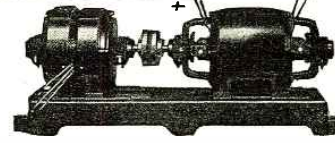

ELECTRIC SPECIALTY COMPANY

211 South Street TRADE "ESCO" MARK Stamford, Conn., U.S.A.
Manufacturers of Motors, Generators, Motor-Generators, Dynamotors and Rotary Converters for Radio and other purposes

Amazing New Ground Antenna



GETS EVERYTHING BUT STATIC
Brings in Far Away Stations Loud and Clear Regardless of Static Conditions
Fans everywhere are replacing their troublesome and static gathering roof aerials with the marvelous new Ground Antenna—Aer-O-Limitator. Radio engineers and hundreds of users testify that Aer-O-Limitator gets better long distance reception, almost unbelievable freedom from outside noises, far greater selectivity and marvelously true, clear, sweet tone quality.
John E. Christenson, Radio Engineer, Chicago, writes: "I have tested and thoroughly approve the Aer-O-Limitator. I find it increases selectivity and volume without distortion, practically eliminates static, gives good clear tones, both on local and distant stations. I would recommend the use of the Aer-O-Limitator to every radio owner to get the best reception from his set."

FREE TRIAL
Make this thrilling test at our risk! Install an Aer-O-Limitator (Ground Antenna). Leave your old overhead aerial up. Try out on a night when static is bad. If you do not get a wonderful improvement in freedom from static, greater selectivity and clear, sweet tone without interfering noises, if you can't get good reception on stations that are drowned out by static on your old aerial, you need not pay us a red cent for this test. Send coupon at once for scientific explanation of Aer-O-Limitator (Ground Antenna) proof of performance and our exclusive iron-bound guarantee and remarkable Free Trial Offer.
CURTAN MFG. COMPANY
Dept. 927-M
154 E. Erie St., Chicago, Ill.

Rush This Important Coupon

CURTAN MANUFACTURING CO.,
154 E. Erie St., Dept. 927-M
Chicago, Ill.
Please send me at once complete description of Aer-O-Limitator with details of guarantee, Scientific Proof and FREE TRIAL OFFER.
Name.....
Address.....
City.....
State.....

Electricity

Learn in Los Angeles. Thoroughly practical course prepares young men, 18 and over, for technical and executive positions. Unlimited opportunities in California for continuous advancement. 32 instructors. Unexcelled equipment. 23rd successful year. 17,000 active graduates. Highest Type Training. Recognized by Electrical Industry. Nominal Entrance Requirements. Employment Service during and after training. California spending \$100,000,000 in electrical development. Large, illustrated catalog sent Free, Postpaid. Dept. R.N.
NATIONAL ELECTRICAL SCHOOL
4004 S. Figueroa, Los Angeles

RADIO PANELS
BAKELITE—HARD RUBBER
Cut, drilled, and engraved to order. Send rough sketch for estimate. Our Complete Catalog of Panels, Tubes and Rods—all of genuine Bakelite or Hard Rubber—mailed on request.
STARRETT MFG. CO.
520 S. GREEN STREET - CHICAGO

SHORT WAVE KIT

Some of the best entertainment of the air is broadcast on the short waves by many powerful stations. There is no longer any reason why all should not receive these excellent programs from all over the world. The Dresner Short Wave Coils, which efficiently cover a wave band of 16 to 210 meters, makes reception easily obtainable for all. Complete kits of coils, and instruction book, only \$3.50. If your dealer cannot supply you call on us direct, or if you so desire we will send the complete kit C. O. D.
DRESNER RADIO MFG. CORPORATION
642 Southern Boulevard - Bronx, N. Y.

DOLLAR
SPEAKER FILTER
Relieves speaker of plate DC (180 to 250 volts). Complete Protection. One dollar postpaid.
Craftsman Radio Products
9 Orchard St., Newark, N. J.

Build a Daven Television Receiver

Complete Essential Kit, \$60.00

THE first complete kit. Furnished with either T-24, T-36 or T-48 Scanning Disk, Motor, Bushing, Rheostat, Daven Television Tube, 3 Complete Stages of Daven Television Amplification and Instructions for Building.

Daven Television Receiver, Complete, including Television Tube—\$100.00 (Less amplifier Tubes.)

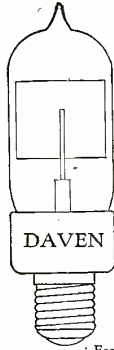

DAVEN TELEVISION APPARATUS

Daven Television Scanning Disks	Each
24 apertures (T-24)	\$ 5.00
36 apertures (T-36)	7.50
48 apertures (T-48)	10.00
Daven Special Television Amplifier (3-T)	12.50
Daven Special Television Amplifier (4-T) for Two Hi-Mu tubes and two power tubes (171, 210 or 250 types)	17.50
Daven Television Tubes—20 to 80 milliamperes—Striking voltage 150. Plate 1 1/2 x 1 3/4	12.50
Daven Television Motor	25.00
Daven Bushing to fit 1/4, 3/8 and 1/2 inch motor shafts	1.00
For 48 aperture disk	3.50
Daven Rheostat	3.50
Daven Television Photo Electric Cell 1 3/4-inch bulb	20.00
Daven Television Photo Electric Cell 3-inch bulb	37.50
Daven Resistor Couplers:	
1st stage No. 411x D-411xx	
2nd stage No. 422x D-422xx	
3rd stage No. 433x D-433xx	
x Glastors are used for resistance	2.25
xx Super Davohims in Plate and Glastors in Grid	4.65
Daven Mu-20 Tubes for Amplifier Stages	2.25
Daven AC-71 for output tubes in series with television lamps	3.50
Daven AC-70 (brighter illumination)	9.00

Write for Television Booklet

THE DAVEN CORPORATION
Amplification Specialists
161 Summit Street Newark, N. J.

this manner, if there is a slight variation in one or both shafts, the distances on the panel may be corrected; so that the dials will fit exactly over the shafts once they are fastened on the panel.

In order to cut the holes for the dial windows, it may be necessary to drill several small holes around the circle which is shown in the dial template, and knock out the center; unless you have handy one of the small circular saws which may be fastened in a drill. However, the circular saw is much simpler; as it will cut a circle in bakelite in short time and with little effort. These small circular saws are available in various diameters, and may be obtained in any hardware store. Any set builder may be recommended to use one, in preference to making holes with the old-style panel-cutter.

After all the wiring has been completed, the panel supporting the dials, the rheostat (R2), the volume-control resistor (R9), and switch (SW), may be placed against the baseboard after the shaft of the condenser has been introduced in the bushing of each one of the dials. This locates the panel exactly and the supporting screws, which hold the panel to the baseboard, may be located accurately after the condenser shafts have been fastened to the dials and the dials have been found to turn true and easily. Connections may then be made to the volume control, rheostat and switch, which are the only apparatus mounted on the panel.

BATTERY CONNECTIONS

It will be noticed that a 12-wire cable is used, although only ten wires are required for the operation of the set from batteries. The two extra wires, however, are for use when it is desired to operate the set from a power unit. In this case it is possible to light the filaments of the two 171-type tubes, used in the push-pull amplifier, with alternating current from the 5-volt winding, which is generally provided on a good "B" power unit for use with a power tube. If the set is operated on batteries, or if it is not desired to light the filaments of the 171-type tubes with A.C., then these two wires are left open.

In the operation of the set, it will be found that the voltages given for the various circuits are about correct; however, one may find it sometimes preferable to use slightly more than 45 volts on the screen-grids of the tubes.

Home Radio Constructors

(Continued from page 247)

immediately I picked up PCJJ at Hilversum, Holland, with remarkable volume for such a small set. I spent the rest of that evening listening to their program.

The next evening, I grounded the far end of my antenna to see what effect it would have on the set. Reception was increased 50%. PCJJ at Hilversum, SSW at Chelmsford, PCLL, Kootwijk, as well as KDKA, 2XAD, 2XAF, 2XE, 2XAL, and WLW, came through splendidly. I have written to most of the above stations for verification.

By mounting a small grounded shield across the front of the variable condensers, much of the hand-capacity is reduced, although it is not entirely eliminated.

I am using 67 1/2 volts of "B" battery, and two dry cells hooked in parallel for the "A" supply. If I increase or decrease the "B" supply, or use a "C" battery, reception is not so good.

A great little set. I wouldn't take a thousand dollars for it. Congratulations to the originator.

THOMAS L. SIGLIN, JR.
23 Norwich Avenue, Providence, R. I.

Please say you saw it in RADIO NEWS.

EXCELLO Radio Consoles

A new console designed for RADIOLA MODEL 18 or other receivers, either A.C. or D.C.



Excello Console Model R 43

Receiver compartment is a sliding drawer 29 in. x 9 1/2 in. x 12 in. deep. Ample room in speaker compartment for cone speaker and eliminator. Cabinet, walnut throughout, with fancy butt walnut veneer doors. At your Dealers, or write for complete catalog of full line.

EXCELLO PRODUCTS CORP.
4832 W. 16th St., Cicero, Ill. (Suburb of Chicago)
Pacific Coast representative—Pacific Sales Corporation, 426 Larkin Street, San Francisco, Calif.

BIG CATALOG FREE DISCOUNTS TO RADIO DEALERS

SET BUILDERS!

Get our new Fall Catalog now. Huge fresh stocks of standard Radio Parts, Sets, Kits ready for quick shipment at lowest rock bottom wholesale prices to Dealers, Set Builders and Agents. Write for free copy NOW.

BARAWIK COMPANY Dept. 899C Chicago, U.S.A.

MAIL COUPON FOR FREE COPY

Your Name.....
Address.....
City.....State.....

DEPENDABLE "B" BATTERY POWER

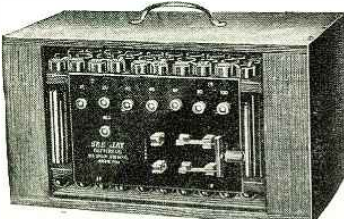

100 Volt Edison Element. Non Destructive, Rechargeable "B" Battery with charger. Shipped dry with solution, \$12. 140 Volt with charger, \$17. 180 Volt Power Unit with Trickle Charger, \$24.00. Free sample cell. See how it operates.

SEND NO MONEY—PAY EXPRESSMAN
Write for our Free Illustrated 24-page Booklet
SEE JAY BATTERY CO., 915 Brook Ave., New York

THIS NAME IS YOUR GUARANTEE

Bought Your New Dynamic Speaker Yet?

WELL, when you do, look for the Elkon Rectifier—you'll find it on good dynamic speakers about in the position shown above—no matter whether in sets, cabinets or separate units. You can't fail to recognize it, by its solid, husky appearance.

For your own protection make the dealer show you the Elkon name plate on the end of the rectifier.

ELKON RECTIFIERS
Standard equipment on the better DYNAMIC SPEAKERS, 'A' ELIMINATORS and BATTERY CHARGERS

FREE RADIO CATALOGUE

To Dealers—New, illustrated 1928 Wholesale Radio Catalog gives lowest prices on accessories, kits, packs, parts and sets. Features master-built single control radio sets for both battery and all-electric operation. Full showing of "A" and "B" Eliminators and thousands of other great values. Write on business letter-head for this free book today.
HAMILTON-CARR RADIO CORPORATION
711 West Lake St., Dept. 396, Chicago, Ill.

On the Short Waves

(Continued from page 254)

dyne set of the L2 type under my directions. This set is now located at the opposite side of Tientsin, among the lumber yards, and there is no iron structure in the vicinity. With this receiver we have also been able to tune in Khabarovsk on the loud speaker.

On my own set I get more volume from this station on 60 meters wave when using the loop instead of the usual aerial. Since May I have not been able to get this station, but this must be due to summer conditions because it is now difficult to get even Japan.

I thought that perhaps the programs of the Khabarovsk station were re-broadcast from the station at Vladivostok which operates on a wavelength of 450 meters. I therefore chose an evening on which station RFM was being received very clearly and noted down the exact time; the voice and other peculiarities of the opera "Demon" which was being broadcast and asked the station to verify my reception, also whether it was not perhaps re-broadcast from Vladivostok. The answer which I am inclosing, confirms my reception and shows you that it was the original transmission of RFM.

I have just learned of another Ultradyne owner here who has been able to get RFM on his set with carphones. Why is it that only Ultradyne receivers get short waves?

(Baron) P. D. VON HOYNINGEN-HUENE,
c/o Boediker & Co., Tientsin, China.

We consider it possible, after consultation with Mr. R. E. Lacault, designer of the Ultradyne, that the 60-meter signal of this powerful station beats with a harmonic of the set's oscillator to produce an intermediate frequency. Have any other super-heterodyne owners noticed this effect?

TRANSATLANTIC TESTS

Editor, RADIO NEWS:

I am a very interested reader of your newly-created short-wave page. This is exactly the kind of thing that short-wave DX hunters have wanted for a long time. Among the numerous stations which have been mentioned, however, I have not seen GBS, of Rugby, England. I have not had much opportunity of observing the times at which this station operates, but I have received its signals on a wavelength of approximately 24.9 meters at 12:15, 1:15, 2:15, 3:15 and 5:15 P. M., Eastern standard time.

This station usually transmits code signals beginning on the hour and lasting until fifteen minutes after the hour, when they read lists of words and announce that they are testing with someone in New Jersey. After reading the lists, they again transmit in code. I have heard them every day of the week except Sunday from February to April of this year. It is quite possible, however, that they are still broadcasting, but I have had no opportunity to listen for them since April. (This was a test, undoubtedly, to determine the feasibility of relay broadcasting across the Atlantic.)

In regard to Ferris W. Fitzpatrick's inquiry in July RADIO NEWS, I wish to say that the station which repeatedly calls, "Hello, Boston" is undoubtedly the Dutch short-wave station PCLL, located in Kootwijk, Holland. Mr. Fitzpatrick has evidently misunderstood it, for the station is really calling "Hello, Bandoeng," with whom it carries on a telephone service. The station which comes in at 17 on Mr. Fitzpatrick's dial is possibly the station at Bandoeng, Java.

WILLIAM F. FELL,
Phoenixville, Pa.

MORE SHORT-WAVERS

Editor, RADIO NEWS:

Regarding Mr. Fitzpatrick's query about a short-wave transmitter calling "Hello, Boston," I can assure him that he mistook this for "Allo, Bandoeng." The transmitter calling was PCLL, Kootwijk (pronounced "Coatvake") and the station called was ANII, Bandoeng (Radiodienst, Java) who operates on exactly 17 meters.

There are one or two additions to the list: JFW, St. Assise (near Paris, France) 24.50 meters; ANE, Bandoeng, Java, 15.93 meters; 2BL, Sydney, Australia, 32.50.

Reception conditions in England have been very bad lately; 2XAF's average strength R2 to R3.
E. T. SOMERSET,

HEARS AFRICAN REBROADCAST

Editor, RADIO NEWS:

With my short-wave set, I am able to pick up many stations, both code and broadcast, all over

the world such as FOA42, Capetown, South Africa, rebroadcasting 2XAF's program on short waves, PCJJ, FL, 5SW every night, and many others in Europe and Asia.

I use only three tubes, an aerial about 125 feet long, and seventeen half-inch pipes, six feet long, in a circle for a ground. The output of the set is often put through a two-stage power amplifier which uses two 5-watt tubes, with 8 volts through a resistor for filament and 350 to 550 volts on the plate. I use this mostly on PCJJ and 5SW as entertainment when we have company and the modulation is as good as most up-to-date stations on the longer waves. I am a graduate of the National Radio Institute and a member of the A. R. R. L.

P. J. AUBIN,
46 Center St., Putnam, Conn.

A VETERAN BEGINNER

Editor, RADIO NEWS:

Although I am 68 years old, I have recently become interested in radio construction, having made a crystal and a two-tube set; but I am not satisfied with what I can get on them. So I am going to change my two-tube into a four-tube set and also build a short-wave receiver. Enclosed find ten cents in stamps for postage on Blueprint No. 58, the "Junkbox Short-Wave Receiver." I have been told that I would be able to get nothing but code messages on it, but I am going to try it, just the same. "Never too old to learn."

W. K. ALLEN,

2145 St. James Ave., Cincinnati, Ohio.

(Three thousand inquiries for blueprints of this set in the first month since its publication indicate that it will surpass the popularity of the "S. W. Broadcast" receiver published in April. The enormous demand for these short-wave sets indicates that radio fans have found a new source of interest.)

FINDS RECEIVER "FLEXIBLE"

Editor, RADIO NEWS:

I am taking this opportunity of thanking you for your new feature, "On the Short-Waves." It is both helpful and interesting, and furnishes much needed data to the short-wave enthusiast.

I have had the pleasure of building the RADIO NEWS Short-Wave receiver described in the April, 1928, issue. On the short waves I have logged such stations as POZ, 5SW, PCJJ, 1AX, and many others. The set is equally efficient on the long waves. Thank you for this excellent receiver.

L. E. BALCOM,
294 Summer St., Malden, Mass.

THE AFRICAN MYSTERY

Editor, RADIO NEWS:

I noticed in the July issue of RADIO NEWS, under the short-wave section, some news about a station heard by South African listeners. I have heard this station calling "Hello," on three different occasions, and each time between 5 and 6 P. M., Eastern standard time. I should say the wavelength was near 26 meters, since it came in very near 5SW, but much lower than PCJJ, on 30.2 meters.

The signal strength is good, and I can use a loud speaker with three tubes. All conversation is in French and no music was played.

I would appreciate any information as to the location of the unknown station.

R. N. VANDERWARKER,
Taunton, Mass.

A SPANISH STATION?

Editor, RADIO NEWS:

I am certainly glad to find that you have added a short-wave section to RADIO NEWS. This is something I have been hoping to see in the magazine for a long time.

I have constructed a short-wave set, using homemade coils, chokes, etc., with which I am getting good results. I recently picked up a station right above 2XAF which announced in Spanish. I should say they were operating on about 33 to 36 meters. I do not know where this station is located. If anyone can identify the station for me I would appreciate it. I have been reading your magazine for a long time and have not found a better one.

PAUL B. LOVEGREN,
Midwest Amateur Radio League, Chicago, Ill.

RECEPTION IN THE TROPICS

Editor, RADIO NEWS:

I think it may be of interest to you to know that I am enjoying every night the programs of 2XAF or 2XAD, KDKA (5SW) Chelmsford, and other less powerful broadcast stations on the short waves. I have also heard station WRNY on 30.9 meters several times during the past week.

Philips' radio has not reappeared so now

Please say you saw it in RADIO NEWS.

TELEVISION IS HERE

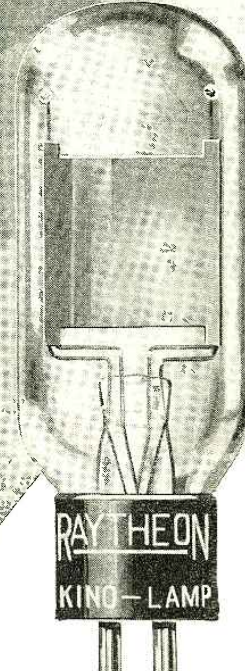

RAYTHEON
KINO-LAMP

TELEVISION is now an accomplished fact.

Experimenters will welcome the Raytheon Kino-Lamp, the first television tube developed commercially to work with any system.

Uniform glow over the entire plate, without the use of mirrors or ground glass, gives it perfect reproduction qualities.

Kino-Lamp is the latest achievement of the Raytheon Laboratories which have made so many original contributions to radio science.

Write for information
RAYTHEON MFG. COMPANY
Cambridge, Mass.

Raytheon Foto-Cell

Available in both hard vacuum and gas-filled extra sensitive types—each in two sizes. Write us for special specifications.

Raytheon KINO-LAMP

HUMOR, COMIC ART, AMUSEMENT, PUZZLES, CONTESTS, ENTERTAINMENT, WIT.

TIDBITS

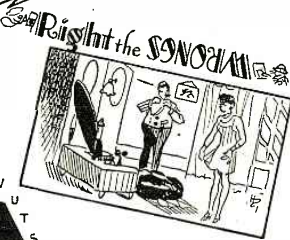
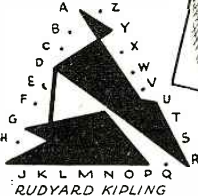
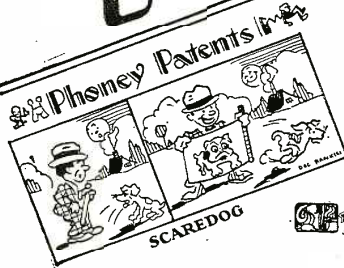

NEW ILLUSTRATED OVER \$150.00 IN PRIZES EACH ISSUE CONTESTS

In all the World
THERE IS NO LOUDER SPEAKER LIKE THIS

young married woman

POPULAR MECHANICS, FEB. ISSUE, OZARKA, ADV.
LIBERTY, MAR. 5th ISSUE, ZONITE, ADV.
SUBMITTED BY ART HAMM, MILWAUKEE, WIS.

TIDBITS is new—is like no other magazine! A long procession of widely diversified topics created for your enjoyment parade before you thru its many pages. Namystics Phoney Patents, Right the Wrong, Advertwisters, Show Me, News Blunders, CooKoo Nuts, Radiocrostics—each of these is a new form of entertainment designed to help you while-away many pleasant hours. Pages of spicy illustrations all drawn by French artists. Zestful tales and jokes. There is a million dollars' worth of laughs in each issue of this fifteen-cent magazine. Go to your newsdealer now and obtain your copy of this new, different magazine of mirth.

the 15c copy
At all Newsstands, or Write Direct to
EXPERIMENTER PUBLISHING CO.
230 Fifth Ave., New York, N. Y.

Show Me!

PLANNING A TRIP TO EUROPE

My Maryland, my native home,
In Rain or Shine I'll ne'er forget,
Nor Lovely Lady Rosalie,
And Rio Rita—gay Coquette.

But now I must Keep Shufflin' on,
For soon I'll be for Paris Bound;
Parisiana I must see—
Artists and Models all around.

News Blunders
THE BIRTH OF THE NATION

BIRTH CERTIFICATES ARE RECORDED IN THE CITY OR TOWN-CLERK'S OFFICE WHERE THE BIRTH OCCURS.—
WATERTOWN (N. Y.) PAPER.
SUBMITTED BY F. A. SMITH TROY, N. Y.

CooKoo-Nuts

"THE MISSING LINK"
BY L. A. CLARK, OTTAWA, CAN

Radiacrostics

THIS ISSUE'S \$5.00 PRIZE WINNER

WEMC WE ELIMINATE MENTAL COBWEBS

SUBMITTED BY MRS IRIS L TOND, YONKERS, N.Y.

and I wonder if the new location at Hilversum, where the new station is built, will be more powerful than at Eindhoven. My set is a 3-tube Schnell circuit with several improvements of my own. It has a range of from 20 to 44 meters and is as clear as a bell, with good volume on the loud speaker when tuning in the high-power stations. As soon as I receive new material for building sets I will try out the Radio News circuit and inform you of the results.

C. KRUSE,
Cali, Colombia, South America.

VERIFIED RECEPTION

Editor, RADIO NEWS:
In response to your request for short-wave data, would say that I have the following information which I have gathered from actual reception, supplemented by verifications from the stations themselves:

PCLL, Kootwijk, operating on 18.1 meters, transmits every Tuesday, Wednesday and Thursday from 12 o'clock noon to 1:20 P. M. Eastern daylight-saving time.

2NM, Gerald Marcuse's station at Caterham, Surrey, England, on 32.5 meters, transmits Sundays 2 to 3 A. M., and 1 to 3 P. M. He is on the air again on Wednesdays and Fridays from 6 to 8 P. M., Eastern daylight-saving time.

Station PCJJ, Eindhoven, Holland, transmits Tuesdays and Thursdays from noon to 4 P. M.; Fridays from 8 P. M. to midnight, and sometimes on the same hours on Wednesdays. This station used to transmit on 30.2 meters, but because of code interference, according to recent letters from them, they have shifted into the 31.4-meter channel, the same wavelength as 2XAF.

SSW transmits every day from 2 to 7 P. M. on 24 meters. Good loud-speaker reception may be had about 3 days a week on this station.

Station 2FC, Sydney, Australia, on 28.5 meters is received approximately two mornings a week, Mondays and Thursdays, between the hours of 6 and 8 A. M., Eastern daylight-saving time.

These programs are received, using a receiving set practically identical to the one Kendall Clough recommended in the October, 1927, issue of RADIO NEWS.

The station heard by Robert Sprague of Hanover, N. H., of which he writes on page 91 of your July issue, was undoubtedly PCJJ, Philips Radio, Eindhoven, Holland. Their announcement in Spanish is "PCJJ, Philips Radio, Eindhoven, Hollanda." When he heard same they were transmitting on 30.2 meters, but this is now changed as above.

GEORGE E. MORCROFT, JR.,
Pittsburgh, Pa.

FOR DAYLIGHT RURAL PROGRAMS

Editor, Radio News:
For distant, daylight and summer-time reception, the short-wave is far ahead of the regular broadcast band. On the short-wave converter, the circuit of which was published in the March issue of RADIO NEWS, I have heard plainly over SSW the striking of Big Ben in London at 6 P. M., E. S. T. During the daytime, when I can get no stations on the long waves, I can often pick up several stations on the short waves, among which are NAA, KDKA, WABC and WGY.

Located as I am, such a great distance from all powerful broadcast stations, were it not for the short-wave stations I would not be able to pick up any programs with any regularity in the summer season until about 8 P. M. From 5 P. M. the programs from WGY and KDKA are broadcast simultaneously over long and short waves and the short waves come in strong here, while the regular waves cannot be heard until much later in the evening. Under favorable conditions, I believe I can hear 2XAD and 2XAF, of Schenectady, N. Y., any time during the day or night. I heard 2XAD very plainly Sunday at 2 P. M., E. S. T. Signals from these stations are practically free from static. Time signals from NAA come in with good volume at noon, as well as at 10 P. M.

Many of the rural and country districts are almost cut off from good radio programs during daylight in the summer time, on account of being so far away from high-powered stations. These districts can be easily reached through powerful short-wave stations. I believe that the entire United States could have available for the year around, day and night radio programs through the proper location of a dozen high-powered short-wave stations.

I. LEE GRAY,
Sylvanus, Va.

(It is too early to plan definitely any such a scheme; for there are many holes in the radio blanket which a high-power short-wave station casts over the area in which it is heard. However, there is little doubt that in the future short waves will give a program service much more extensive than they do at present.—EDITOR.)

MASTER VOLTAGE CONTROL

This voltage regulator (patent pending) is a necessity on all A-C sets. It protects A-C tubes from burning out by reducing excessive line voltage to the proper value. Anyone can install it. Requires no guesswork in setting for the proper voltage. Has no moving parts, therefore nothing to wear out or get out of adjustment.

NO TOOLS NECESSARY

Simply call up the power company in your district and ascertain the maximum line voltage. Plug your A-C set into the marked outlet of the MASTER VOLTAGE CONTROL to correspond to that line voltage. These various line voltages are clearly indicated so that the proper setting may be had. No voltmeters, no tools or a service man's time is required for installation. Once installed it requires no further attention. To get the proper life out of A-C tubes and keep them from burning out use a MASTER VOLTAGE CONTROL.



PRICE \$2.50

At your dealers or write us.

MASTER ENGINEERING CO.

124 South Michigan Ave., Chicago, U. S. A.

Six Tube Radio

\$25.00

30 Days Free Trial

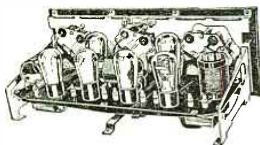

You run no risk. Try it in your own home for volume, selectivity, distance, and tone. If not perfectly satisfied, return it. \$25.00 model operates from batteries, or if preferred we have

A. C. Radio \$50.00

operates from electric light socket. No batteries or eliminators necessary. Also sold on 30-day Free Trial. Write today for FREE BOOKLET.

VIKING RADIO LABORATORIES
435 North LaSalle Street, CHICAGO

SCOTT WORLD'S RECORD SUPER 10

Build the 9,400-mile receiver. Listen in on all the world. Easy and economical to construct. Results guaranteed. Write today for free circuit diagram, parts list and copies of long distance reception verifications.

SCOTT TRANSFORMER COMPANY
4446-4448 Ravenswood Ave. Dept. L Chicago

FREE RADIO GUIDE

BIG NEW FALL CATALOG—4000 items Shows the latest A-C circuits, the newest ideas in radio at startling low prices. Get the sets and parts you want here. Save money. The best in parts, kits, complete factory-built sets and supplies. Orders filled same day received. Write for free copy now! Standard discounts to dealers, set builders, towns.

BARAWIK CO., Dept. 809A CHICAGO, U. S. A.

Insure your copy reaching you. Subscribe to Radio News—\$2.50 a year. Experimenter Publishing Co., 230 Fifth Avenue, N. Y. C.

AN ENERGETIC BEGINNER

Editor, RADIO NEWS:

I have been rather interested in radio activities since last December. I have built four small DX receivers, and when the Beginners' page came out, I thought I might learn something more about radio. I have been learning all I know from RADIO NEWS, as it is all that I can buy at home.

Please get me in touch with boys of my own age, thirteen, if possible. I would like to have, if possible, blueprints Nos. 54, 55, 56, 57 and 58.

HAROLD BROWNE,
R. D. 27 (Richford), Ithaca, N. Y.

SWITZERLAND TO GEORGIA

Editor, RADIO NEWS:

This evening (July 3) between 6:30 and 8:10, E.S.T., I heard a station speaking the German language, or something very similar to it. As near as I could make out, the call was EH9XD, but not knowing the language, I can not say for sure. The wavelength was about 32 meters. WGY, KDKA and WABC come in with loud-speaker volume on three tubes. I am working the "fringe howl" out now. Am using indoor antenna pointing north. Please confirm my report of reception if possible.

W. S. KNAPP,

Box 10, Route 4, Atlanta, Georgia.

(Unfortunately, we have no facilities for confirming reception; and most of the short-wave fans, owing to the extremely experimental nature of short-wave broadcasts, will have to rely on the pleasure of the reception itself without confirmation. However, EH9XD is Zurich, Switzerland, one of the well-known short-wave broadcast stations of the world.)

STANDARD-FREQUENCY TRANSMISSIONS

Experimenters who have wavemeters to calibrate will follow with interest the schedule of the Bureau of Standards, which sends a set of signals on each of eight selected frequencies once a month. From these transmissions very complete calibrations may be made. Full instructions are contained in the Bureau's circular No. 171, which it sends upon request.

The wavemeters of transmissions for the next three months is as follows: frequencies of the signals in kilocycles (and meters beneath in parentheses) opposite the time, which is given as Eastern Standard:

P. M.	Aug. 20	Sept. 20	Oct. 22
10:00 to 10:08.....	125 (2400)	300 (1000)	650 (461)
10:12 to 10:20.....	150 (2000)	350 (857)	750 (400)
10:24 to 10:32.....	175 (1714)	400 (750)	850 (353)
10:36 to 10:44.....	200 (1500)	450 (667)	950 (316)
10:48 to 10:56.....	225 (1333)	500 (600)	1050 (286)
11:00 to 11:08.....	250 (1200)	550 (545)	1200 (250)
11:12 to 11:20.....	275 (1091)	600 (500)	1350 (222)
11:24 to 11:32.....	300 (1000)	650 (461)	1500 (200)

NUMBER OF RADIO STATIONS

How radio has grown in the world as a whole, and particularly in the United States, in the past fifteen years, is shown by these figures recently compiled by the Department of Commerce. These are the licensed transmitting stations of the world:

American Stations	Years	1913	1920	1927
Merchant ships		483	2,808	2,092
Commercial transoceanic.....		1	6	26
Commercial ship-to-shore.....		44	17	69
Commercial point-to-point and private ship-to-shore		30	71	245
Experimental		11	63	185
Technical and training school		7	42	41
Special amateur		4	59	—
General and restricted amateur		1,224	5,922	15,926
Government land (all classes)		77	262	333
Government ship		229	1,312	1,203
Broadcast		—	—	694
Foreign				
Commercial and Government land (all classes)		347	977	1,373
Government ship		1,237	705	2,172
Commercial ship		1,390	5,140	10,276
Broadcast		—	—	800

The number of foreign amateurs is not given; but it may be estimated at five or six thousand, principally in the British Empire, Sweden, Finland, France, Argentina and Uruguay. In most other countries the laws are quite unfavorable to amateur

Please say you saw it in RADIO NEWS.

LEARN RADIO and find

Good Pay from the Start, Rapid Advancement and Phenomenal Success in A Life Profession of Fascinating Brain-work.

You Can Learn At Home!



R.L. DUNCAN, Director.

Here is your big opportunity! Our graduates are earning big money as radio designers, as radio executives, in broadcasting work, as skilled service men and radio dealers. We have trained thousands to become successful radio operators on ships and in shore stations. And now opportunity is knocking at your door. Are you going to plod along at a thirty-five dollar a week job when REAL MONEY is waiting for you in radio?

A New Course

After years of experience, the Radio Institute of America has evolved a new and revolutionary course in radio—right up to the minute and abreast of the most recent developments in the radio industry.

It starts with the very fundamentals and takes you through every phase of radio—right through television, photoradiograms and airplane radio equipment.

The instruction is the work of radio experts, and its clearness and simplicity are such that you can master every point with ease. You take examinations—your papers are corrected and all your questions answered by men with years of radio experience.

A-1 Equipment

A large kit of first-quality equipment is included in the cost of the course—without extra charge—parts for making a hundred different radio circuits and the Peerless Signagraph and key and buzzer set for code instruction.

R. I. A. backed by RCA, G-E and Westinghouse

Conducted by RCA and enjoying the advantages of RCA's associates, General Electric and Westinghouse, the Radio Institute of America can and does give the finest radio instruction obtainable anywhere.

Home Study Course



Moreover, you can STUDY AT HOME—when you please and as long as you please.

This new booklet describing the course is now ready. If you want to learn more about the lucrative and fascinating profession of radio send the coupon now for your copy.

RADIO INSTITUTE OF AMERICA
Dept. A-9, 326 Broadway, New York City

RADIO INSTITUTE OF AMERICA
Dept. A-9 326 Broadway, New York City

Dear Mr. Duncan:

Please send me your new catalog. I want to know more about your new radio course.

Name.....
Address.....
City.....State.....

HAMMARLUND'S

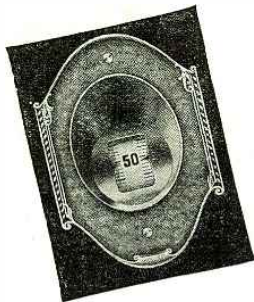

New Knob-Control DRUM DIAL

A richly embossed bronze front of graceful design and an operating mechanism that is a delight to the mechanically informed. Controlled by a knob that can be placed in any position on the panel for attractive balance. No lost motion or backlash. The dial degrees are illuminated from the back.

Write for Hammarlund Folders

HAMMARLUND MANUFACTURING CO.
424-438 West 33rd Street New York

For Better Radio
Hammarlund
PRECISION
CONDENSER

Set Builders! Dealers!

FREE Big Catalogue

Send postcard for new catalog and discount sheet. Hundreds of bargains in latest **Electric Phonographs**, pick-ups, turn-ables, dynamic sets, kits, parts, and other parts. **Shield-Grid** kits, **Television** kits and parts, coupling impedances, shields, **Short-wave** sets, kits, parts, and other parts. **Power Packs**, all kinds, including 250-tube and push-pull circuits. Van-Ashe has everything, at big discounts ready for 12-hour shipment.

Van-Ashe Radio Co.

210 North 10th ST. ST. LOUIS, MO.

XL Products

Model "N" VARIO-DENSER

Used in Every High Grade Circuit or Receiver Today!

MODEL "N" VARIO-DENSER—Micrometer adjustment easily made, assures exact oscillation control. Quick, easy tuning, more volume, clearness and stability. Capacity range 18 to 20 micro-microfarads. Price \$1.00.

Model G

Made in 3 variable capacity ranges; price, \$1.50.

FREE Big new up-to-date book of wiring diagrams of all leading circuits. Write today for copy.

XL Radio Laboratories

Dept. A, 1224 Belmont Ave., Chicago, Ill.

radio; and in many it is necessary for the few hams to keep under cover.

The number of radio receivers in the United States is now estimated at 12,000,000, of which about 8,000,000 are commercially-manufactured sets of several tubes; and others home-made, or obsolete models of which no factory report is available. This is undoubtedly greater than the number in the rest of the world put together. Great Britain is second with nearly two and a half million licensed listeners.

Reviews of Radio Literature

(Continued from page 249)

are explained. This is followed by an explanation of the use of filter condensers, in which the author describes the methods employed to determine the effective capacity of various series and parallel condenser combinations. Voltage-distributing resistors, sometimes called the "heart of the power supply unit," also receive thorough treatment covering the calculation of values, power rating, types of resistance, voltage drop and special applications.

The concluding chapters are given over to general considerations covering line-voltage control methods, "motorboating," voltage-regulator tubes, line-noise problems, etc. Several complete power-unit combinations are suggested by the author in his concluding chapter; one each of the 280, 281 half-wave, 281 full-wave, and Raytheon types of supply unit, as well as a 220-volt D.C. unit.

The experimenter, the broadcast listener, the radio service man and the student in radio, each will find this treatise a valuable and useful addition to his library of radio information.

PRINCIPLES OF RADIO COMMUNICATION, 2nd Edition, by J. H. Morecroft, published by John Wiley & Sons, Inc., New York, N. Y. 6x9 inches, 988 pages, cloth. Price \$7.50.

The original volume by Professor Morecroft has for years been the standard reference book of the radio engineer and the student of radio. A pioneer in a new field, Professor Morecroft is perhaps better fitted, both by training and by actual experience, to prepare such a book than any other man. His introduction to the new edition briefly tells the story as follows:

"When the first edition of the book was in preparation there was very scant literature from which to draw, so that most of the data submitted in verification of the theory was laboriously obtained by the author himself. In the intervening years prolific publication on radio subjects has taken place with the result that this edition is more thorough and complete than the first. The data on the various phases of the radio art have become so plentiful that but a small part could be incorporated in this volume; to make the text as useful as possible, however, references have been given to most of the outstanding articles which have appeared in English during the past decade.

"The new material incorporated in this edition so increased the size that it was thought advisable to delete much of the first edition. A considerable part of the chapter on spark telegraphy has been taken out, therefore, and two of the chapters of the earlier edition have been deleted. The chapter on radio measurements, and that on experiments, have been omitted; if a demand for the material of these two chapters appears it will be published as a separate volume."

Among the valuable additions which have been made to the older edition are the data on coils and condensers at radio frequencies found in Chapter 2. Chapter 4, dealing with general features in radio transmission, includes considerable new material on field-strength measurements, reflection and absorption, fading, and short-wave propagation. In the chapter on radio telephony a large amount of material on voice analysis has been added, together with data on the performance of loud speakers, crystal control, etc. Chapter 10, which deals with vacuum-tube amplifiers, has been enlarged to include screen-grid tubes, power-supply units, filters and their characteristics, radio-frequency amplification, balanced circuits, push-pull arrangements, distortionless audio-frequency amplification, etc.

Chapter 6 includes 240 pages on vacuum tubes and their uses, giving characteristic curves made from typical tubes; data on the measurement of the amplification constant of a tube; instructions for, and methods used in measuring the resistance of the input and output circuits of tubes; neutralization; a discussion of the vacuum tube as a gen-

Get Your Copy of

POPULAR CARD TRICKS

By Walter B. Gibson

Pleasant Entertainment For All

Walter B. Gibson has written what is conceded to be the most complete book of card tricks ever published. There are literally hundreds of these clever little tricks. You need not be a professional in order to work them out. There is no sleight-of-hand required. You can do any of them with little or no practice. Simple to perform—difficult to guess. Complete instructions—Hundreds of illustrations.

Once you have mastered a few of the tricks that this book contains you will become extremely popular—always entertaining. Imagine the fun you can have at a party. Just nonchalantly pick up a deck of cards and inquire if anyone has "seen this one." Then, while all attention is focused on you, do these tricks one after another to the admiration and wonderment of all.

25c

THE COPY

AT ALL NEWSSTANDS OR WRITE DIRECT

EXPERIMENTER PUB. CO., INC.

230 Fifth Avenue, New York, N. Y.

Enjoy LOUD SPEAKER OPERATION from a **CRYSTAL**

NO "TUBES" - NO "B" BATTERIES - NO COSTLY "ELIMINATORS"

WITH THE SKINDERVIKEN TRANSMITTER UNIT

Simple microphone unit provides a most effective and inexpensive way to satisfactory speaker operation. Easy to build and operate circuit.



Everybody can do this now with a Skinderviken Transmitter Unit. The unit is fastened to the diaphragm of the speaker unit. It will act as a "microphonic relay." Every time an incoming signal actuates the diaphragm, the electrical resistance of the microphone unit will be varied correspondingly and the current from the battery, in series with it and the loud speaker, will fluctuate accordingly.

Thus the problem of securing sufficient power to actuate the loud speaker is simply and adequately solved.

The results from this very novel and simple unit will astound you.

The expense of this hook-up is trifling compared to the elaborate tube circuits that give no greater actuation of the speaker.

Besides this there are many other valuable uses in Radio Circuits for this marvelous little unit. Every builder of Radio sets should have a few on hand.

LISTENING THROUGH WALLS

This Unit makes a highly sensitive detectaphone, the real thing—you listen through walls with ease. Plenty of fun and real detective work too.

CONDUCTING SOUND THROUGH WATER

Make yourself a miniature submarine signaling apparatus like those used during the war. Simple circuit with this microphone unit gives splendid results.

12-PAGE INSTRUCTION BOOKLET

containing suggestions and diagrams for innumerable uses, furnished with each unit.

P. G. MICROPHONE TRANSFORMER



A Modulation Transformer specially designed for use with the Skinderviken Transmitter Unit. Has many other uses. Primary resistance, 1/2 ohm; secondary, 55 ohms. **\$2**

FOR SALE AT LEADING DEALERS

Or Order Direct, Using Coupon Below

SEND NO MONEY

When the postman delivers your order you pay him for whatever you have ordered, plus a few cents postage.

PRESS GUILD, INC.

16-18-R—East 30th St., New York, N. Y.

R-9-28

Please mail me at once as many of the following items as I have indicated.

... Skinderviken Transmitter Units at 95c. for 1; \$1.75 for 2; \$2.50 for 3; \$3.20 for 4.

... P. G. Microphone Transformers at \$2.

When delivered I will pay the postman the cost of the items specified plus postage.

Name

Address

City

State

erator of alternating-current power, etc. Altogether it is the most complete and authoritative book on radio, as we know it today, that has yet been published.

This new edition will rightly take its place as the leading American publication on the subject of radio. It should be included in the library of every serious radio experimenter and radio student, in addition to being as the principal reference book of the radio engineer.

PRACTICAL RADIO TELEGRAPHY,

by Arthur R. Nilson and J. L. Hornung of the West Side Y.M.C.A. Radio Institute, N. Y. Published by the McGraw-Hill Book Co., Inc., New York, N. Y. 5 1/2 x 8 inches, 380 pages, cloth. Price \$3.00.

For the student who wishes to gain a knowledge of radio, the amateur who wishes to prepare for a commercial operator's license, or the commercial operator who wishes a handy reference book dealing with the latest standard commercial transmitting and receiving equipment, we recommend *Practical Radio Telegraphy* as about the best thing of its kind that has come to our attention.

The authors of this book are respectively, the director and chief instructor of this New York radio school. The book was prepared to fill the need for a reliable and well-balanced text book for use in the training of radio operators. With this in mind, only such material was used as was thought necessary to give a knowledge of radio circuits and apparatus. In a short preface the authors describe their work in part as follows:

"This book is written for radio students preparing to become radio operators. A thorough understanding of its contents will enable the reader to pass the theoretical examination given to applicants for a radio operator's license. It will also be useful to others, not interested primarily in becoming operators, but who want a knowledge of the theory and operation of radio telegraphy as used in the marine service.

"The World War changed the trend in the design of radio telegraphic equipment from spark to vacuum-tube and arc equipments. This change, which is still under way, rendered those text books written before the war obsolete in so far as modern equipment is concerned.

"Many text books on radio require that the reader be versed in elementary electricity, mathematics and chemistry. This book does not require these prerequisites. It starts with an explanation of elementary electricity and gradually builds on this knowledge until radio circuits and apparatus are understandable."

AMPERITE BLUE BOOK OF RADIO

INFORMATION, published by the Radiall Company, New York City. 5 3/4 x 8 3/4 inches, 24 pages, illustrated, paper covers, cost free.

This booklet is issued for the purpose of assisting home set builders and receiving-set owners who desire to simplify the operation of their sets by eliminating manually-adjusted filament controls and substituting ballast resistors. It explains in detail the use of the products of its publishers and gives general information on the construction and operation of a number of the popular types of receiving sets, illustrated with diagrams. The first half of the booklet is devoted entirely to a detailed discussion of the advantages of self-adjusting resistors in the filament circuit of various types of vacuum tubes, including the new A.C. tubes. The popular hook-ups given in the fast half of the booklet extend all the way from a one-tube "DX" set up to an eight-tube superheterodyne, all of which of course, are shown equipped with self-adjusting filament resistors.



MANUAL OF ENGINEERING DATA

ON ELECTRIC SET ESSENTIALS, published by the Polymet Manufacturing Corp., New York City. 8 1/2 x 11 inches, 20 pages, loose-leaf form, paper covers, cost free.

A loose-leaf booklet, intended for the use of radio engineers and manufacturer's purchasing agents, which contains all electrical and mechanical specifications on the filter condensers, grid leaks, wire-wound resistances, large and small fixed condensers, and other products manufactured by this company.

This manual gives laboratory test reports on the products manufactured by this company and presents considerable information and a number of charts of interest to those engaged in designing receiving sets and power-supply units.

Please say you saw it in RADIO NEWS.

The Name Means Everything

Strict vigilance guards the acknowledged high standards of these tubes with the result of an ever-increasing efficiency of performance.

A set of new Cunningham Tubes gives new life to your radio.

Never use new tubes with old ones—use new tubes throughout.

E. T. CUNNINGHAM, Inc.
NEW YORK CHICAGO
SAN FRANCISCO

Manufactured and sold under rights, patents and inventions owned and/or controlled by Radio Corporation of America

Since 1915 STANDARD QUALITY

OPPORTUNITY AD-LETS

Follow these advertisements every month. Reliable advertisers from all over the country offer their most attractive specials in these columns.

Classified advertising rate twenty-two cents a word for each insertion. Ten per cent discount for 6 issues, 20 per cent discount for 12 issues. Names and addresses must be included at the above rate. Cash should accompany all classified advertisements unless placed by an accredited advertising agency. No advertisements for less than 10 words accepted.

Objectionable or misleading advertisements not accepted. Advertisements for the November issue must reach us not later than September 1st.

CIRCULATION LARGER THAN THAT OF ANY OTHER RADIO PUBLICATION

EXPERIMENTER PUBLISHING CO., INC., 230 Fifth Avenue, New York, N. Y.

Agents Wanted

Big Money and fast sales. Every owner buys gold initials for his auto. You charge \$1.50; make \$1.35. Ten orders daily easy. Write for particulars and free samples. American Monogram Co., Dept. 133, East Orange, N. J.

Agents—We start you in business and help you succeed. No capital or experience needed. Spare or full time. You can earn \$50-\$100 weekly. Write Madison Products, 560 Broadway, New York.

Guaranteed Genuine Gold Leaf Letters anyone can put on store windows. Large profits, enormous demand. Free samples. Metallic Letter Co., 422 N. Clark, Chicago.

Sell subscriptions to magazines known the world over. Steady monthly income with absolutely no investment required. Hundreds of selling arguments every month. Start now. Full information sent free, no obligation. Agency Division, Experimenter Publishing Co., 230 Fifth Avenue, New York.

Agents—Steady income. Large manufacturer of Soaps, Perfumes, Toilet Articles, and Pure Food Products, etc. wishes representatives in each locality. Manufacturer direct to consumer. Big profits. Honest goods, whole or spare time. Cash or credit. Send at once for particulars. American Products Co., 1907 Monmouth, Cincinnati, O.

Books

Books, Magazines, Art Publications in French, Spanish, English. Photo novelties, samples, lists, etc., 20 cents stamps. Villaverde Co., Dept. 211, Box 1329, Havana, Cuba.

Business Opportunities

Inventions Commercialized. Patented or Unpatented. Write Adam Fisher Mfg. Co., 278 Enright, St. Louis, Mo.

Free Book. Start little Mail Order business. Hadwil, 5A-74 Cortlandt Street, N. Y.

67 Ways to Increase Income. 96-page book "Spare-time Money Handbook" contains 67 practical and complete plans to operate sparetime business. For everyone who wants more money. Price only 50c. Conrad Company, Inc., 230 Fifth Avenue, New York.

Chemistry

Learn Chemistry at Home. Dr. T. O'Connor Sloane, noted educator and scientific authority, will teach you. Our home study correspondence course fits you to take a position as chemist. See our full-page ad on page 257 of this issue. Chemical Institute of New York, 16 E. 30th Street, New York City.

Correspondence Courses

Used correspondence school courses sold on repurchase basis. Also rented and exchanged. Money-back guarantee. Catalog free. (Courses bought). Lee Mountain, Pisgah, Alabama.

Detectives

Detectives Needed Everywhere. Travel. Experience unnecessary. Particulars Free. Write. American Detective System, 2190 Broadway, N. Y.

Electricity

Electric Fun! Seventy stunts, 110 volts, \$1. Cooperco, Campbell, Calif.

For Inventors

Inventions Commercialized. Patented or Unpatented. Write Adam Fisher Mfg. Co., 278 Enright, St. Louis, Mo.

Help Wanted

National Publisher, needs agents, boys and shops to help sell great national magazines. No investment required. Big profits, sparetime work very successful. Write Agency Division, Experimenter Publishing Co., 230 Fifth Avenue, New York.

Help Wanted—Instruction

Wanted Immediately, men to qualify for Railway Mail Clerk. P. O. Clerk-Carrier Tests. \$140-\$225 month. Write Ozment Inst., 251, St. Louis, Mo.

Instruction

Learn Chemistry at Home. Dr. T. O'Connor Sloane, noted educator and scientific authority, will teach you. Our home study correspondence course fits you to take a position as chemist. See our full-page ad on page 257 of this issue. Chemical Institute of New York, 16 E. 30th Street, New York City.

Men—Qualify for railway postal clerk, internal revenue, mail carrier and outdoor positions; steady work; particulars free. Write Mokane Inst., Dept. B-32, Denver, Colo.

Men wanting railway mail, postoffice clerk, mail carrier and outdoor positions; qualify immediately. Write for list. Radley Institute, 211-B Cooper Bldg., Denver, Colo.

Read! Opportunity Ad-Lets

Who knows but that the opportunity of your lifetime may be hidden in one of them. Read them each month—they can easily be turned to earning dollars and cents for you.

Miscellaneous

Inventions Commercialized. Patented or Unpatented. Write Adam Fisher Mfg. Co., 278 Enright, St. Louis, Mo.

Save Money at Home. You can build many home necessities yourself, such as furniture, kitchen utensils, decorative material, etc., thus saving many dollars. All constructional information on hundreds of things given in 116-page book "How to Make It." Price 50c. Experimenter Publishing Co., Inc., 230 Fifth Avenue, New York.

Forms to Cast Lead Soldiers, Indians, Marines, Trappers, Animals, 151 kinds. Send 10c for illustrated Catalogue. H. C. Schlerke, 1034 72nd St., Brooklyn, N. Y.

Guaranteed Solder for Aluminum. Mail, \$1. A. N. Pierman, Behnar, N. J.

Motorcycles

Used Motorcycles. Low Terms. Also Parts, Accessories. Catalog Free. Western Motorcycle Co., 946 East 15th St., Kansas City, Mo.

Please say you saw it in RADIO NEWS.

Musical Instruments

Cornetists—Trombonists—Saxophonists—Clarinetists. Send for "Free Pointers." Mention instrument. Virtuoso School, Buffalo, 70, N. Y.

Patent Attorneys

Patents—Send for form "Evidence of Conception" to be signed and witnessed. Form, fee schedule, information free. Lancaster and Alvine, Registered Patent Attorneys in United States and Canada, 269 Ouray Bldg., Washington, D. C.

Patents—Send drawing or model of your invention for examination and instructions. Advice and booklet free. Highest references. Best results. Promptness assured. Watson E. Coleman, Patent Lawyer, 724 9th Street, N.W., Washington, D. C.

Patent Sense—Valuable book free. See Lacey's ad, page 287. Lacey & Lacey, 631 F. St., Washington, D. C. Established 1869.

Patents—Time counts in applying for patents. Don't risk delay in protecting your ideas. Send sketch of model for instructions or write for free book, "How to Obtain a Patent" and "Record of Invention" form. No charge for information on how to proceed. Communications strictly confidential. Prompt, careful, efficient service. Clarence A. O'Brien, Registered Patent Attorney, 309 Security Bank Building (directly across street from Patent Office), Washington, D. C.

Patents procured at reasonable rates with time to pay. Sales negotiated. Staff of registered attorneys and engineers. A complete service for inventors. Write for particulars. Inventors Service Bureau, Box 1648, Washington, D. C.

Patents

Inventions Commercialized. Patented or unpatented. Write Adam Fisher Mfg. Co., 278 Enright, St. Louis, Mo.

Printing, Engraving and Multigraphing

200 Letterheads and 100 Envelopes, \$1.10, postpaid. Oerman Company, Box 989, Los Angeles.

Multigraphing, two dollars thousand. Miscellaneous Printing. Mayer Rey Corporation, Monmouth, Illinois.

Radio

Buy Your B. Power Devices Direct From Factory. Send for particulars. D. L. & G. Mfg. Co., 2941 W. Lake, Dept. 9, Chicago.

Write about our efficient power devices. KIMLEY ELECTRIC CO., 441 E. Ferris, Buffalo, N. Y.

Song Poems

Song Poem Writers. "Real" Proposition. Hibbeler, Dr. N. 2104 N. Keystone, Chicago.

Wanted to Buy

Full Value Paid for Old Gold, Jewelry, Watches, Diamonds, crowns, bridges, dental gold, silver, platinum, gold or silver ore, magneto points, old false teeth. Packages returned if our offer is not satisfactory. United States Smelting Works (The Old Reliable), 39 So. State St., Dept. 16, Chicago, Ill.

90 Volt Power Unit :: \$12.75

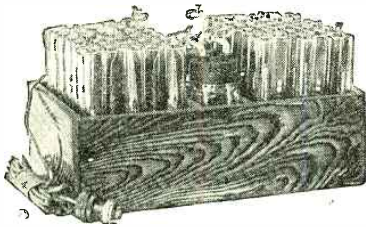

Hums, line noises, etc., positively impossible with this new advanced unit. Plug in and forget. Non-acid and noiseless. All detector and intermediate voltages plainly marked. Simpler to hook up than dry cells. Operates any type set 1 to 12 tubes. Greater volume and clearness guaranteed. If not thoroughly satisfied return after using 30 days for complete refund. Guaranteed further 2 years. For 110-120 volts A.C. 25 to 60 cycle current. 30 volts, \$12.75; 112½, \$15.25; 135, \$17.50; 157½, \$19.50; 180, \$24.00; 202½, \$26.00. Also built for D.C. current 110 and 32 volts at only \$3.00 additional, any size above. Ample stocks—same day shipments. Simply say—ship C.O.D. or write for my interesting literature, testimonials, etc.

B. HAWLEY SMITH

334 Washington Ave. Danbury, Conn., U. S. A.



HOTEL LAFAYETTE

ATLANTIC CITY, N. J.

A new and beautifully furnished fire-proof hotel situated on South North Carolina Ave., in the Boardwalk block near the Steel Pier. Where personal service, homelike surroundings and superior food abound.

Carefully selected clientele and friendly prices. Write for Booklet D.

Arthur O. Franklin, Everett L. Copp, Proprietors

M&H

Radio's largest kit supply house

ESTABLISHED 30 YEARS

We Have Complete Kits For All Circuits Now appearing or which have appeared in "Radio News" and other publications. Send for Circuit Booklet & Catalog M. & H. Sporting Goods Co. 512 Market St., Phila., Pa.

\$5.50 buys this famous cabinet!



The Incredible Sizes range from 7x18x10 to 7x30x12. Mahogany finish, \$5.50 to \$37.50. Solid Walnut, \$8.00 to \$10.25. F.O.B. Hickory. Twelve-hour service. Write for Catalog. SOUTHERN TOY COMPANY, MANFR. HICKORY, N.C.

INVENTORS

who derive largest profits know and heed certain simple but vital facts before applying for Patents. Our book Patent Sense gives those facts; sent free. Write LACEY & LACEY, 631 F St., Washington, D. C. Established 1869

I Want to Know

(Continued from page 253)

center-tapped resistor R2 is used to obtain the center point of the filament circuit of the rectifier. This resistor should be wire-wound and have a total resistance of about 40 ohms. The resistor R2 should have a similar resistance value, and be provided with a variable-tap arrangement, so that the point can be found at which the least hum is noticed in the speaker when the amplifier is in operation. The 2,500-ohm resistor R4, shunted by the 1-mf. fixed condenser C9, is used to provide the bias for the 250-type power tube. Condensers C4, C5 and C6 have a value each of 1 mf., and should be designed for a working voltage of at least 200 volts D.C., so that there will be no danger of a short circuit. The audio transformer should have a low ratio, about 2 or 3 to 1.

The output filter arrangement consists of the heavy-duty choke coil L3 and the condensers C7 and C8, which have a capacity of 2 mf. each. The choke coil should be similar in construction to the choke coils employed in the filter circuit; it too should have an inductance of about 15 henries and should have a D.C. resistance of about 250 ohms.

In constructing the power unit, straight point-to-point wiring should be employed; well-insulated, flexible, rubber-covered wire should be employed for this purpose. The apparatus should be laid out in approximately the positions shown in the schematic diagram, so that the wiring will be as short as possible. When making any adjustments on this power unit and amplifier it is necessary to turn off the electric-light current, since the high voltage produced by this unit is rather dangerous. In connecting the power amplifier to the receiver, the two terminals "P" and "B+" on the transformer T2 should be connected to the plate of the first audio-frequency amplifier tube in the receiver, and to the corresponding "B+" voltage of the power unit, respectively.

It is advisable to place two 3-ampere fuses in the primary leads of the power transformer; so that the 110-volt current will be turned off automatically if a condenser breaks down or a short circuit occurs in the power unit. In first operating the power amplifier, the resistor R3 should be adjusted so that the A.C. hum is at a minimum and a D.C. milliammeter should be placed in series with the plate lead of the amplifier tube. This meter should have a range of about 0-100 milliamperes. The amplifier should then be connected to the receiver and a signal should be received. If the milliammeter shows a very wide fluctuation when the signal is being received, the resistor R4 should be adjusted. It will be found that there is a point on the resistor R4 at which the plate current fluctuates to the minimum extent; this is the correct operating point and the tube is correctly biased. The variable output terminals for the "B" supply in the receiver should then be adjusted until the correct voltage is obtained on each of the tubes in the set.

Send for Latest RADIO CATALOG and GUIDE

NEW FALL GOODS READY

Since Radio began the Barawik Co. has been the stand-by of Radio News readers. Barawik has kept pace with radio's progress, and today offers you the latest in A-C and other radio developments. New Fall goods are now ready. Our fast same-day service on orders assures you complete satisfaction.

Pages Loaded with Bargains

The new big Barawik Radio Guide is filled with reliable information about the newest and most advanced ideas in radio development, describes and illustrates the latest improvements. It will keep you posted on what's up-to-date. It will help you to build a better set, improve your old one and make it up-to-date or buy a complete new modern one. Every radio set owner, amateur, beginner and fan should have a copy.

Lowest Prices

It will pay you to get our prices for complete parts for the popular circuits, sets and accessories now in demand. Big discounts offered to dealers, set builders and agents.

Send for Free Copy Now!

Get our new radio catalog today. Just mail the coupon and free copy will be sent you. Deal with a reliable, dependable house and get full value for your money, honest treatment and quick service.



BARAWIK CO.

Dept. 809D Chicago, U. S. A.

Mail This Coupon Now! For Free Copy

Name.....
Address.....

\$40 to \$100 a week Electrical JOBS



Guaranteed!

We are looking for more ambitious young fellows to place in well-paid Electrical jobs—men we can develop into Chief Electricians, Superintendents of Power Plants, Manufacturing and Construction, Electrical Experts, and Draftsmen. Must have grammar school education and be willing to do one part of spare time to getting ready.

A place for you in World's biggest, fastest growing business

Electricity is fascinating work. Plenty jobs, big pay, real chances for advancement. Get in touch with us immediately, and we'll get you one of these well-paid positions, under money-back guarantee of a two-million dollar institution. Write today and ask for free catalog and guarantee of Electrical job.

American School, Dept. E-685 Drexel Avenue and 58th Street Chicago

A JOB and a 50% Raise - OR NO COST!

SEND FOR NEW RADIO BOOK — IT'S FREE!

New hook-ups. This book shows how to make short-wave receivers and short-wave adapters. How to use the new screen grid tube in D. C. and A. C. circuits. How to build power amplifiers, ABC eliminators. Up-to-the-minute information on all new radio developments. It's free. Send for copy today.

KARAS ELECTRIC COMPANY

4038JA-North Rockwell St., Chicago, Ill.

Name.....
St. and No.....
City and State..... 4038 JB

ELECTRICITY EASILY LEARNED

12 WEEKS fits you for a BIG PAY JOB—no BOOKS or EXPENSES—all PRACTICAL work. Write for BIG FREE BOOK and remarkable tuition offer including FREE RAILROAD FARE. McSWEENEY SCHOOLS Dept. 76-M CLEVELAND, OHIO

6 TUBE SUPERPHONIC RADIO—\$16.95

FREE—Six tubes, tested and matched. An amazing value that can't be beat! Latest 6-tube tuned radio frequency circuit. Metal chassis, shielded. Extremely selective. Long-distance reception. Send for complete descriptive circular. Value \$60, our price \$16.95. Write today. Radio Equipment Co., D. 121, 545 S. Wells St., Chicago, Ill.



Please say you saw it in RADIO NEWS.

Houdini's Spirit Exposés

and Dunniger's Psychological Investigations

Stilled by death but a short time ago,
the voice of Houdini lives again in this
book to carry on the work so prema-
turely cut short.



This book has been written
by Joseph Dunniger, chair-
man of the Science and In-
vestigation Committee for Psychological Re-
search.

HOUDINI was deeply interested in spiritualism. He spent years in the study of this fascinating subject. When he had fully mastered every angle, he turned his attention to exposing the fraudulent practices of mediums. Mysterious voices in the air, unearthly tappings on the table, weirdly moving furniture, floating figures, hands, lights—every trick employed by mediums in order to make their séances

more realistic, Houdini was able to explain and duplicate by perfectly natural means.

With his death the work of exposing the practices of spiritualistic mediums slackened in a very noticeable degree. In consequence, mediums, each day, have grown bolder until now the voice of Houdini, as if called from the grave, has returned and can be heard to echo throughout the pages of this amazing book, "HOUDINI'S SPIRIT EXPOSÉS." Here Houdini lives again to crush the swelling number of mediums parasitically bleeding their victims of their most cherished possessions while posing in the guise of the living dead.

All should read this tremendously interesting book. The entire treatise has been written from the personal notes of Houdini—a startling exposé on one of the biggest frauds of the day. Do not fail to get your copy—112 pages—fully illustrated.

The 50c Copy

At all Newsstands or Write Direct

EXPERIMENTER PUBLISHING CO., 230 Fifth Ave., New York, N. Y.

Here's the new improved SUBANTENNA

**Easily Installed in a Few Minutes—
Guaranteed to Bring in Loud, Clear DX
Right Through Summer Static**



**STATIC
NO LONGER
CUTS UP
RECEPTION**

How This Amazing New Underground Antenna Works

It is a known fact that radio waves travel through the ground just as they do thru the air. Ground waves, however are much clearer than air waves, because air waves are more or less cut-up with static and other disturbances, while the ground is practically free of all such interference. The new improved Subantenna—a real, scientific device completely enclosed in a small, compact sealed and moisture-proof can, is buried in the ground in a vertical position. It intercepts the clear, strong, static-free ground waves and sends them up to the receiver via a shielded cable. Comparison, station for station, of reception taken from the ground with a Subantenna and reception obtained in any other way, instantly establishes the worth of this great new device.



Tested and Proved Tremendously Successful on Every Type of Set

Subantenna was put to countless tests before being offered to you. It was tried out on as many types of receivers as it was possible to obtain. In every test the new improved Subantenna exceeded all previous standards for antenna performance. It is sure to work on *your* set. It is certain to so greatly improve your reception and to so greatly increase your radio enjoyment that you would not part with this new, better antenna for twice its price if you could not get another.

Users Agree It is the Greatest New Thing in Radio

"I have a switch on my cabinet by which I can throw from an aerial to the Subantenna. For example I tune in WEAF on the Subantenna and find I have to turn down my volume control to almost a full stop away from 'OFF.' Then, reversing to the aerial, I can hear barely a sound, and this is only one night I installed the Subantenna. If it were with settling, it should be more than worth the price."—
Wm. Seymour, Newark, N.J.

Here it is—the new, improved and perfected SUBANTENNA—even better than its amazingly efficient predecessor which brought forth volumes of enthusiastic praise from thousands of critical fans. Now it's ready—the new SUBANTENNA—ready to prove its DX ability—ready to challenge any type of loop or up-in-the-air aerial—ready to challenge those who have tried to produce an underground antenna of comparable efficiency, but who can't because the features of the new SUBANTENNA which make it so superior to anything else are patented. In short, here's the ideal antenna. Loud, clear DX regardless of the season—regardless of weather—regardless of how much static there is in the air.

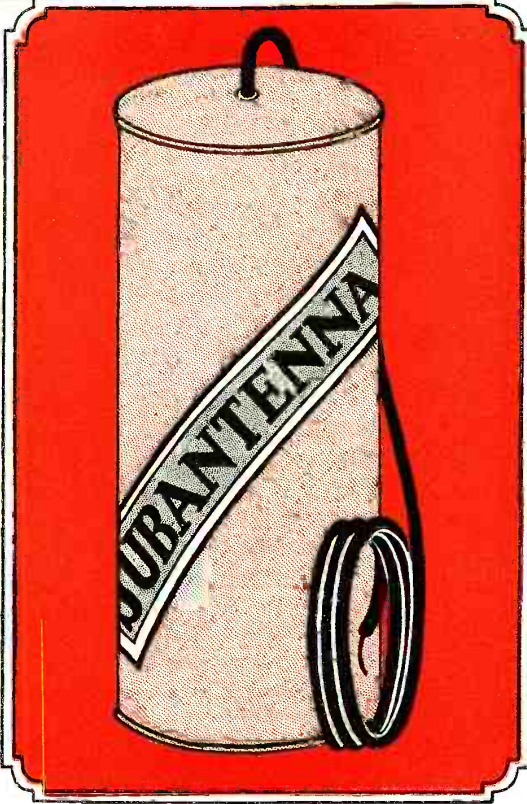

Beats Everything Else

"I am writing to tell you that last night I gave my Sub a good test and must say it has anything beat that I have ever seen and under any conditions. The stations always come in at the exact same spot, and the quality and tone are far better than obtained with the noisy overhead aerial. You had better send me some order blanks. You did send me some before but I misplaced them."

A. W. Turner, Baltimore, Md.

FREE TRIAL!



We want you to install the new, improved SUBANTENNA. Installation takes only 5 minutes. We want you to try it on your own set—entirely at our risk! Test it, try it in every way. Compare the reception it brings you, to the reception you can get with any other kind of antenna. If it isn't clearer, louder, sweeter and better in every way, this test is free.

MAIL COUPON TODAY

Clip, fill in and mail now. No obligation whatever. We'll send you full details of the new improved SUBANTENNA and particulars of our FREE TRIAL OFFER and the truly amazing tests we want you to make entirely at our risk. Mail the coupon right now . . . at once.

Cloverleaf Mfg. Co.
2711E Canal St.
Chicago, Illinois
Send me full details of the new, improved Subantenna and particulars of Free Trial Guarantee Offer.

Name.....
Street.....
Town.....
State.....

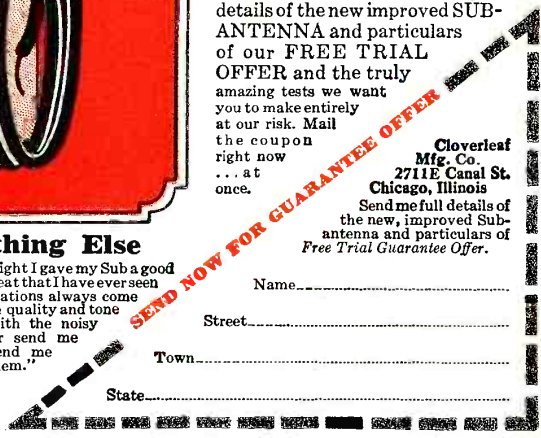

Cloverleaf Mfg. Co., 2711E Canal St., Chicago

NOW—

ABOX

Dynamic Speakers

The wall model illustrated is designed to hang in the corner. The large front ornamental baffle board and the walls of the room combine to produce the best possible acoustical effects—an exclusive Abox idea that sets a new vogue in speakers. There is a reason for this method of mounting. Write for details.

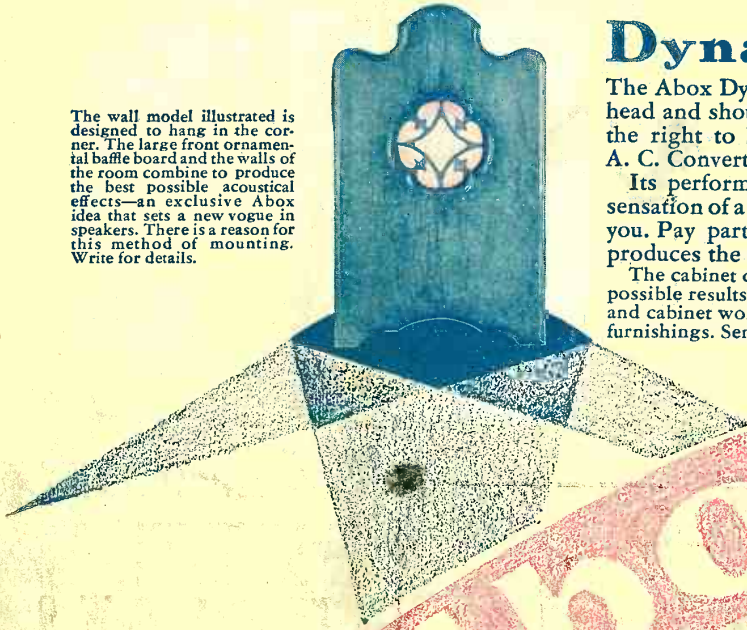

The Abox Dynamic Speaker had to pass a test that put it head and shoulders above any in the field, before it won the right to be the running mate of the famous Abox A. C. Converter—and carry the Abox name.

Its performance is a delightful, new experience. The sensation of a high order of reproduction will linger with you. Pay particular attention to the brilliant way it reproduces the low notes of the scale.

The cabinet designs are acoustically correct to produce the best possible results. Baffle boards $\frac{3}{4}$ inch thick are used. The designs and cabinet work are in harmony with the most beautiful home furnishings. Send coupon today for a descriptive folder.

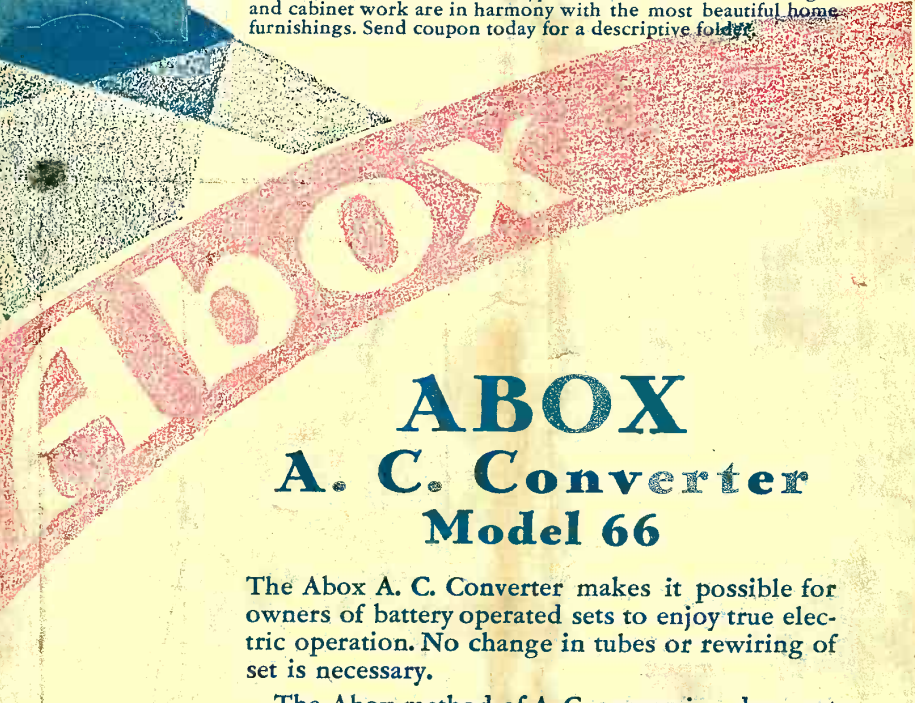

ABOX

A. C. Converter Model 66

The Abox A. C. Converter makes it possible for owners of battery operated sets to enjoy true electric operation. No change in tubes or rewiring of set is necessary.

The Abox method of A. C. conversion does not change the characteristics of your set. It makes any D. C. tube an A. C. tube, and naturally, reception is improved because the tubes are always supplied with full 6 volts of hum-free current at the snap of the switch.

Change now to Abox electric operation for greater convenience and an up-to-date receiver.



Model 66—A. C. Converter Line voltage input—110-120 volts, 50-60 cycles A. C. Output—6 volts, 2 amperes D. C. Complete with receptacle for "B" unit and master control switch. Price \$35.00. (Higher on West Coast.)

The ABOX Company

215 No. Michigan . . . Chicago

ABOX CO., 215 No. Michigan Ave.
Chicago, Illinois

Please send circulars on Abox A. C. Converter.
 Abox Dynamic Speaker.

Name

Address

State