

RADIO'S GREATEST MAGAZINE

RADIO NEWS

REG. U.S. PAT. OFF.

SEPTEMBER

25 CENTS



UNIFORMITY

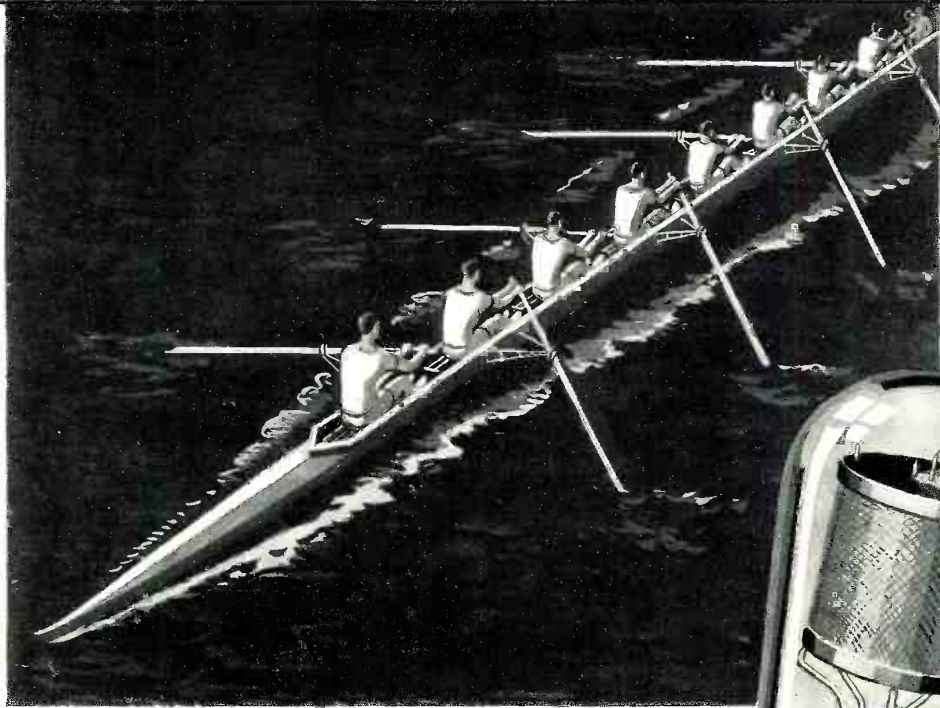

WHETHER in cartons or carloads, you will find TRIAD quality absolutely uniform! UNIFORM because the complete materials for TRIAD Tubes (except glass and base) are made right in the TRIAD plant; UNIFORM because the manufacturing process, from first to last, is personally supervised by world-famous radio engineers; UNIFORM because TRIAD Tubes are subjected to nine exhaustive tests for vital characteristics before ever reaching the packing department—and even there they are sorted for uniformity and *again* inspected before shipment! Even the testing machines themselves are made by the TRIAD Company, and are built to the U. S. Bureau of Standard Specifications. TRIAD Tubes are “honor-built” — throughout! That is why TRIAD *alone* can *insure* every tube for six months’ perfect service—and it is exactly the reason why *you* can win (as thousands of other dealers are now doing) far greater tube sales and profits with TRIAD than you have ever enjoyed before!

Call your jobber or write us direct for complete TRIAD dealer information.

TRIAD MANUFACTURING COMPANY, INC.
Triad Building — Blackstone, Middle and Fountain Sts.
PAWTUCKET, R. I.

TRIAD
INSURED
RADIO TUBES



Above is shown TRIAD
T-24 — Screen Grid Tube
for AC use.



Tune in on the “Triadors”
— every Friday evening
8 to 8.30 Eastern Daylight
Time — on WJZ and as-
sociated NBC Stations.



5 Easy Ways to Make \$3.00 an hour in Your Spare Time in RADIO

Each of these plans, developed by the Radio Training Association of America, is a big money-maker. Set owners everywhere want to get rid of static, to have their sets operate from the electric light socket, the tone improved, and the volume increased, and transformed into single-dial controls. Phonograph owners want their machines electrified and radiofied. If you learn to render these services, you can easily make \$3.00 an hour for your spare time, to say nothing of the money you can make installing, servicing, repairing, building radio sets, and selling supplies.

Over \$600,000,000 is being spent yearly for sets, supplies, service. You can get your share of this business and, at the same time, fit yourself for the big-pay opportunities in Radio by joining the Association.

Join the Radio Training Association of America

A membership in the Association offers you the easiest way into Radio. It will enable you to earn \$3.00 an hour upwards in your spare time—train you to install, repair and build all kinds of sets—start you in business without capital or finance an invention—train you for the \$3,000 to \$10,000 big-pay radio positions—help secure a better position at bigger pay for you.

A membership need not cost you a cent!
The Association will give you a comprehensive, practical, and theoretical training and the benefit of its Employment Service. You earn while you learn. Our cooperative plan will make it possible for you to establish a radio store. You have the privilege of buying radio supplies at wholesale from the very first.

Earned \$500.00 Spare Time
Frank J. Deutsch, Penn.: "I have made over \$500 out of Radio in my spare time."

Radio Engineer in One Year
Claude De Grave, Canada: "I knew nothing about Radio when I joined a year ago. I am now a member of a very exclusive organization of Radio Engineers, and my income is 225% greater than it was."

Doubles Income in 6 Months
W. E. Thon, Chicago: "Six months after I enrolled I secured the managership of large Radio Store and doubled my income."

ACT NOW — If You Wish the No-Cost Membership Plan

To a limited number of ambitious men, we will give Special Memberships that may not—need not—cost you a cent. To secure one, write today. We will send you details and also our Radio Handbook filled with dollars-and-cents radio ideas. It will open your eyes to the money-making possibilities of Radio.

Radio Training Association of America
4513 Ravenswood Ave., Dept. RN-9, Chicago, Ill.

Radio Training Association of America
Dept. RN-9, 4513 Ravenswood Ave., Chicago, Ill.

Gentlemen: Please send me by return mail full details of your Special Membership Plan, and also copy of your Radio Handbook,

Name.....

Address.....

City..... State.....

Radio News

Volume XI

CONTENTS FOR SEPTEMBER, 1929

No. 3

JOHN B. BRENNAN, JR.
Technical Editor

ARTHUR H. LYNCH, Editorial Director
W. THOMSON LEES
Managing Editor

EDWARD W. WILBY
Associate Editor

<i>Cover</i> —From a Painting by Austin E. Briggs	
Frontispiece: The New Short-Wave Station at Chelmsford.....	196
Editorial: What Radio Is Today.....	198
Current Comment.....	200
Notes, news flashes and interpretations of the month's developments.	
The Radio News Foundation Tuner.....	204
By JOHN B. BRENNAN, JR.—First constructional details of a versatile tuning unit embodying a.c. screen-grid tubes with power detection in a compact design.	
Why Not Get the Utmost from Radio on Your Pleasure Boat?.....	212
By LLOYD JAQUET—There is more to pleasure-boat radio than merely a portable set for entertainment.	
Coil Design.....	216
By C. P. MASON—Inductance, resistance and capacity, and what they mean to radio coil design.	
A Handy Calculation Chart.....	220
What Has Brought Tube Prices Down.....	222
Ingenious machines and modern production methods that multiply the value of the radio tube dollar.	
Improving the Explorer Eight.....	226
Antenna stage tuning, screen-grid tubes and a 250 power-amplifier as additional refinements for this popular receiver.	
The Installation and Servicing of Sound Amplifiers.....	228
By S. GORDON TAYLOR—Factors of importance to the man entering this profitable field.	
A Radio Pioneer.....	231
By DR. LEE DE FOREST—Reminiscences of the early experiments out of which grew all the wide ramifications of modern radio.	
Suppressing Oscillations in Tuned R.F. Amplifiers.....	234
By GLENN BROWNING and JAMES MILLEN.	
The Thrills of Amateur Radio.....	236
By LIEUT. WILLIAM H. WENSTROM—What radio offers the real "ham" in thrills and entertainment.	
The Junior Radio Guild.....	241
A department for the boys—already 12,000 strong—who want to know the how, the what and the why of radio.	
Getting the World's News by Radio.....	248
By VOLNEY D. HURD—How an international daily picks up the news on short and long waves.	
Two Practical Laboratory Instruments for the Experimenter.....	252
The Radio Forum.....	255
A meeting place for the Experimenter, Serviceman, and Short-Wave Enthusiast.	
The Trade Broadcasts:.....	261
New equipment and manufacturing trends.	

(Advertisers' Index on page 284)

[[October RADIO NEWS will be the Radio Show Number]]
Look for it—on the news stands Sept. 10]]

Published Monthly by the Experimenter Publications, Inc., at 184-10 Jamaica Ave., Jamaica, N. Y.

Member: Audit Bureau of Circulations

B. A. MACKINNON, President

H. K. FLY, Vice-President and Treasurer

Entered as Second-Class Matter at Jamaica, N. Y., under Act of March 3, 1879.

Executive and Editorial Offices, 381 Fourth Ave., New York, N. Y.

RADIO NEWS is published monthly, on the tenth day of each month preceding that of date. Entered as second-class matter at the postoffice, Jamaica, N. Y., under the act of March 3, 1879. Copyrighted 1929 by Experimenter Publications, Inc.; title

registered U. S. Patent Office. Subscription price \$2.50 a year; \$3.00 in Canada and foreign countries. Single copies, 25 cents each. The contents of RADIO NEWS are indexed in the Industrial Arts Index.

Learn Electricity

in Great Shops!



Not by Correspondence
All PRACTICAL Work at

COYNE



IN 12 WEEKS

LEARN TO EARN \$50 to \$125 a Week

Your future lies in the Electrical Field. The opportunities are limitless. This industry is growing faster than any other and attracting BILLIONS of capital. Get your share. The demand for trained men was never so urgent and the pay was never so large. Act—ACT NOW. Make a start in this wonderful calling.

Hundreds of our graduates are making big money as Power Plant Operators, Electrical Engineers, Telephone Men, Superintendents, Electro Auto Engineers, etc. Hundreds of others are in the electrical contracting business for themselves and making \$3,000 a year and up. I want you to drop your present line and come to Coyne now and let us prepare you for the big opportunities. Spend the next three months in Chicago, the great electrical center of the world. Students taken on frequent inspection trips to the world's greatest electrical plants.

COME WITH US FOR 90 DAYS!

I offer you EXCLUSIVE advantages here. Massive electrical apparatus is reserved for your special use. You learn quickly because individual instruction with instructors to help you—on our immense and modern equipment of dynamos, switchboards, generators, etc. When you graduate you KNOW your business, for you have DONE everything in a practical way.

EARN WHILE YOU LEARN

Don't wait to save a lot of money. Our employment department places students in spare time jobs to earn a good part of their living expenses. Hundreds of our students have worked their way through, you can do the same. Then after you graduate my employment department will give you lifetime employment service. Make up your mind right now—send the coupon this very minute for our big free catalog and full information.

You Don't Need Experience or Advanced Education

You don't need a high school education or one bit of electrical experience. No book studying or classes here. We tell you how to do a thing, then we show you how to do it and then you do the work yourself. That's why you learn quickly and thoroughly.

COYNE ELECTRICAL SCHOOL
H. C. LEWIS, President
500 S. Paulina Street, Dept. 69-02, Chicago, Ill.

AVIATION ELECTRICITY

Automobile and Radio Courses Included Now

Right now I'm including all three of these courses, with my regular electrical course. This is the greatest offer ever made by Coyne and will only be offered for a short time.

GET THE FACTS

Coyne is your one great chance to get into electricity. Every obstacle is removed. My school is 30 years old. Coyne training is tested—proven beyond all doubt—endorsed by many leading electrical concerns.

You can find out everything absolutely Free. Simply mail the coupon and let me send you my big free book.

So act at once. Mail the coupon today.

H. C. LEWIS
President

COYNE
Electrical School
500 S. Paulina St.
Dept. 69-02
CHICAGO, ILLINOIS

Dear Sir:—Please send me absolutely Free your big new book and full particulars of your special offer and three courses FREE.

Name.....
Address.....
Town.....
State.....

MAIL THIS COUPON NOW!

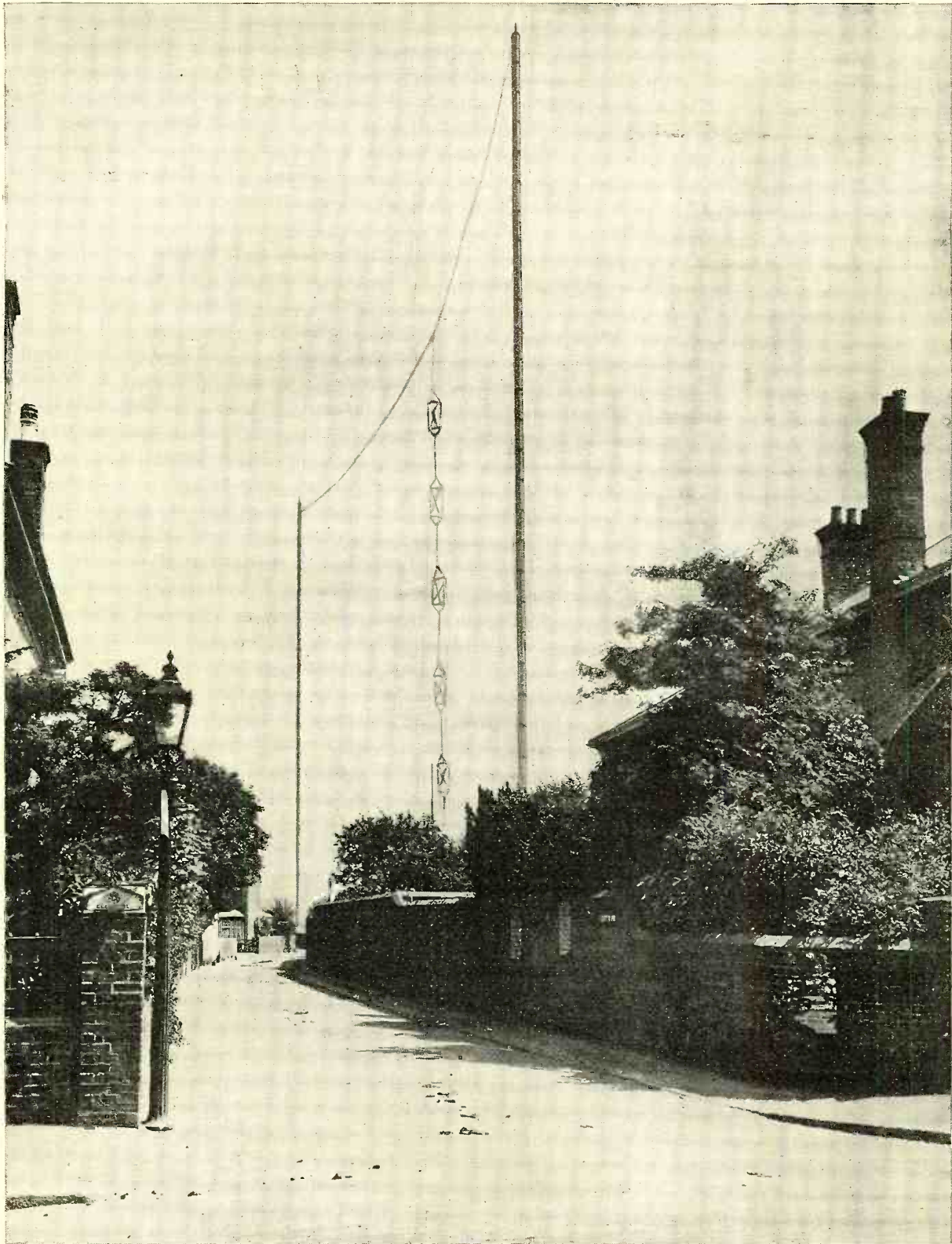

The antenna system of station 5SW, at Chelmsford, the short-wave station of the British Broadcasting Corporation. The operating wave-lengths are 24 and 53 meters. It is through this station that the National

Broadcasting Company plans to pick up and re-broadcast British programs; having already staged a successful demonstration in connection with Thanksgiving services for King George's recovery, early in July.

I Will Train You at Home to Fill a Big-Pay Radio Job



Here's the PROOF



\$375 One Month in Spare Time

"Recently I made \$375 in one month in my spare time installing, servicing, selling Radio Sets."

Earle Cummings,
18 Webster St.,
Haverhill, Mass.

Jumped from \$35 to \$100 a Week

"Last week I had the pleasure of earning \$110 servicing and selling Radio sets. I have made as high as \$241 in two weeks. Before entering Radio I was making \$35 a week. It is certainly great sport to do this kind of work."

J. A. Vaughn,
4202 Arsenal St.,
St. Louis, Mo.



\$450 a Month

"I work in what I believe to be the largest and best equipped Radio shop in the Southwest and also operate KGEI. I am averaging \$450 a month."

Frank M. Jones,
922 Guadalupe St.,
San Angelo, Tex.

If you are earning a penny less than \$50 a week, I send for my book of information on the opportunities in Radio. It's FREE. Clip the coupon NOW. A flood of gold is pouring into this new business, creating hundreds of big pay jobs. Why go along at \$25, \$30 or \$45 a week when the good jobs in Radio pay \$50, \$75, and up to \$250 a week. My book, "Rich Rewards in Radio," gives full information on these big jobs and explains how you can quickly become a Radio Expert through my easy, practical, home-study training.

Salaries of \$50 to \$250 a Week Not Unusual

Get into this live-wire profession of quick success. Radio needs trained men. The amazing growth of the Radio business has astounded the world. In a few short years three hundred thousand jobs have been created. And the biggest growth of Radio is still to come. That's why salaries of \$50 to \$250 a week are not unusual. Radio simply hasn't got nearly the number of thoroughly trained men it needs. Study Radio and after only a short time land yourself a REAL job with a REAL future.

You Can Learn Quickly and Easily in Spare Time

Hundreds of N. R. I. trained men are today making big money—holding down big jobs—in the Radio field. Men just like you—their only advantage is training. You, too, can become a Radio Expert just as they did by our new practical methods. Our tested, clear training, makes it easy for you to learn. You can stay home, hold your job, and learn quickly in your spare time. Lack of education or experience are no drawbacks. You can read and write. That's enough.

Many Earn \$15, \$20, \$30 Weekly on the Side While Learning

My Radio course is the famous course "that pays for itself." I teach you to begin making money almost the day you enroll. My new practical method makes this possible. I give you SIX BIG OUTFITS of Radio parts with my course. You are taught to build practically every type of receiving set known. M. E. Sullivan, 412 73rd Street, Brooklyn, N. Y., writes, "I made \$720 while studying." Earle Cummings, 18 Webster Street, Haverhill, Mass.: "I made \$375 in one month." G. W. Page, 1807 21st Ave., Nashville, Tenn.: "I picked up \$935 in my spare time while studying."

Your Money Back If Not Satisfied

"I'll give you just the training you need to get into the Radio business. My course fits you for all lines—manufacturing, selling, servicing sets, in business for yourself, operating on board ship or in a broadcasting station—and many others. I back up my training with a signed agreement to refund every penny of your money if, after completion, you are not satisfied with the course I give you."

Act Now—64-Page Book is FREE

Send for this book of Radio information. It won't cost you a penny. It has put hundreds of fellows on the road to bigger pay and success. Get it. Investigate. See what Radio has to offer you, and how my Employment Department helps you get into Radio after you graduate. Clip or tear out the coupon and mail it RIGHT NOW.

J. E. SMITH, President
Dept. 9WT
National Radio Institute
Washington, D. C.



**You can build
100 circuits with
the six big outfits
of Radio parts
I give you**

3 of the 100 you can build

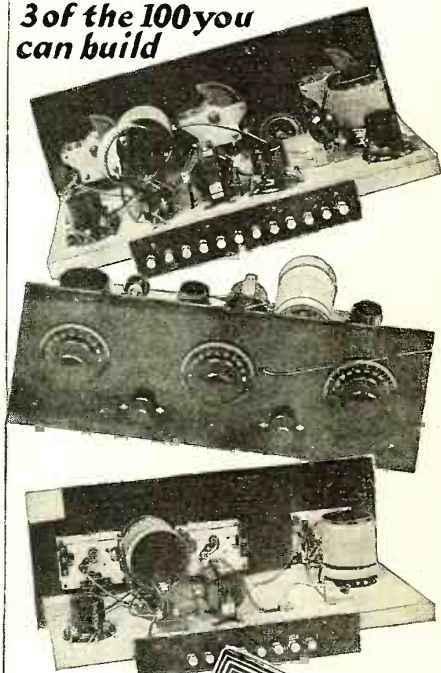

Find out quick
about this
practical way
to big pay



Mail This FREE COUPON Today

J. E. SMITH, President
Dept. 9WT, National Radio Institute
Washington, D. C.

Dear Mr. Smith: Kindly send me your big book, "Rich Rewards in Radio," giving information on the big-money opportunities in Radio and your practical method of teaching with six big Outfits. I understand this book is free, and that this places me under no obligation whatever.

Name Age.....
Address
City State.....
Occupation

Employment Service to all Graduates
Originators of Radio Home Study Training

Editorial

WHAT IS RADIO Today?

OF the millions who listen to broadcast programs we have often wondered how many give any thought to the part radio is playing in other fields than that of broadcasting. How many folks realize, while they listen to the music and the speech which has recently become the latest thing in the movie industry, that the fidelity with which the speech and the music are reproduced is possible because of the pioneer work of a great group of engineers in the broadcast field? It is true that some of the largest among the electrical research organizations have been working on the problem for years and that it is the result of their labors which makes the present day "talkie" possible.

In the laboratories of the Bell Telephone System, of the Radio Corporation of America, the General Electric Company, the De Forest Radio Company, the large motion picture producing corporations and in many other places here and abroad a constant effort is being made to use in other fields those principles which have been laid down as a result of research and investigation in the radio art.

Consider television for the moment. It is one of the most intriguing off-shoots of the radio art. Heralded with a blare of trumpets and great ballyhoo, it is still in its infancy . . . and will be for some time to come before it can be made to serve any very useful purpose. The day when we will be able to watch the "World Series" or the President's inaugural, while we remain at home, is still some distance in the future.

We saw a demonstration of television at one of the largest laboratories in the country a short time ago. The televised images were reproduced in just about their natural colors. They were reproduced clearly and in motion. Truly a remarkable achievement. But the story does not end there. In order to bring about the results, many months of research were necessary and the total cost of the research was in the neighborhood of a million dollars.

Nor is that the entire story. In order to see the reproduction it was necessary to enter a compartment, surround one's self with a curtain and peer through a tiny hole in a contrivance which much resembled the optical end of a stereoscope with one side cut off by a blinder and the other provided with a small hole about the size of the hole in an ordinary spool of cotton. The equipment actually in use for the transmission and reception of the picture would have been cramped had it been in the machinery room of the ordinary broadcasting station and it must have been worth many thousands of dollars. And even that is not the whole story. The picture seemed to be about the size of four ordinary postage stamps. It became very hard to look at, after the first few minutes.

The day when we can hook up some contrivance (which may be had for about thirty-five dollars) to our ordinary radio receiver and see the world before our eyes is not in the immediate tomorrow. But that does not mean that we are to be discouraged. It does mean that the ultimate goal has not as yet been reached. In the meantime it is going to be possible to apply some

of the principles and possibly some slightly altered portions of the equipment in connection with some other scientific achievement.

The same engineers who are applying themselves to these problems are the gentlemen who did a great deal of the fundamental work which has made possible the talking movie and the modern phonograph.

How many folks realize that the telephone engineers are employing daily in their field the fundamental principles of the radio art? It was a telephone engineer and his associates who made a radio telephone conversation between Honolulu and Washington possible.

Some of the principles employed in the standard radio receiver are those on which the present public address system is built. Larger tubes and larger transformers and more power are required, but the manner in which the thousands gathered in Boston's Public Gardens were enabled to hear the World Series is not far removed from the manner in which your own audio amplifier operates.

We could go on indefinitely, but it is our purpose, by calling attention to the present and the past, to suggest a possible new and beneficial use for radio in the immediate future.

Radio's first practical use ("wireless," as it was once known) was in the saving of life when ships at sea were in distress. Now, we just take it for granted that ships are so equipped.

Strangely enough we are moving around in the cycle of events and it will not be uncommon in the very near future to find that the pleasure boat or yacht will also be equipped with radio, primarily for entertainment but equally as important for the safety it makes possible.

Equipped with a comparatively inexpensive receiving outfit it would be possible for a small boat to navigate from point to point without the "skipper" having any knowledge of navigation in the ordinary sense. This could be done by making use of the radio beacon signals and the radio beacon signal receiver. By taking advantage of the signals being transmitted at regular intervals from the air service beacons as well as the beacons which are in use for ordinary navigation along our coasts and applying a simple system of visual recording this simple form of navigation could be put to work. Thus radio is made to serve again.

Let the wet-blanket gentleman who says there is nothing new under the radio sun beware. The radio millennium has not been reached and quite probably will take care of itself when it does come. Meanwhile, we will do well to take full advantage of what radio has to offer in the immediate present.

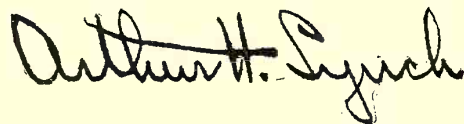

EDITORIAL DIRECTOR,
EXPERIMENTER PUBLICATIONS, INC.

196 Page
FREE
CATALOG

The new **SCREEN GRID**

RADIO

the new **SCREEN GRID** models



A-C RECEIVERS RECEIVERS!

WHOLESALE PRICES!

THIS NEW big catalog—just off the press—heralds values never before approached in radio merchandising. Prices have never been lower—or quality so high. Send for your copy today. See for yourself the astounding values we offer—the actual wholesale prices at which you can now buy. Our recent purchases totaling over one million dollars (\$1,000,000) in standard radio receiving sets coupled with our tremendous stock of standard accessories, parts and kits has enabled us to make startling price reductions. Write today for the complete story as given in this large 196 page catalog of radio bargains.

EVERYTHING IN RADIO AT UNHEARD OF PRICES

New Screen Grid A. C. Humless All-Electric sets—standard A-C sets as well as battery operated receivers in an attractive array of consoles ranging from small table model types to gorgeous pieces of radio furniture. They represent the finest offerings of the season. The price range is especially attractive presenting unusual values as low as \$15.95.

Get this Allied catalog. Buy low so you can make more profit. Deal with an organization of experts who are trained to render real service in radio.

\$ 15.95

A
Reliable,
High-grade
Radio House

ALLIED RADIO CORPORATION

Backed by
Resources
totaling over
\$3,000,000

711 W. Lake Street Dept. B Chicago

Radio News

Vol. 11

SEPTEMBER, 1929

No. 3

Current Comment

AN accepted device among statisticians who wish to present a fair picture of current values, is to translate all prices into terms of "1913 dollars"; that is, to use the purchasing power of the dollar in the last pre-war year as a standard of reference.

It would be interesting to have someone try that method with respect to radio receivers and accessories! Oh, yes; there was radio, even in those days. But the 1913 dollar didn't cover much territory in initiating the novice into its fascinations. Even as late as 1922, it took from seven to nine of that year's dollars (we aren't quite sure what that represented, in 1913 value) to buy a single receiving tube. Today, you can buy a half-dozen infinitely better ones for that amount.

Six years ago, if you were a plutocrat, you could buy a three-tube regenerative receiver for a price (without tubes, batteries or speaker) that seemed almost reasonable. That same price, today, will buy a receiver embodying single control, electric operation, built-in speaker—all housed



NEWLY DEVELOPED GENERAL ELECTRIC AIRPORT BEACON, WITH OPERATING PARTS UNDER A GLASS DOME

in a piece of furniture that is an ornament to any home.

The reason? Just as happened, years ago, in the automobile industry, the radio manufacturers have woven into their production fabric the services of the research engineer, chemist, metallurgist, design engineer, production specialist; and with these, plus the strictly radio technician, radio sets and accessories have gone on a production basis.

That, more than anything else, is why your radio dollar will buy, today, more dollars' worth of radio than last year or ever before.

There is another parallel between automobile development and radio development which is worthy of notice. Remember how the first six-cylinder car was heralded as "spelling the doom of the four"? And was it air-cooled motors that were to make water-cooled motors obsolete, or was it vice versa? Then, the sleeve-valve engine was to relegate the pop-

BELOW—PART OF THE "MOVING ASSEMBLY" LINE OF A MODERN FACTORY; ONE REASON FOR MORE-VALUE-PER-DOLLAR IN RADIO RECEIVERS

Photo Courtesy of Stewart-Warner Mfg. Co.



pet-valve to the scrap-heap. Each of these things, and many more, were to "revolutionize" the automotive industry. Until the automotive industry grew up, and learned that these things were simply progressive developments and evolution, rather than revolution.

Just now, we have seen similar predictions of the "revolutionizing" of the radio industry; at the moment, it is the a.c. screen-grid tube that is to do the trick. We have a strong suspicion that it won't. Just for emphasis, let's say that over again: the new a.c. screen-grid tube (in our humble opinion) is not going to revolutionize radio.

This is by no means in disparagement of the accomplishments and possibilities of that tube. It is, without question, an important contribution to the advancement of the radio art; but it is only one of scores of contributions to that end. And, when enthusiasts call this tube "the last word," they show scant faith in the ability of engineers to keep right on growing.

As for predictions that the a.c. screen-grid tube and the new type -45 together will make all other types obsolete—notice how, after all these years, the four-cylinder car and the six are both doing nicely, even with eights and twelves running around; how the air-cooled motor and the water-cooled motor are still with us; and both sleeve-valve and poppet-valve motors function very nicely. Why look for revolution, where evolution is not only safer and saner, but infinitely more certain in producing results?

Radio and Aviation

Only two months ago, we recorded in these columns the dedication of the first aviation radio station; station WRNY of New York. Other stations have since gone air-minded; even the chain systems having taken on part of the task of making the country air-conscious. Broadcasting stations, however, are not the important factor in promoting safety in flying. Down below the reach of the lowermost tuning of the broadcast receiver, down on the short waves, is where radio is doing its real work for aviation.

The assistance that radio is giving the airplane, and particularly the air mail, is apparent in the announcement that by July 1 there will be 10,700 miles out of a total of 31,222 miles of domestic and foreign routes in operation or scheduled to be cov-

ered by radio range beacons, together with rotating light beacons. In addition, great strides have been recently made in experiments in radio-telephony between airplanes and the ground.

Dr. Frederick L. Hoffman, director of research, Aviation Business Bureau, Department of Commerce, said: "These radio signals indicate to the pilot his position on either side of the airway by the relative strength of two more characters; flying directly on the airways, these characters

the transcontinental route, as well as at intermediate landing fields between radio stations, according to Dr. Hoffman. With these, weather or other information written on one machine at each of these stations, or at intermediate fields, is automatically written on tape at all other stations of the circuit. The weather conditions in the various sections of the route are thus simultaneously available to all pilots.

Not only in beacon and weather service, does radio serve aviation, but in furnishing the only possible means for direct communication. We are much slower, in this country, to appreciate the latter factor than are our European cousins. Abroad, it is compulsory for passenger-carrying planes on commercial routes to be equipped for radio communication with the ground. Here, we concentrate on direction-finding receivers for our airplanes, leaving two-way communication equipment for second thought. A reflection of this difference in viewpoint is shown in the fact that the Americans who plan a flight to Rome (and who, as we go to press, have landed safely in Spain; continuing on to Rome) dispense with radio because of its weight; yet the Frenchmen who successfully spanned the Atlantic would not forego their radio, the Spanish fliers rescued near the Azores had a radio set, and the Swedish amphibian *Sverige*, halted on the first leg of the Viking trail, carries elaborate radio equipment.

Speeding the Transatlantic Mail

Early in June, an airplane equipped with a dragline succeeded in picking up a bag of mail from a specially con-

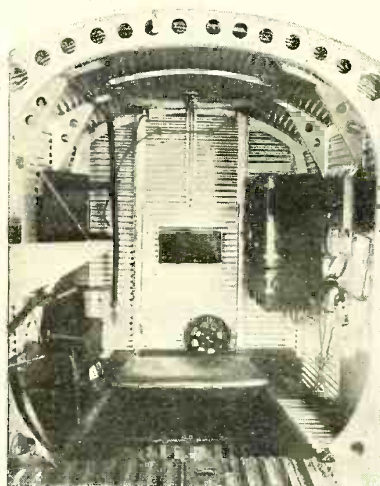

© International

RADIO EQUIPMENT OF THE AMPHIBIAN PLANE "SVERIGE," WHICH SET OUT TO FOLLOW THE OLD VIKING TRAIL TO THE UNITED STATES

blend into one long dash of constant amplitude. A visual method of reception is being developed in order to determine the relative merits of the aural and visual systems. To date, only the aural method has been put into actual daily operation."

Teletype machines have been installed at some radio stations along

THE FORD AIRPORT, SITE OF THE FIRST COMMERCIAL BEACON IN THE UNITED STATES

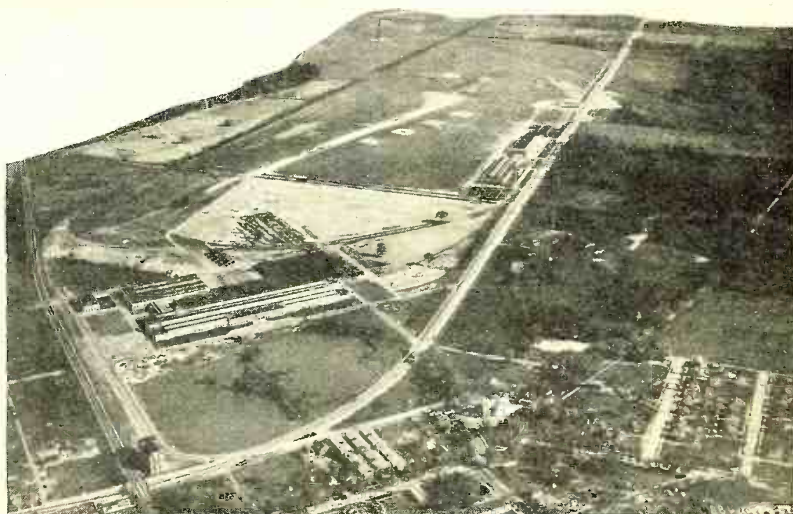

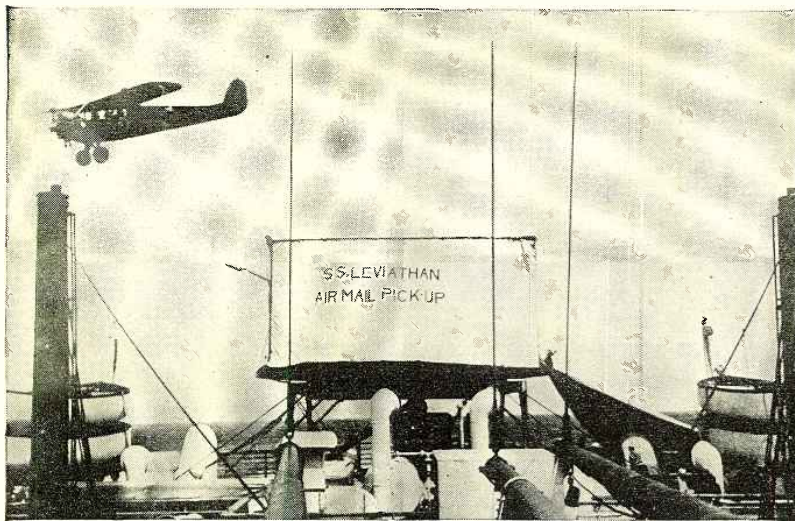

© International
A NEWS PHOTO OF THE FIRST SUCCESSFUL MAIL PICK-UP BY PLANE FROM THE "S.S. LEVIATHAN"

structed pick-up platform on the deck of the *S. S. Leviathan* at sea. The feasibility of the device being demonstrated, it is planned to develop this service so that liners may be met some 500 miles or more from the coast, thus saving more than a day in the schedule of transatlantic mail.

Interesting from a mechanical standpoint, also from an aviation standpoint, this project is particularly interesting to followers of radio—because, *without* radio, it would be impossible. The steamship must first report its position—by radio. The plane must set its course for the point of meeting—by radio. On closer approach, radio direction-finding plays its part; and finally, communication directing the actual pick-up must be by means of radio.

All the Comforts of Home

The *Leviathan* figures in the news of the day—as concerns radio—in still another fashion. It has recently been announced that the flagship of the United States Lines fleet is to be equipped with a telephone exchange and powerful short-wave equipment for two-way radiophone communication. The American Telephone and Telegraph Company is making the installation, coöperating with the steamship company.

Discussing the tests between the *Leviathan* and shore stations, Walter S. Gifford, president of the telephone company, pointed out that there is a growing need for means by which the passengers of trans-Atlantic liners may talk with telephone subscribers on land.

"It is in view of this situation that the American Telephone and Telegraph Company has formulated plans to initiate such a service," he said. "As a first step a shore station in the vicinity of New York will be erected

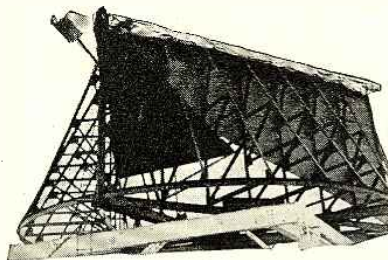

© International
ABOVE IS SHOWN A CLOSE-UP VIEW OF THE MAIL PICK-UP DEVICE BUILT ON THE AFTER ISLAND DECK OF THE "LEVIATHAN." IT IS THE INVENTION OF DR. LYTLE S. ADAMS OF SEATTLE

BELOW—A SIDE VIEW OF THE SENDING APPARATUS FOR TRANSMITTING TELEVISION IN NATURAL COLOR
Photo Courtesy Bell Telephone Laboratories



immediately and radio telephone equipment will be installed on the steamship *Leviathan*, of the United States Lines.

"Since the construction of the new land station will require several months, it is planned to use for the initiation of the ship-to-shore experiments one of the transmitting units at Deal Beach experimental station. One of these transmitters, which is now employed for trans-Atlantic telephony, will become available for the new marine telephone service when it is replaced in the trans-Atlantic service by one of the units of the new short-wave transmitting center at Lawrenceville, N. J., where the first unit was put in operation a few days ago."

The commission has allocated to the telephone company four high-frequency channels for its land station at Deal Beach and three frequencies for the *Leviathan*. If the service proves to be practical, 18,000,000 subscribers in the United States will be able to talk, at present with the *Leviathan*, and eventually with every liner afloat on the Atlantic.

According to present plans, all five of the passenger vessels of the United States Lines will be equipped with radio-telephone after present tests prove successful. The channels allocated for the service are mobile bands. Those assigned to the Deal Beach station are 3124, 4116, 6515 and 8630 kilocycles. The assignments for the *Leviathan* are 3248, 5618 and 8450 kilocycles.

Present plans call for an expenditure of \$750,000 for the development of the service. Aboard the vessel is a complete switchboard connecting all

staterooms now equipped with tele-phones with the radio circuit. The service, it is expected, will be ready for operation in about six months.

The World at Our Doorstep

As we go to press, an interesting demonstration has just been given of what the broadcast listener may look forward to, later in the year. The service of thanksgiving for the return to health of King George, held in Westminster Abbey, London, on the seventh of July, was broadcast by the British Broadcasting Corporation. Simultaneously, the broadcast was put on the air by station 5SW, the powerful short-wave transmitter at Chelmsford.

The program, picked up on short waves by the National Broadcasting

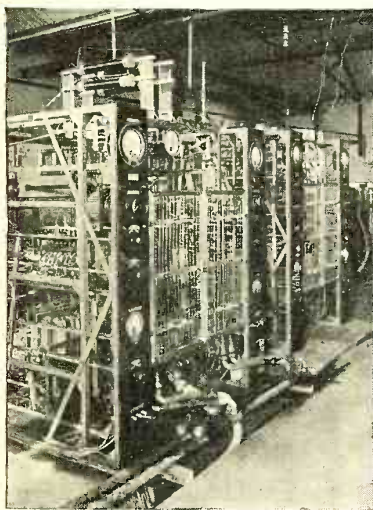

© Underwood & Underwood

INTERIOR OF THE NEW CHELMSFORD TRANSMITTING STATION OF THE BRITISH BROADCASTING CORPORATION. CONTRAST THIS WITH THE EARLY ILLUSTRATION SHOWN AT THE UPPER RIGHT OF THIS PAGE

Company, here, was rebroadcast by 68 stations associated with the N. B. C. chain. Listeners in the eastern part of this country were deprived of the major part of the program, however, by an SOS signal from the S. S. *Prince George* (an odd coincidence of names), which was in collision with a Coast Guard cutter, off Boston. This forced the powerful coastal broadcasters to shut down; though the remainder of the chain continued to re-transmit the program from Chelmsford.

As an additional thrill, toward the close of the special broadcast, the N. B. C. picked up station VK2ME at Sydney, Australia. So that within a few

moments, listeners in New York at approximately 6:45 on a Sunday morning, heard a voice speaking in London at 11:45 of the same morning, and immediately afterward a voice speaking in Sydney, where it was 10:45 in the evening of the same date. Since the day, in New York, was one of sweltering heat, we wonder how many listeners realized that what to them was the dawn of a hot day, was, in Sydney, close to midnight of a mid-winter's night?

The foregoing item, in the light of previous announcements of cooperation between the British Broadcasting Corporation and our own National Broadcasting Company, promise much for the immediate future. Another recent item, also, promises much—but we doubt whether it is for the immediate future. We refer to the demonstration of color television, given in the Bell Telephone Laboratories, New York, in the latter part of June.

Bell engineers have their feet far too firmly on the ground to indulge in wild predictions, but the demonstration was interesting nevertheless. As in all television achievements to date, the image is necessarily small—disappointingly so, to those who have been led by ill-advised premature publicity to expect more.

Meanwhile, for a succinct statement on just what television offers the radio fan and experimenter today, we can hardly do better than to quote Dr. Alfred N. Goldsmith, vice-president and chief broadcast engineer of the Radio Corporation:

“An experimental television broadcasting station of the Radio Corporation of America, call letters W2XBS, located at 411 Fifth Avenue, New York City, has been in operation since August, 1928, and has been frequently used for conducting basic experiments in television transmission and reception since its construction. Its experimental activities have followed several years of television research and development by engineers of the General Electric Company, under the direction of Dr. E. F. W. Alexanderson, and by tele-

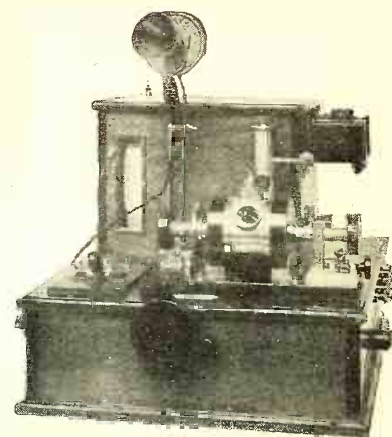

© Underwood & Underwood

AN ARC TELEPHONE SET OF 1914, BEFORE PERFECTED VACUUM TUBES COMPLETELY CHANGED TRANSMITTING EQUIPMENT

vision specialists of the Westinghouse Electric and Manufacturing Company, under the supervision of Dr. Frank Conrad.

“Television broadcasting is now being regularly carried on daily from 7-9 P. M. The radio channel assigned to W2XBS is from 2000 to 2100 kilocycles, which is equivalent to a band of from 142.8 to 149.9 meters. The power employed at present is 250 watts, although it is expected that this will be considerably increased shortly. Pictures are 60 scanning lines high, vertically, and 72 elements wide, horizontally. Twenty complete pictures are transmitted each second. Scanning is in such a direction that looking at the received picture, the scanning light spot moves from left to right and from top to bottom.

“Transmissions consist of pictures, signs, and views of persons and objects. Announcements are made frequently by transmitting a picture of the call letters of the station.”

Dr. Goldsmith continued by saying that this program enables the Radio Corporation of America to give experimenters an opportunity to “look in” on this work, which, it is contemplated, will in due course, evolve into a service to the public on a “commercial” basis similar to sound broadcasting and of like high quality.

W. Thomson Lees

Managing Editor

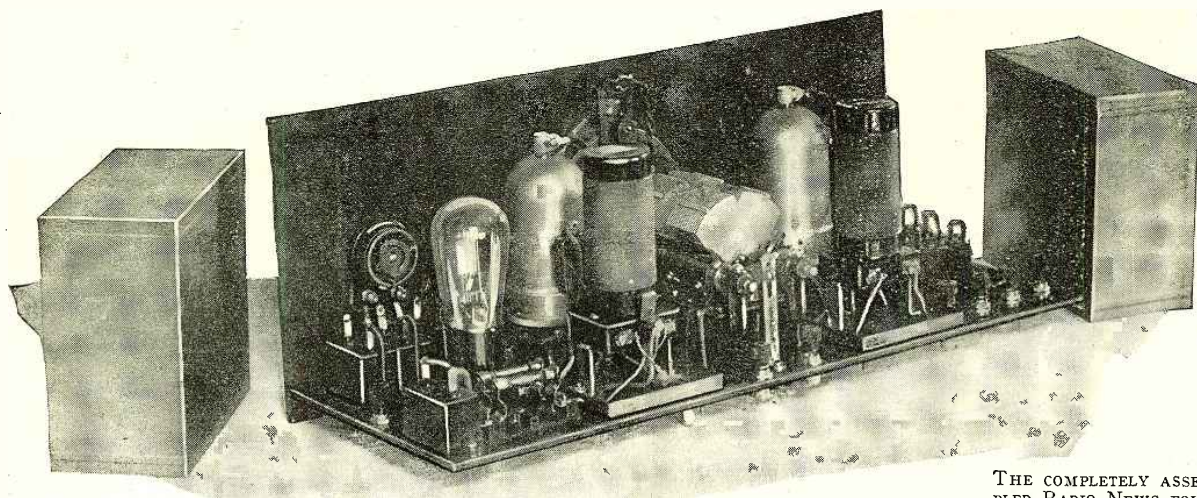

THE COMPLETELY ASSEMBLED RADIO NEWS FOUNDATION TUNER WITH SHIELD CANS REMOVED

First CONSTRUCTIONAL DETAILS of the RADIO NEWS Foundation Tuner

By JOHN B. BRENNAN, JR., *Technical Editor*

WHEN one looks back over the past six or eight years, not a great deal of what might be termed new or revolutionary circuits has been developed. Practically all of the circuits now in use were, in one form or other, with us ever since the early days of radio broadcasting.

Roughly speaking, they fit into any of the three following classes: Multi-stage radio-frequency amplifiers; radio-frequency amplifiers with regenerative detector; or the superheterodynes. Some, of course, have consisted of combinations of one or the other.

Circuit development, then, has become largely a matter of adapting existing types of circuits to new uses, or, said in another way, the application of new devices such as tubes, to existing circuits. In this respect, the screen-grid tube offers perhaps the most varied and far-reaching field for experimentation. It was inevitable, naturally, that the a.c. screen-grid tube would follow.

In the laboratory of RADIO NEWS magazine has been developed a receiver which bids fair to command a widespread attention among the more serious-minded custom set builders and experimenters.

Over a period of months careful consideration has been given to worth-while a.c. circuit designs, to the choice of suitable parts, and lastly to the selection of a satisfactory constructional layout.

IN developing the tuning unit whose construction is described in the accompanying article, our technical staff went at the job with certain definite objectives. The unit must, first of all, satisfy the requirements of tone fidelity; it must provide selectivity; it must accomplish these things, together with adequate sensitivity, with as few tubes and parts as possible, and in the most compact form.

With these marks to shoot at, it was also realized that individual preferences differ widely. So, to the other requirements, was added that of versatility.

While the tuner unit as described here is complete and satisfies all the requirements laid down, at the same time it serves as the foundation unit for a series of interesting adaptations which will be described in succeeding issues of RADIO NEWS.

An inspection of the accompanying sketches and photographs will, it is believed, attest to the fulfilment of the second and last of the above-named features; construction and operation of the receiver itself alone can prove the worthiness of the circuit which has been finally chosen.

During all the preliminary work leading up to the design of the final accepted receiver whose construction is shown here, some very definite requirements were set down which, in the laboratory work of test and investigation, it was desired to satisfy. These were, first, the employment of as few tubes in the receiver as was commensurate with an accepted degree of sensitivity; second, the use of a sufficient number of tuned circuits so as to obtain a high degree of selectivity; third, the use of a circuit which besides embodying the above-named features would also produce a satisfactory order of tone reproduction by virtue of a suitable band-pass filtering action, so as not to introduce distortion through the cutting of sidebands of the received signals.

An exposition of the outstanding features of the tuner design shown herein will, in all probability, show how completely these requirements have been met.

The Circuit

To begin with, the circuit, an a.c.-operated one, comprising three tubes, consists of a single stage of tuned radio-frequency

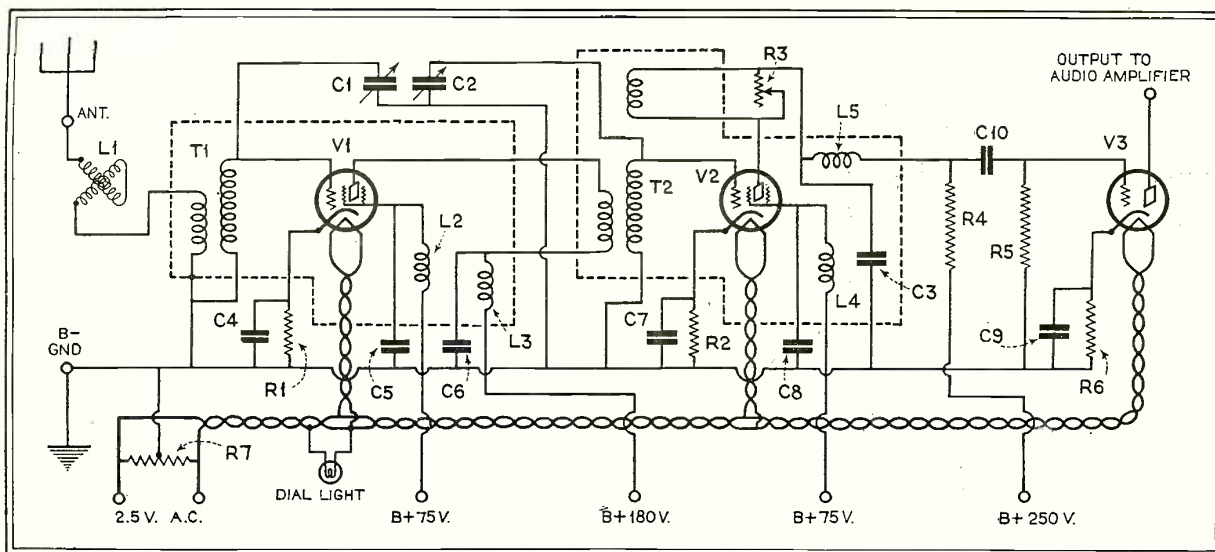

FIG. 1—THE CIRCUIT OF THE RADIO NEWS FOUNDATION TUNER EMPLOYS THREE TUBES, ALL OF THE A.C. TYPE. TWO ARE A.C. SCREEN GRIDS AND ONE, THE THIRD, IS AN A.C. 27 USED IN THE FIRST AUDIO STAGE

amplification, a regenerative power detector and a single stage of resistance-coupled audio-frequency amplification.

Both the radio-frequency and detector stages employ screen-grid tubes, thus entailing the use of complete filtering in the plate and screen-grid circuits of these tubes. This is effectively accomplished by the use of suitable by-pass condensers and chokes in both of these circuits. For purposes of minimizing direct electromagnetic coupling between the tuned circuits, they, the circuits, are completely enclosed in shield cans; thus obtaining the added advantage of preventing direct pick-up of the signals by the coils or their associated circuits. In the isolation of these tuned circuits, the chokes and by-pass condensers also play an important part in that they prevent intercoupling of the radio-frequency currents by shunting them direct to ground instead of allowing them to course through long bunched connecting leads where detrimental linking of the radio-frequency currents would be sure to take place.

By the use of the screen-grid tube in the radio-frequency stage, a high order of sensitivity, by virtue of this tube's enormous amplification properties, is obtained. Selectivity is obtained through the combined effects of a tuned radio-frequency stage and a regenerative detector circuit. An antenna compensator, which is in effect a miniature variometer, is connected in series with the primary of the antenna coil to obtain a further control of selectivity, especially when the circuit is tuned to signals emanating from distant stations.

To intelligently employ the screen-grid tube as a power detector, several points of circuit construction must be observed. First, there is the matter of plate and screen-grid voltages. When operating this tube under normal operating conditions, the screen-grid element has applied to it 75 volts positive bias, the plate 180 volts

and the filament the normal 2½ a.c. volts. Under these conditions, in order to satisfy the impedance relations between the plate and the output circuit of the detector, it is out of the question at this writing to effectively employ one of the standard makes of audio-frequency transformers for the reason that the impedance of their primaries is much too low. That of the a.c. screen-grid-24 tube is 400,000 ohms and, under perfect operating conditions, the impedance of the unit to which is outputted the detector plate should be of a like value. Naturally, the only practical way of satisfying these conditions is to employ a resistance coupling unit between the detector and the first audio stage. However, with a plate resistor of 500,000 ohms (the most practical manufactured value of resistor available which compares with the impedance of the tube) and a current which reaches an average of .32 mils (.00032 amps), the voltage drop across such a resistor would be in the neighborhood of 160 volts. Now, when it is considered that, after passing through this resistor, the actual

voltage under which the tube should be operated is 180 volts, it is not difficult to figure that a total of 340 volts would be required to appease both the plate voltage requirements and the voltage drop across the plate resistor. Unless a power pack which delivers voltages suitable for 210 or 250 power amplifier tubes is available, this high detector plate voltage is not readily obtainable. There is, however, a solution to the problem.

Not a great deal in operation of the detector tube is sacrificed by using a plate resistor which is just one-half the value of the 500,000-ohm resistor previously mentioned. Thus the voltage drop [E equals I (.00032 amps.) times R (250,000 ohms) or 90 volts] is limited to a figure which, in addition to the highest plate voltage required by the tuner,

MR. E. W. WILBY, ASSOCIATE EDITOR AND COLLABORATOR IN THE DESIGN AND CONSTRUCTION OF THE RADIO NEWS FOUNDATION TUNER, IS SHOWN OPERATING THE SET IN RADIO NEWS LABORATORY

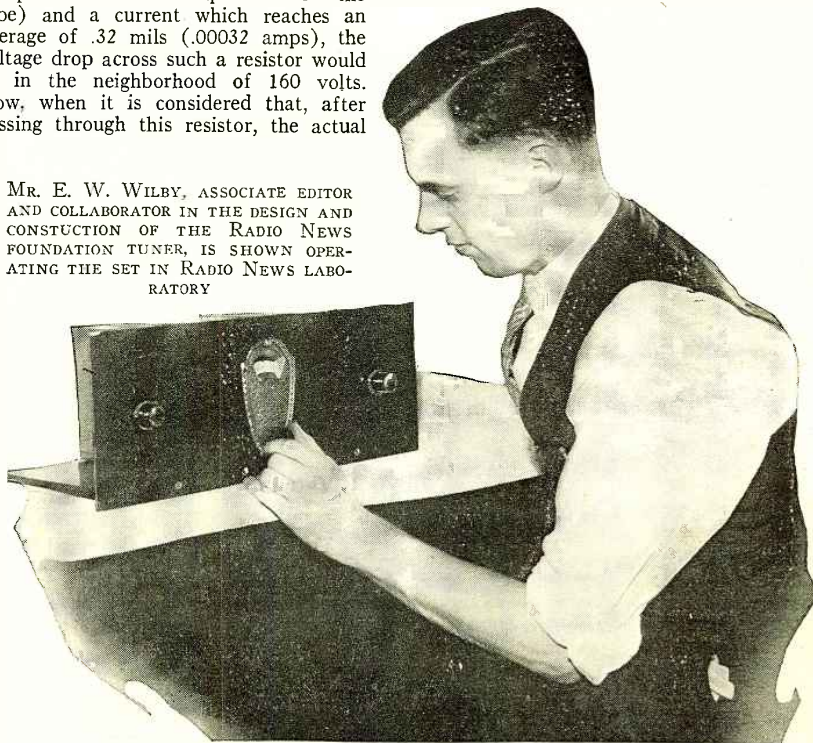

namely 180 volts, is just shy of being within the limits of a power pack suitable for use with a 245 power amplifier. This is mentioned merely because in the following issue will be described such an amplifier-power supply device to be worked with the tuner described here, and capable of supplying these required tuner voltages.

Control of regeneration in the detector stage is obtained by means of a variable resistance of 2,000 ohms which directly shunts the regenerative or tickler coil. A feedback by-pass condenser of .0005 mfd. is provided for the radio-frequency return path of the detector radio-frequency currents. Provision of a choke coil between the tickler and the top side of the plate coupling resistor prevents these radio-frequency currents from entering the audio amplifier, where they would probably cause distortion.

The receiver when operated in the laboratory produced a signal from locals sufficiently strong enough to operate satisfactorily a loud speaker. While the receiver is not intended to be used as a three-tube set but rather as a tuner unit which is to be coupled to a suitable power amplifier stage, the fact that the tuner can produce a loud speaker signal is mentioned only to indicate the very high signal output of this unit.

In the following issue will be described not only the constructional details of the 245 power amplifier but also the installation details for housing the tuner, amplifier and electrical phonograph with electrical pick-up in a suitable console cabinet. The power-amplifier will be so designed as to provide the necessary "A" and "B" voltages for all the tubes in the tuner unit.

"C" bias voltages for the three tubes in the unit described here are obtained by employing resistors so located in the circuit as to provide voltage drops of the correct value in the return grid-to-filament circuit.

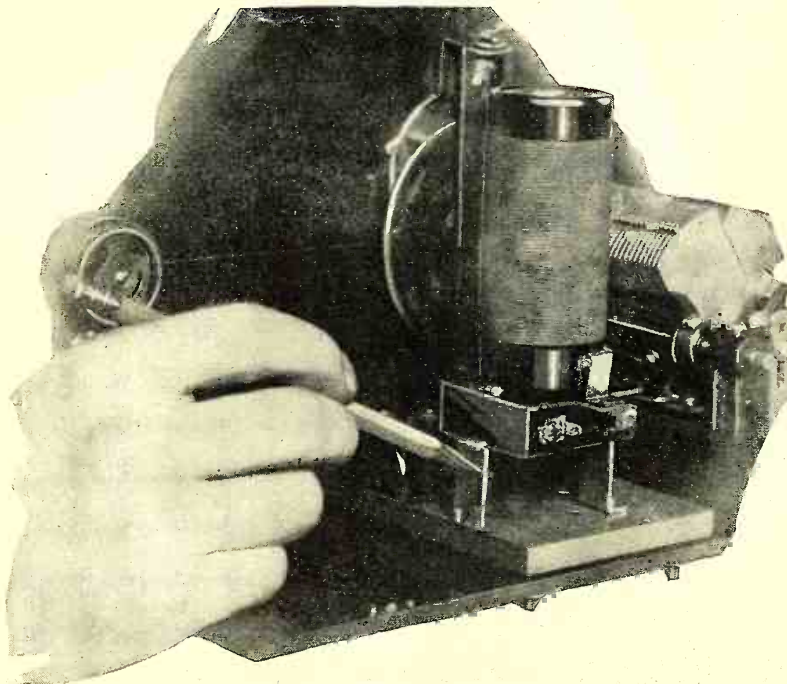

TO CENTRALLY LOCATE THE TUNING COILS WITHIN THE SHIELD CANS, THE COIL SOCKETS ARE MOUNTED ON BRACKETS, AS INDICATED HERE

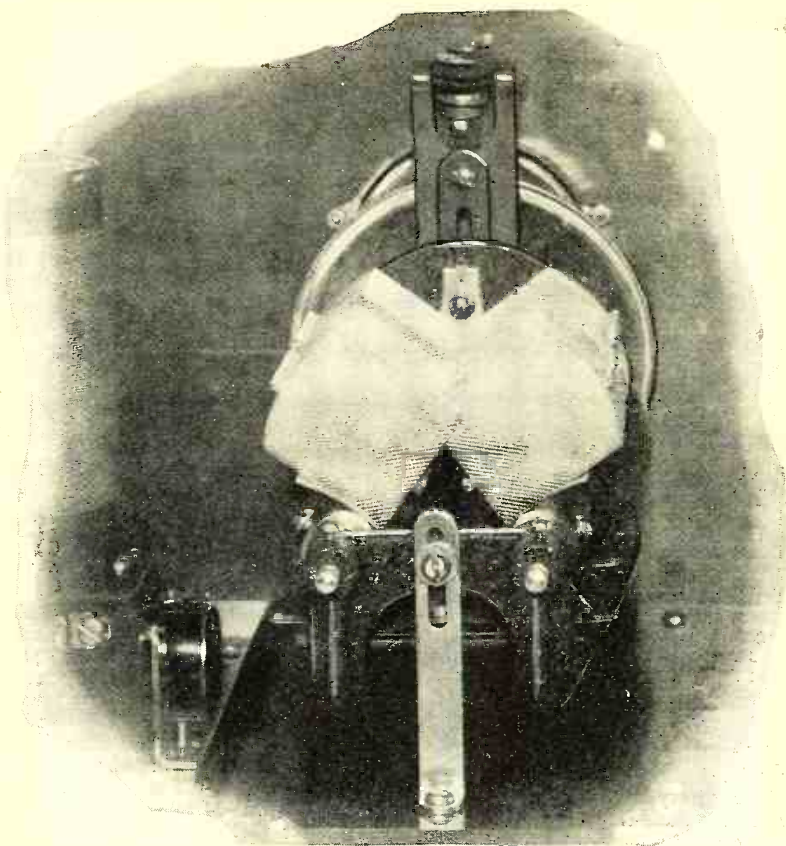

AN ESSENTIAL FEATURE IN THE ASSEMBLY OF THE "TUNER" IS THE RIGID AND SUBSTANTIAL SUPPORT OF THE FRAME OF THE TUNING CONDENSER, AS SHOWN ABOVE

Selection of Parts

In every receiver design it is of prime importance that the parts which are selected for use in the construction of the receiver be of the best and of reputable manufacture. The receiver described here is no exception to this rule.

From the various photographs which illustrate the construction of the receiver, it will be noted that the major portion of the parts comprising the tuned circuits, in fact all except the by-pass condensers and tuning condensers, are completely enclosed in shield cans. The coil units are of the plug-in type, fitting into standard four-prong tube sockets.

The tuning condensers are of the "gang" variety, being operated by one main tuning dial. The antenna compensator knob and regenerative control are the only other controls appearing on the panel, thus lending a clean, factory-like appearance to the job.

Assembly

The first step in the procedure of construction is to inspect the list of parts shown elsewhere in this article; obtain these parts and then do the necessary preliminary layout and drilling work on the main and sub-panels and on the bracket which is employed to fasten the two together. The layout for the main panel is shown in Fig. 3. Twelve holes are to be drilled. One for the antenna compensator at the extreme left center; one for the regeneration control at the extreme right center; four for the mount-

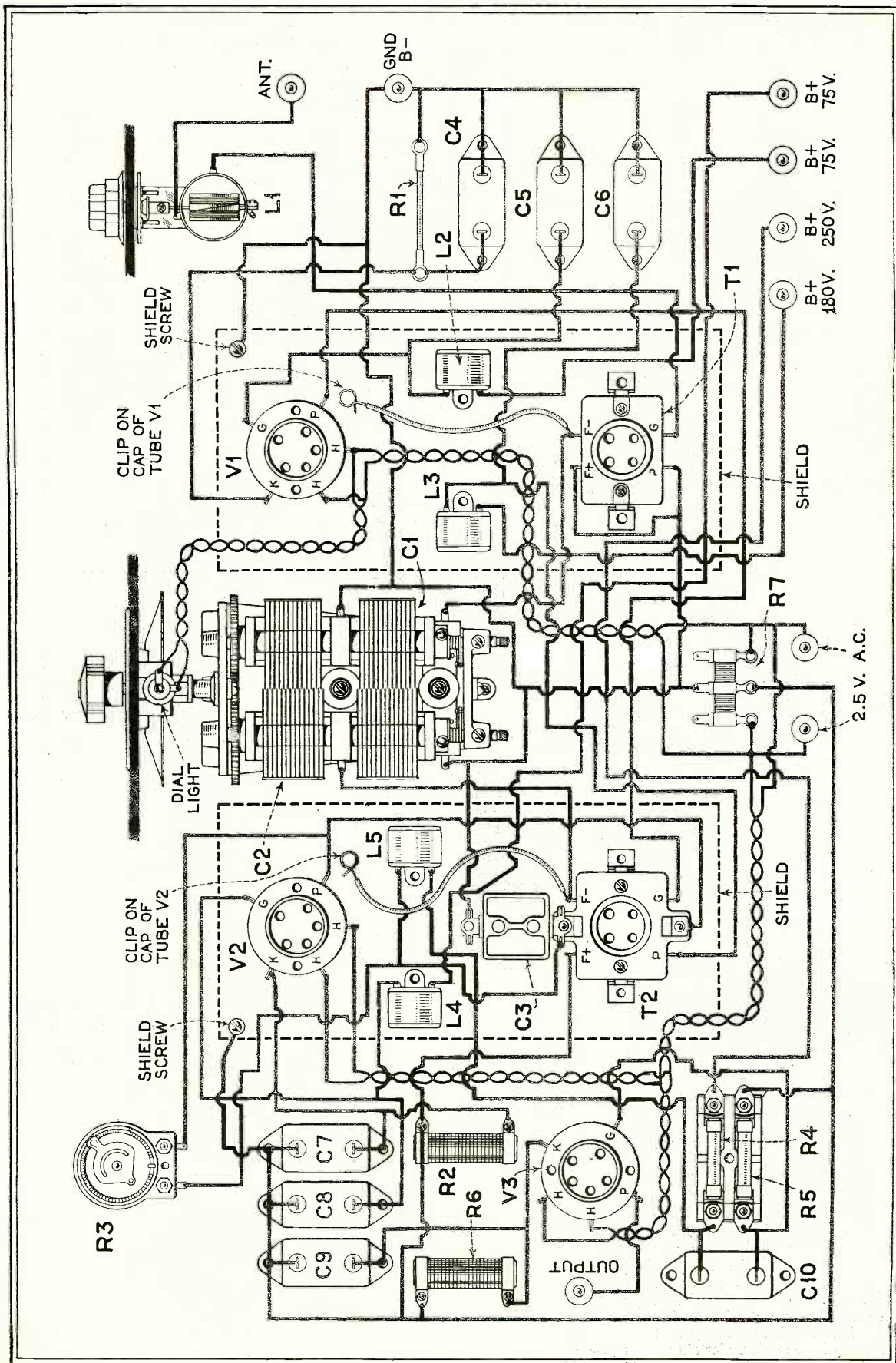

FIG. 2—THE COMPLETE WIRING LAYOUT OF THE RADIO NEWS FOUNDATION TUNER IS GIVEN HERE WITH THE PARTS LOCATED IN APPROXIMATELY THE SAME POSITION THEY WILL OCCUPY IN THE FINISHED RECEIVER. FOR A COMPLETE COMPREHENSION OF THE ABOVE CIRCUIT LAYOUT, IT SHOULD BE COMPARED WITH THE SCHEMATIC CIRCUIT SHOWN IN FIG. 1



THIS DETAILED VIEW OF THE DETECTOR SHIELD CAN SHOWS THE TERMINAL PLATE WHICH FITS OVER THE COIL SOCKET TO ACCOMMODATE THE DETECTOR COIL WITH ITS TICKLER WINDING

ing screws for fastening the panel to the sub-panel and six for the dial mechanism. The positions of these various holes are shown in Fig. 3. They should be spotted on the panel and drilled to the size indicated.

When this is completed, the sub-panel may be drilled. Here, there are many more holes to be drilled and as indicated in Fig. 4 are identified for the use to which they are to be put. Note that practically all of the holes for the sub-panel are drilled with a No. 28 drill.

When all the holes have been drilled, the panels may be put to one side, for the time being.

Then, taking one of the shield can bases, the a.c. socket, radio-frequency chokes and coil socket mounting bracket may be fastened into place. To determine the exact location of these units in respect to the holes which come already drilled in the bases, it is well to refer repeatedly to the several drawings and photographs. The coil socket is mounted on the brackets provided. In the detector shield base, the bakelite plate which is provided with the detector coil for obtaining contact to the tickler coil terminals is placed over the detector coil socket and then the two are mounted on the bracket. To the inside terminal of this plate should be fastened the by-pass condenser C3, although this is something that may wait until the wiring of the set is undertaken.

When all the parts in both of the cans

THE October issue of RADIO NEWS will be the Radio Show Number; devoted to presenting the new radio receivers, kits, parts and accessories that are to be exhibited at the Radio World's Fair in Madison Square Garden, New York, September 23rd to 28th.

This annual New York Radio Show has come to be looked on as more or less the gala public opening of the new radio season. Just as the R. M. A. Convention and Trade Show in June gives jobbers and dealers a line on what manufacturers are doing, so the Radio World's Fair introduces all the newest radio receiver developments to the general public.

The newest low-priced receivers; the most costly and elaborate radio-phonograph combination; the newest tubes, a.c. screen-grid, power amplifier tubes, rectifiers; speakers; cabinets, power-supply devices; kits and individual parts; all these things are to be exhibited, in their latest stages of improvement and refinement.

For those who visit the show, October RADIO NEWS will be a convenient reference manual; for those unable to attend, who want to keep abreast of the latest in radio, it will be almost indispensable.

COMPLETE SHIELDING OF NOT ONLY THE COILS BUT ALSO OF THE TUBES ADDS TO THE OVERALL EFFICIENCY OF THE RECEIVER'S OPERATION. SOME IDEA OF THE GENERAL ASSEMBLY OF THE PARTS WITHIN THE SHIELD CAN MAY ALSO BE GAINED FROM THIS VIEW

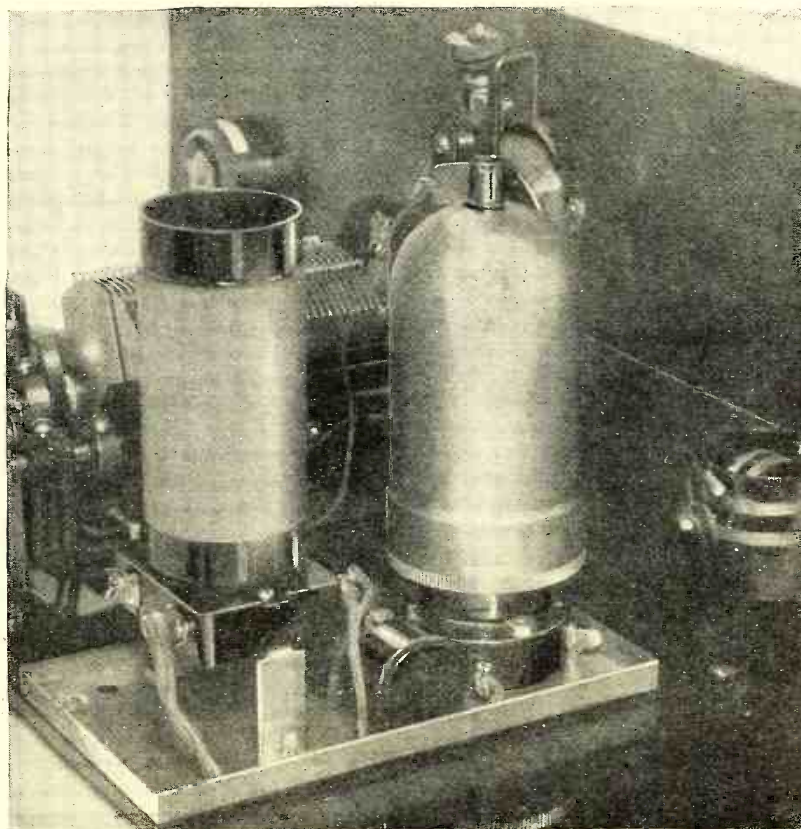

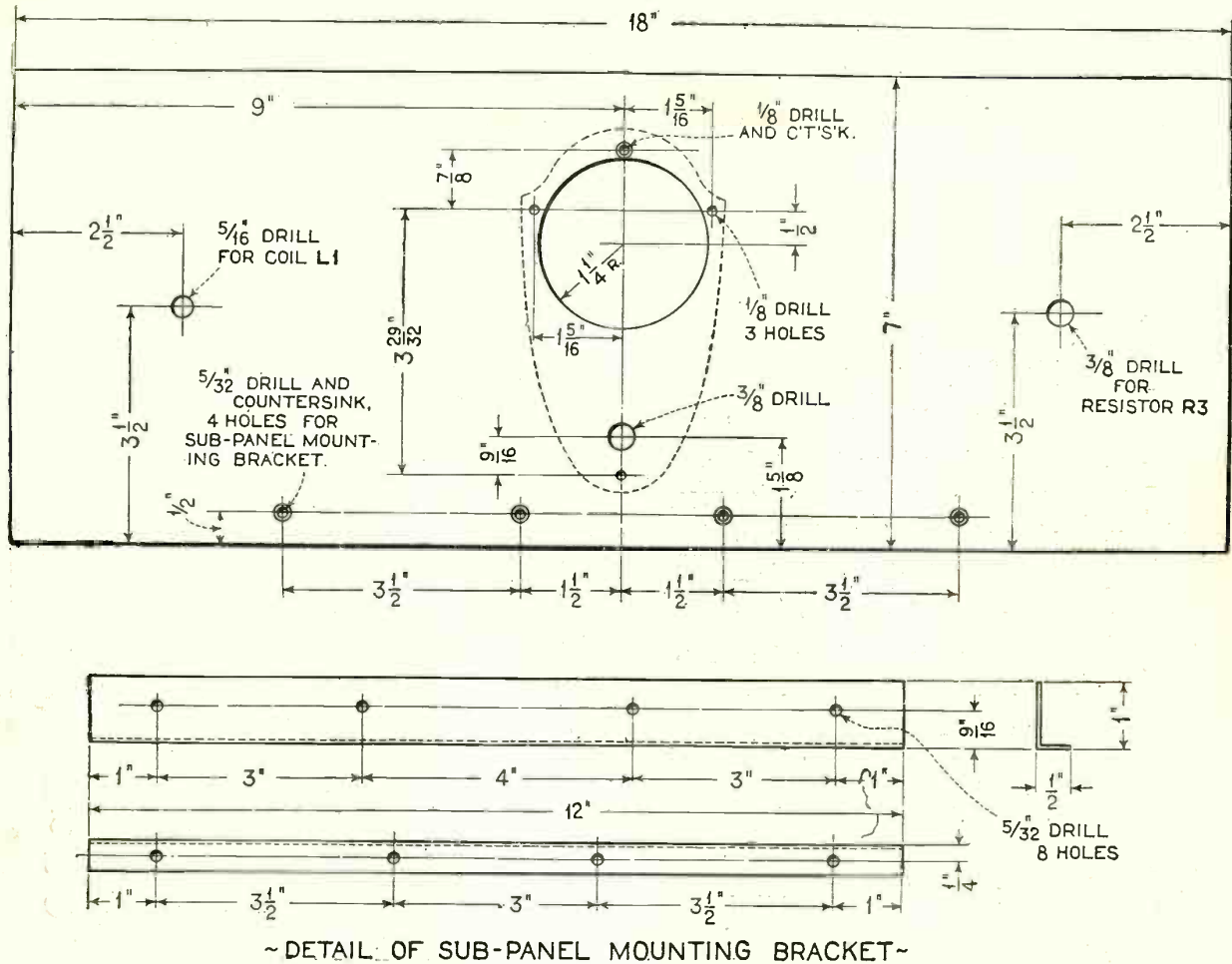

FIG. 3—THE DIMENSIONS OF THE PANEL MOUNTING BRACKET AND THE MAIN PANEL SHOULD BE CAREFULLY OBSERVED IN TRANSFERRING THE LAYOUT TO THE PANEL SO THAT THERE WILL BE NO CHANCE FOR ERROR

have been mounted by means of 6/32 machine screws, the two can bases should be put in their respective places on the sub-panel and fastened there.

Then, from the drawings and photographs note the position of the .5 mfd. by-pass condensers and mount them accordingly. Following this, the resistance coupling mount and tube socket for V3 may be put into place and fastened. Finally, the binding posts are inserted in their respective holes.

When the sub-panel assembly is completed, then the attention of the builder may be given to the main panel. First, it should be fastened to the sub-panel. For this purpose, flat-head 6/32 machine screws are used, preferably with nickel-plated heads so as to lend to the appearance of the panel.

Next, the dial mechanism is put in place. For this job it is well to read over the instructions which are furnished with the dial and proceed accordingly. After the dial mechanism is put in place, the tuning condenser unit may be located. To do this, it will be found necessary to remove the vertical metal strip from the rear of the dial, fasten the condenser in place to it and then replace on the dial mechanism. The antenna compensator

and the variable resistance which is used for the regeneration control may then be mounted on the back of the main panel. This completes the assembly.

Wiring

In connecting the various units within both the shield cans, the wires are so placed as to be contained either directly in the cans, or, where connections are made from one to the other, then the wires are passed through holes in the sub-panel and run underneath it. This method of wiring, besides making for a neat, clean-looking appearance on the top side of the sub-panel, also allows easy removal of the can walls for access to the contained apparatus.

For wiring the complete receiver, a type of wiring is used which lends itself admirably to the cabling and twisting of pairs and associated circuit wiring. Stranded braidite is the wire used and possesses, among other advantages, that of being easily soldered due to the complete coating of tinning on the wires. Also in making soldered connections, the insulated braided covering is very easily slipped back and then pushed up close to the joint once the soldering is completed.

In wiring the receiver, a definite system of procedure is found to be desirable as an aid in this important job. First, wire all the filament circuits; then the plate circuits and then the miscellaneous circuits such as by-pass circuits, etc.

It is well in wiring the filament circuits to use two different colors of wire; then it is easy to distinguish which one of the pair should be paralleled with the filament leads coming from another socket. The worth of such a procedure is all the more appreciated when it is considered that to insure against production of hum, all the filament leads should be twisted.

In making soldered connections, be sure that not too much flux is applied to the part to be soldered. Otherwise, if too much is used, then it will flow all over the terminal as soon as heat is applied. In the operation of the receiver, such misuse of flux is usually the cause of much crackling, disturbing noise.

Connections to the by-pass condensers are made in the following manner: The terminals of each of the by-pass condensers are connected to the mounting screws which fasten them to the sub-panel, then connection of the other leads to the condensers is made to the screws underneath the panel.

Voltage Requirements

The voltages required for the various tubes are as follows: Screen-grid radio-frequency amplifier, 180 volts on the plate, "plus 75 volts" on the screen grid; detector, 250 volts on the plate (through resistor R4), "plus 75 volts" on the screen grid (the resistance R6 provides the correct "C" bias voltage); first audio stage, 180 volts on the plate.

Parts List

- C1, C2—Remler two-in-line gang condenser, .00035 mfd.
 C3—Aerovox fixed condenser, .0005 mfd., No. 1450.
 C4, C5, C6, C7, C8, C9—Aerovox by-pass condensers, .5 mfd., No. 250.
 C10—Aerovox by-pass condenser, .1 mfd., No. 250.
 L1—Remler antenna compensator, No. 502.
 L2, L3, L4, L5—Remler r.f. chokes, No. 35.
 T1—Remler r.f. coil, No. 562.
 T2—Remler detector coil, No. 564.
 R1—Electrad wire-wound grid resistor, 400 ohms.
 R2—Electrad truvolt resistor, 10,000 ohms.
 R3—Electrad royalty variable resistor, 0-2000 ohms.
 R4—Lynch plate resistor, 250,000 ohms.
 R5—Lynch grid resistor, 1 megohm.
 R6—Electrad truvolt resistor, 2000 ohms.
 R7—Aerovox center-tap resistor, 20 ohms, No. 985.
 Two Remler sockets, No. 50 (for coil mounting).
 Two Remler tube ballast shields, No. 55.
 Three Remler a.c. "Y" sockets.
 Two Remler shield cans, No. 720.
 One National dial, type E.
 One Lynch double resistor mount.
 Nine binding posts.
 One Lignole walnut panel, 7 x 18 inches.
 One bakelite sub-panel, 7 x 18 inches.
 One piece angle brass, 12 x 1 x 1/2 inches.
 Three boxes Corwico stranded braidite.
 Two '24 screen-grid tubes, V1, V2.
 One '27 tube, V3.



ABOVE IS THE RECEIVER HOUSED IN THE COMBINATION RADIO-PHONOGRAPH CONSOLE CABINET. FULL INSTALLATION DETAILS FOR THE COMPLETE OUTFIT WILL BE PUBLISHED IN LATER ISSUES OF RADIO NEWS

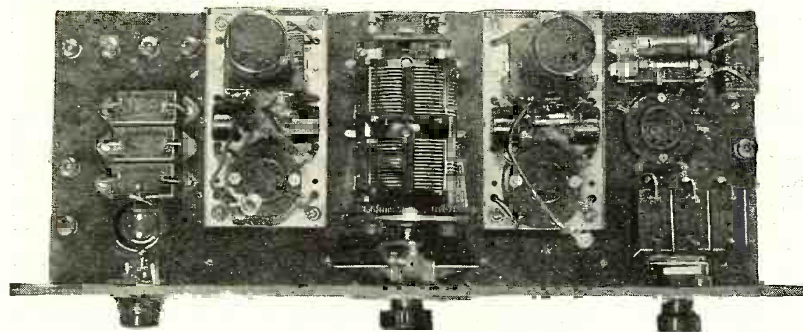

AT THE LEFT—LOOKING DOWN ON THE SUBPANEL LAYOUT OF THE COMPLETED RECEIVER

BELOW—THIS SHOWS HOW THE A.C. SCREEN-GRID '24 TUBE IS INSERTED IN THE TUBE BALLAST SHIELD



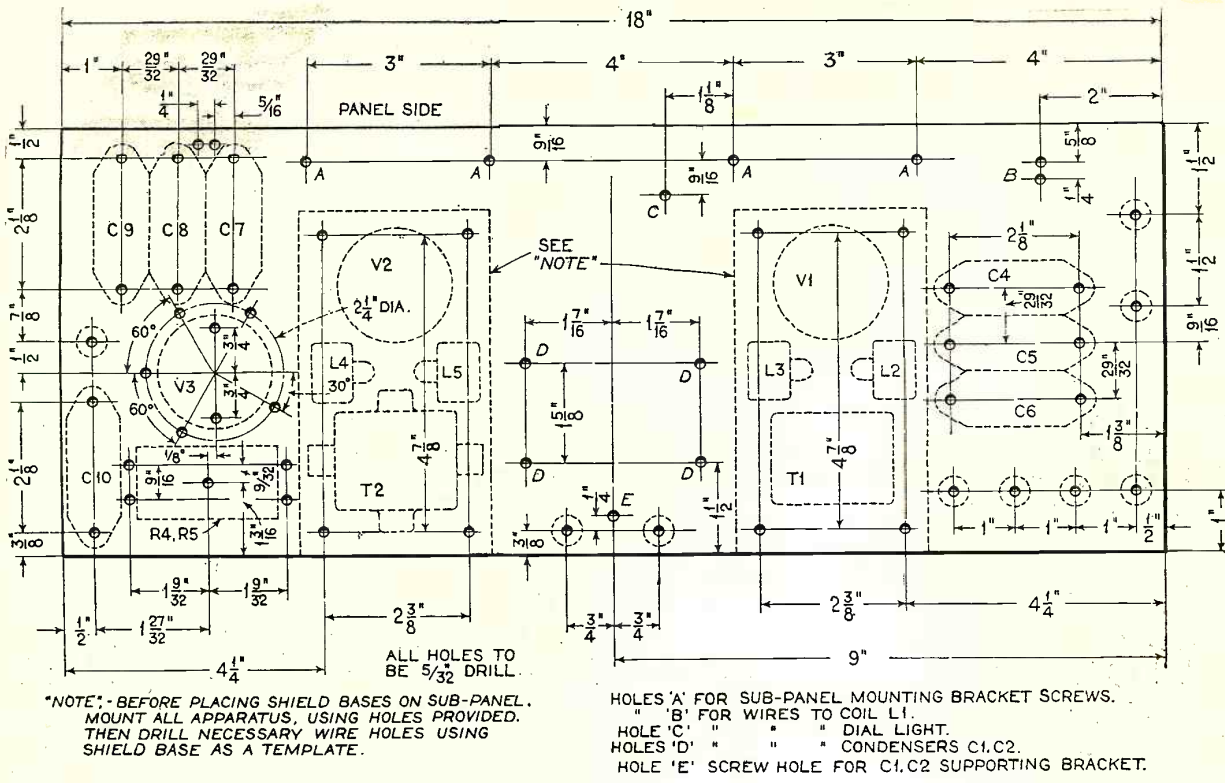
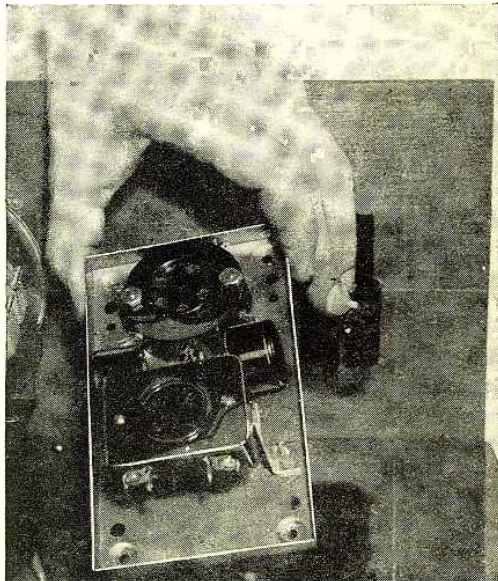

FIG. 4

NOT ONLY ARE THE POSITIONS OF ALL THE MOUNTING AND WIRING HOLES FOR THE SUBPANEL GIVEN HERE BUT ALSO THE ACTUAL POSITION OF THE SHIELD CANS AND OTHER ASSOCIATED APPARATUS IS SHOWN. AS IN THE LAYOUT OF THE MAIN PANEL, IT IS A WISE MEASURE TO BE EXTREMELY CAREFUL IN THE POSITIONING OF THE VARIOUS MOUNTING HOLES

THE PARTS WHICH GO INTO THE BASE OF THE SHIELD CANS ARE FIRST MOUNTED THEREIN BEFORE THE BASES ARE MOUNTED IN PLACE ON THE SUB-PANEL. THE MOUNTING SCREWS ARE PASSED UP FROM THE BOTTOM OF THE BASE AND FASTENED BY NUTS ON THE TOP SIDE OF THE CAN BASE



Operating Notes

Let us assume that the antenna and ground, the various "B" and a.c. supply leads and a power output stage of accepted design have all been connected to their respective terminals on the receiver. Once the power has been turned on, the first thing to do is to see that the dial reads maximum for the setting of the tuning condensers with the plates completely meshed. Now, advance the regeneration control R3 until, by touching the grid side of the detector condenser, a plucking noise is heard. Then, slowly rotate the dial until the station's carrier is picked up. Due to the advanced condition of regeneration, it may be necessary, in order to receive the station clearly, to retard this control, but only after the station's carrier has been tuned in. Now, with the wooden screwdriver supplied with the condensers, make slight adjustment on the balancing condenser of the detector stage (the balancing condensers are mounted on the frame of the main tuning condenser between the sections for the radio-frequency and detector circuits). Make this adjustment by turning the screw head first one way, then the other. If at one point of this operation the signal is received louder, it is an indication that originally the detector condenser was slightly detuned from resonance with the radio-frequency circuits and required the assistance of the balancing condenser to make both circuits peak at the same frequency. This operation should be tried at several points on the main tuning dial and it may be found that it will be necessary to adjust the balancing condenser of the radio frequency circuit too.

In case regeneration does not occur, it may be found necessary to reverse the leads to the tickler coil, although if the wiring as shown is followed out, there should be no need for this procedure. The antenna compensator will be found most useful in aiding the tuning in of signals from a distant station. Not a great deal of effect is noted when the control is adjusted during reception of local signals. In the next article will be described the construction of a two-stage power amplifier-power supply unit, and also instructions will be given showing how the com-

plete receiver, tuner and amplifier may be mounted in a console cabinet which also houses an electric phonograph with magnetic pick-up. Beyond this there are several other very interesting adaptations to which the RADIO NEWS Foundation Tuner will readily adapt itself, such as a compact all-wave receiver, utilizing plug-in coils for both the short-wave and long-wave bands and as the nucleus for a compact superhet. Future issues of RADIO NEWS will "cover" these variations of this aptly named "foundation unit."

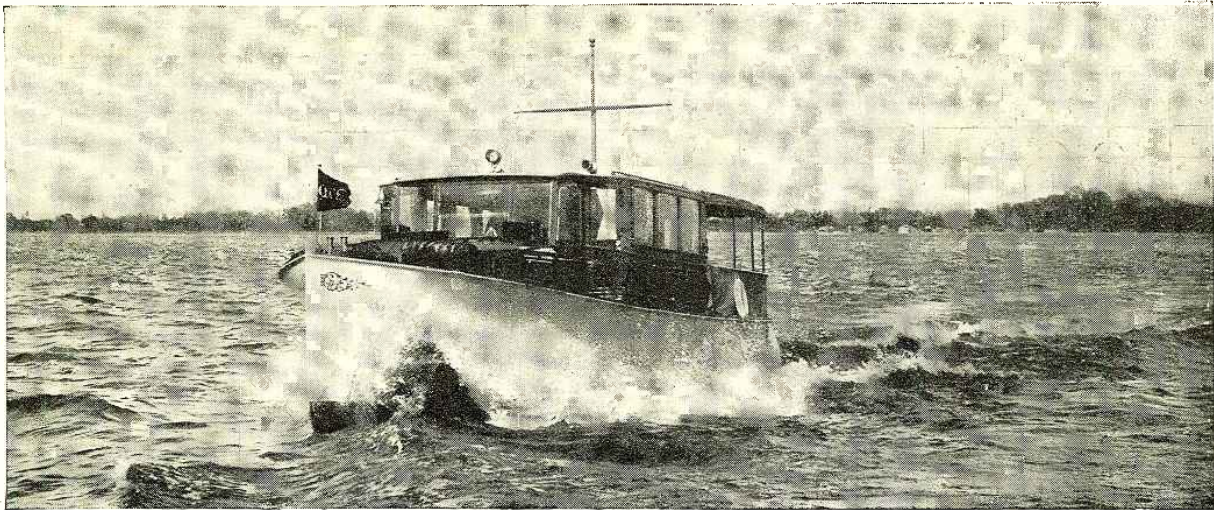

Photograph Courtesy American Car and Foundry Company

Why Not Get *the* Utmost from on your *Pleasure*

By Lloyd Jacquet

ALL is shipshape aboard *this* boat for that long contemplated vacation cruise. Personnel has been carefully chosen with mature consideration of inhibitions, reflexes and complexes; the stores have been replenished; the gear stowed away; the bright work polished; the chronometer wound up and checked—everything ready to get under way now, except the radio.

At the last moment someone suggested that there ought to be entertainment on tap aboard, and of course that meant a radio receiver. Either somebody was to deprive the home of a set or the radio engineer of the crew had to steer a course for the nearest dealer and purchase an apparatus for the trip.

The bundle of tubes, wire and set lashed to his after part, the radio man comes aboard and triumphantly installs the music box that will, he hopes, solve the question of leisure hours of the voyage. A small aerial is hastily rigged up, a corner found for the instrument, connections made to the craft's electric line, the switch flipped and a program tuned in! He reports to the skipper, and now *everything is ready* for the cruise. . . .

Squalls Ahead

There's trouble lurking ahead. What the landlubber radio man didn't know about the tricks that the sea can play on

his pet he will learn before the cruise ends.

He hasn't taken into consideration the corrosive effect of the sea air, which tarnishes to a finish the fine wires in a radio set after several weeks or months. He hasn't thought about the probable ignition noises, if the driving power is of the usual gas-motor type, which will make the radio useless as long as the engine is running.

This same engine that may cause electrical noises will bring about vibration to which his radio tubes will respond in a dispiriting way; and, if the set is not solidly built, will make it rattle like an existing 1914 Ford.

Very likely, in the haste or neglect of installation, the receiver's box is very handy for the idle hands on deck to turn on and tune, but in a devil of a position for the pilot who wants to see his course and properly steer the ship. Also, every time someone goes down the passageway, he is sure to bang his knee against the control knob, so that soon one or the other will have to be serviced.

The least little storm encountered may take away the flimsy aerial construction. At a time when the skipper may want the radio the most for weather reports and storm warnings, it will be inoperative

and as useless as so much dead wood.

Besides, the sea-going members of the crew rather look down upon the entire rig. It is neither shipshape nor sea-going. It looks as though it were out of place in the clean-smelling, varnished space of the pilot house. What they look for is that spot of bright work that makes it look like a marine gadget that *belongs*. Ordinarily, they would not ship nor sail with anything as landlubberly as this.

There is, as any voyager will tell you, a typical "look" about the apparatus that is hung about a wireless room, even aboard the most modest tramp steamers. It is massive, capable-looking. It has a sea-going appearance and is constructed so that it will work reliably whether it is receiving a press report or the answer to an S O S the operator has just transmitted.

Makeshifts Not Suitable

Yachting and motor-boating enthusiasts, who also know their radio, will tell you that an installation, to be useful, must have practically "grewed" there where it is, on board. It must be designed for the job and adapted to the conditions that vary with the boat.

Ferrying the family receiver to the

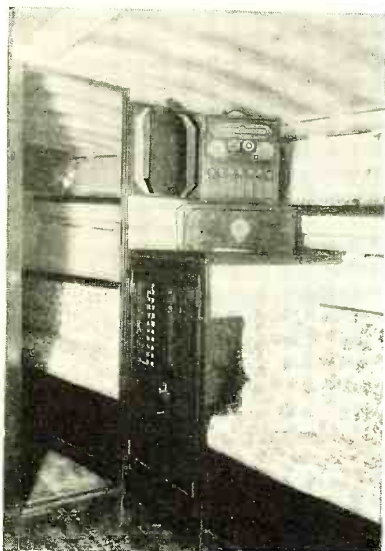

Radio Boat?

RADIO CAN ADD IMMEASURABLY TO THE PLEASURES OF SMALL BOAT CRUISING. THE USE OF A PORTABLE RECEIVER, HOWEVER, IS NOT AS SATISFACTORY IN THE LONG RUN AS A MORE PERMANENT INSTALLATION OF SPECIAL DESIGN

cruiser will not do any good. It is far better to construct a set specially for cruising purposes. Some portables are suitable, but their performance, on the average, does not come up to that of the really sea-going gadget that takes its place in value and importance next to the compass, the barometer and the anchor!

A well-designed set for the small boat or yacht defeats every one of the difficulties that would ordinarily beset it, were it of the common variety as used on land. It is impervious to moisture and outside noises, fits in the most limited space on board, and works whether the engine wants it to or not.

Some Specific Troubles

Salt water, sailors will tell you, gets into everything sooner or later. It will get into an ordinary receiving set. There it will start its corrosive action against sliding and wiping contacts. It will tackle the prongs of the tubes and the fine wires of the coils and transformers. There, where a manufacturer has been shortsighted enough to use an acid flux for soldering, the havoc will be great and the set exceedingly noisy.

There are alternate very damp and cool days afloat. In a way that will appear mysterious to the fresh-water seaman water condenses on everything metallic. The inside of a radio is no exception.

Pasteboard coil forms will resent this. So will the hygroscopic material that served to bind the coiled wire . . . and the poorly glued cabinets of wood that house the apparatus.

There is no way to prevent the corrosive action of the water or moisture from forming. But both can be very much minimized. Coils and condensers,

transformers and other units should be placed in individual cases. The general shielding now indulged in might be satisfactory by way of illustrating this point, although bakelite with metal lining for the shielding itself would be preferable to the all-metal cases.

Joints that have been soldered should be painted either with an insulating var-

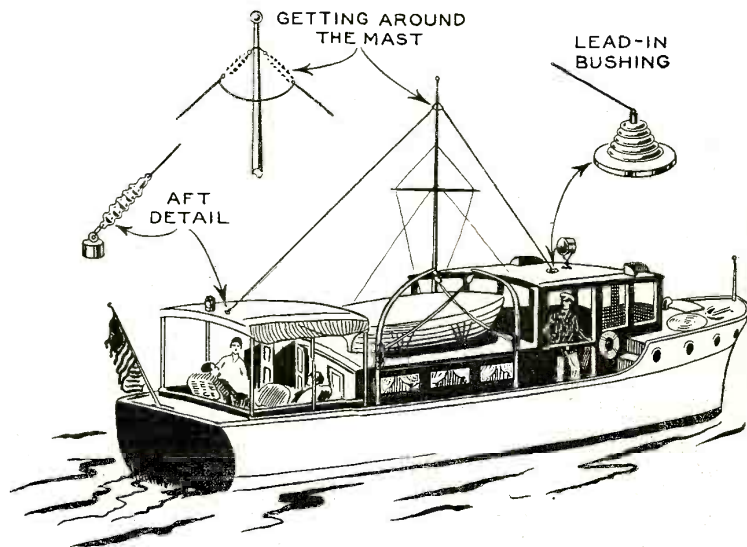

AN ADEQUATE RADIO ANTENNA INTERFERES IN NO WAY WITH EITHER THE LOOKS OR THE OPERATION OF THE SMALL CRUISER

TERMINAL BOARD

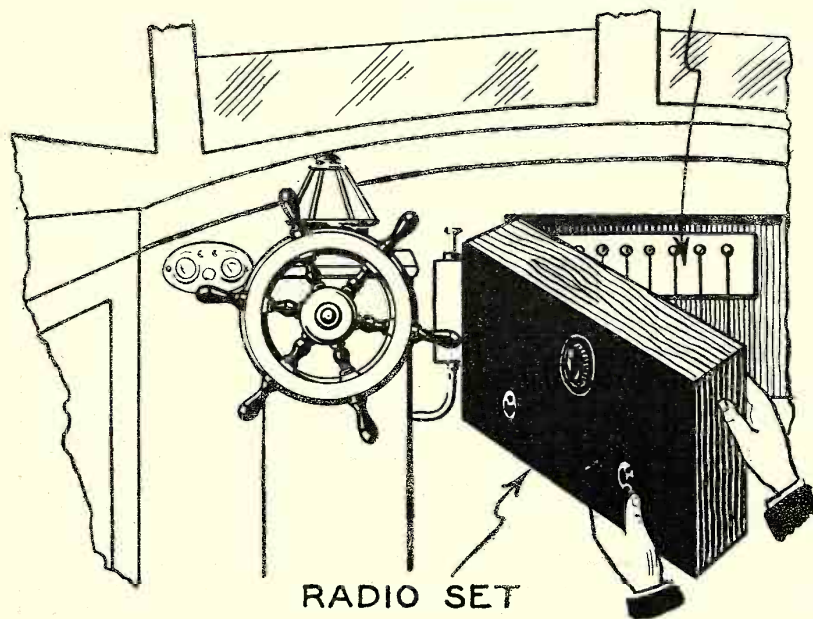

FOR BULKHEAD INSTALLATION THE RECEIVER DESIGN SHOULD BE AS THIN AS POSSIBLE FROM FRONT TO BACK.

nish, such as shellac, or with asphaltum paint, or they may be treated to a paraffin bath. Vaseline on binding posts assists also in preventing local erosion. Paraffin, also, has other applications in this connection, depending upon the details of construction of the receiver.

Corrosion due to electrolytic action of dissimilar metals is found most frequently on shipboard. When a ground connection is made, this situation is most likely to occur. The ground should be positively made and the joint painted, as suggested above. As it will, by reason of its location, be more subject to corrosion than other parts of the radio installation, it should be inspected regularly.

Vibration on a small ship is quite noticeable. It is, in fact, detrimental enough so that microphonic noises will be developed in a radio set if not properly taken care of. Fortunately, this is not a major problem, since the most ordinary care will eliminate this trouble. A few pieces of sponge rubber under the set will usually cure the trouble. Of course, in a specially built receiver provisions will have been made to correct this within the cabinet, by means of cushion sockets, proper sub-panel suspension and bump-proof panels.

Besides the electrical noises, the radio instrument may have to compete with physical noises from the motor. The solution is an improved motor muffler on the exhaust or better sound insulation with the engine room. Placing the set in a part of the boat where noise is at a minimum is obvious, but not always practical nor desirable.

A graver problem is, of course, the ignition noises. Much work has recently been done on this, particularly in the automotive and aviation fields. The only way to eliminate the pick-up of electrical vibrations set up by the spark system of

the gas engine is by careful shielding of the conductors.

It will be noted that the noise is less obvious as the set is removed from the proximity of the leads. If the engine is remote enough, the noises may not be objectionable. In most small boats, however, there is not great choice in space, the engine room being amidships.

Shielding the ignition system is a tedious job, which will well repay in the trouble taken later on. The work is quite simple and detracts in no way from the performance of the engine once it is completed. All of the wires in the entire ignition system are encased in a metallic shield, such as braided copper, and thoroughly grounded. The shielding must be complete, with no part of the ignition wiring escaping. Where several pieces of shielding tubing is found necessary these pieces, to make the job effective, must be electrically bonded.

Another method of controlling the noises is to introduce choke coils in the filament current supply leads and place a large fixed condenser across them (the leads, not the chokes). Choke coils for this purpose, as well as condensers, are readily available on the market. If an adequate shielding job can be done, it will be much preferable, however.

Of course, if the ship is a sailer, or powered by steam or Diesels, all your troubles will be absent, and you may proceed as though you were on land with the installation.

Powering the Receiver

Securing power to run the set is the next problem. It is best practice to follow the lead of the commercial installations so far as concerns the "B" or plate supply and to use batteries. If the ship is a large one, and has a complete 110-volt generating set, the battery eliminator idea may be entertained. However, the direct current system that is on most ships may make it difficult to design an

adequate control panel for the average radio installation. Time, space, energy and money will be saved by using batteries. So far as we consider the filament supply, the usual 12 or 32-volt battery, which energizes the small boat's lighting system, can be used to advantage.

This is of interest, because the filament plug can be fastened into the nearest receptacle on board, thereby saving considerable wiring mess to the control panel in the engine room through difficult places and quasi-inaccessible corners.

Most experimenters tap the battery and use only the six volts they need for the filament circuit. This is not considered the best practice, as it will wear down the one cell used faster than the others. A better plan, which is followed by the best shops today, is to place a suitable resistance across the line, tapping off the potential needed.

The Receiver's Pick-up System

Antenna and ground installations on board the average small boat present a problem to the skipper. Space is limited, masts are usually to be used for something else that radio wires, deck space is restricted, and an aerial is anything but shipshape.

With the new type receivers, employing the very sensitive screen-grid type of tubes, the antenna can be cut down in length very appreciably and certainly within the restrictions that are imposed upon the installer aboard a small craft. With the usual kind of receiver, the antenna problem is still the same old one, and length will have to be made, somehow or other.

Antenna design is an art by itself, which becomes a thing of particular beauty when the small boat is considered. Most installations on board craft of 50 feet or less are usually of the multi-wire variety, bunching together fore and aft, using the yard arm of the only mast amidships to spread the wires apart. Husky insulation is provided, giving the entire installation a top-heavy look which is most uncomfortable and unnecessary.

It is desirable to make the aerial as inconspicuous as possible. A single wire, running fore and aft, insulated with small, well-nigh invisible glass insulators, will not detract from the maneuvering or operating characteristics of the boat. Signal flags can be run up without interference and the searchlight played freely. The thin wire that is the aerial adds to the rigging, and everybody is happy.

Multiple parallel wires are unnecessary, from an electrical standpoint. The lead-in is placed to reach the set at best advantage. It is taken along the aerial, well soldered, and brought down into the cabin through an insulating bushing specially made for the job. If a receiving set only is to be used, it need not be particularly heavy in construction. But it should be shipshape, in so far as the installation is concerned, for no water should seep into the cabin through this hole.

Making ground on a boat is probably very easy. The usual practice is to run a connection to the engine block or to any metallic piping to the water. The ground should be run as directly as possible. It need not be insulated. The connection to

the metal should be particularly thorough, well painted with an insulating varnish and taped. Corrosion can give a lot of trouble at this point.

Phosphor bronze wire, of the type used in commercial installation, will give the long service that is anticipated. Copper wire will service well also. Iron wire is, of course, out of the question, even though galvanized or copper coated. Sooner or later it will begin to rust.

Receiver Design Considerations

Probably the most neglected of all factors in small boat set design is the size and weight. While the latter factor is not of great importance, still the skipper will want to take into consideration every pound of unnecessary gear he may ship above the water line as well as below. A complete radio installation may add a hundred pounds or more, which must be considered is servicing is needed.

Assuming that a place has been found for the radio, an opening should be made in the bulkhead or a siding into a closet provided, so as to get the face of the instrument as flush with the paneling as

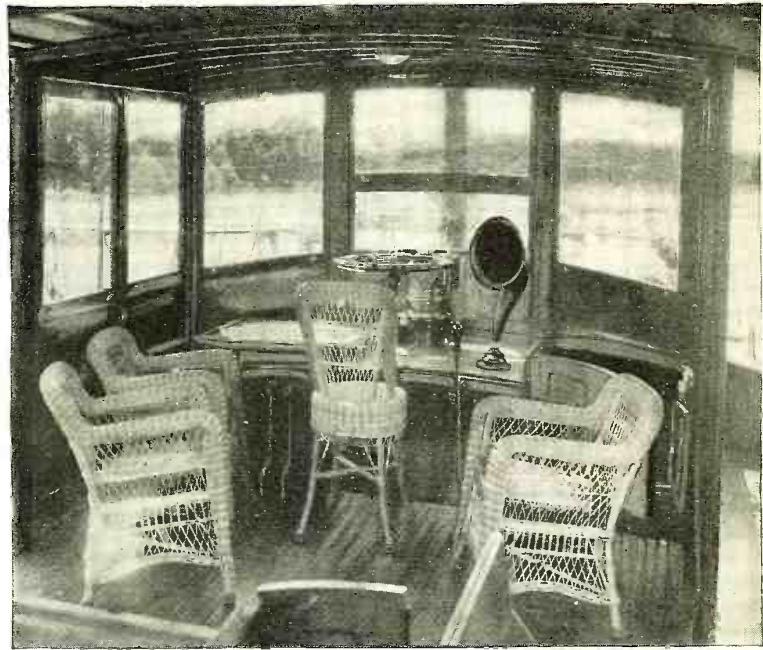

IT IS A SIMPLE MATTER TO PROVIDE MORE THAN ONE SPEAKER OUTLET, WHILE THE SET ITSELF CAN THEN BE PERMANENTLY INSTALLED IN THE MOST ADVANTAGEOUS LOCATION



IN SOME CASES ADVANTAGE MAY BE TAKEN OF EXISTING CUPBOARD OR LOCKER SPACE WITHOUT IN ANY WAY DETRACTING FROM THE CABIN FITTING

possible. Many pilots will want the radio in the pilot house, so that valuable weather information can come to them directly while on watch. Others may want to place it in the forward or after cabin.

Space is at a premium on ships. So as to place the radio as close to bulkheads as possible, it should be made flat. Compactness is required in the depth of the cabinet. The height and the length are not as important, although they too must be considered in the design.

The terminal board for all wires and batteries should be brought as near the instrument as possible. Probably enough space will be available in back of the instrument's opening, in which case it will be out of the way. Otherwise a neat bakelite piece with nicked terminals immediately below the set will add to the looks of the installation.

Entertainment No Longer the Sole Feature

Using the radio installation is quite another problem. It is while at anchor that time begins to weigh. Then the radio can be turned on for entertainment, and if everything has been well done in the installing, the enjoyment will be the reward.

Skippers are learning more and more to use the radio for their navigation and information. A knowledge of the code is not necessary to pick up weather warnings, which are sent out in bulletin form by most broadcasting stations at regular hours daily. Neither is it difficult for the average mariner to tune in and regulate his chronometer by the radio time tick.

There is the story of a yachtsman who won one of the Bermuda races, because he checked his two chronometers by radio

time signals, found out which was in error, and was able to keep accurately on his course, shortening his running time sufficiently to win the race!

Only recently there has been available a small direction-finding jigger for small yachts, which makes it possible for the amateur boatman to correct any error that may be in his compass or to feel his way about even in densest fog.

Transmitters for small boats will undoubtedly become more and more popular as their owners learn their value. Ultimately, with the general acceptance of the Hague Convention deliberations, it may become necessary for all ships carrying passengers to be equipped with radio, both for transmitting and receiving. In anticipation of that event, many yachtsmen are placing wider and wider confidence in compact short-wave apparatus that enables them to be in constant communication with other small ships and with shore. Thus protected, cruising with small ships takes on an added charm and is bound to spread.

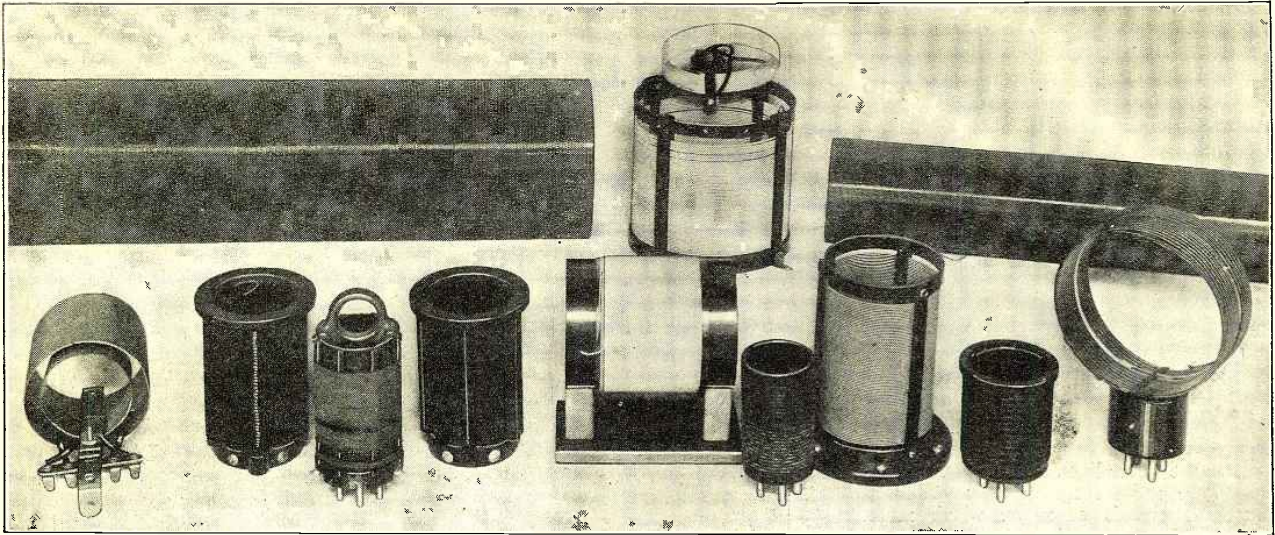

INDUCTANCE, RESISTANCE CAPACITY

and What They Mean to

Coil Design

By C. P. Mason

SIMPLICITY is sometimes deceptive. In witness whereof, we point to the humble coils of a radio receiver—a few turns of wire on a tube, or sometimes hanging in empty air. And yet the electrical and magnetic actions taking place inside them and around them are among the most complicated phenomena over which scientists make long word investigations, and radio engineers burn the midnight oil.

It is not the purpose of this article to go too deeply into the subject—or even within a measurable distance of its theory. But this may be taken by the beginner as an attempt to explain some elementary principles of the use of coils in radio work. There is no subject more interesting to the practical constructor; as attested by the thousands of letters which this office receives yearly, asking “How many turns of wire on this coil?”

First of all, what is a coil? What is its use?

A coil (in radio practice at least) is an instrument for the concentration and control, within a compact space, of a measurable quantity of a certain electromagnetic property called *inductance*, which is necessary to direct alternating currents into the path they should follow. For that reason, a coil is often called, rather improperly, an “inductance.”

Uses of Inductance

Inductance is not utilized solely in radio—far from it. Every electric motor—even the simplest form, such as a door bell or a telephone receiver—employs in-

ductance as indispensable to its operation. We might as well call the windings around the magnet which move the striker of the bell, or vibrate the diaphragm of the telephone, an inductance. They are as much so—and have a good deal more of that essential property—as the inductance coil we call a radio-frequency transformer. The latter has a very small amount of inductance, for a reason which we shall explain later—that it must respond to a current which alternates almost inconceivably faster than that in the bell magnet, or the telephone windings.

What, then, is *inductance*? Why is it to be found in a coil of wire?

It is true that even a straight wire has inductance. That in an aerial is measurable; but the same reason, that leads us to wind a wire on a spool to carry it around leads us to wind it up in order to concentrate its inductance into a convenient space, so that we can control it in our radio set. There is another important advantage; when we wind the wire on a spool, we do not increase or diminish its actual length (so far, for instance, as its resistance goes), but we do greatly increase its inductance, as will be shown soon.

Inductance is that property in a wire—or any other conductor of electricity—which *opposes any change in the amount of an electric current flowing through it*. If we turn a current of electricity into the wire, it is at first opposed by the in-

ductance. After this has been overcome, and a steady current has started to flow, the inductance will oppose any endeavor to shut off the flow of current; as, for instance, by disconnecting a battery attached to the wire.

We may here make a comparison of our current with a train of cars on a railroad track; a good deal of pull—or push—is required to set them in motion. But, when they are once under way, a good deal of force will be required to stop them. This phenomenon—which works both ways—is called *inertia*. So, also, inductance is an *electrical inertia*.

If our long train of cars were on one of the “roller-coasters” popular in city amusement parks, it would be spread out over a good many curves; some cars would be at the top of a steep grade, ready to roll down hill; some would be at the bottom and would have to be pushed uphill in order to move them at all. The reader might see, at first glimpse, an analogy to the movement of electricity in a coil whose turns are at different *voltages*. But there is an important difference.

The Field

The cars on our roller-coaster only push or pull each other along the line of the track. A car on a curve does not pull sideways on one going by it on another track. But, when a charge of electricity is moving along a wire, it has an effect outside the wire which may be felt for a long distance. If this were not true, it would be impossible for a signal

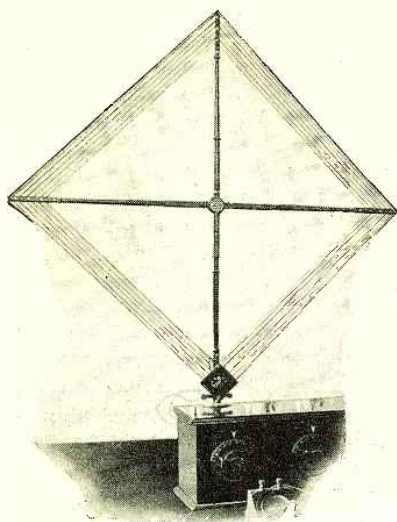

THE LOOP AERIAL IS ONE FORM OF INDUCTANCE, BEING NOTHING MORE THAN A COIL OF LARGE PHYSICAL DIMENSIONS

sent out from an aerial in Pittsburgh or Schenectady to be received on another in Australia or Antarctica—as we know it can be.

The reason is that every moving *particle of electricity* (“*electron*”) has a moving “*magnetic field*”; and this magnetic field has an influence, perceptible to a very great distance, on other electrons which tends to influence their motions. At very short distances, a current moving in one wire and changing its intensity and direction of motion will set up a somewhat similar and strong current in another wire; this effect is made use of in the familiar power transformer. If the two wires are free to move, they will push or pull each other—an effect made use of in the electric motor. If they are moved with relation to each other, while carrying steady currents, additional current will be generated, as in the dynamo.

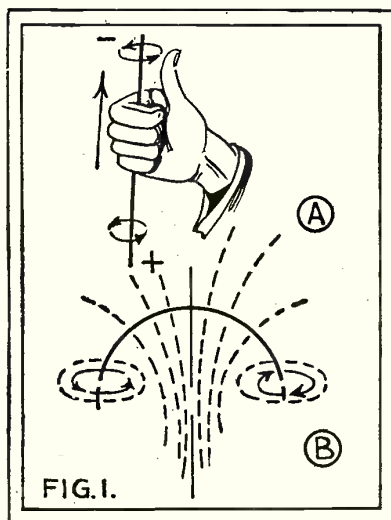

A SHOWS THE DIRECTION OF THE MAGNETIC FLUX WHEN THE CURRENT FLOWS IN THE DIRECTION OF THE THUMB. B SHOWS THE MAGNETIC FIELD OF A SINGLE TURN OF WIRE

The wire in which a current is flowing is surrounded by a magnetic field, as said before. So long as this field remains steady (after the necessary expenditure of force to create it has been completed) it produces no further effect upon its surroundings. For that reason, as our readers who have direct-current lighting service know, we cannot use a transformer to “step up” or “step down” direct current.

But, when we shut off the current, the steady magnetic field which surrounds it “collapses”; the pull and push which it has exerted upon all electrified particles around it weakens, and they begin to rearrange themselves. When they do so, they in turn create a flow of current.

Now, an alternating current may be taken as a series of direct currents turned on and off, *alternately*, and flowing first in one direction and then in the other. At the beginning of each *cycle* there is no voltage (“*electromotive force*”) across the ends of the circuit to which our generator is connected. The current is turned on, and builds up with increasing voltage applied, but not so fast as does the voltage; because the *inductance* of the circuit opposes the flow of current. When the voltage has reached its height it begins to decline, but the current then feels the effect of the *inductance* of the circuit, which tends to keep it moving. For that reason, the current “lags” behind the voltage. Finally, the voltage sinks to zero. All this, with an ordinary a.c. lighting line, has happened in 1/120th part of a second.

Now then, if the voltage were again applied to the same terminals *in the same direction*, we would have a *pulsating current*; such as that which comes from a rectifier in a radio set. But, in an alternating-current system, it now reverses its direction; the terminal which was formerly “+” now becomes “-”, and vice versa; and the current starts to flow backward. It builds up, again lagging behind the voltage, and falls again to zero. The process is then followed again from the other end, and so on till the generator is shut down.

“Self” and “Mutual” Inductance

In a radio circuit we have the same process of alternations of the voltage and current, but thousands of times faster than in a lighting circuit. We may have alternation at the rate of from ten thousand to twenty million, or more, cycles in a second. The conditions which we encounter will be different *in value*; but, however great the frequency, the inductance of the circuit will always tend to resist an increase in the flow of current, when it is building up, by increasing the load upon it; and it will always tend also to resist a decrease in the flow of current, by feeding back energy into it.

This is the “*self-inductance*” of the circuit; but if another circuit is near it, and in the proper position, we shall find that the inductance of the first increases. This is because the current in the first circuit carries not only the load of putting itself in motion, but also the load of putting in motion a current in the second circuit. This is counterbalanced by the fact that, when the first current is

beginning to drop off, the second circuit begins to feed back energy into it. This reversible effect is the *mutual inductance*; and it is only by mutual inductance that we can transfer energy from one electrical circuit to another which is not directly connected with it—as between the primary and the secondary of a transformer. This mutual inductance is greatest when the two wires or other conductors are approximately parallel to each other, and increases as the distance between them is lessened.

And Capacity

Transfer of energy, however, is not the only method in which the property of inductance is used in a radio receiver. The effect of tuning is obtained by a sort of family rivalry between inductance and its contrary sister, *capacity*.

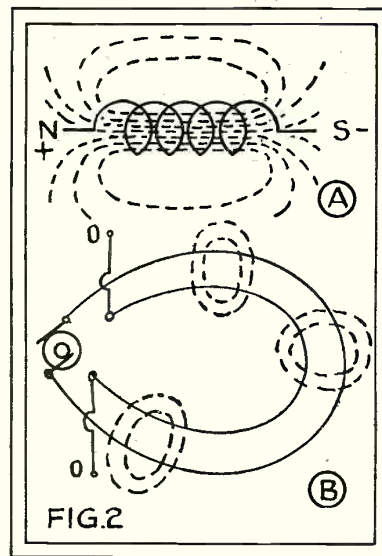

THE DOTTED LINES IN A INDICATE THE FIELD OF AN INDUCTANCE. THE THUMB RULE OF FIG. 1 ALSO HOLDS TRUE HERE. B ILLUSTRATES MUTUAL INDUCTANCE IN TWO COUPLED CIRCUITS

When we turn a current into a wire, by applying an increased voltage across its ends, all the electricity does not remain in the wire. It crowds out all around by pressure from within, as if by attraction from without, into the air or other insulating material surrounding the wire. So that a certain portion of the electricity never gets to the other end. If our current reached a certain steady value and remained there, this truant electricity would remain permanently outside the bounds, except for a slight leakage. This effect may be experimentally tested by charging a large condenser (one-microfarad or up) with a battery. Electricity flows in, but does not pass through. It remains there until the condenser is discharged;—not in the metal plates—as once was thought—but in the insulating layers between.

But, if we remove the electrical “pressure” of the voltage, the *capacitive* electricity will seize the first opportunity to escape—as may be shown by short-cir-

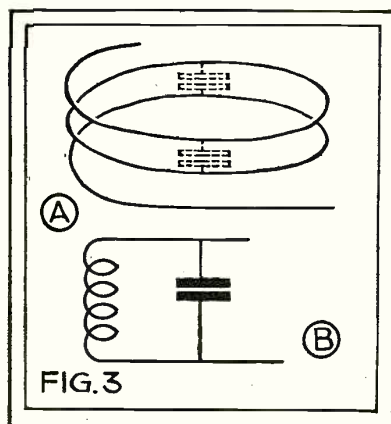

FIG. 3
THE CAPACITY BETWEEN THE TURNS OF WIRE IN A COIL IS SHOWN AT A. THE TOTAL CAPACITY OF THE COIL IS INDICATED AT B

cutting the charged condenser. If we reduce the voltage slowly, the capacitive electricity will flow out in an orderly manner.

There is a third effect which we must take into consideration—resistance. Now resistance does not assist the current, whichever way it flows; it always hinders the flow of current, and takes away electrical energy from a circuit by converting it into heat. The greater the current, the greater the loss of energy by resistance. "I²R loss," as the engineers say.

Imperfect Analogies

Let us take an often-instanced comparison. In a water pipe the flow of water is resisted by the *friction* of the water against the sides of the pipe. In a very long, narrow pipe the pressure is reduced almost to nothing at the far end, purely by the friction of the water. This is *resistance*; and it is lessened as the pipe is increased in size, just as electrical resistance is less in larger wires. An electrical current, however, meets resistance all through a wire, and not merely at the sides. In this case, it is more as if the pipe were filled with pebbles, between which the water had to find its way.

Suppose the pipe to be elastic—that is, made of rubber which would stretch. Then, as pressure was applied, the pipe would increase in diameter, and would take up an increased amount of water before any would emerge from the far end. On the other hand, when the pump was shut off, the contracting walls of the pipe would force out water and maintain a flow for some time. This we may compare to capacity.

In the third place, in order to send water through the pipe, it would be necessary to put all its contents in motion; and, to do this, effort must be expended. When the water was once in motion, however, it would have a speed, and a consequent *momentum*, to be overcome in stopping its flow. This would be comparable to inductance.

Here, however, the comparison fails; because, as we have said, the effect of inductance extends outside of our conductor. We would have to suppose that

the flow of water in a second pipe alongside the first, and attached to a separate pump, would be able to influence that in the first; and vice versa. This effect of magnetism is not paralleled by any other common phenomenon within our knowledge; and we must therefore abandon our comparison at this point.

The "Tuned" Circuit

Let it be enough to say here that the effect of "*resonance*" or the operation of *tuning* in a radio circuit is effected by obtaining a certain proportion of *inductance and capacity, combined*. While either inductance or capacity alone opposes the flow of an alternating current in a circuit, the opposition or "*reactance*" of the capacity diminishes as the frequency of the alternations increases (it becomes infinitely high when there are no alternations, as in a direct current). On the other hand, the opposition or reactance offered by *inductance* increases as the frequency increases (while it is zero to a constant flowing direct current; a coil of wire has no more direct-current resistance than the same length of wire stretched out). More than that, the reactance of capacity and inductance, instead of adding together, *cancel each other*. Therefore, for any given value of capacity and inductance in any circuit, there is some definite frequency at which they balance; and therefore the combined circuit presents no reactance. If its resistance is low, therefore, current of this frequency will alternate back and forth in it readily. We then say that the circuit is "*tuned*" to this frequency.

More than that, if we use half as much capacity and twice as much inductance (or twice as much capacity and half as much inductance) they will still continue to balance; and we shall have a different circuit, yet tuned to the same frequency. Therefore, when we are designing a tuned circuit for a radio receiver, to select a certain frequency out of the enormous number of signals to which it is exposed, we may use our judgment in proportioning the two elements.

It is now customary to use for this purpose two instruments, a coil and a condenser. The coil has comparatively a great deal of inductance and should have as little capacity as possible (it must necessarily have some); the condenser has a great deal of capacity with almost no inductance. By properly balancing their values, we may obtain the best results.

Some Formulas

The fundamental formula of tuned circuits is that the frequency (per second) is equal to 1 divided by 6,2832+ times the *square root* of the product of the inductance in *henries* by the *capacity* in *farads*. The number 6.2832+ may be recognized as the relation of the circumference of a circle to its radius; the "*henry*" and the "*farad*" are the electrical units of *inductance* and *capacity*, respectively. However, for radio frequencies—or even house-lighting frequencies—these units are rather too large for convenience. We may put it this way, instead.

The frequency in *kilocycles* is equal to 159,200 divided by the square root of the product of the inductance in *microhenries* by the capacity in *microfarads*. (A microhenry is one one-millionth of a henry; a microfarad is one one-millionth of a farad.)

The wavelength corresponding to any frequency is often more familiar to the set builder than the frequency. The wavelength in meters is equal to 1884 times the square root of the product of the inductance in microhenries by the capacity in microfarads. If we wish to calculate the capacity in *micromicrofarads*, we use as our final multiplier, 1.884.

However, taking square root is laborious. It is easier to multiply; so here is a simplified formula, more readily useful and quite as accurate, while better fitted to radio frequencies and values.

Square (that is, multiply by itself) the wavelength in meters; divide the product by 3.55. The result is the product of the microhenries of inductance in a circuit by the micromicrofarads of capacity.

(A micromicrofarad is one millionth of a microfarad. Values of tuning condensers in microfarads are more readily

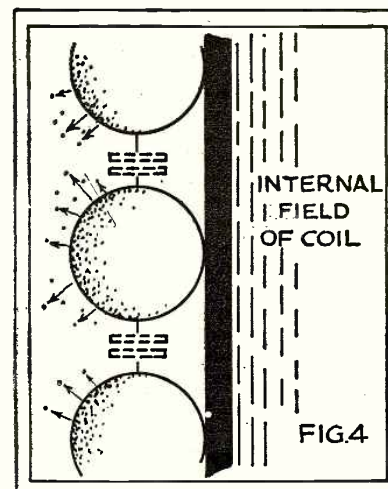

FIG. 4
THIS MAGNIFIED VIEW OF THE SIDE OF A COIL SHOWS THREE THINGS: THE INTERNAL FIELD OF THE COIL, THE CAPACITY BETWEEN THE ADJACENT TURNS AND THE SKIN EFFECT

handled thus: .0005-mfd. is 500-mmfd., or micromicrofarads; .00035-mfd. is 350-mmfd.; .00025-mfd. is 250-mmfd.; .000145-mfd. is 145-mmfd.; .000032-mfd. is 32-mmfd., and so on.)

Coil and Condenser

Now then, to apply our last rule: a tuned circuit to cover the regular broadcast band must go up as high as 545.1 meters. Squaring this gives us 297,135; and dividing by 3.55 shows that we must have such inductance and capacity in the circuit, when the tuning condenser is set at maximum, that their product will be 83,670. If we use a 500-mmfd. condenser, there must be 168 microhenries of inductance in the circuit—that is, in the coil. (This calculation is approxi-

mate, because we have yet to reckon with the "distributed" or "self"-capacity of the coil and the rest of the circuit; which will be far from negligible when we get down to the other end of the dial, as we shall see.)

Similarly, at the other end of the broadcast band, we find that we must not have inductance and capacity in the circuit such that their product will exceed 11,270. In other words, if the inductance remains the same (it really decreases slightly, but this is more than overcome by the effect of the self-capacity) we must be able to reduce the capacity of the circuit to about one-eighth of its former value. This is easy enough as regards the condenser; but the capacity of the coil is the stumbling block on high frequencies. On the broadcast band, however, we should not find this serious.

At 100 meters, however, the product of inductance and capacity is only 2,817; at 50 meters 704; at 20 meters 113; while at 2 meters—and work has been done below this wavelength with a single kink in a wire for a coil—one micromicrofarad of capacity and one microhenry of inductance tune our circuit!

Now then, on the upper band, we have our choice of any of the standard sizes of variable condensers. The 43-plate instruments with .001-mfd. capacity were in style when even longer waves were tuned by the set-building amateur; 500 mmfd. (23-plate) condensers are still in common use, but the 350 mmfd. have now the lead; and from 250-mmfd. we can get instruments down to as low as the 16-mmfd. midgets used in short-wave sets. For any size of condenser we can design a coil with an inductance which will bring the circuit up to our required maximum. What other considerations

then, enter into this simple problem?

A radio receiver, up to the output of its power tube, is a *voltage-operated* device. That is, it generates its own power; but the output of each tube is governed, not by the amount of "signal" *current* of its input, but by the *voltage* which that signal builds up on its grid.

This fact, when we are dealing with the very small current flow in a tube's grid circuit, leads us to design a transformer very different in its purpose from a *power* transformer. If we are to get out of the secondary of the power transformer enough current to light the tubes in our set, we are more interested in the efficiency of its energy (current) transfer. This is not as essential even here, however, as it is in the transformer which feeds many horsepower of energy into a big motor; even with a considerable loss in the circuit, house-current is cheaper than dry-cell batteries for filament lighting.

But in the radio-frequency transformer we need a *voltage* output; the grid circuit draws no current, or practically none. What arrangement of capacity and inductance will give us the greatest voltage on the grid from a given signal?

Design of the Coil

The voltage set up across a coil by a given alternating current increases as the value of the inductance increases (somewhat as the voltage across a resistor with a given direct-current flow increases with the resistance). The tuning condenser charges with the "signal" voltage, and makes it effective across the grid and filament.

Then, if we should use a radio-frequency choke of the familiar 85-milli-henry type as a coil, why would not the voltage obtained across a single tube be sufficient to obviate the necessity of other stages of amplification? A single micro-

microfarad—or a trifle less—would tune it to the highest wave on the broadcast band.

The answer is that it is a practical impossibility to make such a coil with a self-capacity as low as 1-mmfd. For that reason, such a choke is naturally tuned higher than the highest broadcast wave. In some receivers, a choke of this kind is used in the antenna circuit and across the first r.f. tube. We commonly speak of such a circuit as "*aperiodic*" or "*untuned*"; by which we mean that it tunes far above the highest wavelength we wish to receive. It is therefore *unselective*.

The considerations of self-capacity and resistance in the coil, rule out the possibility of using such a monstrosity of an inductor in a tuned circuit for broadcast reception; though on the very long waves "honeycomb" coils of very high inductance are used.

As a practical measure, we will find that a coil to work between 200 and 550 meters should be designed to work with a condenser of not more than 500- or less than 250-mmfd. capacity. The inductance of the coil must therefore be somewhere between 160 and 320 microhenries. For the shorter waves we must have yet smaller coils; with even a midget 32-mmfd. condenser the coil whose upper range is 30 meters must have less than 8 microhenries inductance.

Inductance Formula

A general rule for determining the approximate inductance of a coil from its dimensions in inches is that *the number of microhenries is equal to the square of the radius, multiplied by the square of the number of turns, divided by ten times the length of the winding, and again reduced in a proportion which is determined by the ratio between the diameter*

(Continued on page 264)

A FEW TYPES OF MANUFACTURED AND HOME-MADE COILS

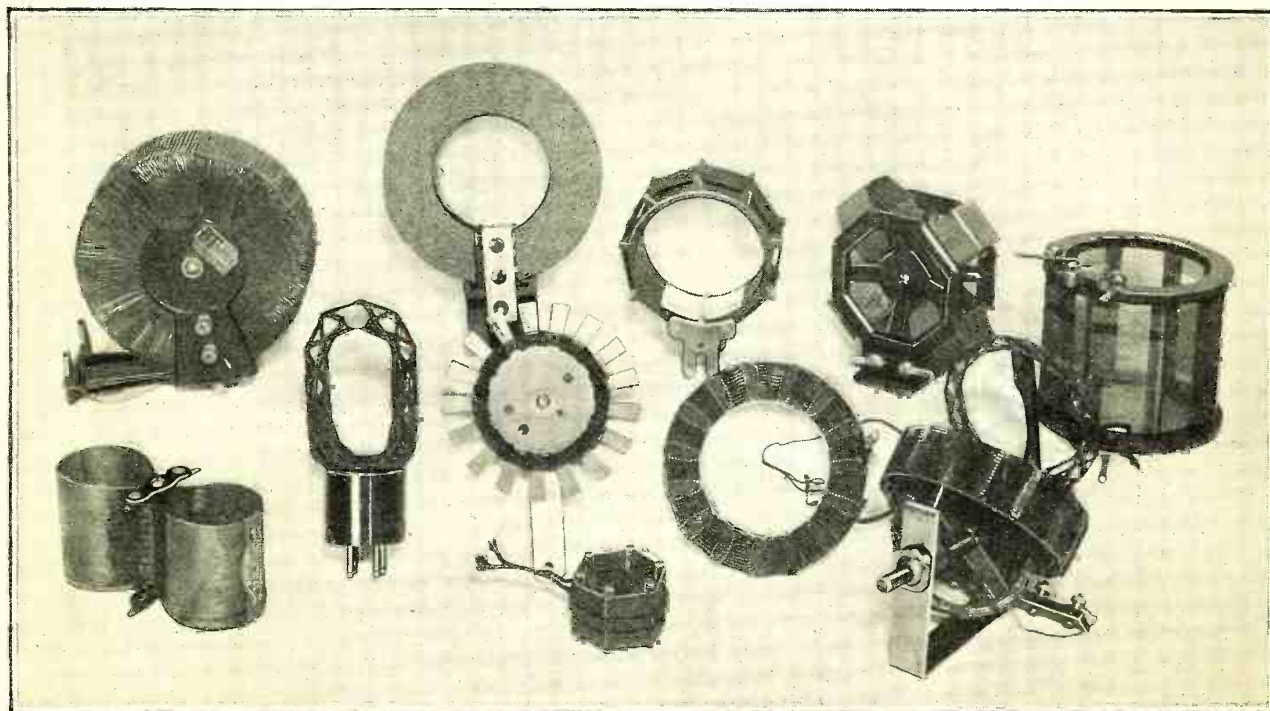

Coil Diameters, Length and Number of Turns Are Determined by this Calculation CHART

IN Mr. Mason's article on coils, found in preceding pages of this issue, the general theory explaining the electrical phenomenon and function of coiled wires to set up an "inductance" is explained. This article, prepared by the Technical Staff, is intended as a logical follow-up on the information presented by Mr. Mason and is of a more practical nature in that it will show the experimenter how, with the aid of the chart shown, if he has a variable condenser of known value, a coil of suitable inductance can be wound to cover a definite band of wavelengths or frequencies. Or, if he has the coil and condenser, it will be shown how it is possible for him to determine the high and low end of the tuning range the combination will cover when connected in a tuning circuit.

It is not the intention of the writer to go into the theory of the calculations or the mechanics behind the preparation of this chart. Suffice it to say that it is based upon the function of the polyphase slide rule and the chart shows a graphic representation of the number of scales of the slide rule in the positions in which they are used. It should be remembered by the experimenter that the calculations made with this chart will not be absolutely accurate. However, as a thumb-rule indication of the approximate size of the secondary of a radio-frequency transformer it will prove satisfactory.

To illustrate the use of this chart, let us start with the first of the number of examples. The constructor has a .00035 mfd. condenser and wishes to wind for it a coil for use in a tuned circuit. Naturally, he has some idea of what he expects the coil-condenser combination to do. First, it must be tuned to the maximum wavelength which will include those stations operating approximately on the highest broadcast wavelength, namely 550 meters. Second, the coil must be wound on some definite diameter tubing; for argument's sake, let us say two inches. Knowing these two prime factors, a suitable coil can be designed by the use of the chart shown which will meet the rough requirements imposed.

From the inspection of the chart, it will be found that there are 7 distinct columns or scales. From top to bottom they read: 1, Capacity; 2, Wavelength; 3, Inductance; 4, Length in Inches; 5, Index Line; 6, Number of Turns; 7, Diameter.

Now, on the first column, marked Capacity, mark lightly with a pencil the point denoting the capacity of the condenser to be used with the coil, namely .00035 mfd. Then, holding the ruler or other straight-edge at this point and also at the point marked 550 on the second scale, Wavelength, draw a light pencil line between these two points and continue it on to the third scale, Inductance. Here, the inductance in microhenries which the coil is to have is indicated. Next, join this

point on the Wavelength Scale, to the point indicating a two-inch diameter on the seventh scale, Diameter.

Now, from the wire table shown, determine the size of wire you wish to use and note the number of turns per inch for that particular wire. Suppose it is desired to use No. 24 d.c.c. wire. This has 35½ turns per inch. Then on the sixth scale, Number of Turns, locate the point denoting 35½; draw a line from it through that point on the Index line at which the previously drawn line intersects it and continue to the fourth scale denoting Length in Inches. We find here that the coil should be wound 2¾ inches long. Going back to the wire table and finding that No. 24 d.c.c. wire runs 35½ turns to the inch, it is merely necessary to multiply this figure by the length in inches, 2¾, to obtain the total number of turns to be wound, or about 98 turns.

Supposing instead of determining the length the coil should be, this together with the diameter was known and instead it was desired to know how many turns per inch would be required. It is simple to see that if by working from the point on the Length in Inches line and intersecting the Index line, a point would be found on the Number of Turns scale which would indicate the number of turns per inch of wire which was necessary to obtain a coil having the required inductance. Thus, by locating the figure 35½ on the scale, it would only be necessary to refer to the wire table to determine the size of wire which equals or approximates this figure in turns per inch. The chart can be worked backwards too, as can easily be determined. Supposing you already have a coil, know its diameter, size of wire and length of winding in inches. With these factors known, all that would be necessary is to observe the following procedure. First, draw a line in the correct manner on the Length in Inches scale to the point on the Number of Turns scale denoting the number which coincides with that determined by an actual count of the turns on the coil for one inch. Then, from the point on the Diameter Scale indicating the diameter of the coil draw a line which intersects the point on the Index line obtained by the first operation. Continuing the second line to the Inductance Scale will indicate the inductance of the coil in microhenries. From there, it is simply necessary to connect this point with the figure denoting the highest wavelength which it is desired to have the coil-condenser combination tuned to. By continuing the line over the Capacity Scale, the size of the condenser in microfarads is thus indicated.

NUMBER OF TURNS PER INCH

Size Wire B & S Gauge	NUMBER OF TURNS PER INCH						
	D.C.C.	S.C.C.	D.S.C.	S.S.C.	Enamel and S.C.C.	Enamel and S.S.C.	
14	13.7	14.6	14.7	15.0	15.2	14.2	14.7
15	15.0	16.2	16.4	17.0	17.0	15.8	16.5
16	16.7	18.0	18.2	19.0	21.4	19.5	20.5
17	18.5	20.0	20.0	21.2	24.0	21.7	22.9
18	19.6	22.3	22.3	23.6	27.2	24.2	25.8
19	22.5	25.0	25.2	27.0	30.1	26.5	28.4
20	24.5	27.5	27.5	29.5	33.6	29.6	31.5
21	27.5	30.8	30.8	32.8	37.7	32.7	35.0
22	30.0	34.0	34.0	36.6	42.3	36.1	39.0
23	32.7	37.5	37.5	40.7	47.2	39.7	43.1
24	35.5	41.5	41.5	45.3	52.9	43.7	47.9
25	38.5	45.7	45.7	50.3	59.0	47.8	52.8
26	41.8	50.2	50.2	55.7	65.8	52.1	58.1
27	45.0	55.0	55.0	61.7	73.9	57.0	64.4
28	48.5	60.0	60.0	68.3	82.2	61.9	70.6
29	52.0	65.5	65.5	75.4	92.3	67.4	77.9
30	55.5	71.3	71.3	83.1	103.0	72.8	85.3
31	60.0	77.3	77.3	91.6	116.0	79.1	93.9
32	62.7	83.7	83.7	101.0	130.0	85.6	103.0
33	66.3	90.3	90.3	110.0	145.0	91.7	112.0
34	70.0	97.0	97.0	120.0	164.0	98.8	123.0
35	73.4	104.0	104.0	131.0	182.0	105.0	133.0
36	77.0	111.0	111.0	143.0	206.0	113.0	146.0
37	80.3	126.0	126.0	155.0	235.0	120.0	157.0
38	83.5	133.0	133.0	168.0	261.0	128.0	172.0
39	89.7	140.0	140.0	181.0			

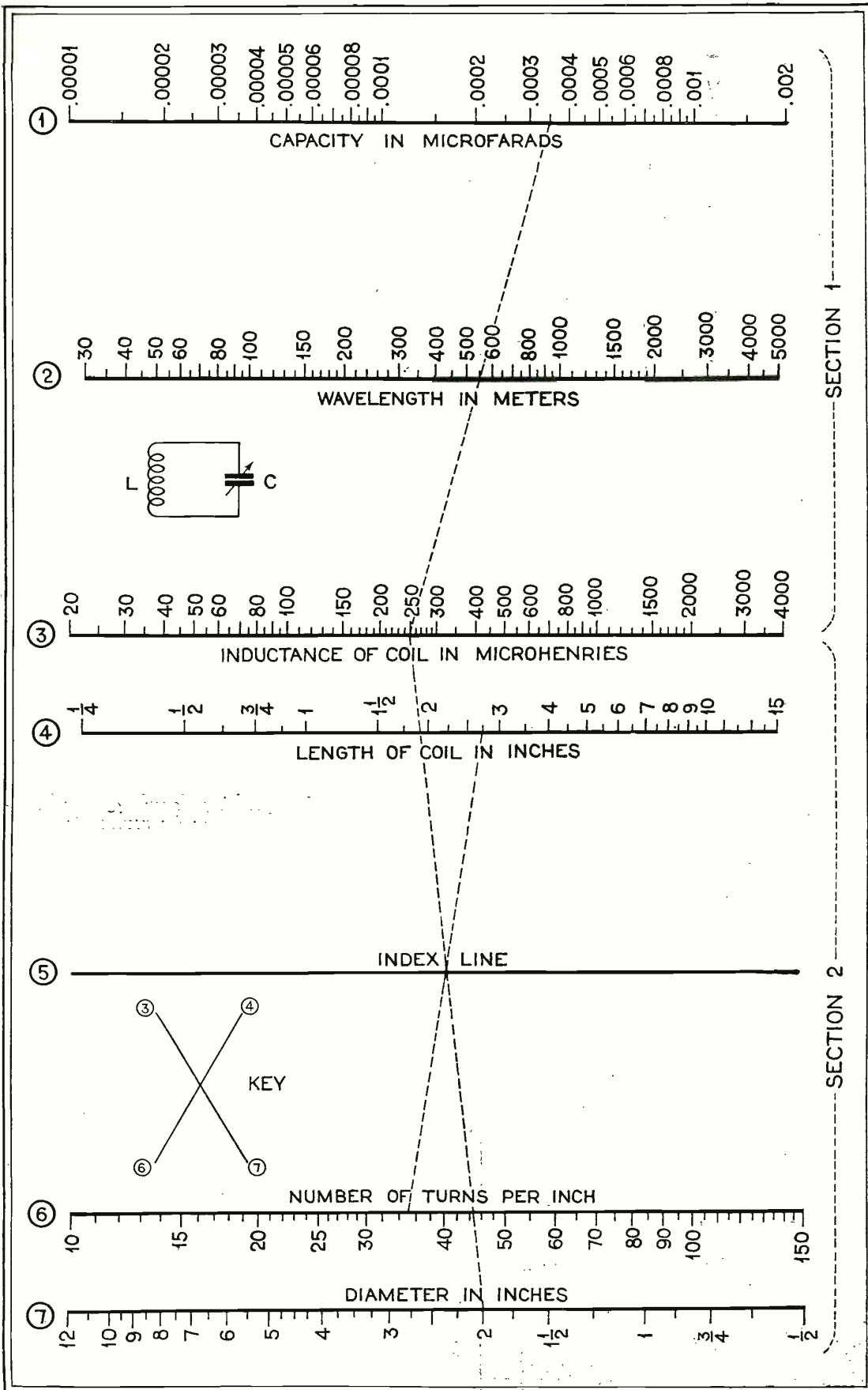

line, continuing it to scale 4. Here is denoted the length of coil in inches. By multiplying the length in inches by the number of turns per inch, a product is obtained indicating number of turns to be wound.

rating diameter of coil in inches; then from the wire table accompanying determine number of turns per inch for wire to be used, locate this point on scale 6 and draw a line through the intersection at index

To use the chart for determining total number of turns to be wound in a coil, proceed as follows: With a line connect scale 1 and 2 and continue to 3; here draw a new line from this point to scale 7, indi-

SECTION 1

SECTION 2

Modern Manufacturing

Tube MACHINES that

Tube Prices

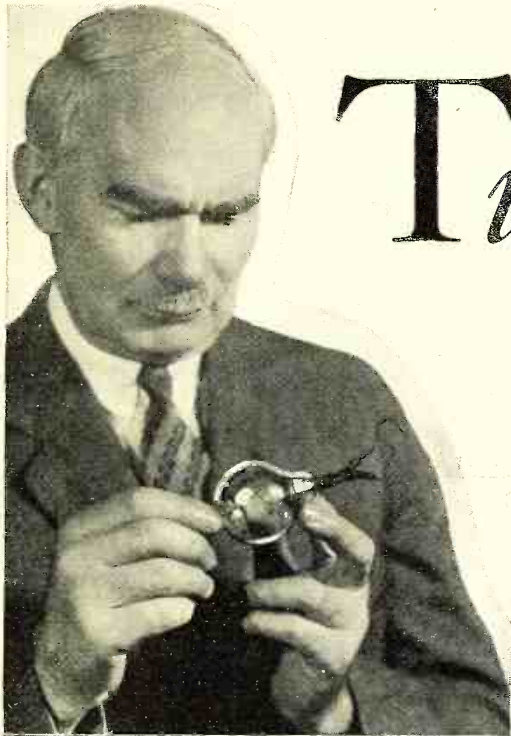

¶ Fig. 1—Dr. Lee DeForest holding one of the earlier types of "audion." Out of this expensive laboratory product grew the whole wide range of modern vacuum tubes which today are made on the machines that reduce the cost to a fraction of what it used to be



¶ Fig. 2—A Machine for flaring the glass tube which acts as a support for the tube elements. This machine, ingenious and costly as it is, is already being superseded by one incorporating even greater cost-cutting improvements

¶ Fig. 3—The Operator is placing in position in the flared tube the grid, plate and filament lead wires and the small diameter glass tube through which the air will later be exhausted. On this machine, which has six jig fixtures, these wires are sealed into the glass, as shown in Fig. 4. Each jig revolves constantly, and the entire circular table is revolved in steps to bring the jigs to the successive heating stages

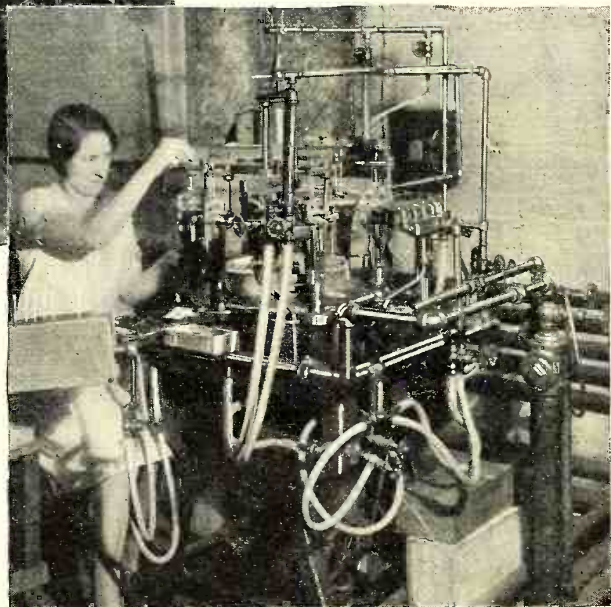

METHODS *and* Ingenious Have Brought

Down

¶ Fig. 4—A Close-up view of jig assembly, at the moment when the two clamping arms are pressing the heated glass to a tight seal around the wires

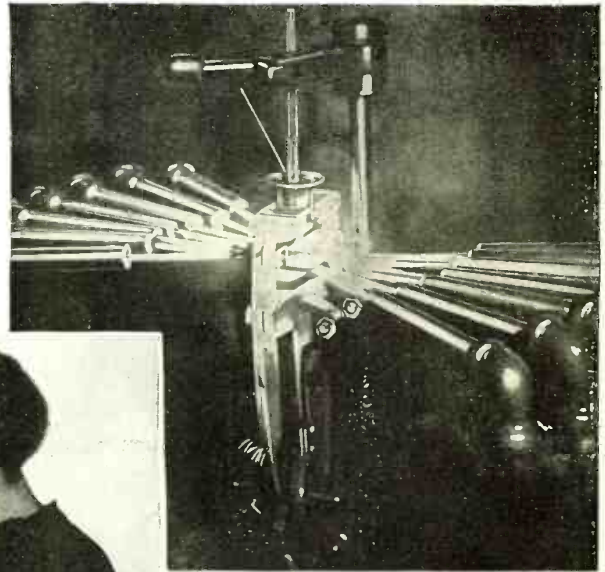

¶ Fig. 5—By Means of gauges, the operators assemble the grid, plate and filament elements for spot-welding to the sealed-in lead wires



¶ Fig. 6—Here the assembled elements are being welded into place; accuracy of spacing between the elements being assured by the gauges shown in Fig. 5

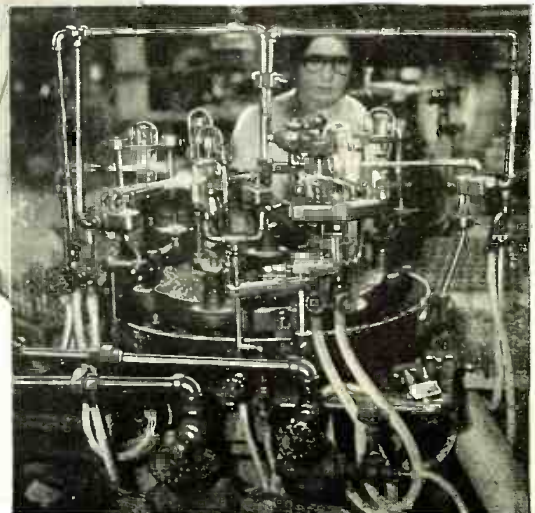

¶ Fig. 7—Another ingenious machine, on which the outer bulb and the sealed-in element assembly are brought together, preheated, sealed together, and the tube cut off ready to be evacuated

Photo © Underwood & Underwood

¶ Fig. 8—The Tubes are evacuated through the small glass tubing extending up inside the bulb. Evacuation is carried on with the filament lit and with heat externally applied

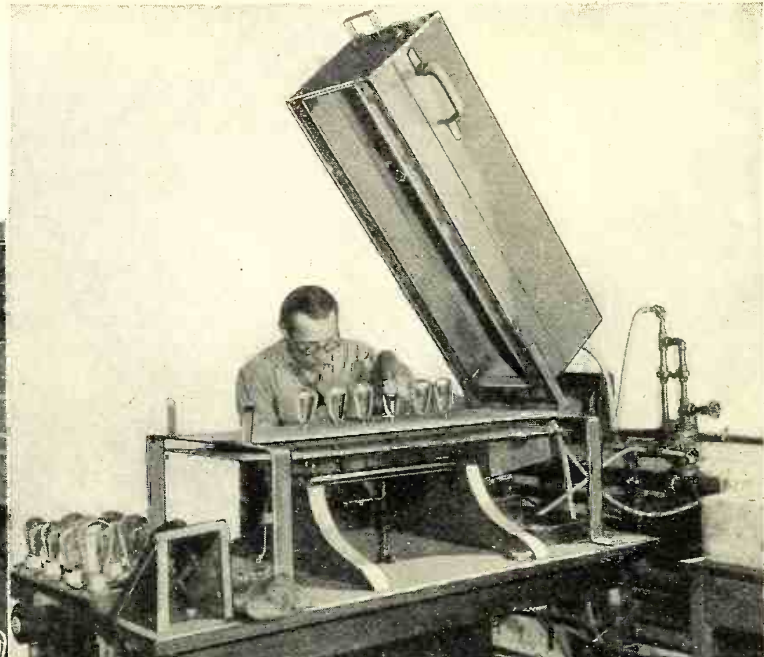

¶ Fig. 9—Another type of evacuating apparatus, with the furnace door raised to show the tubes in position

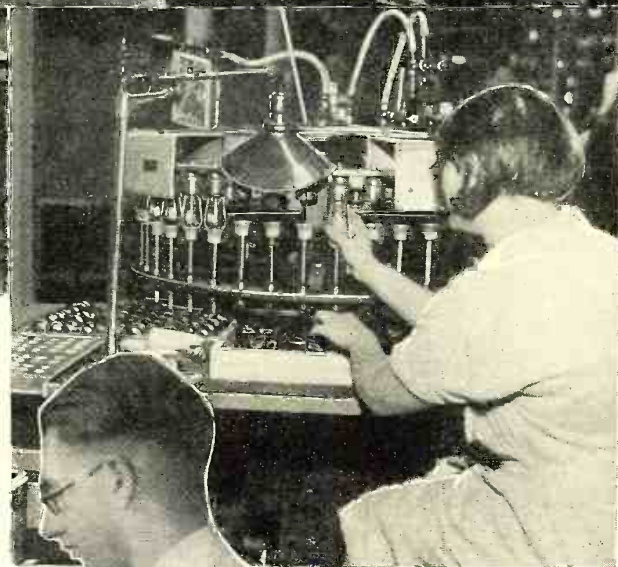

¶ Fig. 11—The Tube is passed inside a high frequency coil, which heats the elements by induction, driving off the last residue of gases and flashing the magnesium or other cleansing agent; another time and cost-cutting process

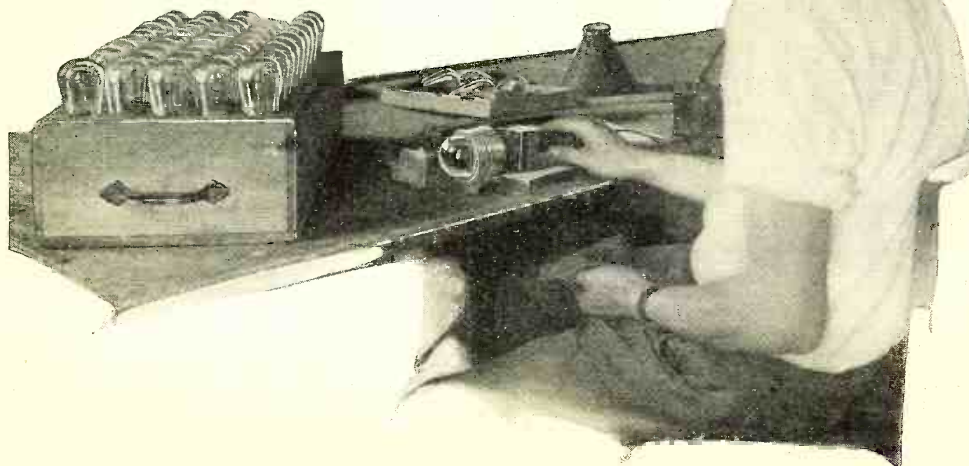

Photo © Underwood & Underwood

¶ Fig. 10—The bulbs are placed in this machine, together with the bases, which are here cemented in place. The lead wires protrude through the base prongs, being then cut off and a drop of solder applied to the end of each prong

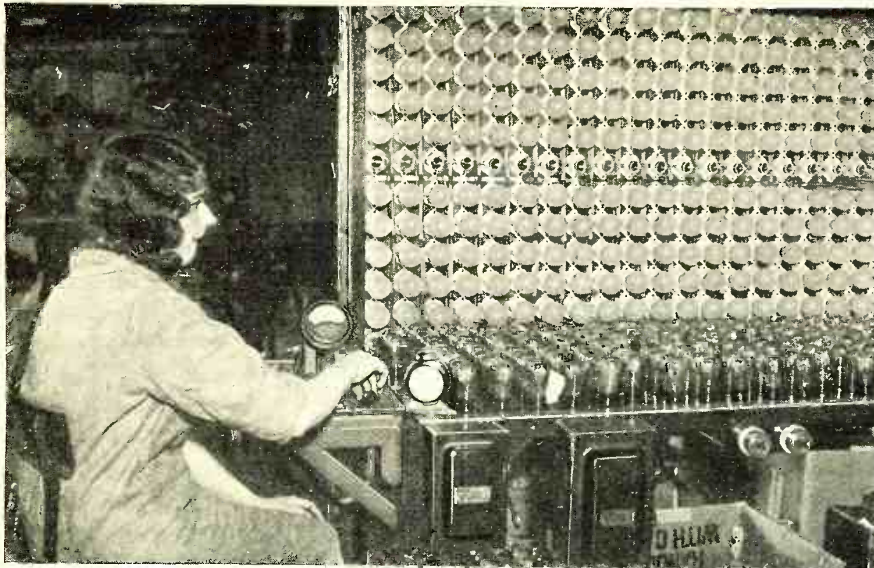
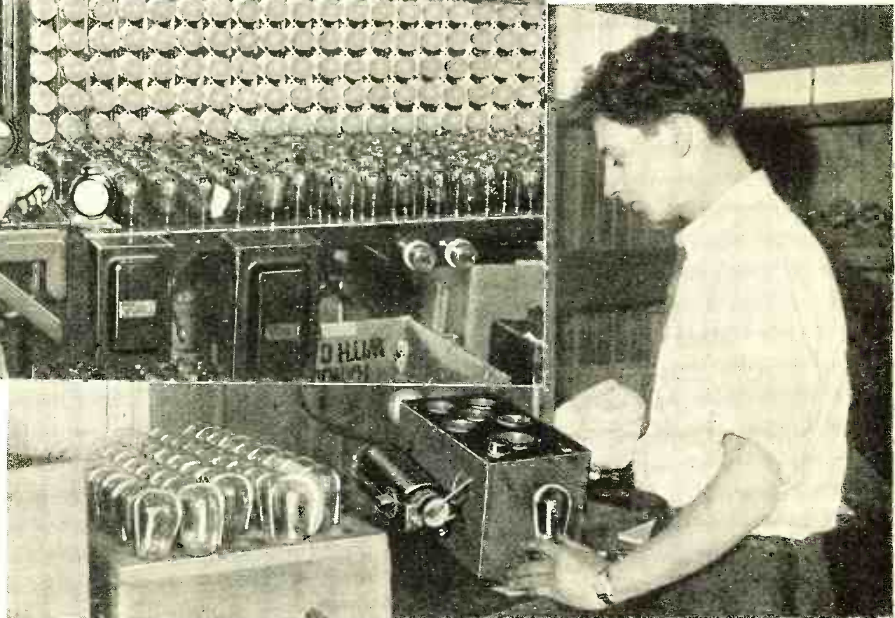

Photo © Underwood & Underwood

¶ Fig. 12—Completed tubes are allowed to “age” for a length of time, which varies according to the manufacturer’s own schedule



¶ Fig. 13—After “aging,” each tube is individually tested. In this particular case rectifiers of the full-wave type are being tested for possible departure from standard



¶ Fig. 14—At the left, power tubes are being tested by impressing a signal on the input and then measuring the output load and analyzing the distortion harmonics

Photo © Underwood & Underwood

¶ Fig. 15—Packaging a well-known make of vacuum tube. This work, as well as many of the manufacturing processes, is carried out by girls, who are better adapted by temperament to the delicate operations involved. Undoubtedly, the further economies of machine packaging will soon be made practical even here

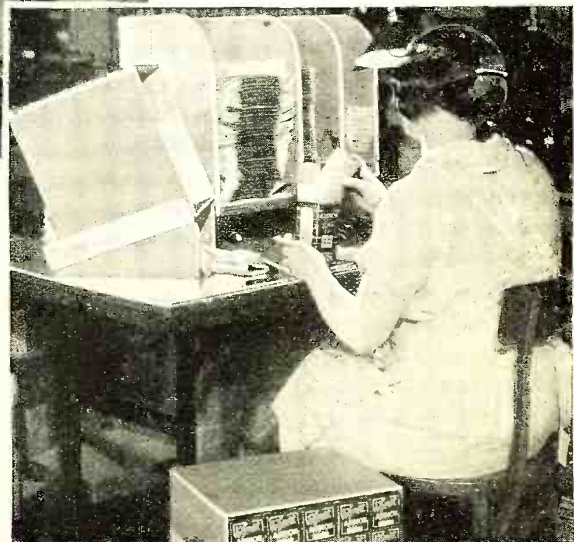

Screen Grid Tubes, Antenna Stage Tuning, and a 250 Power Amplifier as

ADDITIONAL REFINEMENTS

on the EXPLORER *Eight*

By John B.
Brennan, Jr.

Technical Editor

¶ In June, the writer described the details for the construction of an eight-tube receiver. It consisted of four radio-frequency stages, a detector and three audio stages.

¶ Of the radio stages, one comprised an untuned antenna stage employing a single screen-grid tube, while the remaining three were tuned stages employing the common 201A tube. The tuning of the radio-frequency and detector stages was accomplished by means of a single dial. The audio stages consisted of a three-stage resistance-coupled amplifier with 171A power stage.

¶ This present article describes how, if the builder chooses, he may re-vamp his Explorer Electric Eight to fit in with any special requirements which were not included in the original description. These alterations are suggested for those experimenters who find that in the matter of design they desire to exercise their own ingenuity.

REGARDLESS of the degree of perfection or finish a receiver may be said to possess there are always those souls of an inquisitive and experimental turn of mind who will, with great zest and gusto, pounce upon a receiver design and forthwith subject it to all manner of improvement and alteration, some good, and some not so good.

The "Explorer Electric Eight," described by the writer in the June RADIO NEWS, is no exception to the rule and in an effort to guide the trend of experiment and improvement into a channel productive of worthwhile results the following will be of interest:

The requirements of a satisfactory receiver design, as set up by the writer as a goal to be attained, and as applied to the Explorer Electric Eight, were simple and straightforward. The receiver was

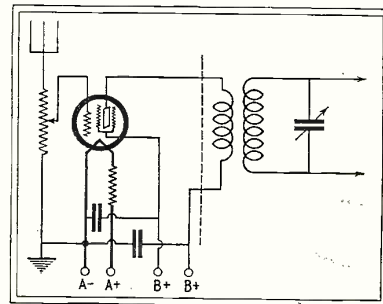

FIG. 1. THE ORIGINAL CONNECTIONS TO THE FIRST, OR ANTENNA STAGE, ARE SHOWN HERE; THE CHANGES ARE NOTED IN FIG. 2

to be sensitive and selective; it was to be a single control affair and was to be as economical in the choice of suitable parts as would be commensurate with a satisfactorily high order of tone quality reproduction. The result of meeting such requirements was the Explorer Eight as described recently.

If it is not considered an absolute necessity to adhere strictly to these requirements then all manner of changes and alterations may be indulged in, so much so that the receiver will lose its entire identity.

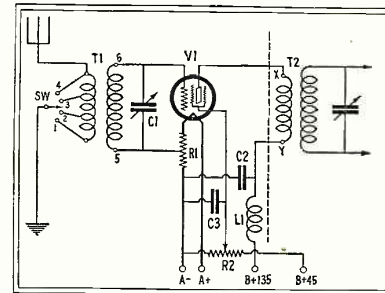

FIG. 2. THE TUNED METHOD OF ANTENNA COUPLING IS SHOWN HERE. THIS WILL IMPROVE THE SENSITIVITY OF THE SET FOR THE DX FAN, AND WILL ADD TO THE RECEIVER'S SELECTIVITY

The changes, therefore, which will be considered here are as follows: First, the employment, purely as an experimental move, of screen-grid tubes in all the tuned stages excepting the detector; second, the use of a separately tuned antenna stage, employing a screen-grid tube; third, the use of a C bias detector to handle the large amounts of signal energy which will be produced as a result of the above-mentioned alterations; finally, the substitution of a transformer-coupled two-stage audio frequency amplifier, the last stage of which is arranged in push-pull fashion, employing two 250 tubes for "auditorium volume" of tone reproduction.

These several changes will be taken up one by one in the order named.

Screen-Grid Tubes Throughout the Radio Amplifier

If, in the original design of the receiver it was found necessary to employ the lossier resistors in the grid circuits of each of the tuned stages to eliminate an oscillatory condition, then, when the changeover to screen-grid tubes is made these resistors will have to be removed from the circuit, as, due to their extremely low inter-electrode capacity, there is little or no tendency for these latter tubes to cause oscillation. Then, as the circuit diagrams, Figs. 1 and 2, show, the connection from the startor plates of the tuning condensers to the grid terminal of each of the r.f. sockets

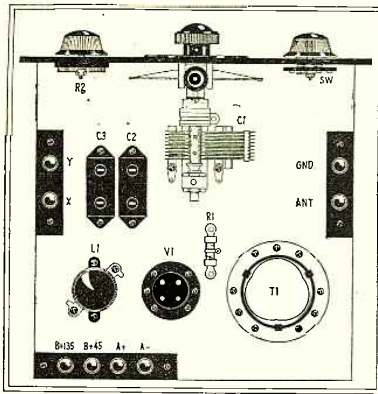

FIG. 2. THE LAYOUT OF THE PARTS IN THE ANTENNA STAGE WHICH IS ADDED TO THE ORIGINAL SET.

is removed and in its place is connected a flexible lead with a grid-grip for attachment to the cap of the screen-grid tubes. Then, connection is made from the vacated grid terminals of the sockets to the plus 45 volt terminal of the B battery supply. As shown, in this change bypass condensers must be added to the grid circuits to prevent intercoupling of the radio frequency currents in the battery leads.

The next change required by the substitution of screen-grid tubes is in the rewinding of the plate coils of each of the tuned circuits. To obtain maximum satisfactory operation from screen-grid tubes it is necessary that a larger induc-

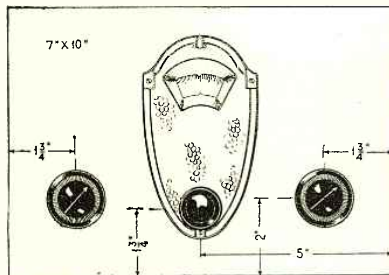

FIG. 4. THE PANEL LAYOUT OF THE ANTENNA UNIT IS SHOWN HERE. THE TWO KNOBS AT THE SIDES OF THE TUNING DIAL ARE FOR THE SWITCH AND VOLUME CONTROL RESISTOR.

tance be employed in the plate circuits so that the impedance relations between the tube and the primary circuits are maintained at a correct value. If this is not done the full value of the change-over to screen-grid tubes will not be entirely realized. Disconnect the coil units from the circuit, and then after they have been removed from the baseboard, carefully remove the inner or primary coil. To do this you will have to unsolder the leads which connect to the terminals at the base of the coil unit. Then, employing a random winding, rewind the primary coils, using 60 turns of No. 30 D. C. C. wire for each primary. When the coils have been rewound, replace them in their former position inside the secondary coil and resolder the leads to their former terminals. When

this has been completed the coil units may be put back in their place in the circuit and reconnected.

Since each of the screen-grid tubes should be operated at 135 volts plate potential the resistance, R11, which was formerly employed to "drop" the 135 volts to about 90 or 100 volts for use on the plates of ordinary 201A tubes should be taken out of the circuit, and the break occasioned by its removal be made into a continuous circuit.

There is still another change which must be made in the circuit when 222 tubes are used in the tuned stages. These tubes, to function satisfactorily, must have their grids biased with a 1½ volt potential. This voltage is most easily obtained by utilizing a voltage drop across a suitable resistor located in the negative leg of the filament supply to each of the tubes. Assuming that a six volt source is employed to furnish current to the filaments of the tubes, a total resistance of 25 ohms is necessary to drop the voltage to that required by the tube, namely 3.3 volts. Then, in order to obtain the 1.5 volt bias a tap is taken off the resistor; or, as is more practicable, two resistors, one of 10 ohms and one of 15 ohms, are connected in series, as shown at R1 in Fig. 2. Some manufacturers have produced a ready-to-use tapped unit, in which case one of these may be used to obtain the grid bias for each of the screen-grid tubes.

As mentioned before, the use of screen-grid tubes in all of the tuned radio frequency stages is to be regarded purely as an experiment where in localities in which reception is exceptionally poor there is need for such a high gain amplifier.

It is entirely probable that in the majority of cases, especially where the receiver is located within fifty to one hundred miles of a city boasting of quite a few stations, that, by simply removing the untuned antenna stage and revamping it into a tuned stage, as explained in succeeding paragraphs, a sufficiently high degree of sensitivity will result.

Tuning the Antenna Stage

As we pointed out in the previous article, where one manual control is employed to tune a number of stages, it is a prerequisite that all of the stages peak alike. Since usually the antenna stage is working under conditions vastly different than those which exist in the other associated tuned circuits, it is not always possible to include its tuning condenser among those to be controlled by the one dial. Where the item of single control is a desirable feature this obstacle can be surmounted by employing the system described in the original design of the Explorer Eight; namely, the use of a coupling tube between the antenna and the first tuned circuit. Where this feature is not of paramount importance and two tuning controls can be tolerated, then the tuning of the antenna stage (wherein are used a coil and condenser similar to those employed in the other tuned stages) will be productive of results greater than those obtained in the original system.

To make the change, it is well to re-

move from the baseboard all the apparatus which comprises the untuned antenna stage. This includes the tube socket, amperite, r.f. choke, bypass condensers and the volume control which is located on the panel. In the hole vacated by the volume control may be mounted a panel light, more as a decorative means for filling the hole.

In Figs. 2 to 4 are shown the constructional details concerning the assembly of the tuned antenna stage. Note that it is constructed in the form of a separate unit which may be placed at any convenient point inside the console cabinet, or right next to the receiver itself, if no console is used.

To the parts removed from the baseboard of the receiver must be added a Hammarlund tuning condenser of .0005 mfd. (C1), a vernier dial, another U4

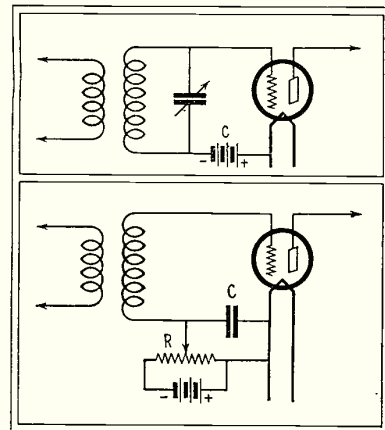

FIGS. 5 AND 6. TWO METHODS OF USING PLATE OR "C" BIAS DETECTION ARE ILLUSTRATED TO FACILITATE THE CHANGES FROM THE ORIGINAL METHOD. A, ABOVE, AND B, BELOW, ARE DESCRIBED IN THE TEXT.

Aero coil (T1), a Yaxley four-point tap switch (SW), a baseboard, panel and binding post strips. The volume control (R1) formerly used is discarded and an Electrad Royalty potentiometer of 0 to 5,000 ohms (R2) is connected in the circuit as shown, to supply a variable positive bias to the screen-grid element of the tube so as to obtain a smooth control of volume. Rough tuning of the antenna primary circuit is obtained by means of the tap switch which cuts in or out of the circuit a varying number of turns of the primary coil. In final operation the 222 tube should be used with a tube shield, and the whole unit covered by a shield can, which may be built up around the unit with sheet aluminum, or a Hammarlund type AS-1 shield box used instead.

The C Bias Detector

In an article in the April RADIO NEWS by Mr. C. W. Palmer, formerly of the Editorial Staff of RADIO NEWS, the methods of detection were explained. In that article the subject of detection by

(Continued on page 268)



LOUD SPEAKERS, CONVENIENTLY LOCATED IN THE FOYER OF THE GEORGE WASHINGTON HOTEL AT JACKSONVILLE, FLORIDA, DISTRIBUTE THE PROGRAMS WHICH ORIGINATE EITHER WITHIN THE HOTEL OR FROM STATIONS OUTSIDE

Factors Affecting the

INSTALLATION *and* SERVICING of Sound Amplifiers

The Second in a Series of Articles by S. Gordon Taylor

IT is the express purpose of this series of articles to discuss the application of power amplifier installations to commercial use. Before going further it is well to make clear that the term "power amplifier installation" as used here means not only the amplifier itself but also the accessories and equipment employed with the amplifier, such, for instance, as loud speakers or head phones, radio tuning units, phonograph pick-up units, microphones, power supply units, etc. In other words, it includes types of installations variously known as public address, group address, phonograph amplifier and voice amplifier systems. Also the term "commercial use" does not necessarily indicate use in commercial enterprises, as many of the potential prospects for power amplifier installations, such as schools, parks, churches and clubs, are non-commercial. The term is used to distinguish installations which serve a large number of people from those intended for ordinary home use. In planning a power amplifier installation the first step is to determine the practical requirements of the particular job in hand. Under this head there are a number of items to be considered.

The first consideration is the amount of coverage required of the installation. Whether the loud speakers are to be indoors or outdoors and whether in one room or in several different rooms, are important considerations. Unfortunately there are no definite rules to be followed in determining the type or number of loud speakers required to provide a given volume of sound over a given area of space. Experience helps a great deal in determining the equipment required under varying conditions, although in some cases experience is not enough. In most installations where extensive coverage is required the only certain method of determining the loud-speaker requirements is by actual test.

Acoustical Problems

For indoor work it is necessary to consider not only the area to be covered but also the acoustical properties, where the rooms are large. In small rooms conditions are usually not unlike those in the home. The greatest problem of indoor work will be found in halls and auditoriums. A hall which when unoccupied can be amply taken care of by a given num-

ber of loud speakers will present an entirely different proposition when filled, because the sound absorption in a hall filled with people is approximately five times greater than that experienced when the hall is empty. Moreover, the tone quality of reproduction will in most cases undergo a very noticeable change, usually for the better, when a hall is filled with people. This brings us to the question of acoustics.

Large halls are subject to three difficulties: echo, dead spots and reverberation. Of the three, reverberation is the most common. This is defined as the tendency of a sound to continue after its source of origin has stopped, and is caused by reflection back and forth between the walls and surfaces of the room. At each reflection a part of the sound is absorbed by the reflecting surface until finally the intensity is reduced to a point below audibility. If the walls and surfaces of a room are draped with heavy hangings or other material of high absorption qualities reverberation is almost entirely eliminated, with the result that the room will be acoustically "dead." On the other hand, a room which consists exclusively of hard-surfaced walls, floors and ceilings,

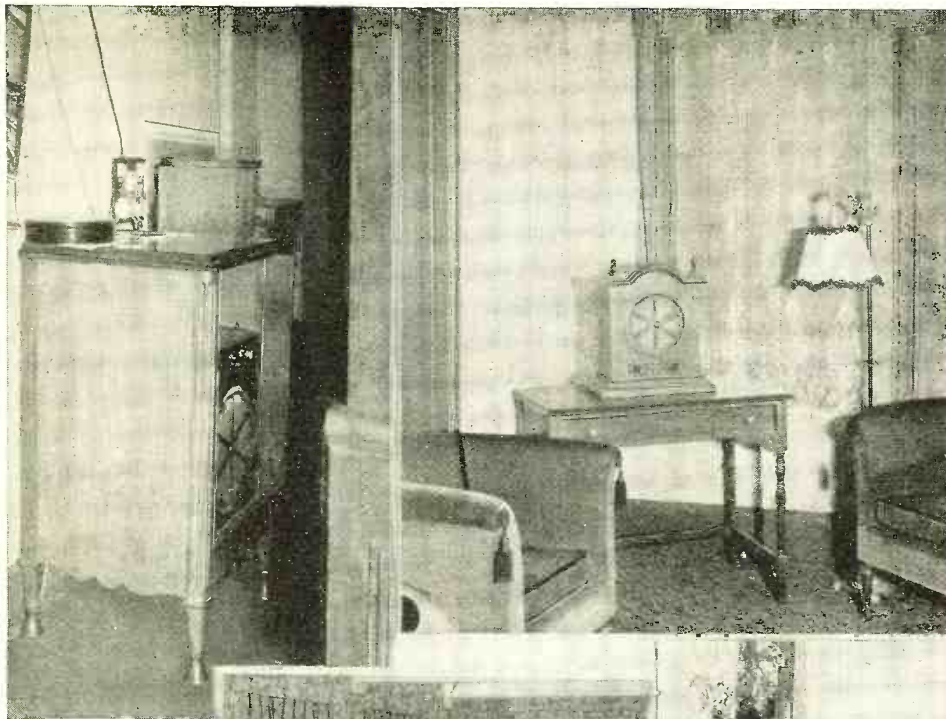

IN A GUEST ROOM OF A HOTEL. THE LOUD SPEAKER, WHICH IS A PART OF THE FURNISHINGS OF EACH ROOM, IS EQUIPPED WITH A VOLUME CONTROL REGULATOR WHICH, WHEN ADJUSTED, DOES NOT AFFECT OTHER LOUD SPEAKERS HOOKED IN THE SAME CIRCUIT

THE EMPLOYMENT OF A TABLE OR PEDESTAL TYPE OF LOUD SPEAKER, HARMONIOUSLY BLENDING WITH THE GENERAL APPOINTMENTS OF A ROOM, IS A CONSIDERATION DESERVING THE ATTENTION OF THE UP-TO-THE-MINUTE SERVICEMAN (TO THE LEFT AND BELOW)

AN ELECTRICALLY OPERATED AUTOMATIC PHONOGRAPH EQUIPPED WITH POWER AMPLIFIER, SUCH AS THAT SHOWN HERE, IS BECOMING WIDELY USED AS A SOURCE OF PROGRAM MATERIAL, SINCE IT WILL PLAY WITHOUT ATTENTION A SERIES OF UP TO TEN RECORDS



ONE OF THE LOUD SPEAKERS, SITUATED IN THE CORNER OF A DANCE FLOOR, TO WHICH IS "PIPED" THE MUSIC ORIGINATING FROM THE RADIO OR PHONOGRAPH

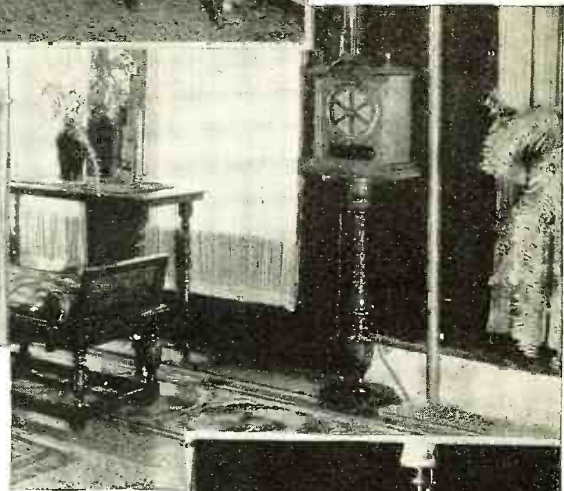

will cause trouble because the lack of sound absorbing qualities will permit the sound to continue for an excessive length of time. The length of time a sound is thus continued is known as the "reverberation time."

Sound Absorption

To give life to music or speech a certain amount of reverberation is desirable, but too great a time of reverberation causes successive sounds to become jumbled and therefore unsatisfactory. This latter condition is particularly evident in the case of loud, staccato sounds such as drums, for instance. Almost everyone has experienced this in hearing a drum corps playing indoors in an armory.

Fortunately, the furnishings of a room and the audience itself tend to decrease reverberation. Anything in a room with a higher sound absorption quality than the room walls and floor will tend to reduce the time of reverberation. A carpeted floor, for instance, absorbs about eight times more sound than a bare wood floor. Upholstered chairs absorb approximately from thirty to eighty times as much sound as would the bare floor space occupied by the chairs, depending upon the type of upholstery. Even bare wood seats offer about three times as much absorption as the wood floor they occupy.

A most important consideration, from

the standpoint of those making sound amplifier installations in halls, is the fact that a person seated on a chair has a sound absorption coefficient of 4.7 as compared with a coefficient of .1 for an empty wood seat; in other words, a person absorbs approximately forty-seven times more sound than a wood chair. This explains the great difference existing in both the quality and volume of sound in an empty hall as compared with the same hall when occupied by a good-sized audience. Because of the sound absorption features of the audience far greater volume of sound is required to fill the occupied hall. At the same time, sound reproduction of a given volume will have much better quality in the occupied hall because of the reduction of reverberation, resulting from the sound absorbing qualities of the audience.

Echoes and dead spots are most often the result of the room shape and are usually not encountered in rooms of rectangular shape. If present at all they usually occur in rooms having curved walls or ceilings, or very large unbroken surfaces. In any event, these are architectural defects which cannot be corrected readily except by extensive re-



modeling. Even in halls where such conditions exist a little experimentation with loud speakers at different points in the room will often overcome the trouble. In the case of a curved ceiling, for instance, it may sometimes be found possible to place the loud-speaker equipment up near the ceiling in such a position that the curvature serves a useful purpose as a sounding board, rather than an echo-producing nuisance.

In restaurants, ice-cream parlors and other stores which may advantageously use radio and amplifier installations, the

acoustical properties do not as a rule offer any problem, because of the comparatively small size of such stores and because of the presence of furniture, irregular wall surfaces, etc. In this type of installation there is another consideration, however. Particularly in restaurants, it is advisable to maintain the volume of sound practically constant throughout the room. To do this it is usually a better plan to distribute two or more loud speakers around the room than to have the sound emerge from a single loud speaker. Otherwise, and especially if the room is fairly large, those sitting near the loud speaker will find that the loud speaker output interferes with conversation. Or, if the volume is cut down to avoid this, it is likely that persons seated at the far side of the room will be unable to hear comfortably. In addition to thus distributing the loud speakers, it is also a good plan to mount them high up toward the ceiling. This latter idea not only tends to make volume distribution more equal, but to a certain extent decreases the absorption suffered where the loud speakers are close to the floor or at table level.

It will be realized, of course, that the normal noise level of a room may do much to mar the loud-speaker reproduction unless adequate volume is provided. Thus in a dance hall full of dancers the volume required will be many times what would be necessary to provide adequate coverage when the hall is empty. To be entirely satisfactory, any power amplifier installation must be capable of providing more undistorted volume than will normally be required of it. It is, therefore, necessary for an installation man in planning an installation to know the normal volume requirements of the job. This means that he must be familiar with the use to which the room is to be put.

In the case of a school room, for instance, the volume required would be very little greater than the ordinary speaking voice level. Ordinarily the noise level in a school room may be considered as practically zero, and school rooms are of such size that the teacher's voice can normally be heard in every seat. Therefore, loud-speaker output volume of like intensity will provide satisfactory audibility. Under certain conditions, however, particularly in the reproduction of musical selections, it may be desired to bring the volume up somewhat to provide more realistic reproduction. It is to take care of such possibilities that the advisability of having reserve power in the amplifier

becomes readily apparent.

The same consideration applies in hotels where loud speakers are installed in each room. Great volume is not necessary here, and, as a matter of fact, the hotel amplifier installation must provide a fixed volume maximum adjusted to a point where the loud speaker operating in one room is not audible in adjacent rooms. In such installations a large number of speakers are operated from one amplifier and a volume control arrangement must be incorporated in the amplifier by means of which the maximum volume level is regulated.

The foregoing paragraphs may seem to make the planning of power amplifier installations an extremely difficult task. Actually, this is rarely the case. In the great majority of installations no acousti-

enced in this field could profitably start with two or three smaller installations. Experience gained through these will aid materially in developing judgment of coverage requirements and other incidental problems.

Study the Actual Requirements

An installation man, in addition to knowing the technical side of the installation work, should endeavor to form some very definite ideas on the likes and dislikes of the public for whom his installation is to provide entertainment. An example of this is provided in the experience of an installation man in a large eastern city. He received a contract to make an installation in a hotel with several hundred rooms, each of which was to be equipped with a set of headphones. It was the first hotel installation that he had made and he failed to make a study of the wishes of hotel patrons and did not realize that they have a very strong preference for loud speakers rather than head phones. The result was that when the installation was completed the management was not satisfied and later went so far as to have another installation man revamp the entire job so as to permit the installation of a loud speaker in each room in place of the original head phones.

Had the first installation man been familiar with the desires of the public in the first place, he could have sold the hotel management on the advisability of installing loud speakers. This would not only have satisfied the hotel management better, but the installation man would have made much more money out of the job. To make matters worse, it so happened in this particular case that this was one of a chain of hotels for which this particular hotel was to serve as a testing ground to determine the value of radio. Had this installation man gone about the job in the proper way in the first place, he could undoubtedly have obtained the contract for all of the other hotels in the chain, because all of them subsequently were radio equipped by the installation man who revamped the first installation.

It might appear that it was the hotel owner's responsibility rather than the installation man's which resulted in the dissatisfaction with the original installation. However, it must be realized that hotel owners, restaurant owners and similar prospects know little or nothing about power amplifier installation work and as a rule will be more than glad to have

(Continued on page 237)

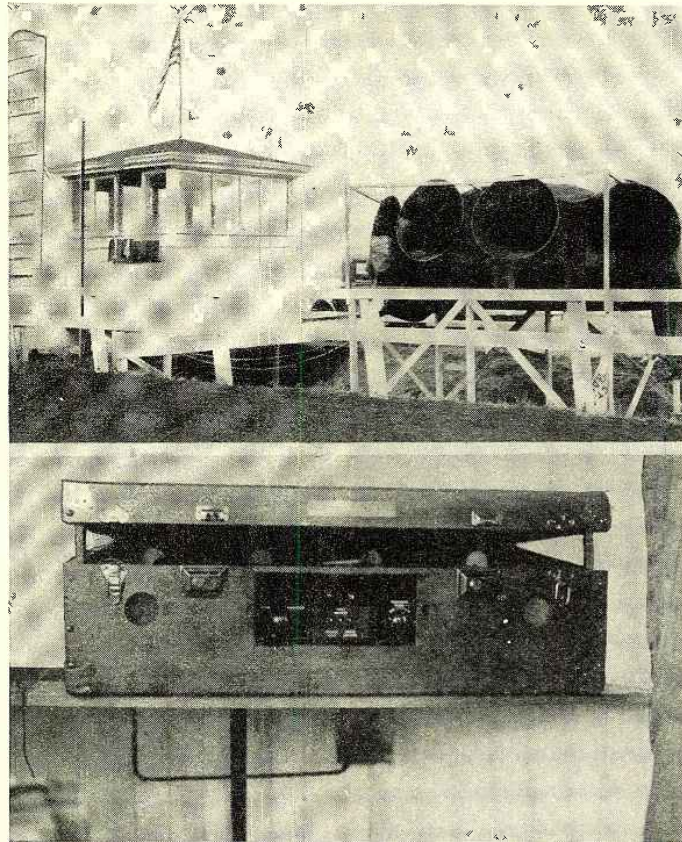

JUST ANOTHER INDICATION OF THE WIDE RANGE OF USES TO WHICH POWER AMPLIFIERS AND THEIR ASSOCIATED APPARATUS MAY BE PUT. ANNOUNCEMENTS AT THE RACE-TRACK (ABOVE) ARE MADE WITH THE USE OF A MICROPHONE ATTACHED TO A POWER AMPLIFIER (BELOW)

cal trouble will be encountered. Especially in smaller installations, there is very little more difficulty involved than in making an installation in a home, except, of course, that greater volume will be required in commercial installations. It is quite logical that installations in large halls, theatres, etc., may be somewhat more complex than those in smaller locations, and it is for this reason that recommendations were made in the first article of this series, that a man inexperi-

Dr. Lee De Forest Writes the Reminiscences of a

RADIO Pioneer

WHEN contrasting the first audions with the vacuum tubes of today, I am reminded of the story they tell about our late President Wilson. He arrived at the pearly gates, so the story goes, and stopped to talk with Moses.

"So you are Mr. Wilson," Moses said. "I've heard a lot about you. They've certainly made a mess of your 'Fourteen Points' down there."

"Oh, yes," replied Mr. Wilson, with his well-known wit; "but you should see what they have done to your Ten Commandments!"

Well, you should see what they have done to my original audion idea—in the way of development and application, I mean. Really, there is little similarity between the first crude audion which I invented and developed back in 1906, and the perfected vacuum tubes of today, except in basic principle. Without the original audion, of course, we could not be enjoying radio broadcasting, transoceanic radio, marine radio, long-distance telephony, multiplex telephony, carrier-current telephony, and even television which is now making its debut. Yes, indeed, I am a proud father, well satisfied with the way my child has grown up.

Back in 1900, I was working as associate editor of the *Western Electrician*. During the evenings, it was my hobby to play with wireless telegraphy in my hall bedroom in Chicago. Among my prized possessions was a large spark coil, the crashing spark of which supplied no end of pleasure to one experimentally inclined. One evening, I discovered that the sparking caused the nearby Welsbach gas mantle in the room to change its brilliancy momentarily. There was obviously some relationship between spark and gas burner. I was curious to find some explanation for this singular behavior, and it occurred to me that the spark discharge must set up waves which in some way affect the heated gas, thereby making the latter a detector of wireless signals. At that time the only detector available was the relatively crude coherer.

At any rate, I started off on the idea of heated gas as a detector of wireless signals, which eventually led to the invention of the audion or three-element vacuum tube. As Fate would have it, my original premise subsequently proved a poor guess; for I soon found that, by placing the spark coil in a closet and operating it from outside, the electromagnetic or wireless waves had no influence on the gas burner. Sound waves, and not wireless waves, were responsible for the phenomenon previously observed.

Nevertheless, I had already started my

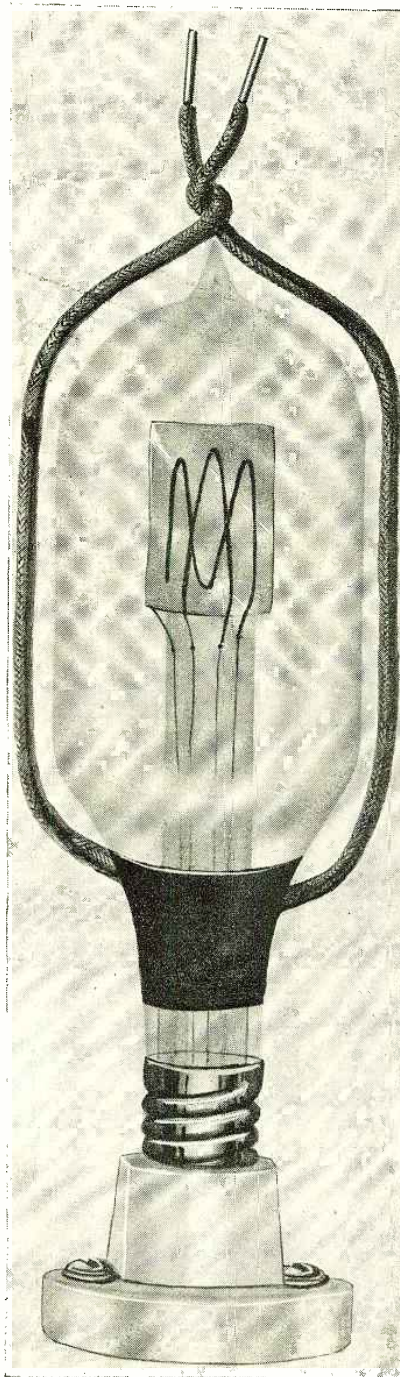

ONE OF THE EARLIEST TYPES OF AUDION DEVELOPED IN DR. DE FOREST'S LABORATORY

work on a heated gas detector, and there was no turning back. In fact, I gave up my position and went to work in earnest on the problem of a new type of wireless detector. By 1903, I produced the first practical detector of this kind—that is, practical in the laboratory sense. However, this detector, comprising a gas flame with electrodes placed at different points, was unsatisfactory commercially, particularly on shipboard, which was the main field of wireless communication, where no gas was available.

I decided to change the idea around a bit by enclosing the detector in a glass bulb, making use of a heated filament as the heat source. Where to get such a device made up was a real problem. The manufacturers of electric lamps were not interested in such a fantastic idea. Finally, I did find an independent manufacturer of miniature electric lamps, by the name of McCandless, who agreed to make up a few experimental bulbs. These were of the two-element kind, with carbon filament and platinum plate or "wing" as we then called it. The antenna was connected to the platinum plate or "wing," and the ground to the carbon filament, while the battery and phones were shunted across the two elements. However, I soon found that much of the signal energy was being by-passed through battery and phones, causing a considerable loss in efficiency. It was to avoid this by-pass loss that the idea of a third element occurred to me. At first I tried a band of tinfoil wrapped around the outside of the round glass bulb, and thereby came a step nearer my objective. Finally, I hit upon the idea of using a lattice-shaped wire between filament and "wing." Lacking a better name, I called this the "grid," because it resembled an ordinary roaster grid. And that name has stuck.

So in 1906 my first three-element vacuum tube made its debut in my laboratory. By now I found that it was really a vacuum, and not a gas content, that I was after in the glass bulb. I called the device the audion.

My early audions had a small lamp base for the connections of the filament, as well as two lead wires protruding through the top of the glass bulb, one red and the other green, for purposes of identification. The red wire connected with the wing or plate, and the green wire with the grid.

Those first audions were fragile devices. The filaments were short-lived. The cost of radio entertainment per hour was high, I can assure you. The audion was generally sold with its associated equipment, as a complete unit. Each audion was a hand-made job. Probably no two were just alike. We did not have



THE AUTHOR IN 1919 WITH A "PORTABLE WIRELESS TELEPHONE FOR THE HOME," AS IT WAS DESCRIBED IN NEWS DISPATCHES OF THE DAY, WHICH PREDICTED THAT IT WOULD BECOME QUITE POPULAR "IN THESE DAYS OF UNCERTAIN TELEPHONE ILLS"

to worry about tolerances in those days. Experimenters were lucky to get them in any form and at any price. Strange as it may seem, we had a tube shortage even in those days, when a radio set in the home was considered an object of rare curiosity.

The early audions labored under many handicaps. Because they were hand made, there was certain to be a considerable variation in characteristics from one audion to the next. The elements were widely spaced and improperly positioned in many instances, so that there was a

BELOW—EARLY EXPERIMENTS WITH THE DE FOREST PORTABLE WIRELESS TELEPHONE AT NEWARK, N. J.

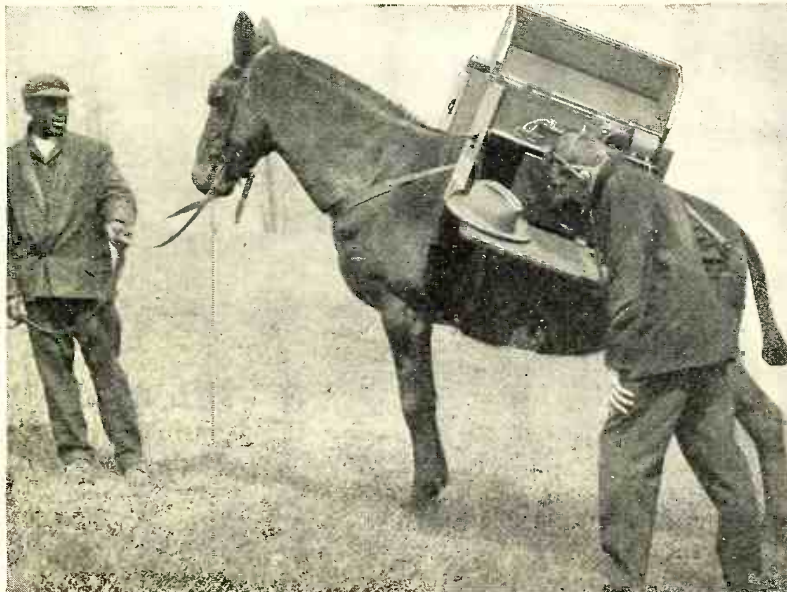

vast range in the characteristics. Filament and plate voltages were quite critical. Tubes were noisy, due to insufficient evacuation. If the plate voltage was increased beyond a certain point, the bulb would glow with a bluish fluorescence, indicating the presence of gas. Nevertheless, those first audions were remarkable detectors, judged by standards then extant, which made them highly popular.

With the audion as a basis, many things became possible. Here was an unlimited field for the research and development engineers. The entire structure of present-day radio—trans-oceanic, marine and broadcasting—rests on the vacuum tube or audion. The present-day long-distance telephone lines depend upon vacuum-tube repeaters to build up the attenuated voice signals. The present-day practice of transmitting a large number of simultaneous telephone messages over a single pair of wires is based on the use of the vacuum tube in providing the necessary carrier frequencies together with the modulations or sound values.

My radio-telephone activities date back to the early part of the present century,

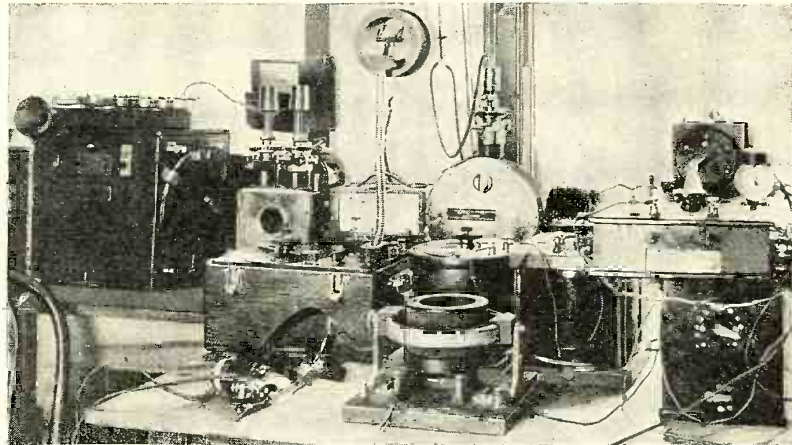

WIRELESS TELEGRAPH, WIRELESS PHONE, AND WIRELESS PICTURE MACHINE APPARATUS IN DR. DE FOREST'S LABORATORY BEFORE THE TIME WHEN BROADCASTING CAME INTO ITS OWN

and, indeed, were coincidental with my audion work. It was in 1907 that I designed and manufactured radio telephone sets for the U. S. Navy ships that sailed around the world under the command of the late Admiral "Fighting Bob" Evans. At that time my shop was in the old Parker Building at Nineteenth Street and Fourth Avenue, in New York City, the very building in which my first three-element audion was born. At the time, I had to use the tricky and altogether unsatisfactory carbon arc, burning in hydrogen, for my oscillator or wave generator. For testing these radio telephone sets, I made use of a phonograph playing directly into the mouthpiece of my transmitter. In another room, I listened in. It was George Davis, at that time Chief Electrician of the Brooklyn Navy Yard, who heard me testing, and became very much interested, as did others who picked up the stray radio telephone signals, in the possibilities of transmitting music through



AWAY BACK IN 1903, IN THE "WIRELESS HOUSE" ON THE ROOF AT 17 STATE STREET, NEW YORK CITY

space. Until that time, of course, the air had contained little else but the dots and dashes of wireless telegraphy.

It was the enthusiasm of these first listeners-in, together with what would now be termed "fan mail," that started my imagination going on the idea of mass communication or broadcasting of music and news bulletins, to a scattered audience. Since marine radio was the most highly developed phase of wireless at that time, I immediately thought in terms of ships. I visualized programs and news bulletins being flashed directly to ships at sea, through the medium of radio telephony. I could even see operatic performances being broadcast from New York to ocean travelers in mid-ocean. In other words, radio telephony had become for me no longer a means merely of point-to-point communication, but of mass communication. Nevertheless, my dreams were not to be realized for quite a while to come.

In March, 1908, I was in Paris demonstrating my wireless telephone system to the French Government, with the idea of equipping ships of the French Navy. I was first permitted to use an antenna strung from the first balcony of the Eiffel Tower. On a later occasion I used an antenna reaching to the top of that lofty steel structure, to see how far I might go in long-distance radio telephone communication. When all preparations had been made for the tests, word was sent to French radio stations and ships to listen in on our radio telephone transmission. The results were very encouraging. We reached Mery-sur-mer, near Marseilles, a distance of some 550 miles. I still made use of the carbon arc generator. My microphone consisted of a battery of four microphones connected in parallel and arranged in a sound chamber of funnel shape so as to provide a small mouthpiece into which the speaker could shout. Compare this, if you will, with the oversensitive microphone of today, which picks up the idle gossip of the indiscreet visitor to the broadcast studio! It's entirely a question of with or without audions! My early work was "without."

Early in 1909 I was back in the States and with the idea of program broadcasting still germinating in my mind. It became a full-fledged realization when I received permission to install a radio telephone transmitter in the Metropolitan

Opera House, and microphones on the stage. To make sure that the microphones were sufficiently sensitive to pick up music and voices at a distance, I had to employ the acousticon microphones such as were then used for the deaf! These microphones operated with dry cells, and their output led to a phone receiver in the attic of the opera house, pressed against the microphone of the radio telephone transmitter. We had no audion amplifiers in those days. Our transmitter microphone was placed in the ground lead of the transmitter, carrying the full force of our transmitted energy. You can well imagine how much time, money and cussing was expended on keeping the microphone in working order.

move our apparatus before the curtains parted.

Alas for our ambitions, a few listeners, mostly wireless operators, heard our broadcast of Caruso's voice. Still, it was the first and, so far, the last time that the Metropolitan Opera Company ever participated in a thing of that kind. Whether or not they felt, with the horrified Sicilians in the end of the opera, that we had "murdered neighbor Turiddu," I cannot say.

Nevertheless, undaunted by the slight success of my first ambitious broadcast, I started a series of broadcast programs with the idea that talent should be brought to our microphones under relatively ideal conditions rather than the microphones to the talent under purely improvised and often unsatisfactory conditions. Our studio was at 103 Park Avenue, in New York City, and our transmitting antenna on the roof.

At that time, Oscar Hammerstein was competing with the Metropolitan Opera, and I, taking advantage of the situation, managed to get Madame Mazarin, a noted French contralto of the Manhattan Opera, to sing before our microphones in our studio, the "Habanera" from Bizet's "Carmen."

Our ambitions far exceeded our possibilities. The arc generator was very inefficient and crude. The microphones were incapable of picking up sounds unless very close to the sound source. There was no suitable means of amplifying the weak electric current of the microphones, so that the sound values might be suitably impressed on the outgoing carrier wave. In the face of all these seemingly insurmountable obstacles, I was forced to abandon my broadcasting efforts until the time when better facilities could be placed at my disposal, and a larger audience would listen in.

It became evident to me, too, that my small organization could not hope to develop and perfect the audion. To do that required expensive research, and entailed engineering development rather than pure invention. I made arrangements with the Western Electric Company whereby subsequent developments of the audion were placed in the hands of their capable engineers. The move proved effective. By 1912 I was able to demonstrate an improved audion to the engineers of the Bell Telephone System, who undertook to develop it still further.

(Continued on page 281)

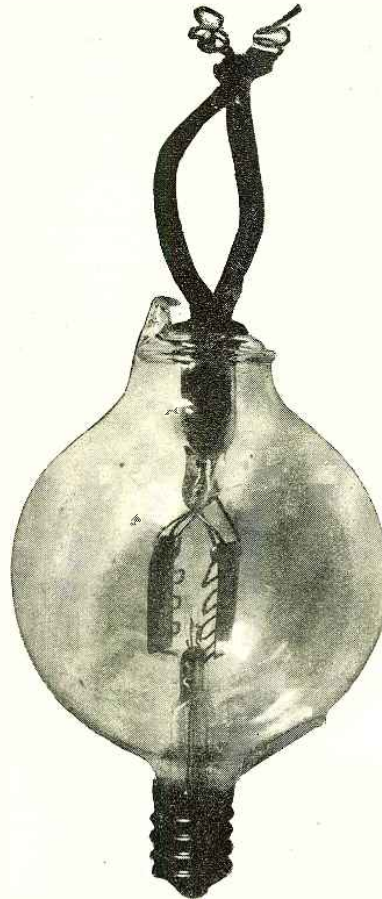

THE DE FOREST AUDION IN ANOTHER ONE OF ITS EARLY STAGES OF EVOLUTION

Nevertheless, with what equipment we had, we aspired to the pinnacle of showmanship, and prepared to broadcast the voice of Enrico Caruso singing the "Siciliana" in Mascagni's "Cavalleria Rusticana." This aria, as most of you know, is sung behind the scenes before the parting of the curtains. That arrangement made it particularly suitable for our purposes. We moved our microphones close up to the great Caruso as he sang behind the curtains, and he poured the glorious beauty of his voice into our all-too-inadequate microphones. Fortunately for us, Mascagni wrote several bars of music after the "Siciliana" and before the opening of the act. That gave us time to re-

BELOW—A SKETCH OF ONE OF DR. DE FOREST'S EARLY PHONE TRANSMITTERS USED IN THE COURSE OF EXPERIMENTS IN WASHINGTON

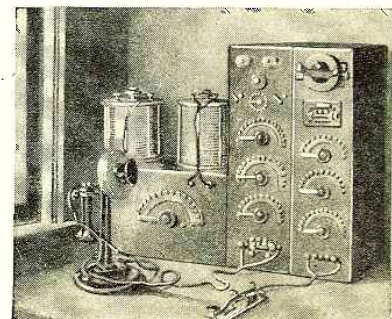

Various Methods of Suppressing Oscillations in Tuned R. F. Amplifiers

By

Glenn H. Browning
and James Millen

ONE of the most important questions which confronts the engineer when designing the radio-frequency amplifier in a modern receiver is a consideration of the best and most simple method of suppressing the tendency of the tuned circuits to oscillate. In fact, the more the amplification and the greater the number of tuned circuits employed, the more important this question becomes. This feedback in radio frequency, as it is usually called, may be due to the magnetic field of tuning coils which, if allowed to link together, will cause oscillations. Second, there is feedback caused by improper placing of the wires, improper by-passing of circuits, which carry radio-frequency current. Third, there is interstage coupling arising from the fact that there is a certain amount of capacity between the plate and grid of radio-frequency amplifier tubes. The first two sources of trouble may be reduced to a minimum by careful mechanical placing of the coils, and other important parts, or by complete shielding. For instance, in a two-stage tuned radio-frequency amplifier, in which the gain is not too great, placing the coils at right angles or at an angle of some 57° will usually reduce the feedback due to the interlocking of magnetic fields sufficiently to make the receiver satisfactorily operate. When more stages are employed, however, with the increasing gain, careful shielding of the tuning coils is usually necessary. The important point is that these inherent difficulties, in the radio amplifier, may be controlled within limits by proper design construction. Not so, however, with the third source of interstage coupling arising from

“AS far as the writers know, the grid suppressor type of ‘losser’ has been accepted by the public though no explanation of how it functions has been described. The theory of its action is not only applicable in tuned radio frequency amplifiers where ordinary tubes are used, but it is also an open question whether or not it cannot be applied in the case of screen grid tubes being used as radio frequency amplifiers, because even in this case there is a great deal more tendency toward oscillation at the low wavelengths than there is on the longer ones.”

the construction of the amplifying vacuum tube itself. Let us analyze the circuit shown in Fig. 1, in order to determine the exact electrical action taking place and the various methods of counteracting the tube capacity. As will be noted, tuned circuit No. 1, in which a radio-frequency signal has been induced, produces a voltage across it which is applied to the grid-filament of the amplifying tube. This signal is reproduced in the primary of the radio-frequency trans-

former and transferred to the secondary (tuned circuit 2) circuit. By tuning both circuits to resonance with the signal frequency a voltage may be built up across No. 2 which is 10 to 18 times that produced across circuit No. 1. In other words, the vacuum tube and tuned radio-frequency transformer has amplified the signal by that amount. Unfortunately, however, some of the energy is fed back through the grid to plate capacity, Cpg. (represented by the dotted lines), of the tube itself, so that if the resistance in the coil and condenser in circuit No. 1 is sufficiently low, continuous oscillation takes place. This feedback of current depends upon two factors. First, the magnitude of the tube capacity and, second, the amount of positive reactance built up in the primary circuit of the radio-frequency transformer. Both of these factors vary with frequency, as will be explained when the analysis of the grid suppressor is considered. There are two general classes of methods for keeping circuit No. 1 from oscillating; that is, neutralization methods, and “lossers.” Under the neutralization methods is the Rice bridge system, shown in Fig. 2.

This consists essentially of connecting the filaments of the amplifier tubes to the center of the tuned circuit and placing a small condenser between the plate and the rotor plates of the tuning condenser for neutralization purposes. It will be noted that in this case only half of the voltage built up across the tuned circuit is put into grid-filament of the amplifier tube. However, there are two other disadvantages which accrue; one is that the stator plates of the tuning condensers are

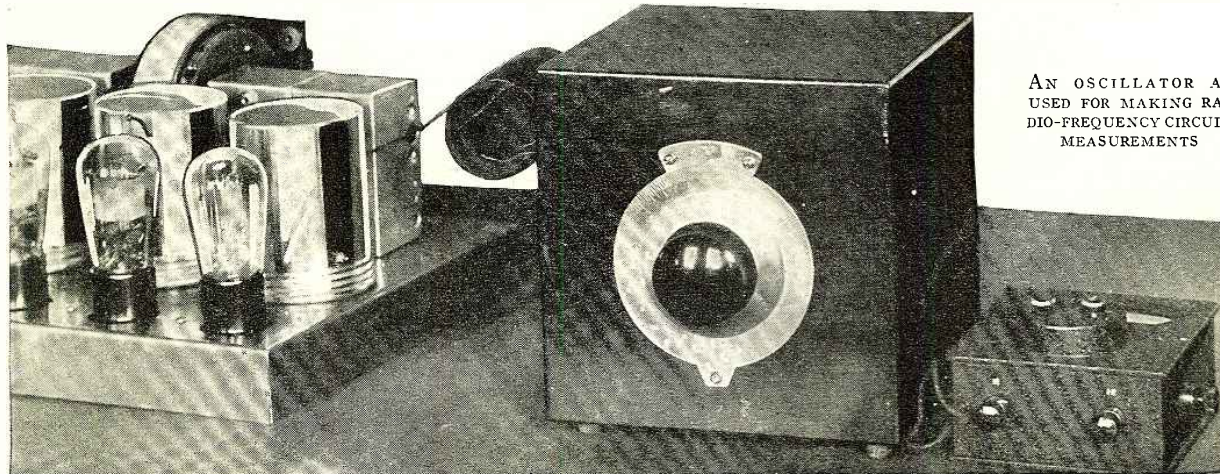

AN OSCILLATOR AS
USED FOR MAKING RA-
DIO-FREQUENCY CIRCUIT
MEASUREMENTS

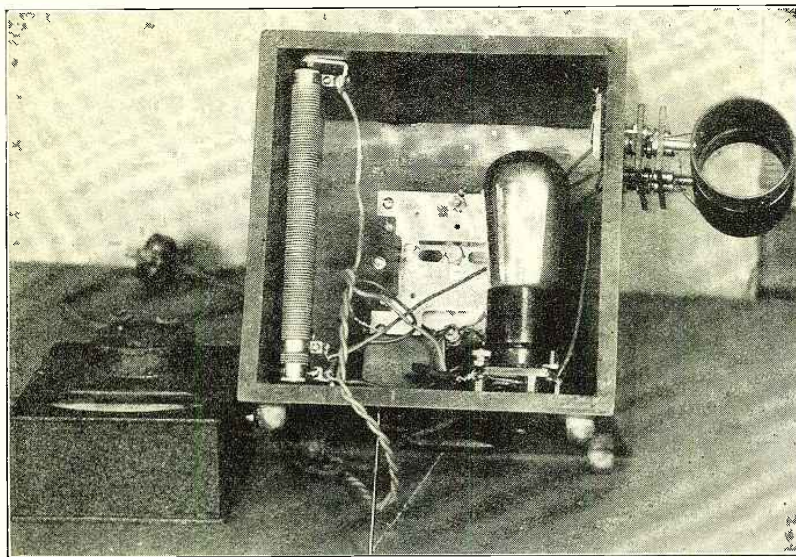

INTERIOR ARRANGEMENT OF THE OSCILLATOR SHOWN ON THE PREVIOUS PAGE

not at ground potential, and may probably cause body capacity effects to be produced. The second is that in ganging these condensers for making a single control radio receiver, the neutralization affects somewhat the capacity in the tuned circuit.

The second method is known as the Hazeltine neutralization method and is

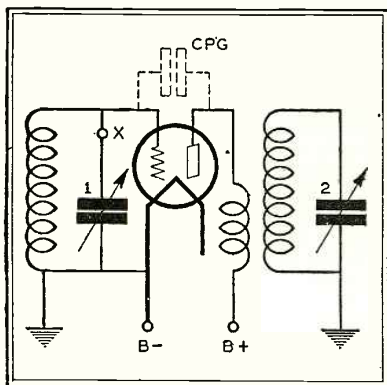

FIG. 1 SHOWS A ONE-STAGE TUNED RADIO-FREQUENCY AMPLIFIER. THE CAPACITY BETWEEN THE PLATE AND GRID INHERENT IN THE TUBE IS SHOWN IN DOTTED LINES

shown in Fig. 3. In this case, the total voltage of the first tuned circuit is put across the grid-filament, but even this method has a disadvantage, for, when a number of tuning condensers are ganged together, the neutralization affects the capacity in the tuned circuit, making it necessary to line up the circuit carefully, neutralize, and then re-line the tuning condensers.

These methods have been successfully used in the past, though in large scale production many difficulties are encountered.

We now come to a consideration of the "losser" methods, only one of which, in the opinion of the writers, is worthy of being taken up in detail here.

As far as the writers know, the grid suppressor type of "losser" has been accepted by the public, though no explanation of how it functions has been described. The theory of its action is not only applicable in tuned radio-frequency amplifiers where ordinary tubes are used, but it is also an open question whether or not it cannot be applied in the case of screen-grid tubes being used as radio-frequency amplifiers, because even in this case there is a great deal more tendency toward oscillation at the low wavelengths than there is on the longer ones.

Fig. 4 shows a grid suppressor inserted in the circuit of a one-stage tuned radio-frequency amplifier. The action that takes place is briefly this: The feedback, as has been pointed out before, depends upon the amount of positive reactance built up in the plate circuit of the amplifier tube. The greater this positive reactance, the greater the tendency to oscillate. It so happens that this positive reactance varies directly with frequency. The amount of current fed back through the grid to plate capacity of the amplifier tube also varies directly with frequency. This means that the total regenerative effect of these two varies directly as the square of the frequency.

FIG. 2 SHOWS THE RICE METHOD OF NEUTRALIZING THE FEEDBACK INHERENT IN THE RADIO-FREQUENCY AMPLIFIER TUBE

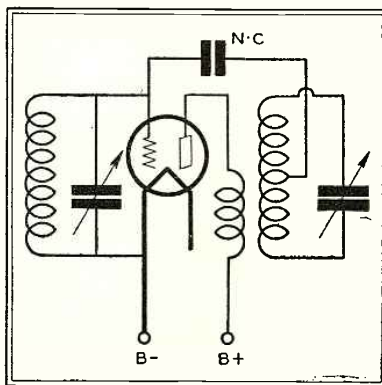

Suppose, for instance, that in Fig. 1, circuit No. 1 oscillates. By inserting a resistance in series with the condenser and coil, at the point marked X, we could throw circuit No. 1 out of oscillation because of the loss introduced by this added resistance. Even though we have inserted this resistance, if it was only sufficient to keep circuit No. 1 from oscillating, the amplification of the whole system would probably be as great, or a little greater, than if some of the neutralization methods were used, because in this case we would make use of some regeneration or feedback introduced through the capacity of the amplifier tube. If the resistance necessary to keep circuit No. 1 from oscillating was exactly the same no matter whether the circuit was tuned to 200 or 550 meters, this would be an excellent system. However, if the resistance was sufficient at 200 meters, it would be a great deal too much at 550 meters, and thus the amplification at the longer waves would fall off. Consequently, we should have some scheme of varying this resistance automatically from the short to the long waves. This is exactly what a resistance in series with the grid of the amplifier tube accomplishes.

If we were inserting a resistance in series with the coil and condenser, this

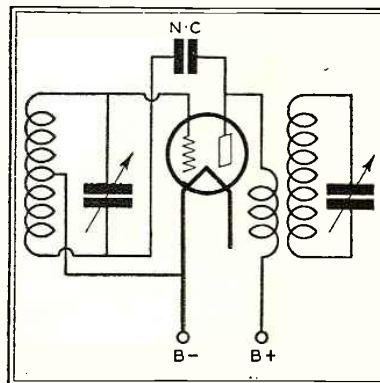

FIG. 3 SHOWS THE HAZELTINE METHOD OF NEUTRALIZING THE GRID-TO-FILAMENT CAPACITY IN A RADIO-FREQUENCY AMPLIFIER TUBE

resistance should be automatically varied as the square of the frequency, if the same regenerative effect were to be obtained from the long to the short waves. In the case of a resistance in series with the grid, this is exactly what happens, for the loss introduced into the tuned circuit depends upon the amount of current passing through the grid suppressor. At first glance, it would seem that no current passes through this resistance at all. However, there is a capacity between the grid and the filament of the vacuum tube which is about 15 mmfd. Were the grid suppressor not present, this capacity would be in parallel with the tuning condenser; consequently the current through these two condensers would divide according to their size, more current going through the larger; but with the grid suppressor present, the current that passes through the grid-filament capacity of the tube also goes through the grid
(Continued on page 280)



AN AFTERMATH OF THE FLORIDA HURRICANE, LAST YEAR

© International

For REAL THRILLS

Get Down in the

AMATEUR WAVE

*"And only the Master shall praise us,
and only the Master shall blame;
And no one shall work for money,
and no one shall work for fame,
But each for the joy of the working,
and each, in his separate star,
Shall draw the Thing as he sees It for
the God of Things as They are!"*

THUS does Kipling, writing of art and life, epitomize the spirit of the scientific amateur. There are many branches of science, but the same spirit of endeavor pervades them all. It may be astronomy, fascinating to many, perhaps too remote for most; or meteorology, wherein also the experiments are prepared by nature, but become vital only when they result in a holiday rainstorm. Usually, however, a man likes a hobby that he can get his hands as well as his mind on; he wants to strive for perfection with limited means, and achieve success in difficult and specific efforts.

Two avocations which can be described by that overworked adjective, "practical," yet reflect some glow of pure science, are aviation and radio. Most of us are interested in them both; which one is best, there is no need to decide; which is cheapest, is plainly apparent. You can get on the air day after day for a few dollars; to get in the air more or less continually will cost a few hundred. Both arts alike transcend old notions of time and space, and both in their future development will be inseparably intertwined.

*Sitting Comfortably in Your Own Home and Run-
to Flood Relief Reports, with DX Friendships*

BY WILLIAM H.

There are now over fifteen thousand transmitting amateurs in the United States alone, and many more in other parts of the world. Many of them sit down of an evening for a pleasant code chat with some foreigner in a far country; or some explorer in arctic cold or equatorial heat. Others talk to a friend in the next state or county by radio telephone, collect weather information for air transport lines, or handle domestic traffic with the speed and certainty of commercial stations. And some may probe that nebulous, frigid sea of helium many miles above the earth's surface with their light-speed waves, investigating a problem that goes back to known physics and forward to the unknown changes rung in the altitude of the northern lights by the ever-varying energy shot out from our distant yet all-powerful sun.

We may divide radio amateurs, according to their particular interests, into three great classes. First of all are the distance-getters. It is a great moment for the beginner, of course, when he works his first station—hears another operator calling him after his first timid transmission. The exalting trepidation most of us feel

at this time corresponds to the mental fog that besets most pilots on their first solo flight. But the next high-water mark on our log books is when we first raise "down under"—the Antipodes, or indeed any distant foreigner. I can remember distinctly enough, raising my first "big DX" some years ago from El Paso, Texas, when in the very early morning Z-1AA answered U-5AKT's hundred-watt growl. It was Mr. C. C. N. Edwards of Auckland, New Zealand, and we held perfect communication for more than an hour. It is a marvelous thing, rightly considered, to engage in easy thought exchange with another human being over eight thousand miles away, whose night is your day, whose down is your up, whose direction is not north or east but *straight down* through the solid earth. And high power is not essential for distance. W2CX, here at West Point, has worked France with a UX-210 tube and an input power barely sufficient for two auto headlights. As for what *can* be done on 40 meters, more than one experimenter has transmitted thousands of miles with 90 volts of "B" battery on a 199! But for all its fascination we are probably right in re-



BANDS

*ning the Gamut from Exploration
Thrown in for Good Measure*

WENSTROM



garding mere distance-getting as a passing phase for every individual operator, mostly because of the spherical shape of the earth. This, if memory does justice to history, also perplexed Alexander. But in science there are always new worlds to conquer, and there is never time, whatever the inclination, to sit down and weep.

A second group of amateurs, probably the backbone of the fraternity, is the traffic handlers. They are expert operators who pride themselves on their send-

ing, copying and rapid, clean-cut procedure. They are valuable potential material for the army and navy in our new scheme of national defense; they keep in touch with expeditions; and in emergencies and disasters, as we shall see later in this article, they often perform distinguished and hazardous service. Of course, the other amateur types also gladly do their part in emergencies, as anyone who holds a license must be at least a fair operator.

The third type, not too numerous but perhaps most interesting, is the experi-

RADIO AMATEURS HAVE PLAYED IMPORTANT ROLES IN SUCH DISASTERS AS (TOP ILLUSTRATION) THE FLOODS WHICH INUNDATED PARTS OF GEORGIA, AND THE TORNADO WHICH PLAYED JACKSTRAWS WITH HOUSES IN LAKE WORTH, FLA. TO SAY NOTHING OF THE THRILLS OF CONTACTING BY RADIO WITH THE BYRD ANTARCTIC EXPEDITION

menter—the man who subordinates operating to engineering. He is more interested in his angle of radiation than in his



CARL BEN EIELSON and Sir Hubert Wilkins when they made their flight over the south polar regions used the government house at Deception Island (shown at the right as radio headquarters). This station not only supplied the world with news, but was in communication with a number of amateurs who had the vicarious pleasure of direct contact without having to resort to newspapers.

extreme range, and is probably a good deal of bother to other "hams" when he asks them to stand by and note what difference in signals, if any, is occasioned by his circuit changes. Yet he is the man who has placed amateur radio on the technical pinnacle it occupies today. Many of us can recollect that, as late as 1924, the short waves were considered valueless for long-distance communication by most professional engineers, though high frequencies had been used long before in the experiments of Hertz and Marconi. In that year, students in the foremost electrical schools were taught the Austin-Cohen formula, which conclusively stated that the shorter the wave, the shorter the distance to be expected with it. It was the experimenting amateurs who proved the Austin-Cohen formula seriously in error at the high-frequency end of the spectrum, and they proved it unmathematically and empirically by actually reaching Europe and the Antipodes with waves below a hundred meters in length. Today, hundreds of high-power commercial stations, backed by millions in capital, are fighting for assignments in these formerly despised bands.

Radio amateurs have contributed greatly to the progress of civilization by keeping exploring expeditions in touch with their home bases. In the summer of 1925, when the able schooner *Bowdoin* sailed to Labrador and Greenland, an amateur went along as her operator, and kept contact from the arctic circle with other amateurs all over the United States. In the same year the big steam whaler, *Sir James Clark Ross*, was shoving her steel nose into the frigid antarctic seas around the great ice barrier, and putting down 40-meter signals in Massachusetts. On one occasion her operator put a microphone in the ground lead of an oscillating receiver and talked 50 miles across the icy ocean to a smaller boat. Up in Greenland, in the following year, the University

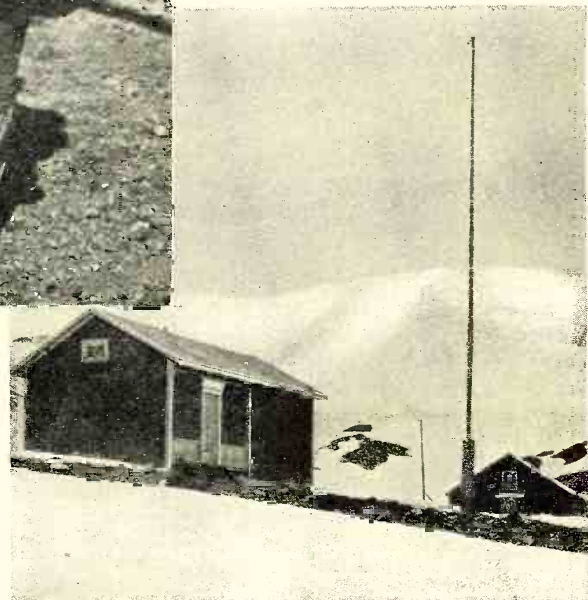



BOTH THE LICENSED AMATEURS AND THE ARMY SIGNAL CORPS, WORKING ON SHORT WAVES, WERE INVALUABLE MEANS OF COMMUNICATION DURING THE DISASTROUS NEW ENGLAND FLOOD OF A LITTLE MORE THAN A YEAR AGO

of Michigan station began to dig in on the Greenland ice cap, amateur transmitter and all; and it is still there, doing meteorological work of the utmost value and maintaining constant touch with home. And down in the steaming jungles of Brazil another short-wave transmitter went with the Dyott expedition, to fling its clear-cut signals over the hemisphere from the backwaters of the Amazon. Radio equipped expeditions grow in number each year—an electric voice is now almost standard practice—but their complete stories would fill several books. The



WIRE COMMUNICATION SELDOM SURVIVES UNDER CONDITIONS SUCH AS PICTURED HERE. IT IS THEN THAT THE RADIO AMATEUR COMES INTO HIS OWN

amateurs are always glad to help out, for the spirit of adventure is strong in us, even if we cannot all journey beyond the known horizon's rim.

This coöperation was well demonstrated to me personally in the summer of 1926, when we had a 37-meter experimental transmitter aboard the army transport *Château-Thierry* on a trip from San Francisco to New York. As the ship was only in port for three days before sailing, everything about the installation was hurried. The two 50-watt tubes, under the ministrations of a 750-volt dynamotor which later developed particular talents for absorbing most of the moisture and dirt in the tropics, delivered a bare 30 watts to the antenna; and the lead-in had to run through a bolt hole in

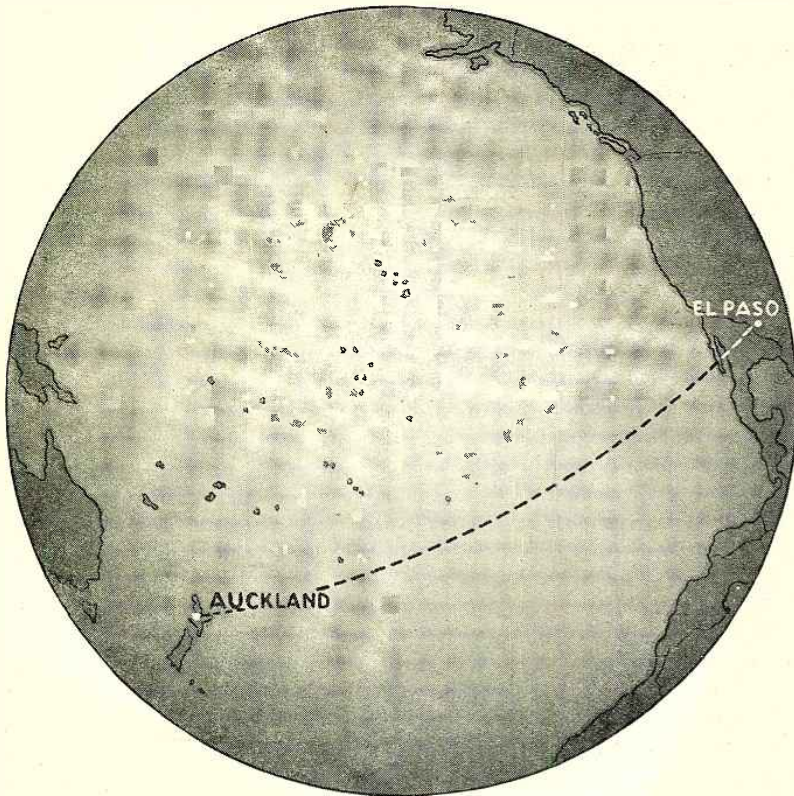

THE AUTHOR'S FIRST REAL DX THRILL; HOLDING MORE THAN AN HOUR'S TWO-WAY COMMUNICATION FROM EL PASO, TEXAS, WITH A BROTHER AMATEUR IN AUCKLAND, NEW ZEALAND

the steel wall. A local engineer predicted our signals would never get out at all, and we were inclined to agree with him. The final sailing whistle found us perched high up on the foremast, stringing the antenna as the ship backed out into the harbor. The inside installation was finished at sea, the next afternoon, and within an hour we had raised 6CUB at Venice, California. During that night, as the ship forged southward off Lower California, we clicked with St. Louis, San Francisco, Fort Leavenworth (Kansas), Dallas, Indianapolis, Oklahoma City, Minneapolis and El Paso! The crisis was past; the jinx had apparently blown overboard in the fresh sea breeze. But it returned temporarily a few days later when the dynamotor developed fever heat combined with a pronounced disinclination to run, and had to be taken apart for a thorough overhaul.

Receiving was none too good, though we did hear one or two Australians. The physical and electrical noise levels were high, the receiver suffered considerably from the ship's vibration, and when the big whistle just above the roof went into action the receiver practically stopped receiving altogether and devoted all its energies to jumping up and down on the table. The atmospherics were atrocious, growing into one continuous roar as the blue Mexican and Central American mountains moved along the eastern horizon in a stately and unhurried procession. The long-wave static was so bad that we had to put through some official traffic to Balboa on the short-wave set, after re-

peated attempts with the 5-kilowatt long-wave arc extending through 36 hours.

Finally the brilliant green hill jungles of Panama appeared to port, and the next morning we were cruising slowly back and forth in the bay outside the canal entrance. That night, at the dock in Balboa, we spoke the cruiser *Memphis* off Seattle, 3,500 miles away, and sent messages home through 4RY at Montreat, North Carolina. So the voyage continued, through the canal, across the Caribbean to Columbus' Island, and up the Atlantic

Coast; and always these unselfish private operators were ready, day after day, to talk for a few minutes, to send us news or to relay our messages.

Quickly as expeditions have seized on radio, they have been no less progressive with aviation. Up in Alaska the first Wilkins expedition did some splendid flying under the most adverse conditions, and its two amateur radio operators worked all around the territory with low-power sets. When Wilkins and Eielson were forced down on the ice far north of Barrow and walked laboriously back to the coast, they had to abandon their plane and with it one of the transmitters. As a result the Barrow transmitter went into another plane for the later flights, and Mason, the Barrow operator, had to improvise a transmitter out of the odds and ends available. This he did, using cut-up tin cans, cigar boxes and flashlight bulbs; and what is more, the set worked, putting out dependable signals for several hundred miles.

During the aerial derby from California to Hawaii in 1927, amateurs maintained a constant circuit for the newspapers between the coast and the islands, and worked some of the planes as well. Everyone remembers how, when some of the early starters were lost at sea, Major Erwin with generous courage pointed his "Dallas Spirit" towards Hawaii in search of them. Eichwaldt, the navigator, operated a small transmitter on 33 meters which gave amateurs all over America news of their tragic but splendid flight. Hundreds of miles out over the darkened Pacific their clear and steady transmissions began to wobble, indicating rough air and uneven speed, despite Eichwaldt's unhurried telegraphic banter. Then came the first SOS, but "Belay that" immediately canceled it. Eichwaldt explained that they had been in a spin, but had pulled out of it. In a moment, however, the unsteadiness of their note told of another spin, and as the plane plunged down to its end Eichwaldt sat there, calmly tapping out with even spacing the final SOS, and setting an example of courage and attention to duty for all the radio operators of the future. The amateur listeners on

(Continued on page 285)

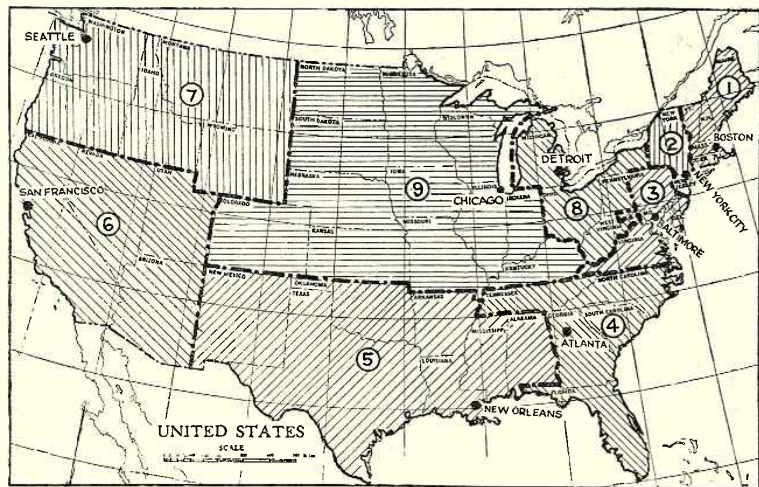

A MAP SHOWING THE NINE RADIO ZONES OF THE UNITED STATES, WITH THE CITY INDICATED IN WHICH EACH ZONE SUPERVISOR IS LOCATED



The Junior Radio Guild



THE Junior Radio Guild is an organization devoted to teaching boys the fundamental principles of radio; not in dry text-book or lecture fashion, but by a method based on an understanding of true boy psychology.

Roughly speaking, something like a million boys each year enter what is known as the "mechanical" age—the age when they want to make things. Some of these boys are interested in one thing, some in another; but a large percentage of them are interested in radio. Many of them are anxious to know more about the how and the why of radio, either as a hobby or as a future career. It is for these boys that the Junior Radio Guild exists; affording them a means of learning the essential principles; teaching them to learn by actually doing; and, if they wish, to earn while learning.

The Junior Radio Guild already has a membership of some twelve thousand boys who are interested and anxious to understand how broadcasting is done, how receivers function, how they are constructed. These boys joined the Guild in order to learn these things.

RADIO NEWS plans to expand the scope of the Junior Radio Guild so that every boy who has a natural leaning in that direction may be given the opportunity to join.

Elsewhere in the pages of this issue will be found an advertisement giving the details of enrollment requirements. Meanwhile, on this page we present the first two lessons of the course of instruction; inaugurating here a regular monthly department which will be devoted to the interests of the Junior Radio Guild.

ELEMENTARY RADIO THEORY LESSON I

RADIO stations as we know them, that is, broadcasting stations which transmit music and speech, all operate more or less on the same general principle. True, all stations are not alike, but for the purpose of this discussion their individual differences need not be considered.

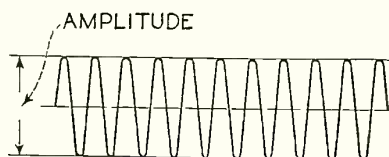

~OSCILLATIONS OF
CONSTANT AMPLITUDE~
(CARRIER WAVE)

FIG. 1

WHEN A STATION GOES ON THE AIR ITS CARRIER WAVE IS COMPOSED OF OSCILLATIONS OF CONSTANT AMPLITUDE OF THE FREQUENCY TO WHICH THE STATION'S TRANSMITTER IS TUNED

The vacuum tube, when placed in a specially designed circuit, is capable of generating radio frequency energy, or as is more commonly known, a wave, whose length from crest to crest is determined by the adjustment of the tuning elements of the circuit, namely, the coils and variable condensers. Now the radio frequency energy, which is transmitted at that wavelength, is composed of a train of oscillations or alterations. This wave train is of continuous amplitude. That is, each succeeding alternation is as similar to the one preceding it as to the one

following it. This is explained in Fig. 1.

Electrical vibrations are produced in the microphone in the broadcasting station by the speech or music being picked up by it, but these vibrations are not directly transmitted or sent into the ether. They are passed into what is called a speech amplifier which strengthens them. The output of this amplifier is then superimposed or placed on the wave of continuous amplitude previously referred to above, which is being produced by the radio-frequency generator. This generator, in radio terms, is called a radio-frequency oscillator and the wave it produces is known as the carrier wave. It is this wave that carries the music or speech through the ether to your receiving equipment. As a result of superimposing or combining the microphone vibrations with the carrier wave the transmitted wave as it reaches your receiver does not maintain its continuous amplitude character like Fig. 1, but, instead, takes the shape somewhat like that shown in Fig. 2. The actual shape of the transmitted wave depends, of course, upon the variations in sound going through the microphone, which, in a way, mold or shape the continuous amplitude or carrier wave. Changing the shape of the carrier wave is known as modulation.

After the oscillator or carrier wave is modulated by the voice or music vibrations it is passed along to the antenna or aerial system of the station, which radiates it into space.

This very briefly describes how a modern broadcast transmitter operates. It does not take into consideration such questions as the power of the transmitter,

or the wavelength to which it is adjusted. These are subjects which concern each individual transmitter and have no direct bearing on the general principle which governs the operation of all broadcasting stations.

How Radio Receivers Work

Just as there are many different types of transmitters, there are also various types of receivers, each having its own particular kind of circuit. As in the case of the transmitter, it is not the purpose to describe the exact action of each of these various receiving circuits, but rather to outline the broad principles of all receiving circuits.

The antenna or aerial, erected for receiving, absorbs or collects a part of the radio-frequency energy radiated from the antenna of the transmitting station. The

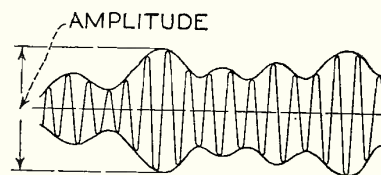

CARRIER WAVE
MODULATED BY
AUDIO FREQUENCY
OSCILLATIONS.

FIG. 2

WHEN THE MICROPHONE OF THE TRANSMITTER IS ACTUATED BY SPEECH OR MUSIC, THEN THE CARRIER WAVE IS MODULATED WITH THE AUDIBLE FREQUENCIES, AS SHOWN HERE

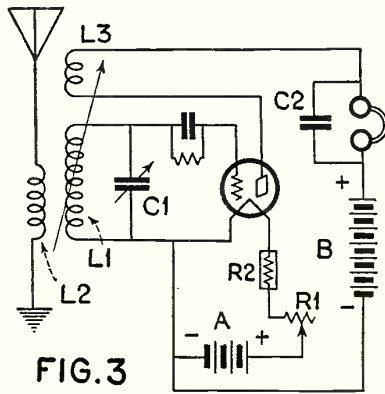

FIG. 3

THE CIRCUIT DIAGRAM OF A SIMPLE REGENERATIVE DETECTOR IS GIVEN HERE. IT IS AROUND THIS CIRCUIT THAT THE COMPLETE FIVE-TUBE RECEIVER DESCRIBED IN THESE LESSONS HAS BEEN BUILT

energy so collected is still of the modulated radio-frequency character. It cannot be heard by the human ear directly. To illustrate this let us digress for a moment. Sound is composed of vibrations. The tone of these vibrations depends on the number of vibrations which occur in one second of time. Your electric light current, depending upon your location, is either of 25, 40 or 60 cycles or vibrations a second. When heard, it sounds like a low bass tone. Sounds of higher frequencies or more vibrations progress gradually from the bass tones to the high treble notes and then on to the shrill whistles. The frequency at which these vibrations take place can increase to such an extent as to be beyond the range of the human ear. A tone of 10,000 vibrations is difficult to hear unless your sense of hearing is unusually keen. Vibrations above 25,000 cycles are called radio frequencies which do not directly manifest themselves to the ears of humans. Now, to get back to our discussion of receiver operation.

As previously stated, the vibrations received are modulated radio frequency and as such cannot be heard by the human ear. Therefore, it becomes necessary to use some device which will change the character of the vibrations so that they can be heard. The device used for this purpose is called a detector, and the work it performs is known as detection or rectification. Crystals of certain kinds have the ability to change the character of these vibrations, but in modern receivers a vacuum tube more efficiently performs this task, as it is more sensitive. The actual operation of a vacuum tube as a detector or rectifier is too great a subject to be taken up in this limited space; besides, it is not intended to treat the subjects to be discussed in too technical a manner. You can supplement the study derived from this course by a reading of technical works dealing with that particular subject in radio in which you desire more detailed information. The purpose of this course is to provide an understanding of the practical side of radio.

The vibrations coming from the detector tube are of an audible nature. That is, they can be heard with a pair

of ear phones connected between the plate of the tube and a battery. Programs can be distinctly heard, although the volume of sound will not be great. This brings us to the next step in the operation of a receiver. In order to strengthen the vibrations from the detector tube so that they will be sufficient to operate a loud speaker, delivering satisfactory room volume of good tone quality, it is necessary to step them up or amplify them. This amplification may be accomplished in several ways, but the one most commonly used is through audio-frequency transformers. This system will be described here. The amplifier consists of two audio-frequency transformers and two audio-amplifying tubes arranged in the following order: First stage audio transformer to first stage audio amplifier tube; to second stage audio transformer to second stage audio amplifier tube; to loud speaker. Added to this is the accessory apparatus such as automatic tube regulating controls, tube sockets, etc., which will be discussed later.

The audio amplifier takes the signal or vibrations from the detector and by means of the amplifying tubes and transformers enlarges the original signal so that it is louder than that heard in the phones originally. When thus amplified it is capable of operating a loud speaker so that it may be heard all over the room.

Audio amplification as applied to receivers means amplifying or stepping up the signal *after* it has been rectified by the detector. There is still another way of amplifying or strengthening the received signal. It consists mainly of amplifying and strengthening the signal *before* it reaches the detector. This is called radio-frequency amplification. Not only does r.f. amplification strengthen the signal before it is rectified by the detector, but also it provides a filtering action which increases the selectivity of the receiver. By selectivity is meant the ability to shut out every signal except the one it is desired to hear. Naturally, also the amplification provided by the use of a radio-frequency amplifier stage or stages will make it possible to hear signals from greater distances which could not be heard before. In other words, the sensitivity of the receiver is increased by the use of radio-frequency amplifiers.

This in general completes the outline of the operation of the various units of a complete receiver. In the lessons to follow, each individual unit will be discussed and a more detailed description of its operation will be given.

How to Understand Radio Diagrams and Symbols

In radio it is necessary to show from time to time the arrangement of, say, a receiver. Since a receiver consists of coils, tuning condensers, tubes, transformers, variable resistances, automatic filament controls, etc., it would be difficult if every time a diagram was required it were necessary to draw an actual picture of the various parts to show the several terminals and how these were connected, one to the other. Therefore, as a short-cut, the use of symbols is now generally employed. Note circuit diagram in Fig. 3.

As an aid in understanding these symbols, a chart is shown on page 244. Not only is the symbol, for instance, of a coil shown, but also an actual picture drawing of a typical coil so that you may have no doubt as to how a coil is represented in a circuit diagram. It is recommended that you study these symbols thoroughly and then try to draw them for the various parts shown without looking at the symbols. Then check back to discover errors. In this way you will learn not only how to read and understand these symbols, but also how to draw them accurately.

After you are thoroughly familiar with the reading and drawing of the complete chart of symbols, you may then attempt to read a complete circuit diagram. For example, let us take the simple circuit shown in Fig. 3 for analysis. First, it is evident that since only one tube is represented, the circuit is what is called a "One Tube-r." The large coiled line (L1) to the left of the tube symbol represents the secondary coil. It is to be shunted (connected at both ends) by a variable condenser (C1), which is the tuning condenser. We know this condenser is variable because of the arrow running diagonally across the symbol. To the left of the coil (L1) is still another coil (L2), but smaller than the first. It is seen that this latter coil has attached to it the antenna and ground, so that we may safely assume that it is the primary or antenna-ground coil. Then, looking further, we see that the plate of the tube connects to a third coil (L3), which is

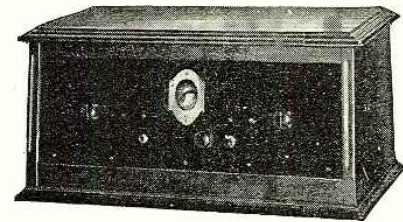

HOW THE FIVE-TUBE RECEIVER WILL LOOK WHEN FINALLY COMPLETED. ONE MAIN TUNING KNOB CONTROLS THE TUNING OF THE SET WHILE THE OTHERS CONTROL SENSITIVITY AND VOLUME

situated just above the secondary coil (L1). This third coil is the tickler and by the long arrow drawn through the secondary and tickler coils we see that the latter is variable in its relation to the secondary coil (L1). Inspecting the filament circuit of the tube (the part connected to the A battery), we see that in addition to the variable resistance (R1), which is the main control rheostat, the tube is also fitted with an Amperite (automatic filament control) (R2). Thus we can easily see that (R2) will automatically limit the filament voltage to the amount required by the tube, while the rheostat will allow a hand control of the voltage below the maximum amount so as to regulate volume. Following the tickler circuit through, it will be seen that the phones are included in the plate circuit of the tube and are shunted (connected at both ends) by a fixed by-pass condenser (C2), thence continuing on to

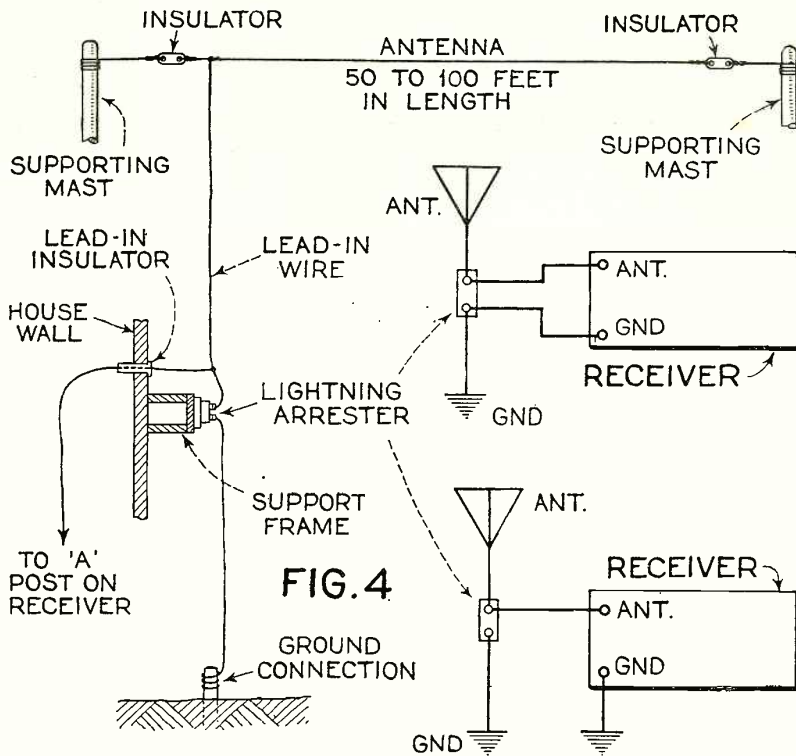

FIG. 4
THERE ARE SEVERAL WAYS IN WHICH A LIGHTNING ARRESTER CAN BE CONNECTED TO THE RECEIVER AND ANTENNA-GROUND SYSTEM. TWO ARE SHOWN ABOVE

the plus side of the B battery. Note also that the minus side of the B battery is connected to the minus terminal of the A battery.

Antenna Construction and Erection

Just a few pointers on the antenna-ground system. At the broadcasting station the purpose of the antenna is to radiate the radio waves into space. At the receiving station it is the job of the antenna to absorb a portion of this radiated energy and pass it along to the receiver coils and other tuning apparatus so that of all the waves absorbed the desired one may be selected. This is called the process of "tuning-in."

Now there are a number of considerations which must be given to the construction and erection of the antenna if it is to be really efficient, that is, if it is to absorb a maximum of energy and waves. First, it should be erected as high as practically possible. The wire used for the antenna should be strong enough to be pulled tight so that there will be no slack after it is put up. Antenna wire usually consists of seven strands of copper or bronze wire. Second, it should be located in an unobstructed place. If it is placed close to other large metallic objects such as a tin or copper roof, the received signals will be seriously weakened. Third, it should be erected in such a manner that it is free from contact with other objects. At no point along the length of the antenna or its lead-in wire

should it come in contact with cornices, supporting masts, sides of the house or any grounded object. If such contact does take place, not only the efficiency of the antenna's receiving qualities become reduced, but also a disturbing, scratchy noise will be produced in the receiver due to the constant making and breaking of the contact between the antenna and the other object.

The down lead, otherwise termed the lead-in, should comply with fire underwriters' rules in that it should be connected to a lightning arrester at the point where the lead is brought into the house. All these points are made clear by referring to the sketch, Fig. 4.

THEORY OF THE DETECTOR TUBE. LESSON II

IN general, detector and amplifier tubes are similar in that they have three elements, filaments, grid and plate, and differ only in the mechanical construction and placement of these elements, depending on the purpose and use of the tube. The exception to this is the screen-grid tube which, besides the three elements named above, has an additional grid structure.

For purposes of discussion, let us suppose that to the detector tube has been connected a coupling tuner consisting of primary, tickler and secondary coils, head phones, filament control, grid leak and grid condenser, phone by-pass condenser and both the A and B batteries. The circuit will be found in Fig. 3.

Now, let us see what happens. When the tube is inserted in its cocket the current from the storage A battery lights the filament within the tube. Thus violently agitated the filament releases electrons which are attracted to the plate. This

is because the electrons are negative in character, while the plate, due to the B battery, is of a positive nature, and, because of a law of electricity which says that like forces repel each other, while unlike forces attract each other, it is easy to understand how the positively charged plate attracts the negative electrons from the filament. Now, when the correct filament voltage is applied (the value for satisfactory operation is always specified by the manufacturer on the carton in which the tube is purchased . . . usually 5 volts) the tube will be working at that point which will cause a rectification of the received signal. Reference to Fig. 5 will illustrate this point. The curved line A . . . B is what is called the tube's characteristic curve. When the signal, indicated by the waving line at the bottom, S . . . S, is applied to the tube it will be seen that the shape of this wave in the output or plate circuit is not the same as the original wave but instead is distorted. That is, the lower portions are not reproduced to the same amplitude as the upper portions. In the phones is heard the audio tone which is produced by the minute variations of the plate current as indicated by the enveloping line termed "audio-plate current variations" in Fig. 5. This variation in plate current is caused by the following action which takes place within the tube. The signal in the primary circuit of the coupling coil passes by induction into the secondary coil and is applied across the grid and filament of the tube through the grid condenser. When the swing of the signal goes positive in one of its many alternations the positive charge is passed to the grid of the tube which, in turn, aids the attraction of electrons from the filament to the plate. A heavy current is thus caused to flow in the plate circuit. Now, when a negative swing of the signal reaches the grid it repels the stream of

THE HEAVY WAVY LINE MARKED "AUDIO PLATE CURRENT VARIATIONS" INDICATES THE RISE AND FALL OF THAT PART OF THE RECTIFIED DETECTOR SIGNAL WHICH ACTUALLY MAKES THE DIAPHRAGM IN THE HEADPHONES VIBRATE SO THAT SOUNDS CAN BE HEARD

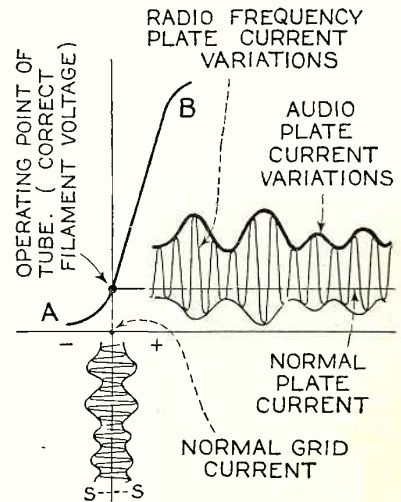
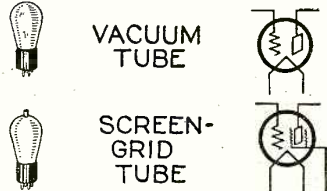
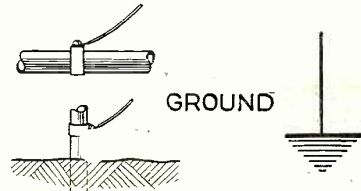
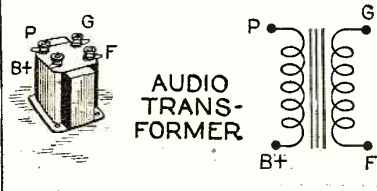
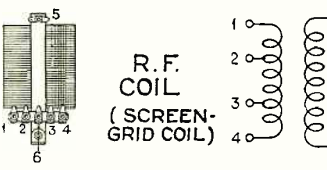

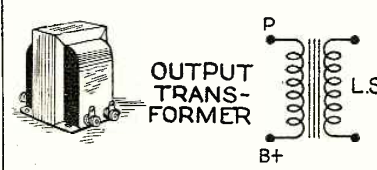
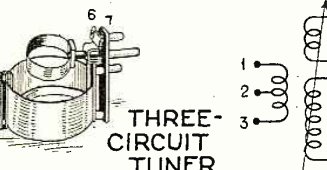

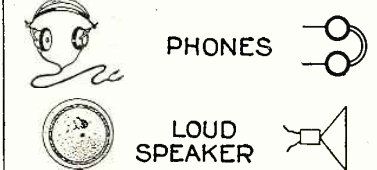



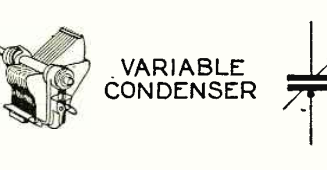

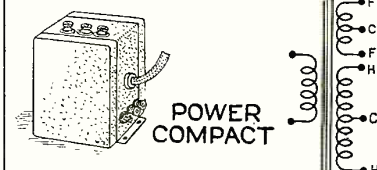
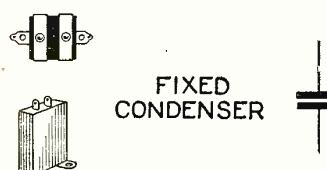
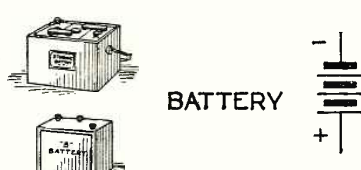
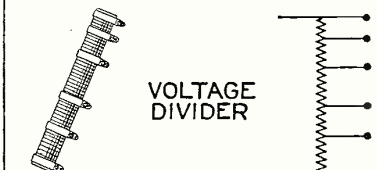
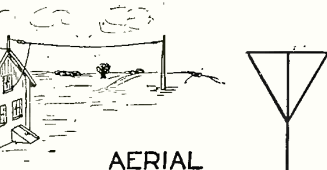
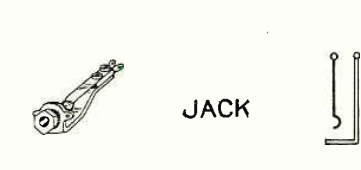
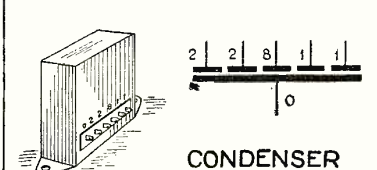

FIG. 5

 <p>VACUUM TUBE</p> <p>SCREEN-GRID TUBE</p>	 <p>GROUND</p>	 <p>AUDIO TRANSFORMER</p>
 <p>R.F. COIL (SCREEN-GRID COIL)</p>	 <p>FIXED RESISTOR</p>	 <p>OUTPUT TRANSFORMER</p>
 <p>THREE-CIRCUIT TUNER</p>	 <p>AMPERITE</p>	 <p>PHONES</p> <p>LOUD SPEAKER</p>
 <p>RADIO FREQUENCY CHOKE</p>	 <p>VARIABLE RESISTOR</p>	 <p>BH RECTIFIER TUBE</p>
 <p>VARIABLE CONDENSER</p>	 <p>FILAMENT SWITCH</p>	 <p>POWER COMPACT</p>
 <p>FIXED CONDENSER</p>	 <p>BATTERY</p>	 <p>VOLTAGE DIVIDER</p>
 <p>AERIAL</p>	 <p>JACK</p>	 <p>CONDENSER BLOCK</p>

IN RADIO, IT WOULD NOT BE WELL, FROM AN EFFICIENCY STANDPOINT, TO DRAW A PICTURE OF EACH PIECE OF APPARATUS AND ITS CONNECTING WIRES EVERY TIME IT WAS DESIRED TO DRAW A CIRCUIT DIAGRAM. TO SIMPLIFY THIS JOB,

REPRESENTATIONS CALLED SYMBOLS ARE ASSIGNED TO THE RADIO PARTS. FOR INSTANCE, IN THE UPPER LEFT-HAND CORNER IS SHOWN THE PICTURE OF A THREE- AND FOUR-ELEMENT TUBE. NEXT TO IT IS SHOWN THE SYMBOL

WHICH WOULD BE USED IN A CIRCUIT DIAGRAM TO REPRESENT EITHER OF THESE TUBES. THUS, WHEN YOU SEE THIS SYMBOL IN A DIAGRAM, YOU KNOW THAT IT IS INTENDED TO REPRESENT TO YOU A TUBE

electrons which normally flow to the plate and consequently little or no plate current flows. This positive flowing and negative stopping of the plate current produces vibrations or alternations of the received signal which cause varying movement of the diaphragm in the head phones, recognized as variations in sound.

Now also in the plate circuit of the detector tube is a radio-frequency variation of current which is in step with the oscillations of the signal developed in the secondary coil. If, then, a coil be included in the plate circuit and coupled to the secondary coil these plate current

charged against the detector unit alone but to the receiver as a whole. If we were to consider the construction of only a one-tube detector unit a smaller and less expensive outlay would be required. But, since a large five-tube receiver is to be eventually built around the detector, it is necessary to purchase these slightly more costly items.

First, obtain the parts as listed. Then, inspect each one carefully for loosened terminals, bolts or nuts which may have become loose through shipping.

Next start the drilling of the panel. It is necessary to drill the several holes in

of the panel in half at the 10½-inch line and draw a line across the width of the panel; do the same 3¾ inches from each end. Now, at the left-hand side make the marks for locating the shaft of the three circuit tuner coil and also the marks either side of it for the mounting holes. At the mid-panel make a mark 3 5/16 inches from the bottom. This mark locates the horizontal position of the shaft of the dial mechanism and the mounting holes for the condenser frames. The holes for the drum dial may be laid off on the panel, with the aid of the lay-out which is packed in the dial carton. Now draw a line 1¾ inches from the bottom edge of the panel. Then, on this line and 7½ inches in from each end make a mark at the two intersections. These marks denote the location of the filament switch and loud-speaker jack. Another line is drawn along the bottom of the panel ¼ inch up for the screws which hold the panel to the baseboard. For further information on the panel layout see the accompanying illustration, Fig. 8.

First mount the dial in place. Then insert two of the long flat-head machine screws in the holes provided for mounting the condenser; slip spacers or a small pile of washers over the screws to take up the space between the back of the panel and the frame of the condenser and then mount the condenser in place. When it is securely fastened the shaft of the condenser may be slipped into the center of the dial drum and fastened by the set-screws provided.

Next mount the volume control (R1) and then the three-circuit tuner coil (T1). When this has been completed, the panel may be fastened to the baseboard and then the socket (V1), r.f. choke (L1) and grid leak mount (R3) are mounted in position. The plate by-pass condenser (C3) and the grid condenser (C2) may be disregarded for the time being, as they are mounted in position later, being supported by the wiring. Bear in mind that the baseboard parts should not be put

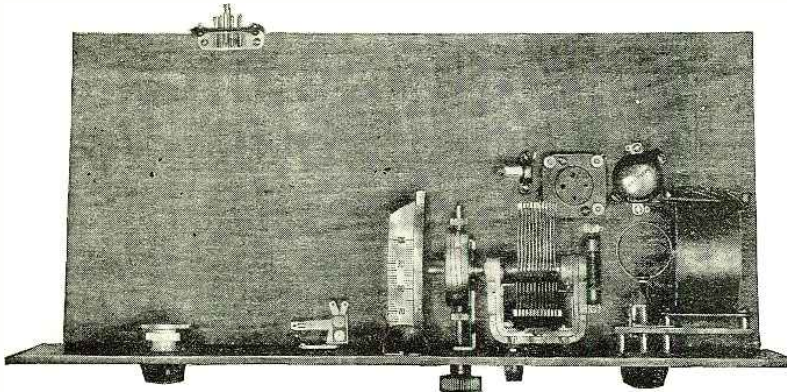

ONLY THE DETECTOR SECTION OF THE FIVE-TUBE RECEIVER IS SHOWN HERE IN PLACE ON THE BASEBOARD. FUTURE LESSONS SHOW HOW THE OTHER SECTIONS ARE ADDED

variations will strengthen or reinforce the original oscillations in the secondary coil and will naturally create a greater plate current variation in the plate circuit, which, in turn, are again used to reinforce the oscillation in the secondary coil, and so on. This is called regeneration, due to the fact that the plate current variations are fed back into the secondary circuit to re-generate or build up the original oscillation. The coil which is used for the purpose is commonly called the regeneration coil or "tickler coil." The fixed condenser, which has the property of readily passing currents of a radio-frequency nature through it, is shunted around the head phones because the latter would have the tendency to retard the regenerative action produced by the tickler coil, while the condenser, on the other hand, would provide an easy short path for the radio-frequency currents and keep them out of the head phones.

In other words, then, two distinct currents are found in the plate circuit of the detector tube. One, the audio-plate current variations, are the variations due to the changing amplitude of the oscillations, while the radio-frequency currents are produced or rather repeated through the tube after having been received by the tuning system from the transmitting station.

Constructing the Detector

From the first glance at the parts list for the detector unit it would seem that the cost of a single-tube receiver is unusually high, but it must be remembered that all of the apparatus cannot be

the panel in accordance with the panel layout, as shown in Fig. 8.

On the back of the panel draw a line with a sharp hard pencil or pointed nail; this line should run parallel with the long edges of the panel and should be located down the center, that is, 3½ inches from one of the edges. Then divide the length

HERE IS THE ACTUAL CIRCUIT DIAGRAM FOR THE DETECTOR SECTION OF THE RECEIVER. THE LETTERED PARTS SHOULD BE COMPARED FOR IDENTIFICATION WITH THE SIMILARLY LETTERED PARTS IN FIG. 7

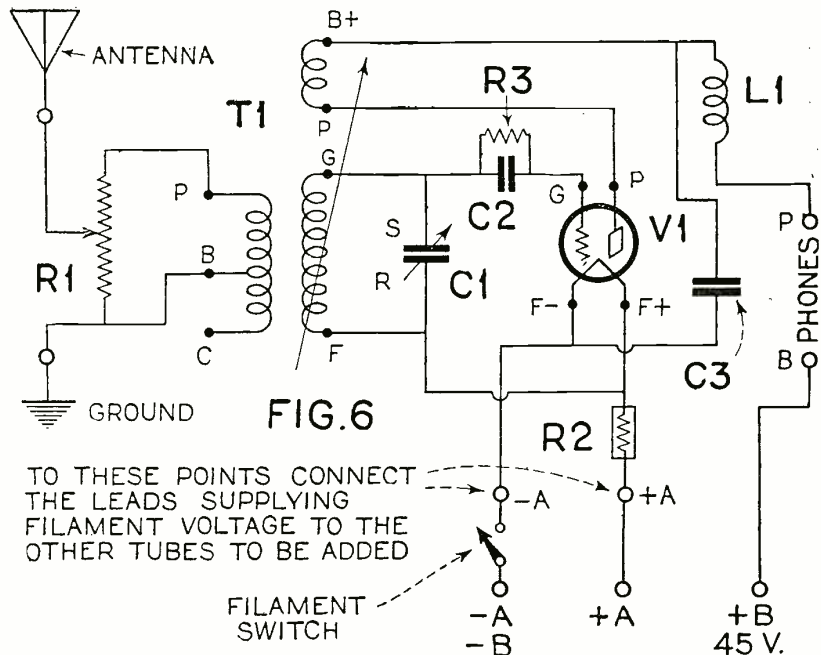

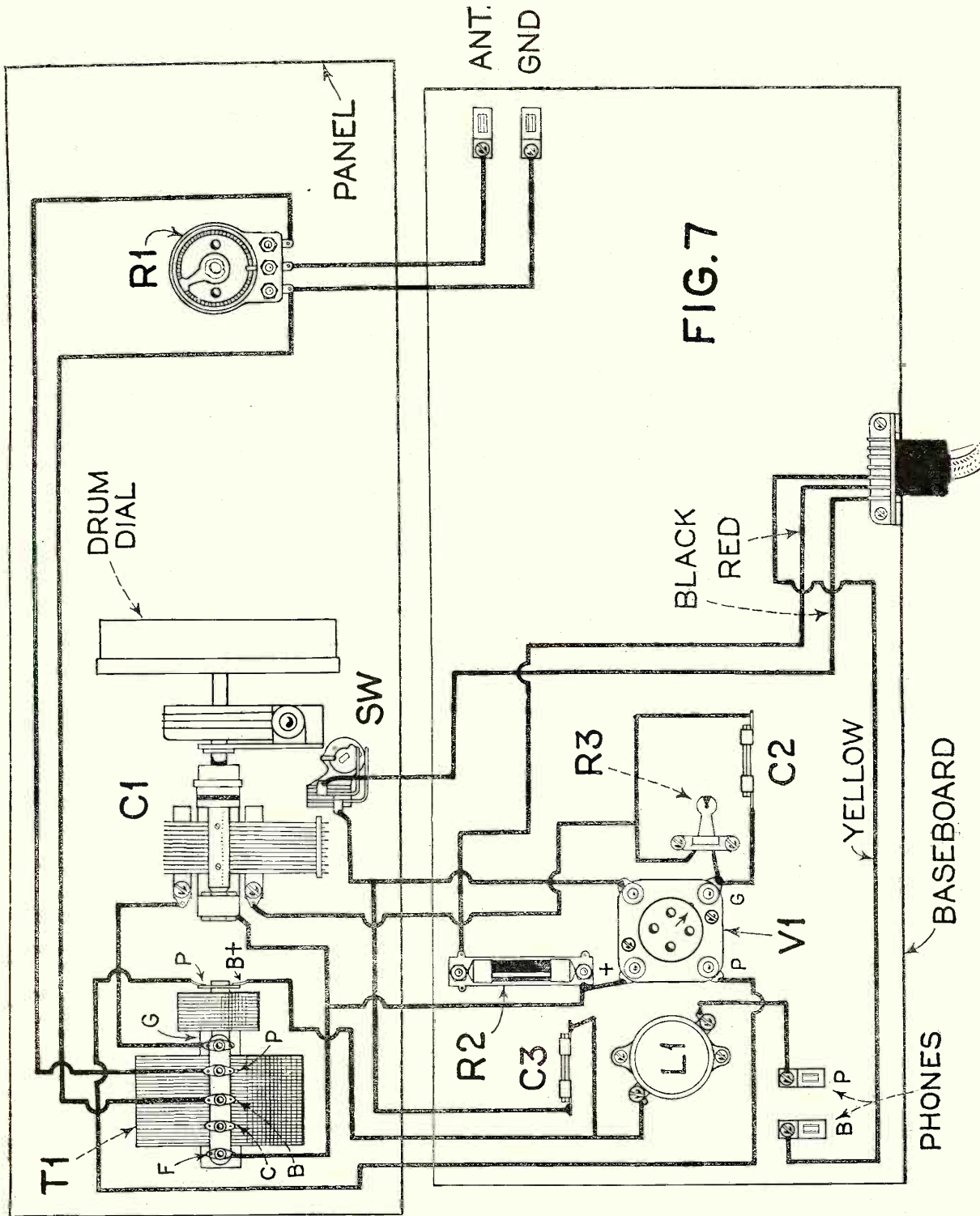
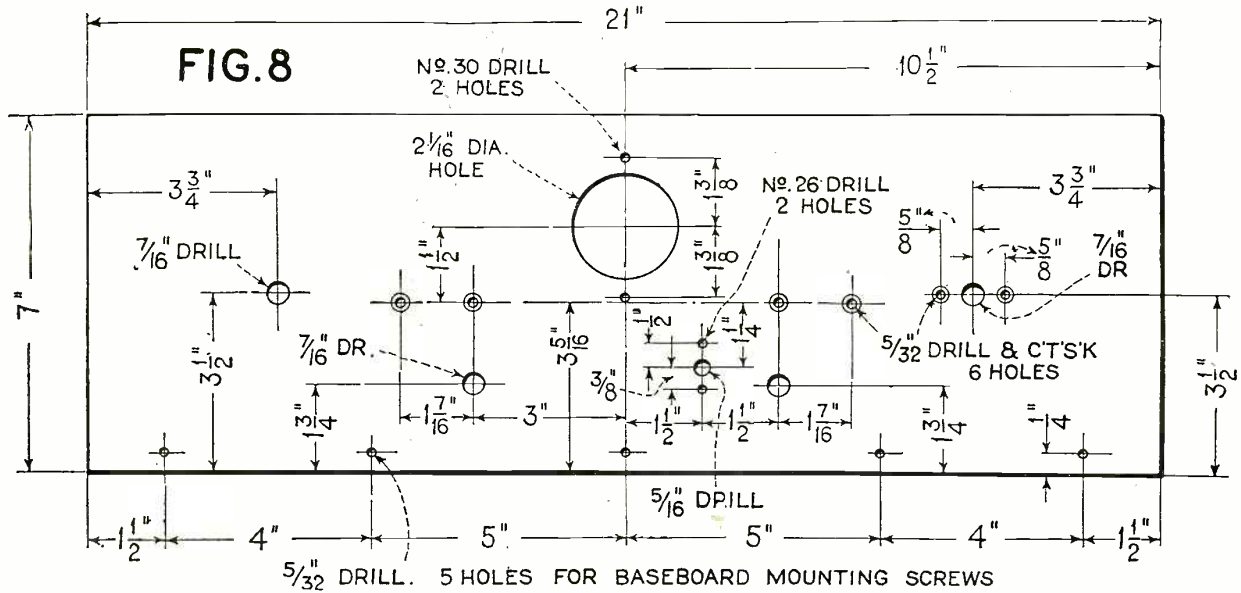

FIG. 7

THIS DRAWING IS CALLED A WIRING LAYOUT DIAGRAM AND SHOWS NOT ONLY THE RELATIVE POSITION OF EACH OF THE DETECTOR PARTS BUT ALSO THE VARIOUS WIRES WHICH CONNECT THEM, ONE TO THE OTHER. STUDY THE DIAGRAM AND COMPARE IT WITH THE CIRCUIT SHOWN IN FIG. 6, FOR A BETTER UNDERSTANDING OF THE CONSTRUCTION OF THE RECEIVER

in place until the panel apparatus is mounted. Then before the parts are finally screwed to the baseboard they should be moved around until the builder is absolutely satisfied that his layout approximates the one shown in the illustration accompanying. Take note that the amperite (R2) is placed so that one of its ends is very close to the F plus terminal of the detector socket. At the extreme right

end of the baseboard is mounted temporarily two Fahnestock clips to take the tips of the phone cord and two others are placed at the left edge of the baseboard directly to the rear of the volume control (R1). These latter two clips are for the temporary antenna-ground connections. Finally the connector cable receptacle is located, as shown, on the baseboard. Although it may be mounted in place, the



IN ORDER TO BUILD THE RECEIVER AS SHOWN, IT IS NECESSARY TO DRILL THE PANEL IN ACCORDANCE WITH THE DRILLING LAYOUT SHOWN ABOVE

loud speaker jack is not used in the detector circuit.

Wiring

Follow the wiring diagram, Fig. 6, and the wiring layout, Fig. 7, shown on page 246, as you read these instructions and as each wiring connection is completed mark it off the diagram with a colored pencil. This will give you an accurate check on your work and will help to avoid errors.

Connect a wire from the terminal marked P on the primary coil to one of the outside terminals on the volume control (R1). Connect a wire from the terminal marked B on the same coil to the other outside terminal on the volume control, and also to the ground clip. Connect the middle terminal of R1 to the antenna clip.

Connect a wire from the stationary section of the variable condenser (C1) to the free end of the grid condenser (C2). Connect this same wire also to the terminal on the coil, marked G. Connect a wire from the frame of the condenser, otherwise the rotor section of the variable condenser, to the terminal on the coil, marked F, and also to the F+ terminal of the socket. Connect the near end of the amperite mounting (R2) to the F+ terminal of the socket. Connect the other end of the amperite mounting (R2) to the red terminal of the cable receptacle. Connect the F- terminal of the socket to one side of the filament switch (SW) mounted on the panel and then connect the other side of the switch to the black terminal of the cable receptacle. Connect the P terminal of the socket to the P terminal on the tickler coil. Connect the tickler terminal B+ to one side of the r.f. choke coil (L1). Connect the other side of the choke coil (L1) to one of the Fahnestock clips provided for the phone tips. Connect the other phone clip to the yellow terminal of the cable receptacle. Take the .001 mfd., by-pass condenser (C3) and connect one side or terminal of it to that terminal of the r.f. choke coil

(L1) which connects to the B+ terminal of the tickler coil. Connect the other terminal of the by-pass condenser to the F- terminal of the socket. This wiring may be checked by referring to the wiring layout shown in Fig. 7.

DETECTOR PARTS LIST

- One Hammarlund midline condenser, .0005 mfd. (C1).
- One Hammarlund TCT23 coil (T1).
- One Hammarlund r.f. choke, No. 85 (L1).
- One Hammarlund drum dial, type SDB-1.
- One Electrad tonatrol, type A (R1).
- One Electrad by-pass condenser, .001 mfd. (C3).
- One Electrad grid condenser, .00025 mfd. (C2).
- One Durham grid leak, 5 megohms (R3).
- One socket.
- One Durham single resistor mount.
- One amperite, type 1A (R2).
- One Yaxley Midget Battery Switch No. 10.
- One Yaxley connector cable and plug, type 660.
- One panel, 7 inches by 21 inches (drilled).
- One box Corwico braidite.

Operation

Insert the 5 megohm grid leak (R3) in the clips of the grid leak mounting. Connect the antenna and ground to their respective clips. Connect the phones to their clips. Connect the batteries to their respective wires as show in Fig. 9. Note: Only the A battery and first 45-volt B battery are used with the detector unit. If, when the condenser plates are entirely closed or meshed with each other, the dial does not read 100, then loosen the dial setscrews and make this correction. Next turn on the filament switch, turn the regeneration control partly to the right, and then slowly rotate the dial knob. At first a station will manifest itself by a shrill whistle. After the whistle has been tuned in to its loudest point then slowly retard the regeneration control until the undistorted signal of the station is heard. At this point it may be found necessary to slightly retune the setting of the dial to bring in the station with maximum loudness. Other stations may be tuned in in like manner.

BELOW SHOWS THE BATTERY HOOK-UP FOR THE COMPLETE RECEIVER. FOR THE DETECTOR, ONLY THE "A" BATTERY AND JUST ONE 45-VOLT "B" BATTERY ARE USED

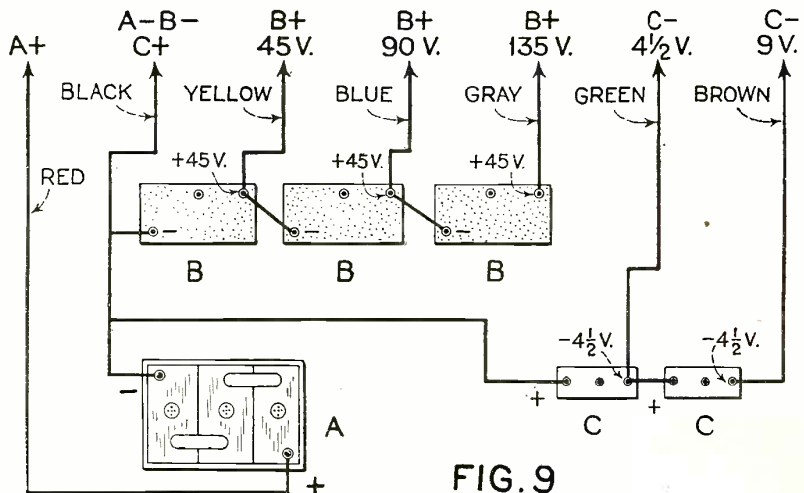

FIG. 9

How an International Daily Gets the

WORLD

TRANSCRIBING THE NEWS AFTER IT
HAS BEEN RECEIVED AT HIGH SPEED IN
CODE ON A DICTOPHONE CYLINDER



TODAY there are people who feel that their adventure is at an end; that it has passed them by. To them is this story written. These are the radio adventurers, the thousands of those busy people who used to go roaming around the world by way of their radio sets in the evening after a busy day at work. Most of them limited this roaming to the North American continent.

But just to show them they are wrong, let us unfold a tale of present-day radio adventure which has been every bit as stimulating as the early broadcast days and which can be duplicated by any experimentally inclined radio reader today.

Newspaper life presents as romantic an angle to young men as the stage does to young women. The rapidly shifting scenes of daily events, the rush to cover these; the speeding of the stories to the office, and after going through the "machinery" of copy desks, make-up, presses, etc., the appearance of the paper on the street. To be true, a few hours afterwards the news is usually forgotten, but the press is already getting the next day's batch of copy.

Gathering the news is interesting, but when the lot of working at the getting of this news to the office—in other words,

the establishment of a system of communication—came the writer's way, he discovered, much to his pleasure, that this was just as thrilling.

The *Monitor* is an international daily newspaper and as such it is almost totally dependent upon distant sources for its news. Thus it has a leased wire which runs from Boston to New York, thence to Washington, and finally to Chicago, besides using the regular Western Union and Postal services. This takes care of the American continent.

World-Wide Coverage

But "international" means world-wide and thus rafts of news come in from every capital in the world. Cables and radio through the regular companies are used daily, but we found we needed more than that. We needed the high-speed service possible when one controls their own communication lines.

Before seeking to conquer the world (by radio) we decided to test out a single link in the chain and therefore chose the England-to-America circuit for our experimental work. The majority of our European news is routed through our London bureau, which in turn sends it by radio from the British station at Rugby.

This is picked up in Halifax, where it is received on a tape, and then decoded and sent via land line telegraph to headquarters in Boston.

By taking this news directly from England, we could save the time consumed in the extra handling at Halifax. Now the problem was to do it.

First we had to consider the source of our receiving station. It would not do for us to receive messages if they had to be re-sent or carried by messenger any distance. This would offset the time we hoped to save. This, in turn, meant that the receiving had to be done right at our regular location, about one and a half miles from the shopping district, in a location that is pretty nearly all commercial now.

A row of apartment houses of wooden construction flank the street where our main office is located. Several of these are in use as extra offices, so to get away from the effect which a steel building would have on reception we started in with these. We set up a short-wave set with batteries and moved it from building to building, and finally came to one that gave us less interference than the others. Various electrical machinery in and near these buildings cause plenty of problems—or did.

NEWS *by* RADIO

By Volney D. Hurd, *Radio Editor*, Christian Science Monitor

Operator Leads Flea's Life

During the summer months when this work was started in an effort to find the best channel, we found that our messages were coming over on about eleven wavelengths. The operator had to be as flexible as a flea. We took on a real "ham," George Hinckley, 1GA, who showed an enthusiastic devotion to the work, was experimentally inclined and therefore fitted for the kind of work we were doing.

Well, the wavelengths ranged from 17 to 20,000 meters, if you like variety. This meant a good long-wave receiver as well as a short-wave set. We started on short waves at first and rigged up a pretty fair job. Shielded-grid tubes were used and little was known about them at the time. We could only see trouble ahead, as we had been warned of the difficulties of stability at short waves.

We discarded much good advice and built a set much like a broadcast receiver, and this worked out with no effort as far as stabilizing it was concerned. Easy! "And long waves are much more stable," we had always been educated to believe, mostly by "super-het" enthusiasts.

So we gaily built a long-wave receiver after the short-wave pattern. Instability was the only thing it seemed to know. We generously told each other what we thought of all the people who had kidded us about long waves, and then went ahead.

The problem was licked by falling back upon the old idea of tuned and untuned stages. We had wanted a stage of r.f. plus a regenerative detector. What we finally did was to place an untuned stage between the r.f. stage and the detector. It worked beautifully. The set was perfectly stable. Plug-in honeycomb coils were used and we could get up and down the various bands with ease.

Finally we settled down for some copying. Tests were made at all hours and we found that by changing the wavelengths from time to time we could get pretty good reception from England. We knew the news schedules and settled down for "a listen." It came. A series of high-pitched sounds in dots and dashes coming so fast that it sounded like a peanut roaster. We had overlooked the fact that England was sending the stuff with an automatic transmitter at the rate of 100 words per minute. "What to do?"

Tape Recorders? No!

Tape recorders are nice, but tricky. They demand extra tuning and also tuning

of the audio amplifier usually to make them "perk" properly. "What do do?"

We finally hit upon an idea that proved to be the solution. In the cellar were several dictophones that had been discarded. We got one of these upstairs, cleaned it off, tied the earphones onto the speaking tubes connection and started up. We speeded the record up as fast as the thing would go, and on went the message. Then we took it off, slowed down the dictophone, put it on the reproducing point and listened in. There was our code coming in at about twenty words a minute as nicely as you please at a much lower pitch.

This bore out a theory we had had regarding tapes. If you want a man to get a message from you, you don't want to

translate it into French and then retranslate it into English in order for him to hear it. It seemed that the tape was a slow line in the regular practice. Operators spend years developing their powers of hearing so that they can read code accurately. Then to train such men to read tape is like teaching them touch reading after they have used their eyes on print all their lives.

Another thing is that in the dictophone, the static crashes are reproduced not nearly as bad as when the headphones are used directly, nor as bad as trying to read tape with static discharges on it. We have proved this in turning out more accurate messages than with a tape recording station, on mornings when the interference has been bad. Thus the dictophone idea seems to have much merit.

Two problems still faced us; weak signals and man-made interference. To get a good kick out of the short-wave receiver seemed to be a problem. We

AN INTERIOR VIEW OF THE NATIONAL SHORT-WAVE RECEIVER, WITH THE REMOVABLE COILS FOR DIFFERENT WAVE BANDS READILY ACCESSIBLE



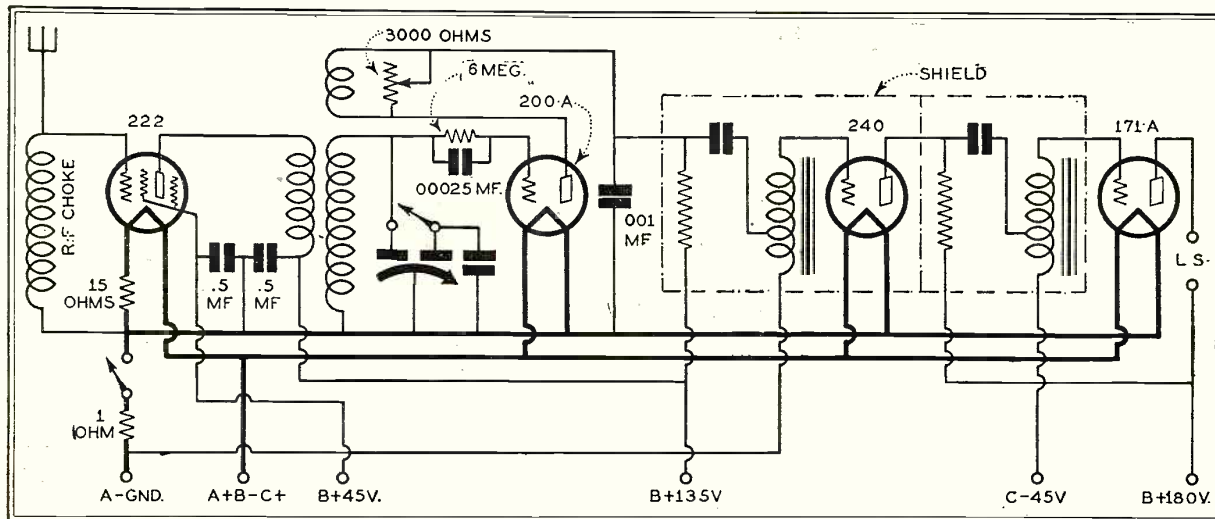

CIRCUIT DIAGRAM OF THE NATIONAL SCREEN-GRID SHORT-WAVE RECEIVER WHICH EMBODIES TWO STAGES OF AUDIO-FREQUENCY AMPLIFICATION

wanted plenty of "sock" to operate the dictaphone, yet the quality must be pretty good too. This was solved in a great part when James Millen sent us over the new National short-wave job.

The Part Audio Plays

This has a two-stage audio amplifier which has been developed to give an awful wallop and yet maintain good quality. Feeding this into the dictaphone did a real job for us. It certainly has a lot of kick for a short-wave set. With its single dial it made it easy to land the station we wanted. Incidentally, we liked to listen to broadcast between times and had little room for an extra receiver for this purpose. This National job has plug-in coils that cover the broadcast band and produces a tremendous kick in the audio end, yet with good quality . . . thus we can have good music between times. In fact, this set

would seem to indicate that the old idea of lots of audio has much merit. We could play "locals" with just a regenerative detector and an untuned shield grid input with only a two-foot piece of wire for an antenna, and this in the daytime. Surely a lot of this kick was in the audio end.

But we are wandering. We still had the long-wave problem, and finally Hinchley solved this by an additional tuning coil in the antenna circuit which pepped the long-wave set right up and also made it very sharp in tuning, a far too uncommon quality in all the long-wave receivers we have ever used before.

Now we were getting our stuff in good style. And here is where the oldtime adventurer is missing a lot. By all means get yourself a good short-wave receiver and a good long-wave one too. This latter type has been forgotten, but there are

BELOW—THE SHORT-WAVE CHASSIS REMOVED FROM ITS CABINET, SHOWING NOT ONLY THE TUBES IN PLACE, BUT SHOWING ALSO THE TWO-SECTION TUNING CONDENSER AND THE SMALL SWITCH WHICH CONNECTS THE TWO SECTIONS

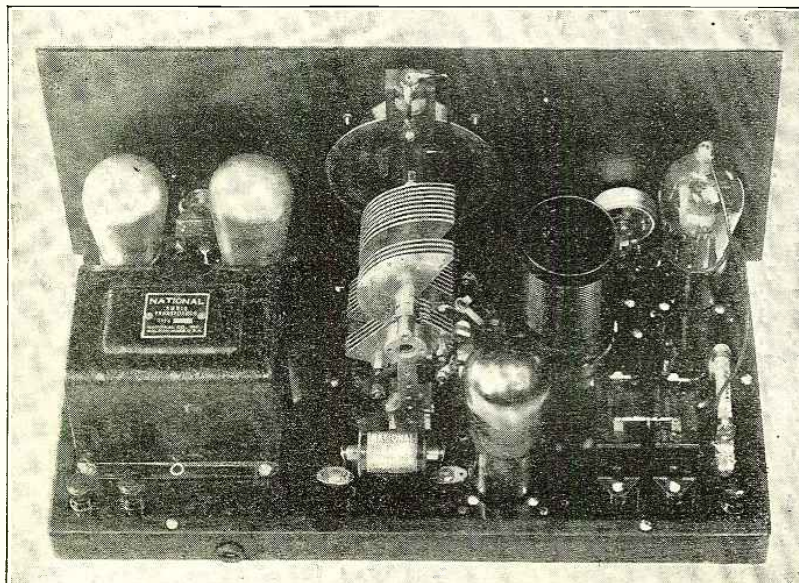

worlds of interesting things coming in on these waves. You can get news dispatches being sent around the world, besides any number of official press services sent out by foreign countries for their colonies and ships at sea.

The British Official Press, GBR, 18,940 meters, which goes on the air at 7:00 A. M. and 3:00 P. M., Eastern Standard Time, is particularly good; its stuff is sent very slowly, so an inexperienced operator really has no trouble in copying it quite easily. This provides a splendid code practice for beginners.

This same press matter also comes over at the same hours between 17 and 18 meters. At 7:00 P. M. in the evening this official press comes over at 35 meters, a convenient wave and time for most experimenters. It also comes over at long-waves at this time.

Of course, much of the most interesting stuff comes high speed and the natural question is, what is the experimenter going to do for a dictaphone?

Shopping for Dictaphones

Well, the ones we used are marked up on our books at about \$25.00 each. Thousands of these, sold ten or more years ago, are probably no longer used and yet are satisfactory for receiving code perfectly well. Shopping around a bit, there is no doubt that they could be inexpensively picked up. Records may be shaved for a few cents and used as many as 75 times.

Of course, taking high-speed code regularly means continuous reception and we couldn't change records without losing a lot. So we got another dictaphone and set this alongside, as well as a third or transcribing machine for reading off the records. Finally, we got hold of a record shaver so we could have a fresh flock of records each day.

Now just when one record is about full, we throw on the second machine, which records the last few turns of the nearly finished record's message. The first record is then put on the transcribing machine and a blank takes its place on the first machine, which is then ready when machine number two has nearly finished its record.

With the receivers we have, the operator can set the machines going and transcribe at the same time the high-speed stuff is being recorded, merely stopping for a few seconds at six to eight-minute intervals to change machines and records. It is a smoothly working proposition.

A double dictaphone tube was made and the reception is taken on a single loud speaker unit instead of phones. Thus, feeding both machines, there is no receiving set adjustment of any sort necessary when reception is shifted from one machine to another. In order to monitor this incoming copy a pair of ear plugs such as are used on a stethoscope was fastened to a rubber tube which was in turn fastened to the common listening lead by a metal tube. Incidentally, this feature leads to an interesting discovery, and that is that by using these ear pieces and a speaker unit outside, noises are not heard by the operator anywhere near as much as when he is wearing headphones; furthermore, the weight is almost nil.

Suppressing Interference

Interference was the last problem. It presented itself early when the dictaphone, electrically operated and of course set up near the receivers, drowned out all signals. A small "antenna plug-in" type of filterette was applied to these machines and stopped that. Then a couple of motors in the basements had big filters applied to them.

Finally we came to the rotary converter. We are in a d.c. district and yet wanted to avoid batteries. We all have heard the story that it is impossible to obtain short-wave reception using an eliminator. Well, using the baby National model, the Velvet, I believe they call it, we operated the short-wave set perfectly with an a.c. supply, and even used an "A" eliminator at times.

But the converter itself offered real

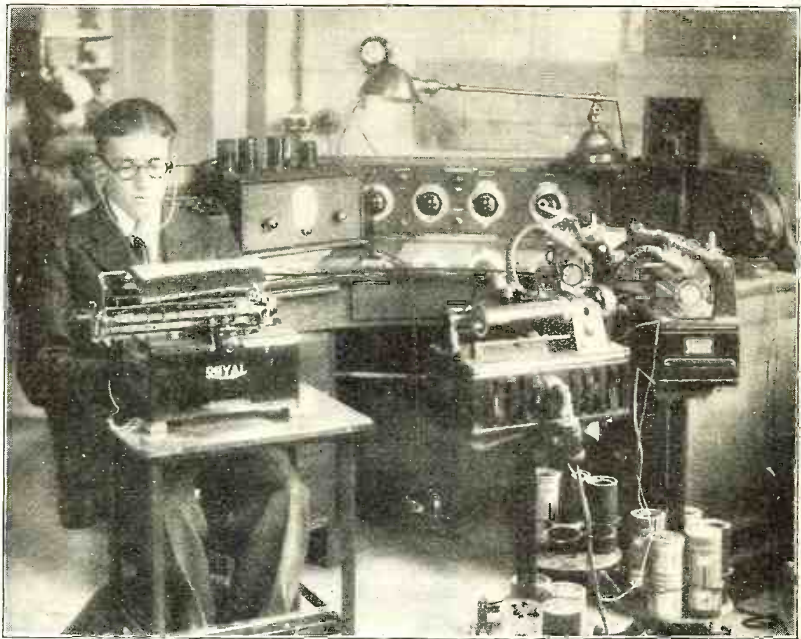

ABOVE—THIS MIGHT BE CALLED AN "ENSEMBLE" VIEW OF THE NEWS-GATHERING FACILITIES, WITH GEORGE HINCHELEY, THE RADIO OPERATOR, LISTENING TO THE SLOWED-DOWN CODE FROM THE DICTOGRAPH CYLINDER

problems. It had come equipped with a filter, but this was on the a.c. side. The manufacturers neglected to think of the other side, leading to the d.c. lines, which were running all around us like a cage. We put a large sized filterette on the d.c. side of the generator and our interference troubles were over.

The result of all this is that our radio editorial force is now studying code after seeing all the fun that 1GA gets out of copying interesting items from all parts of the world. This, in turn, means that some more short-wave and long-wave sets are going to be built, for why have code if you cannot use it in the evenings at home?

Adventure? Come on, you armchair adventurers! Don't toy with stations in the United States. Code is quickly learned. Get a good receiver or two, and you can know any of the world's events before even your local newspaper.

Both the receivers we used are easy to make and operate. Too easy! We would like to impress you with what a difficult thing it all is and how intricate is the machinery needed, but the fact is that they can be built by anyone who can build a broadcast receiver. So come on and join us.

Those of you who listened in on the National Broadcast Company's rebroadcast of the British services of Thanksgiving, on the morning of July 7, got quite a kick out of hearing a voice from London and then one from Australia. Why not get that kick first-hand, and multiply it, by learning to understand the dot and dash?

BELOW IS THE CIRCUIT DIAGRAM OF THE LONG-WAVE RECEIVER WHICH, AFTER EXPERIMENTATION WITH OTHER CIRCUITS, MET ALL REQUIREMENTS

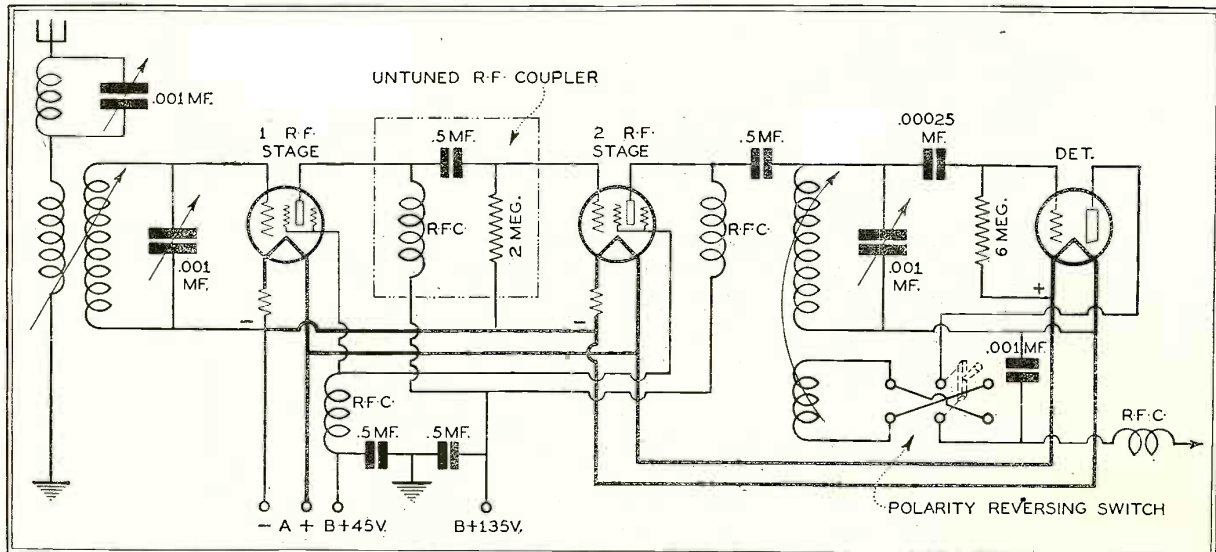

TWO PRACTICAL INSTRUMENTS

for the EXPERIMENTER'S Laboratory

Building Instructions for R. F. Oscillator and Handy Two-Stage Audio Channel

By the Laboratory Staff

The Oscillator

THE work of repairing defective and otherwise inoperative receivers has steadily grown and with the passing of time has become a highly specialized work requiring the attention of men who have made a study of the problems to be met.

Just as the garage man must outfit himself with the various tools necessary to the completion of a good job, so too must the radio serviceman equip himself with not only tools with which to do the actual repair work but also the necessary instruments wherewith he apprises himself of the particular trouble with which a receiver or other piece of radio apparatus is ailing.

Test meters and test batteries may be considered to be the natural equipment of any good repairman and are practically his most important tools when he goes out on a job. Receivers which are so balky as to frustrate any effort at repair in the home naturally come to the serviceman's laboratory and it is here, because his problems are more complex, that he must have on hand some real worth-while pieces of test equipment.

Notwithstanding the fact that perhaps in most every section of the country a score or more of broadcasting stations can be tuned in at most any time of the day, still there is a wide demand in the repair laboratory for a unit that will in itself be a miniature broadcasting station. With such an instrument any number of simple tests may be simulated.

The article herewith describes such a unit. It comprises an oscillator of the radio-frequency type, and uses a 210 tube for the generator of radio frequencies. The circuit employed (Fig. 1) is the Colpitts, known to the short-wave fraternity as of great excellence. A meter located in the grid circuit gives a visual indication of resonance between the circuit of the oscillator and the circuit under test when the two are tuned to the same frequency.

By means of plug-in coils a range of wavelengths is covered, the minimum being about 15 meters and the maximum being about 800 meters.

Coils

The inductors, as manufactured, come in four sizes and cover wave bands ranging from 16 meters to 155 meters. Additional coils may be wound on 2-inch tubing and fitted with plug pins to fit the coil base. The fifth coil should be wound with 44 turns of No. 16 enameled wire,

tapped at the middle turn. This coil covers from 107 to 204 meters. Coil No. 6 consists of 74 turns of No. 24 d.c.c. wire and covers from 170 to 337 meters. Coil No. 7 is wound with 125 turns of No. 30 d.c.c. wire and covers from 313 to 577 meters.

If the experimenter so desires, he may shunt additional fixed capacities across the tuning condensers to obtain a higher range of wavelengths, although in tuning to these higher wavelengths he may find it necessary to make adjustments in the "B" voltage applied to the plate of the oscillator tube so as to maintain it in an oscillating condition.

The use of the National micro-vernier dial permits exceedingly accurate readings, even so fine as one-tenth of a degree. This is especially helpful, allowing accurate readings where the radio-frequency resistance of a coil is being measured or where it is necessary to obtain carefully matched sets of coils.

Calibration

This is an important consideration, but is not so difficult as one would at first expect. If a regenerative detector circuit is not available one can be hurriedly thrown together on a baseboard and then tuned to the wavelength of a station of known, reliable frequency. When this has been done, the oscillator may be loosely coupled to the detector circuit by merely being placed near it. Then, with the oscillator turned on and the dial rotated, a point will be reached where it will be observed that the grid meter needle takes a decided drop. Loosen the coupling more and then repeat the operation until the movement of the meter needle is confined to just a small dip. At this point the oscillator is in resonance with the frequency adjustment of the station to which the detector circuit is tuned. The procedure may be repeated for a number of stations both in the broadcast and short-wave bands. By noting the dial readings of the oscillator, a chart and curve may be prepared to indicate intermediate frequencies not actually spotted in the calibration.

Uses of the Oscillator

This instrument is useful in many ways and is particularly suitable for use in the laboratory of an experimenter or serviceman. It may be used to determine the frequency range of experimental coils; it may be used to measure the gain-percentage of a radio-frequency amplifier; as

a heterodyne wavemeter; as a radio-frequency generator or driver; it may be used to measure the frequency range of radio-frequency amplifiers and to determine the frequency range of experimental coil-condenser combinations.

Because of the fact that it is powered from the house light lines, there is available for other use a d.c. voltage point ranging from zero volts upwards to some 180 or 200 volts. The value of such a versatile instrument in the experimenter's laboratory cannot be overestimated. Those who are so inclined will not find it difficult to assemble a simple audio oscillator within the confines of the oscillator so that they can have at their disposal a modulated radio-frequency signal.

PARTS LIST

- L1, L2—Aero short-wave coils, Nos. INT-101, 102, 103, 104 and home-made as explained.
- L3—Silver-Marshall unichoke, No. 331.
- C1, C2—Hammarlund two-gang condenser, .0001 mfd. (each section).
- C3—Sangamo or other mica insulated fixed condenser. .006 mfd.
- C4—One B block, 12 or 14 mfd.
- R1—Electrad truvolt resistor, 5,000 ohms, type B50.
- R2—Electrad truvolt resistor, 15,000 ohms, type D150.
- T1—Silver-Marshall power transformer, type 327.
- One Yaxley double-pole, single-throw jack switch, No. 40.
- One Electrad truvolt voltage divider, VD.
- One National precision velvet vernier dial, type N.
- One Weston milliammeter, type 301, 0 to 5 mils.
- Two Silver-Marshall sockets, type 511.
- Two boxes Corwico stranded braidite.
- One CeCo power tube, type 110.
- One CeCo half-wave rectifier tube, type R81.

The Audio Amplifier

THE man who is constantly experimenting with the various tuning circuits which are offered for his consideration usually never bothers to build into the receiver a complete audio channel because of the time and labor involved in doing a job which might be only of a temporary nature. More often than not he is content to listen in the plate circuit of the detector tube with a pair of phones, but of course this method of test does not allow him to compare the relative merits of the circuit with another

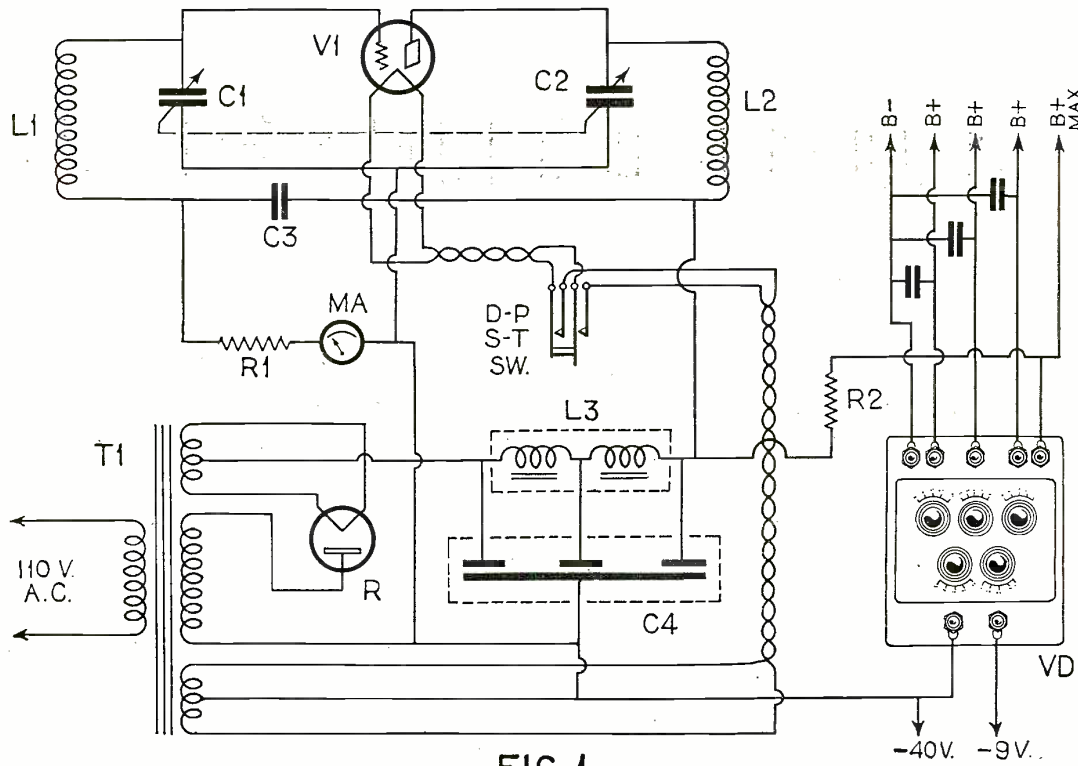

FIG. 1

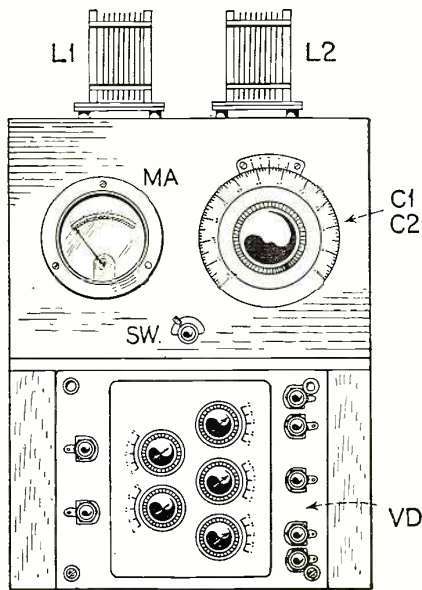

FIG. 2

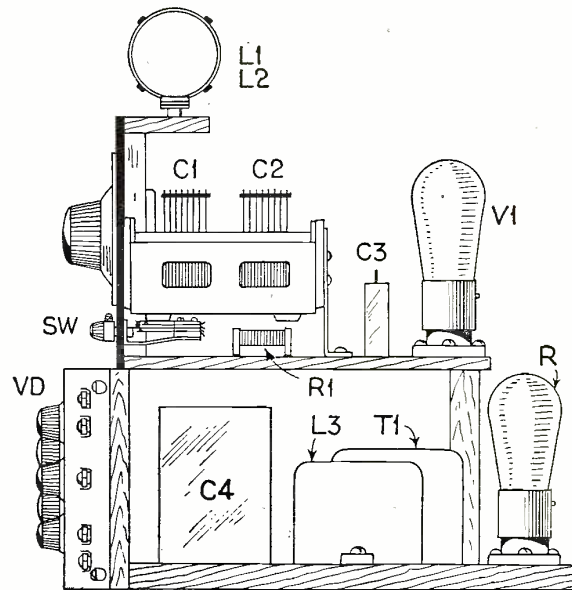
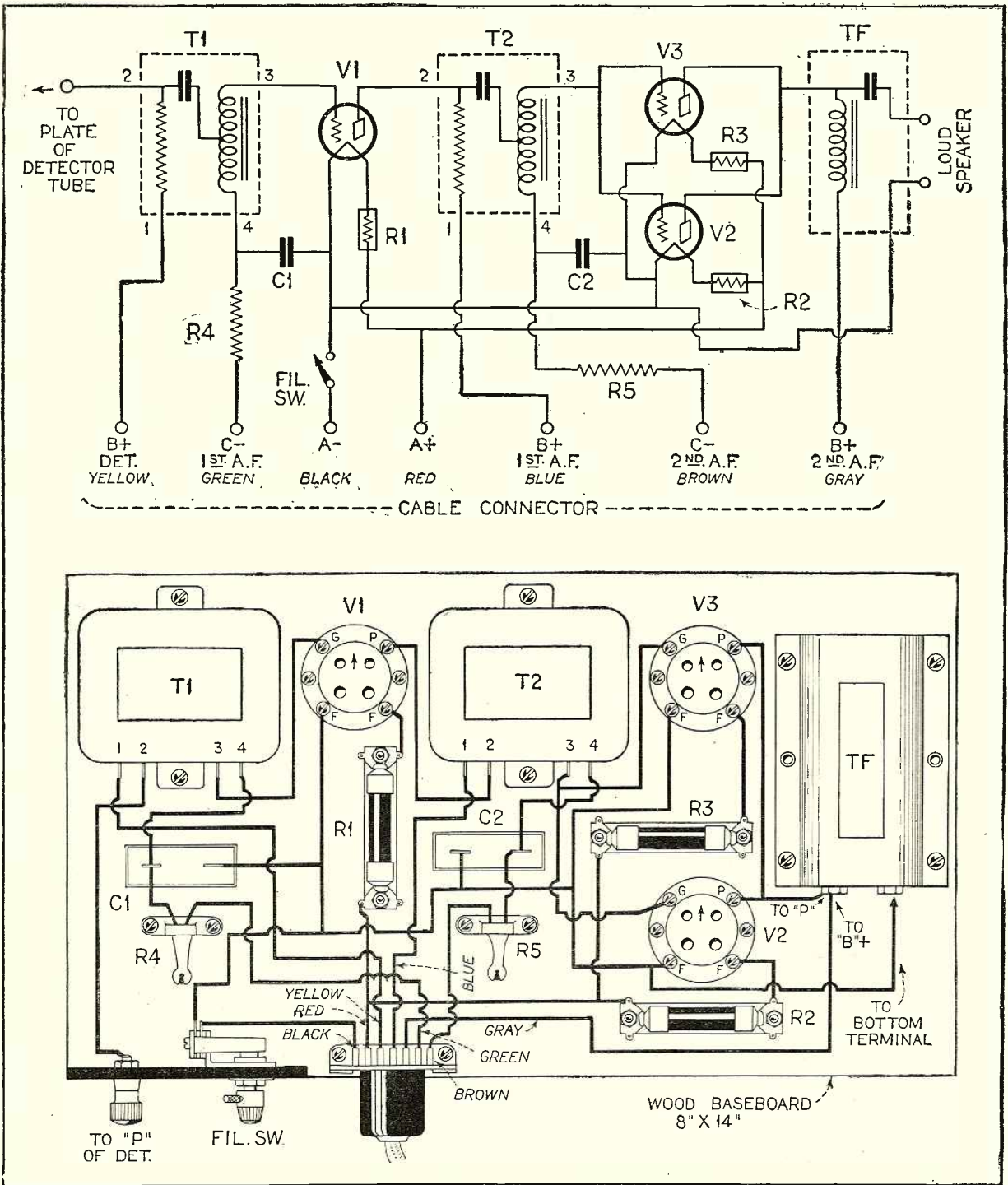

FIG. 3

HEREWITH ARE GIVEN THE CIRCUIT DIAGRAM AND CONSTRUCTIONAL DETAILS FOR BUILDING THE LABORATORY OSCILLATOR-POWER SUPPLY DEVICE. FIG. 1 SHOWS THE CIRCUIT DIAGRAM,

FIG. 2 THE FRONT VIEW, AND FIG. 3 THE SIDE VIEW. NOTE THAT THE OSCILLATOR IS HOUSED IN THE UPPER SHELF, WHILE THE POWER SUPPLY APPARATUS IS LOCATED BELOW.



FOR THE SERVICEMAN OR EXPERIMENTER WHO IS CALLED UPON FREQUENTLY TO CURE AILING RECEIVERS, IT IS OF INESTIMABLE BENEFIT TO BE ABLE TO QUICKLY AND EASILY CONNECT FROM THE DETECTOR PLATE OF THE SUSPECTED RECEIVER TO SOME AMPLIFIER WHICH IS KNOWN TO BE IN SATISFACTORY OPERATING CONDITION. THE CIRCUIT DIAGRAM AND CIRCUIT WIRING LAYOUT SHOWN ABOVE ILLUSTRATE QUITE CLEARLY THE CONSTRUCTION AND HOOK-UP OF SUCH AN AUDIO AMPLIFIER

which was operating a loud speaker. For this reason it is usually beneficial

for the laboratory man to have on hand an audio amplifying channel which can be attached to any particular tuner section under test. It can also be used to reproduce phonograph music by the attachment of a suitable magnetic pick-up to the input terminals of the first-stage amplifier.

The amplifier described here is a two-stage affair using audio transformers. The first stage is a straight audio transformer stage, while the second consists of a pair of power amplifier tubes arranged with their elements in parallel. Such an arrangement provides greater handling

capacity and there is not the danger that the power stage will overload on exceptionally strong signals as is likely to be the case with only one power tube.

A speaker coupling unit of the speaker-filter type is located in the circuit between the plate of the power amplifier tube and the speaker itself. This allows the speaker armature to move freely in conformity with the variations of the signal current and releases it from a steady continual drag which would be imposed if the d.c. from the "B" battery were applied directly.

(Continued on page 271)

The Radio Forum

*A Meeting Place for Experimenter, Serviceman
and Short-Wave Enthusiast*

The Experimenter

A Super-Sensitive Circuit

A very fine co-operative spirit has been displayed by Master Sergeant M. K. Barber, of Fort Ethan Allen, Vt., who has designed a detector circuit incorporating the screen grid tube and a "sensitizing coil." But let Mr. Barber tell his own story. "Recently I conceived and tested a circuit which I believe to be entirely new in principle. Whether it is new or not, I am sure that it has not been tried by many experimenters or its merits would have been made public before this. The circuit I really believe to be too good to enjoy alone. For several months I have been using the 22 type screen-grid tube connected as a space charge detector in the first detector stage of a super-heterodyne receiver. This receiver contains several novel circuit arrangements other than the one to be described here. It was originally a Silver-Marshall Laboratory receiver using the SM-440-SG intermediate amplifier tuned to 112 k.c., the first detector stage being regenerative.

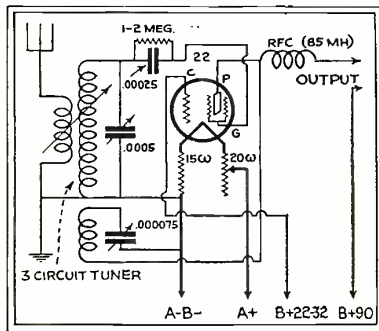

FIG. 1

The regeneration feature consists of a fixed tickler winding and a midget variable condenser in series with the tickler shunting the output circuit of the tube.

"I have found the space charge detector to be both stable and economical in use, and quite a bit more sensitive than any of the 200A or 201A types of tubes which I have tried. It is even an excellent detector when used in a short-wave receiver. Still it was nothing to get excited about. It occurred to me that if I could introduce a part of the incoming signal voltage directly to the space charge grid (inner grid), that the sensitivity of the circuit would be much increased. Upon trying it I found this to be true, and I

hope I may be pardoned for getting a bit excited.

"For the benefit of those not familiar with the circuit of a space charge detector, Fig. 1 is of such a circuit. The plate and inner grid voltages are not at all critical, though I obtained best results with 90 volts on the plate and from 27 to 32 volts applied directly on the inner grid, neither choke coil nor by-pass condenser being used. In the SM-Lab. receiver referred to above, the grid condenser is of the usual .00025 mf. capacity and shunted by a 1 megohm grid leak, the grid return being to A—, while in the short wave receiver the grid condenser was .0001 mf. and the grid leak 3.5 megohms, the latter being connected across the grid and plus filament terminals of the socket. These connections were used simply because the circuits were so wired and each worked so well that no effort was made to determine which might be the best in either case. I mention these facts merely to show how easy it is to adapt the space charge detector to any receiver. As the screen grid of the 22 type tube is connected to the usual grid prong on the tube base, and as this grid is used for the control grid in the space charge detector circuit, it is only necessary to allow for the lower filament voltage (3.3 volts), if the receiver is wired for the 6 volt "A" supply unit, and to provide an additional lead from the

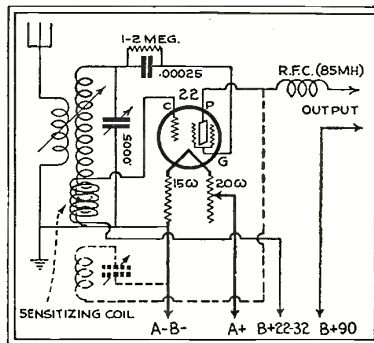

FIG. 2

inner grid terminal cap on the top of the tube, to a suitable positive voltage, which may conveniently be a tap at 22½ volts plus on the "B" battery. Thus the only real change in the receiver is to disconnect the minus "A" lead at the tube socket and insert (in series), a small wire-wound fixed resistor of 15 ohms. This

change is so simple and easily made that everyone should utilize the advantages offered by this really efficient detector tube.

"Now let me return to the main subject of my experiments. Previous experiments, according to my data, had shown the extreme sensitiveness of the 22 type tube when the feeble signal voltages were applied to the inner grid, and this knowledge was the cause of a desire to combine this sensitiveness with the amplifying power of the tube, which could best be obtained by using the inner grid to counteract the space charge. My idea was to couple the inner grid to the input circuit of the space charge detector circuit by means of a coil in series with the inner grid terminal cap and the space charge battery voltage. This extra coil is shown in Fig. 2 and must be poled so that the voltage applied to the inner grid will be in phase with that voltage applied to the screen grid. This is accomplished with the connections as in Fig. 3, where all windings are wound in the same direction, which may be, of course, clockwise or anti-clockwise.

"First, I wound a coil of 45 turns of No. 24 d.s.c wire, jumble fashion around a jelly glass, afterwards slipping it off the glass and tying it into the shape of a ring about 2½" inside diameter. This was large enough to slip loosely over the input coil of the first detector stage, the input coil being a SM No. 112A coil with a SM No. 515 coil socket. The result was more than gratifying. I found that the regeneration condenser could be set at zero, the filament rheostat turned nearly off (a total of more than 30 ohms), and still plenty of volume from the loud speaker. Removing the coil required turning up the regeneration condenser to about 50 and reducing the filament re-

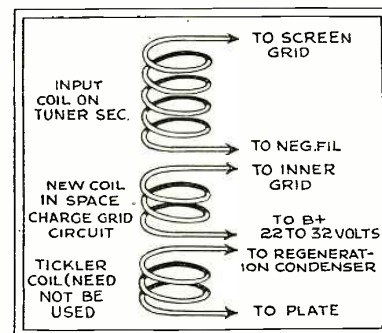

FIG. 3

sistance to about 20 ohms in order to obtain the same volume from the speaker. But even this did not prove that the reaction was anything other than feedback from the plate coil to the inner grid through the new coil, because even though the regeneration condenser was set at zero there would still be a little feedback due to the minimum capacity of the condenser being greater than zero capacity, also a certain small capacity coupling between the tickler coil and the new coil. So the next experiment was with the tickler entirely disconnected from the circuit, and eureka, the same results as before, *i. e.*, with the coil in place, any volume up to the point of making the tube oscillate could be obtained by simply advancing the filament rheostat, while with the new coil removed the set was as dead as the proverbial doornail. It apparently made no difference whether the new coil was coupled to the filament end of the input coil, to its mid-section, or held up above the grid end. The only requirement was that there be some electro-magnetic coupling between the two coils and that the polarity be that shown in Fig. 3. Neither did the addition of this new coil alter the setting of the input circuit tuning condenser for any given station more than one division on the dial. And last, but not least, the set was as sensitive when tuned to around 500 meters without any readjustment of the filament rheostat.

"I concluded that it would be better to use a few less turns in this new coil and a little more voltage on the filament. So the next experimental coil was of 30 turns wound in the same manner as described above, covered the coil with a layer of friction tape, and laid it around the filament end of the input coil on top of the ring-shaped SM coil socket, and have been using it that way since. The regeneration coil has since been connected back in its proper place, but the regeneration condenser left at zero and never used on any station. Most of the stations I receive, the filament rheostat is turned two-thirds of the way off, and the volume is more than double the amount it used to be even after I had made the most careful adjustment of the regeneration condenser. I am sure that anyone who tries this circuit will be pleasantly surprised by the results obtained. For those who have not used the screen grid tube in a simple space charge detector circuit, it may be well for them to first try the detector circuit, and after becoming familiar with its peculiarities to then try adding the coil which will convert the circuit from a very sensitive detector to a 'Super-Sensitive Detector.'

"There is still another use for this 'sensitizing coil' which I am continuing in my experiments. I refer to a radio-frequency amplifying circuit having a positive voltage applied to the inner grid through a sensitizing coil coupled to the input or screen grid circuit, similar to the circuit described above. The sensitizing coil in this case is coupled with reversed polarity for the purpose of applying an alternating e.m.f. to the inner grid which will be out of phase with the signal voltage applied to the screen grid. Enough for now. Go ahead, experimenters, with

the detector and then branch out to the radio frequency circuits."

Ford Model T and Radio

Mr. D. E. Walker, of Banning, California, says: "After trying several hook-ups for connecting a monitor speaker and several sets of phones to a receiver using a single 112A tube in the last audio stage, it began to appear as though it couldn't be done without a considerable amount of distortion. Finally, the following method was devised. It consists of a combination filter and output transformer, the filter being for the speaker while the phones are connected to the output transformer. A peculiar thing about the arrangement is that the volume remains constant, regardless of the number of sets of phones connected in the circuit. Perhaps I am stretching that point, as ten sets of phones are the most that have been connected at any one time. Everything used in the construction of the outfit, with the exception of a few

sections as the primary of our transformer. The next step is to connect leads with the ends of the coil. The outside end, of course, is simple and no suggestions are necessary here. The innermost end offers some difficulty. The way I found very satisfactory was carefully to dig into the insulation until the first layer of the windings was reached. Then carefully scrape the insulation back over a small section of about 10 or 15 turns and solder the leads onto them. It is a good idea to use colored leads here, especially so, if the 24-gauge wire we have for our secondary is white.

"Now we shall commence the construction of the secondary coil. After removing all the old wire from the iron core, we will find that the induction core was a bundle of soft iron wire tightly wrapped in thunderbolt paper. Remove the paper from each end of the core, leaving about 1½" of paper remaining at the center. The paper removed should be saved and used as insulation between

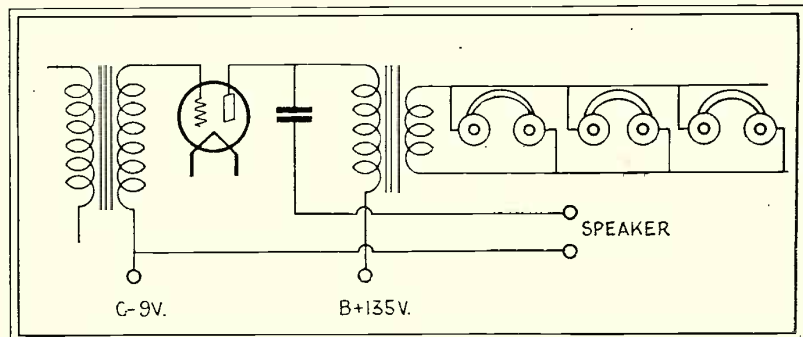

FIG. 4

feet of No. 24 d.c.c. wire, may be taken from the Ford ignition coil. By all means save the condenser in the Ford coil, as this can be used as the condenser between the tube plate and speaker, Fig. 4. Now for the operation on the Ford ignition coil. Carefully remove the outside wooden shell, so that the condenser and winding will not be damaged. After removing the pitch from the surface of the coil, it will appear as in Fig. 5. The secondary of the coil is in two sections, which are held together by heavy paper, which being Ford style, serve also as an insulation between the primary and secondary windings. The primary coil and iron core are easily removed by first giving one end a series of sharp raps. Next separate the section of the secondary coils, by cutting the paper in the slot between them. We will use one of these

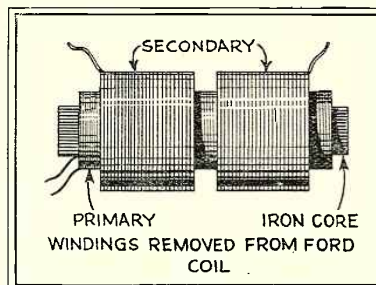

FIG. 5

the windings. Over this center section, wind 4 layers each consisting of 50 turns of 24 d.c.c. wire, bringing out soldered flexible leads. Having used the surplus paper as insulation over the primary winding, slip the primary into the secondary. Over the leads, spaghetti tubing is used as insulation. This will be required, as the

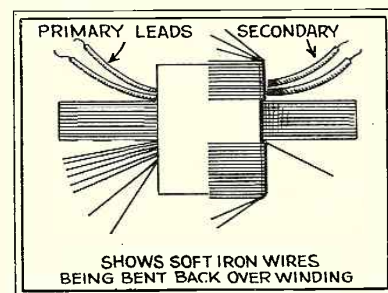

FIG. 6

ends of the iron core wires are turned back over the windings, as in Fig. 6. When finished, the output transformer will look very much like one of the old hedgehog transformers, with the band and base removed. Tightly wrap the whole transformer with friction tape, and it is completed."

The Southern Radio Company, of Miami, Fla., has made a query which leads to the idea of forming a club for
(Continued on page 272)

The Serviceman

A Line and Ground Filter

Mr. Kleinberger, of Philadelphia, Pa., who has been doing service work since 1924, has contributed a filter for in-the-ground circuit of an a.c. receiver. Here is what Mr. Kleinberger writes:

"In the course of my work, I have found 95 per cent of all the a.c. receivers are very noisy, due to interference generated by apparatus connected to the same power lines, and through ground connections. In my home, I am using a set which appears to be very sensitive to picking up these line noises as well as trolley car interference. It is almost impossible to enjoy any stations above 980 kilocycles, due to the noise, and a number of sets in my neighborhood are having the same interference trouble. A number of different types of filters in the 110 volt line have been tried, but to the best of my knowledge a filter in the ground connection is something new. I have been using one on my own set and have installed a filter described

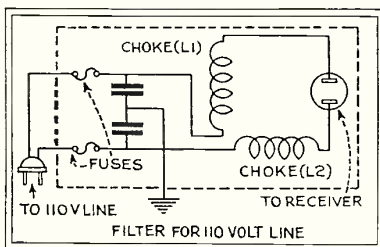

Fig. 1

below on about 120 a.c. receivers and each of the users now enjoys reception over the whole tuning scale of the receiver.

First let us consider the filter for use in the a.c. line. Here, C1 and C2 are 2 mfd. each and rated at 400 volts. The choke coils, L1 and L2, are wound on two-inch forms of No. 16 d.c.c. wire, using 70 turns. The capacities in the ground filter C3 and C4, are also 2 mfd. 400 volt series, and the choke coils wound on a two-inch form with 125 turns of No. 20 double cotton covered. In both the line and ground filter, the choke coils have to be mounted with their centers at right angles, and preferably with copper shielding boxes. In Fig. 1 and Fig. 2 appears the diagram of how these filters should be connected in the circuit. I am sure, if other servicemen will build these filters, they will have the same success I have had with them and their

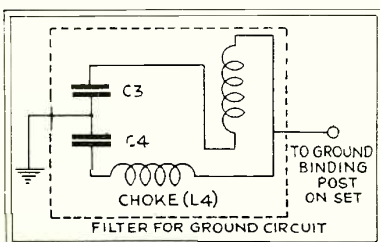

Fig. 2

service work will materially increase in the installing of filters on sets where the noise is unbearable and interference is bad on the low wavelengths. In closing, I would like to add that I have constructed the New York Times Short-Wave receiver, which appeared in May, 1929, issue of RADIO NEWS, and the only thing wrong with it is it keeps me up to 2 and 3 in the morning, something I thought I had gotten over about 4 years ago. Have had more real radio thrills with this set than any I have ever built, and from my log I think I have received every worth while short wave station on the air.

Shorted B Power Condensers

No doubt a number of servicemen, says Mr. C. L. Griffin, of Cleveland, Ohio, have been stopped when they receive a "B" eliminator with a shorted condenser in the block. To return to the factory for repairs takes time, to open the block and replace the shorted condenser is practically impossible. The idea I have passed along to other servicemen has proven satisfactory. To locate the shorted section, the spark test explained on page 1029 of May issue of RADIO NEWS. (There are several ways in which a filter condenser may be tested, probably the simplest is the discharge test. The only apparatus necessary for testing condensers in this way, is the "B" battery and two pieces of wire. The battery is con-

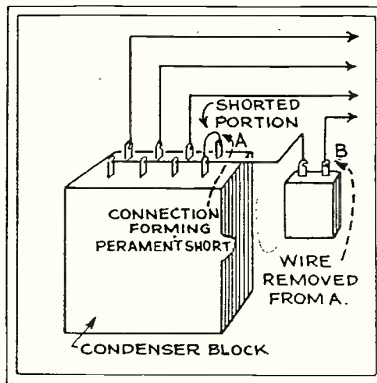

Fig. 3

nected to the condenser for a minute to charge it, then one of the wires is connected from one side of the condenser to the other side, after the battery has been disconnected of course, in order to discharge the condenser. If the latter is in good condition, a spark will jump from it to the wire when it is brought close to the condenser terminal. If the condenser has been previously internally short circuited, a spark will be seen when the battery is connected to the condenser. In this case, the battery should be disconnected instantly, so that it will not be injured. If no spark is obtained when the condenser terminals are shorted, connect the condenser again and repeat the experiment, to be sure that no spark can be obtained. If at the second attempt no spark is obtained, it may be assumed that the condenser is defective. If a heavy

spark is obtained, when the battery is first connected as mentioned above, the condenser is also defective.) Disconnect one wire of the "B" eliminator that is shorted, solder a piece of wire across the terminals of the defective condenser, take a new condenser of the right capacity and solder one side to this short, the remaining wire goes to the other side of the condenser as in Fig. 3. The result being a "B" eliminator condenser bank as good as new.

Portable Tester

Mr. Kessler, of Hillsboro, Md., says: "Hoping this will help someone, I am sending you the diagram of a set tester I have found very efficient for shooting trouble and yet is inexpensive. The milliammeter and voltmeter were taken from an old-time set while the a.c. voltmeter is one of the low priced type, now available on the market. Four midjet jacks and two single pole single throw switches complete the necessary equipment. The d.c. voltmeter had a separate voltage multiplier, which allowed readings of 7½ volts and 150 volts. I used a variable resistance and by doubling the reading, a maximum of 300 volts was obtained. It is well to make a permanent job of this simple piece of apparatus by mounting the meters on a bakelite panel, with the jacks below the meters. With switches in between the meters and the 22½ volt "B" battery on the baseboard, as shown in Fig. 4 when switch No. 1 is thrown to position A and switch No. 2 to position C, batteries or power packs can be tested. With switch No. 1 still on position A and switch No. 2 shifted to position B, continuity test can be made with the voltmeter. Shifting switch No. 1 to B position, the click method may be used for continuity test. The serviceman can readily work out his own procedure of test with this handy little tester."

Permanent Pickup Circuit

Many radio users have not yet used the new electrical pick-up devices for their old phonographs, because of the annoyance of having to fool around with the radio receiver, removing the detector tube, inserting the pick-up plug, at the same time turning off the radio frequency amplifier. This is quite bothersome every time they want to play a record on the phonograph, especially if the receiver is built in an inaccessible console. Mr. C. J. Vesey has devised a method whereby the throw of the double pole double throw

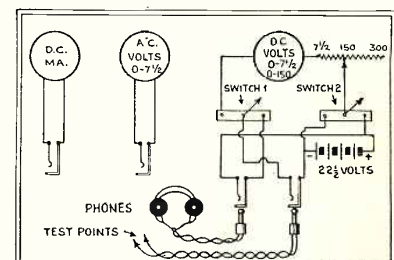

Fig. 4

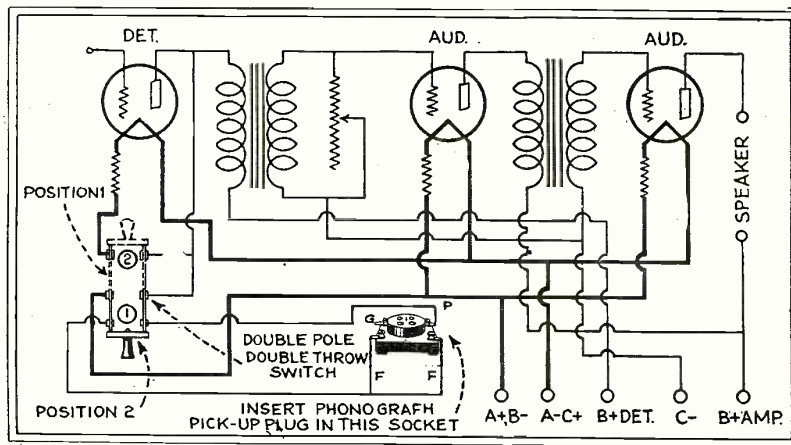

FIG. 5

switch provides either radio or phonograph reception.

"In my set, I use the Supreme pick-up with excellent results. A small double pole double throw switch is necessary for either type of reception, as shown in Fig. 5. The extra connections are extremely simple. In the radio receiver near the detector tube is placed an extra socket. In this a pick-up plug is permanently inserted. From the plate and filament terminals of this socket, leads are connected to one end of the d.t. switch, the center of the switch being connected to the plate of the detector tube, while the other side breaks the negative filament on the detector tube. The other end of the switch is connected to the plate of the detector tube and the minus A terminal on the tube socket, so that it will be easily seen from the diagram, that throwing the switch into position No. 2 connects the detector with the audio amplifying system, while position No. 1 places the phonograph pick-up on the audio amplifier. It will be noticed that I have a 500,000 ohm variable resistor across the secondary of the first audio transformer. This is used as a volume control for the reproduced record, and after it takes care of volume from maximum to a mere whisper. I find that the hook-up does not interfere with radio reception, and another surprising fact is the slight amount of needle scratch. This idea makes a permanent installation of the phonograph pick-up on the customer's

set, without having to use a number of wires outside of the cabinet, which would result in an unsightly job. The double pole double throw switch may be purchased in the jack type from a number of manufacturers, and makes a very pleasing appearance on the receiver panel.

32-Volt Systems

A method of using the home electric power plant, 32 volt type, for the "A" supply on the radio set was described in the June issue of RADIO NEWS. A number of readers of the serviceman department have suggested a second method of using

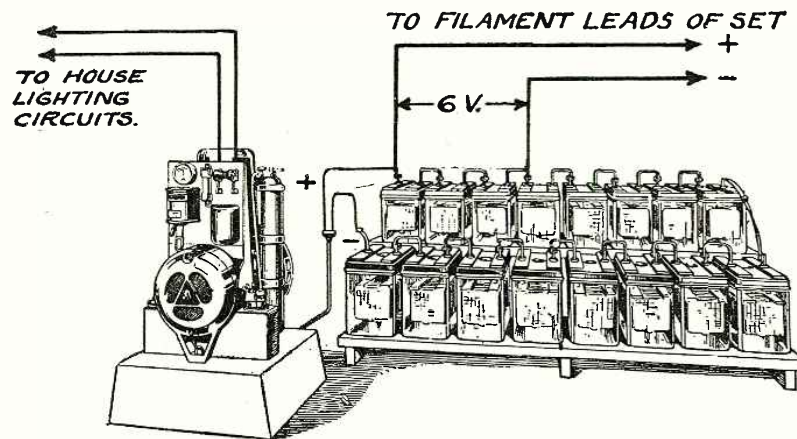

FIG. 6

On Short Waves

Short-Wave Detectors

BEFORE going very far into the design and construction of the short-wave receiver, it will be necessary to make a study of the characteristics of the three- and four-electrode tubes. But the question may arise, "Why use a tube detector, when the crystal, which is very much cheaper, is still to be had, and is used in some of the most famous home constructed circuits?" In last month's short-wave columns we discussed the radio-frequency end of the short-wave receiver and pointed out there the trouble experienced from oscillation when more than

one tube was used. This, then, results in very little actual radio-frequency gain when compared with that obtained in the broadcast receiver, with its three or four r.f. stages.

The vacuum tube, when used as a detector, is not only a rectifier but has decided amplifying tendencies, so that the resultant signal in the plate circuit of the detector is much greater in strength than that of the crystal detector (which is an excellent rectifier but a poor amplifier). Having thus decided on the use of a vacuum tube as the detector, it will be well to realize just what takes place in the detector circuit as well as making a sec-

ond decision, whether this section of the short-wave receiver will employ the grid leak and condenser method of detection, the grid bias method or the space charge principle as used with the screen-grid tube. With a voltmeter and a milliammeter the short-wave fan can actually make measurements, and in this way make a study of the behavior of the detector tube.

Fig. 1 is an arrangement for determining the grid potential-plate current curve. The "C" battery may be composed of a number of No. 6 dry-cells and may be taken for granted to have an e.m.f. of 1.5 volts each. The voltmeter

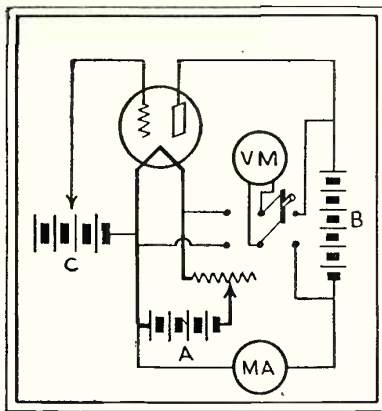

FIG. 1

may then be used, in conjunction with a double-pole double-throw switch, for measuring the "A" and "B" potentials. As will be seen from the chart Fig. 2, the plate current reaches 10 mils with a grid potential of 4 volts plus and with 90 volts plate potential. Let us then start with 90 volts as "B" supply and proceed to plot a curve similar to that shown. At about 12 volts negative grid the plate current will be at about zero. On reducing the grid bias, in steps of 1.5 volts at a time, the plate current will steadily rise until at zero grid the plate current will have reached about 6 mils. A curve similar in shape will, of course, result from using a plate e.m.f. of say 45 or 22½.

This experiment can now be repeated with a 50,000-ohm resistor in the plate circuit, as shown in Fig. 3. Here we will find that the curves have flattened themselves out and are of a totally different shape. The experiment can of course be continued indefinitely by using different size resistors in the plate circuit and various values of "B" potential. Coming back to the curve chart, Fig. 3, where these curves represent the grid potential-plate current characteristics without plate resistance, the theoretical amplification factor of the tube can be obtained. At the grid voltage $E_g = -4.8$ and plate voltage $E_p = +90$ the plate current is the same as for $E_g = +.8$ and $E_p = +44$. That is, a change of 5.6 volts in E_g is equivalent to a change of 46 volts in E_p . Therefore we say the amplification factor is:

$$\mu = \frac{46 (E_p)}{5.6 (E_g)} = 8.2$$

This amplification factor, μ , is the one always given by tube manufacturers. However, in actual use current changes in

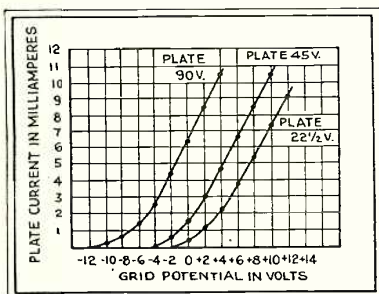

FIG. 2

the plate circuit resulting from voltage changes in the grid circuit are only available when they are used to produce voltage changes across inductances or resistances in the plate circuit. All this does not seem to have much to do with a detector tube but it has and is exactly what takes place in the "C" battery detector. The same holds good in the audio amplifier, but more about that later. Now let us make a curve with the grid detector with the tuning circuit all in order as in Fig. 6. Here we will use a plate e.m.f. of 20 volts. Suppose for the moment that the input voltage across the grid and filament of the tube varies from

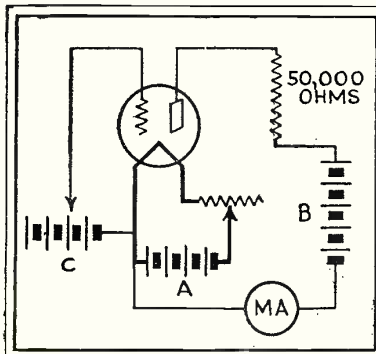

FIG. 3

—4 to zero due, of course, to the alternating current flowing in the tuned inductance. Before the signal is tuned in, let us imagine the normal grid voltage to —2. Referring again to the curve it will be evident that when the impressed e.m.f. goes below this value (—2), only a small reduction in the plate current can take place. But when the alternating e.m.f. goes above —2 the plate current is materially increased. The sine

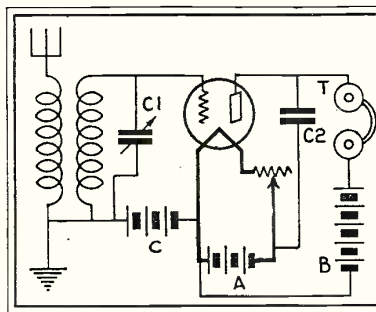

FIG. 4

curve at the right of the plate current curve shows this effect on the plate current for a number of cycles of the input e.m.f. An estimate of the "B" supply average current flow is indicated by the dotted line. Of course if the input e.m.f. varies over or under the —4 to zero we have here considered, the average plate current will be more or less, as the case may be. So, if the carrier wave has an audible modulation the corresponding current variation will make itself heard in the telephones, T. Meantime, a low resistance path for the high-frequency component of the plate current should be offered in the form of a by-pass condenser so that it will not have to flow through

the high impedance of the telephone windings. The windings of the telephones of course have a certain distributed capacity, but usually not near enough, so an external capacity C1 of about .0005 mfd. is employed for the purpose. Usually a "C" battery is used as in Fig. 4 so that the normal grid potential can be kept near its correct value. Undoubtedly this form of detection will come into its own with the television receiver as the grid bias detector will handle a great deal more signal input before overloading than the grid leak condenser system.

Grid Leak Condenser Detection

The more popular method of tube detection is the grid leak grid condenser method as in Fig. 5. For the sake of argument let us take the same grid-potential plate current curve as before and watch the effect on the plate current when an alternating e.m.f. of the same value of that delivered in Fig. 6. When the top side of the tuned coil condenser goes positive, electrons are attracted from the grid into the tube side of the grid condenser, making the grid itself positive, due to a lack of electrons. The grid therefore attracts electrons which are in passage from the filament to the positive plate and some of them are drawn into contact with the grid. The negative charge on the tube

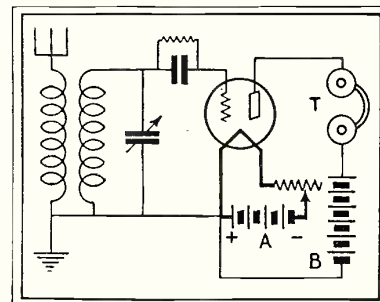

FIG. 5

side of the grid condenser is thereby increased. When the potential of the other side of the grid condenser goes negative on the other cycle of the input e.m.f. in the tuning circuit the electrons on the tube side of the condenser are repelled into the grid, depressing the potential of the grid below normal value. Of course these electrons try to get back to the filament through the grid leak, but the average effect is to depress the grid potential, thus decreasing the plate current. When the incoming e.m.f. varies in amplitude then the plate current will undergo corresponding variations.

In the grid leak condenser detector we will suppose that the carrier wave input produces a plate current of slightly less than 4-milliamperes, while the modulated e.m.f. varies the plate current from 5.5 to .8 milliamperes. The dotted line here shows approximately the average plate current (Fig. 7). The only requirement for this type of detection is that the normal potential be so located that the grid variations of e.m.f. do not extend beyond the nearly straight part of the curve as in Fig. 8. So it is readily realized that the grid leak condenser method is not nearly as critical as to the exact location of the normal grid potential.

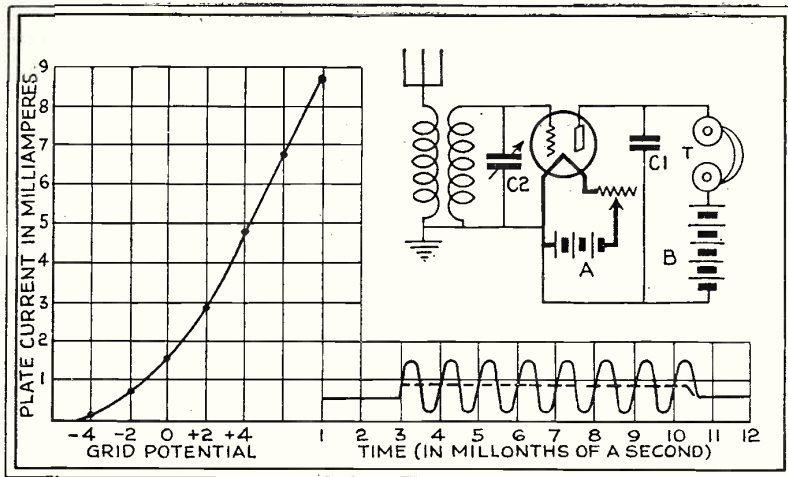

FIG. 6

Screen-Grid Detection

A number of short-wave receivers have appeared using the screen-grid tube as a detector; notable among these was the "Space Charge Autodyne" in the April, 1929, issue of RADIO NEWS. Here it must be remembered that the control grid does not connect to the tuning circuit as it does in the radio-frequency stage, but is connected to a plus potential of 22.5 volts. The screening grid is used as the tuning grid. This method, however, has a bad feature, the tendency of running the dial out of step with that of the r.f. dial. This, of course, to a good many people is not objectionable, considering the increased amplification obtained. This detector will undoubtedly enjoy a well earned popularity when the short-wave fans realize what it will do in comparison to the old, popular 201A tube. Till such a time when multiple stages for short-wave work appear it would seem that little use will be found

for power detectors in this field employing the screen-grid tube. However, a suitable circuit is shown in Fig. 9 for the fans who have a desire to experiment with such a detection circuit.

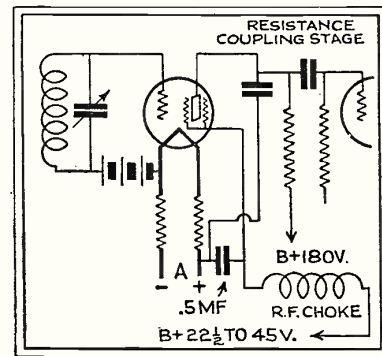

FIG. 9

A very novel stunt has been submitted by Mr. R. L. Ransome, Jr., of Nacogdoches, Texas, for the short-wave fan.

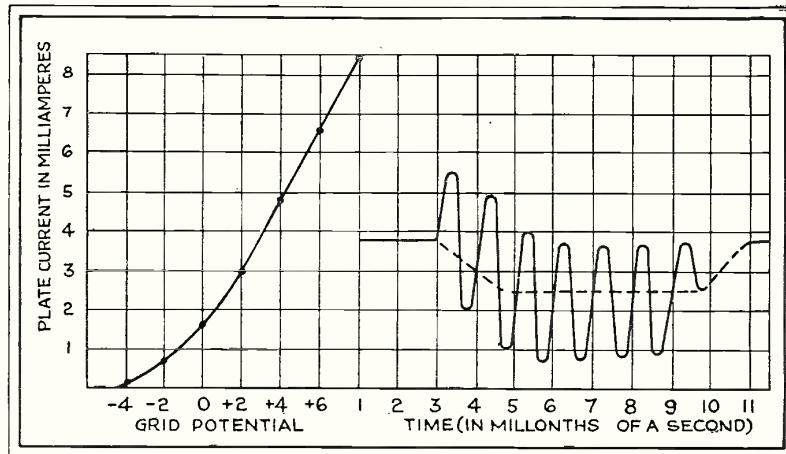

FIG. 7

"Some receivers refused to give stable, smooth regeneration with the ordinary run of r.f. chokes, so I wound a number of these chokes of various values on test tubes. Both ends are of flexible wires soldered and cemented to the choke ends. These flexible leads connect to spring clips. A small cork is screwed down to the sub-panel, over this is fitted the open end of the test tube.

A correspondent writes that he
(Continued on page 276)

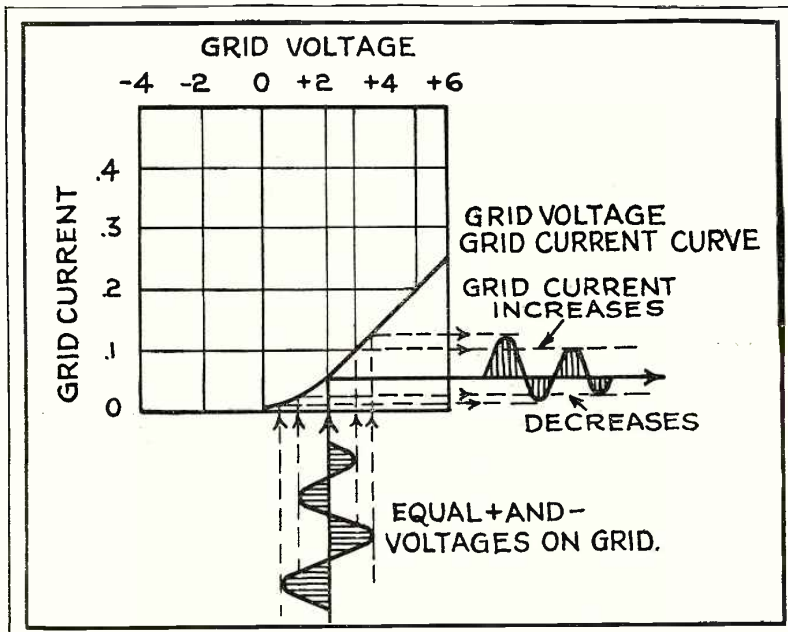

FIG. 8

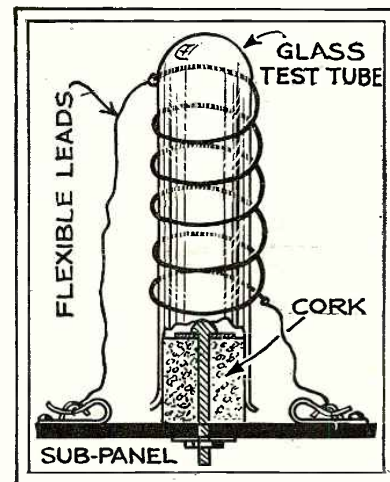

FIG. 10

The Trade Broadcasts:

New Equipment and Manufacturing Trends

A.C. Short-Wave Converter

Of interest to the short-wave enthusiast is the new short-wave converter (Figs. 1 and 2), manufactured by The Westside Radio & Elec. Co., of Miami, Fla. The converter is designed to work with any receiver and remains attached to the receiver at all times. A switch on the converter cuts it in or out as desired. Four 5-element a.c. (cathode type) tubes are used with a special high-frequency circuit, which results in broadness of tuning per stage with resultant overall sharp selectivity. The converter operates exactly the same as the broadcast set, and unlike other short-wave converters, requires no special care in tuning. By the use of a specially constructed regulator which is permanently set when the converter is installed, interference is eliminated. A converter is distributed equipped for a tuning range of 17 to 38 meters. Plug-in-coils for higher waves are, of course, available. The pickup of this converter is so great that the American stations require the manipulation of the volume control, while the European stations pound in with fair volume. Fading and static are practically non-existing, while body capacity is absolutely done away with.

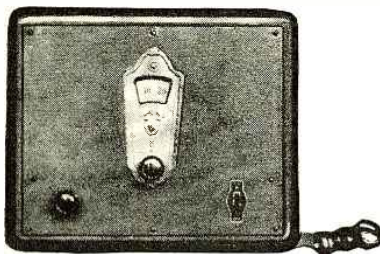

FIG. 1

Amperite's Line Regulator

Of interest to the a.c. radio receiver owner is the new Amperite self-adjusting line control regulator (Fig. 3.) It is a recently perfected device constructed in a glass bulb form, which is remarkable for its regulating efficiency. It is modern, being especially constructed for the conditions encountered in new designs of radio receivers, and has a much longer life than any other type of ballast. The regulator properties of the line amperite are obtained through a specially developed resistance element enclosed in a bulb of standard dimensions, filled with inert gas. UX type base is used for mounting this tube, although only the plate and one filament prong are connected, placing them in series with the line and power transformer. The Amperite line control is designed to handle specific current loads required by receivers, where the fluctuation on the line is about 30 volts, or 95 to 125 volts, and to regulate the current to a



FIG. 3

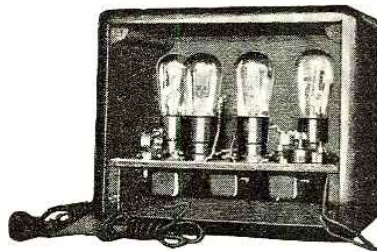

FIG. 2

constancy of within 10 per cent over the range of this fluctuation. The Amperite self-adjusting line control unit is connected directly in series with the 80-85 volt winding of the power transformer. No other change is necessary. Continuous life tests on all capacities from .3 ampere to 1.2 amperes have shown the life far beyond 3,000 hours.

Master Tuning Control

The Master Engineering Company, Chicago, Ill., announces the Master Tuning Selector, which is intended to replace the regular tuning knob on the set. This tuning selector (Fig. 4) is very easily attached with a small screwdriver to the tuning dial or shaft of the drum dial, depending on the make of set, and has a celluloid marker for writing in the call letters of 16 to 20 stations. There are no buttons to be adjusted or to get out of adjustment; when installing this tuning

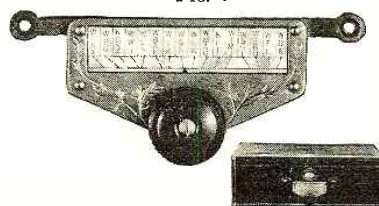

FIG. 4

selector, no changes are required in the tuning of the radio set nor does it interfere in any way with its regular operation. It is particularly adaptable to the new Atwater Kent 55 and 60, Majestic 91 and 92, and the Crosley and Philco receivers.

180-Volt d.c. "B" Eliminator

Where the house mains are of 110 volts direct current, the Rival Radio & Battery Company of New York City has developed an "A" and "B" eliminator for which is claimed a "B" potential of 180 volts. With this new power pack (Fig. 5), the use of heavy duty "B" batteries in conjunction with the 110-volt supply is eliminated. This eliminator contains no choke coils or condensers, the critical voltages being carried by polarized electrolytic cells, which will supply constant current on the taps for 22, 45 and 67 volts, as well as the special amplifier taps, which may be varied from 100 to 140 volts. As an added feature, it contains an automatic device which keeps the "A" battery up to a full charge.

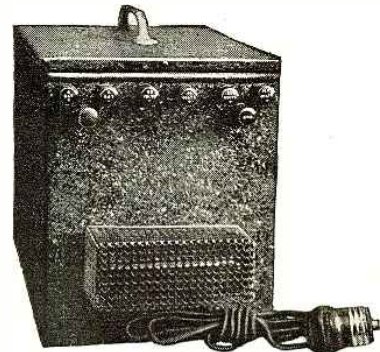

FIG. 5

Of interest to set manufacturers and jobbers in the Chicago area comes the announcement that the W. W. Boyd Company, 9 So. Clinton Street, Chicago, Ill., has been appointed the sales representatives for the Sangamo Electric Company, Radio Division, Springfield, Ill.

The Jensen Radio Mfg. Company of Oakland, Calif., have opened an East coast branch office at 126 Liberty Street, New York City. Mr. James A. Kennedy has been appointed eastern sales manager. At this office a full line of Jensen dynamic loud speakers will be displayed.

John F. Rider, who for the past seventeen years has been interested in radio and for the past eight years has been a contributor to radio periodicals, employed as a consulting engineer, associate editor and managing editor of several radio publications and is the author of several radio text-books which have found wide ac-

claim, has started the Rider-Goll Radio School, 1991 Broadway, New York City, where he will teach radio servicing by attendance and correspondence courses. This phase of the radio industry is well known to Mr. Rider, who has specialized in that field both in practical form and along educational lines, for several years.

According to advice received from the school, two courses will start on July 15. The first is a complete service course lasting over a period of 5 months, involving elementary radio, advanced radio as applied to servicing and practical servicing of radio receivers. The course has been planned to fulfill the requirements of the Radio Service Managers' Association and the requirements set forth by radio manufacturing organizations. The second course is an advanced radio course for men who are now in the service business or who function as servicemen and who are desirous of augmenting their knowledge about a.c. circuits, the most modern receivers and the most modern of servicing methods. Both courses involve practical and lecture work, so that the man who completes the course is familiar with all types of test apparatus, with the best method of procedure and is in possession of knowledge which is necessary for the routine work in manufacturing plants and radio service organizations. The length of the advanced course is two months.

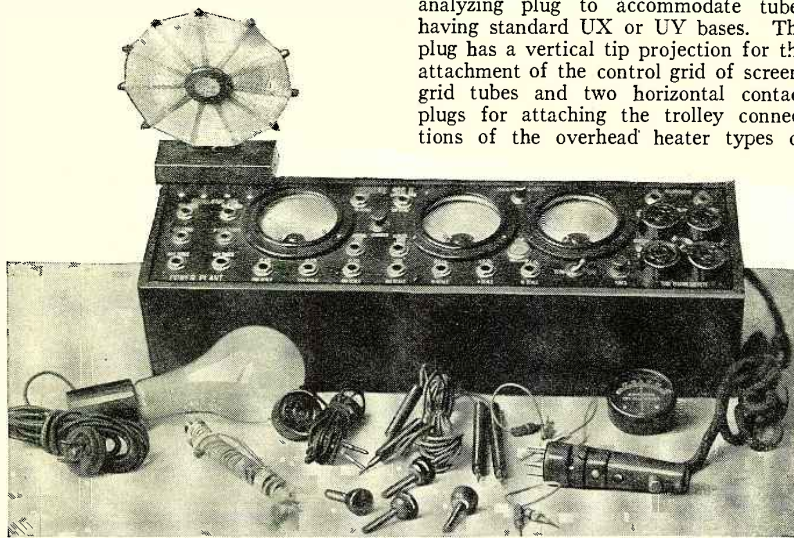

FIG. 6

Supreme Diagonometer 400B

A new Supreme diagonometer known as the model 400B; made by the Supreme Instrument Corp., Greenwood, Miss., is now available, replacing the former model 400A. This new model will not differ fundamentally from the former type, but there have been incorporated certain refinements and changes to the advantage of the serviceman. The model 400B (Figs. 6 and 7) is designed particularly to take care of the new receiving sets employing a.c. tubes. Multiscale meters are used for d.c. and a.c., each of the voltmeters having 4 scales for top value of 750 volts and a milliammeter range to $2\frac{1}{2}$ amperes. The almost universal acceptance of the single-



FIG. 7

dial tuning receiver has introduced the problem of maintaining the synchronous relation between the gang tuning condensers of these receivers, in order that they lose none of their tuning efficiency. The Supreme diagonometer model 400B provides two meter methods of indicating gang tuning condenser alignment, both using the built-in a.c. power and modulated radio-frequency oscillator for setting up signals to be tuned in on the receiver.

Each method utilizes a meter for indicating the output signal-strength of the receiver. This model has been made adaptable for analysis and continuity tests for all types of receivers, including the new screen-grid type. This accomplishment has been made possible by the development of an ingenious tube socket analyzing plug to accommodate tubes having standard UX or UY bases. The plug has a vertical tip projection for the attachment of the control grid of screen-grid tubes and two horizontal contact plugs for attaching the trolley connections of the overhead heater types of

tubes, all of its connections being brought into the test instrument through the same cable. An added feature on this plug is a snap catch which will prevent its becoming separated from the adapter when plugged into tube sockets having tight-fitting contacts. The adapter can, of course, be instantly removed by pressing a button to release the snap catch. Full output readings of filament type rectifier tubes provide a.c. or d.c. current for all continuity tests without the use of external batteries, and with its modulated oscillator furnishes signals for testing receiving sets independent of broadcast stations. As many as 12 thoriated filament type of tubes may be rejuvenated with the diagonometer, without removing from the radio receiver. The Supreme diag-

nometer 400B is complete with a traveling case and is a laboratory in a portable form. Service charts for diagnosing popular makes of receivers are included with the instrument.

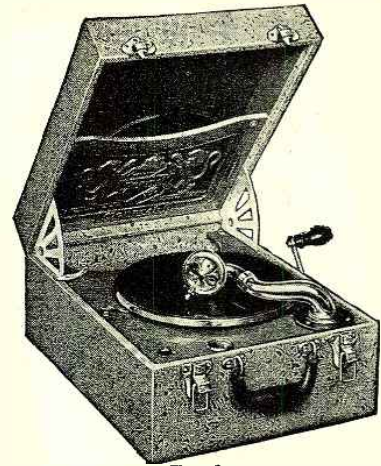

FIG. 8

Caswell's Portable Phonographs

In line with its recent research toward achieving maximum dynamic tone and volume in portable phonographs, Caswell Mfg. Company, of Milwaukee, Wis., has gone still further, introducing what it believes to be the most highly developed portable phonograph of this type on the market, the Caswell Monarch, Fig. 8, and a new and more sensitive phonograph pick-up, Caswell Powertone. The tone and volume of Caswell Monarch is said to be the result of a special air-column chamber developed by Caswell engineers under a new principle of construction. It is so constructed that all the depth, tone and delicate shadings of present-day electrical recordings is retained in the reproduction. The new Monarch actually combines cabinet phonograph reproduction and tone quality in a machine of portable size. It



FIG. 9

is furnished in an artistically constructed exterior case in red, blue or black with appointments to match as well as a built-in record album. The Powertone, Fig. 9, embodies several new mechanical features. It is powered by the General Electric synchronous type motor, chosen because of its dependable performance, with a new feature, the impulse starter.

FREE PROOF YOU CAN MAKE BIG MONEY in RADIO!



Why continue to struggle for years on a meager salary? Why put off the success that can so easily be yours when in only 9 months, you—like hundreds of other men—can be headed straight for a bright financial future? Radio pays big-salaries from \$2,000 to \$25,000 a year are common.

Astounding World-Wide Opportunities

A glorious future awaits you in this huge industry. Millions of sets need servicing, thousands of ships require radio operators . . . manufacturers and broadcasting stations throughout the land are eagerly seeking trained men . . . and now, nationwide radio telegraph service, telephony, television, photoradiograms open up thousands of new and amazing opportunities.

Magnificent Laboratory Outfit Makes It Easy To Learn At Home

You don't have to know an antenna from

a vacuum tube. By means of this marvelous, simplified home training course, sponsored by the Radio Corporation of America . . . you can now prepare for success in every phase of Radio. The remarkable outlay of apparatus given to you with this course . . . enables you to learn by actual practice how to solve every problem in radio work . . . such as repairing, installing and servicing fine sets. That's why you, too, upon graduation can have the confidence and ability to command big money.

Only Training Course Backed by Radio Corporation of America

Graduates of this school are always posted in newest up-to-the-minute developments in Radio. That's why they are always in big demand. The progress of Radio is measured by the accomplishments of the great engineers in the huge research laboratories of the Radio Corporation of America. This gigantic organization sets the standards for the entire industry . . . and sponsors every lesson in the course.

Money Back If Not Satisfied

This marvelous home-laboratory training practically insures your success by preparing you thoroughly in every phase of Radio manufacturing, servicing, broadcasting, photoradiograms, television and airplane radio equipment. As a student you will receive an agreement signed by the president of this school assuring you

of complete satisfaction upon completion of your training—or your money will be instantly refunded.

Read This Free Book

The young men in Radio today will be the industrial leaders of tomorrow . . . that's what happened in the automobile business . . . in aviation . . . and in every other essential industry . . . Get in on the ground floor and climb with this tremendous industry!

Free . . . everything you want to know about Radio . . . 50 fascinating pages . . . each one packed with pictures and descriptions about the brilliant opportunities in this fast-growing profession. See for yourself why R. I. A. training has placed thousands of men in well paid positions—usually from 3 to 10 days after graduation. Mail this coupon now and receive your Free Book.

FREE!

This fascinating book on Radio's glorious opportunities . . . written by one of America's well-known radio experts.

Mail this coupon



RADIO INSTITUTE OF AMERICA



Radio Operator \$90—\$200 per month with all expenses paid. Broadcast Operator \$1,800—\$4,800 a year. Radio Repair Mechanic \$1,800—\$4,000 a year. Radio Inspector \$2,000—\$4,500 a year.

RADIO INSTITUTE OF AMERICA
Dept. Ex. 9
326 Broadway, New York, N. Y.

Gentlemen: Please send me your FREE 50-page book which illustrates the brilliant opportunities in Radio and describes your laboratory-method of guaranteed instruction at home.

Name

Address

The Most Interesting Evening I Ever Spent

UP TILL 9 o'clock the party was a complete flop. Nobody seemed to be able to get things going. Then Tom walked in. Tom's a live wire, if there ever was one.

He said he'd heard about a one man show anyone could perform with the help of a book he knew about. He had sent for that book, and said he was going to put on the show.

We thought he was joking and laughed at him, but he sat us all down in the living room, got out a pack of old playing cards, and started to do things that made our eyes pop out of our heads.

For over 2 hours he made those playing cards almost talk. What he could do with those cards just didn't seem human. After it was all over, the gang all crowded around, shaking his hand, and patting him on the back. The girls all said, "Oh, Tom! You're wonderful!" It was by far the most interesting evening I had ever spent.

I asked him how he learned it all, for I knew he didn't know a single thing about card tricks a week before. For answer he pulled out a shiny new quarter, and said that one just like it had taught him every trick he had showed us.

And it was a fact! Tom had simply enclosed a quarter with the coupon below, and gotten Walter Gibson's Famous Book of Popular Card Tricks by return mail. You, too, can entertain yourself and your friends with the 101 card tricks it teaches. No sleight of hand is necessary—no hard work to learn. Simply read the book carefully and you can do every trick in it.

And it costs only 25c! Send for it today. The demand is great, and we only have a few hundred on hand.

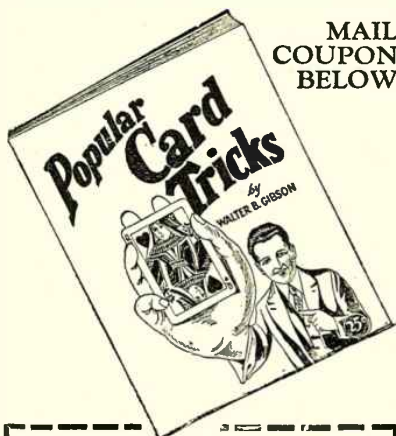

MAIL COUPON BELOW

Experimenter Publications, Inc.
Dept. 2409c, 381 Fourth Ave., New York, N. Y.

I enclose 25c. (in stamps or coin) in full payment for Walter Gibson's Book of Popular Card Tricks, which, if understood, will be sent me by return mail.

Name.....

Street & No.....

City.....State.....

A Discussion of Coil Design

(Continued from page 219)

and the length of the winding. This proportionate reduction is zero for an infinitely long coil; the deduction is 10% for a coil four times as long as its diameter; about 32% for a coil as thick as it is long; 47% for a coil half as long as its diameter; and 65% for a coil whose winding width is only 1/100th of the diameter—a single turn, say. It is evident that, the longer the coil, the greater the efficiency, in the respect of obtaining inductance. But, given a certain length of wire, and instructed to make it into a coil with the greatest possible amount of inductance, we find that the proportion of the length of the winding to the diameter will be 2.46.

It is evident by this formula (which is given here only approximately but is of accuracy as great as that which can be obtained in an ordinary home-made coil) that, if we double the diameter of a coil, we increase the inductance about four times; and if we use half the diameter, we get only one-quarter the inductance in the same number of turns. If we double the number of turns in the same

fifth longer than its diameter, and we get 303 microhenries.

It is obvious, going back to our figures for the capacity and inductance of a tuned circuit, that this coil would (without taking into effect its own self-capacity) tune well over the top of the broadcast band with a 350-mmfd. condenser; it would come very close to it, if not all the way, with a 250-mmfd. variable.

If we reduce the turns to 90, in the same space, leaving next each winding of wire a space equal to one-ninth its own width (or about 1/360th of an inch), we shall find by recalculating that the inductance now reached is about 245 microhenries; which will be about right for a 350-mmfd. condenser. In addition, we have reduced somewhat both the self-capacity and the resistance of the coil, which will be an important advantage at the lower end of the waveband.

It may be interesting to note that, if we stretch the wire out straight, instead of coiling it up into 90 turns, we shall find that its inductance is then about 32.2 microhenries; in other words, its magnetic

TABLE OF COMMON WIRE SIZES
(†Number Close-Wound Turns to 1 Inch Length of Winding)

*FEET TO 1 OHM	GAUGE (B+S)	BARE	ENAMELED	D.C.C.	D.S.C.	FEET IN 1 LB. D.C.C.
388	14	16	14	13	—	77
244	16	20	18	16	—	119
154	18	25	23	20	—	188
97	20	31	29	24	—	298
61	22	39	36	29	—	460
38	24	50	45	34	38	745
24	26	63	57	40	45	1120
15	28	79	71	45	53	1760
9½	30	100	88	51	67	2534
6	32	126	120	60	77	3137

*Direct-current resistance. †Nearest number. In home construction it will probably be impossible to wind wire so tightly, so that the actual number of turns per inch will be less.

space, we increase the inductance about four times; if we halve the number of turns, by space winding, we cut down the inductance to about one-fourth the former amount.

On the other hand, if we lengthen the coil by spacing the turns, using the same number, we find that our first product remains the same; but the increasing length of the winding drags down the inductance faster than the increasing proportion of efficiency sustains it. So we must add more turns; nearly forty per cent, if we are to double the length of winding and still keep the same inductance value. The direct-current resistance of our coil increases in proportion to the length of the wire; although the resistance at radio frequencies (especially the short wavelengths) introduces other problems.

Just for Instance

Example: we have a coil 2 inches in diameter. We wind on it 100 turns of wire in a length of about 2½ inches; as, for instance, by winding closely with No. 26 double-cotton-covered wire. (This will make a winding 2.39 inches long—very close to the value recommended above.) The square of the radius is 1; of the number of turns, 10,000. Divide 10,000 by 24 (ten times the length of the winding) and we get 417. Deduct 27.4 per cent, the proportion for a coil one-

influence upon itself is increased eight times by the winding. It is hardly necessary to add that the straight 48-foot length of wire would be unsuitable for use in a tuned circuit. The self-inductance of a straight wire increases almost in direct proportion to its length, and is less affected by the diameter.

Suppose that we desire instead to make a "junk-box" coil on a tube base, using the same size of wire, No. 26 D.C.C. Our base is 1¾ inches in diameter. We wind 10 turns, spacing them apart to their own width by means of a second wire, later removed. Then the square of the radius (0.6875-inch) is 0.4717, and this multiplied by 100, the square of the turns, is 47.17. The length of the winding is 0.455-inch. Ten times this is 4.55 which goes into 47.17 about 10.37 times. Because our coil is very short in proportion to its diameter, we must deduct 57 per cent, giving us a total of 4.43 microhenries.

With a 32-mmfd. condenser across this coil, we then have a product of inductance and capacity equal to 142. Applying the second formula of this article, we shall find a theoretical maximum wavelength of 16.35 meters. As a matter of fact, it will be considerably higher; because there will certainly be a considerable amount of stray capacity present in

(Continued on page 266)

MISSION BEACH, SAN DIEGO, CAL., PAM EQUIPPED



PAM

The Playground's Partner

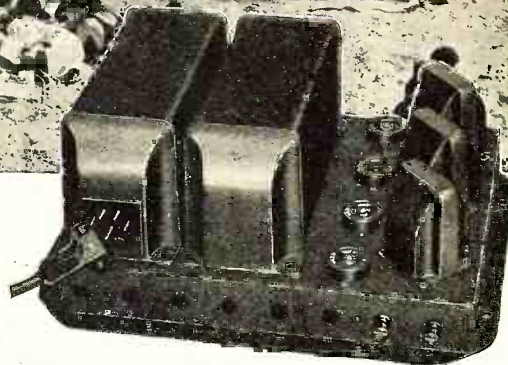

PAM 45 is the newest addition to our line and uses one 227, one 281, and two 245's.

Not only on the beaches and midways, but in dancing pavilions, merry-go-rounds, waiting rooms, and in *any* place where people gather they may be entertained, instructed, or advertised to by PAM amplifiers.

You will find, as other dealers already have found, many places for such installations.

Your worthwhile sales may include phonographs, pick-ups, microphones, radio sets, tubes, loud speakers and wiring.

A new 16-page bulletin giving mechanical and electrical characteristics, representative installations, and many new PAM amplifiers will be sent upon receipt of 10c in stamps to cover postage. When writing ask for Bulletin No. RN2.

Main Office:
Canton, Mass.

Samson Electric Co.

Manufacturers Since 1882



Factories at Canton
and Watertown, Mass.



JULES VERNE'S TOMBSTONE AT AMIENS
PORTRAYING HIS IMMORTALITY

Jules Verne Comes Back to Life!

A MAGIC name—Jules Verne! A name that has brought untold joy to untold millions.

Who can fail to remember his famous novels, "Twenty Thousand Leagues Under the Sea," "From the Earth to the Moon," "To the Center of the Earth," and other equally imaginative triumphs of this world-renowned novelist? Few writers have ever equalled Jules Verne's vivid imagination, and still fewer have been able to paint these pictures of the mind so brilliantly in printed words.

And now Jules Verne comes back to life! Comes back with stories that increase your pulse and make your heart pound. For in **AMAZING STORIES**, the magazine of scientific fiction, the famous school of authors who have followed in Jules Verne's footsteps now offer you the fertile fruits of their imagination. In their colorful minds, the inventions and discoveries still to come are already here. They write of a voyage to Venus, that silvery star seen so often in the evening sky; of correspondence with a mythical people on Mars; of radio messages from still more distant planets; of giant insects and of people who have huge heads and no bodies; of the things a man might well see and hear a thousand years from now!

It's a thrill you've never had! For it deals with the Future, and the things your children's children may some day actually experience and enjoy.

Get the next 6 Big Issues of **AMAZING STORIES** delivered to your home by the postman. Read with a relish these profusely illustrated stories of a weird, but not impossible, future.

As a special inducement we offer all 6 Big Issues for a single \$1. (The news-stand price is \$1.50). And if you are not convinced **AMAZING STORIES** is worth twice the price, after reading the first issue, we will let you keep it FREE, and send your dollar back.

Sit down right now and fill out the coupon below. It is your insurance against dull evenings from now on!

Simply Clip and Mail Coupon

AMAZING STORIES,
Dept. 2409S, 381 Fourth Ave.,
New York, N. Y.

Gentlemen:

I enclose \$1, for which send me your next 6 issues of **AMAZING STORIES**.

Name.....

Street.....

City..... State.....

(Continued from page 264)

the construction of this circuit, and very little is necessary to change the tuning of a system appreciably at this very high frequency.

Mutual Inductance

It will be noted, however, that the figures we have been making refer only to the inductance of a coil by itself. They do not take into consideration the fact that, if another winding (primary or tickler) is anywhere near the tuned circuit which we are considering, it will make a considerable change in the inductance of the secondary. (Also, the secondary will change the inductance of the primary.) Why this should be so is apparent when we look back to the explanation at the beginning of this article. When the current in one wire is creating an induced current in a second wire, it must be carrying a heavier load; just as there is an added load on our house lines (and the transformer feeding them) when we switch on more lights. Furthermore, this magnetic connection between two circuits must work both ways; for this reason it is called "mutual" inductance. When the current in the primary falls, the secondary feeds back into it.

For instance, there is a small current flowing in the primary of a radio-frequency transformer. It is "coupled" to the tuned secondary by being wound on the same tube; so that each turn of the primary is parallel to (or, more exactly, its axis is concentric with that of) each turn of the secondary. Each alternation or pulsation of current in the primary circuit produces a smaller, but similar, pulsation in the magnetic field of the secondary. The electrical particles in the secondary are compelled to shift their positions accordingly, and their motion is what we call a current. The calculation of the mutual inductance of two coils is extremely complicated; and requires formulas of an extended nature. The reader who wishes to pursue them may refer to the textbooks and to the publications of the Bureau of Standards. However, here is a specimen of the results of a rather simple case. A small coil (primary) is wound on a form placed in the center of the tube which carries the secondary. The larger coil is on a two-inch form which has 80 turns of No. 26 wire in a space of 2.4 inches. Its self-inductance, by the formula above, is 194 microhenries.

The smaller coil has 15 turns of the same wire on a 1¾-inch tube, wound in a space of 0.45-inch. Its self-inductance is then 11.27 microhenries. The mutual inductance of the two circuits, then, will be about 31 microhenries; not a great change to that of the secondary, but a very considerable alteration in the load on the primary. It is proportional to the product of the number of windings in each; while the voltage "step-up" in a secondary is also proportional to the ratio between its turns and those of its primary.

The calculation of the effect of the mutual inductance on the characteristics of each coil cannot be treated here readily; it was analyzed mathematically in the December, 1925, issue of **RADIO NEWS**. Suffice it to say that the proportion of the mutual inductance to the self-

inductance of each coil introduces the effect called "coupling"; and that in a radio-frequency transformer it is necessary to avoid coupling which is too close—as it would be if we placed the primary in the middle of the secondary and close to its windings, as in the instance above. The coupling produces a "two-spot" effect in the tuning of the transformer; if it is very slight, the "two-spot" effect will narrow down into that of a band-pass filter, and thereby take off the sharpness of tuning which in a very low-resistance, sharply tuned circuit would "cut off the sidebands" and destroy the quality of the signal. For that reason it is customary to separate the primary somewhat from the secondary; and a means of varying it adds often to the operation of a receiver.

Coil Capacity

While the scientists are fond of very intricate formulas, they decline to give a general rule for calculating the capacity of a coil. There are so many elements which might enter into the problem that it is much more satisfactory to make a coil with given materials and measure the result. However, this does not alter the fact that self-capacity in a coil is a necessary evil, and that it should be kept as low as possible.

Every coil is a tuned circuit in itself; that is, without any condenser attached, its self-capacity and its inductance determine a frequency to which it is tuned. A coil may be used, with a wavemeter, as a frequency standard; and such coils are kept by the Bureau of Standards for use in its precision work.

For instance, suppose that a coil has an inductance of 200 microhenries and a self-capacity of 12.5 mmfd. Its fundamental frequency, by itself, then corresponds to 94.2 meters and, in presence of a strong signal of this frequency, the wavemeter would detect a current flowing the coil.

If we put this coil into a circuit which has a variable condenser of 500-mmfd. capacity, it will tune to well above the upper range of the broadcast band. If the total capacity of the circuit at the condenser's minimum is less than 50 mmfd., we should also expect to tune well below the broadcast band. This condition, however, is not desired in a broadcast receiver where we seek to have one station channel on each division of the dial—none above, and none below. For that reason, and because we have high amplification and must introduce some stabilizing resistance into our several tuned circuits to prevent oscillation, less is heard now of "low-loss" coils than some years ago.

However, the capacity of a coil is a source of undesirable loss. It increases the resistance of a coil more and more, the higher the frequency rises. This is because, so to speak, the electricity in our coil tends to "jump the track." Below the natural wavelength of the coil, its capacity becomes the most pronounced feature, and it is then actually a small condenser in its operation. This is true, for instance, of an audio-frequency transformer. Its high inductance would completely block the radio-frequency output of a detector tube; but its capacity by-passes such current.

(Continued on page 279)



They said—

“S-M will do it this year”

—and S-M has done it!

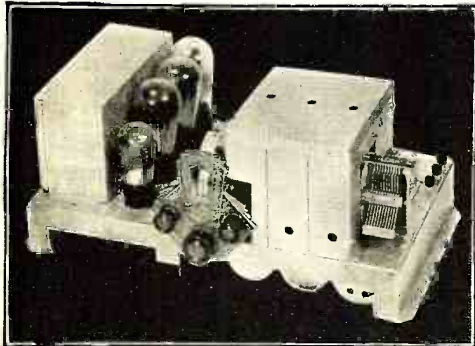

**S-M 722
Band-Selector Seven**

Far better in actual performance than the famous 720 and 720AC Screen-Grid Sixes, as well as more convenient, the 722 Band-Selector Seven is strictly all-electric, and tuned entirely by a single illuminated drum. It embodies a.c. screen-grid amplification in two r.f. stages, band-selector tuning, screen-grid power detection followed by resistance-coupled first r.f. stage, push-pull 245 output tubes, and provision for dynamic speaker. The 722 makes top-notch 1930 quality no more costly than merely mediocre reception.

BUILDING upon the experience of last year—when the S-M 720 and 710 Screen-Grid receivers set new high marks of accomplishment, both in extreme distance reception (such as Australia to New York on the broadcast band) and in musical excellence—Silver-Marshall announces a development as important to the 1930 builder as was the 1929 S-M supremacy in screen-grid receiver design.

This year there is an entirely new keynote in designs for the radio setbuilder: **CONVENIENCE**. Formerly considered as the one feature monopolized by factory-built sets, perfect convenience in operation is now brought within the reach of all—and yet with even better performance than the best “kit sets” of last year—the S-M 720 and 710.

And this, too, at lower cost rather than higher—for the great new S-M factory, five times the size of last year’s, and one of the largest in America, is bending its mighty power to bring still lower the cost to the setbuilder of those phenomenal results he feels a right to expect from any S-M receiver.

**Power
Amplification
of Quality
Unexcelled**

S-M amplifiers will cover large crowds, with practically perfect tone fidelity. Both of these standard types are available through the trade. Both operate entirely from the a.c. light socket, and show a straight-line characteristic from 5000 cycles down to 70 cycles or below.

S-M 690, to reach 2000 or more people, has three stages, the last two being push-pull; will supply 6 to 12 or more dynamic speakers. Fading control is provided on the panel, and a three-point switch for record, microphone, and radio input selection. Tubes required: 1—27, 2—26, 2—50, 2—81. Price less tubes, \$147 net.

S-M 679, (two-stage, supplying 2 to 4 or more dynamic speakers) will cover 1500 people or more. It has binding posts for microphone, record, or radio pickup. Tubes required: 1—26, 1—50, 2—81. Price less tubes, \$81 net.

And If That Sounds Startling—Read This

**The Seven-Twelve Tuner
A Refinement of the Sargent-Rayment**

For the setbuilder who wants the best regardless of cost, S-M is able to repeat the promise made and kept a year ago. The Sargent-Rayment 710 was acknowledged to stand head-and-shoulders above all other receivers offered at any price—and the same laboratory which perfected it now offers a further refinement in the S-M Seven-Twelve Tuner. Though not high-priced, the Seven-Twelve will this year duplicate the achievement of its illustrious predecessor and will far surpass in performance anything offered to the setbuilder at any price whatsoever. Built to realize every advantage of a precision band selector tuner entirely separate from its audio amplifier, the Seven-Twelve uses 224 a.c. screen-grid tubes in three r.f. stages, band-selector tuning, and power detector. Perfectly adapted to give to the 712 a tone quality in keeping with its own outstanding sensitivity and selectivity is the new 677 two-stage power amplifier (245 push-pull). The 712-677 combination will be the setbuilder’s ace for 1930—and at a price that will astonish the most skeptical.

Get your order in right away to your S-M parts distributor, for one or more of these 1930 receivers. Net prices will be found in the new S-M fall catalog; see coupon.

Have you seen the intimate description of these three all-new S-M receivers as first printed in the S-M RADIOBUILDER? If you want to keep up-to-date on the new developments of the S-M laboratories, don't be without the RADIOBUILDER. Use the coupon.

Custom-builders who use S-M parts have profited tremendously throughout the past season through the Authorized S-M Service Station franchise. If you build professionally, let us tell you about it—write now.

**735 Round-the-World Six
All-Electric—Short-Wave and Broadcast Band**

The first completely a.c.-operated short-wave receiver to be offered upon the American market. Built on the same chassis as the 722 illustrated above, the 735 demonstrates in short-wave reception the same mastery of design for the 224 a.c. screen-grid tube which distinguishes the new S-M broadcast receivers. Built into it also is a typical S-M two-stage audio amplifier with push-pull 245 tubes. Plug-in coils give a range of from 17 to 650 meters. Strictly one-dial tuning, full a.c. operation, and provision for dynamic speaker unite to make the 735 a real milestone in short-wave development.

SILVER-MARSHALL, Inc.

6445 West 65th St., Chicago, U. S. A.

Silver-Marshall, Inc.
6445 West 65th Street, Chicago, U. S. A.

... Please send me, free, the complete S-M Catalog; also sample copy of The Radiobuilder.

For enclosed in stamps, send me the following:

- 50c Next 12 issues of The Radiobuilder
- \$1.00 Next 25 issues of The Radiobuilder

S-M DATA SHEETS as follows, at 2c each:

- No. 3. 730, 731, 732 Short-Wave Sets
- No. 4. 255, 256, etc., Audio Transformers
- No. 5. 720 Screen Grid Six Receiver
- No. 6. 740 "Coast-to-Coast" Screen Grid Four
- No. 7. 675ABC High-Voltage Power Supply
- No. 8. 710 Sargent-Rayment Seven
- No. 9. 678PD Phonograph-Radio Amplifier
- No. 10. 720AC All-Electric Screen-Grid Six
- No. 12. 669 Power Unit (for 720AC)
- No. 14. 722 Band-Selector Seven
- No. 15. 735 Round-the-World Six
- No. 16. 712 Tuner (Development from the Sargent-Rayment)
- No. 17. 677 Power Amplifier for use with 712

Name.....

Address.....



To eliminate "static" from motors, street cars, telephones and electrical appliances, plug in a Falck Claroceptor between wall socket and radio set. This new improvement by a pioneer manufacturer grounds and thus blocks out line interference noise and radio frequency disturbances. Also improves selectivity and distance. Requires no changes in set. Measures just $3\frac{1}{2} \times 5\frac{1}{2} \times 2\frac{1}{2}$ inches. Thousands all over America now use the Claroceptor for clearer A.C. reception. Get one right away—at radio parts dealers. Write for descriptive folder.



Falck CLAROCEPTOR
 Manufactured by ADVANCE ELECTRIC CO.
 1260 W. Second Street Los Angeles, Cal.
 JOBBERS AND DEALERS, GET OUR PROPOSITION

Great New Book On
Power Amplifiers
 FROM the Diagrams and Instructions in this new FERRANTI book you can build 10 different wonderful Power Amplifiers using UX171, UX 250, and even the very new UX 245 tubes. Follow the FERRANTI instructions and your Power Amplifiers will have high gain, flat response level, natural tone, tremendous power. Endorsed by engineers and reproduction experts. Sent postpaid for 15¢ coin. Write for YOUR copy today.
FERRANTI, Inc.
 230 W. 42 St. Dept. 95
 New York N. Y.

LEARN TELEGRAPHY WITH TELEPLEX
 Be an expert Morse or Continental code operator! BIG PAY—TRAVEL—FUN—ADVENTURE After a few short weeks of practical study with Teleplex you will be an expert operator. This amazing instrument teaches you right in your own home. Works like a phonograph. No knowledge needed—beginners learn at once! NOT A SCHOOL. Free 10 days' trial. Write for FREE booklet J-11.
TELEPLEX CO., 72 Cortlandt Street, New York City.

Improve your reception with the
Carborundum Detector
 Reg. U. S. Pat. Off.
 Now it's Adjustable—used by noted circuit designers
THE CARBORUNDUM COMPANY
 Dept. D-1 Niagara Falls, N. Y.

FREE Wholesale Radio Catalog
 SEND FOR IT TODAY
 Send for our new illustrated catalog of nationally known AC sets, kits, parts, accessories, consoles, etc. All lines at Lowest Wholesale Prices. Write for your FREE copy today.
SHURE BROS. CO.
 Dept. 315 335 W. Madison St. CHICAGO, ILL.

Explorer Eight Improvements

(Continued from page 227)

means of the employment of a C bias voltage to obtain rectification was fully covered and the reader is referred to that issue for complete information. Suffice it to say that with the C bias or C battery method of detection, much greater signal energy can be applied to the grid circuit of the detector tube without danger of introducing distortion due to overloading, which would be likely to occur if the grid condenser-grid leak method were retained. That is to say, where, ahead of the detector, a tuner unit is employed which is capable of a high order of signal amplification, then it is a wise procedure to employ the C battery method of detection in preference to the condenser-leak method so as to make certain that the detector tube will be capable of handling the amplified signal. The disadvantage which accrues from the use of the C battery detector is in a lessened sensitivity, but considering that this feature is being taken care of by the radio frequency amplifier stages preceding the detector stage it may not be seriously judged as a handicap, especially when the advantages obtained through its use may be said to outweigh the disadvantages.

Two of the ways in which the C potential may be obtained are illustrated in Figs. 5 and 6. In Fig. 5 the voltage employed is of a fixed value and is obtained from a conventional type of $4\frac{1}{2}$ volt C battery. The important point to remember is that the amount of plate voltage required and applied to the plate of the detector tube is of a definite fixed value and should be maintained at that

value if proper rectification is to be expected. For a type 201A detector tube the plate voltage required for satisfactory rectification when $4\frac{1}{2}$ volts of C battery are used should never be of a value below 90 volts. This value applies to the usual makes of tubes. In some instances independent tube manufacturers specify either a different plate voltage or a different grid voltage, and to make sure of these values the reader had better look up the tube charts issued by the manufacturer whose tubes he happens to be using.

The second system of grid biasing makes use of a C battery which is shunted by a potentiometer of the value of 500,000 ohms, and is connected in the detector circuit as shown in Fig. 6. With this system it is possible to adjust the grid bias voltage very accurately to the proper value which by test gives best results. The only possible objection to this system is that when the set is not in use the potentiometer is drawing a minute current from the C battery; a very low amount, to be sure. Naturally, in time the battery will become discharged and will have to be replaced with a new one. Obviously if this feature is objectionable the way out of this problem is to incorporate a switch in the C battery circuit, if another control is not considered undesirable.

Obtaining "Auditorium" Volume

The resistance coupled audio amplifier channel which was originally in—
 (Continued on page 270)

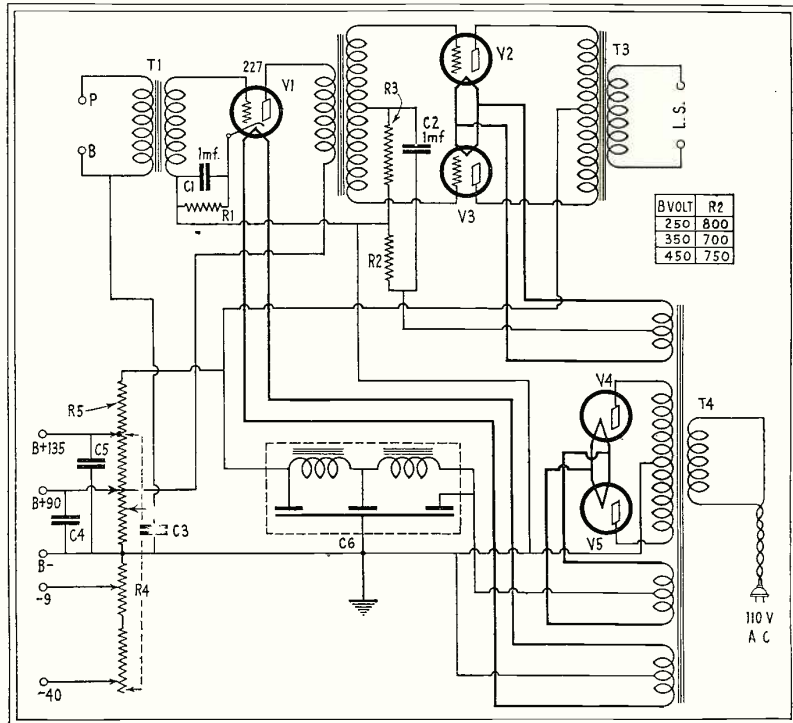

FIG. 7. FOR THOSE WHO DESIRE GREATER VOLUME THAN THAT ORDINARILY REQUIRED, THE "250" POWER AMPLIFIER, WHOSE CIRCUIT IS SHOWN ABOVE, CAN BE SUBSTITUTED FOR THE THREE-STAGE RESISTANCE-COUPLED AMPLIFIER ORIGINALLY SPECIFIED

**IN SEPTEMBER
AMAZING STORIES**

GOLD DUST AND STAR DUST, by Cyril G. Wates. This time our first prize-winning author tackles the fourth dimension—a favorite subject about which so much is written and so little is known. It is no wonder the author finds it necessary to put a detective on the job.

THE RED PERIL, by Capt. S. P. Meek, U. S. A. If it is interesting to watch the advance of the Machine Age, it is equally interesting and perhaps more important to give a thought to the possibilities of future warfare. Being an army man himself, our author goes beyond the "war in the air" period and shows us possibilities far more dangerous.

THE YOUNG OLD MAN, by Earl L. Bell. When the meaning of electricity is discovered, many new, and today unthought of, uses would probably be found for it. For instance, if by a strong enough electric shock, life can be taken away, might it not also be a means for making or perpetuating life? It is an interesting theme to play with and Mr. Bell does so in a manner absorbing to the reader.

OUT OF THE VOID (an interplanetary serial in 2 parts), Part II, by Leslie F. Stone. The concluding chapters of this story gain momentum as they proceed. The adventures of Dana Gleason on this planetoid beyond Mars are particularly fascinating because of the wealth of scientific detail that is included in the story.

THE DOG'S SIXTH SENSE, by W. Alexander. What is it that enables a dog to understand his master's wishes and commands? What would be likely to happen if this extra sense—and there must be one—were combined with man's intelligence? Much might happen—and much does happen in the story.

THE WHITE ARMY, by Dr. Daniel Dressler. Even the layman is greatly concerned over the mechanism and mechanical arrangement of various machines. Only the human machine seems to be taken for granted and is treated with a vast amount of difference. Yet it is the most marvelous machine of all, and as yet has not been capable of reproduction in even the slightest degree. Dr. Dressler, with an expert's knowledge on the subject, weaves a romance around it, worthy of anybody's careful study.

THE CORAL EXPERIMENT, by Alexander Snyder. If you are a dentist, you will be interested in the story, professionally. If you are not a dentist, the interest will be entirely personal. Anyway, you ought to know what it is all about.



**FREE RADIO BOOK~
describes many opportunities
to make big money
in the Radio field.**

**Hundreds of Men
Have Won Success
This Way**

The National Radio Institute is the oldest and largest Radio home-study school in the world. It has prepared hundreds of men for the Radio profession—some of them now holding leading positions in this industry. You'll find N. R. I.-trained men in practically every Radio organization of any importance throughout the world. The same practical tested training that enabled these men to get ahead is now open to you. And this training has been improved, enlarged greatly to keep up with the constant expansion of Radio opportunities.

**Has Made \$10,000
More in Radio**

"I can safely say that I have made \$10,000 more in Radio than I would have made if I had continued at the old job. When I enrolled with you I didn't know a volt from an ampere. I advise all ambitious young men to get into Radio. There is no greater opportunity."
Victor L. Osmond,
7101 Bay Parkway,
Brooklyn, N. Y.

\$3,000 a Year

"I cannot give too much credit to the N. R. I. for what I have been able to do in Radio. I have averaged \$3,000 a year for the past three years. I am in the Radio business. I consider all the success I have obtained so far due entirely to your training."
Fred A. Nichols,
Hereford, Colo.

Here's a book that's shown man after man the way to "cash in" on the big opportunities in Radio. I'm not asking \$5 or \$6 for this book—it's FREE. If you're earning a penny less than \$50 a week clip the coupon below and get a copy of this free Radio book for yourself.

**Salaries of \$50 All the Way Up to \$250 Weekly
Not Unusual**

Radio—the NEW, speedy, growing, live-wire profession—needs trained men for its good jobs. Television, trans-Atlantic Radio telephony, many other wonderful inventions and developments are being made constantly in this field! Each one means more big-money opportunities for a trained Radio man. My book gives the facts about these Radio opportunities. And more—it tells how you can get all the training in Radio you need, quickly and easily in your spare hours at home, by my new and practical methods. In a short time you, too, as have hundreds of others, can be prepared to take advantage of these big-money Radio opportunities—salaries of \$50 all the way up to \$250 a week not unusual. My Free Book will give you all the Facts and Proof.

Extra Dollars for You Almost At Once

Think of making \$15, \$20, \$30 extra each week "on the side," without interfering with your regular job! I'll show you how to do that, too, by using spare time that you're wasting now. I'll show you how to turn what I'm teaching you into cash almost at once, when you and I get started together. My Free Book tells you all about it. If you send for the book today, and if you have the average man's ability, it's possible for you to be making extra money thirty days from now. And you'll be ready for a good full-time Radio position after eight to twelve months of spare-time training.

**I'll Send You This Big 64-Page
Book FREE**

My book is filled with photos and facts—the paying facts you want to read. If you're interested in Radio, or if you're interested in making more money, you owe it to yourself to read this book. The book absolutely won't cost you a cent, and you place yourself under no obligation by sending for it. No previous Radio experience needed to take advantage of this offer. No special schooling required. Send coupon today.



J. E. Smith

Address J. E. SMITH, President

National Radio Institute, Dept 9WTT, Washington, D. C.

**Mail
coupon
Today!**

J. E. SMITH, President,
National Radio Institute,
Dept. 9WTT, Washington, D. C.

Dear Mr. Smith: Kindly send me your free 64-page Radio book, with all information about learning Radio for bigger pay. I understand this places me under no obligation.

Name.....

Address.....

Town..... State.....

For Short-Wave Success

There's no bunk about tuning in G5SW of England, PCJ of Holland, and other overseas stations, right in your own neighborhood, day in and day out. Many radio fans are doing it, but—

Many have tried and failed. Perhaps you have. Why? The cause may be traced to crude regeneration control. Those weak, overseas signals thrive in the threshold oscillation zone—that point in regeneration just before the detector "spills over." Unless your regeneration slides gradually into oscillation, with a soft hiss and a gentle "pop," you won't get real distance in short-wave work.

Irrespective of what short-wave set you are using, it can be improved by means of the

CLAROSTAT

the micrometric resistance for every resistance requirement—micrometric regeneration, proper plate voltages, accurate grid bias, volume control, sensitivity control, and so on.

WRITE for data regarding the complete CLAROSTAT line and how to apply same for better radio results.

CLAROSTAT Mfg. CO., Inc.
Specialists in Radio Aids
281 North 6th Street
Brooklyn, New York

Explorer Eight Improvements

(Continued from page 268)

corporated in the receiver is capable of delivering an abundance of volume suitable for the ordinary home living room. There are those who, notwithstanding this fact, seek an audio channel which will deliver a much greater volume of distortionless reproduction so that it might be suitable for use in a theater auditorium or any other large place where perhaps the receiver is to be used for the reproduction of dance music, etc. To amply meet such requirements the description of a two-stage transformer-coupled audio channel, employing a pair of 250 power amplifier tubes arranged in push-pull in the final stage, is given here.

Fig. 7 shows the circuit diagram of a suitable 250 power amplifier and power supply. In general it closely duplicates the one described by James Millen, in last month's RADIO NEWS, the only difference being in the employment of some parts of other values. This amplifier may be built as a separate unit, the while maintaining in the receiver proper the resistance-coupled amplifier originally described. Then when it is desired to use the "250" a lead may be attached to the outside terminal of the r.f. choke coil attached to the plate of the detector tube, the first plate resistor removed from its mount, and perhaps the other audio tubes in the resistance amplifier removed from their sockets and the entire outfit, including the "250" amplifier, is ready to use.

It will be noted from this circuit diagram that in order to use the Electrad Truvolt Divider with the 250 power supply unit it is necessary to employ a series resistance unit of 8,000 ohms so as to obtain the proper intermediate voltages from the divider.

Tuned Antenna Stage Parts List

T1, Aero Coil, U4;
C1, Hammarlund Midline Condenser, .0005 mfd.;
R1, Yaxley Tapped Resistor, 25 ohms;
R2, Electrad Royalty Potentiometer, 100,000 ohms type B.
One Yaxley Four Point Inductance Switch, No. 44;
One National Illuminated Dial, type E.
Nine Binding Posts;
One Panel 7 inches by 10 inches;
One Baseboard 9 inches by 9 inches;

250 Power Amplifier Parts List

T1, National First Stage Audio Transformer;
T2, National Push-pull Input Transformer;
T3, National Push-pull Output Transformer;
T4, Silver Marshall Power Transformer, type 328;
L1, Silver Marshall Unichoke, No. 331;
C1, C2, C3, C4, C5, Dubilier Filter Condensers, 1 mfd., type 902;
C6, Dubilier B Block (3 sections of 2-4-12 mfd., type PL618);
R1, Electrad Wire Wound Resistance, 2,000 ohms;
R2, Electrad Wire Wound Truvolt Resistance, 750 ohms, type B.
R4, Electrad Truvolt Voltage Divider, (VD);
R5, Electrad Wire Wound Truvolt Resistance, 8,000 ohms, type D;
R3, Durham Grid Resistance, 50,000 ohms, with single resistor mount;
Four Silver Marshall Sockets, No. 511;
One Silver Marshall 277 Socket, No. 512;
One Triad -27 tube (first audio stage);
Two CeCo Rectifier Tubes (half wave);
One Baseboard 15 inches by 18 inches;
Four Binding Posts with mounting strips.

CORWICO

VULCAN

LIGHTNING ARRESTER

\$1



\$100 GUARANTEE AGAINST LIGHTNING DAMAGE ENCLOSED IN EACH BOX.
At your dealers or direct upon receipt of price.
CORNISH WIRE CO., 24 Church St., New York City

MAKERS OF
CORWICO BRAIDITE HOOK UP WIRE

Just Off the Press

A NEW YAXLEY

Catalog



Send for it today for complete listings of Radio Convenience Outlets, Connector Plugs, Rheostats, Fixed and Grid Resistances, Jacks, Jack Switches, Phone Plugs, etc.

YAXLEY MFG. CO.

Dept. N
9 So. Clinton St.,
Chicago, Ill.

STATEMENT OF OWNERSHIP

On April 15th, this publication was acquired by the Mackinnon-Fly Publications, Inc. This company is also the publisher of PLAIN TALK, SCREEN BOOK MAGAZINE, WILD WEST STORIES and COMPLETE NOVEL MAGAZINE, COMPLETE DETECTIVE NOVEL MAGAZINE, SCIENCE AND INVENTION, AMAZING STORIES, YOUR BODY QUARTERLY, AMAZING STORIES QUARTERLY, and AERO MECHANICS.

STATEMENT OF THE OWNERSHIP, MANAGEMENT, CIRCULATION, ETC., REQUIRED BY THE ACT OF CONGRESS OF AUGUST 24, 1912, of Science and Invention, published monthly at New York, N. Y., for April 1, 1929.

State of NEW YORK }
County of NEW YORK } ss.

Before me, a notary public in and for the State and county aforesaid, personally appeared Gustav Gardner, who, having been duly sworn according to law, deposes and says that he is an Assistant Vice-President of Irving Trust Company, owner, as Trustee in Bankruptcy of the Radio News and that the following is, to the best of his knowledge and belief, a true statement of the ownership, management (and if a daily paper, the circulation), etc., of the aforesaid publication for the date shown in the above caption, required by the Act of August 24, 1912, embodied in section 411, Postal Laws and Regulations, printed on the reverse of this form, to wit: 1. That the names and addresses of the publisher, editor, managing editor, and business managers are: Publisher, Irving Trust Company, as Trustee in Bankruptcy of Experimenter Publishing Company, 233 Broadway, N. Y. City; Editor, Arthur J. Lynch, 230

Fifth Ave., N. Y. City; Managing Editor, None; Business Managers, B. A. Mackinnon, 230 Fifth Ave., N. Y. City. 2. That the owner is: The Irving Trust Company, of 233 Broadway, New York City, as Trustee in Bankruptcy of said Experimenter Publishing Company, Inc., said Irving Trust Company having been duly appointed Receiver in Bankruptcy on February 20, 1929, and Trustee on March 28, 1929. 3. That the known bondholders, mortgages, or other security holders owning or holding 1 per cent or more of total amount of bonds, mortgages, or other securities are: None. 4. That the two paragraphs next above, giving the names of the owners, stockholders, and security holders, if any, contain not only the list of stockholders and security holders as they appear upon the books of the company but also, in cases where the stockholder or security holder appears upon the books of the company as trustee or in any other fiduciary relation, the name of the person or corporation for whom such trustee is acting, is given; also that the said two paragraphs contain statements embracing affiant's full knowledge and belief as to the circumstances and conditions under which stockholders and security holders who do not appear upon the books of the company as trustees, hold stock and securities in a capacity other than that of a bona fide owner; and this affiant has no reason to believe that any other person, association, or corporation has any interest direct or indirect in the said stock, bonds, or other securities than as so stated by him. 5. That the average number of copies of each issue of this publication sold or distributed through the mails or otherwise, to paid subscribers during the six months preceding the date shown above is (This information is required from daily publications only). Signed, Irving Trust Company, by G. Gardner, Assistant Vice-President. Sworn to and subscribed before me this 2nd day of April, 1929. (Seal.) Hiram S. Gans. (My commission expires March 30, 1930.)

(Continued from page 254)

To eliminate any danger of coupling of the audio-frequency circuit the grid circuits are suitably by-passed and fitted with filter resistors.

The complete circuit diagram is shown at the top of page 254, while the picture wiring diagram is shown directly below it. No involved construction is employed, the parts being simply arranged on a suitable baseboard of the dimensions specified. Connection from the amplifier to the batteries is obtained through the use of a cable with plug attachment. An input post and filament switch are mounted on a small panel at the left.

Tubes

There is a wide choice of tubes which may be used with this amplifier. They range from the dry-cell type to a pair of 171A's in the output or even the larger types of power amplifier tubes if they are desired. The writer favors the use of a 201A in the first audio stage and a pair of 112A's or 171A's in the parallel power amplifier stage.

PARTS LIST

- T1, T2—Silver-Marshall audio transformers, Nos. 225 and 226 respectively.
- TF—National tone filter.
- C1, C2—By-pass condensers, 1 mfd.
- R1—Amperite, type 1A.
- R2—Amperite, type 1A.
- R3—Amperite, type 1A.
- R4, R5—Durham grid resistors, 50,000 ohms.
- Two Durham single resistor mounts.
- One Yaxley battery switch, No. 10.
- One Yaxley connector cable and plug, No. 660.
- Three Silver-Marshall sockets, No. 511.
- One box Corwico braidite.
- One CeCo 1st-stage amplifier tube, type, AX
- Two CeCo 2nd-stage amplifier tubes, type J71A.
- One baseboard, 7/8 inch by 8 inches by 14 inches.
- One piece scrap panel material.

RADIO ARTICLES IN SEPTEMBER SCIENCE AND INVENTION

The Radio Robot—a most ingenious electrical and mechanical set and parts tester which has been developed by an associate of the U. S. Bureau of Standards.

Telephoning from Moving Trains—how passengers on the Canadian National Railways are enabled to talk with their home or office by a system of radio communication.

Super-directional Sound Beacons—and the part they play in aviation. Huge horns placed about the field are used for directing the landing of dirigibles in foggy weather or at night.

Television in Colors—Dr. Herbert E. Ives of the Bell Telephone Laboratories tells how this is accomplished in a fully illustrated account.

Men Who KNOW Voltage Controls Use ELECTRADS

RADIO engineers, manufacturers, experimenters, custom set-builders, use and endorse ELECTRAD Voltage Controls. They know that it isn't possible to get quality performance and long life from a resistance unless *quality is built into it.* And ELECTRAD'S manufacturing policy is a guarantee of that.

Not afraid to make the best—ELECTRAD, owing to mass production, purchasing and manufacturing economies, can yet sell its products at prices that will appeal to your pocket book.

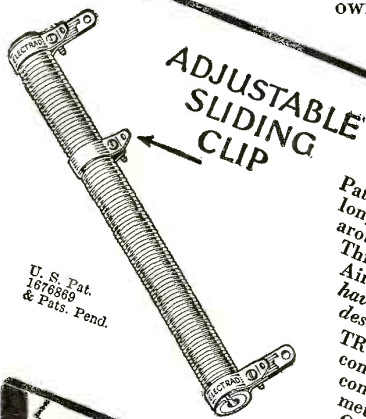

U. S. Pat. 1676869 & Pats. Pend.

TRUVOLTS
Safest for your Eliminator
Patented construction makes for greater accuracy and longer service. The resistance wire is first wound around asbestos over an enameled copper core. This is then wound around a grooved fire-clay base. Air-cooled—accurate. TRUVOLT Fixed Resistances have an adjustable sliding clip, quickly set for any desired voltage.
TRUVOLT Variable Resistances:—Same distinctive construction as the TRUVOLT Fixed Type, plus a convenient knob for fine adjustments. Perforated metal shield for ventilation and heat dissipation. One-hole panel mounting. Lasts longer than other type resistances owing to endwise travel of contact over wire. 22 stock sizes—\$2.50 each.

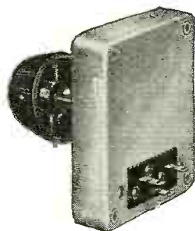

U. S. Pats. 1034103, 1034104 & Pats. Pending

Super -TONATROL
New in Design and Performance

A long-life volume control especially designed for high voltages. Easily dissipates 5-watts without breaking down or varying in value. The resistance element is fused to an enameled metal base. A pure silver floating contact operates with astonishing smoothness and improves with use. The metal cover aids rapid heat dissipation. Neat—compact—built TO LAST.

Seven types \$2.40 to \$3.50.

ROYALTY Variable High Resistances

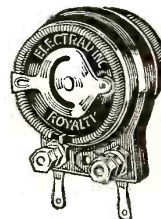

U. S. Pats. 1598658, 1034103, 1034104 & Pats. Pend.

Non-Inductive

Dependable long life and accuracy. Especially useful as voltage controls where low self-inductance is essential. Made with long-lasting resistance element, and finest insulating materials. Entire resistance range covered with one turn of the knob—the same resistance always found at the same setting. 11 types for every radio purpose—including potentiometer. \$1.50 and \$2.

ELECTRAD INC.

ELECTRAD INC., Dept. RN9, 175 Varick St., New York, N. Y.
Please send voltage control data.
Name.....
Address.....
City.....
State.....



New Detective Novels by Famous Authors 5 for \$1

Now just \$1 brings all 5 of these new book-length Detective Novels (shown above) in the new magazine cover form. The same stories that are being sold in the book shops for \$2 each—written by the most popular authors.

America's greatest leaders read these stories to stimulate and exercise their minds.

See if you can solve the strange episode of the Marsh Murder. See if you can find out how a great American detective outwitted England's famous Scotland Yard. See if you can discover who murdered the beautiful Chicago heiress, and why. Make a single \$1 fill your evenings with long hours of fascinating, inexpensive pleasure.

MONEY BACK IF NOT SATISFIED

Simply pin a dollar bill to the coupon—mail it to address given, and we'll send you post-paid all 5 novels complete. Write today.

Novel Magazine Corp.
381 Fourth Ave., Dept. 2409X
New York, N. Y.

Gentlemen:

I enclose \$1 to pay for the 5 novels shown above. It is understood that I can return them and get my money back if not perfectly satisfied.

NAME

STREET

CITY STATE

(Continued from page 256)
notes compiled by the experimenter. The enjoyment of a hobby usually comes not only from the results of experiments, but also from the formation and talking over of new ideas. Now that the idea has been presented why not go around to your dealer, have a talk with him, get started, and then watch the interest shown by your fellow fans.

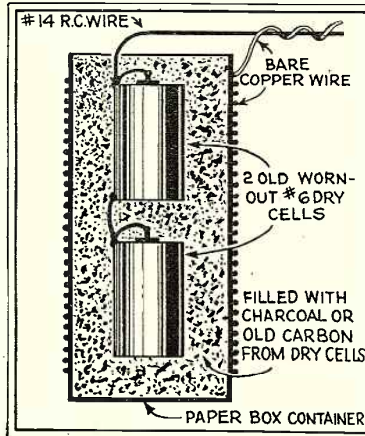

FIG. 7

Mr. O. P. Yurgae, of Milwaukee, Wis., has suggested an excellent idea for an underground antenna, which can be made at a price ridiculously low when results are considered. With the amount of static that arrives with every summer season Mr. Yurgae's contribution should be of special interest to the "DX Hound." In Fig. 7 is shown a cross-section of the underground antenna. Here the outside container is a paper box filled with charcoal or carbon, from old dry batteries. Placed upright end to end in the carbon are two worn out No. 6 dry cells; both the negative and positive poles are connected together with an antenna lead of No. 14 rubber-covered wire to the receiver. Around the paper carton is wound bare copper antenna wire as in Fig. 8, which also connects to the receiver as a ground lead. The underground antenna should be placed at least two or three feet in the ground.

Smoother Regeneration

An interesting experiment on regeneration comes from Mr. P. Graham, of Montreal, Que., here is what he says: "I have been experimenting with a regenerative circuit for some time, and would like to give to other readers of RADIO NEWS the benefit of an experiment in regeneration control which I hope they will find as useful as I have. The three tube set with which I have learned something of the difficulties of feed-back control is of the ordinary three circuit variety, the basis being an Eastern Standard coil and a fifteen plate variable condenser. The control is accomplished with a transformer secondary (audio) and a compression type variable resistor, variable between zero and one thousand ohms. The transformer secondary and the resistor are connected as shown in Fig. 9 in shunt across the antenna coil. At one particular adjustment of the resistance the movement of the condenser between minimum and maximum brings in the station whistles of WKBW of Buffalo with inter-

mediate stations to WEF of New York, with fairly equal intensity. By making a half turn adjustment of the resistor one way or the other the stations either side, of say KDKA of Pittsburgh, are brought in clearly depending whether the resistance across the choke is increased or decreased. Providing the detector voltage is kept at a rating of 12 to 25 volts, the tuning by condenser is fairly easy and so far it has not been necessary to use a grid leak. The regeneration coil is kept all the way in, all the time, and the variable resistor will by slight adjustment make resonance with the sending stations more definite and the signal reception clearer. Fading is seemingly not so much in evidence with the choke across the primary circuit, and slight variations in the broadcaster's wave are easily compensated for by a slight adjustment of the tuning capacity shunting the secondary. Regeneration howls from nearby receivers using regeneration do not make themselves heard to anything like the usual extent. A small adjustment of the tuning condenser and the resistor will take the receiver out of oscillation and give very clear loud speaker volume. The grid condenser should be of the molded type, a detector tube of the 200A type, and the usual audio amplifier. A .0005 to .001 condenser in series with the aerial

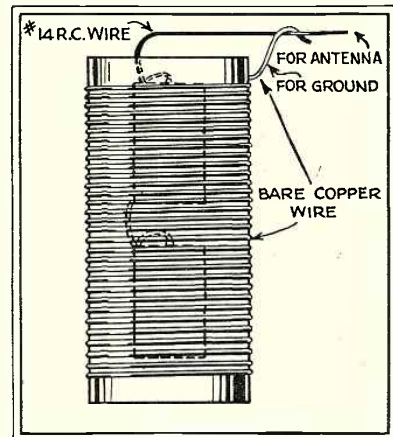

FIG. 8

is necessary; mine is a bank of three grid condensers of .00025 mfd. connected in parallel. With three tubes I have had on the speaker, New York City, Jersey City, Atlantic City, Rochester, Elgin, Buffalo, Baltimore, Cincinnati, Boston, Schenectady, Chicago, Nashville, Toronto, Ottawa and Quebec, and I think that with a small resistor that I am about to use will greatly simplify the tuning between 200 and 250 meters. Perhaps some of my brother experimenters who have more than one three circuit coil handy will try their luck with the resistor-choke across the primary, and compose a set having more than one stage of controlled regeneration in cascade, so that in the near future I hope to hear of experiments carried on with two or more stages. In which case I believe there will be no more 'Good Nights and Bad Nights!'"

Location

Mr. John Datko, Jr., of Youngstown, Ohio, writes: "I have heard and read so much about the merits of different localities for radio reception, that I would like

to say a few things myself. By all means locality is a lot. Have built dozens of sets, and none of them perk quite like the other fellow's. I always blamed it on myself, but not long ago a friend asked for a loan of set. The one loaned was a four-tube regenerative. Taking it home and hooking it up, the receiver worked like a million dollars. He picked up California, Florida, Texas, Maine and New Mexico the first night, and my antenna and ground system is at least 300% better than his. The power supply was batteries in both cases and the tubes were the same so that eliminates these two. Six hundred miles was distance to me. Therefore the trouble must be with locality, others must experience the same."

Mr. Datko has also constructed the RADIO NEWS Junk Box Short Wave re-

ceiver, but has not had much luck with distant reception. We know of one spot within twelve miles of the 50,000 watt transmitter of WEAJ where this station on the average receiver is just recognizable while moving the receiver one mile out from the base of the hill, WEAJ came in with broadcast that was really enjoyable. An underground antenna has in many cases worked wonders as well as changing the direction of the overhead antenna. A lot of trouble has been experienced by short-wave fans with a newly constructed short-wave receiver.—EDITOR.

Increasing R.F. Amplification

A number of experiments in radio frequency amplification have been carried on by readers of RADIO NEWS. Among these experimenters is Mr. A. Hochenberger, who has contributed some real data from

Fig. 9

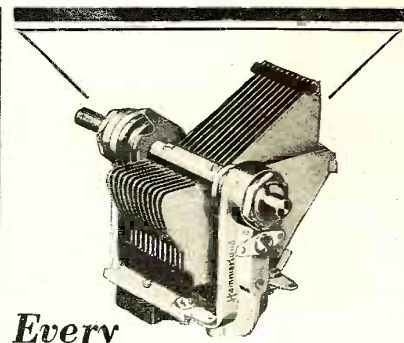
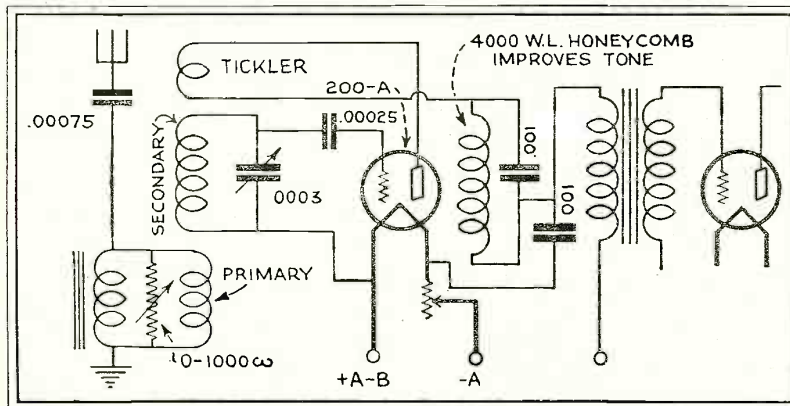

Every Detail a FEATURE!

THE Hammarlund "Midline" Condenser has soldered brass plates with tie-bars for permanent alignment; warpless die-cast aluminum frame; full-floating rotor with removable shaft; ball and cone bearings; bronze clockspring pigtail; minimum dielectric.

Add all of these distinctive qualities together with precision workmanship, and you have the world's finest capacity tuning unit.

Write Dept. RN9 for descriptive folder
HAMMARLUND MFG. CO.,
 424-438 W. 33rd St.,
 New York, N. Y.

For Better Radio
Hammarlund
 PRECISION
 PRODUCTS

**With an Audio-System really
 Designed for Short-Wave Work**

Operates from
 NATIONAL
 Velvet--B

Write us today
 for full details

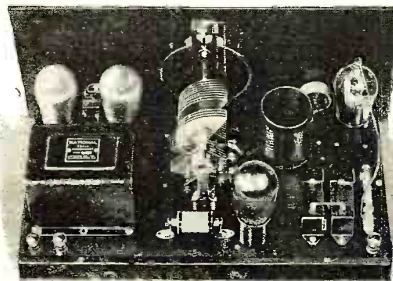

A special audio system has been built for this Double-Duty National THRILL BOX SW-4. It embodies new improvements on the former NATIONAL Impedaformers, permitting the use of a high-mu audio tube and giving a very high audio-gain. The two audio-units are placed in one case for compactness and to make wiring more simple. And the SW-4 is designed for stable and quiet operation with a 200-A detector—an added and unusual advantage.

Every other detail is just as carefully thought out. The SW-4 is not a copy—it bristles with new and ingenious details for your convenience and pleasure.

NATIONAL

4 Tube THRILL BOX SW-4

NATIONAL CO. INC., Malden, Mass.

Est. 1914

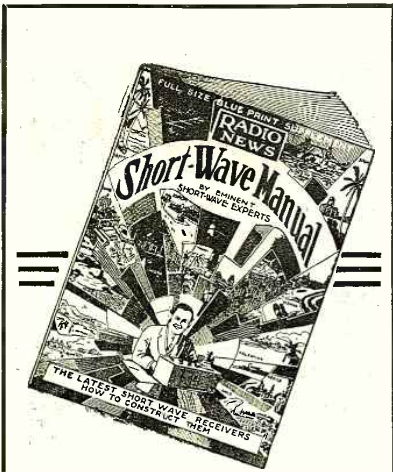

Complete Short-Wave Manual

Up-to-the-Minute Data—All Worth-While Circuits
FULL SIZE BLUEPRINTS

Some of the finest programs are being broadcast over the short-wave bands. There are many reasons for this. Paramount among them all is the fact that that entertainment, broadcast in this band, can be received over distances which with the ordinary broadcast receiver would be impossible!

Thousands of letters, which pour in an unremitting stream into our offices, tell the same tale—it is a common and everyday matter to receive programs from all foreign countries, from the most distant climes. England, France, Germany, towns on the African continent, from every conceivable corner of the globe where a station is located—programs come in with surprising volume and clarity. One would think they were hearing a New York, Chicago or San Francisco station until the voice of the announcer, many thousands of miles away, discloses the true location of station.

The SHORT-WAVE MANUAL tells plainly how to construct all these short-wave circuits, which our tireless laboratory researches have shown to be most efficient.

Large size book (same size as Radio News) with a beautiful colored cover. Replete with illustrations, diagrams and with FULL SIZE BLUEPRINTS. This big valuable book will show you how to receive all the foreign countries clearly and easily. Write today for your copy.

Clip and Mail This Coupon only 50c
the copy

EXPERIMENTER PUBLICATIONS, Inc.
Dept. 2409g, 381 Fourth Avenue, New York

Gentlemen:

Enclosed find 50c for which please send me a copy of THE SHORT-WAVE MANUAL.

Name

Address

City State

his notebook. It is a well-known fact that with radio-frequency amplification we do not obtain the full value of the tube, due partly to the fact that inefficient circuits, neutralization or grid suppressors are employed to prevent oscillation, all this, of course, decreasing the efficiency of a receiver. The one effective form of radio amplification may be obtained by using the autotransformer. There are several kinds of autotransformers, these having been described in past issues of

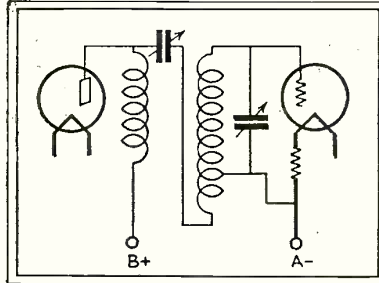

FIG. 10

RADIO NEWS as well as having been incorporated in some kit receivers. However, they are all hampered by the above mentioned faults, more or less. Then there is the ever present fact that the impedance of the plate circuit is much too low to be effective. The circuits to be discussed are designed to effect a remedy to some extent. The circuit shown in Fig. 10 proved very efficient; a modification appears as Fig. 11 and Fig. 12, and is

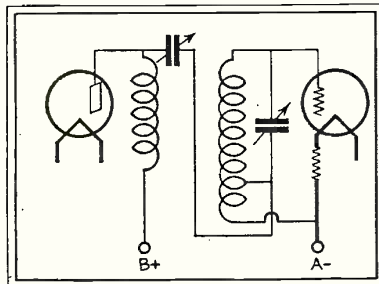

FIG. 11

adaptable where multiple-gang or tandem condensers are used, where all the rotors are electrically connected to each other as in Fig. 13. As it will be seen the transformer is not directly connected to the plate and "B" supply, but to a choke and condenser filter, receiving the a.c. component of the current. It is of importance that the inductance of the r.f.

choke be of sufficient value; the ordinary 85, or 125 microhenry type being totally inefficient—the tube having no chance to operate at its highest efficiency unless the impedance of the "plate to 'B' circuit" is of at least twice the impedance of that of the tube. Since the latter is about 8,000 ohms, then the impedance of the choke has to be about 16,000 ohms for the lowest frequency. According to the standard formula

$$L = \frac{XL}{2\pi F} \text{ which equals } \frac{16,000}{2\pi \times 550,000}$$

or .0046 henries, being the equivalent, to about 5 milhenries, in order to cover the highest broadcast wavelengths. Being unable to find such a choke on the market, it was necessary for the writer to build one for himself. Here the winding data which follows was employed. These chokes shown in Fig. 13 as L4 and L5 are made on a small bobbin having a spindle of 1/2" and a winding space of 1/2". On this are wound 1,200 turns of No. 36 enameled wire. The scramble fashion of winding should be employed, thus avoiding excessive capacity. Either

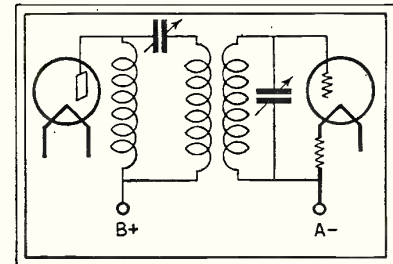

FIG. 12

the popular battery-operated 01A or the 26 a.c. tubes will work admirably with this type of choke.

The experimenter will do well to follow the specifications for the autotransformer coils, L1, L2 and L3 for his first set of coils, and then later may use his own favorite style. These inductances are wound on a 2 1/2" diameter bakelite form, 3" long and with No. 26 d.c.c. wire, L1 having 75 turns with a tap at the 65th turn, L2 and L3 each having 80 turns and also tapped at the 65th turn. This arrangement allows a primary of 10 turns on L1 and primaries of 15 turns on L2 and L3. For this type of inductance a tuning condenser of .00035 mfd. is required. The condensers C4 and C5 in Fig. 13 may be the variometer G10, made by the X-L Radio Laboratories, of Chicago, Illi-

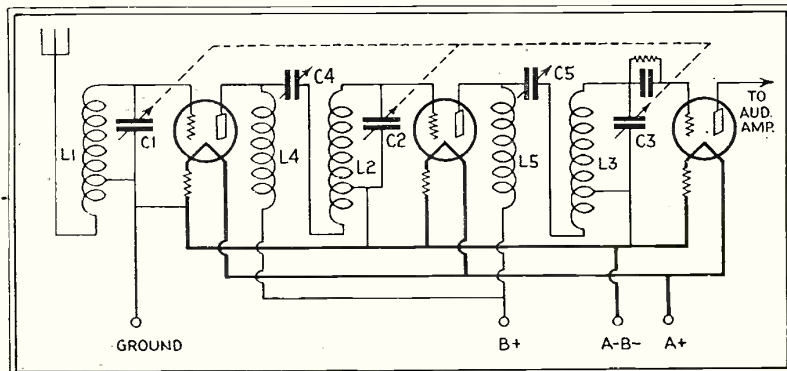

FIG. 13

nois, or may be constructed by the experimenter himself. If the latter is the case, each condenser will require two pieces of bakelite panel $1\frac{1}{2}$ " by $2\frac{1}{2}$ ", as shown in Fig. 14. About $\frac{1}{4}$ " from each end with both bakelite panels clamped together, drill a hole for a $\frac{6}{32}$ " screw. The bakelite panel which is to serve as the top piece for the condenser has a hole drilled in its center large enough for a threaded bushing. Four sheets of shim brass $1\frac{1}{4}$ " by $1\frac{3}{4}$ " are drilled $\frac{1}{4}$ " from one end and are mounted on the bottom bakelite panel alternately

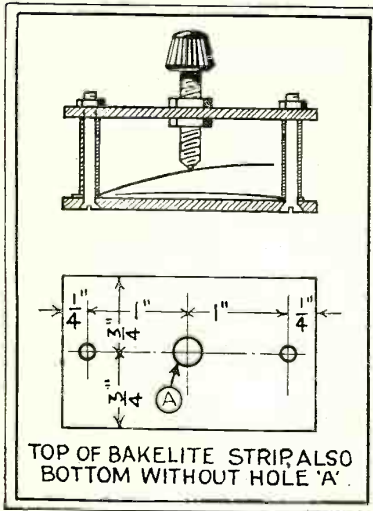

Fig. 14

with thin mica sheets, 2" by $1\frac{1}{2}$ " between as insulation. These shim brass sheets are fastened electrically to the mounting screws holding the top and bottom bakelite panels together. The top bakelite panel is spaced with either nuts or washers, $\frac{1}{2}$ " above the bottom panel, so that the screw which has been inserted in threaded bushing may be lowered or raised, varying the capacity of the shim brass condenser plates. Care should be taken to spring these shim brass plates so as to cause them to bend upwards from about $\frac{1}{2}$ " from the edge which has already been electrically connected to the mounting screw. A condenser of this type will have a maximum capacity of about .001 mfd. with a minimum in the neighborhood of .0005 mfd. Other ideas along this same method may be used, such as in Fig. 15, where C6 will have a capacity of .0001 or less.

A Novel Panel Cutter

"A number of experimenters," says Mr. L. F. Leucke, of Lincoln, Nebraska, "in absence of a regular panel cutter employ the usual method of drilling a number of small holes and filing to make a hole large

Fig. 15

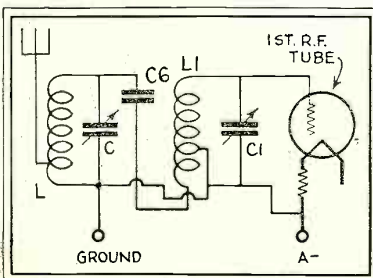

New England Mills Bargain Radio Catalog is Ready!



free
send for it
TODAY

for
RADIO DEALERS SET BUILDERS AGENTS & SERVICE MEN

NEW England Mills offers everything in radio at wholesale prices that spell real savings! That's what you will find in this great catalog just off the press, featuring Radio's newest creations in sets, kits, parts and supplies. Everything in our catalog is backed by the guarantee of this old, stable concern and its vast resources, accumulated through 17 years of faithful service to its customers.

Why Our Prices are Low

We are one of the largest outlets by mail to the trade. Our connections with many of America's leading factories enables us to buy on our own terms. Our cash resources makes it possible to command the very lowest prices from manufacturers — in most cases merely a small margin above the actual manufacturing cost — and frequently at lower than cost. This in turn is reflected in the net wholesale prices we show in our catalog. We give our customers the benefit of our vast purchasing power.

All Radio Dealers Save Money

by trading with New England Mills. This saving applies to complete radio sets of every description, dynamic and magnetic speakers, A. C. and all other types of tubes, eliminators, batteries, radio cabinets — in fact, everything required by dealers for resale or servicing. Every dealer knows that by buying right he is in position to sell at prices that meet all kinds of competition, thereby increasing his profits and good-will.

SET BUILDERS AND REPAIR MEN!

A tremendous amount of business will be done this season in rebuilding sets which users want to keep, and by modernizing old models. Our catalog contains everything required for this work. Besides, we have a supply of the latest models of nationally renowned kits — either knocked down or completely assembled chassis ready to install in table or console cabinets, all at wholesale prices that permit of excellent profits to you.

Catalog also contains complete lines of electrical goods, tires, tubes, and auto supplies. All kinds of sporting goods and hundreds of other items at wholesale prices

A. C. Electric Radios

Our new catalog contains a large selection of the finest A. C. Electric, 6, 7, 8 and 9 tube chassis and complete sets obtainable at the amazingly low prices we quote. Every modern radio improvement is embodied in these marvelous electric radios. All are sold by us with the guarantee of satisfaction backed by this 17 year old institution.

BATTERY SETS FOR UNWIRED HOMES

The vast number of rural communities with homes that are not wired for electric radios offer a tremendous market for battery sets, repairs and replacements. We have not overlooked this important field, as evidenced by the large stock of batteries, eliminators, speakers, tubes, transformers, coils, and all kinds of accessories needed for battery sets. These supplies include some of the best known nationally advertised goods, such as Cunningham, Sonatron and Arcturus tubes, Burgess batteries, Jewel instruments, Belden Products, Utah, Temple, Farrand and other popular dynamic and magnetic speakers.

Send for Free Book — NOW!

Radio dealers, agents, set builders, service men, etc., cannot afford to be without the New England Mills catalog. It contains everything you need for a more profitable radio business. We maintain a complete radio service department, supervised by expert radio engineers who will help you with all your radio problems. All goods catalogued are stocked for immediate shipment. Write for this book today. It's FREE! Send request on your business stationery.

NEW ENGLAND MILLS COMPANY 851 WASHINGTON BLVD. DEPT. 10 CHICAGO, ILL.

A Tube NECESSITY - Not an Extra

There is no choice. You must use Amperite to automatically control variations in the "A" current supply to your tubes. A type for every tube — A. C. or D. C. \$1.10 with mounting (in U. S. A.) at all dealers.

Radiall Company
561 BROADWAY, NEW YORK
Write Dept. RN-9

FREE "Amperite Blue Book" of modern circuits and valuable construction data.



AMPERITE
The "SELF-ADJUSTING" Rheostat.

Latest Radio Guide FREE - Send for it now

Big Radio Guide shows how to assemble short wave, television and other radio apparatus, kits, sets, etc., for best results at startlingly low cost. Tells how A-C Screen Grid works. Shows you latest radio wrinkles — how to save money on tubes, supplies, etc. High Quality complete sets at wholesale prices. You need this book. Send for it NOW. It is free.



Barwik Co. 29-C Canal Sta., Chicago, U. S. A.

Name
Address
City State.....

MAIL THIS COUPON FOR FREE COPY

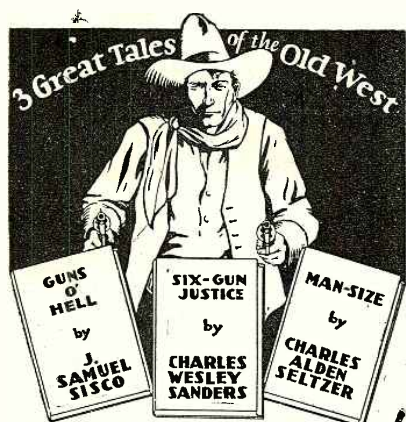

All 3 for 50¢
Complete New Novels
by 3 Famous Authors

Real he-man stories, these! New Stories of the West of Old—when guns flamed and the covered wagon was a familiar sight. Now a half-dollar brings you all 3 novels in magazine form (shown above). Each written by a famous author of Western Tales—J. Samuel Sisco, Charles Alden Seltzer, and Charles Wesley Sanders.

Men Who Made History!

Meet young Benson, that fighting fool who enjoyed bucking odds with his gun. Hit the trails of gold with Dutch Schultz, happy-go-lucky adventurer of the mining camps. Meet Parson Bill, that strange combination of preacher and fighter, who could handle a gun with the best of them. Meet them all—reckless, fighting, romantic adventurers. They wait to give you many an hour's reading joy within the pages of these 3 great novels.

These Same Novels Would Ordinarily Cost You \$6.00

if you bought them in the book stores. By printing in magazine cover style we save you 11 times what they cost you. Imagine paying only 50c for 3 complete \$2 novels.

Mail This Coupon Today Send for them by enclosing 50c with the coupon below, and we will forward all 3 novels by return mail. Do it now, while they last.

NOVEL MAGAZINE CORPORATION
 Dept. 2409Z, 381 Fourth Ave., New York, N. Y.

Gentlemen:

Please send me the 3 complete novels, GUNS O' HELL, SIX-GUN JUSTICE and MAN-SIZE. I enclose 50c (in stamps or coin) to pay for them.

Name

Street

City State

enough for the average present-day drum dial. Aside from the unnecessary labor and time, this method requires, it is still very unsatisfactory, as it is almost impossible to obtain as a final result a neat finished appearing job. Using the method illustrated in Fig. 16, a clean cut hole

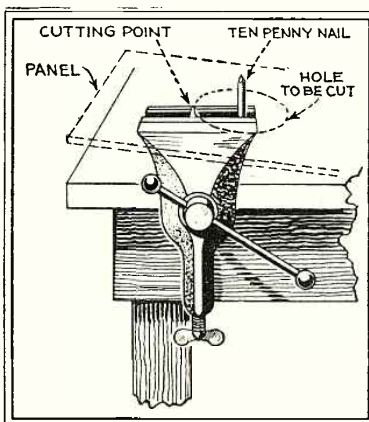

FIG. 16

of any desired size can be made, even soft metal such as copper and aluminum are easy to work. First a ten-penny nail is placed in a vise projecting about an inch above and near one end of the vise jaws. A second nail or, better still, a piece of harder steel pointed, of the same diameter as the first nail, is placed about 1/8 of an inch above the jaw of the vise and at the radius of the desired hole. A hole just the size of the first ten-penny nail is drilled in the exact center of the proposed hole in the panel material. Slip the panel over the nail, rotate the panel with the hands, keeping it parallel with the bench top, applying a light pressure against the cutting point. Work from both sides of the panel with a sharp hard point and a light pressure; results will be equal to those obtained with the regular circular cutter. In case the panel is mounted firmly in place, the cutting and centering points should be secured in the vise as before, the vise removed from the bench, taken to the panel and revolved. This, however, is nowhere near as easy as the former method and need only be used as a last resort.

On Short Waves

(Continued from page 260)

has a new name for the *Junk Box Short-Wave Receiver*. His letter continues, "I constructed the 'Wonder Box' (Junk Box), but departed somewhat from the instructions, using two .00014-mfd. variable condensers and made coils from

distance on the usual short-wave set. Many short-wave set owners have been disappointed in being unable to receive more than just a few American short-wave stations, and have begun to wonder whether it is all the bunk about others receiving Siberia, Java, England, Holland, Germany and so on. Bunk nothing. However, the usual blacksmith methods of the present high-power broadcast reception do not make a go of it in the short-wave band. To tune in G5SW, the British Broadcasting Corporation's experimental station at Chelmsford, England, which is now on the air every day except Saturdays and Sundays, from 7:30 till 8:30 A. M. (Eastern Standard Time) and from 2:00 P. M. till 7:00 P. M., also from 7:00 till 9:00 P. M. on Mondays and Wednesdays, requires the greatest care. The signals on this side of the water are exceedingly sharp, and may be missed time and again even with careful search. The main consideration is accurately controlled regeneration. Receivers using step-by-step high resistances that "plop" suddenly into regeneration, are hardly capable of tuning in weak short-wave signals with their modulation. Gradual regeneration is essential, such as that obtainable with a variable condenser for the regeneration control, or a stepless variable resistance. A variable resistance when used as a control of this type connected in the "B" plus detector lead, may well take the form of the compression

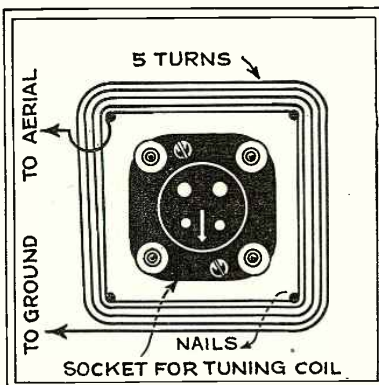
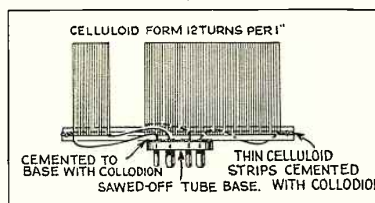

FIG. 11

some old inductances I had on hand. These were space wound on thin celluloid forms, twelve turns to the inch. After cutting to the proper size, the coils were mounted on sawed-off tube bases as in Fig. 12. With two stages of audio amplification I have had excellent results on the loud speaker from KDKA, WGY, CJRX and KGO, with more than thirty amateur short-wave phone stations. The loud amateur is W8AID, who is located in Utica, Mich. The set is truly a 'Wonder Box,' and I am considering adding a push-pull stage as well as a stage of screen-grid r.f. amplification."

Short-wave signals, unlike broadcast signals, are exceedingly sharp. The slightest movement of the tuning dial causes distant signals to come in or pass out. For this reason, it requires no end of patience and care and skill to tune in real

FIG. 12



type such as a clarostat. The regeneration must be accurately handled, sometimes utilizing the zero beat method, working in the "trough" between the squeals, on exceptionally weak signals. There's plenty of fun and real sport for everyone in the high frequencies, but it takes, like fishing, lots of patience.

* * *

Mr. L. R. Greenman of Conneaut, Ohio, forwards some definite information on the short-wave transmitter of KGO of Oakland, Calif. The call letters are W6XXN, broadcasting on a wavelength of 23.34 meters, 5,000 watts, with a schedule from 12:30 to 4:00 P. M., Eastern Standard Time, on Tuesdays, Wednesdays and Fridays.

* * *

Mr. Clifford of Oneonta, N. Y., presents four authentic reports on short waves from G5SW and DHC. He also passes on some valuable information as follows: "In a two-page letter G5SW informs me that due to the thousands of requests for verifications, they are inaugurating a service in conjunction with the *World Radio*, a foreign and technical journal of the British Broadcasting Corporation, whose address is Savoy Hill, London, WC2. Service "A" is the printed verifications in the columns of the Journal. Service "B" is an individual service for which a charge of 6d (12c) per verification plus addressed envelope, so according to this in order to receive the benefit of what B. B. C. refers to as service "A" one will have to obtain copies of the *World Radio* in order to see if the reported reception is verified. The B. B. C. also state that for experimental purposes G5SW radiates the Daventry 5XX programs at the following times, 12:30 P. M. to 1:30 P. M. and 7:00 P. M. to midnight, except Saturdays and Sun-

days. On Tuesdays and Thursdays there is a late program of gramophone records till 2:00 A. M. These times, of course, refer to British Summer time or Greenwich Mean time, according to the season of the year. It should be noted that there are intervals between 9:00 P. M. and 9:15 P. M. for the transmission of the News Bulletin from Daventry 5XX. The verification from DHC is in the form of a large card bearing the following: 'Your letter rec'd May 13th/29 Experimental-Commercial station, DHC Nauen, 45 kilometers N.W. of Berlin; Input 15KW, aerial Hertz Beam. Wavelength 26.225 KC11, 440; times indeterminate. Sig Telefunken Gesellschaft für drahtlose Telegraphie. M.B.H. Dr. Bohn.'

* * *

Mr. Clifford continues by saying that the above station has its carrier on any day or evening for hours without a peep out of them. Usually phonograph records are transmitted Sundays after 9:00 P. M. (E. S. T.) The third confirmation is from PCJ, operating on 31.04 meters, located at Eindhoven, Holland. Last but not least was the verification from PHI, which was in the form of a letter, as follows: "We possess your esteemed letter of the 13th of February and we thank you very much for it, you give us a fine and interesting report. We are glad that the modulation was fine and we beg to ask you to write us again about the reception of PHI in America. You are the first listener in America who has written us; you know, we now give only experimental transmissions. We are very sorry we have not yet a regular schedule. We advise you to try to tune in our programs between one and four hours on Monday, Wednesday, Thursday and Fridays. Signed by N. V. Philips, Omrvep, Holland." Mr. Clifford picked up PHI on 16.88 meters.

Mr. R. M. Bell of Syracuse, N. Y., has on his log as a record 11,435 miles in reception from A6AG, Perth, Western Australia, at 41.7 meters. He also has verification from W6XXN, relaying KGO at 23 meters, 3LO, Melbourne, on 31.55 meters, CJRX on 25.58 meters and KDKA on 25.24 meters. Good reception is also received from PHI (old PHOHI).

* * *

Among a number of letters on short-wave broadcast is one from Mr. Robt. N. Vanderwarker of Taunton, Mass. "For the benefit of the short-wave radio fans I would like to submit the schedule of PCJ at Eindhoven, Holland, given in a letter I have just received from that station. Transmission now takes place on 31.4 meters. Thursday 18-20 and 2,300, Friday 0-3 and 18-20, and Saturday 0 to 6, all Greenwich Mean Time. Have not noticed any reports on reception of KGO on the short waves. I heard this station one Friday afternoon from 1 to 4 P. M. (E. S. T.) on about 22 meters. It was received very clear and loud on the loud speaker. KDKA also comes in here on 31 meters, though not very loud. I presume this is a harmonic of the 62-meter (Continued on page 278)

Installation of radio apparatus to establish direct radio-telegraph communication with Argentina has been approved by the Spanish Government, Commercial Attache Charles A. Livengood, Madrid, has reported to Washington.

Installation of the apparatus will be made by the Sociedad Anonina Radio-Argentina, to which the Government awarded the contract. The company must, under the contracting conditions, put the proposed service in operation within the period of one year.

RADIO DIRECTORY

RADIO NEWS DIRECTORY

The most complete catalog of AC sets, parts, accessories, etc. All nationally known at dealers' wholesale prices. **SAVE MONEY.** Write today for your **FREE** Catalog.

SHURE BROS. CO.
335 W. Madison St.
Dept. 316 Chicago, Ill.

200,000

RADIO NEWS readers carefully scan the RADIO DIRECTORY every month. Your product here, at the lowest cost in the world's largest and most widely read radio magazine.

RATE PER ISSUE—\$25.00

No order for less than three insertions accepted.

Write for Information

RADIO NEWS,
381 Fourth Avenue,
New York City

Electric Extension Cord Set. Instead of having numerous wires, trailing in an unsightly way to a baseboard outlet, the one connecting wire of the BIRNBACH ELECTRIC EXTENSION CORD SET puts three convenient outlets where you want them. At your dealer or send for catalog.

BIRNBACH RADIO CO.
254 West 31st St., New York City

An outside aerial that can be attached in 10 minutes — without climbing on the roof. Write today for details and price.

The Arc-Aerial, Inc.
Green Bay, Wisconsin

THE WORLD'S LEADING ELECTRIC PICK-UP
PACENT ELECTRIC CO., Inc.
91 Seventh Avenue, New York

The "Self-Supporting Resistor" A NEW standardized, Quality Resistor Unit far superior to previous types.

1.0 Watt and 2.0 Watt types, molded end caps, insulated base, tinned wire leads.

LYNCH, Inc. 1775 Broadway, New York

Send 25 cents cash or stamps for 64-page Power Amplifier Manual, describing all A. C. and D. C. amplifiers for all tubes. Including the new 245 tubes just out.

Name

Address

State

Rawner Radio Co.
142 Liberty St.
New York, N. Y.

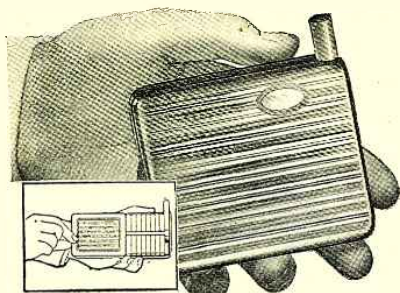

Save Cigarettes
- add to smoking enjoyment

WHENEVER YOU WANT the comfort and companionship of a good smoke, press the button on the EJECTOR and your favorite cigarette, like a welcoming hand, JUMPS OUT to meet you! Cigarettes are fresh and firm in this case.

No more fumbling for cigarettes—no more waste through crushing! Live dealers everywhere sell the strong, beautiful, modern EJECTOR. Satisfaction or money back.

Send \$1.50 for Model "C"

THE LYONS MFG. CO.

Dept. K Mt. Carmel, Conn.

EJECTOR
The Perfect One Hand
CIGARETTE CASE

SHORT WAVES

without the expense of a new set!

The **Submariner**

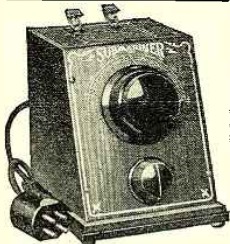

WILL CONVERT YOUR RADIO SET INTO AN EFFICIENT SHORT-WAVE RECEIVER

Simply remove a tube from the set and place it in the "Submariner," then insert plug from "Submariner" in the socket from which tube was taken, attach aerial and ground to clips of "Submariner." Write for our money-back guarantee. Enthusiastic owners have written us from all parts of the world. Stations 8,000 miles away have been received. Vernier dial 32 to 1 ratio. Users are getting foreign stations the year around. There is very little static and short waves carry a much greater distance.

FOUR MODELS

20 to 85 meters for battery tubes, \$15.00. For all electric, \$17.50. Interchangeable coil model, 10 to 160 meters, \$22.50, for A.C. or D.C. receiver. No. 4 coil, 160 to 340 meters, \$2.00 additional. In ordering, be sure and state name of set and the number on each tube. Ask your dealer for one. If he does not carry them, he will get one for you.

If you are unable to get one locally, it will be sent postpaid upon receipt of money order or certified check. Sent C.O.D. only if \$1.00 accompanies order. This is to insure carrying charges. Price in Canada and some other foreign countries, 60c. additional. Cannot be sent C.O.D. outside U. S. ORDER TO-DAY.

J.M.P. MANUFACTURING CO., Inc.
3413 Fond du Lac Ave. Milwaukee, Wis., U. S. A.

PLEASANT WORK ---
--- GOOD PAY



So says Mr. J. L. Phillips, "Y" graduate and radio operator, employed by the Munson S.S. Line. He is an officer of the ship, gets good pay, and enjoys his work.

Radio offers these opportunities to you too!

Write now for free booklet, "Opportunities in Radio"

West Side Y.M.C.A. Radio Institute
319 West 57th St., New York, N. Y.

station. On both their 62 and 26 meter wave-lengths a speaker is used, as is also the case with CJRX. This last mentioned station can be received any time they are on the air. Both ends of the transatlantic telephone are good, with the British end best around noon and the early afternoon. The reception from 5SW does not seem to be as good this summer as last, and no luck with Java, Australia and Central Europe stations. The present receiver consists of detector and two audio stages, connected with a twenty-foot fan antenna which seems to work better here than a single-wire type.

* * *

The "Junk Box Short-Wave Receiver," as described in the July, 1928, issue of RADIO NEWS has brought forward a tremendous amount of enthusiasm and a number of short-wave fans have incorporated ideas of their own. Here is the comment of Mr. Getchell of St. Stephen, New Brunswick, Canada: "I wish to thank you for your page for the short-wave enthusiast; to me it is the most interesting of the whole magazine, which is saying a lot. I have been using a three-tube short-wave set of my own make for about a year, but always had trouble in getting down below 30 meters. Recently I built another receiver patterned after the 'Junk Box,' using an old .00025 mfd. condenser cut down to five plates for the tuning capacity, and a 17-plate condenser for the regeneration control. This new set will without any difficulty work as low as 15 meters. My call list includes G5SW, PHI, PCJ, CJRX, W2XAF, 2XAD, W8XK, W6XN and others, all on a horn-type loud speaker with enough volume to fill a fair-sized room. Code and television signals roar in any time of the day or night. I don't see why anyone has trouble with this set. Have hooked up several for friends and each one works off the bat. Of course it must be remembered that the prime requisite in short waves is patience. One can not whirl the dials as in a broadcast receiver and expect to get signals at every point. Short-wave stations are farther apart, though in my own receiver I have no trouble in tuning even without a vernier dial."

* * *

A letter from Mr. Holmes of Christchurch, New Zealand: "I have noted with interest that in a recent issue of your magazine a correspondent states that he is not getting the very best results out of the Junk Box Receiver. This ingenious set was described in RADIO NEWS July, 1928, and I would like to tell you my experience with it—not as a proud owner anxious to tell the world in general, but in hopes that I may be able to persuade others to make this set which more than does what was originally claimed for it. I am in a position of having to study expenditure and am also not the world's most highly skilled technician. Therefore, when I saw the Junk Box described, it commended itself with its simplicity and low cost. Slavishly following the plan and instructions, I put it together one Saturday afternoon, had it going the same night and, to my delight, heard more than one of the local amateurs. With the kind assistance of one or two radio enthusiasts, the set was made to function perfectly. A week after it was

built, heard RFM, Siberia, with good phone volume and stations like 2ME, Sydney, on the loud speaker. Later another audio stage was added, so now the receiver has three valves, and the following overseas stations come in with loud speaker volume: Nauen, Germany; RFM, Russia; W2XG, New Jersey, U. S. A.; WX2AF, New York, U. S. A.; DOR, Germany; 2XAD, New York, U. S. A.; 5SW, Chelmsford, England; PCJ, Holland; VPD, Suva, Fiji; Drummondville, Canada, and one or two others. In all there are nearly forty phone stations on my log and a bucketful of code. Special mention must be made of KDKA's short-wave broadcasts to the members of the Byrd Expedition. On a number of Sundays the volume from this station is so good that it is 100% audible two rooms away and the same stupendous volume was obtained on KDKA's recent tests with 2ME, Sydney, when duplex telephony was engaged in. Sydney 2ME, by the way, is 1,200 miles from my home. My aerial is three lengths of wire totaling sixty feet, and only twenty-eight feet high at the highest end. The ground is only eighteen inches deep. My Junk Box cost me only £4 and I would not change it for a far more costly set.

* * *

Mr. C. Canolin of Dublin, Ireland, writes: "Being most interested in the science of wireless, I am a keen follower of your most valued RADIO NEWS. I am sure the following will be of interest to readers; this shows the enormous penetrating power of the short waves, also how little we yet know about their mystery through space.

"I built a three-valve set, with the tuning coil hermetically sealed, no frame aerial or ground wire whatsoever, yet on many occasions I have listened to stock exchange reports and dance music from your station at Pittsburgh and Schenectady. After 11:00 P. M. G. M. T. last night (June 7th) I heard PCJ, Holland, calling up the British colonies, India, America, and also the Amsterdam liner, this also without an aerial or ground connection, all as clear as crystal.

"I have carried the set outside the house to front and back gardens, and still these stations come in. This set is so small that the components are very nearly touching."

* * *

A splendid suggestion has been received from Mr. Sundwell of Mt. Morrison, Colo., for the RADIO NEWS Junk Box Short-Wave Receiver. Here is what Mr.

Fig. 13

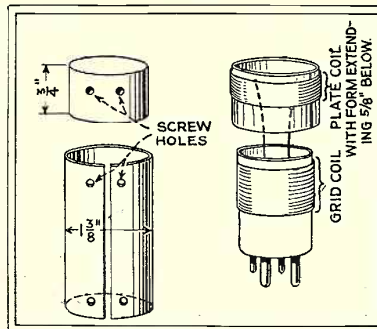

Sundwell writes: "No two tubes seem to function exactly alike as short-wave detectors, some going into regeneration or oscillation more readily than others. To offset this variation in tubes, I use a semi-variable tickler instead of the type suggested by Mr. Hertzberg in the July, 1928, RADIO NEWS. Only the secondary or grid coil is wound on the tube base, beginning $\frac{1}{8}$ " from the top. The tickler is wound on a celluloid tube $1\frac{3}{8}$ " in diameter, so as to slide telescope-wise over the grid coil. The coil form for the tickler tube is of $1\frac{3}{8}$ " bakelite with a strip $\frac{1}{8}$ " cut away, lengthwise, as shown in Fig. 13. Two wooden plugs are turned cut $\frac{3}{4}$ " thick and just small enough to slip inside of the bakelite tube. These plugs are inserted in the ends of the coil winding form and are held in place with two wood screws. A celluloid sheet is now wound around the form, allowed to overlap about $\frac{1}{4}$ ". The ends are moistened with acetone, held together till dry. Wind the required number of turns for the

tickler on this celluloid form, first using acetone sparingly, softening the celluloid surface, allowing the wire to become imbedded, preventing the turns from unraveling later. When dry the plugs can be removed, the bakelite form squeezed together, allowing the tickler to slip off. A razor blade is now brought into play and the celluloid is trimmed down so that about $\frac{5}{8}$ " of form is left below the winding as in Fig. 13. The wires are of course connected the same as if the secondary and tickler were on the same form. The correct spacing is easily taken care of by setting the wavelength and regeneration condensers at maximum, having the tickler coil about $\frac{1}{2}$ " above the grid coil. Then gently tap the tickler coil down with a pencil until the receiver barely oscillates. A drop of collodion put on with a toothpick at two or three points will hold it in position. By this method coils may be easily adjusted to any detector tube, and save the trouble of adding or removing tickler turns.

A Discussion of Coil Design

(Continued from page 266)

Because of the capacity of any coil, not only its "apparent" resistance but its "apparent" inductance are higher than they should be. Both increase as the frequency increases and the wavelength shortens—the resistance increasing faster than the capacity. For this reason, the coil above described will not tune down to anywhere near the low wave we would expect, if its inductance were constant, and the minimum capacity of the condenser were only 10 mmfd. or less.

At the point of "resonance" to which it is tuned, the apparent resistance of a coil-and-condenser combination is enormously high. We use such a combination, *in series* with our aerial as a *wavetrap*; so that an undesired signal will be blocked, instead of passing through it. On the other hand, in our receiver, we use it *in parallel* across the grid and filament of a tube; so that (as there is very little current passing between them through the tube—if it is an amplifier) a very high voltage builds up on the grid in comparison to the strength of the signal.

High-Frequency Resistance

In themselves, capacity and inductance do not produce a loss of electrical energy. They merely affect the distribution of electricity in a circuit. Resistance, however, is a source of loss wherever it is found.

The resistance which we find in an ordinary direct-current (or "zero-frequency") circuit is determined by the size of the wire used. A wire half as large (in cross-section) gives twice as much resistance to the flow of current. No. 20 wire has a cross-section only one-quarter that of No. 14 wire; therefore a length of No. 20 has four times as much resistance as a length of No. 14. The resistance of No. 40 is 416 times that of No. 14, foot for foot.

However, at radio frequencies this is no longer true. A coil of small wire may have very much less resistance than a coil of large wire.

If we wind a coil of No. 14 wire at, say, 14 turns to the inch, the wires are very close together, and present comparatively large surfaces to each other. If we use small wire on the same form, with the same number of turns, the wires are much further apart, and present very much smaller surfaces to introduce capacity. The capacity of the coil is therefore very much smaller.

In addition to this fact, the intense "flux" at the center of a radio-frequency coil drives the electric current out to the further edge of the wires, and thereby reduces the effective area of the wire in which it is able to circulate. This effect is found even in a single straight wire; because its self-inductance sets up an internal field which drives electrons out further and further from the center as the frequency increases. This so-called "skin-effect" is so pronounced that, on the short waves, a tube is often as good a conductor as a solid wire of the same diameter.

It Sounds Improbable

For instance, No. 18 wire has a direct-current resistance of one ohm for 157 feet. At 600,000 cycles (500 meters) it is 3.2 times as much, or one ohm for 49 feet. At 3,000,000 cycles (100 meters) it is 6.8 times as much, or one ohm for 23 feet; and the resistance keeps increasing as the frequency rises. (This is for straight wire, without considering the added effects of coil inductance.) At 30 meters the resistance of the No. 18 would be one ohm for 12.8 feet.

No. 28 wire is much smaller, and much more highly resistant to direct current; one ohm for each 15.4 feet. But its resistance increases very little with frequencies up to 3,000,000 cycles—about 2.5%. And, at 30 meters, the resistance of the No. 28 is only up about 23 per cent, or one ohm for 12.5 feet—about that of the No. 18. And below 30 meters, the No. 28 will have *actually less resistance than the larger wire.*

(Continued on page 281)

KEEP PACE WITH THE NEWEST! EVEREADY RAYTHEON TUBES FOR TELEVISION AND TALKING PICTURES

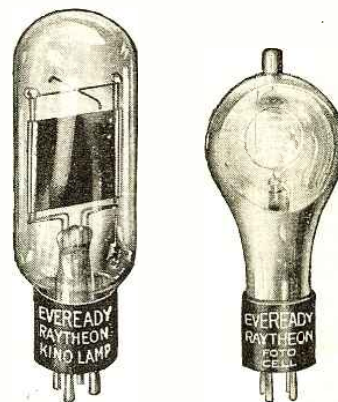

Eveready Raytheon
Kino-Lamp

Eveready Raytheon
Foto-Cell

ARE OF PROVED DEPENDABILITY AND PERFORMANCE

THE Eveready Raytheon Kino-Lamp for television reception is the first tube developed commercially which will work with all systems.

With its uniform glow over the entire plate . . . tested performance . . . long life . . . perfect reproductive qualities . . . the Eveready Raytheon Kino-Lamp is a great step forward in television.

The Eveready Raytheon Foto-Cell is a long-life transmitting tube for television. Used also for talking pictures. Made in two sizes, either hard vacuum or extra-sensitive gas-filled.

Correspondence is invited from everyone interested in television. Foto-Cells to special specifications will be made at reasonable prices.

NATIONAL CARBON CO., INC.
General Offices: New York, N. Y.

Unit of
Union Carbide  and Carbon
Corporation



A Chuckle Each Day

When things seem blue—and you can't help feeling that you are up to your neck in trouble, *smile*—and *smile some more!* Remember, it's the fellow with the happy face who gets the job—and here are a couple of handy helpers that will take your mind off your troubles and teach you to *smile*.

"COOKOO NUTS"

See what you can do with this fascinating new game. It's a test of your ability to think fast and correctly. Play it with friends or alone. Excellent for a party game. Price complete only 25c.

"S'MATTER POP"

Everybody knows C. M. Payne, the famous cartoonist and originator of S'Matter, Pop. Here is his own book full of comics—selected for their ability to provide a healthy chuckle a page. Great to read to the kiddies. Price complete only 25c.

Write Dept. 2509i
Experimenter Publications, Inc.
381 Fourth Ave., New York

On the Road to Big Pay!

Suppressing Oscillations

(Continued from page 235)

suppressor, introducing a loss.

It is easily seen, then, that this current will be larger when the tuning condenser is set at a low value; that is, on the shorter wavelengths; while the loss introduced by the grid suppressor will be much less on the longer waves when the tuning condenser is set at a large value, so that almost none of the r.f. current built up in the tuned circuit passes through the input tube capacity and consequently through the grid resistance.

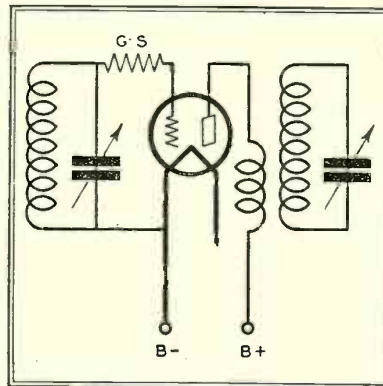
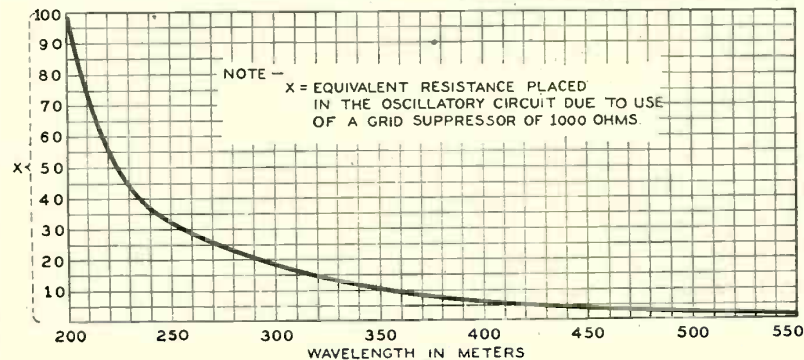

FIG. 4 SHOWS A RESISTANCE IN SERIES WITH THE GRID OF THE RADIO-FREQUENCY AMPLIFIER TUBE FOR THE PURPOSE OF SUPPRESSING OSCILLATIONS DUE TO A FEEDBACK OF CURRENT THROUGH THE PLATE-GRID CAPACITY OF THE TUBE

Fig. 5 shows the theoretical and experimental proof of this statement. The input capacity of the vacuum tube used as a radio-frequency amplifier was of the order of 15 mmfd. and with a maximum



of 400 mmfd. The grid suppressor was 1,000 ohms, which in the case of the circuit shown in Fig. 1, was just sufficient to keep oscillations from being produced. Measurements were made of the amount of resistance introduced in series with the coil and condenser by the use of the grid suppressor. It will be noted that at 200 meters the equivalent resistance equalled about 97 ohms, while at 550 meters only .89 of an ohm was introduced. Calculated values were so slightly different that the two curves would fall almost on top of each other. It was experimentally determined that practically the same amount of amplification could be obtained by placing a series resistance in circuit one and varying its value until that circuit was just on the point of oscillating.

The grid suppression method, moreover, has the advantage of allowing a ganged condenser to be lined up accurately and the alignment will be found correct whether a large or small grid suppressor is used.

This discussion, however, does not apply to any tuned radio-frequency amplifier system where a regenerative detector is used, for in this case some system of neutralization is essential for best results. Neither does it apply when there is a magnetic feedback from one coil to another.

The thought has occurred to the writers that some such system based upon a similar combination of resistances and capacities, would be an excellent method of keeping amplification in a radio receiver absolutely constant over the wave band, no matter what type of tubes were employed.

FIG. 5. A CURVE TENDING TO BEAR OUT THE CONCLUSIONS OF THE AUTHORS, AND EXPLAINED IN DETAIL IN THE TEXT

President Not to Interfere in Radio Situation

PRESIDENT HOOVER has no intention of taking a hand in the radio situation, which he is represented as believing is being dealt with satisfactorily by the Federal Radio Commission.

Refusal of the Federal Radio Commission to grant the application of station WCFL, operated by the Chicago Federation of Labor, for an exclusive channel, was carried to the White House recently by William Green, president of the American Federation of Labor, and John H. Walker, president of the Illinois Federation of Labor, who laid their plea before the President. The President, Mr. Green said, indicated his sympathy with the plight of the station but explained that

the problem was one to be handled by the Federal Radio Commission.

The refusal of President Hoover to interfere with the activities of the Radio Commission is in line with his views expressed when he was Secretary of Commerce urging the creation of such a commission. At that time he pointed out that a body should be created which would have exclusive control of the radio situation, with a view to clearing up the chaos which then existed. It has been his consistent policy to maintain a hands-off attitude with respect to the activities of the various branches of the Federal Government, so long as they were being conducted properly.

(Continued from page 279)

These peculiarities of the radio-frequency inductance coil make the history of its development rather interesting. A good many experiments have been made in the hope of dodging the effects of coil capacity and high-frequency resistance. However, they seem quite as inexorable as that other ill-omened pair, death and taxes.

Large coils have been wound to give wide-space turns and get away from capacity; small coils have been wound with fine wire to get away from "skin effect." Coils have been wound to every conceivable pattern in the hope of reducing the

size of their magnetic field.

"Toroids" and "binoculars" have been made, so that the magnetic field will narrow itself and reduce the effect on other apparatus in the receiver. "Spider-web" and "basket-weave" coils have been made, to eliminate the necessity of a supporting form and reduce capacity by crossing the wires at an angle. Space-wound coils are in some ways more desirable; but if we increase the spacing too much, we need more wire and this increases the resistance. Then, too, we lengthen the coil greatly; while the demand is now for small coils to be put in shield cans with room to spare.

Reminiscences of a Radio Pioneer

(Continued from page 233)

Three years later these engineers, using audions as repeaters or voice relays, established a transcontinental service from New York to San Francisco. In the same year, 1915, the Bell System engineers conducted successful radio telephone experiments between the United States and France, and also to Hawaii, again using my audions, this time as oscillators quite as well as amplifiers.

In 1915 I was working on amplifiers.

recording studio. Three afternoons each week the Columbia records were placed on the air, for any and all who might care to tune in.

A little later, we had a transmitter at our High Bridge plant, and went on the air with a nightly broadcasting service consisting mostly of new phonograph records. Between records, we announced the products of our company, with special emphasis on radio parts for the improve-

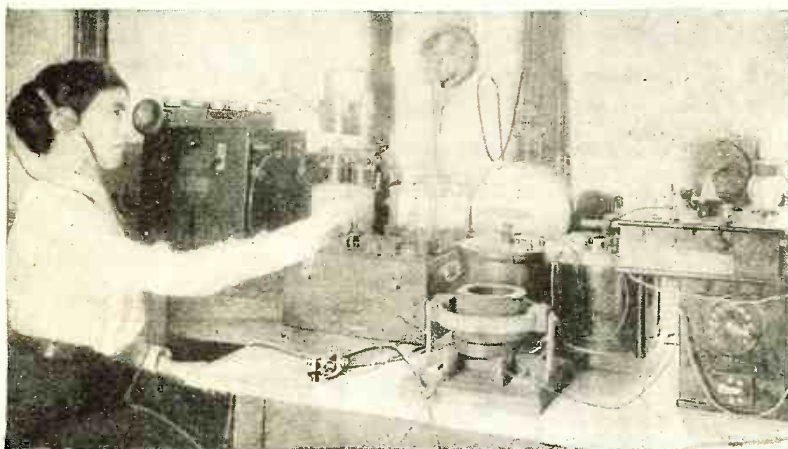

A GIRL OPERATOR USING THE WIRELESS PHONE BETWEEN NEW YORK AND NEWARK, BACK IN 1908

ment of the sets of those who listened in. Our operators in these broadcasts were engineers and other members of the organization drafted for the overtime work. I say "drafted," because broadcasting was not considered any thrilling privilege or honor by those who had to stay overtime. Microphone worship was still unknown.

We made our first broadcast of election returns in 1916—those of the Hughes-Wilson balloting. The *New York American* ran wire lines into our office so that we might have last-minute reports. I served as one of the announcers. We signed off that night at 11 o'clock, with the parting news to our listeners that Hughes had won the election. The next morning we learned of our slight mistake. Wilson, not Hughes, had been elected. However, in making the error we were in good company; many newspapers had done the same, in the hurry of serving

ment of the sets of those who listened in. Our operators in these broadcasts were engineers and other members of the organization drafted for the overtime work. I say "drafted," because broadcasting was not considered any thrilling privilege or honor by those who had to stay overtime. Microphone worship was still unknown.

We made our first broadcast of election returns in 1916—those of the Hughes-Wilson balloting. The *New York American* ran wire lines into our office so that we might have last-minute reports. I served as one of the announcers. We signed off that night at 11 o'clock, with the parting news to our listeners that Hughes had won the election. The next morning we learned of our slight mistake. Wilson, not Hughes, had been elected. However, in making the error we were in good company; many newspapers had done the same, in the hurry of serving

There's No Monopoly of the Dictionary

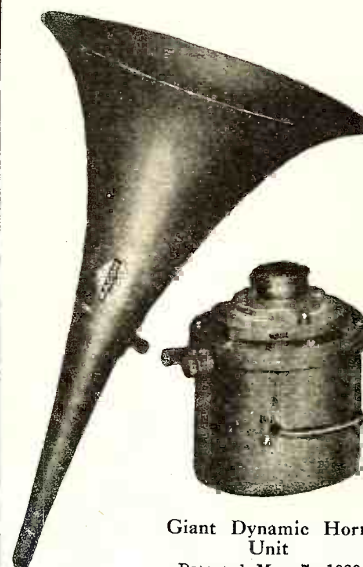

Giant Dynamic Horn Unit
Patented May 7, 1929

RACON HORNS

Racon is the ORIGINATOR in design for public address horns for general commercial use. Do not be misled by ads claiming originality and pioneering.

Anyone can borrow words from the dictionary. No law against it—there is against basic patent infringement. And Racon is amply protected against copyists. To get the original and best you must install Racon Horns—the great reproducers of famous orchestras and public speakers.

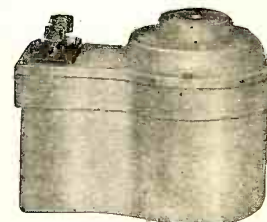

RACON ELECTRIC CO., INC.

Factories:
18 Washington Place, New York
Slough, Bucks, England, and 3 Mutual
Street, Toronto, Canada

**FREE
TO BOYS**

*Become a Member
of the
JUNIOR RADIO
GUILD
and Receive Your
Introductory Lesson FREE!*

In just a few short weeks you can build your own radio set, make sets for your friends at a big profit, and in time become an authority on radio for your whole neighborhood.

It's lots of fun, too, when you learn through the Junior Radio Guild, because you actually build sets as you learn. And there is practically no hard study, because we tell you all about radio in simple, easy, understandable words.

Over 12,000 boys are already members of this great organization which is now sponsored by RADIO NEWS, and they have told so many of their friends about what wonders it has done for them, that membership is increasing rapidly.

All you have to do to become a member of the Junior Radio Guild, absolutely FREE, is to mail us the coupon below. The 25c we ask for is merely to cover the cost of the beautiful bronze membership pin and your membership card. You receive your introductory lesson absolutely FREE!

**MAIL THIS COUPON
TODAY!**

JUNIOR RADIO GUILD, Dept 2409-U
381 Fourth Avenue, New York, N. Y.

Gentlemen:

Please enroll me as a member of the JUNIOR RADIO GUILD. I enclose 25c (coin or stamps) to cover the cost of my membership pin and membership card. I also understand that I will get the introductory lesson in Radio Instruction for Boys FREE by return mail.

Name

Address

City State

news red hot before getting confirmation.

Then came the interlude of the War. After that, in 1919, we resumed our broadcasting from High Bridge, but shortly after, moved to Times Square, where we shade a lofty antenna with Emil J. Simon, who was attempting an inter-city telegraph service. Vaughn de Leath, that delightful radio personality known as The Radio Girl, was one of our first microphone stars.

Just as we were getting on our feet after a period of silence imposed by the War, the radio inspector of our district suddenly awakened to the fact that we, in broadcasting our radio concerts, were taking up too much room on the air, and that, furthermore, we had sinned in moving our transmitter without proper legal formalities. Furthermore, the space we occupied was badly needed for dot-dash communications. Our's was a foolish experiment. Our station was ordered off the air. My broadcasting in the East was over.

I went to San Francisco, hoping that there the powers that be in radio might be less offended by our well-intentioned efforts. I erected an antenna from the top of the Humboldt Bank Building to the roof of the California Theatre. By suspending my microphones over the orchestra in the flies, I secured the theatre music every afternoon and a symphonic concert on Sunday. We were quite successful. Our broadcasts were received as far east as St. Paul, and by ships on the Pacific a day out from Honolulu.

Together with my own broadcasting, I furnished several pioneer broadcasters with equipments, among whom was the *Detroit News*, the first newspaper to go on the air.

And so, at last, broadcasting was becoming known. It grew amazingly, once the large organizations with ample capital took hold of it. When Station KDKA of the Westinghouse Company went on the air with its first radio broadcast schedule, radio broadcasting was to me an old and familiar story. So I gave up my own efforts, feeling that with the true pioneering work at an end, the building up of this technique and institution might better be left in the hands of those with greater capital, influence and personnel to carry on.

Once more I turned to pioneering, this time the talking movies. I had long realized the drawbacks of the earlier systems of talking movies, with crude disk records and films to be kept in step. I felt that the successful system would be one combining the sounds and the pictures on a single film. And I traced my footsteps in that direction.

In 1921 I went to Germany to develop my talking movies or Phonofilm, as I called the system. Upon returning to the States some time later, I was astounded at the progress made in broadcasting. Continuing my work on the Phonofilm system, I nevertheless determined to take part once more in broadcast development, this time returning to the very foundation of the entire structure—the audion. I realized that despite all the progress that had been made, the audion or vacuum tube was still in its infancy and needed engineering development and research in no mean degree.

I have been fortunate in gathering about me a staff of vacuum tube specialists and production experts. I am particularly fortunate in having as my collaborator Allen B. DuMont, together with his assistants, Messrs. Hopping, Allen, Fagin and others. To these men, with the experience and knowledge gained from training in the largest vacuum tube plants, together with their enthusiasm and ambition of youth, I owe in large measure the many refinements recently scored in audions.

It is little things, rather than startling big things, that must mark the future progress of radio. While I would not be so rash as to state that everything is known and discovered today, it seems to me that we have sufficiently covered the basic principles for the present to have an ample field in which to work. We must cultivate what we already have. There is plenty of room for improvement.

For instance, taking the vacuum tube as it existed a year ago, many refinements have since been made. First of all, we have developed improved filaments of special alloys, capable of enormous emission at reasonable temperatures, and therefore providing a long and uniform life. The filament of our general-purpose battery tube, for instance, burns so dimly at ample operating efficiency that it does not appear to be lit in daylight. The delicate 71A power tube, which had been noted for its short life, uncertain emission, and mechanical weakness, has been perfected through developing a special alloy filament. In heaters for a.c. tubes, we have developed new insulating materials and constructions, including the full-length sheath which eliminates hum and crackle. As for mechanical details, we have introduced the mica spacer, eliminating glass beads to an absolute minimum and thereby securing the more accurate spacing of elements, greater uniformity of characteristics, permanent positioning of elements, and the avoidance of electrolysis and leakage which formerly caused many of the tube noises. We have developed improved exhausting and sealing methods, resulting in higher vacuum and therefore audions with better tone quality and less background noise.

Imagine the combined efforts of the radio engineer, the chemist, the expert mechanical engineer, and the production man—little wonder that they produce perfected tubes for radio and other uses.

And now, having attained wonderful realism in our broadcasting, excellent selectivity and sensitivity to bring us the desired programs, and an endless supply of entertainment and enlightenment always at our disposal, what next?

To my mind, we are entering a new era in radio—television. In time sight will come, to join hearing, in the complete home entertainment via the air. There are many problems in television. Our present efforts are not to be compared with the perfection of present broadcasting, but rather with my own crude attempts at broadcasting back in the days of acousticon microphones, carbon arcs and the phone receiver and microphone method of coupling. C. Francis Jenkins, pioneer in the field of television, has already made notable progress. His recent

(Continued on page 284)

RADIO BREVITIES

A SUBSIDY of 3,800,000 marks or almost \$100,000 has been granted by the Finnish Government for the development and improvement of radio stations in Helsingfors, Viipuri (Viborg) and Tampere (Tammerfors), according to press reports. Of this sum, 3,500,000 marks are to be used in the erection of a local station in Helsingfors, which will be ready within the present year.

Daily news in Mexico is now being broadcast every night from Mexico City, Commercial Attache George Wythe of that city has reported to the Department of Commerce. The day's happenings, furnished by the Trens News Service of the city, are broadcast over station XFX of the Mexican Department of Public Education at eleven p. m. in both Spanish and English. At midnight another news report, this time from station XDA, a powerful Government radio, which uses a 32-meter short-wave, is broadcast in International Morse code, also in both languages.

Indications that the number of broadcasting stations will be greatly increased within the next year are seen in the flood of applications for construction permits which is descending upon the Federal Radio Commission.

These applications are being received from every section of the country, some of the proposals being for stations of rather high power. A few construction permits have been issued by the Commission, chiefly for small stations or for stations in districts which are not now adequately served, but the majority of the applications are being filed to await hearings next fall.

Station Changes

The following changes in broadcasting allocations have been announced by the Federal Radio Commission:

WAPI, Birmingham, Ala., license assigned from Alabama Polytechnic Institute to Alabama Polytechnic Institute, University of Alabama and Alabama College.

KMTR, Hollywood, Calif., power increased to 1,000 watts, full time.

KPLA, Los Angeles, Calif., frequency changed from 570 kilocycles (526 meters) to 1,000 kilocycles (300 meters).

KMIC, Inglewood, Calif., new owner, Dalton's, Inc.

WHBD, Bellefontaine, Ohio, license assigned from First Presbyterian Church to F. P. Moler.

WBAW, Nashville, Tenn., license assigned from Waldrum Drug Company to Tennessee Publishing Company.

KTM, Los Angeles, Calif., power increased to 1,000 watts, day only.

KTAB, San Francisco, Calif., power increased to 1,000 watts and frequency changed from 550 kilocycles (545 meters) to 560 kilocycles (536 meters).

KOAC, Corvallis, Ore., frequency changed from 560 kilocycles (536 meters) to 550 kilocycles (545 meters).

Televocal

Quality Tubes

No. A-C
224
Screen
Grid



There is a Tele-
vocal Tube for
every need at all
good dealers.

Are Go-Getters. Developing extreme sensitivity and hair-line selectivity they will bring in stations heretofore strangers to your set, clearly and without hum, with greater volume and perfect reproduction of tone quality. They heat rapidly, are long-lived and built to stand any strain.

No. A-C
227
Quick
Heating

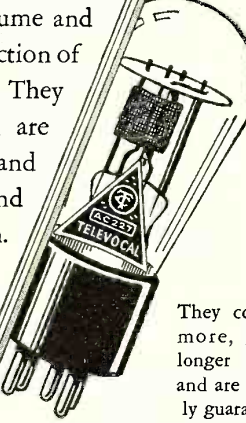

They cost no
more, giving
longer service
and are liberal-
ly guaranteed.

Televocal Corporation

Televocal Building, Dept. A-9
588 12th Street, West New York, N. J.

LOOK AT THIS PHENOMENAL VALUE!

K O L S T E R

Electro Dynamic Reproducer

Combined with 210 Power Amplifier and "B" Supply Unit

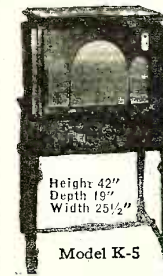

Model K-5

Height 42"
Depth 19"
Width 25 1/2"

This famous genuine Kolster K-5 AC Electro-Dynamic Reproducer is complete with a 210 Power Amplifier and "B" Supply Unit all self-contained on a steel frame. This real fine matched rugged Unit weighs 45 lbs. without the Cabinet. The Cabinet itself is Pencil-Striped Walnut, beautifully designed with Cathedral grille.

If desired, the 210 Power Amplifier will also supply 22, 67 and 90 volts "B" current, sufficient for any set using up to 8 tubes. An automatic voltage regulator tube, UX-874, maintains the "B" voltage silent and steady.

This Electro-Dynamic Reproducer can be used with any battery or AC set, replacing the last audio stage, or be used with all tubes of the set. Wherever used it will bring out every shading and range of tone; every note is reproduced with utmost faithfulness, pure and undistorted. It will modernize any radio receiver.

Uses 1—UX-210, 2—UX-281 and 1—UX-874 tubes.

A 20-ft. cable is included with each instrument. Operates direct from 50-60 cycle, 110-120 volt AC current.

Brand new in original factory cases and guaranteed. Every Reproducer is serial-numbered and has factory guarantee tag enclosed.

List Price \$175.00
(without tubes)

Never Before \$49.50

AMERICAN SALES CO., 19-21 Warren Street, New York City

MASON, FENWICK & LAWRENCE
PATENT LAWYERS
 600 F St., N. W., Washington, D. C.
Estb. over sixty years. Send sketches.
 Electrical, Aeronautical and Chemical Inventions
 carefully handled. Practice before the U. S. Courts
 and the Patent Office. Prompt and careful service.
 Write us. Protect your inventions.
TRADE MARKS REGISTERED

Send for **WESTERN RADIO**
 New 1929 Catalog

LATEST and FINEST nationally known A.C. sets,
 consoles, cabinets, speakers and accessories at
LOWEST PRICES. Catalog sent **FREE** on request.

WESTERN RADIO MFG. CO.
 128 W. Lake Street, Dept. RN-9, Chicago

The Thrills of Amateur Radio

(Continued from page 240)

shore even heard the note sputter as the antenna plunged into the water.

We might continue with the successful Pacific flight of the "Southern Cross," with the remarkable feat of one of Byrd's big monoplanes above Antarctica in maintaining two-way communication with W2UO, an amateur station in New York City. But these and scores of other instances are recent news, and we have seen enough to appreciate the paramount importance of the radio amateur in modern exploration. Let us turn to another amateur activity nearer home; less romantic, perhaps, but often more dangerous and exciting.

On September 17, 1926, hurricane warnings were broadcast up and down the Florida coast. Out in the Bahamas anchored yachts were reeling under a bombardment of coconuts blown about like rain, and at sea high-sided liners were hove to. At Miami that night the wind velocity swung ever upward—sixty miles an hour, eighty, one hundred. Buildings were crumbling into matchwood over their helpless tenants; enormous seas were sweeping over Miami Beach, on which the only refuge was the half-flooded concrete hotel. The next day, as the calm central eye of the storm passed, hundreds thought it was over, and were drowned in the sudden onrush of the east half of the storm. The terrific wind wiped out every telephone and telegraph line, every communication channel which had connected Miami with the outside world. In the cities of the South, where waited the potential forces of rescue, the only word from Miami was "wires down; no further news."

Then amateur radio, in the person of John V. Heish of Miami, stepped into the breach. The electric power was gone, but Heish improvised a transmitter with a UX-210 tube and a score of dry "B" batteries, and sent out an emergency call on 40 meters. He raised Gifford Grange in Jacksonville, and rushed through an official message from the county sheriff asking the Governor of Florida for immediate military aid. Throughout that first day the two stations kept an hourly schedule, handling Government and Red Cross messages, death messages, appeals for aid and news of safety. All over Florida and the entire South other amateur stations stood by, relayed messages, and did their part in the crisis.

The next great sectional disaster struck further westward. Through the spring of 1927 a series of floods occurred all along the Mississippi, inundating immense tracts of land, and driving nearly a million people from their homes and farms. Amateurs all along the great river stood watch hour after hour while flood conditions continued. 5SW in Hot Springs, Arkansas, gathered news for the city paper after wire communication went out. At Pine Bluff, in the heart of the flooded area, 5SI maintained contact with the Army Seventh Corps Area Headquarters at Omaha and handled all official army messages to and from Arkansas. In Louisiana and Mississippi several stations handled official relief and associated press traffic, and many more were standing by in readiness if wire lines failed.

Though the New England flood in November of the same year covered only a fraction of the area of the Mississippi flood, it was in some respects more concentrated and violent. The rainfall up and down western New England was around seven inches, and it is said that seven billion tons of water poured down from the skies on the Connecticut River watershed. George Wallstrom was at work in Montpelier on the afternoon of November 3rd and, realizing the danger of rising waters, started for his home transmitter. The water in the streets stopped his car; he continued on foot, but the depth and current soon forced him to take refuge for the night in a nearby house. The next morning he reached home by boat and met another amateur, Ralph H. Harris. They got one transmitter on the air immediately under auxiliary power, and raised Binghamton, New York, well outside the flood area. A few hours later, with the resumption of electric power, both stations began transmitting scores of official messages, news dispatches and assurances of personal safety. Three amateur expeditions took portable transmitters into the flooded area by automobile, freely sacrificing their time, property and safety in the common cause. Hundreds of permanent stations in the north Atlantic states kept watches night after night to expedite the flood traffic.

Perhaps the climax of wise preparation and intrepid devotion to duty on the part of amateur operators was reached in the Florida hurricane of 1928. The storm swept by the Virgin Islands and Porto Rico on the way, paralyzing two naval radio stations. Amateur transmitters, using the navy calls temporarily, at once got in touch with the mainland. In Palm Beach, Florida, two amateurs named Dana and Hollis prepared against the advancing destruction by gathering an emergency power supply of storage and dry "B" batteries and installing a transmitter in the Fire Station. They completed their final test transmissions under the shadow of the oncoming storm. Again along the Florida coast the wind rose to incredible velocities and began to crush houses, fell telegraph poles and lift solid blocks of stone bodily through the tormented air, while Hollis and Dana sat calmly at their instruments in constant touch with points beyond the storm area. Late in the afternoon their antenna blew away and their end of the building began to crumble. They moved the transmitter into the opposite end of the building, and strung a new antenna in a shower of bricks and roof tile. The next morning, while the wind shifted and the second half of the storm smote Palm Beach, they handled all sorts of emergency traffic that could find no other communication channel. Relief expeditions equipped with portable transmitters were on the way, but it was three whole days later when they were able to get into Palm Beach and relieve Hollis and Dana. During four days and nights one or the other had stayed almost continuously at the key, while other amateur stations all over the South relayed their messages to distant destinations.

Thus do the annals of amateur radio yield a broad and heroic story, of which

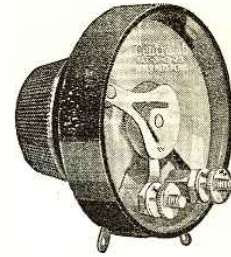

FOR WANT OF A NAIL....

Everybody remembers the verse about the courier in the battle of Waterloo speeding to get reinforcements for Napoleon. His horse faltered and fell. . . . For want of a nail a shoe was lost . . . and the battle lost.

A radio receiver is very much the same. You may have the "re-inforcements" in the form of fine workmanship, good condensers, good transformers and yet there may be a "nail" that causes trouble. Look to the volume control for a great amount of the grief . . . mechanical and electrical noise . . . inadequate and uneven control. Are those the symptoms?

Then turn to Centralab controls whose quality is vouched for by this fact; the great majority of radio manufacturers include them in standard equipment. Be sure the manufacturer of the receiver you sell has done likewise.

CENTRAL RADIO LABORATORIES
Keefe Avenue Milwaukee, Wisconsin



ELECTRIFY YOUR 685 RADIO FOR ONLY \$6.85 COMPLETE

Why discard your present good set when you can electrify it for only \$6.85, and banish the annoyance and expense of buying new "B" batteries?



OVER 100,000 TOWNSEND "B" POWER UNITS IN USE
Hooked up in a few minutes. Use same tubes—no changes. You'll be amazed at the improvement in reception and distance getting. Send name and address today for full details, proof and Free Trial Offer.

TOWNSEND LABORATORIES,
725 Townsend St., Chicago, Ill.

Please send me full information on the Townsend "B" Power and Free Trial Offer.

Name

Address

City..... State.....

To be sure of getting your copy each month, subscribe to Radio News, \$2.50 a year.
EXPERIMENTER PUBLICATIONS, Inc.
381 Fourth Ave., New York City

FREE RADIO GUIDE

This book tells about newest startling developments. How to take advantage of the new wrinkles in radio, television, short wave, etc. Pictures and descriptions of thousands of new ideas. Shows new A-C Screen Grid tube and other sets, kits, parts, accessories and supplies at wholesale prices. Shows you how to save money on these and many home necessities besides. New edition now ready. Send for it today—NOW!



Barawik Co. 29-A Canal Sta. Chicago, U. S. A.

Name

Address

City..... State.....

OPPORTUNITY AD-LETS

Follow these advertisements every month. Reliable advertisers from all over the country offer their most attractive specials in these columns.

Classified advertising rate twenty-six cents a word for each insertion. Names and addresses must be included in the above rate. Cash should accompany all classified advertisements unless placed by an accredited advertising agency. No advertisements for less than 10 words accepted.

Objectionable or misleading advertisements not accepted. Advertisements for the November issue must reach us not later than September 1st.

CIRCULATION LARGER THAN THAT OF ANY OTHER RADIO PUBLICATION

EXPERIMENTER PUBLICATIONS, INC., 381 Fourth Avenue, New York, N. Y.

Agents Wanted

Guaranteed Genuine Gold Leaf Letters anyone can put on store windows. Large profits, enormous demand. Free samples. Metallic Letter Co., 422 N. Clark, Chicago.

Big Ohio Corporation wants county manager. Opportunity \$50 to \$75 weekly. Earnings start immediately. Good for \$5,000 yearly. We furnish everything, deliver and collect. Capital or experience unnecessary. Fyr-Fyter Co., 1906 Fyr-Fyter Bldg., Dayton, Ohio.

Sell High Life Cigars. Big money made. Write for information. John S. Davey & Co., Stop 25, Schenectady Road, Albany, N. Y.

Books

O! O! I'm Leffing—The Jewish Joke Book that keeps them laughing—plenty of wise-cracks—and plenty of fun—only 25c complete. Write, Experimenter Publications, Inc., 381 Fourth Avenue, New York City.

Five Big Movie Novels all for \$1. All individual novels, fully illustrated, in magazine form—same stories often cost you \$2 each in the stores, titles are—"The Singing Fool," "The Awakening," "Noah's Ark," "Lilac Time" and "The Rod Dance." Send only \$1 to Mackinnon-Fly Publications, 381 Fourth Avenue, New York City.

Three Big Wild West Novels in magazine form—all for 50c—titles are "Gold," by Charles Snow; "Hell on Wheels," by John Brock, and "The Border Wolf," by Robert Ames Bennett—all illustrated—all individually bound novels. Send 50c for them to Mackinnon-Fly Publications, Inc., 381 Fourth Avenue, New York City.

Business Opportunities

Free Book. Start Little Mail Order business. Hadwil, 5A-74 Cortlandt Street, N. Y.

Amateur Cartoonists: Sell Your Cartoons. New Plan. Smith's Service EX1194, Wenatchee, Wash.

Inventions Commercialized. Patented or unpatented. Write, Adam Fisher Mfg. Co., 278 Enright, St. Louis, Mo.

Correspondence Courses

Used correspondence school courses sold on repurchase basis. Also rented and exchanged. Money-back guarantee. Catalog free. (Courses bought.) Lee Mountain, Pisgah, Alabama.

Detectives

Experience un-George Wagner,

For Inventors

Inventions Commercialized. Patented or unpatented. Write, Adam Fisher Mfg. Co., 278 Enright, St. Louis, Mo.

Male Help Wanted

Firemen, Brakemen, Baggagemen (white or colored), Sleeping Car, Train Porters (colored), \$150-\$250 monthly. Experience unnecessary. 237 Railway Bureau, East St. Louis, Ill.

Magic and Games

Cookoo Nuts—The fascinating new game that makes a party twice as much fun—only 25c complete. Write, Experimenter Publications, Inc., 381 Fourth Avenue, New York City.

100 Card Tricks for 25c. Complete descriptions for performing with dozens of illustrations—all in one big easy-to-read book. Amaze your friends with these feats of magic. Send 25c today to Experimenter Publications, Inc., 381 Fourth Avenue, New York City.

Miscellaneous

Inventions Commercialized. Patented or unpatented. Write, Adam Fisher Mfg. Co., 278 Enright, St. Louis, Mo.

S'matter Pop—the famous comic strip artist now brings you 50 comic strips all nicely bound in a colorful book. Price only 25c. Write Experimenter Publications, Inc., 381 Fourth Avenue, New York City.

Five Popular Detective Novels in magazine form—written by famous authors of mystery fiction—Titles are—"Star of Death," by R. T. M. Scott; "The Secret Defenders," by Anne MacMahon; "Stealthy Terror," by John Ferguson; "The Taxi Murder," by J. L. Byrne, and "The Marsh Murder," by N. B. Mavity—all five for a single \$1. Write to Mackinnon-Fly Publications, Inc., 381 Fourth Avenue, New York City.

Patents

Inventions Commercialized. Patented or unpatented. Write, Adam Fisher Mfg. Co., 278 Enright, St. Louis, Mo.

Patent Attorneys

Patents—Send for form "Evidence of Conception" to be signed and witnessed. Form, fee schedule, information free. Lancaster and Allwine, Registered Patent Attorneys in United States and Canada, 269 Ouray Bldg., Washington, D. C.

Patents—Write for Free Instructions. Send Drawing or Model for Examination. Carl Miller, Registered Patent Attorney (former Patent Office Examiner), 262 McGill Building, Washington, D. C.

Patent Attorneys (Cont'd)

Inventors—Should write for our Guide Book, "How to Obtain a Patent," and Record of Invention Blank, sent free. Send model or sketch of inventions for our inspection and instructions free. Radio, Electrical, Chemical, Mechanical and Trademark Experts. Terms Reasonable. Victor J. Evans & Co., 922 Ninth, Washington, D. C.

Patents—Send drawing or model of your invention for examination and instructions. Advice and booklet free. Highest references. Best results. Promptness assured. Watson E. Coleman, Patent Lawyer, 724 9th Street, N. W., Washington, D. C.

Printing, Engraving and Multigraphing

Multigraphing, two dollars thousand. Miscellaneous Printing. Mayer Ray Corporation, Monmouth, Illinois.

Radio

Machined Castings, Blueprint, Instructions for Building Dynamic Speaker \$8.50. A. C. Klein Co., 1058 North 10th, Reading, Penna.

Everything in Radio at Attractive Prices. Sets or Parts. Orders shipped exactly as ordered. Prompt Service. Write for prices. Inquiries invited. Send your address. All Radio Co., 417 North Clark St., Chicago.

Get Commander Byrd's messages from the Antarctic—with a Short Wave Radio Set—Complete Short Wave Manual with instructions for building and full size blue prints—all 50c. Write today to Experimenter Publications, Inc., 381 Fourth Avenue, New York City.

Salesmen Wanted

Amazing screw-holding driver! Factories, Garage workers buy on sight! Profit 75c each. Exclusive territory. Free trial offer. Jiffy, 1148 Winthrop Bldg., Boston.

Song Poems

Song Poem Writers: "Real" Proposition. Hibbler. D7X, 2104N, Keystone, Chicago.



CORRECT Your NOSE

to perfect shape while you sleep. Anita Nose Adjuster guarantees SAFE, rapid, lasting results. Age doesn't matter. 68,000 doctors and users praise it. Gold Medal Winner. Write for FREE Booklet and 30 Day Trial Offer.

ANITA INSTITUTE, K-21 Anita Bldg., Newark, N. J.

we have here only sketched some of the highlights. Inspiring as it is to read this narrative written in fleeting signals through intangible space, how much more so, in whatever small degree, to help write it!

Today, amateurs are on a sound footing in every civilized country on the globe, and their operating bands and other privileges are recognized by international agreement. Many of our own operators

have joined the Army Amateur Radio Net or the Naval Radio Reserve. In these days of propaganda, when the word "service" too often means simply self-glorification, to see a group of men who stand always ready in times of danger and disaster as a matter of course, with little to say about it either before or after, is both splendid and refreshing. And to join that group is more than merely to pursue a hobby.

Installation and Servicing of Sound Amplifiers

(Continued from page 230)

worth-while suggestions from the installation man. They may have certain preconceived ideas, but very often these are not definitely fixed and can be easily influenced by the installation man with a little logic based on his experience. This does not mean that the installation man should make recommendations solely because they will increase the size of his contract, because a prospective client will be suspicious of any recommendations unless they are based on sound considerations.

Providing for Various Pick-Up Methods

It so happens, of course, that most recommendations aimed toward providing better results will involve a greater expenditure, which is one of the reasons why careful planning and study on the part of the installation man is well worth while. For instance, in a power amplifier system which is planned for the reproduction of radio programs it will usually not be difficult to sell the purchaser on the idea of installing a phonograph and pick-up for use as a substitute for the radio receiver. Thus, in summer when the static level is high he can switch in the phonograph and continue to provide entertainment, or should something go wrong with the radio receiver he can always let the phonograph pinch hit until repairs are made. In few sections of the country are there good broadcast programs on the air at all hours. In other sections the phonograph may be used to fill in the time occupied by uninteresting programs. This phonograph idea would not be so practical except for the comparatively recent development of automatic machines which will take a number of records and play them continuously one after the other for hours on end. Such phonographs need no more attention than a radio receiver.

Power amplifiers are used mainly for the amplification and reproduction of radio broadcast programs and phonograph selections, but to an ever-increasing extent they are also being used for speech amplification. This latter use is not limited to large halls or large assemblages which cannot be covered by the unaided voice, but is also finding extensive application in cases where it is desired to reproduce music or talking in several rooms at one time. In assembly places which are frequently overcrowded, the installation of a power amplifier system will permit speeches or programs in the main room to be reproduced in adjacent rooms, thus taking care of the overflow audience.

Another and not inconsiderable use of

a power amplifier for speech amplifier purposes is in cases where radio or phonograph reproduction is used as an advertising or publicity medium to attract trade to a store, etc. One interesting example of this application was in a New Jersey town where a progressive storekeeper happened to have a store located about a half block off the main street. In order to attract public attention to his store he had a power amplifier system installed with a large loud speaker above the front of his store. The radio and phonograph programs reproduced through this system were easily audible on the main street and attracted considerable attention. As a result a good deal of trade was brought to his store which he otherwise would not have received. In order to increase the value of this installation he made use of a microphone hook-up by means of which his voice was thrown out on the main street, announcing special items of interest, including results of local sporting events, etc., and not neglecting to tell the world about special sale features to be found in his store. Also, when time would permit, he acted as the announcer for his phonograph programs, and thus by combining radio, phonograph and microphone pick-ups he made the maximum use of his power amplifier installation.

Outdoor reproduction is usually a matter for individual study, and generalizations are of little practical value. The main problem in outdoor work is to obtain sufficient volume, intensity and distribution to provide the desired coverage. This is particularly true of outdoor athletic fields, baseball parks, etc., where the noise level is usually high. The difficulty is not so much in obtaining sufficient amplification but rather in deciding upon the types, number and placement of radio speakers to reach the entire audience. Horn type loud speakers are very often used for this purpose, and the familiar cluster of "morning glory" horns generally used in the past is probably familiar to almost everyone. Improvements made in loud speaker design during the past year or two are making changes, however, with the result that standard dynamic type speakers with large horns are now finding a place in this service, as also are large horns with compact special dynamic units.

In the articles to follow, detailed attention is to be given to technical discussion of equipment suitable for use in power amplifier installations, together with illustrations and descriptions of some of the installations now in operation, and of the amplifier input and output equipment of various types now on the market.

EXCELLO Radio Consoles

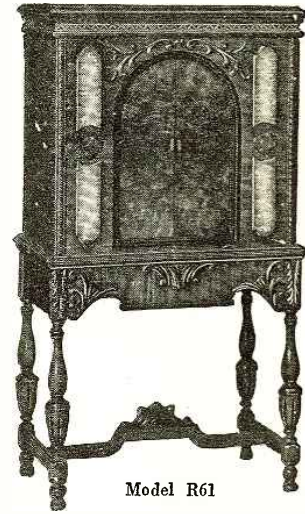

Model R61

A beautiful Walnut Cabinet with sliding doors of matched Butt Walnut and selected Japanese Ash sidepanel overlays. Accommodates Buckingham, Crosley, Atwater Kent, Fada, Sparton and all standard receivers. Ample space for Receiver, Speaker, etc.

Write today for Free illustrated folder of all new styles, including Phono-Radio Combination Consoles.

EXCELLO PRODUCTS CORPORATION
4832 West 16th St., Cicero, Illinois

Excellent results obtained with those batteries on short wave receivers. 100-Volt Edison Element, Non-Destructive, Rechargeable "B" Battery with charger. Shipped dry, with solution, \$12. 140-Volt with charger, \$17. 180-Volt Power Unit, with Trickle Charger, \$24. Send no money—pay expressman. Write for our Free Literature

SEE JAY BATTERY CO
915 BROOK AVE. NEW YORK

BIG-PAY JOBS in ELECTRICITY

\$60.00 to \$150.00 WEEKLY

Amazing new method. Trains you quicker and better. Motion Pictures in your own home make every point clear. Genuine DeVry motion picture projector at no extra cost. Thousands of feet of film furnished. We pledge to give you training and employment service necessary to secure a better job at bigger pay or refund money. Get full facts. No obligation. Write quick while offer lasts.

Motion Pictures Train You QUICK

National School of Visual Education, Dept. 9-N
537 S. Dearborn St., Chicago, Ill.

Send book, "The Film Way to Bigger Pay," with facts about this new, easier way to master electricity.

Name Age

St. or R. F. D.

City

State

MAIL THIS COUPON NOW!



How Would You Like to Be Another Lindbergh?

YOU, too, may win huge prizes for daring feats of aviation. You, too, may earn the honors heaped on heroes of the air by admiring nations. You, too, may gain the support and friendship of the great financial leaders of the world. But you've got to start, and start soon! Only a little more than 2 years ago nobody knew Lindbergh. Only a little more than 2 years ago, he was just an obscure young man trying to learn all he could about aviation.

We Are Looking for Men Who Dare!

Today his fame is probably greater than that of any other single man. At the age of 27 he stands a model of the way to gain fame and fortune quickly.

We are looking for men who dare to conquer the air! We are looking for men who realize that the quickest route to success is in a field of endeavor that is new and growing fast. We are looking for men who want to learn all about Aviation. We want to show them how to get started *right!*

AERO A Mechanics

Dept. 2409a

381 Fourth Avenue, New York, N. Y.

These Men Can Help You

With this ideal (to help the youth of America learn Aviation) firmly in mind, we have brought together a staff of men who KNOW Aviation. Years of practical experience in the Aviation School of Hard Knocks have taught them how to conquer the air. And now, they want to give this knowledge to you in AERO MECHANICS, the new magazine that tells all about Aviation in easy-to-read language. Within its pages you will learn how a pilot controls his airplane; how the propeller works; what you have to do to become a flier; how to build model aircraft; how to build a glider; and dozens of other practical, helpful bits of information every aviator must know.

Complete Cost Is Only \$1

As a special inducement we are offering you the next 6 Big issues of AERO MECHANICS all for a single \$1. Simply clip and mail the coupon below with your dollar.

AERO MECHANICS
Dept. 2409a, 381 Fourth Ave., New York, N. Y.

Gentlemen:

I am interested in Aviation. Please send me the next 6 issues of AERO MECHANICS, for which I enclose \$1.

Name

Street and Street No.....

City..... State.....

FACTORY TO YOU—SAVE 50%—COMPARE WITH COSTLIEST OUTFITS BEFORE YOU BUY

a powerful new Miraco ^{set or complete outfit} **30 DAYS FREE**
Electric or Battery



NEW LOW FACTORY PRICES SAVE 50%

Beautiful Variety of Latest Fine Consoles, AC or Battery Sets

30 DAYS FREE TRIAL



An exquisitely new and fine, genuine walnut desk-type Mastercrest console. Very pretty and a rare bargain. Hinged top.

Richly designed, latest type, Lo-Boy Mastercrest console, beautiful two-tone finish in walnut. A gem that costs little. Hinged top lid.



Spanish Treasure chest design, Mastercrest console. Finest selected grain, solid walnut. Antique wrought hardware. Marvellous value. Hinged top.

These Consoles are Equipped with **SUPER DYNAMIC CATHEDRAL TONE REPRODUCERS**



Table compact style Mastercrest cabinet in handsome walnut and gold-striped finish. Separate Cathedral Tone Super-Dynamic Speaker to match. Wonderful bargain!

Get Our Send No Money 10th Anniversary Offer!

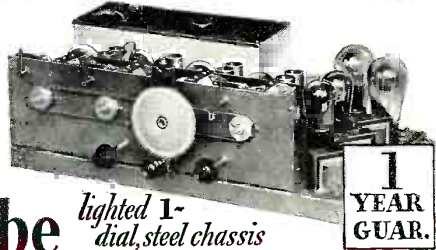

1 YEAR GUAR.

9 tube *lighted 1-dial, steel chassis*
perfected SCREEN GRID—
latest **PUSH-PULL** Amplification

New SCREEN AERIAL Console SUPER-DYNAMIC Cathedral Tone!
Mastercrest-built with beautiful genuine walnut; sparkling maple panels; 4-way matched sliding doors. Lifting top. Concealed SCREEN aerial makes outdoor aerial unnecessary. Super-Dynamic Cathedral Tone Reproducer.

Built like—looks like—performs like newest sets in many outfits up to \$300! Latest, finest, costliest construction! Uses "224" SCREEN GRID, "245" PUSH-PULL POWER, "227" HUM-FREE POWER DETECTOR AND "280" RECTIFIER AC TUBES. Phonograph pick-up connection. Local-Distance switch. Built-in power section on steel shielded chassis. Lighted one-dial tuning. Razor-edge selectivity; super-dynamic cathedral tone quality; marvelous distance getter. Solid one-year guarantee if you buy it for

Only **\$49⁸⁸**
COMPLETELY ASSEMBLED

Values possible because you deal direct with big factory

MIRACO

TRADE MARK REGISTERED

CATHEDRAL TONED, SUPER SELECTIVE, POWERFUL DISTANCE GETTERS

You needn't send us a cent! America's big, old, reliable Radio Factory springs its 10th Anniversary Surprise in high-grade, 1-year guaranteed sets at history's lowest prices!

Don't Confuse with Cheap Radios
With Miraco's rich, clear cathedral tone, quiet operation, razor-sharp separation of nearby stations, tremendous "kick" on distant stations and latest improvements—you'll be the envy of 2 or 3 times as much!

Special! Electric Super AC-7 \$39⁸⁵

USER-AGENTS WANTED
Exclusive Territory—Demonstrator Supplied
Spare or full time. No contract, no experience required. Big money! Send coupon now!

Send for proof that delighted thousands of Miraco users cut through locals, get coast to coast, with tone and power of costly sets. Miraco's are custom-built of finest parts—product of 10 years' successful experience. Approved by Radio's highest authorities.

SEND for AMAZING SPECIAL OFFER

With its latest perfected Screen-Grid, push-pull, super-powered and hum-free AC electric Miraco's—you are guaranteed satisfaction, values and savings unsurpassed. *Get Amazing Special Offer!*

Deal Direct with Big Factory

At our risk compare a Miraco with highest priced radios, for 30 days in your home. Surprise and entertain your friends—get their opinions. Unless 100% delighted, *don't buy!* Your decision is final—no argument!

Miraco outfits reach you splendidly packed, rigidly tested with everything in place ready to plug in! No assembling! Entertain yourself 30 days—then decide. Liberal one-year guarantee on each set. Play safe, save lots of money, insure satisfaction—deal direct with Radio's old, reliable builders of fine sets—10th successful year. **SEND POSTAL OR COUPON NOW** for Amazing Offer!

Only marvellously fine radios, of latest perfected type, at rock-bottom prices, can back up such a guarantee. Send postal or coupon for *Amazing Special Factory Offer!*

MIDWEST RADIO CORP., 404-AS Miraco Bldg., Cincinnati, Ohio

BEAUTIFULLY ILLUSTRATED LITERATURE, AMAZING SPECIAL FACTORY OFFER, TESTIMONY OF NEARBY USERS—

All the proof you want—of our honesty, fairness, size, financial integrity, radio experience and the performance of our sets—including Amazing Factory Offer—sent without obligation!



Free!

MIDWEST RADIO CORPORATION
Pioneer Builders of Sets—10th Successful Year
404-AS Miraco Bldg., Cincinnati, Ohio

THIS COUPON IS NOT AN ORDER

WITHOUT OBLIGATION, send latest literature, Amazing Special Free Trial Wholesale Price Offer, testimony of nearby users, and all Proof. User Agent Dealer
 Check here if interested in an **EXCLUSIVE TERRITORY PROPOSITION**
NAME ADDRESS

No More Razor Blades To Buy!

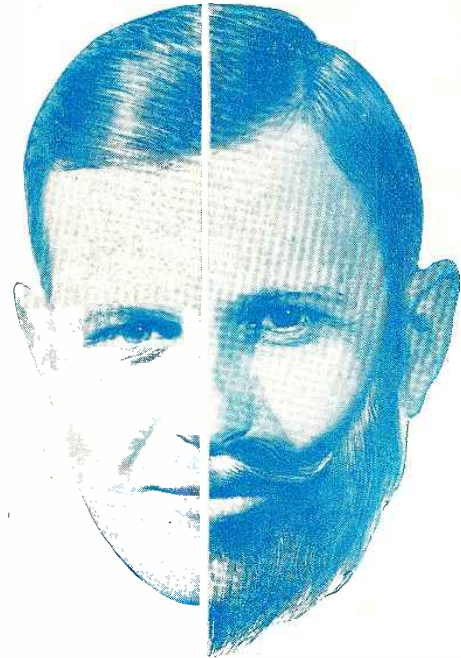
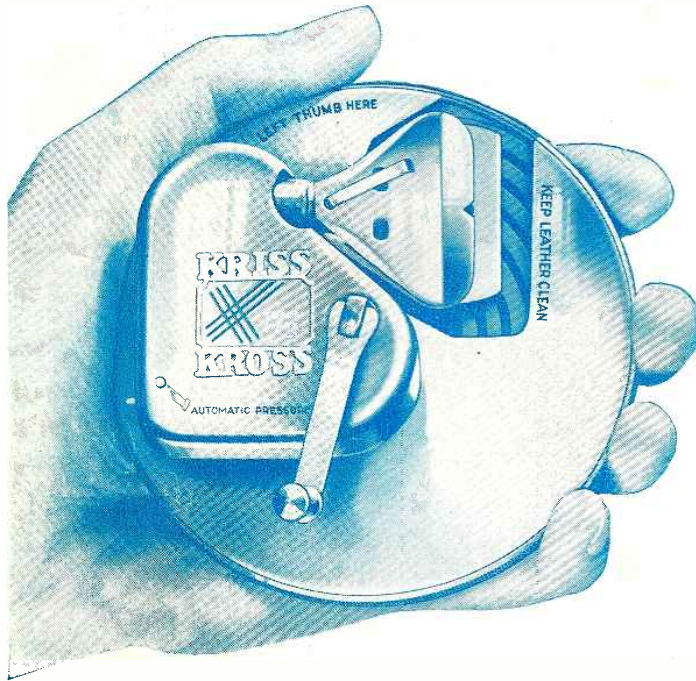

**365 Keen Shaves
A YEAR WITH ONE SINGLE BLADE**
 "I want to say that KRISS-KROSS Stropper is the best thing I ever saw. I have been using one blade continuously for one year and nine months and have no idea how much longer it will last."
 C. S. Stephenson, Okla.

Inventor Discovers Amazing New Way to Shave! -Without Buying Blades!

K EEN velvety shaves forever and no more blades to buy! That's what the astonishing invention of a St. Louis man offers the great army of American shavers today!

KRISS-KROSS is destined to revolutionize all existing traditions of shaving! Its performance is so sensational that it seems hardly fair to call it a stropper. Rather it is a super-stropper or blade-rejuvenator! Almost literally it makes a new blade out of an old one every day. No longer do you find that your blades "die" after five or six shaves. KRISS-KROSS "brings 'em to life" a surprising way, week after week and month after month and endows them with a keenness that they never possessed when brand-new! Actually you can take a blade right out of a fresh package and improve it as much as 100% in eleven seconds with KRISS-KROSS! No wonder experts pronounce it one of the greatest inventions ever patented!

Magic Diagonal Stroke

Until you've seen KRISS-KROSS, fitted its sturdy nicked smoothness into the palm of your hand and tested its uncanny dexterity yourself, you'll never know how amazing it really is! It employs the famous diagonal stroke, same as a master barber uses. Never before has anyone captured the secret of reproducing it automatically. Eight "lucky leather grooves" do the trick in 11 seconds with a precision it takes a master barber years to attain.

But that's not all, KRISS-KROSS embodies still another feature that has hitherto baffled mechanical reproduction. It strops from heavy to light. It's absolutely uncanny the way the strokes start with strong pressure and grow lighter and lighter until an adjustable, automatic jig flies up and notifies you that your blade is ready—ready with the keenest cutting-edge that steel can take!

Fits All Makes of Blades

KRISS-KROSS produces unbelievable sharpness and prolongs the life of any razor blade for months and even years. Fits all brands and makes except Durham. Eliminates 83% of shaving costs. No more "raking" and scraping with dull blades. No more stinging and smarting that has to be relieved with messy lotions and harsh astringents. KRISS-KROSS solves your blade problem for all time and gives you keen velvet-smooth shaves forever!

Sensational Offer

And now for my surprising offer. To introduce KRISS-KROSS, I am giving with it Free a new kind of razor. Possesses remarkable features. Instantly adjustable to any shaving position. A flip of the finger makes it (1) T-shaped; (2) straight (old style); (3) or diagonal (new way). Gives a sliding instead of pulling stroke. Simply

zips right through the toughest crops of whiskers. Made of rustless metal. Comes with 5 special process blades and is entirely unlike anything you ever saw before!

Get Free Offer

Send for full information on these surprising new inventions today. KRISS-KROSS products are never sold in stores. You deal direct with me or my authorized representative. Write for illustrated description and full details of free razor offer. It's even more remarkable than I can tell you in this short space. Clip the coupon now. Mail it today.

**Mystery
Razor
FREE**

Agents \$30.00 a Day
 Make big money with KRISS-KROSS. Giving away FREE razors boosts your profits amazingly. H. King made \$66 in one day. N. C. Paige made \$104 in 3 days! Others average \$350 and up to \$750 a month! Spare-time workers. Office and Factory men make \$6-\$12 extra a day showing KRISS-KROSS to friends and fellow employees. S. Kartala made \$154 extra just working evenings 3 weeks. Get details at once. Check bottom of coupon and mail it today!

Rhodes' KRISS KROSS

KRISS-KROSS CORP'N
 Dept. M-3104, 1418 Pendleton Ave.
 St. Louis, Mo.

Canadian Address:
 CANADIAN KRISS-KROSS CO.
 39 Wellington Street East
 Toronto 2, Canada

KRISS-KROSS CORP'N, Dept. M-3104
 1418 Pendleton Ave., St. Louis, Mo.

Without obligation, please send me illustrated description and full details of your special introductory offer on KRISS-KROSS super-stropper and FREE 3-way razor.

Name

Address

Town

Check here if interested in making money as authorized KRISS-KROSS representative.