

Radio Digest

WEEKLY **Illustrated** 10¢

Vol. 1

CHICAGO, ILL., SATURDAY, JUNE 24, 1922

No. 11

RADIO PHOTO OVER SEA

SUMMER CONCERTS BY CAPITOL BANDS

SIGNAL CORPS TRUCKS TO RECEIVE MUSIC

Naval Station Will Broadcast Over 800 Mile Range of Washington

(Special to RADIO DIGEST)
WASHINGTON.—Plans are under way for broadcasting summer band concerts held practically daily in the parks of Washington. Transmitting microphones will soon be erected in the band stands at the White House and Potomac Park and connected by wires with the Naval Radio station at Anacostia, so that band concerts by the Marine and other bands can be broadcast for the benefit of Radio enthusiasts within 800 miles from Washington.

Signal Corps Radio trucks may be stationed in out-of-the-way sections of the city to provide a means of listening in for

those who are so unfortunate as not to possess receiving sets. The Naval station at Anacostia will broadcast on 410 or 412 meters, between 7 and 8 p. m. but it is not yet known when the broadcasting will start.

EASTERN FANS HEAR TRAINING CAMP PLEA

"Mother" of Thousand Broadcasts Appeals for Military

(Special to RADIO DIGEST)
MEDFORD, MASS.—Boy Radio fans and their mothers recently heard a strong plea for the citizens' military camp at Camp Devens this summer, made by Mrs. Clarence R. Edwards, wife of Major-General Edwards, commander of the First Corps Area, U. S. Army. Mrs. Edwards, the "mother" of thousands of service men and former service men of New England, made the appeal at the request of the Military Training Camps Association.

EVERYTHING BUT CAKE SENT BY RADIOPHONE

MIDDLETON, MASS.—Mendelsohn's wedding march was sent through the ether a few days ago, and picked up at Middleton, at the home of Mrs. Laura Peabody, whose son and daughter were both married in a double wedding ceremony. The two couples marched into the living room of the Peabody home by the Radio music sent out from Station WGL.

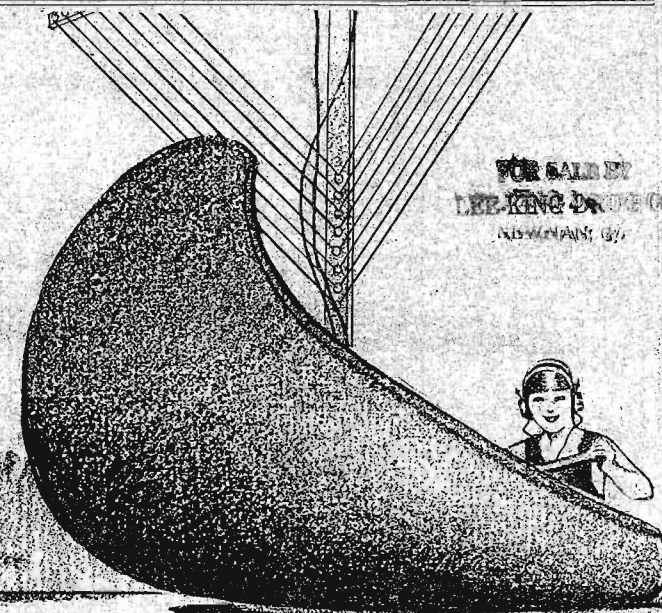

TEST PROVES USEFULNESS OF INVENTION

Picture Spans Atlantic Idea of Dr. Arthur Korn Uses Selenium "Camera," Radiogram and "Photo-Typewriter"

(Copyright (New York World) by Press Publishing Co., 1922)
(Special to RADIO DIGEST)
NEW YORK.—Transmission of pictures by Radio across the Atlantic Ocean has been shown to be entirely practical by means of a test recently held under the auspices of the New York World in which a

photograph, filed at Rome, Italy, was received forty minutes later at the naval Radio station at Bar Harbor, Me., by Chief Radioman Edward H. Hansen, U. S. N.

The process by which this latest Radio "miracle" was performed is the invention of Dr. Arthur Korn, professor of electro-physics at the Berlin (Germany) High School of Technology. Tests of it have been under way between his laboratory at Canteello, a suburb of Rome, and the United States Navy Radio Station at Otter Cliffs, Bar Harbor, for some time, but the first practical demonstration was made a little over a week ago when the World published the picture given on page 2, and which was sent by Radio across the ocean, a distance of 3,232 miles.

Shows Basic Method Sound. Over shorter distances and under more favorable conditions pictures have been (Continued on page 2)

MOOSE WILL HEAR DEDICATION TALK

Illinois Order to Broadcast Speech at Opening of New Tower

(Special to RADIO DIGEST)
MOOSEHEART, ILL.—A Radio broadcasting station will shortly be established by the Loyal Order of Moose here on the new Campanile or bell tower to be dedicated during the week commencing August 21st. Speeches made at the monthly meetings of the Board of Governors of the Loyal Order will be broadcast so that all the lodges of the Moose can pick up the proceedings. It is planned that each lodge room be equipped with a suitable apparatus for receiving speeches and matter sent out from Mooseheart, enabling them to keep in direct touch with national headquarters.

Form Organization To List All Calls

Indiana Fans Use Postcards to Correspond with Each Other

(Special to RADIO DIGEST)
INDIANAPOLIS.—All licensed amateur Radio operators in Indiana are interested in the "Unorganized Organizations." The men and boys included in this body are always interested in learning the various distances at which their sending sets are heard and are interested in the description of sets belonging to other operators. Members of the organization have postcards by which they correspond with each other. These postcards contain blanks for the names, address, station code, description of their sets and remarks. These are sent from man to man or boy to boy as the case may be.

BEATS ALL RECORDS ON TRAIN RECEPTION

MEMPHIS, TENN.—While the members of a party were traveling on a train near Lula, Miss., they were "listening in" on what was in the ether to while away the time. The train was traveling at thirty miles an hour and the party clearly heard the Hatfield Electric Company broadcasting station at Indianapolis, Ind., WOH. The location of the train was 530 miles from Indianapolis.

SUCCESSFUL TEST ON MOVING TRAIN

OKLAHOMA MAKES RECORD ON 100 MILE RANGE

Daily Paper Stages Tryout on Western Rails—Successful During Severe Storm

By Robert M. Reed
(Special to RADIO DIGEST)

OKLAHOMA CITY, OKLA.—The Daily Oklahoman co-operating with the St. Louis and San Francisco railroad, the Oklahoma Radio shop and the government station at Post Field, Okla., accomplished recently a feat yet to be equalled by any other Radio broadcasting station on railroad—the feat of receiving and transmitting messages on a moving train from a distance greater than twenty-five miles from the broadcasting station.

Equipped with a regenerative receiving set with four stages of amplification, a loud speaker, a 100-watt transmitter and a novel antenna, consisting of four, four-wire cage antennas strung from one car to the other, the car was attached to Frisco train No. 9 at Oklahoma City on the morning of May 30 and hauled to Lawton, Okla., a distance of 100 miles.

Encounter Electric Storm

At Mustang, Okla., thirty miles from Oklahoma City, a severe electrical storm was encountered but signals were received and little static encountered. In fact the signals and music came in so loud that they almost drowned out the static. Constant communication was kept up between WKY, Oklahoma City, and DME, Post Field, and the phone conversations were heard with great clarity.

At Cement, Okla., sixty miles from Oklahoma City and forty miles from Post Field, the signals, music, weather reports and Liberty bond quotations were received with as much clearness as they were at Wheatland, Okla., only 16 miles from Oklahoma City.

With a thousand reasons why the apparatus should not have worked and only a few why it should, the entire run of 100 miles with constant communications kept up between WKY-DME and the train, marks an epoch in the use of Radio on moving trains.

CINCINNATI FIRM WILL RADIO KENTUCKY RACE

Results of Southern Special to Be Airphoned to Fans

CINCINNATI, OHIO.—For the first time in the history of Radio there will be broadcast by the Crosley Manufacturing Company of this city, an account of a horse race as it is announced by the caller in the judge's stand at the Latonia Race Track. The race picked out for this unique plan is the great Kentucky Special, to be run about 4 p. m., June 24th. This will be a one and one-quarter mile race for three year olds, with a \$50,000 purse added, and will be one of the most important races of the year.

Arrangements have been made with a telephone company by which the voice of Jack Dempsey, when he is calling the position of the horses at the various stages of the race, will be carried to broadcasting station WLW over the wire phone. At the station the voice will be amplified and transmitted by Radio to the thousands of persons throughout the country who will be listening in. In other words, owners of receiving sets and their friends will be able to hear Dempsey, who is famous nationally for his ability to call horses at the various posts, announce the exact positions of the horses throughout the race, and will know the winner as soon as the great event is over.

SHOW IN BALTIMORE STARTS JULY TENTH

BALTIMORE, MD.—The Export and Import Board of trade in conjunction with the Maryland Radio Association will hold a Radio exposition in the Fifth Regiment Armory starting July 10th. It is estimated that there will be 100,000 people in attendance. Admittance will be free at the gate to all amateurs by invitation. The message of the Association will be made known to all third district amateurs.

FOLLIES WILL JAZZ TO AIRPHONE MUSIC

NEW YORK—The Ziegfeld Follies of 1922-23 beauties will dance this year to the jazzy music of the snappy Radio waves according to a person who knows. A large cabinet-sized Radio receiving instrument has been installed in the theatre to receive Radio music from broadcasting stations throughout the country. Radio dealers expect an increase in sales through "Johnnies" buying portable sets.

PLAN BETTER RADIO SERVICE FOR FARMS

HOUSE COMMITTEE GIVES FAVORABLE REPORT

Resolution to Furnish Farmers with Daily Market Prices of All Kinds

(Special to RADIO DIGEST)

WASHINGTON, June—The House Committee on Agriculture has favorably reported out of committee the resolution directing the Department of Agriculture and the Post Office Department to investigate the feasibility of furnishing market prices of cotton, corn, wheat, live stock, and dairy products by Radiophone to the farmers. The committee in reporting the resolution out says:

"The resolution reported herewith directs the Department of Agriculture and the Post Office Department to make an investigation as to the feasibility of supplying growers and producers with daily Radiophone reports of the market prices of cotton, corn, wheat, live stock, and dairy products; and to ascertain the expense of furnishing these Radiophone market reports. It contemplates that the broadcasting would be done by the air mail service, Post Office Department, and directed of the manner and means by which these reports may be furnished, what would be necessary for the different cities, towns, and individuals to do to receive the service, and what it would cost to provide the equipment necessary for receiving such reports. It directs the Department of Agriculture and the Post Office Department to make a report of their investigation and findings, with such recommendations as they may see fit to submit, within 30 days from the passage of the resolution. The adoption of the resolution does not involve any expenditure on the part of the government but merely directs an investigation as to the feasibility and cost of this market news service Radiophone."

PETITE MISS LISTENS IN AT TEE



Miss Virginia Res, Coloratura Soprano, stopping in her round on Eastern Links to hear the news

ALL COOKING BY RADIO

Muncie Food Show Puts on Unique Culinary Stunt

MUNCIE, IND.—While an admiring and awe stricken crowd of women looked on, a loaf of bread was baked to perfection recently by Radio at a local pure food show. The actual cooking was done by electricity, current for which was controlled by Radio. Bacon was fried in the same manner. Various foods were to have been cooked in the same way each night of the show. It was said to be the first attempt at Radio cooking and was pronounced a success. The Radio apparatus was placed in one end of the long Chamber of Commerce auditorium and the electric heater in the other.

EXPERIMENT WITH STATIC

Compass Stations of Navy to Conduct Special Tests

(Special to RADIO DIGEST)

WASHINGTON—Plans for the study of the well-known static in connection with its possible relation to storm centers, have been announced by the Navy Department for the summer months. All Radio Compass stations, especially those along the southern and gulf coasts, will co-operate with the Weather Bureau in taking Radio-compass bearings on all static disturbances three times daily, in an effort to determine whether or not there is any connection between the center of electrical disturbances and the centers of storms.

Spring New Scheme For Wired Radio

Farmers to Get Market Reports by Using Local Power Line Sets

(Special to RADIO DIGEST)

NEW YORK—A new scheme for "wired Radio" is in contemplation by certain Radio experts, by means of which millions of farmers now out of the regular broadcasting range will be enabled to "listen in" to market and agricultural reports with small crystal sets, which have a receiving range of 15 to 25 miles.

The scheme takes into consideration the broadcasting of speech by means of the electrical power lines which cover the country with a network of wires. A sending station may be at one end of a wire which penetrates many miles into the "backwoods," and any farmer who is located less than thirty miles or so from this wire, anywhere along the route, can "listen in" with ease, on a low-priced crystal outfit.

Detroit News Orchestra Nightly Feature on WWJ

DETROIT, MICH.—The Detroit News has organized the Detroit News Orchestra, which will be a regular nightly feature of the News' WWJ Radio programs. In addition to these programs, the orchestra will also play elsewhere under the auspices of the News as a compliment to its readers.

THE ANTENNA BROTHERS Spir L. and Lew P. OUT OF RANGE



How to Make a Canoe Receiving Set

Receiving Set Readily Installed in Any Canoe

With the summer and vacation time confronting us, the Radio amateur begins to contemplate the trips to the seashore and the mountains. His receiving set is not forgotten. Receiving should take a natural place in the routine of summer sports.

WORKSHOP KINKS? EARN A DOLLAR—

There are many little kinks worked out at home that would aid your fellow Radio worker if he only knew about them. There are new hook-ups, new ways of making parts and various unique ways of operating sets that are discovered every day. RADIO DIGEST is very much interested in securing such material. Send them in with full details, including stamped envelope so rejected copy may be returned. The work must be entirely original, not copied.

RADIO KINKS DEPARTMENT,
RADIO DIGEST,
123 West Madison St., Chicago, Ill.

Radio sets are found installed on the automobile, in the summer camp, at the seashore, in the mountains, on the sail boat, yacht, canoes and row boats. Even the aeroplane is found equipped with this source of recreation that has fascinated the entire country. As a part of a series that RADIO DIGEST is presenting, on the application of the Radio receiving set for summer-time recreation, the installation in a canoe is illustrated and described.

The loop aerial adapts itself as the most practical for canoe installation. The cross-pieces are made up of two lengths of wood, 6 feet long by 2 inches square, crossed and joined at the center. Dowels are glued in the arms of the frame, as shown, about 1 inch apart, inserting eight dowels in the end of each arm except on top where nine are inserted. The frame is then shellacked with a good grade of waterproof shellac.

The winding consists of No. 14 wire run around the dowels, as indicated in figure 1. Two binding posts are placed on the horizontal cross-piece.

At the base of the vertical arm the threaded pin is inserted. This pivot screw passes through a baseboard and is fastened with a thumb screw from the other side. The baseboard is about 1 inch thick and 6 inches wide and long enough to rest on the gunwales of the canoe. Four hook clamps, passing through the ends of the baseboard clamp the board to the gunwales of the canoe.

The loop aerial is not adapted to use with the crystal set or even a detector vacuum tube set. It is usually very diffi-

LOOP AERIAL USED ON CANOE

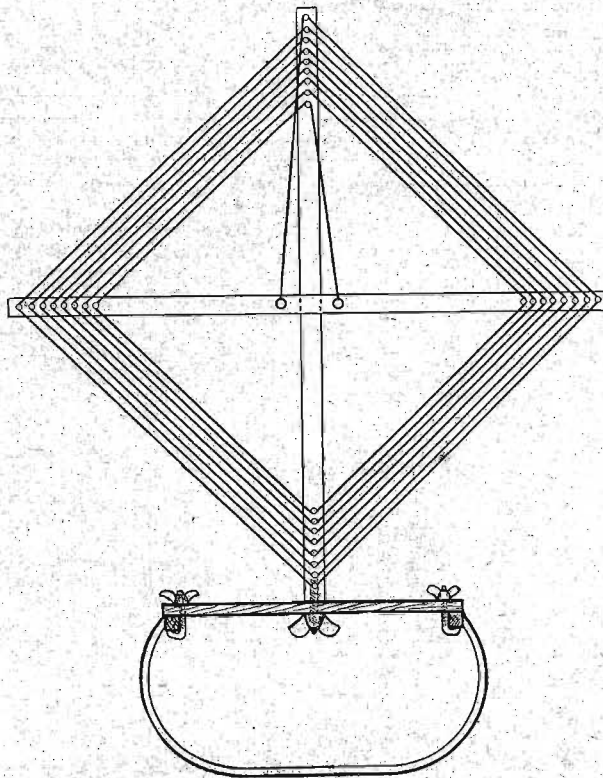

Fig. 1

A very effective way to measure the coupling of a loose coupler is to fasten a ruler, preferably marked in centimeters, on the ends of the primary parallel to the slider, as shown in Figure 1. The ruler may be screwed to the base of the coupler under the rods which support the sliding secondary, in such a position as to be easily seen. This will measure the coupling.

The honeycomb type coil presents a more difficult problem. The old method

Battery Cap Makes Crystal Cup

If you have an old style dry cell of battery which has a metal cap over the center carbon stick, this cap can be of service in your crystal receiving set. Remove the metal cap, drill a hole in the side and tap the hole for a machine screw. When assembled it makes an admirable crystal cup. It can be used for either table or panel mounting by means of the bolt already attached.—James M. Hale.

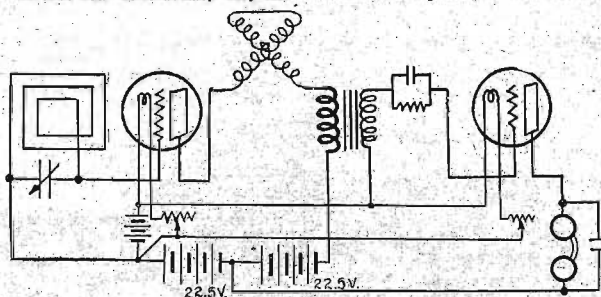

Fig. 2

cult to receive signals sufficiently loud to make them audible and for that reason where the loop aerial is to be used, at least one stage of Radio frequency is advisable.

In Figure 2, a good 1-stage of Radio frequency with vacuum tube detector circuit is shown. It is very desirable to add more stages if the expense is not beyond the limit of the amateur.

Recording Coupling Measures

If it is desired to jot down notes on the position of the instruments while copying

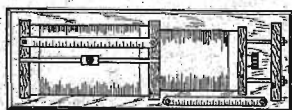

Fig. 1

of measuring with a ruler the distance between their extreme ends is slow and inaccurate. A much easier and quicker method is to place a protractor where the coils separate, at the mounting of panel and then the coupling can be recorded in degrees. The illustration, Figure 2, shows how this may be accomplished. With

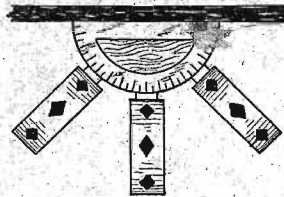

Fig. 2

Winding All Coils Even Makes Them Look Well

In winding coils, both for transformers and receiving sets some trouble is encountered in keeping the turns against one another for the whole circumference of the coil. I have wound quite a number of coils and until I wound my continuous wave transformer I had a hard time of it. My method for winding coils is as follows: The first thing to do is to fasten the spool of wire to be used on a rod of some kind and hang it as near the ceiling as possible so that the wire will be out of the way as the winding proceeds. The next thing to do is to fasten the wire to the tube you wish to wind the coil on, starting the winding at the left end of the tube.

Roll the tube across a flat surface, such as a table top with the right hand and guide the wire with the left. When the center of the coil is reached the position of the hands must be changed as follows: Roll the tube with the left hand and guide the wire with the right.

If this plan is followed out it will be found to give very satisfactory results. I wound a secondary coil of 2,800 turns in three evenings and did the work easily.—John H. Boos, Jr.

Holding Detector Adjustment

To keep a crystal detector in adjustment first find its most sensitive spot by a buzzer test. When the point of the "cat whisker" is adjusted, drop some hot bees wax or paraffin around the point. In practice this has kept the whisker in the right place for months. It eliminates the necessity of seeking the desired sensitive spot every time the set is to be used.

Distributors

FOR

DeForest Radio Sets

All Types

IMMEDIATE SHIPMENT

Head Sets

Vario-Coupler

Variometers

and all necessary parts for constructing your own set.

Write for Complete Price List
Special Discounts to Dealers

THOS. E. WILSON & CO.

42 South Wabash Avenue
Dept. R. D. Chicago

RADIO SUPPLIES STORES

Prompt Service—Quality Goods—Priced Right
Radio Division
TELEPHONE MAINTENANCE CO.
20 S. Wells St. Franklin 3986
5206 W. Madison, Austin 7041. 1122 E. 47th St.

Look for the TELMACO Sign

SELECTOR

A selective radio contact switch. For varying the number of turns in any kind of radio tuning coil. The SELECTOR can be mounted on coupler or coil direct, thus reducing leads to a minimum. Short leads and positive contact in radio instrument wiring are not only necessary, but are imperative for highest efficiency.

The SELECTOR combines these essential features and in addition is compact, positive and will give that commercial appearance to your panel.

ROTORS AND STATOR SECTIONS

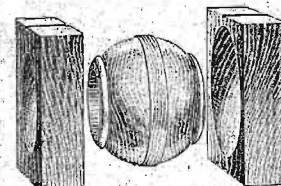

Carefully and accurately made from specially selected and treated woods. Not "mere wood turnings," but manufactured to pattern makers standard.

Rotors packed 50 and 100 in package. Stator sections packed 100 and 200 in package.

Dealers! Send for interesting circular and attractive proposition.

NORRIS ELECTRICAL SPECIALTIES CO., Inc.
126 Liberty Street

STATION KDN FAMOUS IN WEST

Fairmont Hotel Plant Passes Two Year Mark with Many Laurels

Permits No Advertising

Well-Known Broadcaster Helps San Francisco Police Dept. Catch Criminals

By Earl Ennis

(Special to RADIO DIGEST)

The Radio history of the Pacific Coast, like much of the development record of the West, is a chapter of primitive pioneering—of advancement in the face of difficulty, of belief in a fundamental destiny, and of valiant adherence to the minutiae of achievement. In this chapter of hard won success, no one element stands forth more conspicuously than the now-famous Fairmont Hotel Radiophone station in San Francisco—known familiarly to 50,000 nightly listeners as "KDN" in the cabalism of government designation.

The Fairmont Hotel made its initial bow, as a Radiophone broadcasting headquarters more than two years ago. At that time, broadcasting was considered a romance of the east coast, more fanciful and experimental than of practical commercial and entertainment value. To Leo J. Meyberg, head of a San Francisco electrical concern, and Sheldon Peterson, his chief engineer, belong the credit of prophetic vision, which led them to plunge where others feared to tread. Out of this vision was born San Francisco's first systematized Radio headquarters.

Open Station with Surprise

The original installation was a 5-watt equipment, using the well-known Heising modulation circuit. The instruments were installed under the personal direction of Peterson. There were, at that time, approximately 10,000 amateurs in the San Francisco bay district comprising nearly a score of cities and towns, and probably 25,000 amateurs in all, scattered along the immediate coast. To the ears of these, one summer night was brought, over busy air lanes, for the first time, the Fairmont's opening Radio program.

There had been other experimental Radio work done on the coast prior to that date—work that had resulted in various installations, and a partially successful



Station WAAT studio and equipment. Left to right: Adele Rankin, soprano; F. V. Bremer, Radio editor Jersey Review; Gordon Stanley, pianist; C. J. Ingram, managing editor, Jersey Review. Much has been accomplished by the mostly "home-made" apparatus.

demonstration of the possibilities of the Radiophone. But with the advent of the Fairmont hotel station, came regular programs of phonograph music supplied by local music stores. Over night San Francisco awoke to the fact that broadcasting had crossed the Rocky Mountains from East to West and that the first ripple of the New World entertainment, had touched the Pacific Coast.

Service Gains Favor

From that period onward, the Fairmont Hotel won fame for its nightly offerings. From the swaddling clothes period, it advanced into broader fields. From the valleys of the Sacramento and San Joaquin rivers—from rural communities, from farmers in distant points, who read in the newspapers of the Fairmont Hotel programs, came requests for stock and market quotations. This was answered by the Meyberg company with a regularly established stock market and United States Government Weather Bureau service.

Standard quotations were flashed from the antenna of the Fairmont hotel station for more than 1,000 miles inland. Growers and agriculturists grew to depend upon the butter and egg quotations received by Radio from San Francisco, as a valuable asset to their shipping operations. The latest figures over the stock exchange wires, altered the price conditions in the local markets in the San Francisco bay districts and commission houses found the producer intelligently informed on prices of which he had previously been ignorant. The circumstance went down in Radio history as another milestone of achievement.

(Continued on page 9)

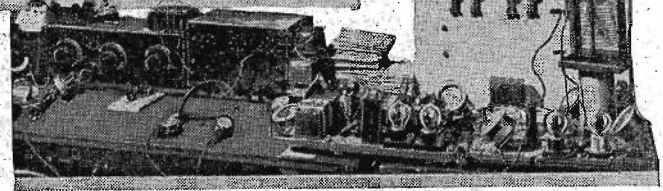

WAAT, Jersey Review Claims Pioneer Honor

Began Broadcasts Before Amateur Stations Were Barred

By Frank V. Bremer

(Special to RADIO DIGEST)

Radiophone station WAAT—operated by the Jersey Review, Jersey City, N. J., was one of the first stations in the United States to operate on a regular scheduled program. The station formerly known as 2IA was licensed as an amateur station and used for the first time on January 11, 1922 for Radiophone work. Previously, except during the war period, Station 2IA had been a spark transmitter.

On January 11, 1922, a regular schedule of Radiophone broadcasting was commenced by the Jersey Review. At that time the ban had not been placed upon amateur broadcasting and the station operated on a wave length of 200 meters. Regular programs ever since that time have been broadcast on Wednesday and Sunday evenings, commencing at 6:57 p. m. with a phonograph record for a tuning test, and continuing for about an hour or a little more.

Heard Over Wide Area

When the government placed a ban on amateur broadcasting, stations 2IA was changed to WAAT and commenced operating on 350 meters.

Low power is used at WAAT and modulation rather than distance is sought. The programs have been reported by over 1,100 stations, having been heard by operators in the first, second, third, fourth, fifth, eighth, and ninth districts. This is remarkable when it is considered, that Station WAAT uses but 2 five-watt tubes for oscillators; 2 five-watt tubes for modu-

lators, and one five-watt tube as speech amplifier. The greatest distance at which WAAT has been heard is Memphis, Tenn., where Station 5EK managed to tune in. Programs from WAAT are regularly tuned in at points 150 miles away and all report exceptionally fine modulation.

Broadcast Concerts Mainly

Programs broadcasted by the Jersey Review are principally of the concert or operatic type, though an occasional evening of dance music and 'Radio party' is broadcasted. That the offerings are appreciated is attested by the enthusiastic phone reports that are received at the station during a program.

On Wednesdays the program is usually a fifteen minute address by a prominent judge, or leader, in some profession, and followed by a concert given by well known vocal and instrumental artists. On Sunday evening a half hour Radio chapel Vesper service is broadcast from 7 to 7:30 p. m. following which a musicale is given.

Experiment With Acoustics

The station is located in a private dwelling where the living room is used as the studio. The room is so constructed that its acoustics are ideal. No trouble is experienced with echos or rebounds. Carpet on the floor, wall hangings, curtains, draperies, etc., make for ideal reproduction.

Most of the equipment is of the so-called "home made" variety and required a great deal of experimental and rebuilding work before the present high efficiency was attained. A system of rectified AC has been worked out that gives exceptionally fine results, and though not used is so arranged that in event of generator trouble, the set can be "thrown over" to the AC with no interruption to the broadcasting. An overheated generator bearing once during a program necessitated this change over, but operators noticed no difference in the quality of the broadcasting.

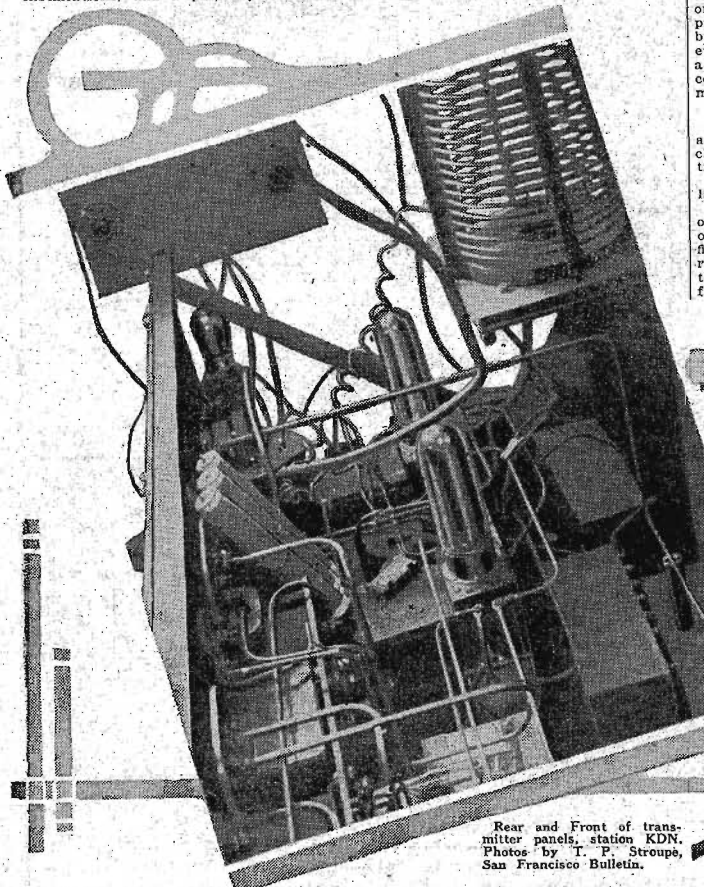

Rear and Front of transmitter panels, station KDN. Photos by I. P. Stroupe, San Francisco Bulletin.

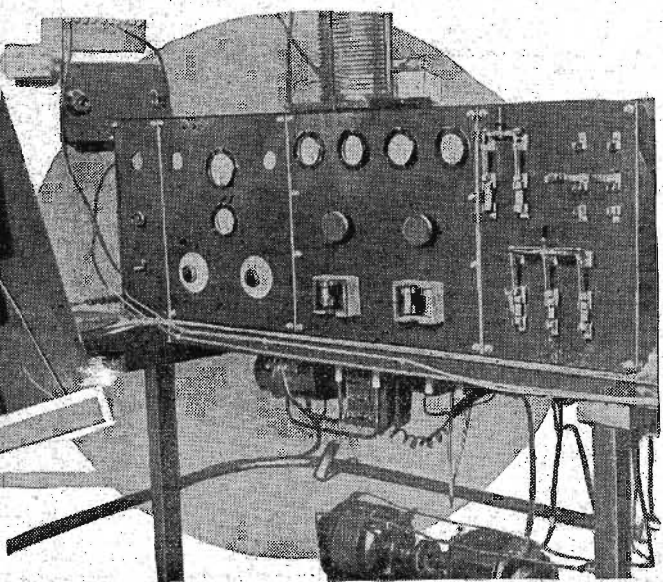

DESCRIBES TRESCO UNIT NUMBER SU-3

SECTIONAL SET PERMITS ADDITIONAL PARTS

Is Licensed Under Armstrong Patent—Provided with Battery Panel and Ammeter

(See Diagram, Page 7)

The set shown in this number is the Tresco Sectional Universal Radio Receiving set No. SU-3, manufactured by the Tresco Radio Company of Davenport, Iowa. The circuit is the Armstrong Regenerative, licensed under patent 1113149.

This Sectional Receiving set consists of 3 separate units sold either jointly or separately as desired. Unit No. 1 shown on the left in the front view is the tuner and detector, a complete Radio Receiver in itself when the vacuum tube, "A" and "B" batteries and phones are added. Unit No. 2, the center one shown in the diagram, is a storage battery cabinet that offers a little relief from the monotonous uniformity of the average standard receiving sets. The "A" storage battery is hidden away, eliminating the usual unsightly wires. An ammeter indicates the flow of current to the filaments when the battery is discharging. Binding posts in the rear offer a means of connections for recharging battery as desired. The ammeter under these conditions indicates the actual charging current. Unit 3 shown on the right of the section is a 2 stage amplifier. A top and base furnished with the three units permitting them to set into the base and top without the addition of screws or bolts.

Inter-Unit Connections

When the three units are set in the base, the four binding posts on the right hand side of unit No. 1 line up with the four on the left hand side of unit No. 2. Likewise the four on the right hand side of unit No. 2 are in line with the four on the left hand side of unit No. 3. These binding posts are connected in pairs, tuning up with each other as indicated in the diagram. The two binding posts on the right hand side of unit No. 3 are for the control of the phone receivers or loud speaker.

Battery Connections

Looking at the set from the rear, we find that the center or battery cabinet provides ample space for the storage battery. The negative terminal of the "A" battery connects to the one terminal on the ammeter wire. The positive terminal of the battery connects to the binding post, next to the second lowest binding post on the right hand side (rear view). In diagram the battery is shown outside of the cabinet, merely to avoid the obstruction of the interior view.

The battery can be installed inside of the detector unit with ample room to spare. The two binding posts on the base of the center unit (rear view) are the terminals for connections, when charging the storage battery, or can also be used for the battery connections to the loud speaker when desired. The right hand unit in the rear view is the tuner and detector, the "B" or plate battery of this unit, should be of the 22 1/2 volt type. The positive side is connected to the wire running from the vacuum tube socket, the connection for the negative side is for the lower wire running from the interior. The two binding posts on the base of the detector unit, are for the aerial and ground connection, the one to the right for the antenna lead, and the one to the left running to the ground.

The amplifier unit requires three 22 1/2 volt "B" batteries, connected in series. The positive terminal running to the wire on the left hand side (rear view) and the negative terminal with the wire on the right hand side. Likewise these batteries can be inserted in the amplifier panel. These panels are furnished with doors in rear, keeping the batteries dustproof, and eliminating the necessity of unsightly battery boxes in the neighborhood of an otherwise very decorative receiving unit.

Tuning Control

The dial in the upper left hand corner of the detector unit, operates a variable condenser in series with the tickler coil, thus controlling the finer adjustment of the plate or feed back circuit.

The other dial in the detector unit operates the variable condenser, shunted across the secondary coil, thus controlling the finer tuning adjustment to proper wave length of the secondary circuit.

The knob of the tapped switch directly under the nameplate, controls the tapped winding of the primary coil. Therefore, this knob is the means of tuning the primary or antenna circuit to the proper wave length.

The knob of the tapped switch on the left hand side, controls the adjustment of the tapped winding on the secondary coil thus permitting the adjustment for tuning of the secondary circuit by means of the variation in the inductance of that coil. The lower tapped switch controls the adjustment of the tapped winding of the tickler coil, in this way permitting an increase or decrease in the inductive effect

in the plate or feed back circuit.

The knob in the lower right hand corner of the detector unit operates the filament rheostat, and therefore, controls the voltage of the filament current in the detector vacuum tubes. The two similar knobs in the amplifier unit likewise control the voltage of the current to the filament of the amplifier tubes.

The ammeter in the battery panel, as stated before, indicates the charge and discharge of the "A" battery.

Tuning

The tuning of this set is very similar to that of any other standard set of the same type. The filament rheostats should be adjusted for the proper point of incandescence of the tube filaments.

The primary knob is set for the proper wave length, then the secondary is adjusted in conjunction with the tickler knob. Finer control of adjustments is accomplished by means of the two dials on top. The taps are not so numerous in number that tuning would be difficult, in fact the adjustments are so limited that the number of combinations require very little waste of time in tuning, and thereby causing loss of part of the broadcasting.

The actual wave length range of this set runs from 160 to 600 meters.

Involute Coils

The Involute Coil, used by the Tresco people, is a type which they have been successfully using for a considerable length of time. They are of the Spider Web Type, and the three coils are wound in a compact unit. The theory is very similar to the average spider web coil and requires no special explanation.

Detroit Radio Firm Expands

DETROIT, MICH.—Expecting an unprecedented demand for Radio parts in the fall and winter months, the Fisher Tool & Supply Company of this city has announced a large expansion. The firm as a result of the expansion is in a position to supply whatever is needed in Radio manufacture. The company of which Roy R. Fisher is president, is sole distributor in the middle west for the Bakelite Company and Frost Radio materials.

★ Radio Bugs! ★
Try This on Your Cat's Whisker
To the tune of Yankee Doodle

Price \$10

Gregg's Listen In set, is a marvel, you bet. Through which the waves come abuzzin'.
Attach to the phone you now use alone. And the program is heard by a dozen. Yes, a dozen hear the news. A dozen hear it dandy. Everyone should have Gregg's Set. Because it is so handy.
The family should get Gregg's Listen In set. Does for all, even uncle and cousin. No more all alone. Does one use the phone. The set sends it out to a dozen.

Write for Catalogue
Gregg Company
Room 505, 35 South Dearborn Street
CHICAGO

Predicts Television By Radio in Near Future

Nikola Tesla Says No Limit to Distance

Nikola Tesla recently predicted that television, a method of seeing by Radio, soon will be in as common use as the telephone. There will be no limit to the distance of such transmission, predicts Mr. Tesla, so that we may be able to talk to and see at the same time any person in any part of the world. Mr. Tesla will be remembered for his research in power transmission by Radio.

RADIO FOR THE BEGINNER

tells you what you want to know about radio. It explains the principles of radio, the vacuum tube, radio tuning, etc., in plain language, and will help you make your set work better. Handy pocket-size book, price \$7.00. Order to-day.
ALFRED FOWLER
19 Board of Trade, Kansas City, Missouri

RADIO MAILING LIST

6646 Radio Retail Dealers, per M. . . \$7.50
681 Radio Jobbers, for list . . . 7.50
824 Radio Manufacturers, for list . . . 7.50
and any other list you want.
Trade Circular Addressing Co.
186 W. Adams Street Chicago, Ill.
Phone FRANKLIN 1182

Tresco

SECTIONAL UNIVERSAL

Licensed Under Armstrong U. S. Patent No. 1,113,149

Seven Years in Radio

Think What That Means!

The Tresco Tuners were among the first ever made under the Armstrong patent. They are found in all parts of the world, giving satisfactory service. The sectional idea is original with Tresco.

The Set Consists of Three Units:

- Tuner and Detector Unit \$50.00
- Two-Step Amplifier Unit 35.00
- Unit for holding "A" Battery 9.50

Top and Bottom, which when added to the three other units, make a complete section all in one.

Each, \$5; both 10.00
Complete Set, total, \$104.50

The units when assembled make a cabinet 40 inches wide, 15 inches high and 10 inches deep.

Tresco Sectional Universals

are being supplied to dealers and jobbers just as fast as possible. Order from your local dealer. If he cannot supply you, send us the price of set desired, and we will fill your order.

Dealers and jobbers are rapidly finding out that TRESCO is one of the very few manufacturers actually in position to take care of large volume orders for immediate shipment. Liberal discounts are given to jobbers and dealers for quantity orders.

We do not furnish vacuum tubes, head sets, batteries or loud speakers.



WE ARE DISTRIBUTORS FOR FROST RADIO MATERIALS

DEALERS: WRITE--PHONE--WIRE FOR OUR PRICES!

ORDERS FOR "FROST FONES" TAKEN ON GUARANTEED SHIPPING DATES.
ALSO DISTRIBUTORS FOR CUNNINGHAM TUBES
WE ARE DISTRIBUTORS IN BAKELITE DIALS AND SPECIAL BAKELITE PARTS



DEALERS ATTENTION!
NOW IS THE TIME TO GET IN LINE WITH A REAL NATIONAL RADIO DISTRIBUTING ORGANIZATION
GET BUSY!
IMMEDIATE DELIVERY ON PLUGS AND JACKS



FISHER TOOL & SUPPLY COMPANY

CHICAGO OFFICE: 234 SOUTH WABASH AVENUE
GENERAL OFFICES: 254 WOODWARD AVENUE DETROIT MICHIGAN

Radio Receiving Sets

Tresco Sectional Universal Unit SU-3

Antenna

Pursuant to the policy of RADIO DIGEST to contain material of interest and help to beginners, the ninth of the series of standard receiving sets is given herewith.

The set shown below is known as the Tresco Sectional Universal Radio Receiving Set No. SU-3, and is manufactured by the Tresco Radio Company, Dav-
enport, Iowa.

The front and back views of the unit show clearly what the various parts are and how they function. Although the novice may not possess a set of this manufacture, careful study of the photo diagram will aid in the understanding of the operation of his own apparatus. Complete instructions on the unit and details of its working will be found on page six, column one, this issue.

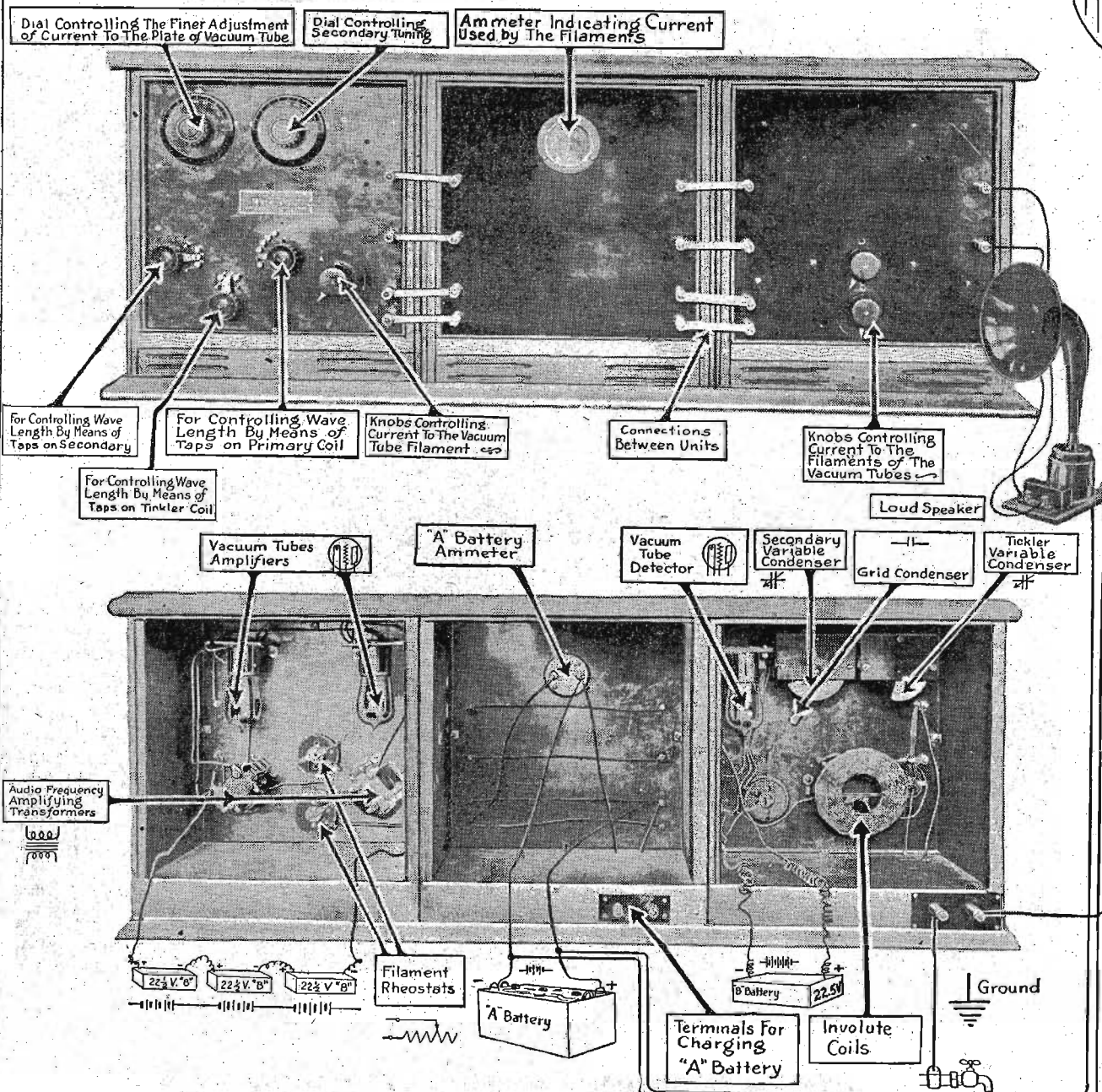

Radio Digest Illustrated

E. C. RAYNER, Publisher
123 WEST MADISON STREET
TELEPHONE STATE 4844-4845
CHICAGO, ILLINOIS

New York Office 2126 Broadway
Detroit Office 28 Rowland Building

PUBLISHED WEEKLY

SUBSCRIPTION RATES
Yearly.....\$5.00 | Foreign.....\$6.00
Single Copies, 10 Cents

Entered as second-class matter April 27, 1922, at the post office at Chicago, Illinois, under the Act of March 3, 1879.

In a new scientific field where many writers are contributing articles there will arise some controversy over the expressions of opinions and statements made from time to time. Some of these controversies may be taken into the courts for settlement. The priority of inventions may be claimed as well as the merits of some part entering into the construction of the radio apparatus. The Radio Digest is an outlet for these expressions and the publisher disclaims any responsibility for opinions or statements made in connection with radio apparatus. The news will be printed as it comes to us.

Vol. 1 Chicago, Saturday, June 24, 1922 No. 11

Radio and Church Collections

Remember Those Who Cannot Go to Church

THERE are many invalids who cannot possibly attend church, and for their benefit Radio church services are the finest thing in the world. But for good able bodied men and women it hardly makes a substitute for worship in person. While the person who relies on his receiving instruments alone for inspiration in his spiritual life is missing much, he can help materially by inviting in his neighbors not so fortunate physically or financially. It should be remembered by those who attend church or who listen in without cost that the making of contributions aids in continuing the exercises, thus enabling those who cannot attend the services to receive much from the music and sermons.

Small Town Best Field for Radio

Better Chance for Radio to be Found in Rural Districts

THE logical field for the Radiophone is in the small country town. The department of commerce tells of a community broadcasting set which has a low wave length and which is practically free from interference. With a set of this type installed in the village, important news, concerts and public lectures can be broadcasted and every citizen in the township surrounding can get the program with his receiving set. Where other means of communication are more difficult to maintain the Radiophone can bridge the gap with ease.

The Airphone, like motion pictures and interurbans, means more to the small town and the farmers than to the city dwellers. Persons residing in large centers are ordinarily jammed with multitudinous distractions. The people in the small towns can best appreciate the utilitarian and entertaining advantages of Radiophony.

Radio Broadcast Advertisements

Airphone Advertising Will Kill Fan Interest

YOU will remember the days when you paid your money to see a motion picture show and between "acts" you were compelled to read over, or sit with your eyes closed to prevent reading over, a whole lot of local still picture advertisements. Then along came the "bright idea" fellow and put across a movie film with the same sort of "kill time on your money" advertisements. Do you recall how bitterly you were opposed to such a thing? It really hurt a number of movie theaters, and the owners wondered what was the trouble.

The same propaganda now confronts the Radiophone broadcasts. Do you wish to tune up your receiving set and sit back to take in a good concert or listen to something interesting and instructive and get for your trouble, "You can save dollars if you trade at Wanacoopers."

Suppose a delightful soprano voice has just sung your favorite song—"Kiss Me Again," "Little Gray Home in the West," or whatever it may be—and you are just drawing a deep breath, sorry it's over, and you are saying to yourself, "Gosh that was a dandy! Made me think of someone I used to know who sang that song." And then, all of a sudden, a voice says, "Good morning! Have you used Hare's Soap? Be sure to buy Goodberry's Facial Cream. Save the surface and you will keep that schoolgirl complexion!"

Do you like the idea? Something must be done about it—government regulation perhaps. Maybe you have found an answer to the question of who will eventually pay for broadcasting when the saturation point in sales of instruments is reached and if advertising is prohibited. The right place to stop anything dangerous is just before it starts. The broadcasting of advertising matter comes in the "dangerous" class and it must be nipped in the bud.

Radio Digest Comment

Views of Central and Western Editors

WHEN your set refuses to work what will you do? Heretofore everybody who had a small manufacturing establishment started in to make receiving sets, but there will be a time when aid will be required to keep these sets in working order. A service man will be needed. The Jobber's Salesman (Chicago) has an editorial on maintenance service as follows:

"When Radio settles down to a steady business a new responsibility will be placed upon the manufacturers and distributors of sets, it is said in some quarters. The users of the Radiophones will demand service in much the same way that the automobile owners or the telephone subscribers demand that their equipment be kept in operation.

"Some manufacturers are already taking steps to establish service departments, where the bewildered Radio fan may summon aid when the set refuses to work. A few dealers today in selling sets quote prices for installing and two or three months' service.

"This tendency, experts assert, can be expected to increase until the owners of a particular kind of receiving apparatus will have their sets inspected at regular intervals, renewal of parts made when needed and the instrument kept in first class order at all times."

Radio has covered quite a number of years' time for its arrival at the present stage. It has been quite a few years since the first inventions for transmitting messages were brought out. The Denver Post reviews the history of Radio as follows:

"Radio today is the one thing we hear about, dream about, write about, yet we venture to say that there are few who can trace, at least in part, its development from the beginning. The following is a short and concise outline of Radio development since its beginning.

"The first name mentioned in connection with telegraphy of any kind is that of Savary, in 1827. His experiments eventually led up to the invention of the line telegraph by Morse in 1837. Even at those early dates Radio was talked about, but the conception at that time was far different from our present day ideas.

"The scientists of this time searched diligently for some means of employing the earth or waterways as means of conducting electric currents, but were much disappointed with the cost and impracticability of the project.

"In 1867 James Clark Maxwell predicted the coming of the propagation of electric energy through space, but it remained for Heinrich Rudolph Hertz, in 1887, to produce and measure the magnitude and length of electrical energy now known as Hertzian waves. This is really the birth of Radio.

"The efforts of other scientists, such as Trowbridge and Branly, served to add impetus to the general theory, and in 1896 the world awoke to find itself the possessor of the first real Radio patent taken out by Marconi, generally conceded the title of the "Father of Wireless."

We all know that Radio has fallen upon us almost instantly. There are many things yet to be learned, and before another year passes receiving sets will have attained a high degree of efficiency through the efforts of the many manufacturers and interested amateurs. We all know the demand for outfits at the present time and manufacturers are beginning to meet the needs. The editor of the Spokesman-Review (Spokane, Wash.) writes:

"The manufacture of apparatus for the transmission and reception of Radio waves has grown over night into a sizeable industry, and even at that it is just beginning to grow. If the prophets are true prophets, and if America is destined some day to have as many Radio outfits as it has telephones, it is easy to see that the thing for the discerning young man to do is to start a Radio factory on a small scale, and let the wave of electrical progress carry him to fame and affluence.

"Trade reports say that the demand for Radio outfits is a long way ahead of the supply, and that manufacturers cannot turn this sort of apparatus out fast enough. A good many of the contraptions being sold are only playthings, and will not be in demand after the first wave of curiosity has subsided, but the making of really serviceable sending and receiving sets rests on a solid basis, and has a great future. The scheme of Radio telephony is passing through its first stage, which is one of excitement and confusion. Not until later shall we be able to know its permanent value to society."

There is no doubt but what the airphone is much needed in places where news is retarded, either by location or inability to be reached by daily mail or telephone and telegraph lines. The editor of the Chronicle (Ketchikan, Alaska) makes this statement in his editorial:

"The day of extreme isolation is rapidly disappearing in the remote corners of the earth. Radio telephony is responsible, according to T. Wood, chief clerk of the lighthouse service, who reports that even the most isolated lighthouse stations now are getting in touch with the news of the day.

"At one station where the keeper of the lighthouse received but one mail in a year, he is now equipped so that he may talk with other stations, or listen in for the concerts or information sent out broadcast. Also, he is able to get in touch with any ships that may come his way. Thereby, his life and health and that of his assistant is better protected."

RADIO INDI-GEST

Radio All Over the Globe

The radio craze continues to spread. Soon it will be around the world. Then look out.

For when China, Poland and Zululand start to broadcast someone is going to need an interpreter with about ninety-three languages, dialects and jargons ready for action.

Imagine sitting in with a parlor Radio outfit. "Bo-la, glub, blup, bub." Gasps as the grand opera selection is interrupted. Follows the interpreter.

"It's only a kaffir making love to his dusky sweetheart." So much for that and the opera selection is resumed.

"Chee klick il se," comes over the Radio and

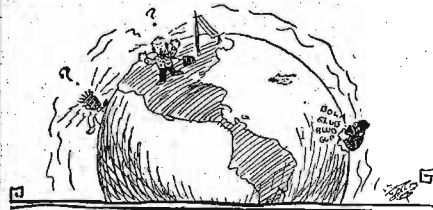

once again the interpreter comes to the rescue. "It's only the missing link somewhere in darkest Africa calling to its mate." That's that.

On with the concert, only to be interrupted again. This time it's different.

"Dearie, can I have \$37.48 for a new hat—I should say not, whaddye think I am, a millionaire?" Just a husband and wife accidentally broadcasting a little family opera.—Transcript, Peoria, Ill.

The Song of the Nut

One day I thought that I would get
An inexpensive Radio set;
I thought its entertaining tone
Would save me many a hard-earned bone,
Heigho! Heigho! For Radio!

The things 'twould do, the things 'twould say
(All Radio fans start out this way)
Would furnish entertainment cheap
And at the home the children keep,
Heigho! Heigho! For Radio!

But soon I got the Radio craze
And spent much cash in many ways,
The latest wrinkles soon I bought,
The whole darn family's now distraught,
Heigho! Heigho! For Radio!

For sets and jimcracks I'm in deep,
But everlastingly I keep
A brying Radio this and that
It's great, but oh! I'm busted flat,
I owe, I owe, for Radio.—Chicago Daily News.

Broadcast That Calls for Help

Sunrise, a. m.—Brennan's scheme eliminates electric chair and hanging. Condemned get national capital punishment by being chained to receiver tuned to Congress and talked to death.

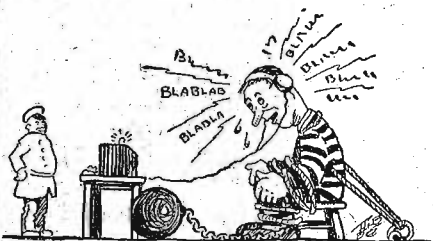

An Answer for Mr. Henpeck

Dear Editor.—In answer to "Henpeck's" question under Radio Indi-Gest in the June 3d copy of RADIO DIGEST, I suggest that he try another hook-up.—Fred W. Oliver.

Inhale, One, Two, WOP!

The Radiophone is a great invention, but it is fraught with dangerous possibilities. When we go to the door or window for fresh air we breathe in Radio songs, market reports, political speeches and jazz.—Messenger, Grapeland, Texas.

Paul Would Need a License

If the Radiophone had been in existence in Paul Revere's time that wild ride on a horse would have not been necessary at all. He would have bawled his message into the broadcaster, then the rest of us would have jumped into our autos and airplanes and given 'em fits.—Messenger, Grapeland, Texas.

Characteristics of Vacuum Tube Amplifiers

By Benjamin F. Miessner

It has been shown in the preceding article that vacuum tube rectifiers may cause considerable distortion in the audio frequency wave form, with a resultant loss in exactness of sound reproduction. The reason underlying this distortion was shown to reside in the curvature of the characteristic curve for the rectifying tube.

It may be remarked here that some other types of rectifying devices, while perhaps not so sensitive as the tube rectifier, may function with very much reduced distortion. The sensitivity, it will be remembered, depends largely on the sharpness of the rectifying bend and on the steepness of the curve beyond it, while low distortion depends on the sharpness of the bend and the lack of curvature of the curve beyond the bend.

Crystals Give Less Distortion

These characteristics are shown in Fig. 24. A represents an insensitive and badly distorting rectifier; B shows sensitivity but still bad distortion; C shows insensitivity but no distortion; and D indicates high sensitivity and absence of distortion.

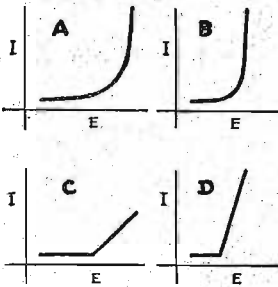

FIG. 24

Obviously a characteristic such as D is the most desirable for Radiophone reception. Some types of crystal and electrolytic rectifiers possess characteristics approaching that shown in C, and actual tests have shown that receiving apparatus with crystal rectifiers reproduces with less distortion than the usual vacuum tube rectifier. Certain special types of rectifying tubes have been constructed, however, which possess both high sensitivity and low distortion.

Purpose of Previous Articles

The preceding installations in this series, while dwelling at considerable length on rectifying tubes and characteristics, has now fulfilled its most important mission, that is, to provide a thorough understanding of the principles underlying the operation of all types of vacuum tube devices based on pure electronic discharge phenomena. At the same time they have served to acquaint us fully with such a device as used for one important function in Radio reception.

The discussions relative to vacuum tube amplifiers which will now follow will, for this reason, be comparatively easy to understand without the necessity for a pains-

taking attention to fundamentals in the treatment.

Vacuum Tube Amplifiers

The ability of a vacuum tube to amplify alternating currents resides in the control of the electron stream between filament and plate, provided by the grid electrode. This electrode, merely by the nature and amount of its electrostatic charge, has the power to control, with practically no expenditure of energy, the flow of current through the tube. Like the catalytic agent in chemical reactions, it possesses a great power of control without being itself controlled.

Since the current in the plate circuit depends from moment to moment on the potential of the grid with respect to the filament, it will be seen that the greatest change in plate current is produced by the greatest change in grid potential. It is a fundamental principle then, when desiring the highest possible amplification of changing currents, to impress the highest possible potentials between the grid and filament, and corresponding in form to the currents or voltages to be amplified.

Types of Amplifiers

In Radiophone reception the function of amplifiers is to increase the energy of currents, themselves too weak for proper reception, to a point where they are sufficiently powerful to actuate the final sound producing device in the desired manner. Such amplifiers are not confined to Radio but find important use in other fields, including long distance wire telephony and many kinds of laboratory research.

There are two general types of amplifiers used in Radio reception. One is the audio frequency type, used to amplify the received currents after rectification; the other is the Radio frequency type, used for amplifying the received current before rectification.

Nearly all amplifiers now used in Radiophone reception employ the audio frequency system, and this type will therefore be given first consideration.

Point of Best Amplification

In Fig. 25 is reproduced one of our earlier characteristic curves (Fig. 13), showing the variations of plate current with grid potential for several values of

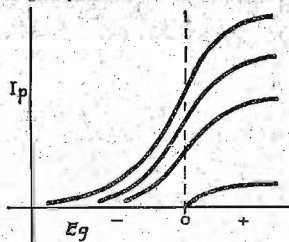

FIG. 25

plate voltage. This represents roughly the characteristic of small tubes of the receiving types now in general use. It will be observed that the region of greatest steepness and consequently highest ampli-

fication exists at a grid potential of zero volts. This means that if the grid be connected through its input circuit to the negative terminal of the "A" battery, its potential will be zero and maximum amplification will be obtained. This is not always the case, however, as sometimes the filament rheostat may be in the negative leg of the battery circuit to the filament, in which case the grid voltage may be one or two volts negative.

Tubes also vary as to the best grid voltage for maximum amplification, so that if the very best results are desired a grid potentiometer should be provided for accurate adjustment.

High Voltage and Ionization

Obviously the greatest amplification will also be produced, using a tube of such characteristics, when the highest permissible plate voltage is applied, inasmuch as the curve steepens with that voltage. There is a limit to that voltage, however, which is determined usually by the perfection of the vacuum, known commonly as the "hardness" of the tube. With practically all tubes there is some point at which either the residual gas is ionized, or a small amount is driven from the metallic parts, such as the plate, and ionized.

In any event the resultant ionization effects completely alter the performance

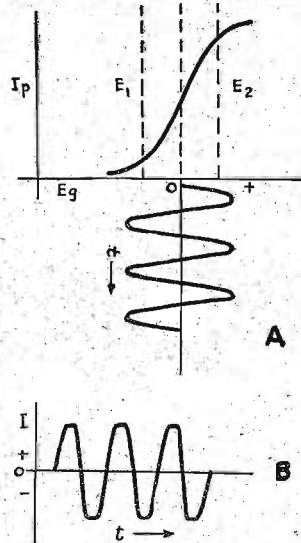

FIG. 26

of the tube. Ionization occurs when the electrons attain a sufficient velocity to break up, by collision, the gas molecules which they strike, forming two or more parts carrying positive and negative

charges. On this account the ionization greatly complicates the action of the tube.

Tube Distortion

Irrespective of the kind of amplification used, there exists certain fundamental causes for distortion in amplifying tubes themselves which must be guarded against. Chief among these is the curvature of the characteristic at the ends of the comparatively straight central portion. If the impressed voltage extends beyond this central portion, the peaks of amplified wave forms will tend to be flattened as shown in Fig. 26 B.

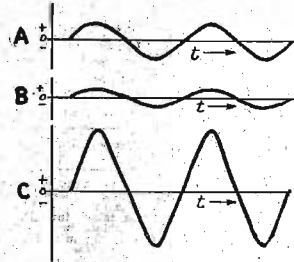

FIG. 27

It is seen in Fig. 26 A that the operating range of grid potential extends at most from E_1 to E_2 , indicated by the dotted lines. With these limits, the greatest output will be obtained without serious distortion. Less distortion, however, may be obtained at a decreased output by restricting the limits so that the operating part of the curve is more nearly rectilinear.

Peak Flattening Effect

Graph A of Fig. 26 shows that the impressed voltage to be applied extends beyond this low distortion part of the tube characteristic, so that the current limiting or "cut-off" action of the tube comes into play. Graph B shows that the output wave form, instead of being an exact but magnified counterpart of the original input wave form, has its peak portions cut off or flattened out as a result of the flattening of the tube characteristic at its two extremities.

It should be noted here that in the magnified wave form, only the ordinates are increased by amplification. The abscissae, of course, remain constant, as they represent time intervals which are the same in the two graphs. This causes an apparent change in the wave form as viewed by the eye, but the actual time rate of variation is maintained in correct ratio.

This effect is shown in Fig. 27, where A, B, and C, all represent the same wave form, the curve of sines, of identical frequency but of different amplitudes. A sound represented by these wave forms would be weak in B, louder in A, and loudest in C, but the quality of the sound would be the same in all.

Editor's Note—The next installment of Mr. Miessner's instructive series of articles will appear in the July 5 issue of RADIO DIGEST.

The Plain English of Ether and Ether Waves

By Letson Balliet

AIR waves and ether waves are different. We know that both light and heat waves come from the sun. We know that there must be something to conduct these waves, for they could not come through a vacuum. We know that whatever it is that fills the space between here and the sun is not air, because the air film that surrounds the earth is only 40 miles deep, while the sun is 93,000,000 miles away. There is no air in space. In fact, the space between the stars comes as near being pure nothing as we can imagine, but there is something that conducts the heat vibrations or waves more rapidly than air will conduct them. We will call it "ether."

Use Spectroscope

If we undertake to analyze the heat and light waves we use the spectroscope, which separates the waves by their wavelength, giving us the seven colors of the rainbow, or the colors of the prism. Light and heat waves come together. As we commonly see the light of the sun, of the fire and the electric light we know that they have both heat and light. The raindrops, the prisms and the spectroscope reflect all of the visible light waves. A green light differs from the red light only in the length of the ether waves. Yellow, violet and blue differ only in wave length.

Violet Waves Shortest

The violet waves are very short. The blue waves are a little longer, green waves are still longer and red waves still longer, though they come several million to the inch. To the unaided eye these waves

come mixed and we see a blended color of light; in some lights we have one wave predominating over the others.

But the light waves are not all the waves coming through the ether. There are still other longer waves, which are invisible and are called the "infrared," or heat waves. Thus the only difference between the visible light waves and the heat waves is that the heat waves are the longer number of long heat waves than it has visible light waves. In other words, there is more heat energy in an electric light than there is light energy.

Wave Lengths Discussed

And now, if we advance still farther, we pass into wave lengths that are longer than the heat waves. These are the Hertzian waves, or wireless waves, and may range anywhere from one-fiftieth of an inch to several miles in length. These are the waves that we must make to send a wireless message and these are the waves we must catch and amplify into sound waves in order to hear them.

Now, we know that a dog can hear a fainter sound than a human ear can detect, and that a dog howls with pain at the ringing of a bell, which is due to the height of the waves, not to the length of the waves. The dog's ear drum is "tuned" more sensitively to catch shallow or faint waves than the human ear, hence a deep or loud wave continuously vibrating makes the dog howl with pain and anguish.

In order that the human ear may be able

to detect the vibrations that are as faint or even more faint than those that are detected by the dog's ear, the vibrations must be amplified by some means. In other words, their pressure or strength must be increased. As a comparison, a pipe line carrying water or oil a long distance might have a booster pump installed somewhere along the line to increase the pressure, or the electric current generated at, say, 2,200 volts pressure could be passed through a transformer and brought out at a pressure of 100,000 volts for transmission to great distance. If it was passed the other way through a series of transformers it could be stepped down to two or three volts, or even to a fraction of a volt, which would be so low that its detection would be impossible. It is on this principle that the amplifier works. It increases the pressure or size of the vibrations until they are of sufficient size or strength to operate on the human ear drum. These vibrations can be amplified by a series of amplifiers until concerts can be given in great auditoriums or speakers heard for blocks away from the amplifying apparatus.

All of this seems very simple, but it would result in nothing but discord and a jumble of sound waves if it were not possible to tune out all the vibrations except those wanted.

Tune for Waves

Figuratively speaking, the electricians have been able to "tune" electric vibrations so that they can obtain light waves, or from the same circuit obtain magnetic waves to turn a motor, and again, from the

same circuit they can obtain heat waves to cook your food. The electric vibrations travel with the same speed as the ether waves that bring our light; hence electricity is used for sending or creating the wireless waves. Whether there are ether waves in electricity as generated, or whether they are capable of transmitting their vibrations to the ether I do not know, but we do know that electric actuated waves come through the ether to the receiving station, just as we know that heat waves and light waves come through the ether from the sun.

Must Meet Resistance

We also know that the further away we go from the earth the colder it gets, aviators and temperatures on high mountains have proven that, and it will surprise many of us to know that the space between the earth's atmosphere and the sun is absolutely dark, and the temperature is down to absolute zero. In other words, traveling heat and light waves through the ether give neither heat nor light till they meet resistance or interruption in the earth's atmosphere. Neither will electric vibrations give off heat or light till they meet resistance. While it is impossible to make electric transmission lines at absolute zero, it is a common sight to see ice and snow upon electric wires carrying thousands of horsepower which may lead to electric furnaces where 3,000 or 10,000 degrees are in use.

Editor's Note—The third of Mr. Balliet's everyday language explanations of the wonders of Radio will appear in the July 1 issue of RADIO DIGEST.

Radio Telephony for Amateurs and Beginners

Part VI—Section I: Crystal Detectors

By Peter J. M. Clute

To Explain—

The following article by Peter J. M. Clute is a continuation of his series. Articles to come are:

- VI. Detectors: Crystal and Vacuum Tube, Section II Vacuum Tube.
- VII. The Batteries.
- VIII. Receivers and Loud Speakers.
- IX. Crystal Detector Receiving Sets.
- X. Vacuum Tube Receiving Sets.
- XI. Amplifiers.
- XII. Useful Information.

The process of tuning the receiving circuit to the incoming Radio-frequency waves had been described in the previous part. These high-frequency currents are then converted, through the medium of the detector, into direct current, so that with the aid of the telephone receivers the incoming signals are rendered audible to the ear. This device, therefore, performs the function of converting the Radio-frequency oscillations of the antenna circuit into uni-directional pulsating currents.

High frequency oscillations are far in excess of the limiting frequency of vibration to which the ear will respond. Under normal conditions, vibrations whose frequencies are above 10,000 cycles per second are inaudible. The diaphragm of the telephone receiver vibrates at frequencies between 500 and 1,000 cycles per second.

Of the various kinds of detectors only two are commonly used, namely, the crystal detector and the vacuum tube detector.

The Crystal Detector

The crystal detector (Figure 1) consists essentially of a piece of mineral, such as listed below, upon which rests with light pressure a sharp metal point,

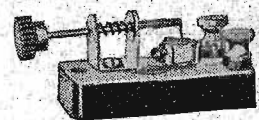

Fig. 1

or a piece of some other mineral. The crystal is generally mounted in a metal cup, which forms one terminal of the detector. The pointed contact is adjustable so as to be moved over the surface of the crystal, until a point is found where signals are clearly received. Figure 2 shows a weatherproof and dustproof galena crystal detector. Some of the minerals which possess the valuable property of rectification are: Galena, carborundum, silicon, tellurium, zincite. Some crystals are more sensitive than others because they are better rectifiers. All crystal combinations act as rectifiers, that is, current can only pass through the detector in one direction. Alternating current is changed to direct current by the detector. Naturally, this direct current is a pulsating one, inasmuch as there is no current flowing during the time that the alternating current is applied in the negative direction. The high-frequency currents received in the tuning circuit vary the same as the transmitted electro-magnetic waves vary with the speech or sound vibrations. The pulsating direct current thus passing through the detector and telephone receivers varies in strength in the same proportions, thereby causing the receiver diaphragms to be vibrated by the magnetic variations in their windings and so give off audible waves.

While it is not as yet definitely known how or why a crystal detector acts as it does, it is quite evident that it works, in effect, as a rectifier. The sensitivity of a crystal is a measure of the degree of its usefulness as a rectifier of high-frequency currents. In order to get as much

contact with them as possible, crystals will work much better and more efficiently, if mounted in a soft metal alloy. An alloy, known as Wood's metal, is commonly used for this purpose. When the crystal is held by set-screws, or in a fuse clip, there is added, in effect, another metal point, working in opposition to the one already provided. Under these adverse circumstances, the current can not flow through the crystal detector in either direction.

Sensitiveness of the Crystal

The value of a crystal detector lies in its sensitiveness to the incoming oscillations, in addition to its stability of adjustment. Some crystals will give good signals on currents which give no sound at all on other crystals. Furthermore, crystals of the same material differ greatly in sensitiveness, and some of them have only a few sensitive spots on the surface.

Many crystals, such as carborundum, operate better with a low-voltage battery connected across them. The small current supplied by this battery must flow

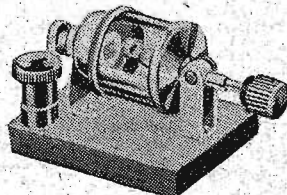

Fig. 2

in a certain direction through the crystal, the amount of current being adjusted by means of a potentiometer. Carborundum requires a firm pressure of the contact point to obtain audible signals. It is one of the most stable detectors but it is not very sensitive, unless a battery is connected across it as explained above. A connection of this sort is shown in Figure 3.

Galena, with a fine phosphor bronze or steel wire point resting lightly upon it, is the most sensitive detector. However, it has to be readjusted frequently, because strong signals or slight vibrations, easily put it out of adjustment. Figure 4 shows a galena detector that is easily adjusted and clamped in position.

A crystal detector consisting of silicon with a brass contact point combines a fair share of both stability and sensitiveness.

Use of a Test Buzzer

If the crystal detector receiving set is being used beyond the usual range, it may be necessary to use a test buzzer, such as is shown in Figure 5, to make sure that the detector is adjusted to the utmost

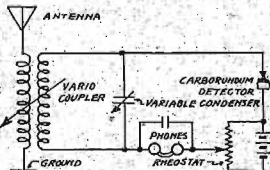

FIG. 3: CIRCUIT FOR CARBORUNDUM DETECTOR WITH BATTERY.

Fig. 3

sensitiveness. The buzzer test serves as a positive indication of the sensitivity of the crystal detector. The buzzer is connected in series with a dry cell and a single-pole switch, or push-button, a wire from one side of the buzzer interrupter being lead to the ground lead of the receiving set, as shown in Figure 6. When the switch is closed the electro-magnetic waves given off by the buzzer interrupter are impressed on the receiving circuit. The detector can then be adjusted for sensitivity as though tuning for a Radio-frequency transmitter. Adjust the detector until the sound of the buzzer is audible in the head-phones—the spot that brings

the buzzer signals in loudest is the most sensitive. The buzzer circuit can then be opened, and by proper tuning anything in the range of the receiving set can be heard.

Figures 7 and 8 show other methods of using a buzzer for this purpose, by depending upon induced currents. The advantages are slight but users of this system claim that sensitive spots so found on crystals are not apt to be lost or burnt and that more sensitive spots are generally found. In Figure 7, several turns

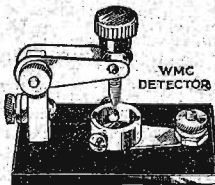

Fig. 4

of wire are wound around the aerial "lead-in" wire, before connecting to the buzzer. In Figure 8, a coil of wire, in the buzzer circuit, is placed near the loose coupler or tuner, so as to react upon it.

Figure 9 shows a single-circuit receiving connection, in which the detector element is connected directly to the terminals of the tuning coil. Oftentimes better and more satisfactory results may be obtained by connecting the detector across part (one-third to one-half) of the coil, instead of across all of it.

An indirect method of connecting the detector to the antenna circuit is shown in Figure 10, where the antenna tuning

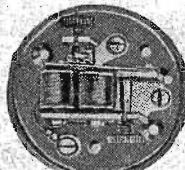

Fig. 5

coil is the primary of a loose coupler or variometer. The crystal detector is connected across the secondary of the coupler. The currents induced in the secondary coil by the high-frequency currents flowing in the primary or antenna circuit are rectified by the detector, as previously explained. In the two-circuit receiver, two circuits must be tuned to the incoming waves and the degree of coupling between the primary and secondary

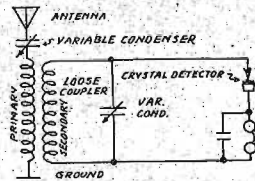

FIG. 10: TWO CIRCUIT RECEIVER.

coils of the coupler must be carefully adjusted for best results. The secondary is usually movable with reference to the primary, so that the induced effect of the primary on it can be regulated gradually. The two-circuit is more selective than the single-circuit receiver, and, hence, it eliminates interference from signals which are not desired to be heard.

The distance at which a crystal detector set can receive is dependent, in a small measure, upon the power of the transmitting station. The present commercial Radiophone broadcasting stations can be heard with a crystal detector at a distance not over thirty to forty miles. For long

distance reception a detector having more sensitive and stable characteristics than the crystal type is quite desirable and very essential. These characteristics are embodied in detectors of the vacuum tube type.

The vacuum tube detector has the advantage over the crystal detector in the matter of increased range, louder signals and more stable adjustment. With a vacuum tube as a detector, signals may be received at distances up to eighty or ninety miles.

NOTE—The second installment for Part VI of this series will appear in the next issue and will deal with vacuum tube detectors, giving the theory, construction and operation of the same.

Connection for a Loud Speaker

Those of you who have a two circuit jack for your last stage of amplification can save time and also one plug by connecting a pair of binding posts to your idle



terminals and connecting your loud talker to the binding posts permanently. Removing the phone plug thus automatically connects your loud speaker.

Do Not Use Any Paint on Sets

In finishing your Radio apparatus do not use any kind of paint on them. This is because most paints contain metal oxides and are poor insulators. Use nothing but a good grade of water or oil stain and either shellac or a good insulating varnish. Do not apply the shellac or insulating varnish too thickly over coil windings because this lessens their efficiency. A very thin coat will do just as well.

To Make "B" Battery Cell

It is easy to make a B-battery if you can procure a suitable glass bottle that has an almost square body. The bottle must be cut to the proper height. There are several ways to do this. One is to wind one turn of resistance wire around the bottle at the desired height and short the wire across a storage battery. When the wire becomes hot tap the top of the bottle smartly and the glass will break off smooth.

Procure some old unsulphated plates, 2 by 3 inches, at a battery supply station, and cut them to the right size to fit in the bottle. Use two positive and two negative plates in each jar made from the bottles. Be sure to have proper insulation between the plates.

When placing the plates in the jar remember to put first positive and then the negative, then positive and negative again. Make sure that both negative plate leads will come on the same side of the jar and the positive leads on the other side of the jar. Two volts per cell will be obtained. Ten cells will be enough for an audion detector.

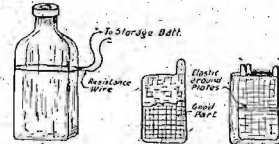

Make inquiry of your battery service dealer in regard to how much acid and water to use and how long to charge each cell. Do not put the acid in the cells until ready to charge and use.—Marius Salsbury.

Panels Made of Battery Boxes

Material for a panel is not always at hand and in some localities is hard to procure. I am using hard rubber plates made from material cut out of storage battery jars procured from a battery service station. Fill the battery jar with hot water and cut the one side with the bottom attached in one piece. This gives you a panel about 8 by 12 inches in size with a base to mount it on. A number of these plates can be used as units with a tuner, detector and amplifiers, and they will make a very attractive set. By placing these panels in hot water they work up very easy and a person can cut or drill them without fear of breaking the piece.—R. C. Barrie.

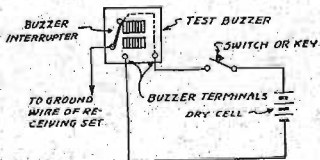

FIG. 6. CONNECTIONS FOR BUZZER FOR TESTING CRYSTAL DETECTOR.

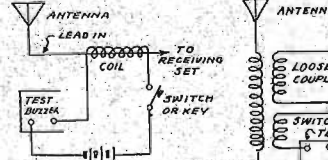

FIG. 7: MODIFIED CONNECTIONS FOR TEST BUZZER.

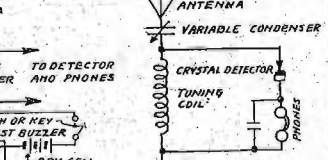

FIG. 8: MODIFIED CONNECTIONS FOR BUZZER FOR TESTING CRYSTAL DETECTOR.

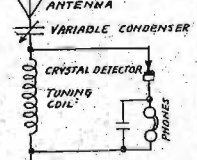

FIG. 9: SINGLE CIRCUIT RECEIVER.

Simple Instructions for the Beginner

By Harry J. Marx

Radio Formulae

before he can thoroughly understand the theory and operation of Radio telephony. It is to his advantage to study the operation of his set and to understand just how each piece of apparatus can be used to the best advantage. To do this the proper instrument must be used in each place in the circuit. This means that the capacity, inductance, resistance or any other characteristics must be found and located in the proper place in the circuit. The following general formulas are given and where necessary an explanation is added. No explanation of the derivation is given.

Ohms law is given, but the amateur must remember it does not apply to alternating current.

Amperes = Volts / Ohms (1)

Watts = Volts X Amperes (2)

Frequency = wavelength (3)

Wavelength = 1885 sqrt(C x L) (4)

where C = capacity in microfarads L = inductance in microhenries

Resistance in series R = R1 + R2 + R3 (5)

Resistance in parallel 1 / R = 1 / R1 + 1 / R2 + 1 / R3 (6)

Capacity of a condenser in micro-microfarads C = .0855 KS / t (7)

where t = thickness of dielectric S = Surface area in square centimeters K = dielectric constant

Table for "K" Values of dielectric constant

Table with 2 columns: Substances, Values of dielectric constant. Lists materials like Air, Glass, Mica, Hard rubber, Paraffin, Paper, etc.

Series & Parallel Capacity of condensers in parallel C = C1 + C2 + C3 (8)

Capacity of condensers in series C = 1 / (1/C1 + 1/C2 + 1/C3) (9)

Volts in a transformer Ep / Es = Tp / Ts (10)

where Ep = voltage in primary Es = voltage in secondary Tp = turns in primary Ts = turns in secondary.

Antenna Formulae Watt energy radiated in transmitting WE = 1578 H P^2 (11)

where H = Height of aerial in meters I = Current at base of aerial in amperes

Wa = Wavelength of aerial in meters Capacitance of antenna in microfarads C = Wa^2 / Wa'^2 x C' (12)

where Wa = natural wavelength of aerial in meters Wa' = wavelength with condenser in series C' = capacity of condenser in series with aerial

Inductance of an aerial in centimeters L = Wa'^2 / Wa^2 x L' (13)

where Wa = natural wavelength of aerial in meters Wa' = wavelength with inductance in series L' = inductance of coil in series with aerial

Wavelengths Corresponding to Various Frequencies

Table with 2 columns: Wavelengths in meters, Frequency cycles per second. Lists values for 200, 300, 400, 500, etc.

Coil Formulae The amateur occasionally finds that the natural wavelength of his aerial is too high for broadcasting. To reduce the natural wavelength of the antenna a condenser is connected in series in the antenna circuit.

The following formula gives the approximate capacity in microfarads required to reduce the wavelength of the aerial to the desired meters: C = W^2 x Ca / 3552 LaCa - W^2 (14)

where W = desired wavelength in meters La = inductance of the aerial in centimeters Ca = Capacity of the aerial in microfarads

The inductance of the primary coil in an antenna circuit for a desired wavelength is calculated from the following formula: L = W^2 / 3552 Ca (15)

where W = desired wavelength in meters Ca = capacity of the aerial in microfarads La = inductance of the aerial in centimeters

If the circuit is to be used for longer wavelengths than that of the antenna with the primary coil, loading coils are inserted in series. The following formula gives the required inductance in centimeters of the loading coils.

L = W^2 / 3552 Ca (La / 3 + Lp) (16)

where W = desired wavelength in meters Ca = capacity of the antenna in microfarads La = inductance of the antenna in centimeters Lp = inductance of the primary coil in centimeters

The inductance in centimeters of the secondary coil is calculated as follows: L = W^2 / 3552 C (17)

where W = desired wavelength in meters C = capacity of the condenser shunted across secondary coil

The inductance in centimeters of any single layer coil where the details of the winding are given can be figured from the formula: L = 39.47 Kr^2 n^2 / J (18)

L = radius of coil in centimeters n = number of turns J = equivalent length of winding in centimeters K = variable factor depending on the

TABLE V. WAVE LENGTH VALUES

Large table with columns: Inductance in microhenries, Capacity in microfarads (0.0025 to 0.0100). Contains numerical data for wave length values.

The table shown above is given as an aid to the amateurs who are interested in the calculations that were described in the two-part article on Tuning Apparatus Design. It gives the wave length in the meters, when the capacity and inductance are known, in the same sense, the table can really be used to get any one of the three values when the other two are known. This will help in eliminating a number of the tiresome calculations necessary in solving the wave length formula.

Dodging Body Capacity Effects

Many sensitive regenerative receivers are troubled by body capacity effects. To eliminate these, the panels may be lined with grounded tinfoil, but this is bothersome to do with so much wiring in the way. A so-called "magic wand" has been conceived but lacks friction for fine adjustments and I have found that a twelve-inch length of rubber tubing or hose will remove the effects and has friction enough for very fine adjustments, which are necessary for sharp tuning. By pressing an end against the dial and turning it as desired, it will perform very well.—Lewis A. Spalding.

Correct Regenerative Tuning

By William R. Tanner

A regenerative receiving set is not hard to tune, once the operator gets used to the complicated controls. Probably not more than 2 or 3 percent of the Radio fans realize the importance of tuning the primary circuit to the exact frequency of the secondary. When this is done, a surprising amount of amplification is obtained, and signals are much sharper, in fact, stations not wanted, can usually be tuned out. The procedure is as follows: Set the coupling at about 35 or 40 degrees. Start the tube oscillating by increasing the inductance of the plate variometer or tickler, whichever is used. Start tuning the secondary condenser (as grid variometer) from zero to maximum, at the same time tuning the primary condenser and inductance until the click is heard in the phones. If no click is heard, use more taps on the primary. With close couplings two clicks will be heard a few degrees apart. The looser the coupling, the closer will be the clicks. On either side of the clicks, continuous wave signals can be received. For phone signals, the operator should decrease the plate variometer until voice or music is clear. Spark signals may be received at the point between the two clicks. The primary condenser should preferably be shunted across the primary coil as this gives louder signals and the series connection. This method is applicable to both short and long receivers. The back of the panels should always be coated with tinfoil or other metal to eliminate body capacity effects. The foil should, of course, be grounded. If a secondary condenser is used, capacity effects of the hand may sometimes be eliminated by grounding the stationary plate. The connection from the rotary plate should go to the grid side of the coil.

Carter Radio Co. TU-WAY Plugs; HOLD-TITE Jacks V. T. Sockets; Variable Condensers; Rheostats and Head-sets. If your jobber is unable to supply, write us.

"ALL AMERICAN" Amplifying Transformers STAND THE TESTS Audio Frequency Ratios 10-1 & 3-1 Radio Frequency AT LEADING DEALERS RAULAND MANUFACTURING CO. 35 South Dearborn Street CHICAGO

Headquarters for Radio Supplies and Equipment Radio Department COMMONWEALTH EDISON ELECTRIC SHOPS 72 West Adams Street Chicago, Ill.

Radio Digest Illustrated

No 11

By: Harry J. Marx

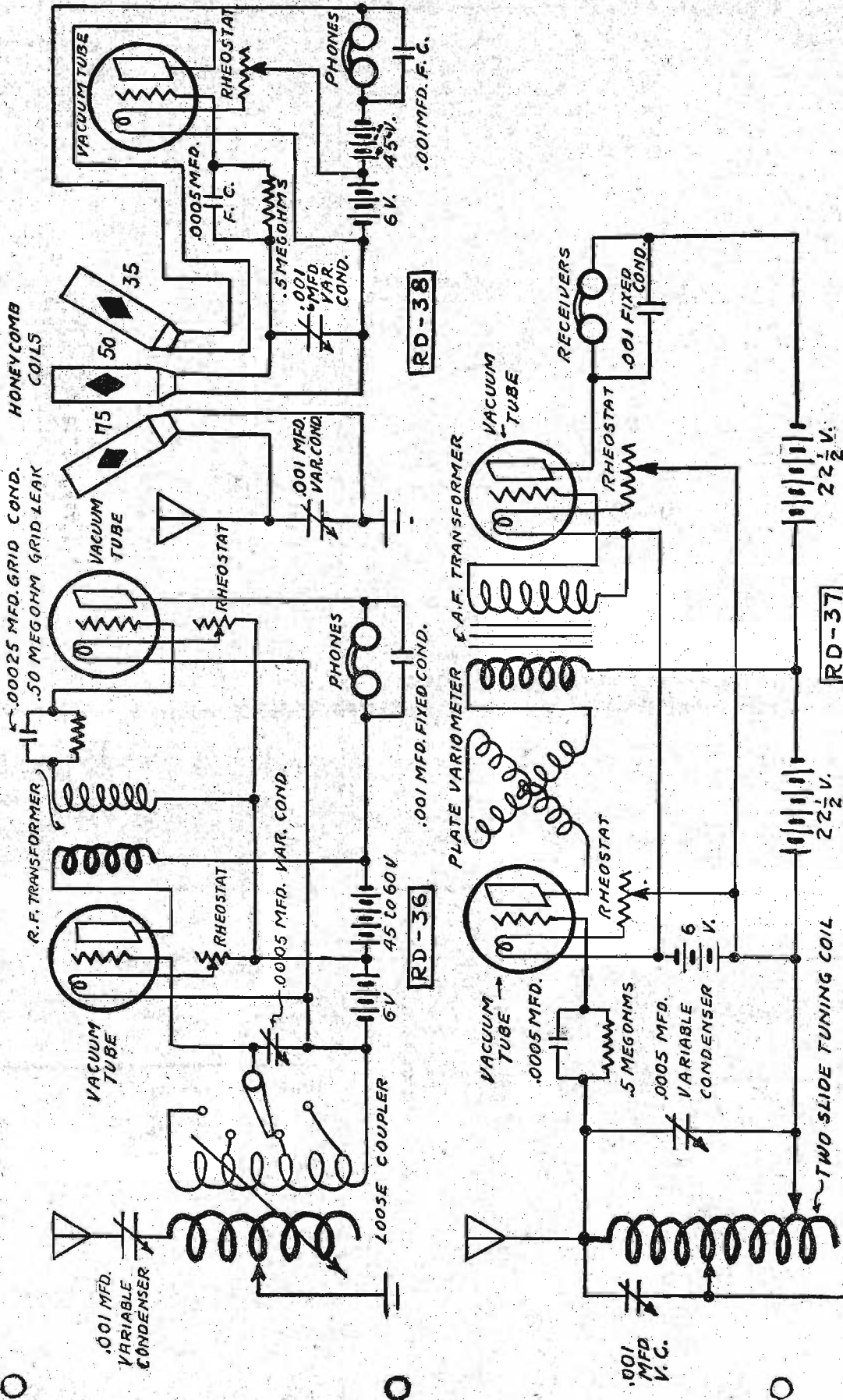

Hook Ups

Questions and Answers

Audio Frequency

(631) EW
I am a reader of RADIO DIGEST. Enclosed find a drawing of Hook-up for 1 Variocoupler and 1 Variometer. How can I connect 2 stages of Amplification to this circuit. This Hook-up will be found in Vol. 1, No. 3, April 23.

A—Hook-up Q & A 631 is given on this page.

Potentiometer as Rheostat

(232) EHB
I am submitting herewith attached a diagram of a hook-up system which I would appreciate if you would look over and give me a little advice as to its receiving qualities. The following questions have me plexed to quite a degree.

1. Is an amplifier necessary with this hook-up system.
 2. How far will this receiving set receive telephone messages and also code messages.
 3. Is it a good policy to use an auxiliary coil and also a variable condenser in series with the antenna.
 4. Will a potentiometer of 200 ohms 0.2 Amps. work as a Rheostat and to what degree if any.
 5. Is the vacuum tube detector and amplifier contained in one tube or can you get them separate.
- A.—1. How far do you want to receive? Better put a .001 mfd. condenser across your phones.
2. How high is your aerial? Are there any obstructions, buildings, trees, etc.? On an average, 100 miles.
 3. No.
 4. No. This resistance is too high.
 5. The detector is one style of tube, the amplifier another.

Diagram Hook-up

(340) MCW
In your magazine Vol 1, No. 3, April 29th, 1922, on page five you illustrate a receiving set. I am just a new Radio fan and know very little about same, but I like the looks of the set shown and would like to know how great a range a set similar to the set shown can receive. I would like also to know if I could get further information as to type of parts shown and a more thorough diagram of the wiring and connections.

The nearest sending station is 300 to 500 miles. As I cannot buy such a set fit already set up, I would like to buy it part at a time and assemble it myself. Thanking you for information you can give me, I am

A.—The distance of reception with a set of this type depends upon the surrounding conditions, location of aerial etc. We cannot take a manufacturer's set and divulge the complete details of construction. If you want to assemble a set yourself I would suggest that you use the hook-up shown on page 13 of the 6th number of RADIO DIGEST, May 20th, 1922. This will give you the receiving range in miles that you need.

Honeycomb Cells vs. Varico Coupler and Variometers

(354) SA
Please send me an answer to the enclosed three questions by mail if possible.

1. With the enclosed hook-up, could I receive clearly from the stations in Cincinnati, about 100 miles, Louisville, 98 miles, Dayton and Toledo?
2. Can the toy transformers for electric trains be used as "L" battery in audion tube receiving set, giving 8 volts?
3. Are honeycomb coil sets, as shown in enclosed diagram better than a set containing a varico coupler and two variometers?
4. S. Please answer by enclosed self-addressed envelope as I buy RADIO DIGEST at the news stand occasionally.

1. What should be the diameter of the primary winding so as to obtain maximum results?

2. Is the range dependent upon the miss an issue. I think your magazine is the best published, at any price.
- A.—1. No. See R. D., 11 issue, No. 4, RADIO DIGEST, May 6th, 1922.
2. Yes.
3. Matter of choice.

"Wave-length"

(275) MGM
I am enclosing the wiring diagram of a regenerative receiver, with a one step amplifier, that I am thinking of constructing.

Using standard parts, and having a one wire aerial forty-five feet high on one end and about fifteen on the other, and about ninety to one hundred feet long, what would be the range of such a set? Would I be able to hear the Radiophone broadcasts from Minneapolis, Minn., which is about two hundred and fifty miles from here?

A.—The natural wave-length of your aerial is about 175 meters.

You ought to pick them up O. K.

Loose Coupler and Varico Coupler

(330) JGK
Having read your articles on the loose coupler and varico coupler, I decided to ask a few questions.

1. Please send me data for construction of a good loose coupler and a good

varico coupler, in enclosed envelope.

2. May the ground of a lightning switch be connected with a drain pipe in the cellar of an apartment block or has it got to be driven in the ground outside?
3. Send list of parts necessary to build a fairly good bulb set.
4. Would 200 feet of seven strand copper covered antenna wire, about 50 feet high at one end and 50 feet at the end where the lead-in is, a 25 foot lead-in, and a wire about 20 feet long, going to a water pipe on the fourth floor, for a

Loose Speaker

(277) CPH
We have the following Radio equipment hooked up as per the attached diagram: variocoupler, two variometers, detector and two stages of amplification. We have an L type antenna about 85 feet high and 62 feet long.

We have at times gotten G. E. Co. WGY at Schenectady, W. J. Detroit News, Fitzsimmons Hospital at Denver, University of Wisconsin at Madison, Wis., Roswell, N. M., but only at times and have trou-

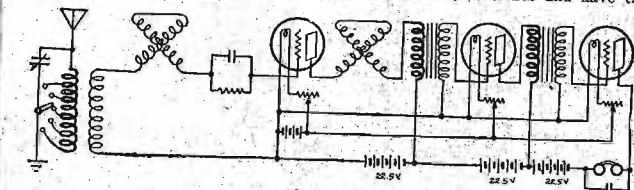

Q & A—531

ground, would this make a good antenna?

5. With the antenna mentioned, a loose coupler of your design (or a varico coupler), a crystal detector, a .005 Microfarad phone condenser and a pair of 2,000 ohm Manhattan Radio telephone head set. What would be my approximate range? What could I add to better this set?

- A.—1. See issue No. 4 and 8 of the RADIO DIGEST.
2. The lightning ground must be outside.
 3. Look up our hook-up sheets especially in No. 8.
 4. Your aerial should not exceed 150 feet including lead-in and ground wire. Preferably not more than two strands for receiving.
 5. About 30 miles. Use a vacuum tube.

"Radio Frequency"

(332) LH
Would you kindly answer the following questions:

1. Is it possible to connect a Radio frequency amplifier in the enclosed circuit (Grebe C. R. 8)? If so will you mark the changes in the diagram and return to me?

2. What kind of Radio frequency amplifying transformers and tubes would you advise me to get?
3. Will an aerial erect over a tin roof be effected by it? The aerial will be about thirty feet above the roof.
4. The national guard is thinking of putting in a station which will be quite near me (about 200 feet). Will they interfere while they are sending? Should my aerial be at right angles or parallel to theirs?

- A.—1. No, not without taking it apart.
2. Any of the popular makes.
 3. No.
 4. To a limited extent depending on power, output, etc., parallel.

Indoor Aerial

(276) RCD
It is impossible for me to have an outdoor aerial. My aerial would be in a room about ten (10) by twelve (12) feet.

would you advise me to lay one wire around the molding and then string three or four wires across the ceiling? The house is elevated about fifteen feet from the front sidewalk, and the elevation is about one hundred twenty-five (125) feet long. What instruments would I need to receive broadcasting from Chicago and about how much would they cost? Could I make any of the parts myself?

A.—Wind your aerial around the room four times spaced about 1 inch apart. You will have to use a short wave regenerative receiver consisting of two variometers, one variocoupler, a vacuum tube detector and two stages of amplification. You can make the variocoupler and variometers yourself.

Electric Bell Wire

(659) DJ
Would you please answer these questions in your RADIO DIGEST in the next issue:

1. Could I use wire off of a coil from an electric bell for the aerial?
 2. Salina is twenty-five miles from where I live. Could I hear the concerts with a crystal set?
- A.—1. I would not suggest using that wire as the gauge is rather small.
2. Yes, but not very clearly.

Loading Coil

(266) CT
Please answer these questions and oblige:

1. Please give data for making a 1,500 meter loading inductance and name the parts necessary to go with it for a crystal set.
 2. Would a loose coupler wound with number 26 wire for both primary and secondary, be all right?
- A.—See issues Nos. 9 and 10 of RADIO DIGEST. Also see loose leaf sheets for hook-ups.
2. Yes.

have several call books but none of them list the stations which sign off as I am listing and I will appreciate it very much if you will write the name of the station and where located after each of them, of course you understand it is telegraphy I am getting and not Radiophone.

Just write the station and location after these calls or as many as possible and return same to me.

- A.—5 AN—H. W. Phillips, McAlester, Okla.
5 BF—C. R. Taylor, Waurika, Okla.
WXY—Washington, D. C. (Govt.)
WBY—?
Z-VD—H. L. Demuth, N. Y. C.
WYB—?
3 BC—C. A. Roberts, Phila., Pa.
WVP—Fort Drum, Philippine Islands.

Panel With Fittings.

Many an amateur can easily make a panel with fittings from some parts of his "meccano" or similar set and a cigar box. A tuning coil for this purpose can be made by winding wire (about No. 22 insulated) around a pasteboard box in which salt or rolled oats are sold, taking as many taps out as desired from the coil. The taps are connected as shown in the illustration, using the nuts and bolts for the switch points. The illustration is self explanatory. The panel may be stained dark or enameled black to improve the appearance.

A home-made variocoupler may be mounted in the same way as the tuning coil, except that it has two knobs with switch points instead of one.—Joseph M. Manenium.

Reducing Static.

One way to reduce static is to make a loop lead to the aerial. Construct the aerial in the usual manner then make connections to each wire in the aerial and run them down as shown in the illustration. Keep the wires separate with rings of insulating material to hold them in a circular form. I have found this to reduce much of the static to be encountered during the warm weather.—Clifford Kenyon.

MANAGUA, NICARAGUA—The establishment of a commercial Radio station at Managua, and also stations at Bluefields, San Juan del Norte, and Cabo Gracias de Dios in Nicaragua, have been authorized by concessions granted to John B. Wilson, Managua.

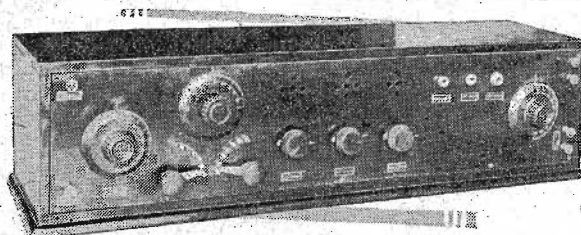

A High Class Long Range Receiving Set

With two stages of amplification
S. & H. MODEL No. 301
Immediate Delivery

RADIO-PHONE SALES CORPORATION

37 W. Van Buren Street Room 770 Old Colony Bldg.
CHICAGO, ILLINOIS

Dealers: Write for Special Proposition

Radio Illustrated



The "most ingenious Radio fan" is Sterling G. Sears, who made the smallest vacuum tube set and won the first prize at the recent New York Radio show. The set was judged best for police work. The set's normal range is seventy-five miles.
© K. & H.

There are other things to do at Brighton Beach on Long Island, New York, besides bathing and luncheon. Then, too, who wants to stay in the water all the time when there is something interesting in Radioing? Miss Peggy Roy and Miss Florence Cronin enjoying the shade under a beach umbrella and listening in on grand opera.
© Int.

Another small receiving set which is placed into a safety razor box. It consists of a variable condenser, a tuning coil and a crystal detector. Signals can be heard for a distance of ten miles.
© K. & H.

The largest Radio horn ever made was placed in Idora Park, California. This horn will megaphone music over an area of twenty-eight square miles.
© Wide World

