

# Radio Digest

EVERY WEEK

Illustrated

TEN CENTS

TRADE-MARK

Vol. IV

Copyright, 1923  
R. D. P. Co. Inc.

CHICAGO, ILL., SATURDAY, JANUARY 13, 1923

No. 1

## ACT ON NEW RADIO LAW

### MANUFACTURERS TO FIGHT R. C. A. TO END

INDEPENDENTS ALL TO GET UNDER ONE FLAG

Victors Over Radio Corporation Subsidiary Consider Joining in New Battle—Licensees Hold Meeting

(Special to RADIO DIGEST)

NEW YORK.—Organization of the independent Radio manufacturers for a fight to the finish against the Radio Corporation of America, has proceeded to the stage that many such manufacturers not holding Armstrong licenses are expected to join forces with the group for self defense. The latest group to consider joining in the fight on the side of A. H. Grebe and the Bunnell companies, is the Independent Radio Manufacturers, an organization which recently won a decisive victory over the Wireless Specialty Apparatus Company of Boston, Massachusetts, a subsidiary of the Radio Corporation of America.

It will be remembered by those who followed the last mentioned suit, that the Wireless Specialty Apparatus Company was enjoined by the courts not to practice further advertising of a nature harmful to the characters of the manufacturers of crystal detector receiving sets who were not infringing certain patents said to be owned by the Wireless Specialty Apparatus Company.

Fighting Body Meets

On Thursday, December 28, the Associated Radio Manufacturers, composed of Armstrong patent licensees, had a meeting for the purpose.

(Continued on page 2)

### COMMITTEE HEARS OPINIONS ON BILL

No Serious Objections Raised—Measure Starts Regular Course

(Special to RADIO DIGEST)

WASHINGTON.—Actual hearings on the important White Radio bill were commenced January 2 before the merchant marine committee of the House of Representatives. The main opposition to the bill came from the army and navy officials who oppose having their operators and stations licensed by another (the commerce) department. However, on all other points the war and navy departments favored the bill. Secretary of Commerce Hoover said that his department favored the bill, and had immediate need for its enactment. R. P. Maximum, representing the American Radio Relay League, said that he spoke for the 16,000 licensed Radio amateurs who are members of the league and that he supported the bill in general. Secretary Hoover, Admiral Zigmeler, chief of naval communications; Major L. B. Vender, army signal corps; Eugene Sibley, postoffice department; W. A. Wheeler, department of agriculture; Alfred H.

(Continued on page 2)

Little Fred C. Shearer, Jr., the world's tiniest Radio announcer, is a regular star on programs broadcast by WSB, The Atlanta Journal's Radiophone broadcasting station. He is seen holding his homemade banjo, on which he sometimes accompanies himself. The murderous musical weapon to the left belongs to Ernest Rogers, the WSB star shown below. Master Shearer tickled the nation's funny bone when he recently gave an imitation of Mr. Roger's famous "Willie the Weeper"

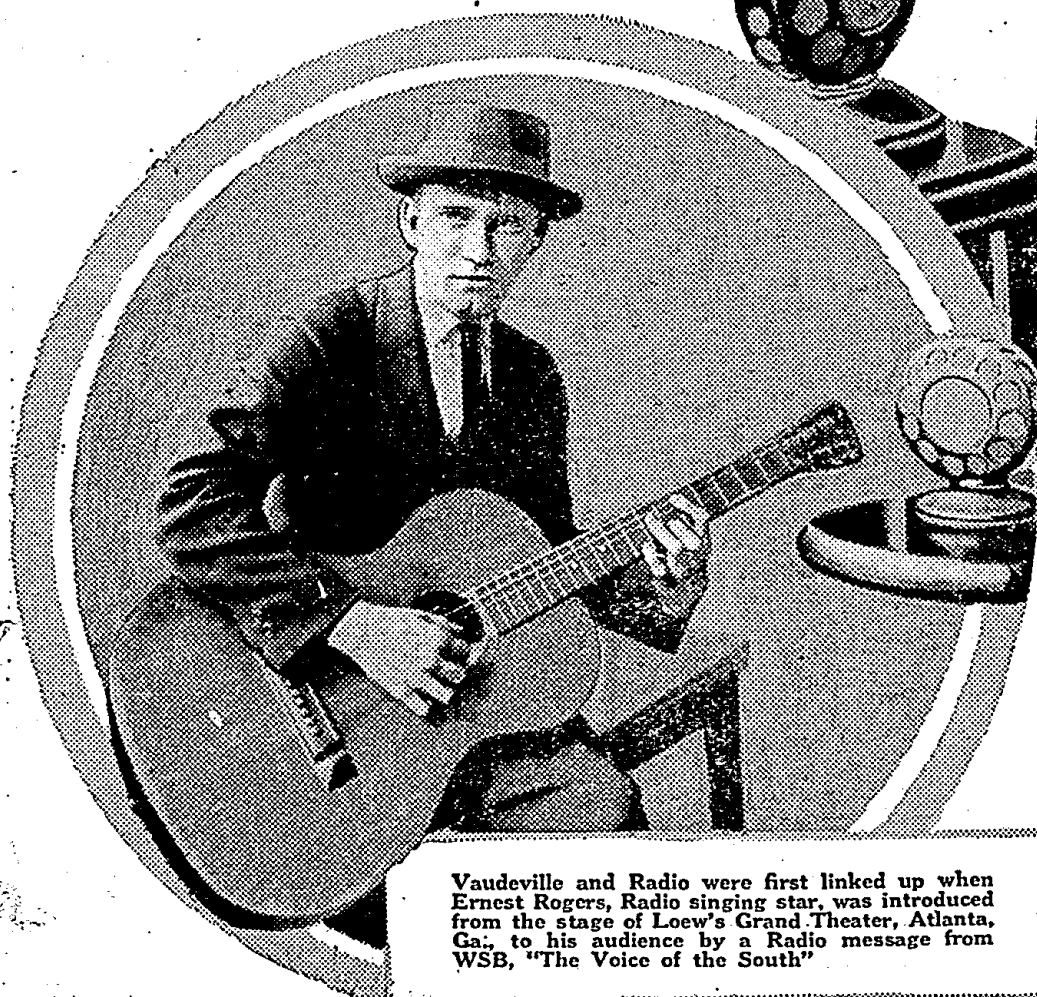

Vaudeville and Radio were first linked up when Ernest Rogers, Radio singing star, was introduced from the stage of Loew's Grand Theater, Atlanta, Ga., to his audience by a Radio message from WSB, "The Voice of the South"



### TWO NEW OPERAS GO ON ETHER FROM KYW

"Barber of Seville" and "Samson and Delilah" Heard

CHICAGO.—"The Barber of Seville" January 3 and "Samson and Delilah" on January 5 were the Chicago Opera productions broadcast by Westinghouse Station KYW during the opening week of the new year. Both operas were given for the first time during the season and afforded an unexpected treat for Radiophans.

The cast for "The Barber of Seville" (Continued on page 2)

### COPS USE KOP PLANT TO "COP" CRIMINALS

DETROIT.—KOP is the Detroit police department Radio station. KOP is a very good call number—particularly for a police department. The station is used strictly for business purposes, no programs being broadcast. It is brought into use for hunting criminals, locating stolen automobiles and other official police business. It has proven its worth in several recent criminal hunts.

### ACT ON NEW RADIO LAW

(Continued from page 1)

Thom, American Railway Association; Mr. Maximum and others all appeared in favor of the bill. Several of them, however, offered minor amendments. It is believed that the bill will have speedy and favorably action by the House of Representatives when reported by the merchant marine committee.

#### Will Be New Year's Gift

Literally, the final passage of the White bill, seeking to re-allocate Radio waves, minimize interference and provide for the adequate regulation of national Radio transmission, will be a New Year's gift to practically every amateur in the country and to every Radiophan. To be sure, its benefits will not be realized at once, but they will last for years to come.

The bills presented in both the Senate and House last June, lay dormant at the Capitol until Secretary Hoover returned from a protracted trip to the West Coast, where he was busy with another national project. Immediately upon his return, he took up the question of the desired Radio legislation with Representative W. H. White, Jr., of Maine, the House champion of Radio, with the result that it was announced that hearings would be started before the House Merchant Marine and Fisheries Committee on Tuesday, January 2.

### TO FIGHT R.C.A. TO END

(Continued from page 1)

pose of discussing further organization. Ten licensees were present and all subscribed to support A. H. Grebe in the Radio Corporation of America monopoly suit. The spirit of the meeting was indicative of a high morale, and while it could not be definitely ascertained, it is said that two important legal points, sufficient to block the patent monopoly efforts of the Radio Corporation, were disclosed.

The officials of the organization are: A. H. Grebe of the A. H. Grebe Company, president; Edward Weston of the Radiocraft Company, vice president; Fulton Cutting of Cutting & Washington, treasurer; Francis P. Pace, lawyer, secretary.

#### De Forest Corrects Rumor

Dr. Lee De Forest and Charles Gilbert, president of the De Forest Radio Telephone and Telegraph Company, are righteously angered at recent misstatements regarding the De Forest patents. In order to have the public understand the truth an interview with the two obtained the following statement:

"Rumors have been circulated throughout the trade and statements have been published that the Radio Corporation of America, or the American Telephone and Telegraph Company, or both, are the owners of the De Forest patents. In the interest of fairness and to prevent those unfamiliar with patent matters from being imposed upon or being misled by misrepresented facts, we wish to advise that the De Forest company is, and at all times has been, the owner of the De Forest patents, and any statements to the contrary by anyone are untrue.

"The Radio Corporation of American and its associated companies are operating under a license acquired from the DeForest company through the A. T. & T. Company and the Western Electric Company who are licensees under the De Forest patents. This license which the De Forest company granted is open to public inspection, and is recorded in the U. S. Patent Office.

"Nevertheless, pursuant to its attitude and policy of fairness, it cannot permit a misrepresentation of facts to accomplish what can be accomplished by fair legal methods. The apparatus manufactured and sold by the De Forest company is free from infringement of any existing valid patent of the United States owned by anyone other than the De Forest company, and frees the purchaser of such apparatus from any litigation."

### NEW OPERAS ON AIR

(Continued from page 1)

included the familiar array of former seasons; Mmes. Galli-Curci, Claessens, Mecsrs. Schipa, Rimini, Lazzari and Trevisan. Cimini conducted.

"Samson and Delilah" was interesting from the standpoint of debuts, as Louise Homer as Delilah and Charles Marshall as Samson were heard for the first time in these roles with the Chicago Opera. Polacco conducted.

### Radio Comes to Rescue of Lonely, Historic Island

SYDNEY, AUSTRALIA.—Radio has come to the rescue of lonely Polynesian Pitcairn Island, which loomed large in fiction and history as the refuge of the mutineers of the British sloop Bounty, years ago.

Until now the 200 islanders have been compelled to depend for their news of the outside world upon the occasional visits of ships. Radio equipment has just been installed, however, and will do much to relieve the isolation of the island residents. Some of the young men of the island have been learning the International Morse code.

### FLEWELLING PRIZE CONTEST RULES

1. Contest is open to all Radiophans, whether or not they are subscribers to Radio Digest, Illustrated. The contest is open now and will close January 27 at midnight. Awards will be announced in the February 24 issue of this publication.
2. The object is to locate and award prizes on a competitive basis for the best Flewelling circuit receiving set entered.
3. Prizes are: First, \$25.00; Second, \$15.00; Third, \$10.00; Fourth to Eighth (five prizes) inclusive, \$5.00 each.
4. In event of a tie, equal prizes will be awarded both contestants.
5. Judges will be the Technical Staff of Radio Digest, Illustrated.
6. To enter the contest send working drawings and diagrams together with an article of from 1,500 to 2,500 words in length describing the making and operation of an actual Flewelling circuit receiving set. The contestant must build this set and test it before entering the contest. The article must tell: (a) how to make the set, (b) how to operate it, (c) helpful suggestions for getting maximum results, (d) actual airline broadcasting station receiving range using only one tube, first employing only an indoor aerial but no ground, second, using a ground but no aerial, and third, if available, using only a loop aerial. Other combinations and notations on the antenna system used will be considered in the award of prizes.
7. In sending material for consideration in the contest, exclusive publication rights are automatically given to Radio Digest, Illustrated. All articles published, but not awarded prizes, will be paid for at regular space rates. Unused manuscripts will be returned to contestants.
8. In deciding the winners of the contest the judges reserve the right to call for any set entered to be sent in for examination and test. Tubes, A and B batteries and phones will not be required in sets sent in for testing.
9. Manuscripts will be judged from the standpoints of neatness, clarity of expression, completeness, and actual tried success of the set described.
10. Originality in the use of various parts of apparatus other than shown by Radio Digest in the Flewelling circuit heretofore, is encouraged and even recommended. See Rule 6, however, for method to be used in determining the range.

#### Seven New 360-Meter Plants

CHICAGO.—Seven new plants managed to get the date 1922 on their 360-meter broadcasting licenses by obtaining their licenses during the last week of December. Station WCAE, Pittsburgh, Pa., was also granted a Class B license, carrying with it the use of a 400-meter wave length. The new plants on 360 meters are: WRAM, R. E. Compton and Carthage College, Carthage, Ill.; WQAC, E. B. Gish,

Amarillo, Tex.; WPAW, Radio Installation Co., Wilmington, Del.; KFCM, Richmond Radio Shop, Richmond, Calif.; WPAX, S-W Radio Co., J. R. Shumate, Jr., Thomasville, Ga.; WPAV, Paul Tineti & Sons, Laurium, Mich.; KFAZ, C. H. Weatherell, Reedley, Calif.

The Government station at Estevan, Canada, recently established communication with Raratonga, New Zealand, 6,500 miles distant.

## CONTENTS

Radio Digest, Illustrated, Volume 4, Number 1, published Chicago, Illinois, January 13, 1923. Published weekly by Radio Digest Publishing Company, 123 West Madison Street, Chicago, Illinois. Subscription rates, yearly, Five Dollars; Foreign, Six Dollars; single copies, Ten Cents. Entered as second-class matter April 27, 1922, at the postoffice at Chicago, Illinois, under the Act of March 3, 1879.

"All the Live News of Radio".....	1 to 6
Flewelling Prize Contest Rules.....	2
How They Do It at WDAP's Plant.....	5
Receiving Records Contest.....	6
The Reinartz Set in Photo Diagram.....	7
Radiophone Broadcasting Station Directory, Part II, Station Schedules from WAAX to WJAR.....	8
Editorials; Condensed by Dialectic; Indigest; Humor Column.....	10
A-B-C Lessons for Radio Beginners, Chapter II, by Arthur G. Mohaupt.....	11
Panel Shield Prevents Body Capacity; Ten Variations in Grid Leak Increase Signals; Six Workshop Kinks.....	12
How to Make and Operate the Reinartz Receiver, an Explanation of the Photo Diagram Shown on Page Seven, by H. J. Marx.....	13
Radio Digest Standard Conventions; The Reader's View.....	14
Questions and Answers.....	15
Radio Illustrated, a Page of Pictures.....	16

### Looking Ahead

More About Reflex Circuits, is a feature by Harry J. Marx in the next issue, January 20, of Radio Digest. Mr. Marx has uncovered some interesting new data regarding these "trick" circuits, and will show and tell about three more hook-ups for the home experimenter to try out. Making one tube "work overtime" is always an interesting subject. Buy the next issue and learn more about this type of receiving circuit.

A-B-C Lessons for Radio Beginners, Chapter III, will appear in next issue. The "green" novice should not miss any of these simple explanatory articles by Arthur G. Mohaupt. His next chapter will take up the subject of oscillating circuits and the high frequency currents established in them. As these form the real basis of Radio operation, no novice should miss the next chapter.

Radio Receiving Sets in Photo Diagram, one of the popular original features of the Digest, will illustrate the new Federal Radio frequency receiving set. This will appear in the January 20 issue. Place your order with the newsstand dealer today.

The Effect of Religious Broadcasting, is the subject of an article by Vera Brady Shipman to appear in an early number of the Digest. Will Radio aid in the propagation of Christianity? Does the broadcasting of various denominations' services have a unifying effect? See what this interesting article discloses.

The State, City—Station Index, to the Radiophone Broadcasting Station Directory, together with the third and last part of the station schedules, will appear in the Digest. Imitation is the sincerest form of flattery. This service is original with Radio Digest, and is the best directory of such stations that anyone can secure.

Newsstands Don't Always Have One Left

WHEN YOU WANT

## Radio Digest

YOU WANT IT!

BE SURE OF YOUR WEEKLY COPY BY SUBSCRIBING NOW

SEND IN THE BLANK TODAY

Publisher: Radio Digest, Illustrated, 123 West Madison St., Chicago, Illinois. 4-1

Please find enclosed check M. O. for Five Dollars (Six, Foreign) for One Year's Subscription to Radio Digest, Illustrated.

Name .....

Address .....

City ..... State .....

## NEW YORK'S SHOW DRAWS BIG CROWD

### MANY ATTRACTED BY ENTERTAINMENT FEATURES

David W. Griffith, Wm. J. Burns, Chauncey Depew and E. H. Armstrong Keep Interest Alive

NEW YORK.—Closing with exhibitors leaving late Saturday night, December 30, the American Radio Exposition at Grand Central Palace here broke all previous records for previous Radio shows. The great crowds, growing every day of the ten days, were literally jammed about the booths and entertainment features on the last night.

One feature which held the interest of all was the standard 500-watt broadcasting station which was located on the main floor. Hundreds of well-known persons were accorded the honor of broadcasting from the show's station.

#### Show Program Excellent

The excellent character of the program arranged for the show undoubtedly caused many persons to attend who might not have done so otherwise. The entertainment was not confined to Radio, but included motion pictures, crime detection and other distinct fields in its scope.

On the day following Christmas, Richard Barthelmess was awarded a photograph medal for his acting in "Tol'able David." Later during the same evening, David Wark Griffith broadcast from the show's station on the subject, "The Type That Need Apply." His talk described the best type of person adaptable to a motion picture career.

#### William J. Burns Talks

On Wednesday night, December 27, William J. Burns told the crowd attending how Radio was being used in the detection and capture of criminals. On the same evening Julius Tanner, vaudeville star, and "Uncle Dave" Cory, famed writer of children's stories, contributed to the show's popularity.

On the next night Chauncey Depew attempted to break some broadcasting records. A great many years ago when the wired telegraph first reached around the world, Mr. Depew gave an exhibition of fast sending and his message circled the globe in twenty-eight seconds. Then Thomas A. Edison cut two seconds from Mr. Depew's time. When the new mark was recorded Mr. Depew contended he was the best amateur, as the great inventor was a professional.

#### "The Major" Shows 'Em How

One of the daily features of the exposition was a demonstration of Radio receiving by Major Edwin H. Armstrong, under the auspices of the Radio Club of America. Special apparatus using 29 vacuum tubes was constructed and used for this purpose and an extraordinary system of amplification was used so that the receiving programs could be heard distinctly and clearly by the crowd.

Armstrong worked at the show in a special glass enclosed room on the mezzanine floor.

### Radio Takes Role as Show Booster

Broadcasts Effective in Calling Wide Public Attention to Los Angeles Pageant of Progress

LOS ANGELES, CALIF.—Radio was recently presented to the world in the role of "A Messenger," by the Los Angeles Chamber of Commerce, when they decided to broadcast information concerning the Pageant of Progress and Industrial Exposition, which they were to present to Southern California and the world.

For several weeks before the opening and during the two weeks of the Exposition which was held a short time ago, Stations KHJ, the Los Angeles Times; KOG, the Evening Herald, and KWH, the Los Angeles Examiner, included Pageant of Progress news, information and programs in the broadcasting of their news bulletins.

This was the first time that Radio has been brought into play in connection with an exposition of any kind on the Pacific Coast, and in which the information was broadcast by the newspaper stations. The news matter, broadcast from an educational standpoint, proved from late reports to have been more than the success expected.

An experimental twenty kilowatt vacuum tube at Rocky Point, Long Island, transmitting on a wave length of 19,000 meters, recently handled commercial trans-Atlantic Radio traffic with Great Britain and Germany.

Instead of the usual picture or piece of statuary, the graduating class in a Western high school presented to its alma mater an expensive Radio receiving outfit.

## START 'HOOK NIGHTS' FOR ENTERTAINERS

BUT NO RADIO CABBAGES FOR THESE AMATEURS

Everyone Gets Chance to Broadcast "Act" from New York Plant for Weekly Prize

NEW YORK.—The Society Radio of Radio Artists and Audiences, established some months ago to effect a closer relationship between the audiences of Station WHN and the artists who entertain them, held the first of a series of amateur nights on Thursday evening, January 4th. This amateur night was comparable in every way with an amateur night which one might see in a vaudeville theater, and it marked the first opportunity that has been afforded to novice, amateur entertainers to broadcast from an eastern station.

Anyone and everyone is eligible to compete for the prizes which are offered at WHN each Thursday evening. There is no entrance fee. All that is required of a would-be prize winner is that he write to the station, telling the nature of his act and the length of time it will take to broadcast it. As the time for amateur broadcasting is limited to one hour and a half, no one person will be allowed more than five minutes, nor will it be possible to admit everyone who asks for a place on the program at any one night. However, letters will be answered in the order in which they are received and each person will be advised when he is to appear at Station WHN to try for a prize.

Listeners-in are the sole judges of the winners, and they cast their votes by telephoning to the station at the conclusion of the program or by writing their decisions in a letter so that they will reach the station before Thursday of the following week. The correct address of the station for those who wish to enter the contests or vote for winners is: Ridgewood Radiophone Station WHN, Ridgewood, Long Island, N. Y.

## NEW HONDURAS PLANT WORKS NEW ORLEANS

WNU Handles Traffic of Fruit Firm's Tropical Station

NEW ORLEANS, LA.—Another lap toward New Orleans' goal as a Radio center is the opening at Tegucigalpa, Honduras, of the first of a number of Radio stations under the auspices of the United Fruit Company. The formal opening took place December 1, and traffic was handled by WNU, the company's New Orleans station, for several hours.

The Honduras station is among the first to generate the high frequency current by means of a 20-kilowatt triode tube. According to Crawford H. Ellis of the United Fruit Company office at New Orleans, virtually no trouble with static, usually bothersome in the tropics, was experienced between WNU and the new station. Five new stations are being built in the tropics by the concern. At New Orleans the 50-kilowatt transmitter is to be replaced by tube of 20-kilowatts, and greater range is expected.

## Two New Tacoma Plants; City Sets Mark for Size

TACOMA, WASH.—Two more new broadcasting stations have brought the number in Tacoma up to five, considered a record for a city of 100,000. KFEJ, the Tacoma Radio News Service station, opened up in December with records, news bulletins and advertising material. The idea is a new one, the station broadcasting the names and lines of various firms who sign with them, advising auditors to call the office of the broadcasting station for prices.

The other new station is BE1, the Third Signal Company station at Camp Lewis, on the outskirts of Tacoma. The army station operates on 400 meters, sending music and lectures five nights a week.

## BRITISH LICENSES GO TO NEW HIGH MARK

WASHINGTON.—Between March and November the number of experimental Radio licenses in England, which are granted only to those competent to make useful contribution to Radio research, increased from 8,000 to 18,000. An even greater growth is expected with the recent opening of several broadcasting stations throughout the isle.

## MASSACHUSETTS HIGH IN CROSS OCEAN WORK

BOSTON, MASS.—Stations in Massachusetts form a large percentage of those heard across the Atlantic in the amateur transatlantic ten day test. Over 52 New England stations were heard. Among the most notable achievements was that of S. S. Heap of Atlantic, Mass., who got his call across with only a 5-watt transmitter.

## DAY-LONG SABBATH SERVICES AT KYW

MORNING UNTIL EVENING CHURCH BROADCASTS

"Old Central Church," Spiritual Haven of Strangers, and Sunday Evening Club Co-operate

CHICAGO.—Sunday, December 24, Station KYW introduced its latest broadcasting feature, church services continuing intermittently from 11 A. M. to 9 P. M. This was accomplished by arrangement with the board of directors of the Sunday Evening Club, which gave permission for the installation of a special telephone wire connecting Orchestra Hall with the station. This now makes possible the broadcasting of the Central Church and Sunday Evening Club's services in addition to the regular chapel services conducted by the leading pastors of Chicago churches in KYW's studio at 3:30 p. m., Central time.

### Central Church Known to Transients

If there is such a thing as a heart-throb or flash of sentiment in the life of a great city, that spark flashes in Chicago when mention is made of "Old Central Church" which has been the spiritual resting place for years for strangers within the walls of the city. The services of Central Church are conducted by Dr. Frederick F. Shannon. For seven years before coming to Chicago Dr. Shannon was pastor of the Reformed Church of the Heights in Brooklyn.

The feature of the Sunday Evening Club's services is the musical program furnished by a choir of 100 voices under the direction of Edgar Nelson, who was decorated by the King of Sweden. The sermons are delivered by men of national repute, and the entire order of service has long been popular with Chicago residents.

## POEMS BY LONGFELLOW GO ON ETHER AT WOR

Lecturer Honors Poet in Broadcast from Newark Plant

NEWARK, N. J.—Oscar I. Lamberger, Ph. D., author and lecturer, broadcast a most interesting talk from L. Bamberger Station WOR recently, entitled "Longfellow," illustrated by Longfellow's poems.

Dr. Lamberger is a graduate of Leipzig University and was assistant professor of comparative literature at Leipzig University, 1899-1901. He is well known in Germany and England, chiefly for his translations of English and American classics into German.

In conjunction with the late professor, Charles Sprague Smith, of the Peoples Institute, N. Y., and John Collier, he organized "The National Board of Review," an organization which on account of its powerful influence has done much towards the making of high grade motion-pictures, educational and otherwise. Dr. Lamberger is now President of the Longfellow Literary Society with headquarters in Brooklyn, N. Y.

## Plane, Storm Victim, Calls for Repair Squad by Radio

LONDON, ENG.—How Radio can speed ahead and tell of trouble has been illustrated in a recent incident in the airplane service between France and England. A plane in the London-Paris run was damaged in a storm over the English Channel, the damage making it necessary to stop as soon as land was in sight. The pilot realized this, and phoned the extent of the damage and the repairs believed necessary.

Upon his landing near Calais, he found the mechanics ready to work to replace the damaged parts. Fifteen minutes later, the plane was in condition to continue its trip with its twelve passengers. The plane was only ten minutes late in its schedule when it arrived in Paris.

## LEARNING WHAT TO COOK TODAY



The old problem, "What shall I cook today?" no longer bothers modern housewives who have found a ready solution in the Radiophone. Many recipes and menus are broadcast daily from various large stations over the country by leading chefs and cooking experts. The Mrs. Newbywed believes it a great help. © K. & H.

## Radio Helps in Columbus Charity Drive for Kiddies

COLUMBUS, O.—One of the most touching events connected with the annual charity "newsie" drive for the poor kiddies of Columbus, held each year by prominent business and professional men of Columbus, who sell special editions of The Ohio State Journal for charity, was the

Radio appeal broadcast by Attorney General John G. Price, of Ohio. Mr. Price sought the co-operation of Station WPAL, of the Superior Radio & Telegraph Equipment Company, and was given a place on the weekly program before the charity drive.

The smallest Radio set in the world contained in a ten-grain capsule, was recently exhibited in New York city.

## THE ANTENNA BROTHERS

Spir L. and Lew P.

## She Heard His Call

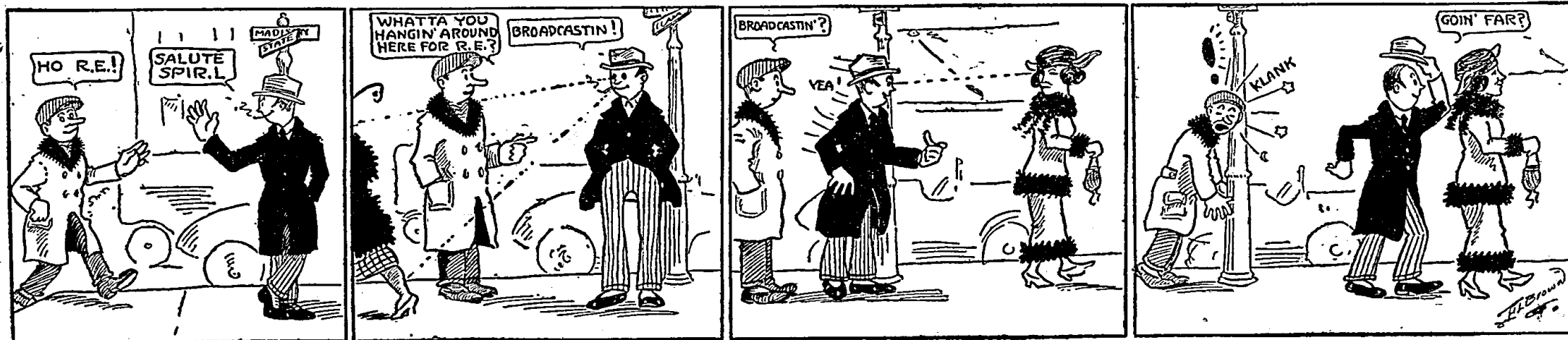

# REBUILDING OF WBZ STRENGTHENS VOICE

## SURMOUNTS ETHER BAR TO ALL NEW ENGLAND

### Improved Springfield Station Uses Two Oscillators and Three Modulators of 250 Watts Each

By R. P. King

Many Radiophans have doubtless noticed that the voice of WBZ, the Westinghouse station at Springfield, Mass., is considerably louder and clearer than it was last winter. There is a good reason for this improvement. The station was entirely rebuilt during the summer and is now one of the finest in the country.

The original station was opened in September, 1921, and was one of the pioneers in the broadcasting field. Only two or three stations now in operation have a longer period of operation record. WBZ was designed to serve New England only, so that its power was limited. But, though it was found to have a consistent range of about 500 miles south and west under good atmospheric conditions, it did not entirely fulfill its purpose.

### All New England Hard to Reach

New England is peculiar from a Radio standpoint, and for some unknown reason there were several areas in this section that WBZ could not reach. The new station, however, has remedied this situation and now can be heard clearly on a detector tube alone all over the northeastern part of the country.

The new transmitting apparatus is of the same type as that used by Stations KDKA, KYW, and WJZ, although somewhat smaller. It has two oscillating tubes and three modulator tubes, each rated at 250 watts. Ten-volt alternating current for the filaments is supplied by a transformer from a 110-volt circuit, and 2000-volt direct current for the plates is supplied by a motor-generator set located outside of the station and remotely controlled from the transmitter. The tubes are kept cooled by a fan mounted behind the transmitter.

### Antenna on 142-Foot Towers

The transmitting antenna is supported by two structural steel towers, 142 feet high. These towers are located on the roof of the company's Radio factory so that the height of the antenna above the ground is 200 feet. The antenna is made up of six phosphor-bronze cables spaced five feet apart and is 220 feet long, between insulators. A counterpoise, of similar dimensions, is suspended 130 feet below the antenna. Special arrangements have been made to prevent breakage of the antenna and counterpoise by ice, and a heavy current can be circulated through the antenna wires and down leads to prevent accumulations during ice storms.

### Shirred Monk Cloth Cuts Out Echoes

The studio, which is located on the third floor of the building, is a room of 20 by 23 feet. Heavy carpets on the floor and shirred monk cloth on the walls and ceilings eliminate all echoes. Among the musical instruments used are a Knabe-Ampico reproducing grand piano, a Victrola, and a Brunswick talking machine.

The condenser type microphone, which is standard at present, is hung from a movable and adjustable stand. Its output passes through three stages of amplification before it goes to the transmitting room, where three more stages of amplification are provided. The studio amplifiers are housed in a cabinet padded with felt. A small receiver with a loop aerial is used to check the character of the performances broadcast.

### Schedule of Operation

WBZ operates every night from 7:30 to 9 P. M. Eastern time. Its regular weekly program includes children's stories, agricultural reports, addresses, and music. On Sunday, chapel services are broadcast at 3 P. M. and church services at 8 P. M. A number of well-known people have addressed the Radio audience from WBZ, including the governor of every New England state, and Dr. Charles R. Steinmetz.

It is stated that more than 2,000 hours of operating time, conservatively estimated to be worth \$150,000, has been saved to navigation interests in the Great Lakes in a single season by Radio advice as to weather conditions.



**Carter "TU-WAY" Radio Plug**  
take two head sets and all types cord tip terminals. Price \$1.50. Write for Bulletin on Carter "HOLD-TITE" Jacks and other products. CARTER RADIO COMPANY, 209 South State Street, CHICAGO

**THE ONLY KNOB and DIAL WITHOUT A SET SCREW**  
ASK YOUR DEALER  
4 in., \$1.50 3 in., \$1.00

**TAIT KNOB & DIAL CO., Inc.**  
11 East 42nd Street NEW YORK CITY

# Growth in Radio Interest Keeps Uncle Sam's "Lab" Staff on Jump

## Information Service Installed for Fans, Experimental Investigations Conducted, Radio Relay Perfected, Improvement Made in Various Outfits as Part of Bureau of Standards Work

WASHINGTON.—During the past year there has been a remarkable increase in popular interest in Radio communication, according to Dr. S. W. Stratton, former chief of the Bureau of Standards. Dr. Stratton continues in part:

"This has been greatly stimulated by the fact that there has become available Radiophone apparatus of satisfactory performance, by means of which market and crop reports and other news, music, and entertainments have been transmitted broadcast and received by many persons. This general interest has resulted in a large increase in the bureau's correspondence on Radio subjects. Dozens of letters asking for Radio information are received each day, and many of these are of considerable importance.

### Radio Information Service Required

"In order to answer such inquiries, as well as to keep the bureau's staff informed on current developments, it has been necessary to devote much time to the maintenance of a Radio information service. An unusually large number of visitors have called at the Radio laboratory, and in order to avoid continual interruption of the regular work in progress special arrangements have been made for demonstrating the exhibits of most general interest. Members of the bureau have delivered a number of lectures on Radio subjects.

### Electron-Tube Generator Research

"Theoretical and experimental investigations were conducted on the power output of electron-tube generators. A paper was prepared for publication on methods of testing and rating electron-tube generators. A special form of electron-tube generator was developed for producing sparks of high frequency for use with recording apparatus for recording the pressure cycle in a gas engine cylinder.

### Work on Radio and Audio Amplifiers

"Special amplifiers, using both Radio frequency and audio frequency amplification, were developed for particular purposes, including direction finding, Radiophone communication with surfboats of the Coast Guard service and reception of material sent broadcast by Radiophony. "A 5-stage amplifier was developed which used 60-cycle alternating current to supply power for the filaments and plates, instead of the usual storage and dry batteries. Both Radio frequency and audio-frequency amplification are used in connection with a crystal detector. This amplifier has aroused considerable interest, and is described in a paper which has been published. A special amplifier was developed for amplifying variations in direct current, or low-frequency alternating currents.

### Radio Relay Perfected

"A Radio-operated relay has been developed which employs audio frequency tuning and has been found effective for operating other mechanisms. Such a relay can be used for the remote control of

mechanisms by Radio. The relay is rugged and highly selective, and is very useful when moderate strays or considerable interference exists. By proper audio frequency tuning it has made clear tape records of messages when interference was so severe that an experienced operator could not copy the message at all by the use of his phones. It can be used for reception at fairly high speeds. Relays of this type have been constructed for various applications in the Signal Corps and other branches of the Government service.

### Equip Surfboat; Communicate Five Miles

"At the request of the Coast Guard, Radiophone transmitting and receiving equipment was installed on a 36-foot motor-driven surfboat, and successful communication in both directions was maintained during a demonstration over a distance of about 5 miles from shore.

"The antenna used on the boat was a single-turn coil antenna, of which the hull of the boat formed a part. A special multistage amplifier was constructed for use in this work.

### Find Better Alcohol for Arcs

"An investigation was conducted to determine the most satisfactory denaturing formula for alcohol used to supply hydrogen in the arc chamber of small arcs, and several kinds of denatured alcohol were found which gave more satisfactory operation than ethyl alcohol, which was used as a comparison standard. Preliminary developments were made on a short-wave arc using electrodes submerged in alcohol.

"Improvements were made in a method of locating an airplane in flight transmitting Radio signals. Two trucks equipped with crossed-coil direction finders were used, and results of satisfactory accuracy were obtained. Other work has been done on direction finding and related problems for the Air Service.

### Test Makes of Receiving Sets

"A comprehensive investigation has been made on the construction, design, and performance of representative types of Radio receiving sets. Methods of testing

## RADIO MAILING LISTS

12,400 Radio Dealers, covering U. S. by states Per list \$7.50  
1,814 Radio Mfrs., covering U. S. by states Per list \$5.00  
1,757 Radio Supply Jobbers, covering U. S. by states Per list \$5.00  
260 Radio Stations Per list \$5.00  
257 Mfrs. who make and assemble complete Radio Sets Per list \$4.00  
25,000 Radio Amateurs & Mfrs. of Radio Stations, Per list \$7.50  
Ask for price list covering Canada and England.  
Send remittance with order.  
Trade Circular Addressing Co., 166 W. Adams St., Chicago, Ill.

and standards of performance have been developed for receiving sets, and publications covering various classes of sets are in preparation. Some of this work has been conducted in co-operation with commercial testing laboratories and retail trade organizations.

"The bureau has co-operated with the National Fire Protection Association in the preparation of a revised rule for Radio installations for the National Electrical code."

## Makes Music on Glasses with Fingers for WEA F

NEW YORK.—One outstanding musical novelty of the present season broadcast from Station WEA F, of the American Telephone and Telegraph Company, was that of recent date when Charles Wold, famous for his work on musical glasses, gave a special program. For many years Mr. Wold has toured the country with these musical glasses, fifty-two in all. Mr. Wold wets his fingers and by rubbing over the edges of the glasses, which contain no water, the skill of his touch produces music of exquisite sweetness.

Isaak Newlin, an Alaskan Eskimo, in his early twenties, is a Radio operator of marked ability.

**FOR YOUR RADIO**

Saves you 50% of the usual cost and you get an unconditional **WRITTEN 2 YEAR GUARANTEE**

Best battery buy on the market today. Thousands of satisfied users.

6-Volt \$8.50 6 Volt \$10.00  
40 Amp. 60 Amp.

6 Volt \$12.50 6-Volt \$14.50  
80 Amp. 100 Amp.

Ask about our rubber containers

**WORLD BATTERY CO.**  
60 E. Roosevelt Rd.—Dept. L.  
CHICAGO, ILLS.

**BALDWIN**  
Master Type  
Dealers: New Discounts  
Hudson-Ross, 123 W. Madison, Chicago

**MAGNAVOX Radio**  
*The Reproducer Supreme*

IN Radio, there are no substitutes for the Magnavox electrodynamic principle.

When you purchase Magnavox apparatus you assure yourself the utmost satisfaction.

**R-2 Magnavox Radio**  
with 18-inch horn (as illustrated)  
For store demonstration, large audiences, dance halls, etc. \$85.00

**R-3 Magnavox Radio**  
with 14-inch horn  
For homes, offices, amateur stations, etc. \$45.00

At good dealers everywhere

**THE MAGNAVOX CO.** New York Office 370 Seventh Ave.  
Oakland, Cal.

"WHEN happiness or calamity is about to come, it can be known beforehand."  
—said Confucius.

Insure complete Radio happiness with a Grebe Receiver.

Doctor My

Licensed under Armstrong U. S. Pat. No. 1113149

**A. H. GREBE & CO., Inc.**  
Richmond Hill, N. Y.

**DELICATE SOLDERING**

The Post Soldering Iron  
Platinum Heating Unit  
Interchangeable Tip  
Universal Current

ONE-HALF ACTUAL SIZE

LISTS AT \$6.00 Awarded Certificate of Excellency, N. Y. Evening Mail Radio Institute

LISTS AT \$6.00

From your dealer or write

**POST ELECTRIC COMPANY,** Dept. 509, 30 E. 42nd St. NEW YORK

# HOW THEY DO IT AT WDAP'S PLANT



Shown at the left is the concert ensemble of WDAP, the Drake Hotel station, Chicago, in the broadcasting studio. Henry Sellinger, standing at the extreme left of the group, is director of the orchestra. Below is Vice-President Coolidge, in Washington, delivering an address into the new Pallophotophone, which later broadcast his voice, recorded on a film, from WGY, Schenectady. The results were so natural that many listeners in believed the voice to be "first hand."

## "Jazz Nomads" Send Wicked Tunes Into "Doughnut" as Lady Visitor Looks On

### Reporter Gets "Inside"

Tells How Drake Hotel Plant, Chicago, Puts Sunday Evening Program on Air

By Vera Brady Shipman

"Say, fellows, aren't you going to play 'Three o'Clock in the Morning?' You've been on fifteen minutes and we've had twenty requests." And the jocular voice which the "Drake Radio Family" knows so well announces—

"By special request the Campus Nomads will play—"

I visited the Drake broadcasting Station WDAP Sunday evening. The broadcasting room is not so privately enclosed as many, and the chance guest can get a wonderful idea of how they do it at WDAP. ("We do Atlantic Pacific," as the announcer adds.)

#### Microphone Resembles Doughnut

The room is heavily hung with draperies on three sides with the fourth side open. Before a microphone which looks like a large black doughnut with smaller doughnuts around the outer edge, the orchestra plays, the soloist sings and the speaker talks to the great unseen, as though the audience were hidden in that doughnut.

A red electric light bulb flashes on when the microphone is open, when the operator in the adjoining room opens the switch which opens the air to the broadcasters. Intense silence drops at the moment the light flashes on. The orchestra if not ready, quickly assembles itself, and instantly the opening chords are sounded. When the number is finished, silence until the red bulb goes out. Then the hubbub resumes until the next red flash.

#### Glimpse at Musicians

The Sunday night program I heard was given by the Campus Nomads, a group of five Northwestern University students who are jazzing their way to knowledge, and the Drake Hotel Orchestral Ensemble of five soloists under the direction of Henry Sellinger. Also pianologues by Jean King Leighton with Anne Mortensen Herre at the piano, were sent forth over the air in Miss Leighton's regular fashion of interesting dialect.

Two grand pianos in the broadcasting room are used for every kind of musical entertainment, all of which are under the personal direction of Mrs. Saida Balentine.

The Drake station, which unlike others in Chicago, is privately owned, began its existence atop the Wrigley building a year or so ago and is owned by two Chicago men, Thorne Donnelley and J. Elliott Jenkins.

#### Goes to Transmitter Room

By the courtesy of the announcer-operator (oh, how he hated to let a woman in, and I can't blame him), Ralph Shukart, otherwise called "The Sheik of the Drake," I was allowed to go silently into the operating room. Here the operator broadcasts his announcements through the same kind of a "doughnut" microphone, which catches every room sound as well as long-distance wire telephone interference.

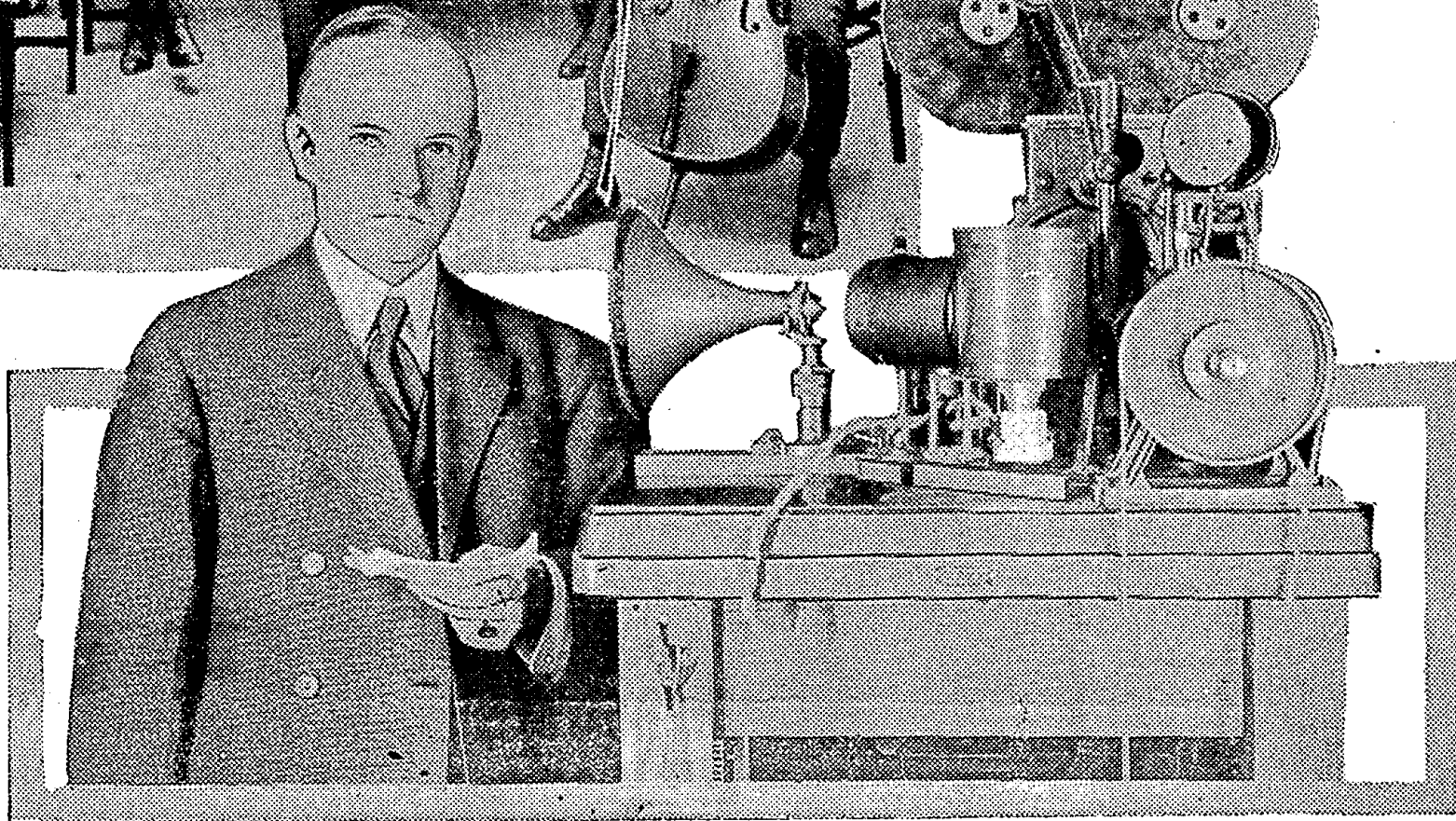

Here the operator listens in on the musical program and times his announcements accordingly. The second operator, M. L. Green, courteously gave me some of the data needed for this story.

#### Fine Feeling Pervades Plant

I meant to stay just a short time, but I found upon leaving that I had been there nearly two hours. The time flew and the informality, the courtesy from the owner on down to each assisting operator, and the comradeship which exists throughout this station strengthened the feeling that the listener in always obtains of the "Drake family."

As I left the top floor of the Drake, the boys at the telephone were still answering—

"Oh, yes, Madam, they have played 'Three o'Clock' and I am sure they will play it again before the evening is over, Yes, Madam, glad you called."

## Close Large Business Deal by Air; 'Bugs' Aid

COLUMBUS, O.—Except for the customary written confirmation and acceptance, a business deal involving several hundred dollars brought to a successful close by Radio recently by the Columbus Slate Company, it has been announced by H. W. Webb, secretary and treasurer of the company. Amateur operators were the exclusive "agents" in this matter.

Frank Hahne, tin and sheet iron worker of Savannah, Georgia, is an old customer of the Columbus Slate company and also is a code Radio enthusiast. On Thanksgiving morning, he sat down to his transmitting set and sent a message to the Columbus firm. It was picked up by an amateur in Cincinnati, who in turn relayed it. R. C. Bohannon, with the Erner & Hopkins company, Station WBAV, received the message at his home and called Mr. Webb on the telephone. Mr. Webb at once quoted by telegraph the price on sea green slate, according to the amount wanted. The next day, Hahne sent the written confirmation and also a Radio confirmation. A return telegram acknowledged the order and the deal was closed.

This is believed to be the first time in the Radio history of Ohio that business has been negotiated through amateur Radio stations.

## Device Photographs Voice on Film Reproducing Message for Broadcast

Flickers of Tiny Mirror Record Speech on Pallophotophone Film—Developed Strip Gives Natural Tones—Weeks', Denby's and Coolidge's Speeches Reach All Corners of U. S. at Once by Means of Instrument

By B. S. Beach

Christmas greetings and messages to the people of the United States from Vice President Coolidge, Secretary of War Weeks and from Secretary of Navy Denby were broadcast on Christmas eve from Station WGY, the General Electric transmitter at Schenectady, N. Y., without their being present, or speaking, in fact. This was the first time that three leading executives of the country ever attempted to extend their greetings in a way that reached the four corners of the country simultaneously. The feat was made possible by use of the Pallophotophone, a new device for photographing the voice and later reproducing it with perfect clearness.

#### How It Was Done

The machine was set up in a hotel in Washington ten days before. The vice president and the war and navy secretaries spoke into a small recording horn. As they did, their voices caused a small diaphragm to vibrate to which is attached a tiny mirror, scarcely smaller than the head of a pin. This oscillation or flickering of the mirror reflected a beam of light upon a moving photographic film, thus recording the human voice accurately with the overtones, the delicate shadings of speech, and all other characteristics which make one voice sound different from another.

#### Develop Film, Reproduce Messages

The film was then taken to Schenectady and was broadcast twice on Christmas eve from the WGY studio, the first time at 7:30 o'clock Eastern time, during the regular Christmas program and then again at 10:30 o'clock for Radiophans in the western states.

In reproducing, the film is passed before a strong ray of light and the zigzag markings photographed on it by the sound waves create electric waves which pass through an arrangement of vacuum tubes and produce sound waves again

which are sent directly into the Radio broadcasting apparatus without the use of a microphone or any sort of a pickup device ordinarily used.

#### Value of Device

The feat of recording the speech of a person in a distant city is believed to have introduced an entirely new element in Radio broadcasting—the possibility of making a master record and then broadcasting it days or weeks later from any Radio station in the country.

The reality of the characteristics of the reproduced and broadcast voices was evinced by thousands of complimentary letters received by WGY from fans who praised the feat. The following is to WGY from W. C. Crews, who listened in on a single tube, non-regenerating set, 500 miles away from Schenectady, N. Y.:

"Calvin Coolidge, Weeks and Denby came in just grand, almost as though they were in the next room—sounded as though it was the real thing. Had you not said something about Photophone I never would have known the difference. To me it seemed marvelous.

"I am sure thousands of fans throughout the country would be interested in knowing the outcome of the experiment, as it related to Europe as well as knowing something in detail about the Photophone, and it is suggested that when results are definitely known that they be given to RADIO DIGEST for a story."

#### Give Set to Wounded Vets

SPRINGFIELD, O.—Mrs. Albert A. Wright, of this city, is the chairman of a committee of the Woman's Auxiliary of the Springfield American Legion, which on Christmas Day presented a complete Radio receiving set to the wounded world war veterans of Ward 27 at the National Soldiers' Home in Dayton. The men in the ward are those suffering from tuberculosis, shell shock and wounds received in service overseas.

## SERVICE OF BRITISH RANKS BELOW U. S.

### ENGLAND TRIES NEW PLAN IN LICENSING

Canadian Radio Official Declares American Standards Are Models in Britain

OTTAWA, CAN.—Lieut. Com. C. P. Edwards, director of Radio in the department of marine at Ottawa, Ontario, has just arrived back from a visit to Great Britain, where he went as technical advisor to the Hon. Ernest Lapointe, minister of marine, in connection with the imperial Radio scheme.

Interviewed by a representative of RADIO DIGEST, Commander Edwards declined to make any statement about the imperial Radio project until Mr. Lapointe returns. The matter was still under discussion when Mr. Edwards left and consequently he has no knowledge of the decision finally reached.

#### Consents to Cross-Examination

He consented, however, to undergo a cross-examination at the hands of RADIO DIGEST on the subject of Radio development in Great Britain.

"What actual progress," he was asked, "is broadcasting making in the British Isles?"

"The first broadcasting station was opened while I was there," replied Commander Edwards. "An entirely different scheme from ours and that in the United States is being followed. In Britain the principle of granting licenses to different people has been rejected. Licenses are granted to a specially established broadcasting company which is authorized to establish stations in each territorial area until the whole of the British Isles is covered. Seven or eight stations are contemplated, London, Birmingham and Manchester being among the centers chosen for the location.

#### Britain Not Up on Quality

"In the matter of quality of transmission and also in the matter of programs the British stations have not yet achieved the high standards attained by the first-class stations in the United States. They would appear to be about where your stations were twelve months ago, but there is little doubt that when they enjoy the same experience in broadcasting as the stations in America and Canada they will approximate to the same standards."

#### Hold American Standards as Models

"Is public interest in Radio keen?" he was asked.

"Decidedly so, and it is growing by leaps and bounds every day. The Prince of Wales, for instance, has already spoken via the London station several times."

"What reputation does the stations in the United States enjoy in Great Britain?" asked the RADIO DIGEST representative.

"I was surprised and delighted to find the reputation for reliability and accuracy held by the American direction finding stations stood very high. In fact, they are regarded more or less as models whose standards should be emulated as far as possible."

## Official Books Give Data on Simple Sets

### Uncle Sam's Circulars Describe Crystal and Electron Outfits

WASHINGTON.—To meet the great popular interest in the use of Radio receiving apparatus, the Bureau of Standards is publishing a series of circulars descriptive of simple receiving sets. The first two of this series are Bureau of Standards Circulars 120 and 121. These two circulars describe the receiving sets which use crystal detectors.

The third paper of this series is Bureau of Standards Circular 133. This circular is a description of an electron tube detector and gives instructions for its operation. A receiving set employing an electron tube detector is more sensitive than a set employing a crystal detector and may be expected to give more satisfactory results. The tuning devices, antenna, lightning switch, ground connection, and telephone receivers with which this electron tube detector is used may be those previously described in Circulars 120 and 121.

This paper describes in detail the various parts which constitute the electron tube detector unit and gives illustrations showing the arrangement of these parts in the complete assembled unit. Detailed instructions for operating this set are also given.

#### WGI Studio Gets Organ

MEDFORD HILLSIDE, MASS.—A motor-driven reed organ has been installed in the Station WGI studio in a specially prepared room, and regular organ recitals by the best organists in the country will be given frequently. The organ was especially built for the Amrad station, and consists of two manuals, foot pedals and eighteen stops.

## Book Reviews

**Home Radio—How to Make It.** By A. Hyatt Verrill. This book is particularly adapted for the amateur who desires to know how to make Radiophones. Twelve full page illustrations and diagrams. Price, 75c.

**Radio Experimenter's Hand Book.** By M. B. Sleeper. This book will help in the selection and the construction of simple apparatus for transmission and reception of Radio telegraph and telephone signals. Price, \$1.00.

**Elements of Radio Telephony.** By William C. Ballard, Jr., M. E. A reliable, authoritative discussion, in simple form, of the essential principles of Radio telephony and their application. The use of mathematics has been almost entirely avoided. Price, \$1.50.

**Radio for the Amateur.** By A. H. Packer and R. R. Haugh. The underlying principles of Radio thoroughly explained in simple language and understandable illustrations. This book will teach you how to construct and operate a receiving set successfully. Price, \$1.50.

**The Radio Amateur's Handbook.** By A. Frederick Collins. A new revised edition of this book is just out. It is complete, authentic, and informative work on Radio. Fully illustrated. Price, \$1.50.

**Radio Receivers for Beginners.** By Snodgrass and Camp. Answers the universal question, "How can I receive Radio?" Price, \$1.00.

**Radio First Aid.** Illustrated with working drawings and complete data as to the necessary equipment and cost of constructing from the simplest to the most modern Radio outfits at home. Price, \$1.

**How to Retail Radio.** A new book telling of tested plans and methods and policies for the dealer in Radio. Financing, location, store equipment and arrangement. Price, \$2.00.

**Radio Reception.** By Harry J. Marx, Technical Editor Radio Digest Illustrated, and Adrian Van Huffling. A simple treatise on Radio reception. Beginning with the elementary principles of electricity, it carries the reader on into the essentials of Radio telephony. The most successful methods of Radio reception are explained and special reference given to practical tuning. 230 pages, with 130 illustrations. Price, \$2.00.

The book department of the Radio Digest is prepared to send you any of the books on Radio published, whether listed in our Book Review or not. Let us know what book you want, send us your check and we will see that the book is mailed to you. Postage stamps in payment for books not accepted. Send money order or check. Book Department, Radio Digest Illustrated, 123 W. Madison St., Chicago, Ill.

## "SANTA" NOTES IN AIR BRING CHEER TO KIDS

### Goodfellows, Hearing Youngsters' Letters, Lend Hand

MEDFORD HILLSIDE, MASS.—Tangible evidence that the Santa Claus letters read over the Radiophone from Station WGI made a hit, not only with old Santa but with other Radiophans who listened in, is shown in several cases that came to the attention of the Amrad Station management. One letter from four little children of Italian parentage to Santa, sent to WGI and broadcast, asked Santa for a "good reading book and some games, with a choo-choo train for little brother and a sleeping Mama doll for little sister, because there would be no Christmas at their house, since papa had had to spend all his savings for big sister's funeral."

Within five minutes after this letter was broadcast, a representative of the Somerville, Mass., lodge of Elks telephoned for confirmation of the name and address so that they might help the unlucky youngsters with a Christmas dinner. A second telephone message came from a Cambridge business man who wanted to see that Santa brought them a basket of toys and playthings. Over 1,000 letters to Santa Claus were received by WGI and broadcast.

#### Fraternities Have "Nights"

MEDFORD, MASS.—The first of a series of fraternity and club nights was held at Station WGI recently, when the Boston Masonic Club had a night, with a special program under the direction of Pres. W. L. Terhune of the club.

A card was recently received at Schenecady, N. Y., from Maui, Hawaii, saying that signals from WGI had been clear.

**"ALL-AMERICAN" Amplifying Transformers**  
Two years of successful use all over the world guarantees permanent satisfaction. Radio and Audio Frequency.  
SEND FOR CIRCULARS  
**RAULAND MANUFACTURING CO.**  
35 South Dearborn Street Chicago

## RECEIVING RECORDS? SEND 'EM IN—

IN the last issue of RADIO DIGEST the complete, verified list of receiving records to date was published. During the week, the following new and superseding records were made. In order to inform new readers, the rules of the contest can be found in the last issue. The complete list of records, revised and with rules, will appear in the February 10 issue.

#### Station—Miles Away—Holder and Location

CFAC—1650, R. A. Deger, Dayton, O.  
CFCN—1650, H. R. Wunder, Cheviot, O.  
CJCG—1375, D. J. Morris, Weir, Tex.  
CKCK—1450, D. J. Morris, Weir, Tex.  
KDYW—1025, C. B. Martin, Springfield, S. D.  
KDZF—1850, C. H. Nolder, Cincinnati, O.  
KFAP—1950, A. M. Tobias, East Orange, N. J.  
KFBD—1375, W. M. K. Young, Kansas City, Mo.  
KFCE—1300, R. Talbott, Grinnell, Ia.  
KFCK—1100, R. A. Deger, Cheviot, O.  
KFDB—2025, H. R. Wunder, Cheviot, O.  
KFDF—1150, H. R. Wunder, Cheviot, O.  
KFW—1125, C. B. Martin, Springfield, S. D.  
KJJ—1325, C. B. Martin, Springfield, S. D.  
KJR—1500, W. M. K. Young, Kansas City, Mo.  
KNI—2075, R. A. Deger, Dayton, O.  
KON—1900, F. Brinnon, Urbana, O.  
KOP—1175, D. J. Morris, Weir, Tex.  
KPO—1400, L. Snider, Sioux Falls, S. D.  
KSD—1700, N. E. Parr, Albany, Ore.  
NOF—1100, C. B. Martin, Springfield, S. D.  
WCAH—1075, D. J. Morris, Weir, Tex.  
WCAY—1050, D. J. Morris, Weir, Tex.  
WVN—1200, W. M. K. Young, Kansas City, Mo.  
WDAJ—2175, G. L. Harms, Portland, Ore.  
WDAW—1175, C. B. Martin, Springfield, S. D.  
WEAF—2450, N. E. Parr, Albany, Ore.  
WFO—1000, D. J. Morris, Weir, Tex.  
WGAY—1000, D. J. Morris, Weir, Tex.  
WGR—2175, N. E. Parr, Albany, Ore.  
WIAO—1050, D. J. Morris, Weir, Tex.  
WJAD—1625, G. F. Cory, New Bedford, Mass.  
WJAP—1200, D. J. Morris, Weir, Tex.  
WJAZ—1200, C. B. Martin, Springfield, S. D.  
WMAT—1500, N. E. Parr, Albany, Ore.  
WOOA—1525, G. F. Cory, New Bedford, Mass.  
WOAC—1050, D. J. Morris, Weir, Tex.  
WRL—1100, W. M. K. Young, Kansas City, Mo.

## \$866,000 TO REPAIR NAVY RADIO PLANTS

### Congress Hears Heating and Lighting of Station Costs \$956,000 in Year

WASHINGTON.—Some very interesting facts regarding naval Radio activities have been brought out during recent hearings on the naval appropriation bill by Congress. The statement was made during the hearings that \$866,300 was spent during the past year for repairs to worn out parts of Radio stations and that \$956,000 was spent for heating, light and power in naval Radio stations. There are at present 100 naval Radio stations operating, which is a reduction from last year of 37, of which number 62 are Radio compass stations.

Answering a question by one of the congressmen, the expert who was on the stand stated that in 1922 the Navy Department has spent \$2,510,421 on Radio apparatus, while it is asking for \$1,823,255 for next year. The maintenance costs have been reduced, it is said, and they are now lower than they have been for many years. During the course of the hearings, the statement was made that the Navy Department is allowing commercial concerns to take over such stations as the Navy does not need.

In response to a question as to the amount spent in 1922, the expert said that it was roughly \$3,000,000, but the Navy Department desires to cut this considerably and the request for the appropriation was reduced to approximately \$150,000 per month for 1923. With ship work it is running about \$250,000 a month gross for all Radio work. It was said that there has been a great increase in non-commercial traffic.

In Canada the Royal Canadian horse artillery has met with great success in its maneuvers by directing artillery fire from an airplane by means of Radio communications.

#### IMPROVED REINARTZ CIRCUIT

My highly improved circuit brings in all important stations from both coasts and the Mexican border without any distortion or other noises. We dance to music from Atlanta received on one loud Baldwin unit. Build one of these supersensitive sets from my blueprints and specifications. Price 50c or with a perfect and complete double wound spidervob coil \$3.00 by mail. No other windings used. Photo of my set on a glass panel with every order. Everything clearly shown. Cheap and easy to build. Easy to operate.  
S. A. TWITCHELL, 1925 Western Av., Minneapolis, Minn.

#### Tell Us Your Radio Troubles

##### OUR ADVICE MAY HELP YOU

Give full particulars, make of instrument, local conditions, type and length of aerial. No circular letter proposition. Each case is individual.

Enclose 25c and addressed stamped envelope to

#### Radio Information Bureau

627 First Avenue North, MINNEAPOLIS, MINNESOTA

## "SPARK PLUG" HITS ON ALL CYLINDERS

### CHARITY DOLLARS ROLL IN AS FANS CHUCKLE

KFC Announcer with Novel Scheme and Bits of Comedy Swells Fund for Poor

#### By A. M. Ottenheimer

SEATTLE, WASH.—A new phase of Radio broadcasting presents itself almost every day, but one of the latest to come to light is of a nature entirely different from any previously revealed.

The Seattle Post-Intelligencer, operators of KFC, a 100-watt station, during the Christmas season every year conducts a campaign for funds for the needy of Seattle. This year, however, Radio, through KFC, was put in use and when the drive was finished, the Seattle station had the assistance of a station in San Francisco, one in Calgary and another in Denver.

The announcer at KFC, who has dubbed himself "Spark Plug," devised a system whereby the dollars literally rolled into the fund. He explained that for \$5, which was to be turned into the fund, KFC would play any record requested. Each request was acknowledged and the announcer, a man with a keen sense of humor, had fans for hundreds of miles around rocking in laughter at his remarks. A small triangle, which he tinkled upon the receipt of each call, he explained as the clank of the cash register. His remarks were novel and the affair created much comment.

#### Frisco Plant Joins in Scheme

The campaign began early in December and on December 8 the operators at KFDB, the Mercantile Trust Company station on Telegraph Hill, San Francisco, heard "Spark Plug" explain his plan. The plan was simple: upon the promise of \$5 from any auditor, KFC was playing any record requested. The operator at KFC was struck with the idea that he might find some customers in San Francisco. So he called KFDB and offered to play any record for Californians—with the same \$5 poor fund proviso.

The idea took instantly. Customers began to come. Then a new phase was added. A Seattle fan would call for a record. KFC would transmit the call to KFDB, and the latter would play the record. The strength of the San Francisco station made it possible for Seattle contributors to the fund actually to dance to San Francisco music.

#### CFCN and KFAF Recruited

CFCN, the W. W. Grant Radio, Ltd., station in Calgary, Alberta, Canada, then joined in and the \$5 contributions from Canadian listeners were obtained in the same manner. KFAF, the Western Radio Corporation outfit in Denver, Colo., also took part in the performance for one night.

KFC made an appeal to President Harding to contribute \$10 to the fund. KFDB picked it up and relayed it on. Other stations across the continent relayed it to Washington, D. C., stations. KFDB also broadcasted a call for contributions to every governor in the United States, asking other stations to relay the message on to its proper destination.

The triangular conversations between Seattle, Calgary and San Francisco were carried on late at night, the San Francisco station operating under its experimental license call of 6XB, but hundreds of Radiophans stayed up late at night just for that purpose. Several hundreds of dollars were "Radioly" raised for the fund.

For the first time in history, airplane races have been reported by Radio.

## FRESHMAN

### Variable Grid Leak and Micon Condenser Combined

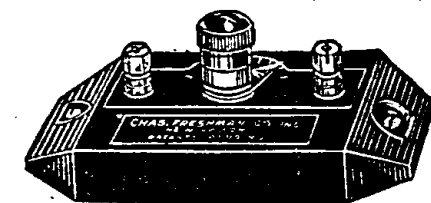

Clarifies Signals, Lowers Filament Current, Increases Battery Life, Eliminates Hissing.

Unbroken range—zero to 5 Megohms; all intermediate points. Fixed capacity, .00025 M. F.

Price Only \$1.00

At your dealers—otherwise send purchase price and you will be supplied without further charge.

Manufactured by

**Chas. Freshman Co., Inc.**  
97 Beekman Street, New York City

# The Reinartz Set

## Its Construction and Operation

The photo diagram illustrates a Reinartz regenerative receiver designed and built by Benjamin E. Freund in the Radio laboratory of the Chicago Salvage Stock Store, Radio dealers located in Chicago. The efficiency of this simple regenerative set is

surprising to many Radiophans. Undoubtedly it is one of the most satisfactory receivers. On page thirteen, Harry J. Marx explains how to make and use the set illustrated here. Turn to Mr. Marx' page and you'll want to make a Reinartz receiver.

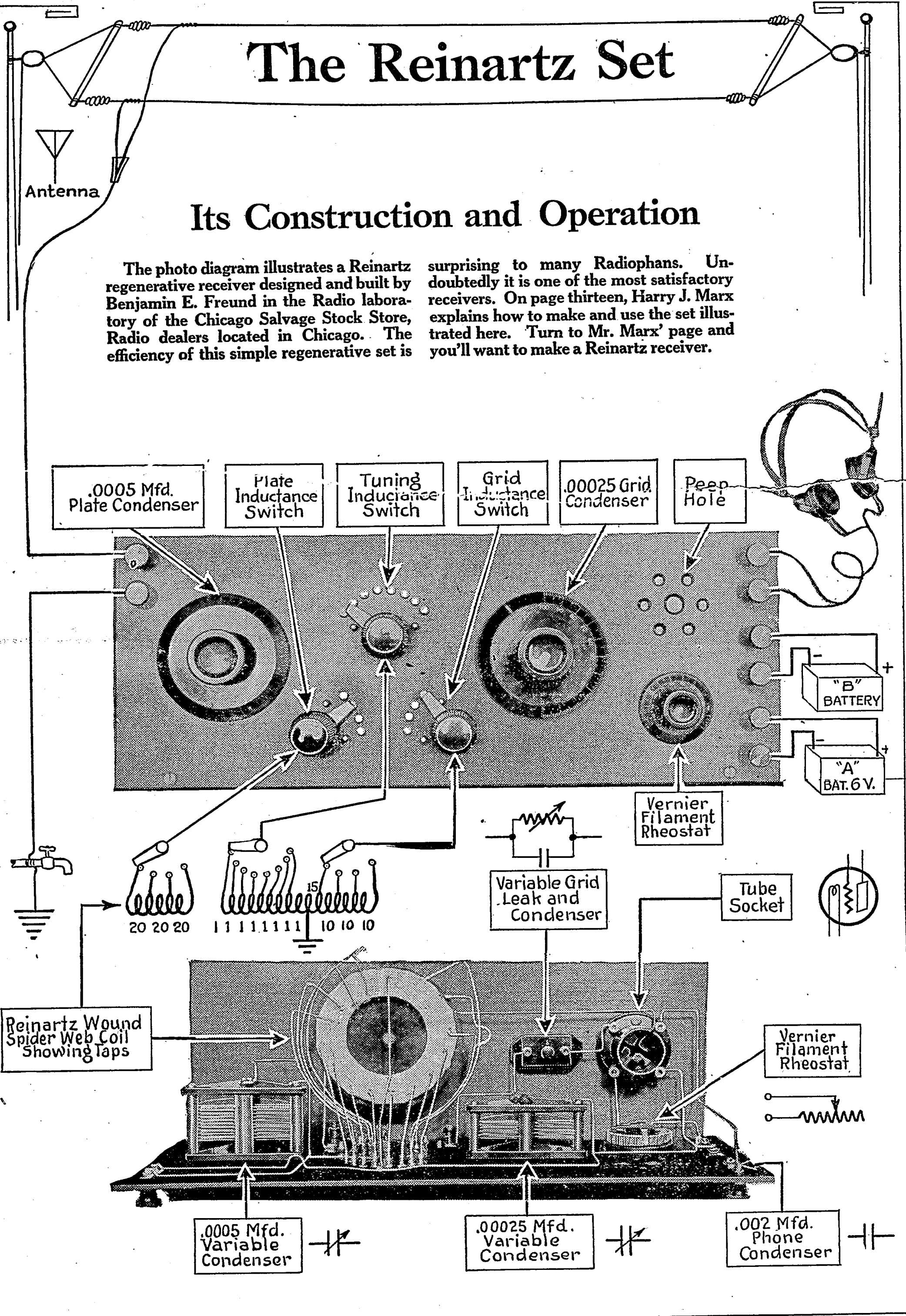





## PLANT OWNERS IN BETTERMENT GROUP

### ORGANIZE TO IMPROVE BROADCAST SITUATION

Washington Station Proprietors Send "Feelers" to Learn Public Wants in Radio Entertainment

WASHINGTON.—Definite action which may insure the permanent improvement of the Radio broadcasting situation in the District of Columbia was taken when owners and representatives of all broadcasting stations here met at the City Club as guests of Harold H. Levi, general manager of the Hecht Company, owners of Station WEAS, and formed the Radio Broadcasters' Association of Washington. The membership includes representatives of concerns operating broadcasting stations in the District of Columbia only. C. O. Fisher, manager of the Radio department of Woodward & Lothrop, was unanimously elected president. A committee was appointed to prepare and arrange publicity for a questionnaire to determine the wishes of the public concerning the nature of Radio entertainment desired. The most important action taken was improving the arrangement of broadcasting schedules.

#### To Study Public Demand

Mr. Levi urged those present to co-operate, organize and make a study of the public demand for Radio entertainment. C. O. Fischer and Chief Radio Inspector Terrell, who was elected an honorary member of the association, spoke briefly. Mr. Terrell described methods pursued in other communities, particularly New York City, where station operators have made every effort to co-operate for greater efficiency on the part of broadcasting stations, and likewise for the greater benefit shared by the public and listeners in.

As the object of the session was the furtherance of co-operation between operators of broadcasting stations and the public dependent on the entertainment supplied by these stations, it was decided by all those present to eliminate so far as possible long waits between the announcements and the actual broadcasts of selections on Radio programs.

## Radio to Assist China Missions

Phones and Airplanes to Help Work of Methodist Episcopal Church in Orient

BOSTON, MASS.—Word has been received by the Methodist Episcopal missionary department that Radiophones and airplanes are to be used as an aid in carrying on missionary work of the church in virtually inaccessible parts of China. This announcement is made by the committee on conservation and church advancement, the statement further adding that the decision was reached at a conference of missionaries in Tzechow, West China. Rev. James Maxon Yard, new executive secretary of the centenary, in China, sent the news to Rev. Paul Hutchinson, editor of the Chinese Advocate, and the latter relayed it by Radio to the committee in America. The Tzechow district is several weeks' journey from Shanghai and the missionaries there can see the mountains of Tibet from their headquarters. It lies in one of the wealthiest provinces of China, Szechuen, with 60,000,000 inhabitants. The Radiophone and airplane at present are the only means available for communication and quick transportation.

## Predicts Wider Use of Air Waves by Farmers

Weather Bureau Chief Sees Steps Beyond Forecasts Stage

WASHINGTON.—A great future increase in use of Radio by farmers is forecast in the report of Dr. C. F. Marvin, chief of the weather bureau, to the Secretary of Agriculture.

"The great value of Radiophony as a means for disseminating weather forecasts and warnings to the people already has been demonstrated," Dr. Marvin pointed out. "Its future usefulness cannot be estimated."

Extension of telephone lines into rural districts overcame only a part of the difficulty of giving the farmer the latest weather advice, the report continued. Then came Radio. "Thousands of farmers installed such receiving apparatus during the past year, and are now obtaining the weather forecasts and warnings which are so important to their operations, as promptly and effectively as the business interests in urban communities," said Dr. Marvin.

## KITCHEN, BUSINESS HELPS TO WGI FANS

Women's Club Expert Gives Tuesday Cooking Tips—Market News Four Days

MEDFORD HILLSIDE, MASS.—Several new features have been added to the broadcasting program of WGI, Amrad station here. In the afternoon on Tuesdays, the Amrad Women's Club has an hour, and for a time a series of helpful cooking lessons by Mrs. Christine Frederick, director of the Applecroft Efficiency Station, will be given. The first lesson was "The Bride's Own Cooking Primer," a lesson intended for newlyweds.

The broadcasting of information of interest to business men has proven so popular that the regular program has been enlarged and includes the following: Mondays, at 6 p. m., a weekly review of conditions in the iron and steel industry, prepared by the Iron Trade Review; Tuesdays, at 6 p. m., Babson business report, assembled by the Babson Statistical Organization and reviewing the economic situation of the past week; Wednesdays, at the same hour, "News of the Wool Market," prepared by the Commercial Bulletin and arranged so that the layman as well as wool dealers and merchants may be interested; Thursdays, "Weekly Review of the Shoe and Leather Industry," prepared by the New England Shoe and Leather Association, same hour.

## Radiophone Used to Direct Movie

Rex Ingram Controls Crowds in "Prisoner of Zenda" by New Device

LOS ANGELES, CALIF.—Radiophony has found new application in the hands of Rex Ingram, director of "The Prisoner of Zenda," in giving commands to the young army of extras in the great coronation scenes.

It was during the height of the recent Radio popularity that the brilliant young director undertook to transfer to the screen Anthony Hope's celebrated romance, "The Prisoner of Zenda," which was dramatized by Edward Rose.

In the course of making "The Four Horsemen," Mr. Ingram had encountered an obstacle in the control of the thousands of actors in the big scenes. He had in that case used a wire telephone with success. But with the advent of the Radiophone, he saw one undeniable superiority in the newer instrument; that there need be no switchboard operator to delay the transmission of his direction.

Practical use of the Radio idea brought approval from Mr. Ingram. The working out of the scheme was not so complicated as he had anticipated. By placing sub-directors to issue orders to every group in the crowds at the coronation scenes, and so arranging the position of these sub-directors as to hide them from the camera, and equipping them with receiving apparatus tuned to the same wave length as the transmitter he used, he was able to direct the entire mass of people with great success and instant response.

## Radio Carries Coolidge's Voice into Distant Homes

WASHINGTON.—Vice President Coolidge has received some interesting communications in connection with the broadcasting of his talk on Americanism which was sent out by Station WGY at Schenectady, N. Y., on Christmas Eve. A great number of communications have reached the Vice President, including one from Jasper, Ind., Carthage, Mo., Gypsum, Kans., Greensboro, Ala., and other distant places.

The communication from Carthage says in part: "Your message was as clear as though you were speaking to us ten feet away."

From Gypsum comes the following: "Articulation and modulation were as perfect here through a loud speaker as though I had been there."

From Omaha, Neb.: "This address was received in our home, every word perfectly audible and very clear, and it almost fills one with awe at the thought of the great possibilities of the future of the Radio as a servant of the public."

## Champ Canary Warblers Entertain from Chicago

CHICAGO.—Probably the most novel features of any program broadcast by Radio was recently sent out from Station KYW. This entertainment was given in connection with a recent midnight show and consisted of the singing of twelve champion roller canaries. These birds were the prize winners in the International Roller Canary contest held at the local Hotel Sherman. Several of the wee yellow warblers have toured the world, and have the distinction of having sung at the Crystal Palace in London before King George.

# R-A-D-I-O

BUY HERE FOR LESS

Radio Supplies purchased here are sold under a positive guarantee of satisfaction. We carry the largest new stock of first quality merchandise.

## Complete Parts for Reinartz Circuit

Includes 17x18 Formica Panel, 1 Bakelite Socket, 1 Howard Vernier Rheostat, 23 Plate Condenser, 11 Plate Condenser, 3 Switch Levers, 2 Dozen Switch Points, 1 Reinartz Wound Coil, 1 Variable Grid Leak, 8 Binding Posts, 25 Feet Tinned Wire, 1 Base for Coil, 1 Mounting Base Board, and 1 Diagram **\$11.45** to Construct This Set. Complete...

ORIGINAL TYPE "C" BALDWIN UNITS .....\$4.95

### COMPLETE PARTS FOR REGENERATIVE SETS

This includes 2 Variometers, 1 Coupler, 3 Dials, 1 Rheostat, 1 Cunningham Detector Tube, 1 Bakelite Socket, 1 Mahogany Cabinet, 7x18 Formica Panel, 6 Binding Posts, 1 Switch Lever, 12 Switch Points, 2 Stops and 1 Diagram to construct this set. Set is capable of receiving 1,000 miles if installed with outdoor aerial..... \$17.95

### VARIABLE CONDENSERS

\$4.30 Value, 43 PLATE, now \$1.75    \$3.10 Value, 5 PLATE, now \$1.25  
\$3.70 Value, 23 PLATE, now \$1.45    \$2.70 Value, 3 PLATE, now \$1.15  
\$3.30 Value, 11 PLATE, now \$1.35

### U. S. A. Signal Corps Aviation Type 194-W Western Electric Phones, \$7.95

Each Phone Cap is covered with large soft rubber ear cushions, and an aviation leather helmet goes with each set! These are the only phones to pass the Government specifications for sensitiveness and loudness, the requirements called for in aircraft reception.

### COMPLETE PARTS FOR FLEWELLING CIRCUIT

Includes 6x14 Formica Panel, 23 Plate Condenser, 3 Micon .006 Condensers, 1 Freshman Variable Grid Leak, 1 Remler Leak, 2 Coil Mount, 2 Honeycomb Coils, 2 Coil Plugs, 8 Binding Posts and 1 Diagram to Wire and Construct This Set. Complete..... \$12.45

### MAGNAVOX, Loud Speaker, Type R3 \$34.95

VARIOMETERS    GENUINE MAHOGANY, \$5 VALUE, NOW    \$1.95

VARIOCOUPERS, \$4.50 Value, Now \$1.75

### HONEYCOMB COILS

1,500 Turns.....\$1.50	750 Turns.....\$1.00	75 Turns.....40c
1,250 Turns.....1.50	250 Turns.....75c	50 Turns.....40c
1,000 Turns.....1.25	150 Turns.....60c	35 and 25 Turns.....40c
	100 Turns.....50c	

\$8.50 Guaranteed 3,000 Ohm

HEAD PHONES **\$3.65**

RHEOSTATS.....45c

Sponge Rubber EAR CAPS, Pair.....50c

DIALS, 2, 3 and 3 1/2 in.....25c

THORDARSON AMPLIFYING TRANSFORMERS \$4.50 VALUE, NOW \$2.95

GREWOL DETECTORS.....\$1.65

Signal Corps Super Sensitive Microphone Transmitters, \$2.45

Solid Copper Aerial Wire, 100 ft. ....35c	2-Slide Tuning Coils, at 3-Coil Honeycomb Mountings, with knobs .....\$1.95	Anti-Capacity Switches .....\$1.50
Spaghetti Tubing, yard .....10c	Phone Caps, for mostly all phones .....25c	Lightning Switches .....\$2.65
Cord Tip Plugs .....60c	Signal Corps Hot Wire Ammeters, at .....\$5.45	Hydrometers, now at .....45c
Lightning Arresters .....95c		Radio Crystal, at .....35c

FORMICA PANEL 1/8" thick, Square Inch. 1 1/2 BLACK OR BROWN

WE GUARANTEE ALL MERCHANDISE PURCHASED OF US  
Mail orders filled same day received

BUY HERE FOR LESS

# CHICAGO SALVAGE STOCK STORE

509 South State Street, Chicago, Ill.

# Radio Digest Illustrated

TRADE-MARK

Published by the Radio Digest Publishing Company, Inc.  
123 West Madison Street  
Telephone State 4844-4845  
Chicago, Illinois

E. C. RAYNER, Publisher  
Chas. F. Smisor, Editor Evans E. Plummer, Managing Editor  
Harry J. Marx, Technical Editor

Eastern Representative, Jacob Miller, 2126 Broadway, New York  
Telephone Columbus 2390

Pacific Coast Representatives  
E. J. Wood, 251 Kearny St., San Francisco  
Telephone Kearny 1472

H. M. Morris, 417 Western Mutual Life Building, Los Angeles  
Telephone 12011

58

PUBLISHED WEEKLY

SUBSCRIPTION RATES

Yearly.....\$5.00 | Foreign.....\$6.00  
Single Copies, 10 Cents

Vol. IV Chicago, Saturday, January 13, 1923 No. 1

## Radio Brings Cheer

First Year's Popularity of the Science

RADIO is a great many years older than many realize. That is in a strict sense, it has existed rather obscurely for many years. But it was about this time, a year ago, that the Radiophone sprang boldly into the limelight and grew in popularity at a breathtaking pace, until it reached its present status as an institution almost as firmly established as if it had grown steadily for a decade.

Radio, in its recreational phase, has achieved popularity more quickly and more consistently than almost any other thing the American public has ever known. It has come to stay. It is spreading across the world. Conservative estimates have placed at better than a million the number of interested auditors who are equipped with Radio receiving outfits varying from home-made crystal sets, built of scraps, at an outlay of a quarter of a dollar, to magnificent tube sets of values up to a thousand dollars. The number is expected to double during the ensuing year.

Radio reaches everywhere. Few barriers prevail against it. It defies time, space and matter. Every day reveals some new phase of its usefulness. Home, hospital, school, hall, store, office and factory are entered and entertained by it. It is too large a thing for the human mind even to conjecture at the ultimate development.

Meanwhile, however, the Radio-minded of the nation are celebrating a milestone in Radio's endeavors with mingled awe at its great strides of the past, and wonder as to what it will do in the future. The Radio receiving set is speedily establishing itself as a fixture of the American home, and is as permanent and necessary as telephone or baby carriage.

## Bringing Peoples Close Together

Air Communication Results in Removing Barriers

IT IS difficult to keep one's feet on the ground when contemplating the possibilities of Radiophone communication. They stagger the imagination. Radio is a utility of great value and like all discoveries and inventions it is causing a revolution in our civilization. Every day sees new opportunities for service along different lines of activity.

Experimenters are working night and day on improvements. The greatest development in broadcasting has been made through the use of the vacuum tube and future possibilities of immense improvement in this one feature are confidently expected.

There is one important factor, however, in this recent product of the inventive genius so active among our citizens that is fraught with tremendous significance. That is the effect that it will have on the age-long struggle of the human race for attaining a perfect system of society.

Radio now is and will become more so, one of the greatest influences along the lines mentioned, for it removes effectively those barriers of time, space and lack of communication, and brings the peoples of the world close together. It will act as a great impetus to the movement to establish an international, or worldwide, language, and play no small part in assisting the race to reach the goal destined for it by a beneficial Providence.

## Fundamental Definition Lacking

What Radio Means to Hundreds of Thousands

THE word Radio has as its fundamental definition the means whereby concerts, plays, operas, football scores and the like are brought into the individual home with the expenditure of little money and a comparatively small amount of labor. To a certain extent this is true, but there is now vastly more than that connected with the science itself, has been in the past and will be a hundred times more in the future.

Today Radio is the very heart string of the merchant marine of the world. It is the safeguard of the tourist and sailor when miles away from home on the trackless expanse of the world's oceans. True, lives have been lost regardless of Radio, yet how many more have been saved by the fleetness and magic of the Radio wave?

## Condensed

By DIELECTRIC

There are times when a piece of news would never be noticed by us stuck down in a corner somewhere on an inside page of the daily journal. After hearing the announcement from Station DOE of the theft of a large number of five dollar Federal Reserve notes, and their numbers, then we plainly saw the news item to that effect in the paper we had just carefully perused. The trouble in the circuit when such a thing happens to any of us probably lies in our optical bulbs; one of these is directional, the other fixed. One oscillates before the printed page, while the other never leaves the filament rheostat that gentle fingers are persuading to mount ever higher! It is no easy thing to read all the news and at the same time keep ambitious hands from ruining the set. However, speaking of bank notes, I never knew even one of their numbers personally.

Will England send its Radio Premier to this country to beseech our aid in co-operating with them in their effort to keep American made sets off the British market? Receiving sets manufactured in the United States are admittedly superior to theirs, but they must needs develop the industry to themselves. A British broadcasting company has been granted a charter which insures that concern at least two years' monopoly in this line.

From the American Radio Exposition held in the Grand Central Palace, New York city, many items of general interest were given the listeners in, one of these being a wedding ceremony with two couples participating. It is rather a strange experience to hear the parson proclaim, "I pronounce you man and wife," when neither of the contracting parties are visible to the majority of the invited guests. The most aggravating part of it all, perhaps, is to be unable to contribute the usual rice and old shoes to the newlyweds. Some means will be provided in time whereby we listeners may play a more active part in starting a Radio-married couple on their life journey. For instance, we might shock them.

At that same exposition, we heard a speech broadcast by vice-president Griswold, of the American Telegraph and Telephone Company, in which he called our attention to the problems of the future in Radio broadcasting. We were advised to consider the necessity of placing this great source of entertainment on a sound business basis, as considerable sums of money are required to maintain broadcasting stations and to give to the public what it desired to hear. Then, the following evening, we heard (those of us who were listening to WJZ) a rather different aspect of the subject. We were told that the expense of broadcasting was to be less the concern of the Radio audiences, than that well-organized stations should be supported by public approval made manifest to the ruling authorities. Whom are we to believe? Read column four, page one, of RADIO DIGEST, of December 23rd issue. Shall we put all our eggs in one basket?

Good news for the "silent period" fans! KSD announced two evenings a week when virtually no broadcasting would be done by stations in St. Louis, Mo. Others are learning to keep quiet, though it's a slow process.

Many of you may have heard the music from Station WMAF and not known the identity of the owner of that station. If other men of wealth would do as Col. Edward Green has here done, devote some of their means to the furtherance of the science of Radio, we could advance even more rapidly than is now the case. He has provided an equipment in his laboratory, which is second to none, of such experimental value that important discoveries may be looked for from this source. The appealing feature of it all is that any amateur may visit the place and, without expense, benefit by whatever he finds of new ideas. This is in marked contrast to the monopolistic spirit which seems to be pervading some quarters at the present time. Not that I would suggest hampering the purely business phase of Radiophony, rather, to extend the field of operation beyond the narrow confines of a single corporate interest. We will continue to need diversified application to this mammoth industry, if we wish to develop all of its latent possibilities.

Like reading a dime novel detective story just before retiring for the night, it is a bit disturbing to hear hold-up descriptions direct from police headquarters. That station in Detroit, Mich., with the well-chosen call letter—KOP—is responsible for my having spent a restless night on a recent occasion. In forboding tones I heard of two cases of highwaymen successfully accomplishing their nefarious purposes, and could easily visualize the whole exciting drama. Each character was carefully described as to dress, weight and the beautiful finish of his treasured automatic, and in both cases I was informed that these criminals were heading in my direction. With so vast an audience it is quite possible that the leading men were detained before they had gone very far. The incident serves to impress one anew with the utility of Radio broadcasting; not, however, with the need of spending money for blood curdling literature.

Music with your meals is possible without the cost of employing an orchestra. Simply tune that station which is transmitting an orchestra concert for your benefit at the dinner hour.

## RADIO INDI-GEST

### The Grid Choked Up with Tears and Leaked

Why did the tube howl? Because an electron passed round the plate, but found not a bite had been put on the grid.

### Hook the Two in Series

Dear Indi—The following was "lamped" in a so-called newspaper "Radio" department.

\$1 45

11-Plate  
Invariable  
Condenser

Please tell me how to hook-up said "invariable" condensers. The same paper also mentioned the use of "negative" B batteries. Do the dealers pay you the price when you purchase a "negative" B battery?  
—F. W. L.

### He Usta Be Out Till He Listened "In"

Long into the night she sat watching  
The fire that but feebly burned;  
The hour of midnight solemnly tolled,  
But yet he had not returned.

What could she do to keep him at home,  
Keep him away from that club?  
While love springs eternal hope will not die,  
Traps must be set for that "hub."

But now you'll find him always at home,  
And proudly to you he'll own,  
That he's never been out since the day  
She bought him a Radiophone.

—Popular Wireless (London.)

### Even Poems Have Meter

Pa: "I see Radio is sent according to meters."  
Ma: "First it was the gas meter, then the electric

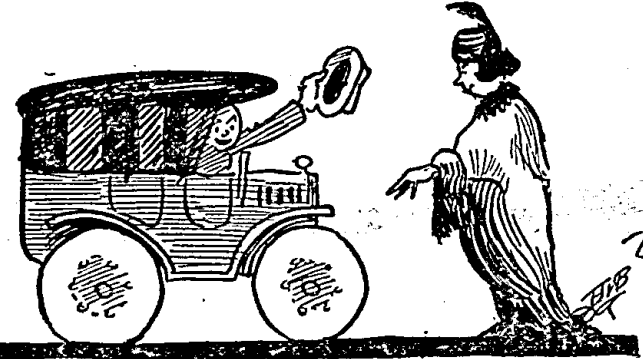

meter, then we get an automobile and Will uses it to meet her every night and now it's Radio wavemeters."

### Dancing at Radio Frequency

He wondered why "The Blue Danube Waltz" didn't sound just right. Then he found he had plugged in the two-step amplifier.

### We Like Radio but We Eat First

When a Radiophan tells his wife, who is holding supper for him, that he wants to listen in just one more minute—he is usually picking a minute half an hour away.

### Well, You Need a Ground

Notatube: "What's in the Radio concert program?"  
Whataset: "Concert in A Minor."  
Notatube: "Probably Massa's in the coaled, coaled ground."

### Three Cheers for Marconi!

Lawyer: "Now, if you will let me have some of his love letters."  
Ex-Sweetie (suing for breach of promise): "I haven't any. We both had Radio sets."

### She Listens in for Him

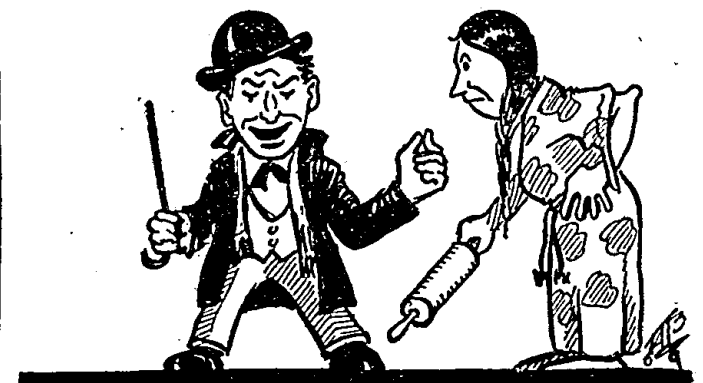

Ida: "I can't afford a Radio receiving set."  
Angela: "How foolish! What is your hubby's average income?"  
Ida: "Oh, usually midnight."

# A. B. C. Lessons for Radio Beginners

By Arthur G. Mohaupt

## Chapter II

**I**N CHAPTER one we learned about the nature of electricity and about the different kinds of electric currents that are used in modern Radio practice. We also took up the subjects of electrical pressure, current flow, and resistance, and learned that pressure is measured in volts, current flow in amperes, and resistance in ohms. The entire chapter ought to be carefully reviewed before a study of this second chapter is undertaken.

In this chapter we will discuss electric circuits and magnetism, two very important subjects with which everyone should

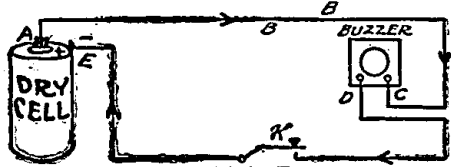

FIG. 5

be familiar who wishes to understand the why's and wherefore's of Radio operation.

### The Electric Circuit

In order that an electric current can flow, it is necessary to have a complete and uninterrupted conducting path or ring. This unbroken path over which an electric current flows is called an electric circuit. The complete circuit includes three essential parts: First, a source of current flow which may be either a battery or a dynamo; second, the apparatus in which the energy of the electric current is consumed, and third, the necessary connecting wires and switches.

In Figure 5 we have illustrated a simple electric circuit consisting of a dry cell as the source of the electric current, a buzzer in which the energy of the current is consumed, and the connecting wires containing the switch or key K. As long as the key is open, there is a break or gap in the circuit and hence no current can flow; but as soon as the key is closed, the circuit becomes continuous and the dry cell is then able to cause a current to flow and to operate the buzzer. Although this is only a simple electric circuit, still its operation is the same as that of a large power circuit in which a large water wheel driven generator is delivering several thousand horsepower by means of a high tension (voltage) transmission line to a distant city.

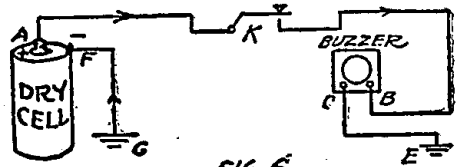

FIG. 6

Every electric cell, storage battery or dynamo, always has two terminals, one positive and one negative. The positive terminal is the one at which the current leaves the generator and flows to the energy consuming device, while the negative terminal is the one at which the current returns and again enters the generator. The wire conducting the current away from the generator is hence known as the positive side of the line, and the other wire over which the current returns is the negative side of the line.

Thus, in Figure 5, A is the positive terminal of the dry cell and the wire ABC is the positive side of the line, for through it the electric current flows from the cell to the buzzer. The wire DKE is then known as the negative side of the line, for through it the current returns to the cell.

Sometimes the earth or ground is used as the negative side of the line for conducting the return current. In Figure 6 we again have a simple buzzer circuit, in which the current leaves the cell at the positive terminal A and flows through the key K to the buzzer at B. The current then leaves the buzzer at C and enters the ground at E, it flows through the ground to G, and then returns to negative terminal of the cell at F. Note carefully how a ground connection is represented. For making a ground connection the wire can be connected to a

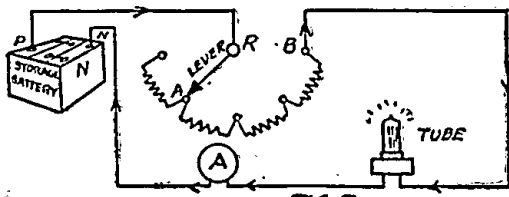

FIG. 7

water pipe by means of a special "ground clamp," or else it can be connected to an iron rod or pipe which is driven down into the earth to a depth of six or eight feet.

### Ohms Law

The amount of current (No. of amperes) flowing in a circuit depends upon the applied electrical pressure (volts) and the amount of resistance (ohms) offered by the circuit to the flow of current. The higher the pressure, the more current will be caused to flow; also with a high resistance the same pressure can cause less current to flow than if the resistance is small. There is an impor-

tant law which combines these three factors. This law is known as Ohm's Law, and states that the number of amperes of current flowing in a circuit is equal to the number of volts pressure divided by the number of ohms resistance. Thus, if a storage battery can exert a pressure of 6 volts, and the resistance of the filament of a vacuum tube is 3 ohms, the number of amperes of current flowing will be equal to 6 divided by 3 or 2 amperes.

Since at a given pressure the current flow (No. of amperes) depends upon the resistance of the circuit it is evident that we can control the strength of the current by regulating the amount of resistance. A device consisting of a variable resistance and used for regulating the current flow in a circuit is called a rheostat. It is always connected in series in a circuit so that it forms a part of the circuit and all the current must flow through it. A rheostat is illustrated at A in Figure 7. The current leaves the storage battery at the positive terminal P, and enters the rheostat at R. The rheostat consists of a number of coils of high resistance wire connected between a series of contact points over which the end of a rotating lever moves. In the position in which this lever is in Figure 7, the current must first flow through all of the resistance connected in between A and B before it can flow on through the filament of the tube. Thus by rotating the lever any amount of resistance can

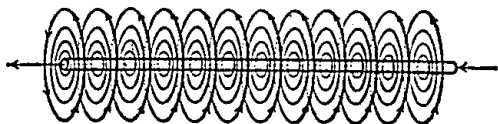

FIG. 8

be cut in or out of the circuit, and the current correspondingly decreased or increased. As the current strength increases, the filament of the tube burns brighter, while with a decreased current the filament glows less dim.

The amount of current flow (No. of amperes) in a circuit is measured with an instrument known as an ammeter. An ammeter, like a water meter, is always connected "in series" in a circuit so that the entire current to be measured must flow through it. As is illustrated in Figure 7, an ammeter is represented by a circle with the letter A in it. As the current flows through the instrument, the pointer indicates on a scale the number of amperes flowing. The two terminals of an ammeter are marked P (positive) and N (negative). When connecting the instrument into the circuit, the positive terminal must always be connected to the positive side of the line, and the negative terminal to the negative side of the line.

### Magnetism

Although magnetism is a very broad and interesting subject, we will be able to take up only a few of the important points which are necessary in order to understand the fundamental principles of Radio. We are all familiar with the small horseshoe magnet and have per-

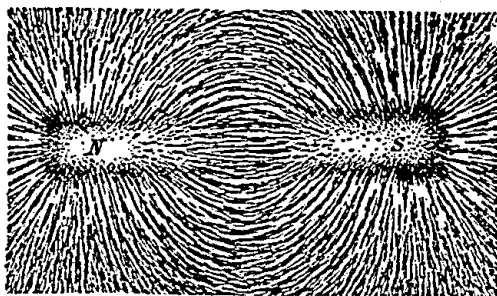

FIG. 9

formed many interesting experiments with it. A magnet will pick up only small pieces of iron and steel; but no other metals. Hence iron and steel are used so extensively in the construction of electrical apparatus and machinery, for they are the only metals which will carry magnetism or can be magnetized.

However, a magnet does not possess its power of attraction over the entire surface, but only at certain places near the ends of the magnet. These spots where the magnetism seems to be concentrated are called the poles of the magnet. A magnet always has two poles, one called the north pole and the other the south pole.

If we lay a piece of stiff paper over a magnet on a flat surface and then sprinkle iron filings on the paper, these filings will arrange themselves along definite lines as is illustrated in Figure 9. These lines are called magnetic lines of force or merely lines of force, because the magnetic force of the magnet seems to act along these lines. These lines appear to come out of one end of the magnet, the north pole, travel around through the surrounding space, and enter the magnet again at the other end or south pole. The entire collection of lines of force is commonly called a magnetic field, or magnetic flux.

Whenever an electric current flows

through a wire or any other conductor, that conductor is surrounded with a magnetic field in the form of circular lines of force, all of which have the conductor as a common center. They all become larger as the distance from the conductor increases. Such a circular magnetic field is illustrated in Figure 8. The direction in which the magnetic lines of force act around the conductor depends upon the direction in which the electric current flows. If the current is reversed, the lines of force act in the opposite direction around the conductor.

The strength of the circular magnetic field, that is, the number of magnetic lines of force, depends upon the strength of the electric current (No. of amperes)—the larger the current, the more lines of force encircle the conductor. We can never have an electric current without also having the magnetic field around it. Such magnetism is known as electro-magnetism.

If the strength of the electric current changes, the number of lines of force also change. If the current increases, the lines of force expand around the wire and increase in number; while if the current decreases, the lines of force shrink together and decrease in number. If the current flow stops altogether, all of the lines of force collapse and disappear within the wire.

Since a change in current strength causes a change in the magnetic field around the wire, an alternating or pulsating current which is constantly changing in strength, is surrounded with a variable or everchanging magnetic field. As the alternating current increases from zero to a maximum value in one direction, the lines of force expand outward around the conductor; and as the current again decreases to zero, the lines of force also shrink together and collapse within the conductor. As the current reverses and increases to a negative maximum, the lines of force again expand, but this time act in the opposite direction. With the current again decreasing to zero, the lines of force again collapse.

An alternating current is thus surrounded with a variable or pulsating magnetic field. Such a magnetic field, we will learn in the next chapter, plays an im-

portant part in the operation of all Radio transmitting and receiving apparatus. In fact, the entire art of Radio is based partly upon the possibility of establishing such variable magnetic fields.

### The Third Chapter

With this chapter we have practically completed our study of the electrical fundamentals of Radio, and are now ready for the third chapter in which will be taken up the subject of oscillating circuits. Oscillating circuits and the high frequency currents established in them form the real essence of all Radio operation. The third chapter is, therefore, a most important one; and no one who desires to learn all about Radio can afford to miss that chapter.

### Lightning Arrester

The construction of a lightning arrester shown in the illustration uses the brass ends of shot gun shells for making the

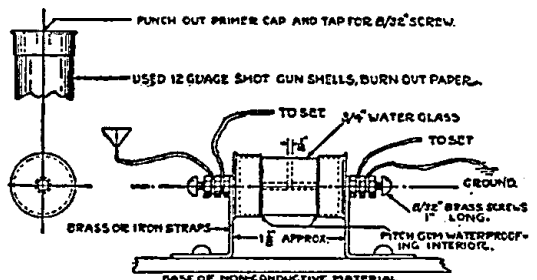

body. A short tube is used between the shell ends. The base is made of bakelite or porcelain.—George M. Swallow, Davenport, Iowa.

# ATWATER KENT

Immediate Delivery  
Dealers: Write for Discounts  
Hudson-Ross, 123 W. Madison, Chicago

## To Yearly Subscribers Only

Limited Number of

# BOUND VOLUME TWO

RADIO DIGEST

Volume Two

13 Numbers

July 15—October 7, 1922

Now Ready for Delivery. Parcel Post Prepaid, Only **\$2.00**

On account of the limited supply, the sale of these bound volumes No. 2 is limited strictly to those readers of the Radio Digest who have subscribed for a year.

## TO NEW SUBSCRIBERS

One year subscription to Radio Digest and both bound volumes 1 and 2 **\$7.00**

By subscribing now for one year to the Radio Digest you get both BOUND VOLUMES 1 AND 2, 26 numbers, with one year's subscription for \$7.00.

or either volume 1 or 2, FREE with a year's subscription to Radio Digest **\$5.00**

ALL ORDERS MUST BE SENT DIRECT—No orders on this offer will be accepted through subscription agencies, news dealers or other sources. Check, money or express orders (no stamps) must accompany all orders.

TEAR HERE—MAIL

## Supply Limited—Better Hurry

### COUPON

PUBLISHER, RADIO DIGEST ILLUSTRATED, 123 West Madison St., Chicago, Illinois.

I have already subscribed to the Radio Digest for one year, so please reserve me one bound volume Number Two for which I am enclosing check—M. O. for Two Dollars.

Please reserve me Bound Volume Number One and also Number Two and one year's subscription to the Radio Digest, Illustrated, for which I am enclosing check—M. O. for Seven Dollars.

Name .....

Address .....

City..... State.....

# Panel Shield Prevents Body Capacity

## Grounding Shafts Aids in Eliminating Capacity

Finding that I still had considerable trouble from body capacity in the operation of a Copp circuit receiving set, even after the panel had been carefully shielded,

### WORKSHOP KINKS? EARN A DOLLAR—

THERE are many little kinks worked out at home that would aid your fellow Radio worker if he only knew about them. There are new hook-ups, new ways of making parts and various unique ways of operating sets that are discovered every day. RADIO DIGEST is very much interested in securing such material. Send them in with full details, including stamped envelope so rejected copy may be returned. The work must be entirely original, not copied.

RADIO KINKS DEPARTMENT,  
RADIO DIGEST,  
123 West Madison St., Chicago, Ill.

I investigated for the trouble, found it and got rid of it in the following manner:

The body capacity appeared to come from the arrangement of shafts for the movable sections of both the aerial condenser and the variocoupler which carried it to the front of the panel and outside of the protection of the grounded shield. The trouble was overcome by changing the connections to both the condenser and the variocoupler. The sketch is self-explanatory.—E. H. Rankin, Lakewood, O.

### Plugging in the Aerial

Where the aerial lead-in enters the house I fastened an ordinary electric light socket with screws to the wall and connected the lead-in to one of the two screws in the socket. To the other screw is con-

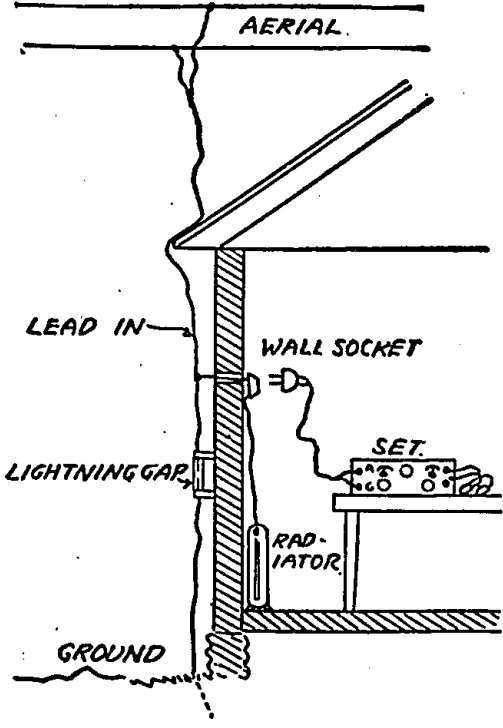

nected to the inside ground wire. A small piece of ordinary drop light cord is attached to the aerial and ground binding posts. The other end has a regular light plug attached. When ready for use I insert the plug.—William Graham, Chicago, Ill.

### Long Distance Receiver

The articles required for this set are one variometer, one 23 or 43-plate variable condenser, phones, batteries, detector tube, socket, rheostat and grid condenser.

The variometer is split, or, in other words, where one end of the stator is connected to the rotor metal plate, this lead

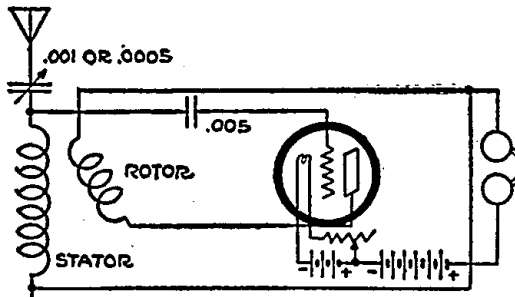

is taken off and the rotor is used as the plate inductance and the stator ends are connected, one side in the grid and the other side in the ground.

Using about 28 volts on the plate and with an aerial about 60 feet long, seven feet high at one end and 20 feet high at the other, the following stations have been heard on one tube: WHAS, FWX, WBR,

## COPP CIRCUIT RECEIVING SET

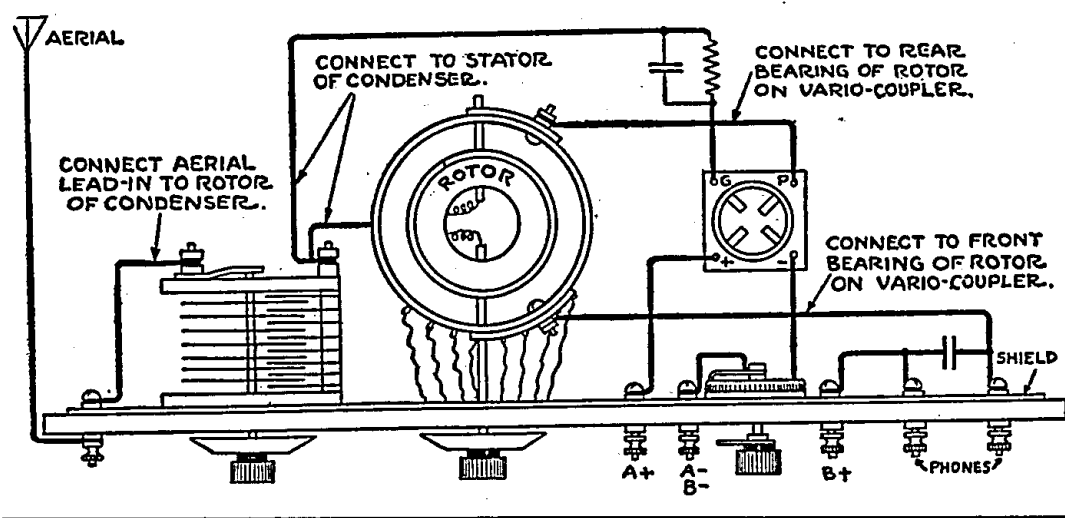

WDAP, WFAF, WOC, CKAC, WWG, KYW, WBAP and WFAA. If the amateur has difficulty in getting this set to operate, he should reverse the A battery, or if he has a rather large aerial he may get better results by using the tap where the two halves of the rotor are joined.—Samuel Wells, Atlantic City, N. Y.

### Mounting for Honeycomb Coils

Homemade coils are difficult to mount and are a nuisance if placed on the table in front of the cabinet. The coils may be

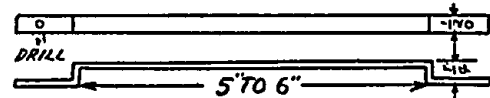

COILS MOUNTED ON PANEL.

held in an upright position with a strip of tin which is from 5 to 6 inches long and about 1/2 inch wide and bent as shown in the illustration. After shaping the strip, mount it in a convenient place on the cabinet panel. If two coils are used, four binding posts are necessary, two of which are mounted just below each coil, then enough wire is taken off the coil so that it will reach to the binding posts and still have enough wire to let the coil move back and forth on the tin bracket to cause regeneration.

The other binding posts are put on the panel in the same way, except that it is put a little over and under the other coil,

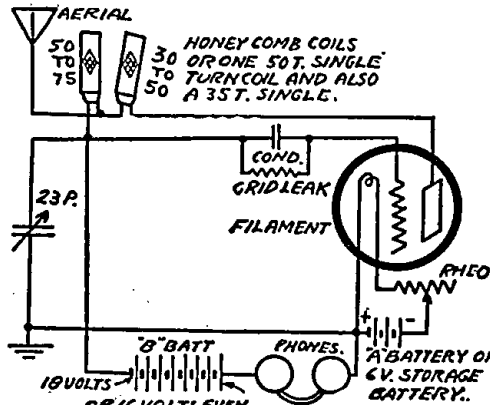

then by moving the coils closer together or farther apart it will cause regeneration, providing they are connected right. If three coils are used and one is to be stationary, the stationary coil wires may be drawn through the panel and pulled up firm to it so that it will rest easy against the panel and connect it. The other two coils are put on as shown in the illustration, except that one coil will be on each side of the stationary coil.

If regeneration is desired from a two coil hook-up the diagram gives one that received up to 200 miles distinctly. This hook-up I am using with great success.—Kenneth Voeck, Baraboo, Wis.

### Homemade Multiple Headset

Usually when a receiving set is working good there are more persons wanting to listen in than there are headsets. If there is one headset at hand a multiple hearing device can be made from a good, sound cigar box. Procure some rubber tubing, 3 or 4 feet for each person, and drill holes in the sides of the box for the tubing to fit in snugly. Tune in as loud as possible and detach the receivers from the headset and place them in the box. Each member of the party listens in through a rubber tube with its end placed in the ear.—Glenn E. Ganfin, Escanaba, Mich.

In buying or building a receiver, select a design capable of rendering selective tuning.

### Signal Light on Loud Speaker

A friend of mine arranged a handy attachment for my loud speaker, which, after my first carelessness in leaving my battery connection on, has saved me much trouble and expense in recharging the battery. He attached a small automobile lamp and socket on the base of the loud speaker by spreading the twisted wires sufficiently to slip them over the socket. The wires were held together on each side of the socket with tape. The ends of the wires were connected to the back of the loud speaker. When connections are made



with the loud speaker the small light is a constant reminder that the current is on, and I never forget now to disconnect the battery circuit when I am through using the instrument.—J. Howard Howe, Lewiston, Idaho.

## MYERS TUBES

Dealers: Write for Discounts  
Hudson-Ross, 123 W. Madison, Chicago

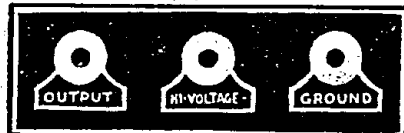

## SOMERVILLE TERMINAL TAGS 5c

READINGS  
ANTENNA HI-VOLTAGE +  
GROUND HI-VOLTAGE -  
OUTPUT LO-VOLTAGE +  
INPUT LO-VOLTAGE -  
TICKLER MODULATION

"Slip under any Binding Post—Like Washers"  
"The Original and Best" at Your Dealer or Direct

Somerville Radio Laboratory  
43 CORNHILL, BOSTON, MASS.

## SPIROLA REAL CABINET TYPE \$3.85 LOUD SPEAKERS

Not just a common horn built into a cabinet. Beautiful—Compact—THE TONE OF FINE CABINET PHONOGRAPHS. Make your two-step set a HOME ENTERTAINER. All SPIROLAS are of the best construction, with fine, rubbed finishes and are absolutely guaranteed.

SPIROLA DUPLEX—uses any headset. Satin black (DB) finish \$3.85. Oak (DO) or mahogany (DM) finish \$4.85.

SPIROLA SIMPLEX—uses Baldwin or other unit. Black (SB), oak (SO), mahogany (SM) finish, same prices as DUPLEX.

## Ten Variations in Grid Leak Increase Signals

Procure ten switch points, one switch knob, one grid condenser and one binding post. Fasten the switch on the panel. In the track of the switch place the switch points spaced equally about one-half inch apart, then between the first two points draw a light line with a soft lead pencil. Between the next two

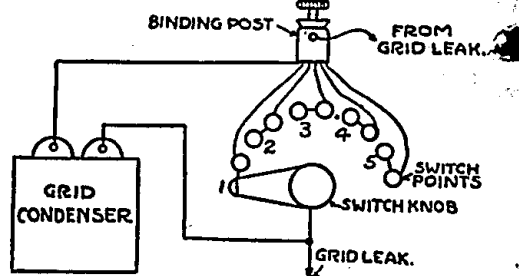

draw a heavier line and so on, drawing heavier lines until you have made five grid leaks, then make the hook-up as shown in the diagram.

Place the switch spring on the point No. 1. If the signals are heard, but not loud enough, turn to the next two, and so on until the signals are heard the best.—M. Hindert, Peoria, Ill.

### Mount for Spider Web Coils

The illustration shows a tray-like support for holding spider web coils. It is made of wood to the dimensions given,

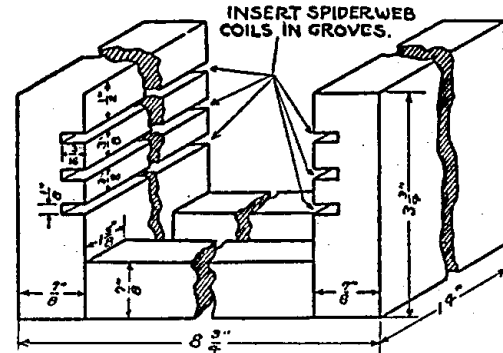

although any width may be used suitable to the diameter of the coils. The coils slide in the grooves. Binding posts may be placed on either side.—Irving A. Brown, Anthony, R. I.

## Phantom Tuner

\$19.75 will bring one of these marvelously sensitive instruments to your address, prepaid. No aerial, ground, loop or radio frequency used. All parts highest quality. Cutler Hammer, Remler, Dubelier, etc., mounted on genuine bakelite panel. Complete instructions furnished for wiring. No soldering necessary. Have music on strip of lamp cord one hour after set arrives. Our Phantom gets over distance and is practical using detector only. Wind lamp cord in auto top and tune in music while driving. We've done it often. Send stamp for booklet and learn the Phantom story. VESCO RADIO SHOP, Box D-704, Vacaville, Calif.

## INCREASE YOUR RANGE

BY ADDING A PERFECTLY CONSTRUCTED VARIABLE CONDENSER TO YOUR SET

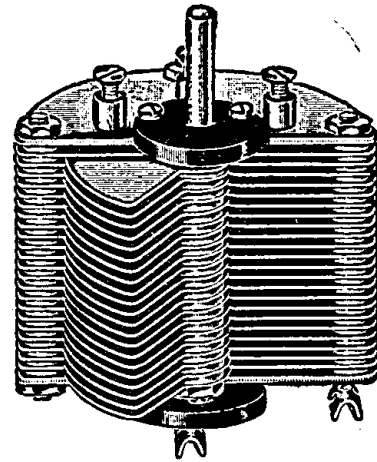

11 PLATE.....\$1.25  
23 PLATE.....1.40  
43 PLATE.....1.75

Mail Orders Filled Same Day  
Postage Extra No Personal Checks Accepted  
B. K. Ford & Co. 4343 West Fifth Avenue CHICAGO, ILL.

# RADIO DIGEST STANDARD CONVENTIONS

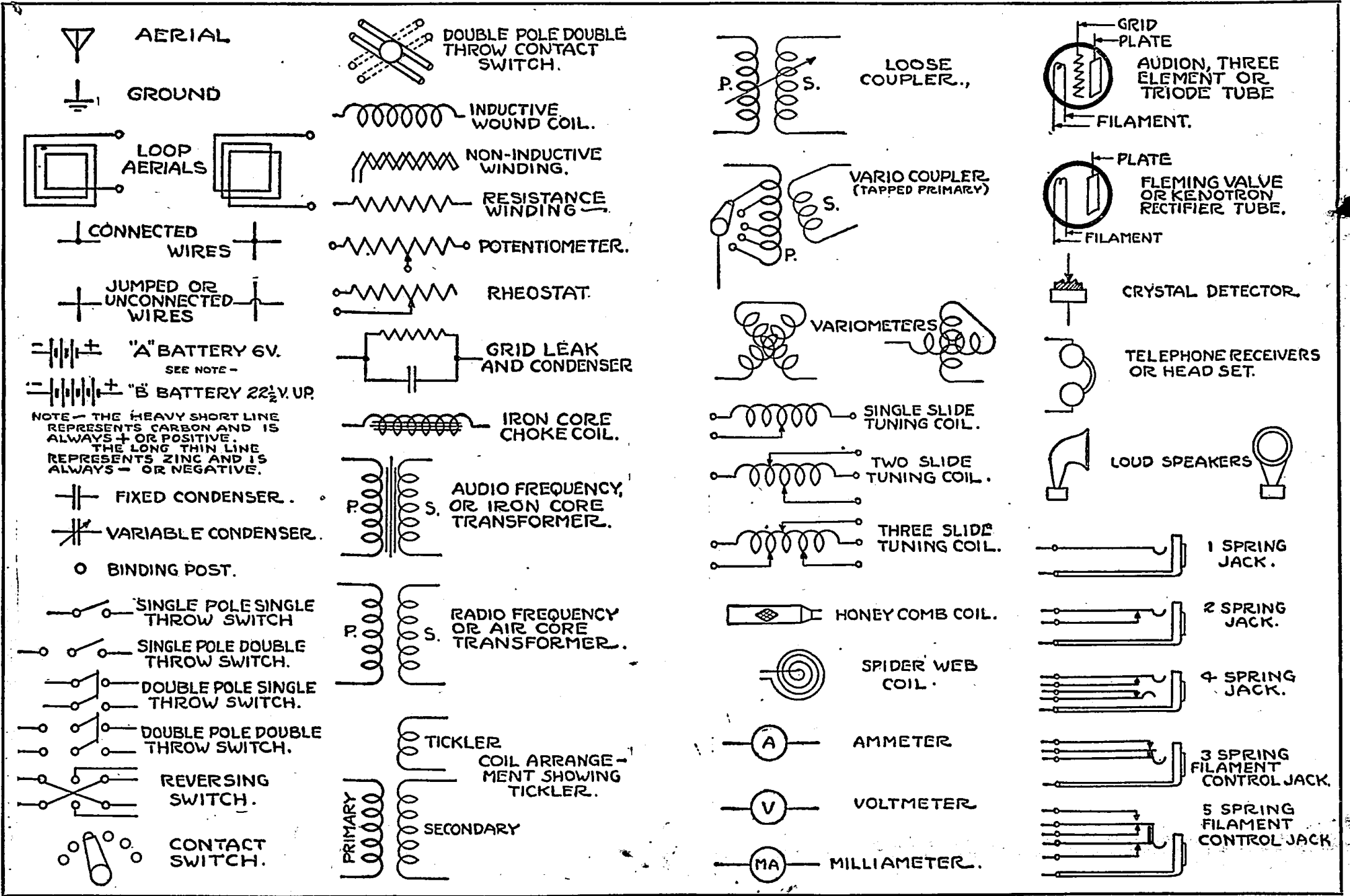

## The Reader's View

**A Plea for Grand Opera from the Metropolitan**

Let me add a word to the plea for broadcasting Grand Opera from the Metropolitan Opera Co. All who have had the privilege of listening in on the operas as given by the Chicago Civic Opera Co. will agree that Station KYW, with the co-operation of the opera company, is doing a great work in the line of educating the public in the best in music, and thereby is rendering a service to this age and the rising generation. We are sure that the Metropolitan Opera Co. can be no less humanitarian in its outlook on the musical world. But we know there are many, as we, who can not rely on getting Chicago, but in the South and East, here, can often without interference get New York. The two sets, which we use interchangeably, with a two-step audio amplifier, will not always tune out other stations satisfactorily enough to get good results with Chicago.

I know this is the case with others. We are all working to have better sets. Those who can afford to buy the more expensive sets are doing so, and getting distance, or the boys at home, as in my case, are building more improved sets. We want the best in Radio sets. Likewise, there is no question in my mind that there is a vast Radio audience that wants Grand Opera, and those who do not will learn to want it. The more the Radiophans learn about Radio, the better sets they want, so with the listeners in regard to programs heard.

Take the movies. Time was, not so long ago, when slap-stick comedy and a piano player would do. Now we want good plots, finished actors, and a symphony orchestra. We don't have to wait to grow up to the best in music. If the best is made available the growing generation will take hold of it, is my opinion. The talking machine and player piano have done wonders to make us, as a nation, more musically inclined, but it remains for Radio to guide and shape our tastes. The great majority, of necessity, choose the records from the 10-cent stores. But the Radio selections are, to use an old, old expression, "free as air," and if the producing companies will only co-operate with the managers of broadcasting stations, so they may send out the best productions, then the tube will not need to usher in the familiar "clack clickety, clack," and even the hum-

ble little crystal will "glow" with the reflected beauty of the tones it brings in.

To illustrate: In the last several weeks, here in Virginia, my son of fourteen years has learned to distinguish Grand Opera. We turned in, by chance, New York the night of the broadcasting of "Aida," which of course I recognized and thoroughly enjoyed. So last Friday, when my son caught the last act of "Il Trovatore" at Chicago, he breathlessly called, "I have Grand Opera for you." He also stopped his experimental tuning, lately, to listen to the fine Shakespearean reader who recently gave "As You Like It," because he had been making a book report on that very play at high school. Then Saturday night, a week ago, we heard the wonderful Symphony Orchestra from New York, and I find Radio is the way to study and teach the symphonic form. Then the harpist, whom we heard from Atlanta last Saturday, gave us clearly the tone qualities of the harp in all their beauty.

What makes the Italians such a musical people is, not only their ability to execute but the wonderful opportunity of the masses to hear the operas. Think of the impetus to the hearing of opera on the stage this listening in will give! Why do the young people love jazz? Because they know it. But let them constantly hear the best, and they will no more go back to it than the Radiophans will discard their amplifying devices or their improved hook-ups. I know, for I am one who from babyhood not only studied but constantly heard the better forms of music.

Who would stop the avenues, which Radio is opening up, for the onward progress of a better appreciation and a truer valuation of the best music? Let's have Grand Opera from the Metropolitan!—Harriet Reynolds Marchant, Petersburg, Va.

**Likes Flewelling Set**

It may interest you to know that I built a Flewelling super-regenerative circuit as given in RADIO DIGEST in the December 2 number and I have been getting some remarkable results. I am using the set without any real antenna. For receiving purposes I attach a wire to the heating system of the house or simply drop fifteen or twenty feet of ordinary annunciator wire out of the window and not touching the ground. In either of these methods of receiving I have been able to receive up to a distance of one thousand miles. It remains to be seen what I can do with a real antenna.

Now comes the strangest thing of all. With this set and without any receiving wire of any kind I can pick up stations as far away as Pittsburgh and bring the voices and music loud and clear. I can pick up Pittsburgh in this manner almost at will. I have demonstrated this fact to several people who have been skeptical and I have done it with the set inside of a brick building in the heart of Asheville, N. C., among all of the trolley and lighting wires. If you can devote the space in your paper I wish you would give the theory of the reception in this instance. The set itself is picking up the signals and regenerating them of course, but just what part of it is probably doing it?

A good many of the Radiophans here are interested in this and so far as I know I am the only person in this part of the state who has been experimenting with the Flewelling circuit, although several have tried out the Armstrong circuit. Here I wish to congratulate you upon the good paper which you put out and in my humble estimation it is the very best published for those wishing to keep up with the latest in Radio and to experiment with circuits. Your diagrams are the most explicit for the novice that can be found anywhere. This is my first attempt at building or using a receiving set and I am very proud of the fact that by using your diagram and directions I was able to put this set up and it worked from the very beginning.

In final explanation I wish to state that my set is mounted on a beaver board panel with dimensions of about 10 by 14 inches. The connecting wires are rather longer than ordinarily used and this may have something to do with such long-distance reception without receiving connections. Please note that Pittsburgh is about 275 miles from here. Thanking you and assuring you that I enjoy your paper each week, I beg to remain.—Dr. F. C. Locke, Oteen, N. C.

**Condensers Vary**

Mechanical motion of the dial of the condenser of a receiving set is not necessarily an indication of the sharpness of tuning. Moving a dial on one set a single degree may lose a particular signal, while it may take ten degrees of another set to tune out the same signal. However, ten degrees on the second condenser may correspond to the same change in capacity which is made in one degree on the first condenser, if there are fewer plates or if the latter are more widely separated.

## HOW TO MAKE FLEWELLING RECEIVER

COMPLETE  
**Blue Prints**  
 for the construction of a Flewelling Receiving Unit and two step amplifier.

**Full Instructions**  
 FOR ASSEMBLY  
 Description of apparatus and accessories and details of tuning.

**Cabinet Dimensions**  
**Panel Layout**  
**List of Parts**

**Only 50c**

Send only money orders—no checks or stamps. Coins at your own risk.

Book Department  
**RADIO DIGEST**  
 123 W. Madison Street  
 CHICAGO, ILL.

# Questions and Answers

### Wants to Add Amplification

(1248) CG, Baylis, Ill.  
I have a set containing a 43-plate variable condenser, variocoupler, grid leak and grid condenser, rheostat, detector tube, socket, 22½-volt battery, 6-volt storage battery, and a pair of 2,000 ohm phones. What other parts would it take to add one stage of amplification?

Does it take a 45-volt B battery or a 22½-volt B battery for an amplifier? Can you use one A battery for two tubes?

Is there any way by which you can use a transformer on a 110-volt electric light so as to take the place of a storage battery?

A.—Your detector set is complete as now is. For one step of amplification add socket, rheostat, 45-volt B battery, amplifying tube and amplifying transformer.

Best results will be secured with either a 45-volt B battery or two 22½-volt batteries. The A battery may be used for two or more tubes.

We do not believe that 110-volt transformer designed by the Bureau of Standards for elimination of the A battery is on the market as yet. Any six-volt output transformer will serve, although we do not recommend it as a practical venture.

Page fourteen of September 2nd issue will afford you diagram of one stage amplifier.

### Variocoupler Suggested

(1193) PMC, Ft. Stockton, Texas.  
I have been reading your paper from the start and have gotten lots of information from your question and answer page. I am going to ask that you answer some questions for me.

I have a detector and two-stage audio frequency amplifier which I assembled. I am sending you the hook-up I use. My aerial is a three-wire inverted L, seventy-five feet long with a twenty-five foot lead-in and twenty-five foot ground lead. One end of my aerial is seventy feet high; the other, twenty. I have brought in Stations WHB, WDAF, KFAF, KUY, and a number nearer, but I have considerable trouble in tuning them in. I am using a homemade loose coupler with tapped primary and secondary for tuning.

Would a variocoupler work better with this set? Am I receiving as far as I should with this set under favorable conditions? Should a potentiometer across the A battery weaken the signal? If not, why is it that I find this the case with mine? Why is it that I can sometimes hear the whistle of a station clear but can't tune the voice in? If I should add one stage of Radio amplification to my set, would it increase the signal strength?

I would appreciate any change in the hook-up you might offer to improve the tuning.

A.—We are gratified to answer your inquiries briefly as follows:

We suggest the use of a variocoupler with variometer for tuning and one in plate circuit for regeneration. Radio frequency amplification will increase your range slightly and also the signal strength. For this addition of Radio frequency to your circuit, see page fifteen of August 19th and page fourteen of September 16th issues of RADIO DIGEST.

Your receiving records are good. However, your potentiometer should not function as you describe. Increase the detector plate voltage slightly. This will doubtless remedy the unfavorable condition.

### Don't Put in Acid!

(1253) AM, Spiro, Okla.  
How often would I have to put acid in a storage battery? I am using a charger to charge it.

Could the battery be used while it was being charged?

A.—Never put acid in a battery unless you have the experience and skill of a practical battery man and then not more often than at six month intervals. This is very important to the protection of your battery and should be carefully observed.

Using the battery while being charged is not advisable on account of the hum that occurs while charging.

### Condenser Construction

(1247) EJJ, Vincennes, Ind.

For my benefit and others, please say if it is a good custom to have condensers consolidated. I have in mind making lead foil and manila or waxed paper condensers to nearly their minimum capacity and then cut in parallel with each set of plates, a 5, 11, or 13-plate rotary condenser with them, the idea being to lay all the foil sheets in one shallow container leading out the necessary taps for 4 auxiliary condensers, and sealing up the lead sheet container permanently. Will one interfere with the others in such close proximity?

A.—There will be no interference between condensers in close proximity in the method you describe. Consolidation of condensers in this manner is practical and convenient.

### Circuit for Out-of-Town Stations

(1548) EJJ, Chicago, Ill.  
I am having difficulty in getting my set hooked up so as to get out-of-town sta-

### Has Silent Week!

(1233) CTR, Newport, Pa.  
For one whole week we failed to get anything on our outfit. There are eight

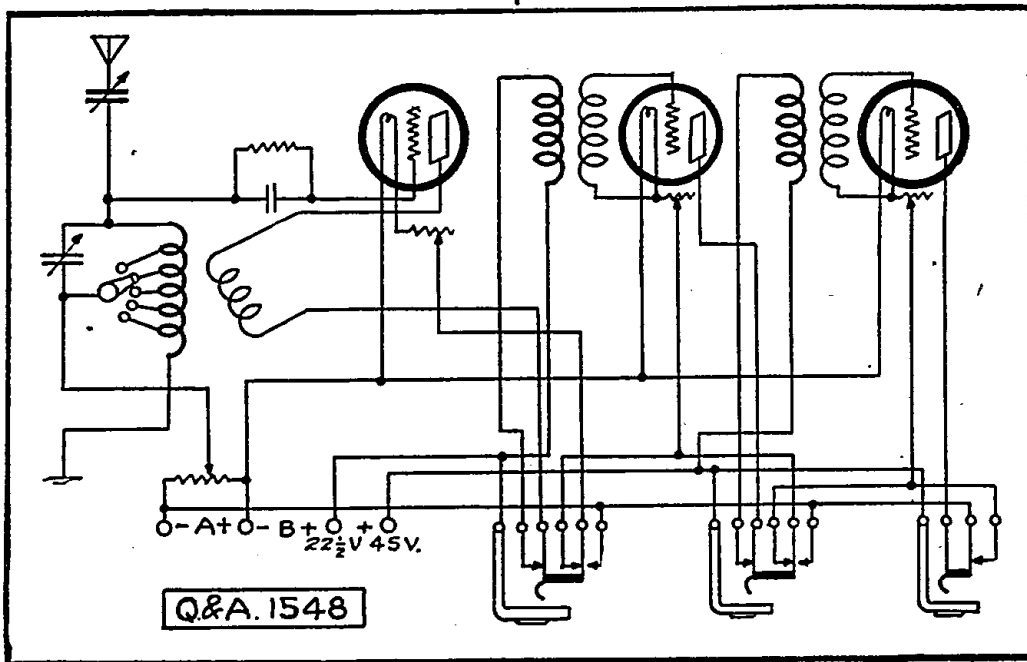

tions, and would appreciate your sending me sketch connecting the apparatus of my set as you think it ought to be connected. I have one variocoupler, one 43-plate variable condenser, one 23-plate variable condenser, one detector tube, two amplifier tubes, rheostats for each tube, two audio transformers, one potentiometer, three jacks and one plug for phones.

Please lay particular stress on connecting the potentiometer so as to bring the best results.

A.—Q. & A. 1548 diagram shows one type of circuit that you can employ with your apparatus, and which should bring in out-of-town stations.

### Windings; Leak Resistance

(1246) MV, Portland, Ore.

1. The primary and secondary of my variocoupler and grid variometer are wired with No. 24 wire and plate variometer with No. 21 wire. Should I have used No. 21 wire throughout or a larger sized wire and if so would results justify my rewiring the set?

2. When a grid leak has too heavy a pencil mark or too light a pencil mark what effect has it on the working of a set, and how can I tell when it has just the right resistance?

A.—1. Wire used in construction of your apparatus is all right and there would be no advantage in making suggested rewiring.

2. The best way to determine resistance of grid leak and proper adjustment to that end is to make a heavy pencil mark and keep erasing until you sense the verge of howling. When too little resistance obtains, a howl or whistle is noticeable; when too much, a decrease in signal strength results.

### Loop Aerial in Series

(1258) ANF, Paterson, N. J.

I am employing hook-up which you published in your issue of Saturday, August 12th, 1923, page 15, of 1 stage Radio and 2 stage audio frequency with a 43-foot outdoor aerial. I am getting good results but would like to get better if possible by increasing my wave length inductance with a loop aerial.

Will you please show me how to employ a loop aerial with this hook-up and size of variable condensers to use in their respective places?

A.—Place loop aerial in series with set and antenna with a forty-three plate variable condenser across it. However, we do not believe that this will materially assist you and would rather advise to increase the length of your outdoor antenna to one hundred and fifty feet.

Page fourteen of September 16th issue of RADIO DIGEST affords a rather comprehensive article on loop aerials, which will be helpful in employing them.

### Allen's Circuit Layout

(1238) FXB, Weehawken, N. J.

I am particularly interested in the circuit submitted by A. J. Allen, page 4, Vol. 2, No. 11. Will be very thankful to know how he constructed the set, or the position of various inductances.

A.—The only communication we had from Mr. Allen, (3807 Graceland Ave., Indianapolis, Ind.) was that given in the article you read.

I don't think the arrangement would be very important, except first, that your grid leads (lead to grid variometer—to leak and condenser—to grid) should be as short as possible, and second, that the three variometers and their leads should be separated enough so as to avoid back coupling through induction. If the latter is impossible, shield the variometers with ungrounded but commonly connected shields,

conclusion as to the nature of the phenomena you are experiencing. Off hand, the solution might be in suspended broadcasting of stations you are accustomed to receive. RADIO DIGEST affords a weekly bulletin of broadcasting stations and the hours of operation by which you might be able to determine if this might explain your period of silence. However, the cause may lie in the geological terrain.

### Trees Near Aerial

(1226) JH, Sylvan Beach, N. Y.

1. My aerial is 150 feet long, with lead-in, and 35 feet high and entirely surrounded by trees, some only a few inches from the wire. Have heard stations 800 miles distant with this arrangement. Would raising the aerial above the trees increase the range of the set?

2. What would be the advantage of shunting a variable condenser across the primary of the first step amplifying transformer? What capacity should it be?

A.—1. It is granted that the higher the aerial, the better. Your present results are certainly satisfactory and would not suggest the necessity of any change. Proximity of trees is not objectionable provided they do not touch antenna at any point.

2. There would be no advantage derived from shunting a variable condenser across the primary as suggested. If your circuit is regenerative, use a .001 mfd. fixed condenser here.

## Wessco

W. E. SUPPLY AND SERVICE CORPORATION

18 MURRAY STREET, New York

2 Blocks South of Chambers, between Broadway and Church St.

We Are Giving Away These Beautiful Crystal Sets HAVE YOU RECEIVED YOURS?

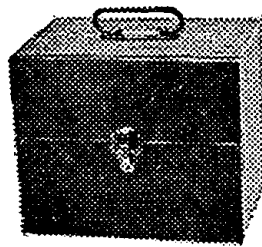

FREE

FREE

This set will receive everything broadcasted within a 25-mile radius of your home. Highly polished mahogany case with nickel-plated fittings.

Buy \$20.00 worth of Radio supplies and receive this beautiful Crystal Set absolutely FREE.

With each purchase of \$10.00 or more we are giving free of charge a \$1.75 B Battery.

Do You Need Radio Supplies? Our Prices Speak Louder Than Words.

All Merchandise offered is Standard, Guaranteed, and is of perfect workmanship. Mail orders must include postage. TERMS—Money Orders with Orders—Checks not accepted.

Better Than The Best  
PRICE Complete AERIAL-A INCLUDING PHONES, TUBES, AERIAL and BATTERIES  
\$35 The Radio Tube Set That Made Good in a Night

\$25.00 MIRCLE CRYSTAL RECEIVING SET WITH 3000 OHM PHONES, 100 FT. AERIAL, 2 CLEATS AND POR. TUBES, \$7.95

\$1.00 Genuine Bakelite Socket.....	.40	\$6.50 Moulded Variometer, highest quality..	3.50
\$1.00 Genuine Bakelite Dials, 3-in., 4-in.	.55	Special Radio Soldering Iron.....	4.95
\$7.00 Guaranteed Genuine Bakelite Variocoupler, silk wound.....	4.75	20c Bezel BRANDES PHONES.....	.15
\$6.00 Wessco Variometer, highest quality guaranteed.....	3.25	\$1.00 BRANDES PHONES.....	5.75
\$5.00 Acme Transformer.....	3.40	\$1.00 FRESHMAN VAR. GRID LEAK.....	.75
\$24.00 A BATTERY, 100 AMP., 6 V.....	16.75	100 ft. Coll No. 14 7-strand Pure Copper Aerial Wire.....	.50
\$19.00 A BATTERY, 80 AMP., 6 V.....	11.45	HOMECHARGER DE LUXE.....	13.25
\$14.50 A BATTERY, 60 AMP., 6 V.....	8.75	Thordarson Grid Condenser.....	.15
\$1.00 Rheostat.....	.32	\$1.50 Thordarson Vernier Rheostat.....	1.10
\$5.00 23-pl. Variable Condenser.....	1.65	Johns-Manville BIK. Com. Tubes, 3-inch.....	.25
\$5.50 43-pl. Variable Condenser.....	1.95	75c Crystal Detector.....	.35
\$4.50 Variometer, guaranteed high quality.....	2.40	\$1.50 Multi Jack.....	1.15
\$4.25 Variocoupler, guaranteed high quality.....	2.25	\$1.50 Twin Adapter.....	1.15
Contact Points, dozen.....	.04	\$1.25 Universal Plug.....	.75
Bronze Bus Bar, tinned, ft.....	.02	\$18.00 WESTINGHOUSE BATTERY CHARGERS.....	13.25
\$1.00 Socket.....	.35	\$19.50 WESTINGHOUSE BATTERY CHARGERS for A & B Batteries.....	16.00
\$3.00 BATTERY, 22½ V. VARIABLE, HIGHEST QUALITY GUARANTEED, LARGE SIZE.....	1.45	\$5.00 Murdock Phones.....	3.55
\$1.75 B BATTERY, 22½ V. VARIABLE, HIGHEST QUALITY GUAR., SMALL SIZE.....	.75	70c Open Circuit Jack.....	.40
3-plate Venter Variable Condenser.....	.70	85c Double Circuit.....	.45
Guaranteed Genuine Bakelite Panels—7x10, 5x9, 95c; 6x12, \$1.25; 7x12, \$1.50; 7x9, \$1.15; 12x14, \$3; 7x24.....	3.00	40c K. D. Crystal Detector.....	.16
50c Mica Condensers.....	.25	Magnet Wire 20 per cent. discount off List.....	1.65
\$1.00 All Moulded V. T. Sockets.....	.25	\$3.00 Radio Frequency Transformers.....	2.59
\$1.50 MICROSTATS.....	.85	75c Battery Hydrometer.....	6.00
SPAGHETTI per length.....	.07½	Knife Switch, S. P. S. T.....	.14
\$8.00 Moulded Variocoupler, highest quality.....	4.50	Knife Switch, S. P. D. T.....	.22
		Knife Switch, D. P. D. T.....	.35
		\$6.50 Wessco Audio Transformers, highest quality guaranteed.....	3.25
		\$6.75 Westinghouse Storage Battery.....	4.75
		\$5.00 Shamrock Variocoupler.....	2.59
		\$8.00 Dreyfuss Phones.....	6.00
		\$7.50 Wooden Horn.....	6.00

MAGNAVOX, NEW TYPE, NEW CONSTRUCTION. NEW FINISH ..... \$45.00

# Radio Illustrated



Married by Radio. Several marriages took place at the Grand Central Palace during the show. This couple is rehearsing for the occasion, using the Radiophone to receive the marriage ceremony. In this case both the bride and bridegroom are at the altar and the minister at home delivering the marriage rites by ether waves. © U. & U.

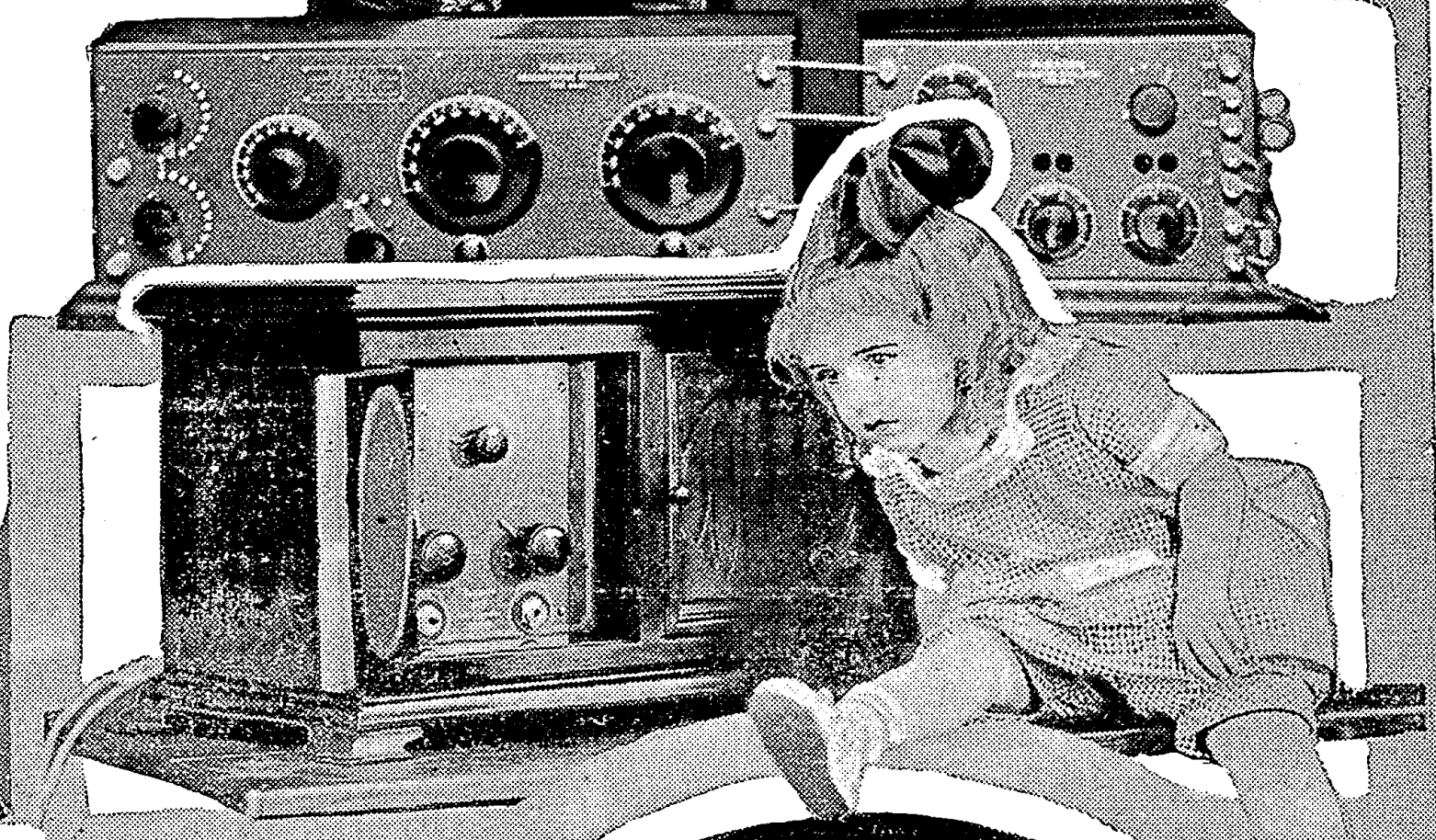

Ivan Steschenko, now basso with the Chicago Opera Company, is here leading us in song. In this case he is Music Master Basilio in the comic opera, "The Barber of Seville." Steschenko has been heard over KYW several times. Moffett Photo

A new type Radiophone recently brought out by a large manufacturer of these goods is shown in this picture. It is a fine cabinet construction. The daughter of one of the officials is listening in on the new instrument. © Wide World



The latest contribution to science is the code sending and receiving typewriter, which is equipped to either operate by wire or Radio. The inventor of the instrument, Edward Hebern, is shown using the machine, which has already awakened the interest of government officials. The machine, with the code wheel inserted, translates the coded message from any similar machine immediately on its receipt. An electric current is applied in certain combinations, which causes the machine at the receiving end to reproduce the words in a readable way. © Wide World

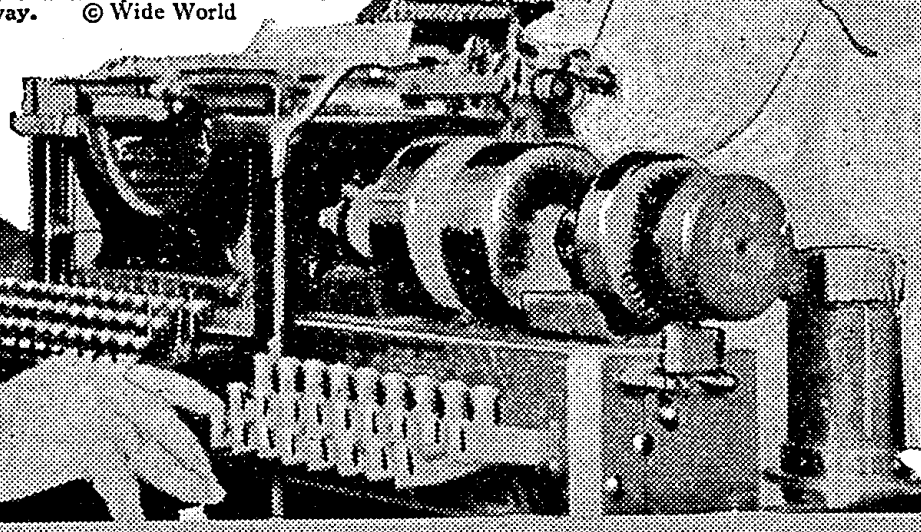

Presented with the smallest tube Radio set by his associates at the federal board for vocational training of war veterans in Washington, R. Edwin Joyce is shown listening in to a concert that was broadcast from St. Louis. Joyce is in the hospital at Washington, where he had a leg amputated recently. The miniature tube set is the invention of Barney J. Goy, who is in charge of the electrical training courses at the Washington bureau for war veterans. © Int.