

Portable Set, Reinartz Hook-Ups; Tube Curves

Radio Digest

EVERY WEEK **Illustrated** TEN CENTS

REG. U. S. PAT. OFF.

Vol. V Copyright, 1923 R. D. P. Co. Inc. SATURDAY, JUNE 9, 1923 No. 9

RADIO PILOTS AIRPLANE

KSD OFFERS OPEN-AIR LIGHT OPERAS

TWICE-WEEKLY CONCERT FROM ST. LOUIS

Talented Principals, Musicians and Huge Chorus Present Masterpieces of Great Composers

ST. LOUIS, MO.—Twice-weekly broadcasts of light opera, to be continued through most of the summer season, are being sent out by Station KSD from the huge municipal open air theater at Forest Park, this city.

These operas, which are the work of the most talented composers, are being presented on a scale never before attempted. The principals are highly capable and critics have agreed the immense chorus of one hundred voices is exceptionally well trained. An orchestra of eighty musicians, some of them members of the famed St. Louis symphony orchestra, furnishes the accompaniment. The open air theater has a seating capacity of 10,000.

Monday and Friday night of each week has been chosen for the broadcasts. In the event of unfavorable conditions, however, the selections will be broadcast on Thursday or Sunday evening.

Beginning June 11 the program that has been scheduled will be as follows:

(Continued on page 2)

CYCLONE WIPES OUT HOMES; CALL FOR AID

FORT WORTH, TEX.—For the first time in Texas Radio has been used to appeal for aid for disaster victims. On a stormy night recently a cyclone struck Colorado, Texas. Word was sent to WBAP, Fort Worth, that \$50,000 was needed to relieve suffering. WBAP relayed the message to the nation and within a day contributions to care for the victims of the storm were pouring in.

WLW, Class B Now, Bans Canned Tunes

Re-rating of Cincinnati Plant Brings Many Changes

CINCINNATI, O.—WLW is now a Class B broadcasting station. Many changes in the studio and operating room, combined with the installation of a 500-watt transmitter, have resulted in WLW being given the new rating. Of the approximately 600 Radio broadcasting sets in operation, less than two score are included in the B class.

At the recent Radio conference in Washington a 309 meter wave was allocated to WLW, and the change from 360 meters was made several weeks ago by engineers in charge of the Crosley Manufacturing Company station.

Placing of Station WLW in Class B necessitated radical changes in the day concerts. No more "canned" music will be broadcast.



FRENCHMAN'S INVENTION IS BIG WAR AID

Manless Plane Successful

French Air Under Secretary Gives Official Okeh—War Use Visualized

(By Pierre Douchenne, Special Correspondent)

PARIS, FRANCE.—Radio has mastered the air, flying a pilotless plane from take-off to landing! A recent experiment conducted at Villesauvage Aerodrome, near here, proved a complete success. Among the spectators was M. Laurent Eynac, Under Secretary of the Air.

What movements of the airplane were not Radio-controlled, were automatically self-adjusted by gyroscopes and other mechanical stabilizers. It is reported that the Radio-control devices resemble in principle those used aboard the Battleship Iowa, recently sunk in the U. S. Navy maneuvers off Panama Bay.

(Continued on page 5)



Miss Katherine Gorin (left), talented young pianist composer, heard May 6 on WDAP and May 2 on KYW, Chicago. She was also scheduled to microphone June 7 at WMAQ. She plays many of her own compositions, accompanied by Miss Theodora Bleidung, violinist. Right above (guess?) is Bebe Daniels, recently interviewed at the WOR, Newark, N. J., microphone by David A. Balch, Movie Weekly editor



Miss Verna Rabay (right), coloratura soprano, who recently sang some of Frank La Forge's songs, accompanied by the composer, over WEA, New York

SECOND COUPON IN BIG REWARD OFFER

TO GIVE PARTS FOR COUPONS AND REMITTANCE

Special Offer to Benefit Regular Readers - Many More Standard Parts This Issue

SPECIAL REWARD OFFER Coupon Number 2. This Special Reward Coupon appears each issue in Radio Digest until further notice. When sent in, accompanied by necessary remittance...

As was announced last issue, we inaugurated a Special Reward Offer for the benefit of you regular readers of the paper who have shown such splendid support and interest in the growth of the Digest.

With this the second week of the special offer many new items have been added to the list.

Rules to Remember. One point must be emphasized to those contemplating taking advantage of the special offer; that is, that the coupons turned in for any item must be numbered consecutively...

Class A Articles. For two consecutively numbered coupons and thirty cents (\$0.30) any one of the following articles will be sent: 1 Carter Imp Jack and Plug; 1 Carter 15-Ohm Resistance Unit...

Class B Articles. For four consecutively numbered coupons and sixty cents (\$0.60) any one of the following articles will be sent: 1 Carter .04 mfd. Special Fixed Condenser; 1 Carter Jack Switch; 1 Carter Hold-Tite Jack...

Class C Articles. For six consecutively numbered coupons and ninety cents (\$0.90) any one of the following articles will be sent: 1 Carter 6-Ohm Vernier Control Rheostat; 1 Carter 'Tu-Way' Plug; 1 Federal Panel Mount Socket...

Class D Articles. For eight consecutive coupons and one dollar and twenty cents (\$1.20) any one of the following articles will be sent: 1 Carter 20-Ohm Vernier Control Rheostat; 1 Schindler Radio Frequency Transformer...

AN EVENING AT HOME WITH THE LISTENER IN (SEE NOTE BELOW FOR INSTRUCTIONS)

Table with columns: Station and City, Met., Monday, Tuesday, Wednesday, Thursday, Friday, Saturday, Sunday. Lists radio stations like CFCA, CFCN, CKAC, etc. and their broadcast times.

Instructions for Use.—All the hours above are given in Central Standard Time. If your city uses Eastern Time, add one hour to each of the periods stated; if your city uses Mountain Time, subtract one hour; if your city uses Pacific Time, subtract two hours.

CONTENTS

Radio Digest, Illustrated, Volume V, Number 9, published Chicago, Illinois, June 9, 1923. Published weekly by Radio Digest Publishing Company, 123 West Madison Street, Chicago, Illinois.

Looking Ahead

- Marx Tells What's Wrong and Right about Tubes next issue, concluding his series. "Don't blame the set for all its ills, but blame whoever sells you untested tubes," says he.
- First Steps for Radio Beginners, by Thomas W. Benson, will tell you next week how to tune a tuner properly.

Newsstands Don't Always Have One Left WHEN YOU WANT YOU WANT IT! BE SURE OF YOUR WEEKLY COPY BY SUBSCRIBING NOW

TRANSMIT WAVES IN "FLASHLIGHT" BEAM

REPORT IMPORTANT WAY TO CUT INTERFERENCE

Forty Vertical Wires in Parabola Frame Serve as "Mirror" Reflector

WASHINGTON.—F. W. Dunmore and F. H. Engel, Radio experts of the Bureau of Standards, state that for point-to-point Radio communication there are two important ways of reducing interference...

Experiments have recently been conducted at the Bureau of Standards on transmitting apparatus, employing electron tubes, which transmits a directed beam of Radio waves, and employs waves as short as ten meters.

Use Wire Reflector. In the experiments, a reflector used consisting of short parallel vertical wires arranged on a frame shaped like a parabola. This reflector acts much as an ordinary mirror for light waves.

Dreams of Radio Joy for Convicts

Would Be "Missing Link" Between Prisoners and Outside World, Welfare Worker Believes

NEW YORK.—Radio bids fair to become the latest and most important step in prison reform if the dream of Mrs. Maud Ballington Booth, famous leader of the Volunteers of America, is realized.

Changing Attitude. Society's changing attitude toward those convicted of offending it, is beginning to concede that prisons should be more corrective than penal institutions, Mrs. Booth believes.

WMAQ Receives Aid of WJAZ During Removal to La Salle

CHICAGO.—WMAQ, Daily News — Fair Store plant here is now using the equipment of WJAZ, Zenith-Edgewater Beach Hotel station, by courtesy of the latter.

KSD LIGHT OPERA ON

(Continued from page 1) June 11, "The Fencing Master", by De Koven; June 18, "The Prince of Pilsen", Luders; June 25, "The Bat", Strauss; July 2, "Sweethearts", Herbert; July 9, "The Gypsy Baron", Strauss; July 16, "The Merry Widow", Lehar; July 23, "Gypsy Love", Lehar, and July 30, "Springmaid", Reinhardt.

SEND IN THE BLANK TODAY. Publisher Radio Digest, 123 West Madison St., Chicago, Illinois. Please find enclosed check M. O. for Five Dollars (Six, Foreign) for One Year's Subscription to Radio Digest, Illustrated.

EDEN MAPMAKERS TAKE SETS ON TRIP

ARLINGTON TO TICK OFF CORRECT TIME

Third Expedition to Land of Adam and Eve Recognizes Value of Airwaves as Guide

PEKING, CHINA.—Arlington, Station NAA, will tick off the time for the mapmakers in the Garden of Eden or in what many scientists believe is the original scene of the apple episode.

The third Asiatic expedition is today on its way over the Gobi desert, bound for western Mongolia, where rare fossil finds have already been encouraging enough to lead the scientists to make a determined search for the birthplace of man.

Part of the expedition will go into the southern part of the Gobi about eight or nine hundred miles west and a little north of Peking, to search for fossilized fig leaves or any other thing that will increase knowledge of early animal and possibly human life.

Carry Complete Outfit

This section is carrying an up-to-date Radio receiving set for use in mapmaking. With the set are chronometers that must be occasionally corrected to the fraction of a second, for a slight error in time would mean many yards, even miles.

Consequently the American legation Radio station will receive its time directly from Arlington, and with the aid of a chronometer record and relay it to the expedition in the Gobi.

The other part of the expedition will go 500 miles or so west of Urga, in the wooded hills, to continue the work begun last year. Their discoveries were revolutionary so far as geological theories are concerned and they expect still greater finds.

Find Snakes with Legs

They didn't find Adam or Eve, but they found the mosquitoes fossilized and harmless but perfectly preserved. They found huge reptiles supposed to have existed only in other parts of the world. Among these were reptiles with legs that might have stood upright. They also proved that Mongolia was once a much warmer country, a delightful place to live, which is in itself encouraging, for the present climate is cold, even on summer nights.

The expedition has a fleet of American motor trucks, reinforced by some 50 camels and equipment that insures comfortable if not luxurious living.

Pastorless Churches Reached by Airphone

Birmingham Congregation Fills Pulpit with Ether Set

BIRMINGHAM, ALA.—Is the time coming when there will be preacherless churches along with all the other economical measures which are being adopted? It looks as if Radio is going to aid such a move.

Last Sunday night when a Birmingham church had no preacher, the deacons did not trouble to invite an out-of-town pastor to preach. Instead a loud speaker was cut in on the ether waves from WSY, the congregation went to church as usual and heard a sermon preached from the pulpit of another Baptist church in the city.

About 500 persons were present and officials of the church the next day phoned Dr. J. E. Dillard, pastor of the other church, that they "enjoyed his sermon immensely" and took part in the prayers and songs as if they had been present. Dr. Dillard did not know he had been speaking to two audiences, one visible and one invisible.

Whistles in locomotive cabs to signal engineers by Radio waves are being tested on railroads in France.

ASKS DIVORCE; RADIO NAMED "LOVE CHIEF"

NEW YORK.—His Radio set was named as co-respondent by Mrs. Emma E. Mapother recently in a separation suit against George Mapother, wholesale druggist. Mrs. Mapother declared Mapother insisted on sitting up most of the night listening in on concerts and what-not, and keeping her awake the rest of the night quarreling.

JAZZ FALLS BEFORE EDUCATION AT KFDB

SAN FRANCISCO.—Station KFDB has discontinued broadcasting entertainment and reverted to the former policy of putting on the air matter of educational nature only. Under this arrangement the station operates only during mornings and afternoons, the evening hours having been abandoned for the present.

BUFFALOS LIKE BROADCASTS TOO



The miniature portable tube set Miss Ruth Wendt, Merrill, Wisconsin, girl, is holding in the palm of her hand, would just about make one bite for her friend, Mr. Buffalo. His interest in the camp's ether wave receiver, however, prevents him from resorting to such tactics

Texas Governor and Theo. Roberts on WEAY Program

HOUSTON, TEX.—Governor Pat M. Neff of Texas and Governor E. Lee Trinkle of Virginia joined Theodore Roberts, famous actor, in a two-hours Radiophone program recently at The Evening Post studio of WEAY, the Iris theater station.

Val and Earnie Stanton, brothers touring the Interstate circuit, also helped make up the bill with their "English as she is not spoken" a vaudeville act complete.

Want Press Commercial Station

OTTAWA.—Application to the department of marine for a license for a Radio station near St. Margaret's Bay, Halifax, has been made by the American Publishers' Committee on cable and Radio communications. Business is to be entirely press matter which will be relayed to New York, Chicago and other centers.

W. W. Grant Manufacturing Broadcasters' Equipment

CALGARY, ALTA.—W. W. Grant, president of The W. W. Grant Radio, Ltd., at Calgary, owner of broadcasting station CFCN, has now undertaken the manufacture and sale of Radiophone broadcasters.

During the last week he has manufactured and sold broadcasting sets to one firm in Saskatoon, Sask., Olds, Alta., and a large corporation which is installing plants in Mexico and South American cities.

WOAW Becomes Crime Sleuth

OMAHA, NEBR.—Police Commissioner Butler has arranged with the Woodmen of the World to have Station WOAW immediately available for police use in emergency. By this means, description of criminals or suspects will be sent out immediately following a crime.

AROUSES INTEREST IN CITY BY RADIO

BROADCAST SESSION OF POLICE COURT

Mayor of Kansas City Explains Functions of Government—Asks Citizens' Co-operation

KANSAS CITY, MO.—Mayor Frank H. Cromwell has evolved the problem of creating personal interest in the city's government among the citizens.

He's done it by Radio. Believing the main trouble with city government was that not enough persons understood its workings, the mayor determined upon a publicity campaign.

But there were no funds for advertising. There were no funds and no stenographers to write personal letters to all the taxpayers.

So the mayor hit upon the idea of using Radio.

Arrangements were made with the Sweeney Electrical and Automotive School broadcasting station, WHB, and now the plant carries a municipal program one evening each week.

Explains Problem to Citizens

First the mayor himself explained some of his problems and asked co-operation of citizens.

Next John B. Pew, city counselor, lectured on municipal problems—told how ordinances are passed, how improvements are determined upon and how taxes are assessed and collected.

Then Charles B. Tucker of the board of public welfare; Charles S. Foreman, assistant engineer of the municipal water system, and other heads of departments followed with explanations of municipal affairs.

The mayor found the plan worked to perfection except that voters still were in ignorance of how courts and commissions proceed at hearings.

Broadcast Proceedings

So the microphone was moved from one municipal organization meeting to another. The first experience was in broadcasting a session of the police court.

Listeners in heard the judge ask traffic violators why they drove by standing street cars, why they failed to drive on the right side of the street and why they did not observe traffic regulations.

Now the mayor believes the public is more in sympathy with his attempts to give the city a good administration. Police heads believe broadcasting of municipal court sessions helps the public understand the laws.

Mississippi to Have New Broadcaster in College

Station 5YE Awaiting License to Go on Air

NEW ORLEANS, LA.—The first station to broadcast in Mississippi will be 5YE, the new station being installed by the University of Mississippi. The school will make a specialty of broadcasting typical college songs, glee club music and university orchestra programs in addition to athletic news. Regular broadcasting awaits only the obtaining of a license.

Dr. W. L. Kennon will operate the station assisted by five student operators. The university hopes to arouse interest among "Ole Miss" alumni in southern cities who, it is believed, will thrill anew to their favorite glees resounding through the ether in the voices of their sons.

KGB Celebrates First Birthday

TACOMA, WASH.—KGB, the Tacoma Ledger-William A. Mullins Electric Company broadcasting station, celebrated its first birthday recently. The Ledger station presented a special anniversary program, duplicating insofar as possible the original program given at the station on its opening night a year ago.

THE ANTENNA BROTHERS

Spir L. and Lew P.

No Doubt 'Twas WSB

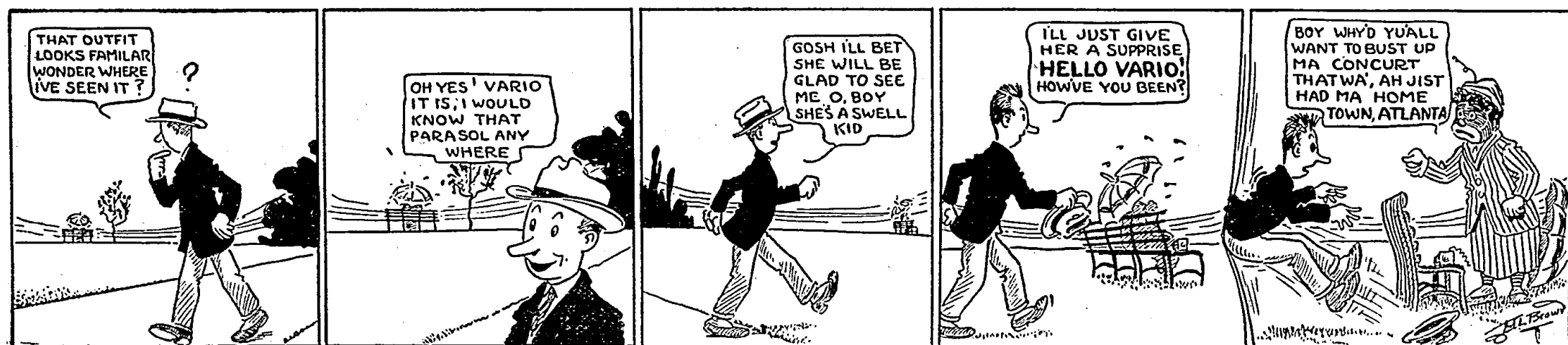

The Week's Advance Broadcast Programs

Tuesday, June 5

CFCA (Eastern, Daylight Saving, 400), 8:00-9:30 P. M., Concert, Star Orchestra; "Gunga Din" Thomas Pyburn, reader; "My Dreams"; W. Woods, cornetist; "Premier Amour", Star Orchestra; "Kissing Cup's Race"; Thomas Pyburn, reader; Cornet selections; W. Woods; "Spanish Serenade" Star Orchestra; "The Cremation of Sam McGee" Thomas Pyburn, reader.

KHJ (Pacific, 400), 6:45-7:30 P. M., Children's Hour; 8:00-10:00 P. M., De Luxe program.

KSD (Central, 546), 8:00 P. M., Concert and musical specialties furnished by Grand Central Theater talent.

KYW (Central, Daylight Saving, 345), 8:00-8:58 P. M., Musical program, Alice LeTarte, pianist; Martin Nelson, Lewis Meehan, tenors; Bernice Solomon, reader; Mrs. E. C. Russ, Carl Linner, accompanists; Wendell W. Hall, KYW's Music Maker.

WBAP (Central, 476), 9:30-10:30 P. M., Concert, Texas Hotel Orchestra.

WJAR (Eastern, Daylight Saving, 395), 12:02-1:00 P. M., Organ recital, Stanley Theater; Dinner music, Arcadia Cafe Orchestra; 2:00-3:00 P. M., Musical program; 4:30-6:00 P. M., Talk, "Affairs of the Heart"; Besty Logan; 7:30-7:55 P. M., Dream daddy with boys and girls.

WFAC (Central, 476), 12:30-1:00 P. M., Address, DeWitt McNair; 3:30-9:30 P. M., Concert, Jessie McKee's Orchestra; 11:00-12:00 P. M., Musical program under auspices of Sanger Bros.

WFI (Eastern, Daylight Saving, 395), 1:00-2:00 P. M., Dinner music, Meyer Davis Bellevue Stratford Orchestra; 3:00-3:30 P. M., Song and piano recital; 3:30-7:00 P. M., Strawberry and Clothier Male Quartet; 7:00-7:30 P. M., Safety talk by Stanley Cowman of the United States Fidelity and Guarantee Company; 8:00-8:30 P. M., Boy scout period; 8:30-10:30 P. M., Musical program; 10:30-12:00 P. M., Dance music, Meyer Davis Bellevue Stratford Orchestra.

WGI (Eastern, Daylight Saving, 360), 3:00 P. M., Amrad Women's Club; 5:00 P. M., "Twilight Tales"; Uncle David; 8:30 P. M., Babson report; Selections by Mrs. Annie L. Helser, soprano, and pupils; Tufts College lecture; Playlet, "A Cyclone for a Cent"; Amrad Players; Mrs. Annie L. Helser, soprano.

WGY (Eastern, 360), 1:00 P. M., Music and address, "The Moscow Art Theater"; Mrs. A. B. McKenzie, Schenectady Woman's Club; 7:35 P. M., Address, "The Saratoga Cure"; John G. Jones, Supt. Saratoga Springs Commission; 7:45 P. M., Radio drama, "Happiness"; WGY Players.

WHK (Eastern, 360), 8:00 P. M., Concert, WHK Trio; Babson's Radio Release.

WIP (Eastern, Daylight Saving, 509), 1:00 P. M., Short talk; 3:00-4:30 P. M., Musical program; 6:00-6:45 P. M., Dinner music program; 7:00-7:30 P. M., Bedtime stories, Uncle Wip; 8:00-10:10 P. M., Recital; 10:10 P. M.; Dance music, Charlie Kerr's L'Aiglon Orchestra.

WJAX (Eastern, 390), 7:30 P. M., Concert furnished by Cleveland News.

WLW (Eastern, 309), 10:00 P. M., Musical program, Alma L. Goldstine, pianist; "The Great Awakening"; "Give a Man a Horse He Can Ride"; Theodore Niedzielski, baritone; Schweuher's "Lazarus in E Flat Minor"; "In the Ropes"; Ruth S. Arnold, harpist; Mary Green, soprano; Ruth S. Arnold, harpist; Playlet, "Sweet and Twenty"; "Star Eyes"; "The Banjo Song"; Theodore Niedzielski; "Dance Fantastique"; Ruth S. Arnold; Santuzza's Aria from Cavalleria Rusticana; "Believe Me If All Those Endearing Young Charms"; Ruth S. Arnold; Alma L. Goldstine; "The Singer"; "Su Mirada"; Mary Green, soprano.

WMAQ (Central, Daylight Saving, 447), 9:15 P. M., Musical program, Mixed Quartet from Lyceum Arts Conservatory.

WMB (Central, 500), 8:30 P. M., Concert, Hotel Gayoso Orchestra, Gaspar Pappalardo, director; 11:00 P. M., Midnight Frolic.

WOC (Central, 484), 12:00 M., Chimes concert; 3:30 P. M., Educational talk, A. G. Hinrichs.

WOO (Eastern, Daylight Saving, 509), 11:00-11:30 A. M., Organ recital; 12:00-12:55 P. M., Luncheon Music, Tea Room Orchestra; 4:45-5:00 P. M., Organ; 7:45-8:30 P. M., Song recital; 8:30-10:55 P. M., Dance music, Hotel Adelphi Orchestra, A. Candelori, director.

WWJ (Eastern, 580), 8:30 P. M., Concert News Orchestra; Town Crier; Vocal selections, pupils of George Carr.

WGI (Eastern, Daylight Saving, 360), 5:00 P. M., "Twilight Tales"; Uncle David; 8:15 P. M., Glee Hour, Eunice L. Randall; "Pung Chow and Stories of China"; Marion A. Hewlett; Musical program, Uncle Eddie.

WIP (Eastern, Daylight Saving, 509), 1:00-2:00 P. M., Organ recital, Karl Bonawitz; 3:00-4:30 P. M., Musical program; 6:00-6:45 P. M., Dinner music; 7:00-7:30 P. M., Bedtime stories, Uncle Wip.

WLW (Eastern, 309), 8:00 P. M., Accordion solo, Salvatore Ercolino; Songs for children, Hilda Kaufman; Comedian, Sam Ward; Zither duets, Ruth and

Minor; Sarah Gelman, pianist; "Gold and Silver", Star Orchestra; "The Evening Star"; H. Saunders, cellist; "Etude in F Sharp"; Sarah Gelman, pianist; Suite, "Country Sketches" Star Orchestra.

KHJ (Pacific, 400), 6:45-7:30 P. M., Children's Hour, "Uncle John"; 8:00-10:00 P. M., De Luxe program.

WBAP (Central, 476), 9:30-10:45 P. M., Negro spirituals and folk songs, Mount Pisgah Negro Baptist Church.

WJAR (Eastern, Daylight Saving, 395), 11:30-12:50 P. M., Musical program, Stanley Organ, Arcadia Cafe Orchestra; 2:00-3:00 P. M., Song recital; 4:30-6:00

Winstow Hanscom, tenor; "Budgets"; I. E. Dierdorff; Grace H. Olin; Musical program.

WGY (Eastern, 360), 1:00 P. M., Music and address, "Foods for Growth—Cereals"; Mary G. McCormick, Supervisor of Nutrition, N. Y. Dept. of Health; 7:30-8:00 P. M., Program of National Elec. Light Ass'n., Carnegie Hall, N. Y.; 8:15 P. M., Address, Julius H. Barnes, President of U. S. Chamber of Commerce; 8:45 P. M., Anna Case, soprano.

WIP (Eastern, Daylight Saving, 509), 1:00 P. M., Short talk; 3:00-4:30 P. M., Musical program; 6:00-6:45 P. M., Dinner music; 7:00-7:30 P. M., Bedtime stories, Uncle Wip; 8:00-9:00 P. M., Musical program; 9:00-9:30 P. M., Karl Bonawitz, organist.

WJAX (Eastern, 390), 8:00 P. M., Concert; "Beneath Thy Window"; "Deep in the Mine"; Wendall Phillips; Gavotte from "Iphigene in Aulis"; Caprice from "Alecote"; Mrs. Lester L. Askue; Scotch ditties and monologues, Phil Barker; "The Harry Lauder of Cleveland"; Recitative air from "Nadeschda"; "My Heart is Heavy"; Marie Simmelink; "Meditation" from "Thals"; "Liebesfreud"; Diana Miller, violinist; Accordion selections, S. R. Rinn; "A Dream"; "Sweet Miss Mary"; Wendall Phillips; Scotch songs, Phil Barker; "Romance and Truesque"; "Jest in Vienna"; Mrs. Lester L. Askue; "Thy Beaming Eyes"; "Pleading"; "All For You"; Marie Simmelink; "The

What Time Is It?

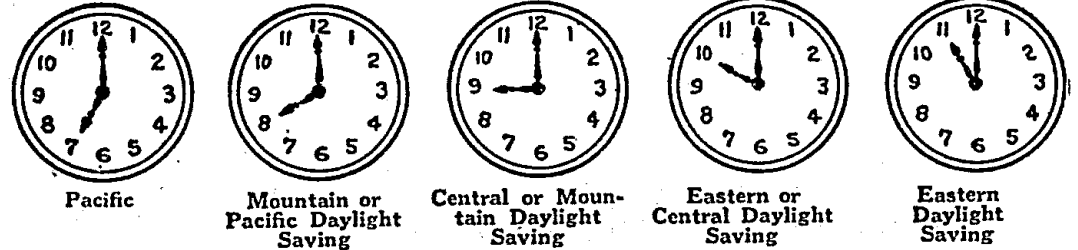

THE above clock dials are shown to clear up the misunderstanding which the various time bands and the Daylight Saving plan are creating. Although each dial registers time one hour ahead or behind of its neighbor, the exact period indicated on each dial is the same as that on every other. This chart will aid in the use of the advance programs and the schedules in the Radiophone Broadcasting Station Directory, both of which give the hours stated in the particular kind of time in use at each station. Only features are listed in the advance programs below. Much additional data and such parts of station schedules as are regular features serially continuously on page eight.

Charles Hohe; Children's story, "Epaminondas"; Hilda Kaufman; Zither duet; Banjo, mandolin and guitar selections; Al Zeps and Sons; "Poems for Children"; B. C. O'Donnell; Concert, Choir of Grace M. E. Church of Norwood; "Day Is Dying in the West"; Choir; "God Shall Wipe Away All Tears"; Naomi Earhart; "Savior, Thy Children Keep"; Choir; Ralph House, cellist; "Hark, Hark My Soul"; "Quartet"; "The Road to Greatness"; Dr. J. J. Richards; "Love's Old Sweet Song"; "Sweet and Low"; Choir; Alma House, soprano; "Publitate"; Choir.

WMAQ (Central, Daylight Saving, 447), 7:00-7:30 P. M., Babson report; 7:30-8:00 P. M., Talk on Infant Welfare Society; Burdette Cleveland, soprano; 8:15-10:00 P. M., Maurice G. Irvin, baritone.

WOC (Central, 484), 3:30 P. M., Educational talk, D. K. Kirk; 8:00 P. M., Organ recital, Erwin Swindell, organist; 10:00 P. M., Musical program, Galva Military Band, of Galva, Ill.; Address, Mayor Howard Mellow, of Galva, Ill.

WOO (Eastern, Daylight Saving, 509), 11:00-11:30 A. M., Organ recital; 12:00-12:55 P. M., Luncheon Music, Tea Room Orchestra; 4:45-5:00 P. M., Organ; 7:45-8:30 P. M., Song recital; 8:30-10:55 P. M., Dance music, Hotel Adelphi Orchestra, A. Candelori, director.

WWJ (Eastern, 580), 8:30 P. M., Concert News Orchestra; Town Crier; Vocal selections, pupils of George Carr.

P. M., Musical selections and short talks; 7:30-8:00 P. M., Bedtime stories, Dream Daddy.

WFAC (Central, 476), 12:30-1:00 P. M., Address, "Simple Civic Duties"; Judge Rosser Thomas; 8:30-9:30 P. M., Musical program, J. A. Fite, basso, assisting musicians; 11:00-12:00 P. M., Musical program, under the auspices of D. L. Whittle Music Co.

WFI (Eastern, Daylight Saving, 395), 1:00-2:00 P. M., Dinner music, Meyer Davis Bellevue Stratford Orchestra; 3:00 P. M., Song recital; 6:30-7:00 P. M., Children's Own Half Hour, Cousin Sue; 7:00 P. M., Short talk; 8:00-10:30 P. M., Musical program; 10:30 P. M., Dance music, Meyer Davis Bellevue Stratford Orchestra.

WGI (Eastern, Daylight Saving, 360), 5:00 P. M., "Twilight Tales"; Uncle David; 8:30 P. M., Dean

Thursday, June 7

CFCA (Eastern, Daylight Saving, 400), 8:00-9:00 P. M., Selections "High Jinks" Star Orchestra; "First Movement from Mozart Sonata in G Major", Sarah Gelman, pianist; "Melody in F", H. Saunders, cellist; "Rosaura" Star Orchestra; "Sherzor in E

Real Radio Bargains

That Save You Money

40 Spot Triple Tested Crystal Mounted Galena that will equal any 50c crystal..	Special 7 for \$1.00
Cockaday, Flewelling, Reinartz-Rosenblum. All parts complete for these circuits with working diagrams.....	Only \$10.50
Tubular Grid-Leaks from 1/2 to 5 megohms	Special 4 for \$1.00
\$8.00 Signal Corps Phone	Special \$3.25

All merchandise sold on our money-back guarantee. Send Purchase Price and you will be supplied Postpaid.

Vorzimer Radio Company
1610 Lexington Avenue NEW YORK CITY

Kellogg Radio Equipment

For Better Results

The Kellogg Variometer

The stator and rotor are of Kellogg Bakelite, with properly proportioned windings of well insulated copper wire.

Two terminals are provided for the rotor and three of the stator, permitting the variometer to be used in all known variometer circuits.

Kellogg variometers have no sliding contacts; nothing to wear or short. A spring takes up all play and allows the rotor to turn with a smooth even motion.

No. 501.....Each \$8.00

KELLOGG SWITCHBOARD & SUPPLY COMPANY
CHICAGO

CHAS. FRESHMAN CO. INC.
106-7th Ave., New York, N.Y.

All Sizes at Reliable Dealers

10c

FLEWELLING, REINARTZ, SUPER-REGENERATIVE

and other diagrams will be brought to you immediately in our new 32-page booklet. Information about tubes, hints on construction of sets and other valuable and instructive data for everyone interested in Radio is included.

Our complete line of standard equipment is also illustrated and described—an up-to-date catalog of the newest in Radio at right prices.

FREMONT RADIO SALES CO.
227-229 Fulton St. NEW YORK CITY

Wednesday, June 6

CFCA (Eastern, Daylight Saving, 400), 8:00 P. M., Overture, "Masanello"; Star Orchestra; "That Night"; Elcho Fiddes, tenor; "Serenade"; Star Orchestra; "Tambourin Chinois"; Harry Adaskin, violinist; "Sound the Pibroch"; Elcho Fiddes, tenor; "Skaters' Waltz"; Star Orchestra; "From the Land of the Sky-Blue Waters"; Harry Adaskin, violinist; Suite, "From the Country-Side"; Star Orchestra; "Inter Nese"; Echo Fiddes, tenor; "Through Battle to Victory"; Star Orchestra.

KHJ (Pacific, 400), 6:45-7:30 P. M., Children's Hour, "Uncle John"; 8:00-10:00 P. M., Program arranged by South Pasadena Chamber of Commerce.

KSD (Central, 546), 8:00 P. M., Concert, Standard Oil Band of Wood River, Ill.

KYW (Central, Daylight Saving, 345), 8:00-8:58 P. M., Musical program, Grace King Granston, soprano; S. J. Sjoberg, accompanist; Dixie Fields, soprano; Wendell W. Hall; George Cranston, tenor; Kellers Orchestra; 9:25 P. M., "Twenty Minutes of Good Reading"; Rev. C. J. Perlin, Loyola University.

WBAP (Central, 476), 9:30-10:45 P. M., Concert, Banjo Orchestra from Butcher School of Music.

WJAR (Eastern, Daylight Saving, 395), 1:30-2:00 P. M., Organ recital; Stanley Theater; Arcadia Cafe Orchestra; 2:00-3:00 P. M., Song recital; 4:30-6:00 P. M., Solos; Talk, "Affairs of the Heart"; by Besty Logan; 7:30-7:55 P. M., Bedtime stories, Dream Daddy; 8:00 P. M., Short talks and musical program.

WFAC (Central, 476), 12:30-1:00 P. M., Musical program, Melba Theater talent.

WFI (Eastern, Daylight Saving, 395), 1:00-2:00 P. M., Dinner music, Meyer Davis' Bellevue Stratford Orchestra; 3:00-4:00 P. M., Musical program, 4:00 P. M., Song recital; 6:30-7:00 P. M., Children's own half hour, Cousin Sue.

No. 1010X

30 Ohm Rheostat

Excellent results assured with use on New Type Tubes

UV199A UV201A

Using small filament current

6 Ohm	\$0.75
20 Ohm	1.00
30 Ohm	1.10

At your dealers. Otherwise sent postpaid on receipt of purchase price.

Write for catalog illustrating and describing our entire line of quality apparatus.

Territory Open for Jobbers

AEROVOX WIRELESS CORP.
208 West 17th Street NEW YORK

What is Doctor Mu's Great Secret?

Doctor Mu, exalted sage, whose wisdom has guided thousands along the path to true radio joy, promises to divulge a momentous secret in a few days. Watch for it.

ALL GRESE & CO. INC.
RICHMOND HILL
NEW YORK

How to Make a Reinartz Receiver

Complete BLUE PRINTS

for the construction of a Reinartz Receiving Unit and two step amplifier.

INSTRUCTIONS FOR ASSEMBLY

Description of apparatus and accessories and details of tuning.

WINDING A REINARTZ COIL

Cabinet Dimensions
Panel Layouts
List of Parts

Send only money orders—no checks or stamps. Coins at your own risk.

Book Department
Radio Digest
123 West Madison Street
CHICAGO, ILL.

Only 50c

PILOTLESS FRENCH PLANE PROVES SUCCESS

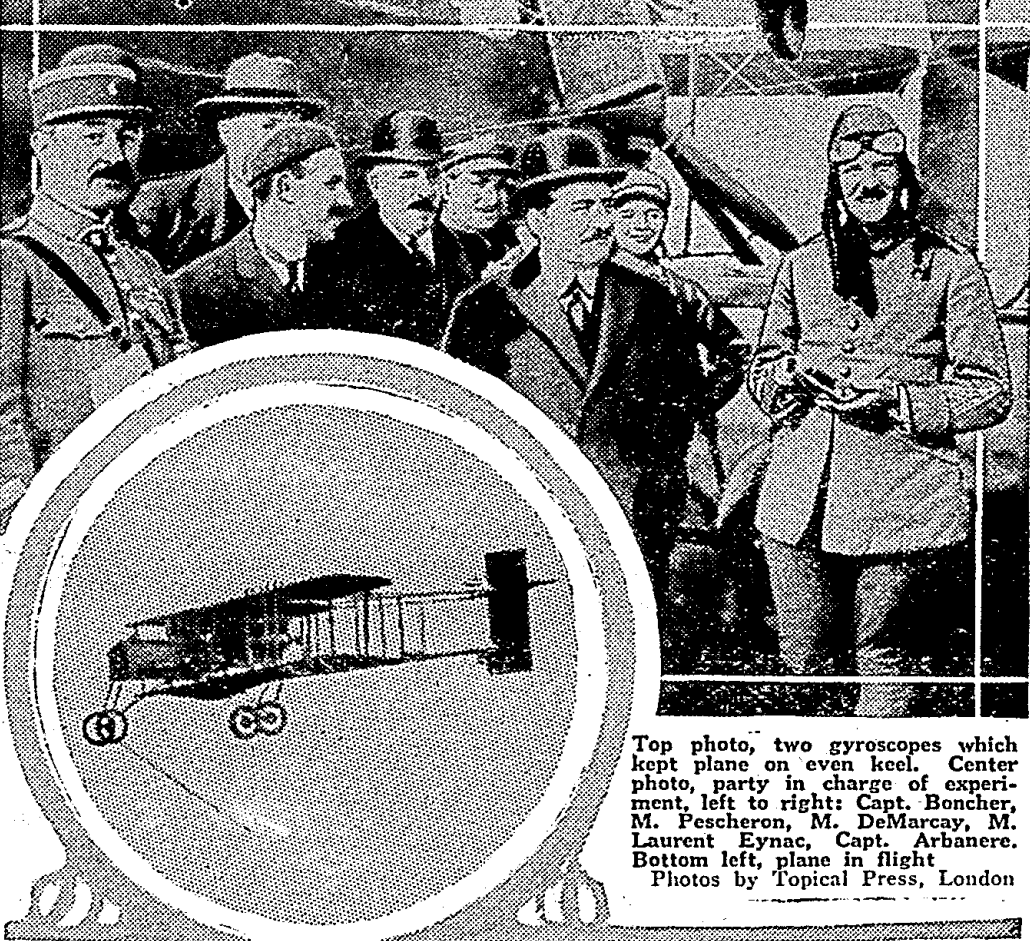
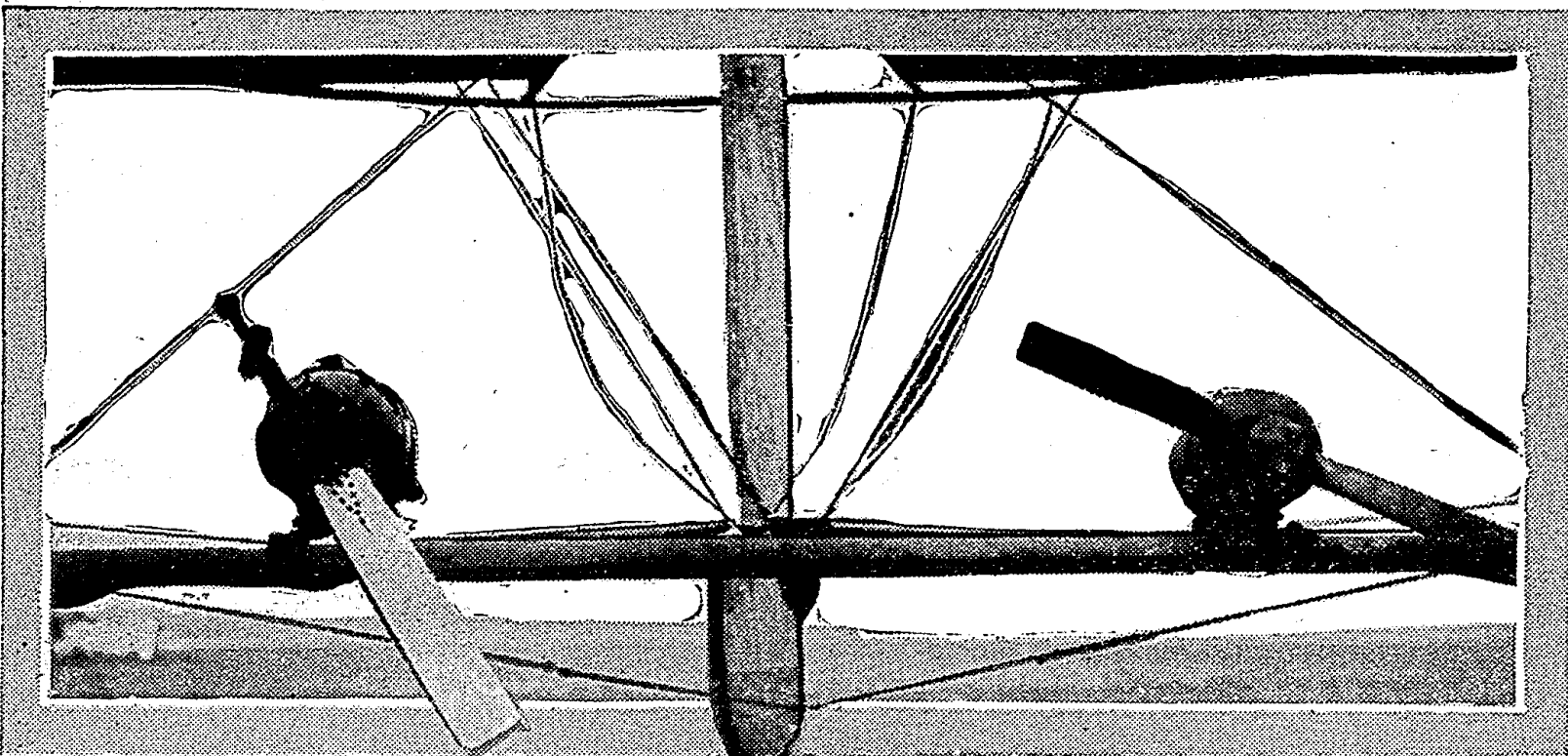

Top photo, two gyroscopes which kept plane on even keel. Center photo, party in charge of experiment, left to right: Capt. Boncher, M. Pescheron, M. DeMarcay, M. Laurent Eynac, Capt. Arbanere. Bottom left, plane in flight. Photos by Topical Press, London

RADIO PILOTS PLANE

(Continued from page 1)
M. Pescheron, engineer in charge, and Capt. Arbanere, the pilot, were passengers in the plane during the flight, but were there only to observe the control and land the ship in case something should go wrong. The success, however, proved so great that they did not touch a control during the take-off, flight, or landing. The builder and inventor of the plane is M. De Marcay, famous French aeronautical and Radio engineer. He is said to have negotiated the sale of his invention with the French government.

Description of Flight
The machine has been made almost automatic, a button on the ground controlling by Radio only the ascent, the descent and turning movements. Everything else was automatic. Stability was obtained by gyroscopes connected with auxiliary motors by means of cogs. In landing, the machine when ten feet from the ground, automatically righted itself and shut off the motor. After it had touched the earth the engine started again and the machine ran along the ground. The aeroplane after leaving the ground flew over the aerodrome exactly like one driven by a human pilot, and landed without mishap amid the cheers of the spectators.

War Use Visualized
War use of the pilotless, Radio-controlled plane unfolds unlimited possibilities. Photographic record could be made of the entire enemy front without endangering a pilot's life, or if the pilot were wounded, the Radio-control would bring the plane and pilot back behind the lines in safety. Bombing expeditions could be carried to the limit with the new invention. Tons of explosives might be dropped on enemy ground while one pilot at the Radio control key, on the ground, could direct the entire squadron on the bombing expedition.

Amateurs experimenting with Radio sets should never tinker with house lighting circuits or other high voltage systems.

PREMIER "MICROMETER" VARIOCOUPERS

Cure the New Wave Length Troubles

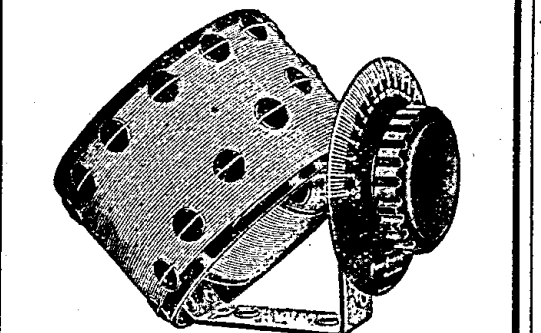

\$5.00 COMPLETE WITH DIAL.
A HIGHLY SELECTIVE VARIOCOUPLER having 180-degree orientation and 20 Antenna taps which facilitate very sharp tuning. Wound with No. 21 single silk or black enameled pure copper wire. Eighty turns on stator—fifty-five on rotor. Wave lengths range from 150 to 750 meters. All metal parts brass—contacts positive—slugs "put" at any angle. Adaptable for either single circuit or loose coupled tuned plate hook-ups. Bakelite button on each tap wire permitting easy and safe soldering.
Our Complete Parts Bulletin on request.
DISTRIBUTORS—We make a most complete line of Radio parts. Some territory open for live, responsible concerns.
PREMIER ELECTRIC COMPANY
Manufacturers Est. 1905.
3810 Ravenswood Avenue, CHICAGO, ILL.

SUMMER PHOTOGRAPHS? EARN A DOLLAR—

SUMMERTIME means summer pictures. You and your camera can earn a dollar by sending the Digest out-of-door photos involving the use of Radio in camp, the automobile, swimming, boating, canoeing, on the hike, playing golf, etc. Send such photographs with negatives and a few descriptive words, including a stamped, addressed envelope so that unsuitable pictures may be returned.
SUMMER PHOTO DEPARTMENT,
Radio Digest,
123 W. Madison St., Chicago.

SMUGGLES SET TO HIS BEDSIDE IN HOSPITAL

Patient, Suddenly Taken Ill, Determines to Hear Wife Sing.

BOSTON, MASS.—Stephen O'Neill of Dorchester is the most envied patient at the Boston City Hospital. He is the only one in that institution to have a Radio set to while away his time while undergoing treatment. Although the hospital authorities now know that his Radio has been installed, it was not for several days after it came in that they discovered it. The set is now enjoyed by all the patients in the ward from time to time.

O'Neill had a special reason for having the set brought in to him and quietly connected up, for he wanted to listen to his wife's singing broadcast from the Shepard Stores station, WNAC, recently. She and her husband were recently scheduled for a musical program at WNAC in connection with the Young Men's Catholic Association Glee Club, but just before the event Mr. O'Neill was taken seriously sick and rushed to the City Hospital for an operation. Not to be beaten by sickness, he decided to hear the program at all costs, and with the assistance of friends secured the set and secretly installed it near his bed.

The trick is in the Coil
NO STORAGE BATTERY REQUIRED
No Radio Frequency Transformer used. Not Super but DOUBLE Reflex Regeneration. Works local without antenna or ground, and brings in the "FAR AWAY ONES" with more volume than you ever thought one tube could deliver.
Money Order for 25 cts. brings easy to read diagrams and all information. Address:
JACK PRATT
508 Railway Exchange Bldg., Chicago, Ill.
P. S.: Its Radio Golf Record is 110,000 miles. First Trial Picked Up Havana from New York

SPECIAL OFFER LIST

(Continued from page 2)
Class D Articles
(5-Plate .0001 mfd.); Ray-O-Vac No. 4151 B Battery, 22½ volts; Ray-O-Vac Dry Battery, 3 cells 4½ volts; Electrad Variolum, with mica condenser; Dubiller By-Pass Condenser (2 mfd.); CRL Variable Grid Leak with Condenser.
Class E Articles
For ten consecutively numbered coupons and one dollar and fifty cents (\$1.50) any one of the following articles will be sent: 1 Carter 6-Ohm Automatic Control Rheostat; 1 Carter 20 Ohm Automatic Control Rheostat; 1 Decima 3-Plate Variable Condenser; Walnut Variable Condenser (13-Plate .00025 mfd.); Ray-O-Vac Dry Battery, 4 cells 1½ volts; Dubiller Variodon (.0004 or .0006 mfd.).
Class F Articles
For twelve consecutively numbered coupons and one dollar and eighty cents (\$1.80) the following will be sent: 1 Acme Pot-Rheo (potentiometer and rheostat); Walnut Variable Condenser (23-Plate .0005 mfd.); Ray-O-Vac No. 2151 B Battery, 22½ volts; Dubiller By-Pass Condenser (3 mfd.); Premier Variable Condenser without dial (.00039 mfd.).
Class G Articles
For fourteen consecutively numbered coupons and two dollars and forty cents (\$2.40) any one of the following articles will be sent: 1 Federal 7-Plate Variable Condenser; 1 Federal 11-Plate Variable Condenser; 1 Federal 21-Plate Variable Condenser; 1 Federal Anticapacity Switch; 1 Democal Variable Condenser 11-Plate; Walnut Variable Condenser (43-Plate .001 mfd.); Dubiller Variodon (.001 mfd.); Dubiller By-Pass Con-

denser (4 mfd.); Premier Variable Condenser with dial (.00078 mfd.).
Class H Articles
For sixteen consecutively numbered coupons and three dollars (\$3.00) any one of the following articles will be sent: 1 Federal Audio Frequency Transformer No. 228 W; 1 Democal 23-Plate Variable Condenser; 1 Acme Audio Frequency Transformer; 1 Acme Radio Frequency Transformer (R-2, R-3, or R-4); Walnut Variable Condenser (13-Plate vernier); Walnut Variable Condenser (23-plate vernier); Ray-O-Vac No. 2301 "B" Battery 45 volts; Ray-O-Vac Dry Battery, 6 cells 1½ volts; Dubiller Duratran (R. F. transformer); Premier Micrometer Variocoupler with dial; Premier Variable Condenser with dial (.0015 mfd.); Premier Variable Condenser with vernier (.0004 mfd.).
WJAX Gives Condensed News
CLEVELAND, OHIO.—WJAX the broadcasting station of the Union Trust Co. here has augmented its regular program of financial and stock reports with a condensed report of all important news of general interest. The reports will be furnished by the Cleveland News.
Sunday Evening Club Suspends
CHICAGO.—Concluding services of the Sunday Evening club prior to the summer adjournment were broadcast from Orchestra hall by Station KYW Sunday. The services will be resumed October 7.

Delicate Soldering

THE POST SOLDERING IRON
Platinum-Heating Unit—Interchangeable Tips—Universal Current
(Large and Small)

\$6 ONE-HALF ACTUAL SIZE
Awarded Certificate of Excellency, N. Y. Evening Mail Radio Institute
From your Dealer, or write
POST ELECTRIC COMPANY (Dept. 509), 30 E. 42nd St., New York

Books of HOOKUPS

For One Dollar
Reinartz Flewelling Reflex

many others, simple and elaborate, fully diagrammed and explained. Used continuously by thousands of Radio fans, both amateurs and professionals. The greatest book ever published for experimenting. Keep this valuable little book before you at all times. Send your check or money-order for one dollar and the book will be mailed to you. Forty-seven hook-ups, all different. Send your order today. The edition is limited.

Book of Hook-ups, \$1.00
E L S RADIO COMPANY
Randolph Building
CHICAGO, ILL.
Special Offer to Dealers

ZENITH 1R DETECTOR AND 2M AMPLIFIER

HOW TO OPERATE UNITS CLEARLY EXPLAINED

Apparatus Comprises Regenerative Feed-Back Detector and Two-Stage Amplifier—Selective and Sensitive

See Photo Diagram on Facing Page
The standard receiving set illustrated on page seven is a Zenith 1-R Receiver and 2-M Amplifier, manufactured by the Chicago Radio Laboratory, Chicago. It comprises a three-circuit regenerative feed-back tuner and detector combined with two stages of audio frequency amplification. Some of its features are: Total elimination of body capacity by proper concentration of electro-static and electro-magnetic fields without the use of metal shields or screens; reduction of high frequency resistance to a minimum and consequent increase in signal strength and efficiency; unusual selectivity and distance range achieved by radical departures from customary methods of construction.

Battery Connections to Set
In the photo diagram the first photo shows the front view of the set and its controls. The lower view illustrates the panels with the mounted apparatus as moved from the cabinet. When inserted in the cabinet the binding posts project from the back through holes in the base. The antenna and battery connections are made to these posts.

The detector plate battery and likewise the amplifier plate and biasing batteries are incorporated in the interior of the cabinet. These then do not have to be added to the external connections but are shown for clearness and simplicity.

The photo diagram illustrates the method of making the connections between the I-R receiver and the 2-M amplifier. It is particularly important that the positive pole on the storage battery be connected as shown on the diagram. The positive pole is usually marked "Pos," "P" or "x" and is frequently painted red. The negative is marked "Neg," "N" or "—" and is frequently painted black. This applies to the B batteries also, where the positive lead is red and the negative lead is black.

Loud Speaker Use
Whenever a loud speaker is used in connection with the 2-M amplifier, extra B battery should be connected to posts No. 5 and No. 6. This extra B battery should be not less than 67½ volts, and preferably should be 90 volts. It may consist of three or four 22½ volt B batteries connected in series (i.e., positive of one to the negative of the next, and so on), or may be two of the 45 volt or one of the 90 volt B batteries on the market, whichever is best available. Positive should connect to No. 5 and negative to No. 6.

When using a loud speaker in connection with the 2-M amplifier, never connect it to posts No. 5 and No. 6 in series with the extra B battery, as is sometimes done with other types of amplifiers. Always connect the loud speaker terminals to a telephone plug and insert this plug in whichever step of the amplifier is required for the strength desired.

Instructions for Operation
When the installation has been completed insert the three vacuum tubes in their respective sockets inside the instruments. It is better to begin operating the instruments by using the head phones rather than by attempting to use the loud speaker at first. Never use the loud speaker for tuning, but tune using head phones only, switching to loud speaker when tuning is completed and station is heard clearly in phones.

The detector rheostat should be set be-

HERE'S YOUR CHANCE TO LEARN MONGOLIAN

SHEFFIELD, ENG.—A Radio experiment of great interest is to be made here soon. General Ferris, Director-General of Radio Services to the French Government, has agreed to broadcast to three Sheffield schools, each fitted with sets, a fable and a poem in French. The experiment, it is believed, will lead to students in all countries getting a first-hand grasp of foreign languages by listening in to the teaching in native schools.

tween points 8 and 9 and the amplifier rheostats a little further advanced. If either UV-201A or C-301A tubes are used all rheostats are set between 0 and 1.

Place the head telephone plug in jack No. 2 in the amplifier, turn the battery switch to the "on" position, and with the pointer of secondary tuner knob on graduation 2 turn the pointer of the tickler knob very gradually to the right. It is better when adjusting these two pointers to use the small knobs for making these adjustments. As the pointer is gradually moved to the right you will notice a faint "scratchy hiss" in the telephone and you will note that as the first pointer is changed to a different position this "hiss" in the telephones is also secured at a different position on the tickler pointer. If this pointer is turned too far to the right you may hear a loud, unpleasant "howl" in the head telephones. This "howl" is an indication that pointer is turned too far to the right.

With one hand on the left small knob and the other on the center small knob, keeping tickler pointer at all times far enough to the right so that the hiss continues, revolve secondary tuner pointer over the portion of the scale between 1 and 5. A series of clear flute-like whistles will be heard, provided broadcasting stations are in operation within your range. It will be noticed that when you locate one of these whistles, that as you move the secondary pointer the whistle is first of very high pitch, and as the movement of the pointer is continued the pitch becomes lower, and finally the sound is lost entirely; and as the movement of the pointer is still continued the whistle is again heard low in pitch, and on further movement increases higher and higher until lost again. The center of this whistle, or the silent point, is the exact setting for the station transmitting. Once such a whistle is located and a silent point found, gradually turn tickler pointer to the left. This requires again an adjustment of the first pointer to keep at the silent point. Then tickler is turned slightly further to the left, and secondary again adjusted. This operation is continued until the hissing sound in the telephone stops, and the station should then be heard clearly. The operator should learn to adjust these two simultaneously and not first move one and then the other.

It will be found, usually, that on one or two points on lower switch the operator will be unable to secure the hissing sound by turning tickler pointer. These "dead" points should thereafter be avoided. They are, usually, depending on the antenna used, points 3 and 4, 4 and 5, or 5 and 6. Should there be more than two of these "dead" points, it is good evidence that there are exceptional losses in the antenna, and a better antenna should be provided.

After the "dead" points have been located, set the lower switch on the contact just below the dead points and adjust pointers secondary and tickler until you hear clearly and loudly a fairly distant station, selecting your time for this when a local or nearby station is not transmitting.

Supposing the "dead" points in this case are 5 and 6, set lower switch on point 4 and adjust till you hear the station clearly. If point 3 is better than point 4, try point 2. After you secure the best point on lower switch, try movement of upper switch until you find the best point on it for that particular station. It is possible that when you desire to hear a particular station and have adjusted both as above indicated, there will be some undesired interference which prevents you hearing the station clearly. In such a case, still assuming that points 5 and 6 are found to be dead, try point 7, again adjusting secondary and tickler until the station is heard, then 8 and 9 on both, and lastly the various points on upper switch, until you have found the best point above the "dead" points. This procedure often gives equally good receiving conditions and does away with the interference.

In case it is desired to tune out a nearby broadcasting station and receive distant stations, quite satisfactory results are usually obtained by either setting lower switch on point 1 or 2, and varying upper switch till the best point is found where the distant station comes in clearly and the local station is not heard. Sometimes the local station can be eliminated by using the lower switch on points 9 and 10. This especially applies when the local station is operating on 360 meters, and the distant station is operating on 400 meters. For Radiophone reception, the small

knob and pointer at the bottom to the right should be left on point 2, although under certain conditions the longer or 400 meter broadcasting stations will be received quite clearly when this switch is set on point 3, but with corresponding change in position of the secondary pointer, which will then be found to be somewhere nearer the lower end of the scale.

It will be noted from the instructions given that for ordinary conditions all but two of the adjustments provided are left fixed, once found. After these have been found the operator confines his efforts to the secondary and regeneration controls, using the small knobs to manipulate them.

Meters, measuring the time during which persons are listening in on a radio concert, is the suggestion coming from South America. Actual use was made of such an arrangement recently in Belgrano, a suburb of Buenos Aires.

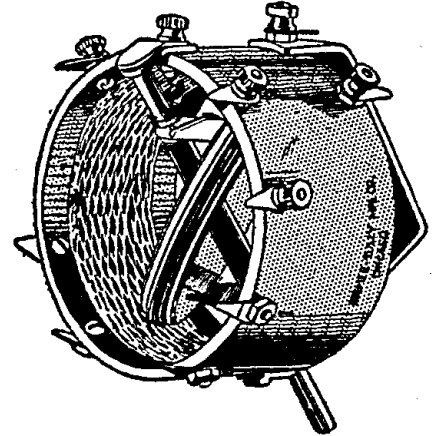

WITH TWO GOOD CONDENSERS AND A B-T VERNIER TUNER

you can hook up the latest circuits with absolute vernier control and greatly superior results.

Detailed diagrams furnished. 180-750 meters. Price\$5.00

BREMER-TULLY MFG. CO.

532 S. Canal St Chicago

RITTER LOOP AERIAL \$1

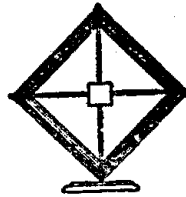

All parts supplied; can be assembled in 10 minutes. We guarantee that the Ritter Loop will eliminate lightning troubles. Reduces static, interference and noises from your neighbors' regenerative sets. Come and see the Ritter Loop Assembled. By mail 10c extra.

RITTER RADIO CORP.

232 Canal St., near Centre New York



Doctor Mu is never idle! Watch for the New Grebe Receiver

Doctor Mu, exalted sage of radio, will make an announcement of utmost importance to the readers of this paper within a few days.



Summer Static Overcome

"Good-bye Aerial"



ANTENNELLA

No aerial or antenna needed

All outside wiring, aerial, lightning arresters, switches and other inconveniences so inductive to static are eliminated.

Merely plug Antennella in any light socket and you can enjoy all Radio pleasures in any room in your home, apartment or hotel. No current consumed.

New Improved

ANTENNELLA NOW ONLY \$1.25

formerly \$2.00

At your dealer's—otherwise send purchase price and you will be supplied postpaid.

Chas. Freshman Co. Inc. Radio Condenser Products 106 SEVENTH AVENUE, NEW YORK

BARGAINS THAT SATISFY

VARIOMETERS	
Raysol (Kill-dried parts).....	\$2.00
VARIOCOUPERS	
Eastern Green Silk Wound.....	1.60
Queens (180 degree).....	2.30
Moradio (Cotton covered).....	1.50
Moradio (Enameled).....	1.50
Eastern Long Wave (150-3200 meters).....	5.50
Cockaday Coils.....	2.35
CONDENSERS	
Regal, 43 Plates, .001 Mfd. Cap.....	2.25
Regal, 11 Plates, .00025 Mfd. Cap.....	1.65
American Bell, 43 Plates with Vernier.....	3.95
American Bell, 23 Plates with Vernier.....	3.65
Arrow, 23 Plates with Vernier.....	3.50
Phone By-pass, A. J. M.....	.35
RHEOSTATS	
Regal (High quality, 8 ohm).....	.70
Klossner Vernier.....	.55
Pararon.....	.80
Roberts 6 Ohm Standard.....	.60
Bradleystats.....	1.30
Resistances.....	
Moulded.....	.35
Rameco.....	.35
Turney (All Metal).....	.25
TRANSFORMERS (Radio Frequency)	
Tricoil (of Subway Reception Fame).....	1.35
Radio Laboratory RT-1.....	2.50
Murad T-11.....	2.20
Baldwin.....	1.55
DIALS	
Kesco 3 1/4-inch Moulded.....	.30
Kesco 3-inch Moulded.....	.25
Kesco 2-inch Moulded.....	.25
American Hard Rubber, 3-inch.....	.50
American Hard Rubber, 4-inch.....\$0.55	
Electro, 4-inch Fada Knob.....	.55
Emeloid 3-inch Unbreakable.....	.30
Emeloid 2-inch Unbreakable.....	.20
Vernier Dial Adjustment.....	.20
HEAD TELEPHONES	
Royal Phones.....	3.75
Telephone Connectors, Regal, for 3 Pair Phones.....	.30
Phonograph Attachment "Y" Shape.....	1.00
Radiophone Adapter (Rubber Moulded).....	1.35
TUBES	
Meyers High-Mu (Last Lot).....	4.25
BATTERIES ("B" Only)	
Volton 22 1/2 V., Small Size.....	.90
Volton 22 1/2 V., Medium Size.....	1.14
Volton 22 1/2 V., Large Size.....	1.55
Volton 45 V., Medium Size.....	1.98
Volton 45 V., Large Size.....	2.50
MISCELLANEOUS	
Single Circuit Jacks.....	.25
Double Closed Circuit Jacks.....	.35
Telephone Plugs.....	.65
Bus Bar Wire, per foot.....	.015
Spagetti (any color), per length.....	.07
Single Coil Mounting.....	.35
Double Coil Mounting.....	2.00
Triple Coil Mounting.....	2.50
All Atwater-Kent, Radio Corporation of America, Fada, DeForest, Dubilier, General Radio and Brach merchandise—Special prices on inquiry.	
We also carry in stock at all times all parts for Flewelling, Reinartz, Reflex, Cockaday, Hazeltine-Neutrodyne, Mawhinney and Armstrong Super-Regenerative Circuits.	
All merchandise guaranteed by both the manufacturer and ourselves. Will be shipped upon receipt of purchase price, including postage.	

Radio & Mechanical Trading Corporation 23 WARREN STREET, NEW YORK CITY

DON'T PASS THIS-BUY

World Radio Batteries SAVE YOU 50% WRITTEN 2 YR GUAR

Every World User Is a Booster WRITTEN 2 YEAR GUARANTEE

Because you deal direct with a manufacturer who is responsible for the performance and quality of the Battery.

World Radio Batteries

6 Volts—40 Amps.,	6 Volts—80 Amps.,
\$8.50	\$12.50
6 Volts—60 Amps.,	6 Volts—100 Amps.,
\$10.00	\$14.50
6 Volts \$16.00	120 Amps.

Full Rating Guaranteed
MAIL YOUR ORDER TODAY. WE SHIP EXPRESS C. O. D., SUBJECT TO INSPECTION, OR WILL ALLOW 5% FOR CASH WITH ORDER. ALL ORDERS SHIPPED SAME DAY AS RECEIVED.
WORLD BATTERY COMPANY, 60 E. Roosevelt Rd., Dept. L, Chicago, Ill.

Radio Receiving Sets

Zenith 1-R Receiver and 2-M Amplifier

As another of the series of standard receiving sets, Radio Digest presents herewith the photo diagram of the Zenith 1-R Receiver and 2-M Amplifier, manufactured by the Chicago Radio Laboratory, Chicago. The set uses a three-circuit regenerative feed-back tuner, licensed under Armstrong patent No. 1,113,149. This is com-

combined with a two-stage audio frequency amplifier. The set has great selectivity and range, achieved by unusual departures in design. Operating instructions and description will be found on page six. Although the reader may not own a Zenith, points of similarity in standard receivers will repay him for studying the diagram.

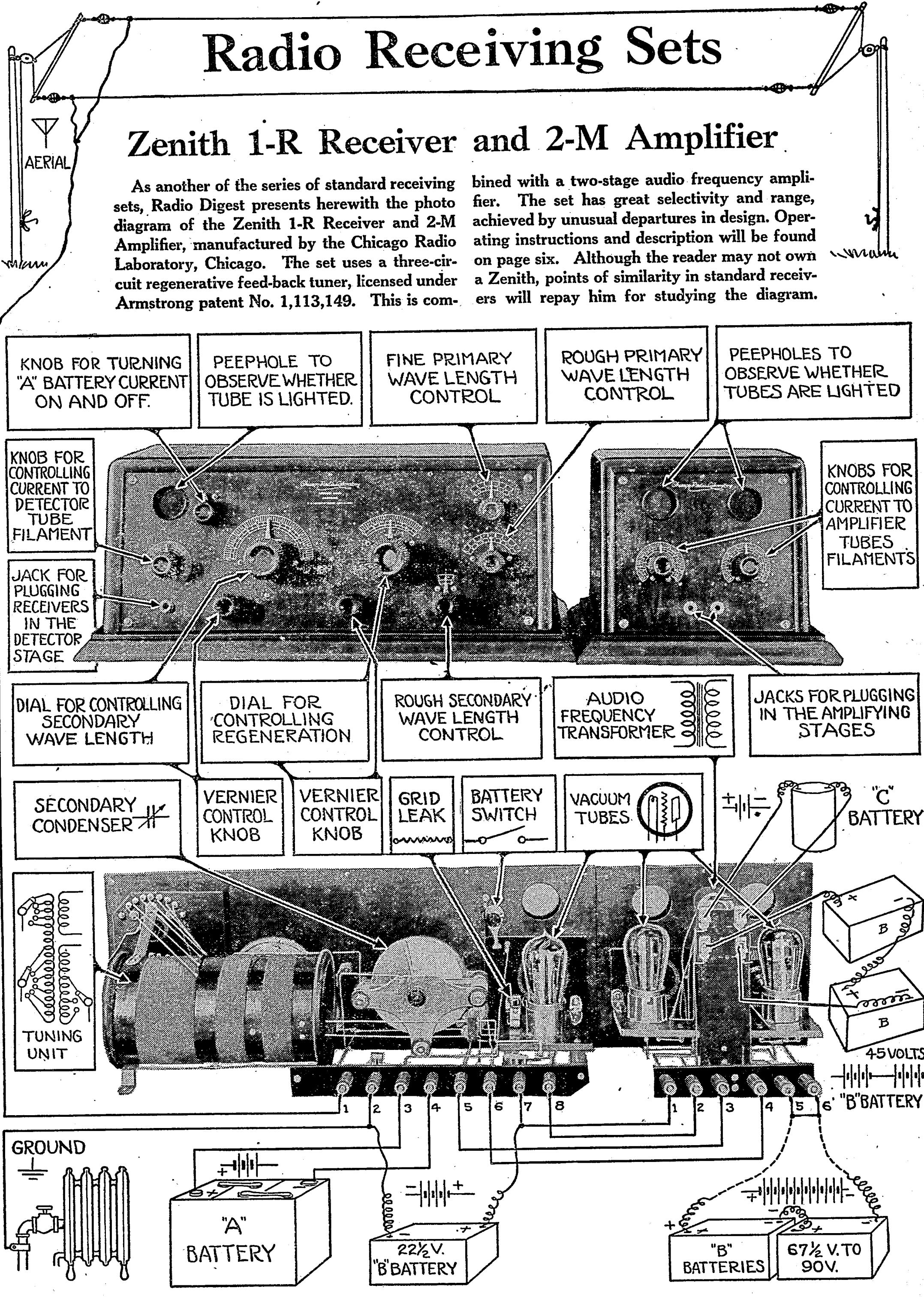

ADVANCE PROGRAMS

(Continued from page 4)

Old Refrain, "Valse Bluetto", Diana Miller; Accordian selections, S. R. Blum... WLV (Eastern, 309), 10:00 P. M., Musical program...

Friday, June 8

CFCA (Central, Daylight Saving, 400), 8:00-9:00 P. M., "The Chocolate Soldier", Star Orchestra; "O Love, from Thy Love", May Taylor...

Sunday, June 10

WBAP (Central, 476), 11:00-12:15 P. M., Church services, First Methodist Church, Rev. J. W. Berglin, pastor; Will Foster, organist...

Monday, June 11

WBAP (Central, 476), 9:30-10:30 P. M., Concert, Shrine Band; WDAE (Eastern, Daylight Saving, 395), 12:02-1:00 P. M., Organ recital, Stanley Theater...

When building your set it is advisable to put it up in sections such as tuner, detector and amplifiers. In this way one can do a lot of experimenting.

LOADING COILS

Add 100 meters to your wave length by inserting F. B. LOADING COILS in your circuit. Designed especially to enable you to tune in on the new wave lengths.

LIST PRICE 80c

FLANNER BRUCE MFG. CO. 304 West 130th St., NEW YORK CITY

VACUUM TUBES

No shortage here WD-11 and WD-12 \$6.20 UV-199 \$6.20 UV-201-A \$6.20 UV-200 \$4.75

WE REPAIR YOUR BURNT-OUT VACUUM TUBES—Quick Service WD-11-12 \$3.50 UV-201-A \$3.50 UV-200 2.75 UV-201 3.00

When sending Tubes for repair, include with your remittance parcel postage for one pound per tube. Tubes guaranteed equal to new. \$14.00 Supersensitive imported N&K Phones. Essential for DX work \$6.25

Abalene Radio 416 D Broadway New York, N.Y.

PORTABLE RECORDS? SEND 'EM IN—

By the Contest Editor

TO keep pace with the fast growing popularity of portable receiving sets and the use of them in the automobile, camp, on the beach, fishing trips and elsewhere, a new type of receiving record contest has been devised.

It is possible that one or more of the sets making the best records will be described in detail in the midsummer issues of the Digest. It is a popular superstition that Radio broadcasting is not a summer sport.

Portable Set Contest Rules

The rules to follow in the contest are but few and easily followed. They are:

- 1. Amateurs who are able to beat the records given, or who can claim with good evidence, distance receiving records of 300 statute miles or more for Radiophone broadcasting stations found in the "Broadcasting Station Directory," page 8, of three consecutive issues, may send in such records.

FLEWELLING ANSWERS

By E. T. Flewelling

(Editor's Note.—This department is written by Mr. Flewelling, the inventor of the famous super circuit. From the questions sent him each week, he picks the one considered most informative for all and answers it in this column.)

Connections to "A" Battery (Submitted by R. C. O., Detroit, Mich.) Question.—In reviewing and following your description in Part IV—Panel Layout and Wiring, issue of May 26, I note that the wiring diagram shows the rheostat in the positive side of the filament circuit while the negative is directly connected to the negative side of the B battery and the filament terminal.

Answer.—This question seems to have arisen in quite a number of instances, and for this reason it is chosen as this week's question. In the Flewelling Super Circuit the polarity of the A battery has no bearing on the action of the set; neither has the negative return of the B battery. The set will work just as well whichever way you may care to arrange the polarities.

Also the new UV-199. Moorehead Detectors 2.75 Moorehead Amplifiers 3.00 DY-6 or DY-6A 3.00 Also the new UV-199. NEW DX 1/2 VOLT TUBES \$4.00 All tubes guaranteed to work like new. Mail Orders Given Prompt Attention "24 Hour Service"

CUNNINGHAM TUBES REPAIRED

Table listing tube types and prices: C-300 or UV-200 \$2.75, C-201 or UV-201 3.00, C-302 or UV-202 3.50, C-201A or UV-201A 3.50, WD-11 or WD-12 3.50, Moorehead Detectors 2.75, Moorehead Amplifiers 3.00, DY-6 or DY-6A 3.00, Also the new UV-199 3.50, NEW DX 1/2 VOLT TUBES \$4.00

Mail Orders Given Prompt Attention "24 Hour Service"

RADIO TUBE CORP. 55 Halsey Street Newark, N. J. TUBES SENT PARCEL POST, C. O. D.

RADIO VIA PARCEL POST AT N. Y. PRICES

Standard Parts Only, in Original Packing NO SALVAGED GOODS SOLD Where "Money Back Policy Prevails"

Table listing radio parts and prices: PHONES For Parcel Post Ins. Add Dietzen 3,000 Ohm \$3.75 \$0.12, Brown Single (1,000 Ohm Pr.) 4.95 .09, Royal 2,200 Ohm 3.75 .12, COUPLERS Atwater Kent 6.80 .14, Freed Eiscman (180 Degree) 2.45 .09, All Wave (Genuine Capitol) 6.95 .18, VARIOMETERS Dayton 4.85 .12, VARIABLE CONDENSERS U. S. Tool 46-Plate Vernier 4.45 .24, U. S. Tool 21-Plate Vernier 4.10 .20, 3 Plate Vernier .95 .08, 23 Plate Vernier 2.95 .14, 43 Plate Vernier 3.45 .18, TRANSFORMERS (Audio Frequency) Acme 3.45 .14, TRANSFORMERS (Radio Frequency) Acme 3.45 .14, Cotoco 2.95 .12, Owl .95 .10, Sleeper 1.95 .10, MISCELLANEOUS Hydrometers .49 .08, Electric Soldering Iron 2.50 .15, Wave Trap 5.95 .20, Double Phonograph Attachment .65 .06, SETS Westinghouse, Jr. 6.95 .40, Westinghouse R. C. 79.50 1.80, De Forest Reflex D. T. A. 112.00 1.80, Aerex Crystal Set 7.95 .45, Victor Single Tube, completely assembled 12.50 .45, RHEOSTATS Klossner Vernier 1.25 .14, Bradleystat 1.49 .10, SOCKETS Bell V. T. & W. D. 11 .89 .10, V. T. Bakelite .50 .10, LOUD SPEAKERS King Amplitone Horn 4.95 .28, Pathie 17.50 .50, Reflex 9.85 .30, TUBES Welch Peanut Tube 2.00 .10, U. V.-200 4.95 .15, U. V.-199 6.50 .15, U. V.-201-A 6.50 .15, W. D.-11 6.50 .15, Sterling 1 1/2 3.95 .15, Marco 1 1/2 V. (2 Element) 1.00 .15, De Forest D. V. 6A 6.00 .15, CABINETS (In White) 7x10 1.45 .20, 7x12 1.65 .25, 7x14 1.85 .30, 7x18 2.15 .40, 7x21 2.45 .45, 7x24 2.95 .50, LIGHTNING ARRESTERS Argus, Outdoor or Indoor .95 .12, DIALS 2-inch (Bakelite) .25 .06, 3-inch (Bakelite) .35 .08

1500 Miles On One Tube Set

Complete parts for Regenerative Receiver. We hear Havana, Cuba, regularly on this receiver. It consists of the following standard parts: 1-180° Varlocoupler; 1-23 plate DX Variable Condenser; 1-Freshman Var. Grid Leak and Condenser; 1-Rosco Socket; 1-Klossner Vernier Rheostat; 1-Fada Switch Lever; 14 Switch Points; 2 Switch Stops; 8 Binding Posts; 1-7"x9" Radion Panel; 1 Mahogany Cabinet; 2-3" Dials; Copper Shield for Panel; Bus Wire; Tube Solderant, and Connecting Diagram. Mailed Postpaid for \$12.85

Above outfit completely assembled and wired, ready to "Listen In." Mailed postpaid for \$17.95

FREE Secure U. S. Army Diagram of one tube set. Eliminates static, battery capacity and placed in the hands of the radio fan. Send 2c stamp for mailing. Hurry up. Everything guaranteed as firsts. Money orders or checks. We pay postage.

RADIO SUPPLY STORES 254 West Stiegel St. Manheim, Pa.

The latest and most essential part of an efficient tube set

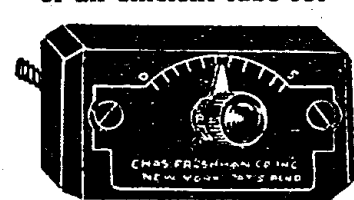

Variable Resistance Leaks FOR PANEL MOUNTING

Mounted on any panel in a few seconds—2 screws serving as connections behind panel.

Get stations you never heard before No pencil markings—assure unbroken range of 180 degrees. Clarifies signals—eliminates hissing.

Complete with either .00025 or .0005 mfd. Micon Cond. \$1.00

Without Condenser .75c

At your dealers—otherwise send purchase price and you will be supplied postpaid.

Chas. Freshman Co. Inc. Radio Condenser Products 106 Seventh Ave. New York

Saturday, June 9

CFCA (Eastern, Daylight Saving, 400), 8:00-9:00 P. M., "The Gondollers", Star Orchestra; W. R. Curry, bass; "Nocturne", Harry Adaskin, violinist; "Air de Ballet", Star Orchestra; "The Two Grenadiers", W. R. Curry, bass; "Caprice Viennois", Harry Adaskin, violinist; "Wine, Woman and Song", Star Orchestra; W. R. Curry, bass; Lorraine Star Orchestra.

Build Your Own HAZELTINE NEUTRODYNE with FREED-EISEMANN Licensed Essential Parts Complete wiring diagram, instructions, etc. sent in special container with patented essential parts. Three NEUTROFORMER COILS mounted on variable condensers, and DOUBLE NEUTRODON (as illustrated), sent for \$21.50. Ask your dealer to show you these parts, as well as complete assembled five-tube Neutrodyne Set in mahogany cabinet, Model NR-5, \$150.

Modell's ESTABLISHED 1889 191 Fulton St., Dept. F-16, New York City 9 New York Stores America's Greatest Radio Mail Order House

Radio Digest

Illustrated

REG. U. S. PAT. OFF.

Published by the Radio Digest Publishing Company, Inc.
123 West Madison Street
Telephone State 4844-4845
Chicago, Illinois

E. C. RAYNER, Publisher
Chas. F. Smisor, Editor Evans E. Plummer, Managing Editor
Harry J. Marx, Technical Editor

Eastern Representative, Jacob Miller, Times Bldg., Times Square,
New York; Telephone Bryant 4909

Pacific Coast Representatives
E. J. Wood, 251 Kearney St., San Francisco
Telephone Kearney 1472

H. M. Morris, 417 Western Mutual Life Building, Los Angeles
Telephone 12011

58
PUBLISHED WEEKLY

SUBSCRIPTION RATES
Yearly.....\$5.00 Foreign.....\$6.00
Single Copies, 10 Cents

Vol. V Chicago, Saturday, June 9, 1923 No. 9

Build Your Own Set

Learn the Why With Simple Apparatus

THERE is no reason for buying an expensive set to start with and, in fact, it is much better to begin by buying parts and assembling them. In this way one learns the why and wherefore of each part and its relation to the others. It is much more pleasant to rig a simple outfit and to get results than to fuss with a complicated set and get no results.

Radio work offers to the younger mind a tremendously valuable developer of logical analytical thinking more effective than school-book methods because this object is accomplished while affording entertainment.

After one has become able to operate his set and get good results from it, he can then entertain the rest of the family and even his friends. On account of so many stations broadcasting one can just about choose his programs, once he has them in advance.

Range of Receiving Set

Reception Due to Local Conditions

WHEN consideration is given to the distance a transmitting station will radiate signals or to the operating radius of the receiving set it is important to make a distinction between the reliable range and the variable or occasional range.

The range of a receiving set depends in a large measure upon the local conditions, whether it is located in an open country with but few interposing obstacles to absorb the Radio waves or whether it is surrounded by lofty buildings constructed with framework of steel.

The simple, well-constructed receiver employing a crystal detector and using a single wire outdoor antenna approximately 100 feet in length elevated at least 20 feet above the ground has a daytime range of about 25 miles while at night signals from much greater distances are easily received.

If the crystal detector is replaced by a vacuum tube detector the reliable operating radius of the set is increased to approximately 75 miles and there is considerable improvement in the receiving qualities due to the sensitive properties and amplifying action of the tube which secures louder music or speech. A simple regenerative receiver using an outdoor antenna will cover a distance of approximately 100 miles.

Better Equipment for Summer

Distance Reception Proving Good This Year

MANY people will be able to obtain more real enjoyment and benefit from Radio this summer when, of course, they have more spare time, and on their vacations than in the winter months. Thousands of sets will be taken on vacation trips. Radio today is far different than it was a year ago and the Radiophan will find more things in his favor this summer than last.

Last year few persons would believe that the voice could be transmitted four or five thousand miles. Today they are entering on a new field of Radio and sets are being made that will receive from stations thousands of miles distant, while a few hundred miles was the limit of a year ago.

Then several hundred dollars was paid for sets that could not be sure of receiving broadcasts over five hundred miles. Now, less money will buy better sets able to reach from coast to coast.

The receivers used a year ago would pick up everything in the air for a short distance and would not tune out interference. Sets are now procurable that will single out almost any station while scores of other stations are broadcasting. Then again, the new wave allocations put into effect May 15, have aided the solution of the interference problem.

Any person who has a chosen set in his mind and is waiting until next fall before making the purchase, is sure going to lose many interesting hours of real enjoyment this summer. But those with keener judgment will first make inquiry about what now may be expected in range and clearness of reception of broadcasting with a properly constructed set during the summer months. A keen interest is bound to continue throughout the summer.

RADIO INDI-GEST

INDIGEST BROADCAST PLANT SOON BEGINS TO START TO COMMENCE

WALLA WALLA.—The handsome and sanitary new broadcasting station owned by INDIGEST is now ready for operation and will soon be heard on the set wave length of 99 2/3 feet. This new quick-service free air station will be operated on a cut-rate policy and will give broadcasting service day or night. It is located on the picturesque little island of Walla Walla (the natives liked the place so well they named it twice), a tropical land that lies in the midst of the great damp Pacific ocean.

The new plant is the most modern to be erected in a radius, as the crow flies in circles, of 7,000 miles and as there is no other station within 9,000 miles there will be no interference. The powerful transmitting apparatus has a range of 3,000 cubic miles. The closest habitation to Walla Walla is 10,000 miles so it should be easily heard by those that tune to the proper wave length.

A unique plan is to be put in effect to enable the listeners to tune in properly before the regular weekly programs are broadcast nightly once each month. For five minutes before the station's generator is started or the antenna is raised the announcer will commence to scream, "Help!—Fire!!—Murder!!! If you hear these frantic cries for succor do not become dismayed or alarmed for it is merely Indigest's method of letting you tune in before the station begins operation.

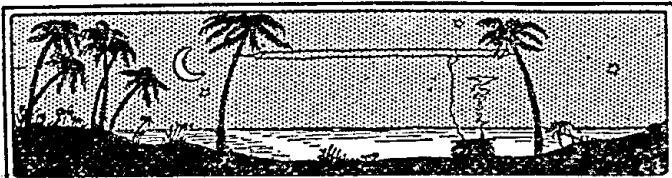

Above Photo Is Flashlight of Our New Station

The first of the series of weekly programs will be put on the ozone promptly at 11:33 (Walla Walla time) Wednesday, June 31. Remember that Walla Walla time differs from ours as they have a nineteen-hour day and the time can be reckoned as being the square root of Central time divided by 0.71144, or just exactly three days, twenty-three hours, fifty-nine minutes and sixty seconds behind or ahead of Central-Pacific time, daylight saving, 3% interest plan.

The program to be given Wednesday, June 31, will appear in Indigest next week.

A PROBLEM IN SELECTIVITY

Jack Spratt installed a Radio,
Connected up his phones,
And listened in with wife and kids
To hear the Broadcasts tones.

But Mrs. Spratt likes Classic Themes,
The kids, a bedtime yarn;
While Jack himself likes Jazzy Stuff;
"The rest ain't worth a darn."

They can't agree on what is what
But live in constant wrangle;
Ain't this a doggone problem
For Hoover to untangle? —Eazy Lane.

Read Indi and You'll Find Out

Dear Indi: Here's one I lamped in WOC's program sheet—
"A listener in had a sleepy-looking parrot which he kept as a pet in the same room with his set. One day while the receiver was tuned in on a station he was called out of the room to answer the telephone. A few seconds after he had left the loud speaker broke forth in a clear tone, 'Hello!' This was repeated several times, the parrot paying not the slightest attention. At the final 'Hello!' the bird opened one eye, gazed at the set, and snapped out, 'H—I, man, the line's busy!'"
P. S.—Do I get in with this one? —POLLY W.

LEM STEBBINS DEGENERATIVE SET VICTORS GET \$000,000,000,000.19

The great Indigest \$000,000,000,000.19 Cash Copper Contest was officially closed at midnight sharp one noon some days ago. The prize winners were selected and each has been mailed their checks to cover the amount awarded them. Lillian G. was selected as having the best all around paper and was awarded the first prize. Ezra Hecht won second, Polly W. nabbed third honors and Alagonquin Tonsils III came in fourth. Fifth, sixth and seventh prizes were awarded to Spider Webb, who sneaked in three separate papers.

This will serve to notify the prize winners that they are requested to hold the checks sent them until such time that we notify them we have enough money in the bank to cover same. Lem Stebbins is overmodulated with the novel methods of obtaining his sooper effect, and has immediately taken out patent papers on all the circuits which the contest brought in.

Here lies Sammie
James Henry DeFinn,
Two lovers were talking
— he listened in.

My Yes! They Plant It by the R. R. Tracks

Indi: I garnered this from Station WOC:
"—P. W. E. signing off in the state where the tall corn grows at exactly 8:22 P. M."
Is the corn on a schedule, too? —LE MOQUEUR

You Should Call Him to Time

Dear Mr. Gest: I gotta friend who is regular jazz hound. Personally, I like grand opera once in a while, and am particularly fond of the "Dance of the Hours," from La Gioconda. I told this J. H. to look out for it, so last night he says, "C'mere, I just tuned in one of your 'Dances of the Hours.' I put on the fones and whaddya think I heard? 'Three O'clock in the Morning!'"
Come to think it over, he was sorta right at that, but—
Well, you know these Jazz hounds. Yours disrespectfully
—ELLIS BROAKLEWSE

Looking Ahead

In Next Week's Issue of Indigest Will Start "The Quest of the Kanooofs." This beautiful poem is filled with pathos and melodrama to the point that it is overrunning with tears. If you want a good cry for a dime, get Indigest from your most gorgeous newsdealer—10c.

Around the World with Radio

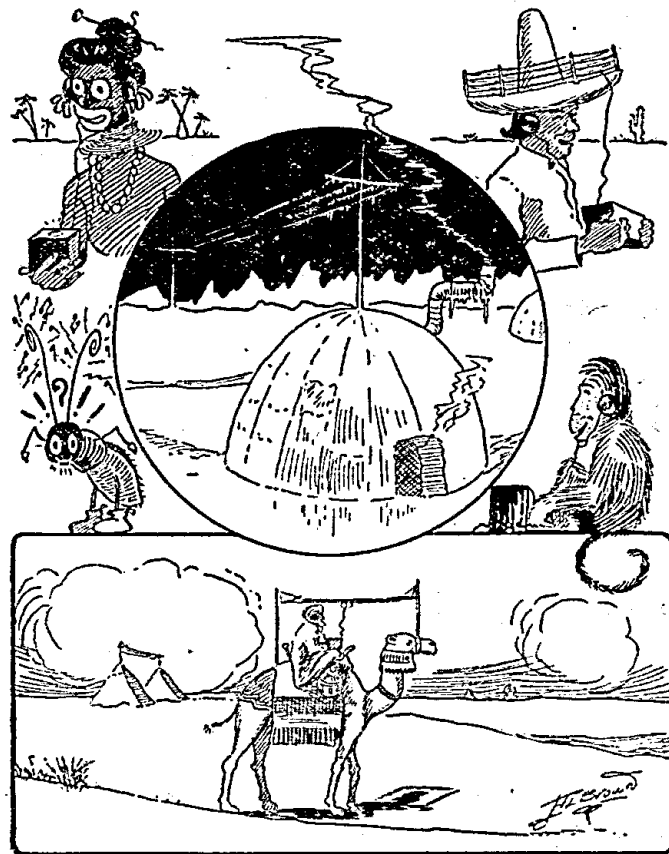

Condensed

By DIELECTRIC

Outside antennae are still the vogue among thousands of Radio fans and it is doubtful if the indoor loop will supplant them altogether. Where an aerial is strung in a position to be easily destroyed by a vengeful and irate landlord, he may do it—but look out for judges like Judge Schwaba of Chicago. His conception of home appurtenances places aerials within the safety zone, so far as malicious destruction subject to punishment is concerned. Score one!

We all have had a chance to try out the new broadcasting plan by this time. It remains now to hear from the bugs as to their opinion of it. Some I have heard complain that there are still too many broadcasting stations and that these should be reduced to say two large ones in a district, one for the highbrows and one for the—netherbrows. The rest of us are very much enthused with the distinct gain on noninterference. When one large station was sending out its program (which it did from morn 'til night), no other station on the same wave length could be heard nor distant ones on any wave. Now we can hear them when desired and cut them at will. Thanks be for this!

I had lost hope of finding any excuse to mention opera again until next fall, but behold what has taken place in the studio of Station KPO! From their transmitter has come the first broadcast of an entire opera along the whole of the Pacific coast. It was a distinctively domestic product as both librettist and composer are native Californians; however, the audience was most cosmopolitan including listeners in all parts of the country. It was well worth hearing, too.

The Canadian amateurs had a little hard luck recently when they first tried for a relay across the continent during the three-day test. QRM was right on the job in what is thought to be the form of the aurora borealis. This famous phenomenon has been known to serve in that capacity before now. It is just the chance of running afoul of QRM that makes the sport so fascinating. You never know when you'll accomplish what you set out to do.

We may detest Germany with all our hearts—and they have proven themselves worthy of it as a nation—yet it is a fact that among them are some very clever scientists. A recent witness to this is the reported discovery of a means of forcing airplanes to light by employing Radio waves of certain characteristics. The French are much disturbed at the news. We managed to find out the secrets of quite a few German inventions during the World War. We may get this one.

You know there are some folks who think it a crime to go to the circus or a prize fight, so they lead their small boys there to show them how awful these things are. Since the coming of Radio has permitted members of this class to listen to the jazziest jazz, the vodevillian's jests and the exciting descriptions of prize fights in the seclusion of their own homes, they feel much better. They were all listening to the Jess Willard and Firpo bouts I'll wager a new call. Folks were discussing the fight within ten minutes after the finish in towns miles away from the arena. Radio does that.

Not all of the distance records were made during the winter months when conditions were thought to be the most favorable. An amateur station in Connecticut was sending through the ether a short time ago and his message was picked up about one hundred miles from Ceylon, India. That is pretty good for a record, about 11,000 miles.

First Steps for Beginners in Radio

Chapter IV, Part II--About Condensers and Inductances

By Thomas W. Benson, A. M. I. R. E.

AN INDUCTANCE is characterized by its ability to produce currents by induction within itself or self induction. All current carrying conductors possess self induction due to the fact that all currents are surrounded by a magnetic field of force. Any variation in the strength of the field will induce a current in any conductor in that field. A straight wire will be found to have self induction due to the fact that any variation in the field around that wire while carrying a current will induce current in the wire since it lays in the field of the magnetic lines.

Inductive Effect

When the wire is wound into a coil the inductive effect, resulting from a change in the lines of force is increased many fold and we then have what is termed an

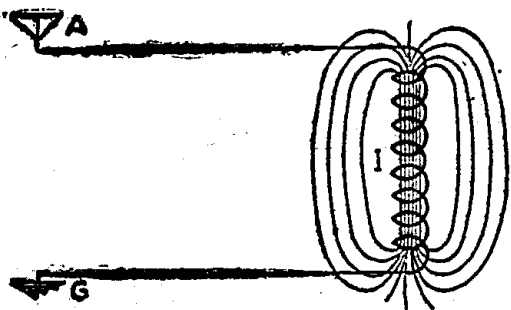

Figure 19--Effect of Connecting Inductance Into a Circuit

inductance. And to understand how an inductance tunes a Radio circuit we must have a knowledge of what takes place in the inductance.

Let us then consider Figure 19 which shows an inductance I connected to an aerial A and ground G, the latter two forming a condenser as described previously. Let us assume that a Radio wave induces a positive charge on the aerial and current starts to flow. As the current starts through the coil it begins to build up a magnetic field. As this field takes form it cuts some of the turns of the coil. We have learned that when a magnetic field cuts or passes over a conductor it induces a current, hence, a current will be induced in the turns of the coil during the formation of the field around it. However, it will be found that the induced cur-

BEGINNERS will find the accompanying series by Mr. Benson very helpful in learning the rudiments of the popular science of Radiophony. The articles yet to appear are:

Chapter V--Tuners and How to Tune Your Set.	Chapter X--Audio Frequency Amplification.
Chapter VI--About Crystal Detectors.	Chapter XI--How Super Regeneration is Accomplished.
Chapter VII--Tube Detector Theory and Operation.	Chapter XII--Reflex Circuit Operation.
Chapter VIII--The Regenerative Detector.	Chapter XIII--About Headsets and Loud Speakers.
Chapter IX--Radio Frequency Amplification.	Chapter XIV--Batteries Used in Radiophony.

due to the self induction of the coil is to overdischarge the aerial-ground condenser and the current will start to flow in the reverse direction. The above action of first holding back the current and then helping it along will be repeated and an overdischarge results again but to not as great an extent. In this way the current will flow back and forth and the circuit is said to be oscillating.

It is quite apparent that the time it takes for the current to reach its full value after starting to flow and the time the current flow is prolonged by the self induction will depend upon the amount of this self induction. This in turn will depend upon the number of turns in the coil cut by the rising and falling of the magnetic field. We see then that increasing the turns increases the self induction in the circuit, and thus it takes longer for one complete cycle of charging and discharging of the condenser.

Tuned Circuit

Now going back a little. We considered that a wave induced a positive charge on the aerial and this flowed through the inductance and the aerial became over discharged and a negative charge was built up on the aerial. Now if the incoming waves are of such a length that they tend to put a negative charge on the aerial at the same instant that the currents due to self induction does, the total current will be increased and each succeeding oscillation of the circuit will be in time with the incoming waves, and we say the circuit is tuned to that wave.

Were we to add inductance the time for one discharge of the aerial would be increased and before it was entirely discharged the waves would have induced a negative charge on the aerial which would neutralize the positive current still present and the current flow reduced. The circuit is then out of tune. Reducing the inductance would have a similar effect only the aerial would have discharged once and started to oscillate back again before the wave had a chance to put the negative charge on the aerial and the current would never reach its maximum value because the circuit is out of tune

with the wave length. Thus we see how the inductance tunes a circuit but this will be taken up more in detail in the next chapter.

Measuring the Inductance

To measure this self induction we use the unit called the henry. A circuit has an inductance of one henry when one volt

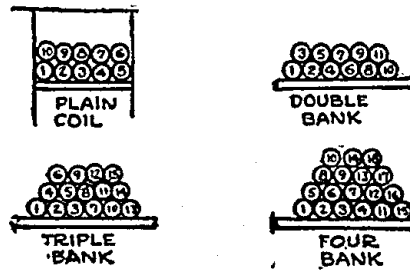

Figure 21--Various Types of Bank Windings

is induced in it by a current change of one ampere per second. Here again we have a unit too large for practical purposes so use is made of the millihenry or one thousandth of a henry. A smaller unit is also in common use, the centimeter or as it is abbreviated cm, which is the one-millionth part of a millihenry.

Forms of Inductance

Inductances take many forms and it is advisable to be acquainted with the va-

rious forms they take and their suitability for a given purpose. The simplest form of inductance is a single layer of wire wound on an insulating form, usually a tube. This form of construction is entirely suitable for short wave lengths but in order to vary the amount of inductance in the circuit taps are taken from the winding.

There are two methods of tapping, one being to take taps evenly spaced over the length of the coil for rough tuning and relying on a variable condenser to get sharp tuning as shown in Figure 20. The condenser may be connected in parallel or series to get the fine variation. Another method of tapping is to tap single turns for 8 or 10 turns and then tap in sets of 8 or ten turns for 7 or 9 sets, respectively. With this arrangement rough tuning is done with the 8 or 10-turn switch and fine tuning with the single turn switch to get intermediate values. As a rule a variable condenser is unnecessary when a single turn tap switch is used in tuning.

Windings on a Coil

For the sake of compactness it is often desirable to make the inductance smaller and a number of methods are employed to accomplish this without adding distributed capacity to the coil. We have learned in the preceding part that two conductors with a difference of potential form a condenser.

Were we to wind a coil as shown in Figure 21 with the turns wound as numbered there would be an appreciable voltage difference between say turns 1 and 10 resulting in a capacity being formed that will by-pass some of the current and reduce the strength of the magnetic field of the coil. To overcome this and reduce

(Continued on page 14)

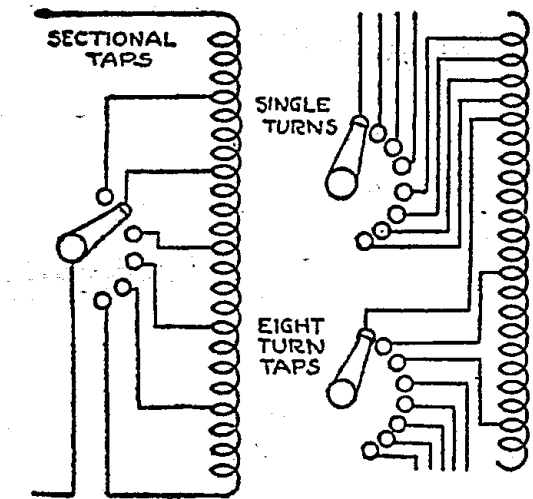

Figure 20--Two Methods of Varying Inductances with Taps

rent opposes the current in the circuit and thus delays it reaching its full value immediately.

Now let us assume that the charge induced on the aerial has finally all flowed through the inductance to ground. The magnetic field will then begin to collapse and the movement of the lines will cut the turns of the coil again and another current will be induced. However, the latter current will be in a direction similar to that from the aerial and will tend to prolong the current flow.

Oscillating Circuit

The effect of this last current surge

Don't just ask for a Head Set-- Say:

DICTOGRAPH

Choice of experts

Sold by all Responsible Dealers & Department Stores

DICTOGRAPH PRODUCTS CORP.
220 W. 42nd St., New York

New CARTER Vernier Control RHEOSTAT
Simple, positive, distinctive, reliable. Satin silver finish; clock spring digital connection insures positive and reliable operation.
Code 1, 6-ohm, for U. V. 200 tube... \$1.50 ea.
Code 1-C, 20 ohm, for U. V. 201-A tube... 1.75 ea.
Code 1-D, 30-ohm, for U. V. 199 tube... 1.75 ea.
Write for Bulletins of Carter Products
CARTER RADIO COMPANY
209 S. State St., CHICAGO

FORMICA
A Laminated Phenolic Condensation Product
SHEETS TUBES RODS

RADIO PANELS
POLISHED BLACK FINISH

CUT PERFECTLY SQUARE TO ANY SIZE

1/32" THICK	1/2¢ PER SQ. INCH
1/16" THICK	3/4¢ PER SQ. INCH
3/32" THICK	1¢ PER SQ. INCH
1/8" THICK	1 1/2¢ PER SQ. INCH
3/16" THICK	2¢ PER SQ. INCH
1/4" THICK	2 1/2¢ PER SQ. INCH
3/8" THICK	4¢ PER SQ. INCH
1/2" THICK	5 1/4¢ PER SQ. INCH

SEND FOR COMPLETE PRICE LIST
PROMPT ATTENTION TO MAIL ORDERS
DEALERS PRICES ON APPLICATION

STARRETT MFG. CO.
519 SOUTH GREEN ST. CHICAGO

PATENT APPLIED FOR

Michigan Split-Hair Vernier Dial Adjuster

The Key to Selective Tuning--The Secret of "Michigan" Supremacy

Want to pick up any station at will, in a moment, without hunting all over the map?

"A Michigan "Junior" or "Senior" Regenerative Receiver, with the Patented Split-Hair Vernier Dial Adjuster Will Do It

This is only one of many exclusive features of "Michigan" Regenerative Receivers. They are licensed under the Armstrong U.S. Pat. No. 1,113,149 and pending letters pat. No. 807,388, covering the highest development of *Regeneration* -- the *only* means to clear, long-distance reception.

When you write, give us the name of your favorite Radio Dealer, as we want to tell him about our *Exclusive M. R. C. Franchise* which will put him in *control* of the whole Radio Situation in his territory.

MICHIGAN RADIO CORPORATION
GRAND RAPIDS, MICHIGAN

A LARGE TWO COLOR MAP
Size 25x38 inches, showing the location of all the broadcasting stations of United States and Canada, their wave lengths, exact geographical position, change of time area, amateur radio districts, etc., etc. Also a complete list of call letters (listed alphabetically) of all the broadcasting stations, bound in a separate cover.
(Mailed on the Receipt of 25 Cents in Coin or Stamps)
Walter B. Spiegel, 45 Vesey St., New York City

Long Distance Single Tube Receiver

Connections Similar to the Ultra Audion

The accompanying hook-up is one which has given excellent results. The variable condenser is connected in series with the inductance, plate and filament circuits

WORKSHOP KINKS? EARN A DOLLAR—

THERE are many little kinks worked out at home that would aid your fellow Radio worker if he only knew about them. There are new hook-ups, new ways of making parts and various unique ways of operating sets that are discovered every day. Radio Digest is very much interested in securing such material. Send them in with full details, including stamped envelope so rejected copy may be returned. The work must be entirely original, not copied.

RADIO KINKS DEPARTMENT,
Radio Digest
123 West Madison St., Chicago, Ill.

somewhat like the ultra audion. I have heard local stations on a horn with just one tube. In colder weather I have copied KFI and KHJ, both 1,900 miles away on an aerial 65 feet long and only 20 feet high.

After adjustments are made, tuning can be accomplished with either the rotor or condenser. The rotary side of the variable condenser should be connected to the ground to eliminate body capacity.—J. W. Mayfield, Cincinnati, Ohio.

Spider Web Coils on Cabinet Ends

Spider web coils are shown mounted on the end of a cabinet. One of the coils is mounted with hinges attached to the cabinet. The other is fastened to the edge of

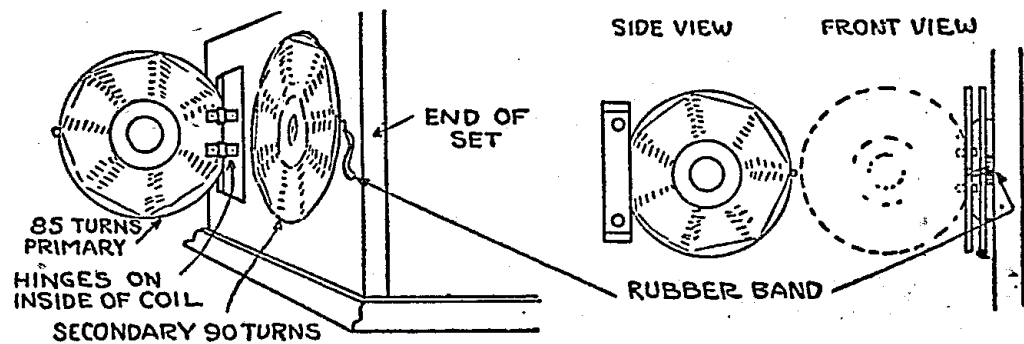

a square piece of wood so that the hinges are at right angles to the cabinet.

Both of the coils fold against the cabinet and a rubber band fastened to the cabinet slips over a stud on the outer coil and it holds them flat against the cabinet end.

This set of coils cost me 45 cents with hinges and they have given me an efficient tuning set.—C. W. Woodside, Calgary, Canada.

Measuring Condensers

Wishing to measure the capacity of some condensers which were unmarked with the capacity when I bought them I happened to think of connecting a tuning coil into a wave trap, as shown in the circuit A. This is a circuit usually recommended for a wave trap. With ten coils on a 4-inch tube it took .00025 mfd. capacity. I next connected in a .0005 mfd. condenser when it took two or three coils. As two or three coils was not sufficiently

SERIES CONNECTION OF CONDENSER

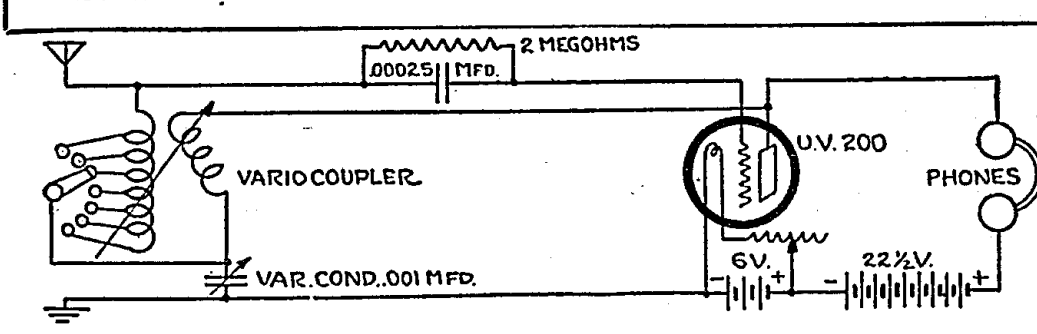

sensitive I thought of the scheme as shown in B. This was better and the relative capacities and number of turns on a 4-inch tube were as follows:

.0001 mfd.	54 turns
.0005 mfd.	25 turns
.005 mfd.	10 turns
.006 mfd.	9 turns

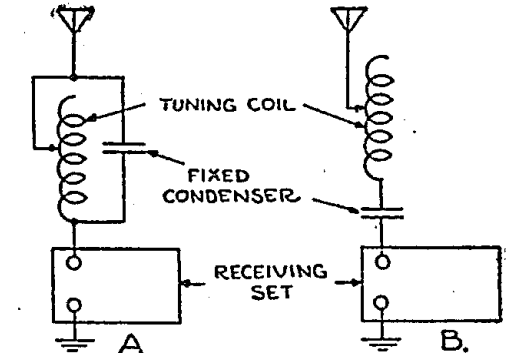

The broadcasting came in just as clearly through this series wave trap as it did through the parallel one except with the .0001 condenser. This would show that a 50-turn honeycomb coil with a 23-plate condenser in series with it would make a splendid wave trap. It would also be much more effective than the parallel or shunt type on account of having more coils or inductance to hold back the waves

Beginners' Aids

To obtain the most out of a newly-purchased receiving set, it is necessary to learn a few rudimentary principles of operation. What to do and what not to do should be memorized.

If you have a crystal detector, keep the fingers off the mineral. Handling it leaves a greasy surface and it is more apt to collect dust. It is best to keep it covered and if you must handle the crystal, do so with a pair of tweezers.

Don't attempt to find out what is inside of your head receivers. Many poor results can be traced to the fact that the individual was too inquisitive and opened the receivers by unscrewing the caps. In doing so, you will bend the diaphragms and almost surely ruin the phones. The diaphragms are made of very thin metal and are easily bent if handled. You may also injure the winding, as it is wound with wire as fine as hair.

If you have purchased a complete set, don't handle it roughly, as you may loosen a connection inside the cabinet.

Don't try to change any of the wiring if you are unfamiliar with the working of it.

Shielding Panels

In the shielding of a panel it is only necessary to shield the parts of the panel that house the tuning controls, such as the variometer, variocouplers or tuners. The detector and amplifying units do not have to be shielded. In some of the commercial sets the units are shielded separately. There is a separate shield for each variometer, tuner and condenser.

Three Honeycomb Coils Used on a Crystal Set

The accompanying diagram shows a hook-up which I have recently developed. It is far superior to any other crystal hook-up I have ever tried. In this hook-up spider web or honeycomb coils are used

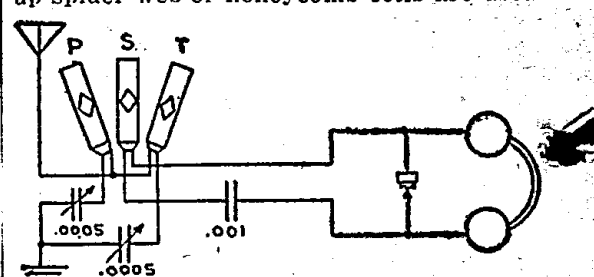

in conjunction with a crystal detector. I had been troubled with interference until I found that this hook-up eliminates it quite well.—Leo Schechter, St. Louis, Mo.

Testing for Open Circuit

The windings of the amplifying transformers may be tested for open circuits by means of a telephone and a single dry cell. The absence of a click or a very faint click when breaking the circuit indicates that the winding is open.

SOMETHING NEW

A real loud talking detector made of "B" Metal, 100% superior to any crystal. Puts new life into your set. Guaranteed for one year. It's the cheapest in the long run.

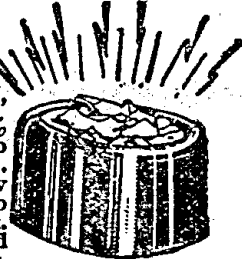

50c

Sold by all live dealers, or can be ordered from the
B-Metal Refining Co.
3134 Trumbull Ave.
Detroit, Mich.

wanted. It is necessary to have one condenser whose capacity is known. Having obtained the constant you can use it to measure an unknown one. $N^2C = \text{constant}$ (approximately). This formula was used to measure the condensers. N = number of coils. C = capacity.—D. W. Starkey, Chicago, Ill.

REFLEX
Erla Reflex Transformers
DEALERS: SEND FOR LITERATURE
HUDSON-ROSS
123 W. Madison St. Chicago

WILLARD
WILLARD RADIO COMPANY
Dept. R. D., 291 Broadway,
New York City
"The Best for Less"

REINARTZ CIRCUIT EVERY PART COMPLETE
1 Reinartz wound coil, 1 tube socket, 1 rheostat, 1 23-plate .0005 MFD. variable condenser, 1-13-plate .00025 MFD. variable condenser, 3 inductance switches, 16 switch points and nuts, 4 switch stops and nuts, 8 binding posts, 2 3" dials, 1 variable grid leak, 1 .002 MFD. phone condenser, 23 feet bus bar wire, 1 high-grade panel ALREADY DRILLED AS PER DIAGRAM and complete instructions. **\$10.00**
Two-Stage Audio Frequency Amplifier—Parts complete in every detail for this Circuit—\$11.00

CONDENSERS	
3 Plate Variable; value, \$1.75.....	\$1.05
13 Plate Variable; value, \$2.50.....	1.20
23 Plate Variable; value, \$3.50.....	1.35
43 Plate Variable; value, \$4.50.....	1.85
13 Plate VERNIER; value, \$5.50.....	3.75
23 Plate VERNIER; value, \$6.00.....	4.00
43 Plate VERNIER; value, \$6.50.....	4.25

Honeycomb Coils, 50 turns mounted, \$0.95
Honeycomb Coils, 75 turns mounted, 1.00
Double Coil Mountings..... 2.45
Triple Coil Mountings..... 3.35
Reinartz Coils and Mounting..... 1.45

VARIOCOUPLER—Celeron Condensite and Litz Wire Wound Secondary; Value \$4.50. Special.....	\$2.95
AUDIO FREQUENCY TRANSFORMER—Designed for use with W. D. 11 Tubes, list, \$4.50; price.....	\$2.75
BALL BEARING INDUCTANCE SWITCH—value 75c, special.....	\$0.30
V. T. SOCKETS—Nickel, brass sleeve, composition base value, \$1.00; special at.....	.50
EXTRA SPECIAL—Telephone 3000 Ohms Handsets; \$9.00 value; reduced to.....	\$3.50
ALUMINUM LOUD SPEAKING HORN—Nickel plated, highly polished; \$8.00 list.....	\$3.75

FLEWELLING CIRCUIT EVERY PART COMPLETE
2 honeycomb coils, 1 2-coil mounting, 2 coil plugs, 3 .006 condensers, 1 variable grid leak, 1 grid leak, 1 23-plate .0005 MFD. variable condenser, Verner rheostat, 1 tube socket, 8 binding posts, 20 feet bus bar wire, 1 high-grade panel ALREADY DRILLED AS PER DIAGRAM, 1 3" dial and the Radio Digest Booklet on Operation and Construction of this Circuit..... **\$11.00**
Two-Stage Audio Frequency Amplifier—Parts complete in every detail for this Circuit—\$11.00

BEST QUALITY JACKS, Single Circuit; value, 65c; special at.....	\$0.30
Double Circuit; value, 90c; special at.....	.45
MULTIPLE POINT INDUCTANCE SWITCH with Knob and Dial (15 Switch Points).....	1.45
LIGHTNING ARRESTERS approved by underwriters.....	.90
THREE-INCH DIALS—Unbreakable—heat resisting composition—high finish; special.....	.30
TWO-INCH DIALS—Same design—for rheostats and potentiometer; special at.....	\$0.25
FILAMENT RHEOSTAT—Condensite base; value, \$1.10; special at.....	.70
FILAMENT RHEOSTAT with 2 1/2" dial; value, \$1.50; special at.....	.85
TELEPHONE PLUGS.....	.60
FRESHMAN VARIABLE RESISTANCE LEAK and MICON CONDENSER Combined.....	.75

A BEAUTIFUL "SALRITE" PENCIL FREE
SALRITE PENCIL
With every order of \$12.50 or more. Made of beautiful Mahogany Rubber, about five inches long. Equipped with vest pocket clip, 10 extra leads and eraser. Will write like a charm and last a lifetime. Only a limited supply available—so rush your order now.

Now is the time to build your own set to take with you on your vacation. We will be glad to offer you any information or advice that you may require. Just drop us a line.

Every article advertised above is guaranteed by the manufacturer and by us—Mail orders filled immediately—transportation PREPAID on all orders of \$5.00 or over east of the Mississippi River. All others include postage.

For Weeks You Have Been Reading of the Superior Advantages of
SPIDER WEB COILS
(Copyrighted)
EUGENE T. TURNEY is the inventor of Spider Web Coils and holds the only patent granted by the U. S. Government. TURNEY COILS are wound by Automatic Machines, on Bakelite Cores, and are taking first place in the Radio Field today. They are cheaper and more efficient than Duolateral Coils.

PRICES OF SEPARATE COILS
S. W. 10, 25 Turns, Enameled Wire, 66c
S. W. 15, 36 Turns, Enameled Wire, 65c
S. W. 20, 40 Turns, Enameled Wire, 70c

Turney's Spider Web Plex Tuner

Three Coils Combined Mounted on Bakelite Panel
PRIMARY
SECONDARY
TICKLER

Price Complete
\$4.50
With 4 Different Hook-ups (3 Tube and 1 Crystal)

At Your Dealers or Direct by Mail. Cash or Money Order (No Stamps or Checks)
We are the SOLE NATIONAL DISTRIBUTORS for Turney's Spider Web Coils
TRISTAN SALES CORPORATION
No. 1 UNION SQUARE NEW YORK CITY

Characteristics of Some New Vacuum Tubes

Part II—Tube Advice; UV-199, DV-6 and Philips Tube

By H. J. Marx

AMONG the multitude of letters received from fans working with the Reflex De Luxe is one that states: "Have constructed your Reflex De Luxe. The reception on a loud speaker is the

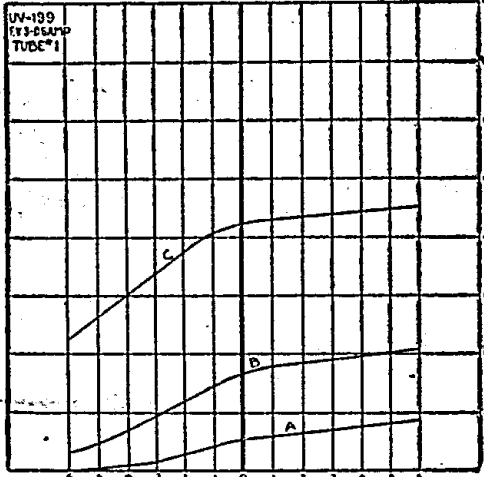

Figure 5

clearest and best in tone value ever heard. But I have the rheostats barely turned on. If I increase the current, the reception turns to howls and growls. Undoubtedly there is even greater volume in the set but I can't get it." This statement clearly indicates that the source of trouble lies in the tubes, inasmuch as the same experience was encountered by the author.

Tubes on Reflex Circuit

Especially in the reflex type—there is required a certain percentage of operating efficiency, if this is lacking in the tubes used, no amount of development or alteration of the circuit will remedy the situation. Reflexing with but a single tube does not present the difficulties that multi-tube reflex circuits do. The demand on that single tube is usually within the functioning limits.

Portable Set Tubes

The question of portability of receiving sets has developed a decided demand for a good dry cell tube. Unfortunately most dry cell tubes are either too microphonic, sensitive to mechanical vibrations of any sort, or their efficiency is doubtful. If it was not for the cost the best solution would be to purchase ten tubes of the type decided on and then test them for the selection of the three best. Dry cell tubes should always be cushion mounted, that is supported on either a rubber or felt pad to take up any shocks, bumps, or knocks, as much as possible.

Sockets and Rheostats

In order to be on the safe side it is best to use standard sockets and if neces-

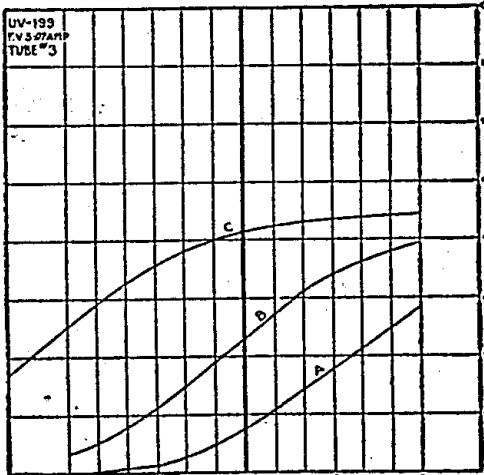

Figure 6

sary use adapters—then if a better tube is produced the chances are no socket changes will be necessary.

The subject of rheostats can also be easily taken care of. Manufacturers are now producing small unit resistances that can be added in series in the filament cir-

cuit, building up to any particular resistance value best adapted for the tube used, and enabling the use of the popular 6-ohm type of rheostat with which most sets are equipped. Rheostats are also being produced now that have a total of 30 ohms' resistance but are so constructed that they can be used in the same way as that of the 6-ohm type.

UV-199 Characteristics

This tube is rated at a filament voltage of three. The current consumption is exceptionally low, only .06 amperes. This permits its use with dry cells. A special socket is required, with a standard type of socket an adapter is necessary. The variable resistance in series in the filament circuit is recommended as 30 ohms. If a 6-ohm rheostat is used, a 25-ohm resistance unit should be added in series.

The plate-grid potential curves taken on three of these tubes were so far different from what was taken that more were tested, the two extreme sets of curves as taken are given in Figures 5 and 6. Curves A are taken at a plate voltage of 21, B at 45 and C at 80 volts.

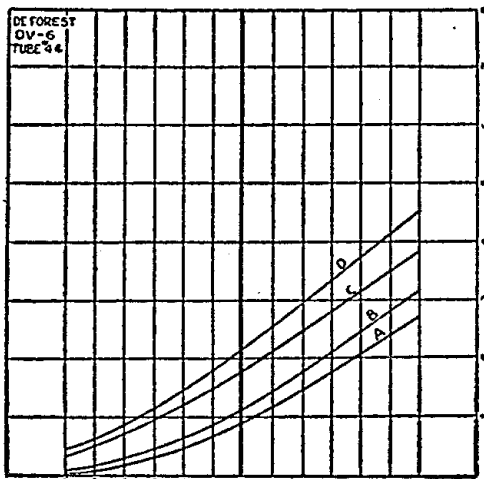

Figure 7

age is increased a more negative grid potential is required.

In the De Forest DV-6 tube considerable variation was found, but due to lack

of space only the average set of curves are given (Figure 7.) On a few of these tubes exceptionally good values were discovered while others didn't come up to the standards shown.

The tube is rated at 3 to 5 volts. Results at three volts were negligible so only the curves at 4 and 5 volts filament are shown. Although rated at 5 amperes the current consumption at 4 volts was found to run from .7 to .75 amperes while at 5 volts it varied between .8 to .85 amperes.

The tube has a standard socket base. The usual 6-ohm rheostat can be used. The curves, although indicating no exceptional values, are fairly consistent. In fact, they are more so than many tubes that indicate relatively higher efficiency. The tube is small and saves space for compact arrangements.

The rated plate voltage recommended is 40 to 60. In Figure 7 the curves A and C are taken at 4 volts filament and 45 and 67½ volts on the plate, respectively, while B and D are taken with 5 volts filament and the same respective potential on the plate.

Philips Detector Type IV

For the purpose of comparing a few of the foreign type of tubes with American manufacture, tests were made on a few of these also. Many of the foreign tubes that are made for the American market are rather poor in quality due to the necessity of keeping costs low in order to overcome the rather high duty imposed on this type of apparatus. Where this cheaper production method has been avoided some very high efficiency values have resulted. Due to a lack of some of these higher grade tubes, the tests made were very limited in number. One of these, the curves of which are given in Figure 8, is a Dutch tube known as the Philips Detector Type IV. This tube has a standard base and can be used on either dry cells or a storage battery in conjunction with the standard 6-ohm rheostat. The filament voltage recommended is 3.5 while the current consumption is .51 amperes.

The curve A, Figure 8, was developed with the plate potential at 16½ volts, when this was increased to 22½ the curve

shown as B was developed. Curve C shows the variation when the plate was

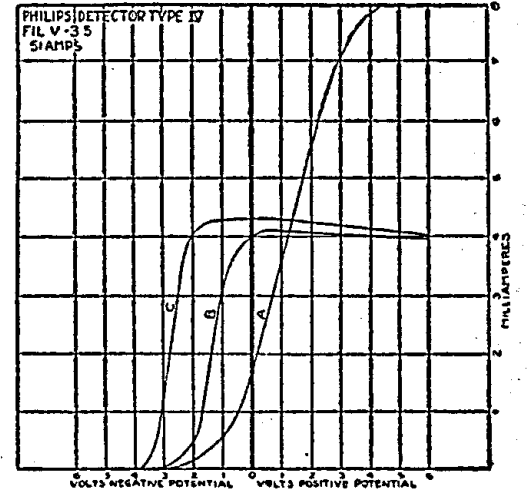

Figure 8

changed to 25½ volts. It is evident that this tube will give a very high efficiency value, but the adjustment of a proper grid potential is necessary. For this reason the use of a potentiometer connected across the A battery, with the grid return connected to the center terminal of the potentiometer, is advisable.

(TO BE CONCLUDED)

A steady hum in the headset isn't always caused by alternating current lines. It is often due to an open circuit somewhere. Trace out your open circuits before you blame it on power lines.

HOOK-UP BLUE PRINTS WITH ALL PARTS' VALUES GIVEN FOR—

1—Hazelitine Neutrodyne	7—Armstrong Super
2—Gibbons Ultra Audion	8—Regenerative
3—Cockaday Four-Circuit	9—Armstrong Super
4—Single Tube Reflex	10—Heterodyne
5—Three Tube Reflex	11—New Ultra Reinartz
6—Flewelling Filter	12—Kaufman Circuit

These helpful prints designed by a Member of the Institute of Radio Engineers. All ten mailed prepaid for five dollars (\$5) or single prints at 75c apiece. Send money order or check (no stamps).

HOME WORKSHOP CO., P.O. Box 1062 Chicago

Jewell Pattern No. 95 Complete Radio Test Set



The only complete radio test set made. All curves on vacuum tubes may be taken, the only other equipment necessary being batteries.

The instrument is enclosed in a handsome case and includes five instruments, a standard vacuum tube socket, a filament rheostat and grid potentiometer, an instruction book and special cross-section paper for plotting curves. The instruments are a filament voltmeter reading to 6 volts, a filament ammeter reading to 1.2 amperes, a plate voltmeter reading to 120 volts, a plate milliammeter reading to 10 milliamperes and a center zero grid voltmeter reading to 10-0-10 volts.

Voltage tests of "A" and "B" batteries and resistance tests of telephone receivers, grid leaks, amplifying transformers and similar apparatus may also be made.

The most important use of this instrument, however, is in taking the characteristic curve of a vacuum tube, from which all of its constants may be determined and the relative value of any tube measured.

This instrument is absolutely invaluable to serious experimenters, to dealers handling large quantities of tubes and to anyone who wishes to go beyond the mere fundamentals in the radio game.

PRICE, \$65.00

Jewell Electrical Instrument Co.
1650 Walnut St., CHICAGO

We Will Mail You One

"VERILOUD" SYNTHETIC RADIO CRYSTAL

COMPARE IT WITH WHAT YOU ARE NOW USING. OURS IS BETTER MAIL US 30 CENTS IF NOT Return it at Our Expense

ZOBEL-STEIN LABORATORIES
322 9TH ST. BROOKLYN, N.Y. SOUTH 2650

THE LARGEST RADIO STORE IN AMERICA

RADIO

BUY HERE FOR LESS

THE LARGEST RADIO STORE IN AMERICA

Radio Supplies purchased here are sold under a positive guarantee of satisfaction. We carry the largest new stock of first quality merchandise.

10A WESTERN ELECTRIC LOUD SPEAKER, complete, \$161 value...\$98.45

BRACH LIGHTNING ARRESTER.....95c

COMPLETE PARTS FOR ULTRA AUDION CIRCUIT (Known as Wonder Circuit)...	\$11.90	HONCHARGER, De Luxe Model	\$12.95
COMPLETE PARTS FOR 2 STEP AMPLIFIER	\$12.45	THORDARSON AMPLIFYING TRANSFORMER, High and Low Ratio	\$2.45
COMPLETE PARTS FOR FLEWELLING CIRCUIT	\$12.45	ORIGINAL BALDWIN PHONES. These are the Genuine Nathaniel Baldwin "Mica Diaphragm" Phones, complete with silk cord and headband. Special at	\$9.95
U. S. A. SIGNAL CORPS (Aviation Type 194-W) WESTERN ELECTRIC PHONES.	\$7.95	Genuine Baldwin "Mica Diaphragm" Type "C" Loud Speaking Units. Special	\$4.65
3000 Ohm GUARANTEED HEADSETS, \$8.50 Value.....	\$3.65	LOOP AERIALS	\$5.95
MAGNAVOX, LOUD SPEAKERS, Type R3	\$27.45	COMPLETE PARTS FOR REINARTZ SETS	\$11.45
COMPLETE PARTS FOR KNOCKED DOWN RECEIVING SET	\$17.95		

Moulded Variometers \$3.45
180° Moulded Variocouplers 3.45
Mahogany Variometers 1.95
180° Bakelite Variocouplers 1.75
Freshman Variable Grid Leak and Condenser.. .75
CRL Adjustable Grid Leak and Dubilier 1.35
Condenser 3.95
Master Baldwin Type G Units with Cord 6.95
Master Baldwin Type C Headsets..... 5.75
Brandes Superior Headset..... 1.15
Antenna Aerial Plug..... 3.45
3 Coll Honeycomb Mounting 2.60
WD-11 Bakelite Sockets..... .50
Firth Cord Tip Plugs..... .60

VARIABLE CONDENSERS

\$4.30 Value, 42 Plate, now.....	\$1.75
3.70 Value, 23 Plate, now.....	1.45
3.30 Value, 11 Plate, now.....	1.35
3.10 Value, 5 Plate, now.....	1.25
2.70 Value, 3 Plate, now.....	1.15
7.00 Value, 43 Plate Vernier Var. Condenser..	3.95
6.50 Value, 23 Plate Vernier Var. Condenser..	3.45
6.00 Value, 11 Plate Vernier Var. Condenser..	2.95

JACKS

Percent Single Circuit.....	\$0.35
Percent Double Circuit.....	.50
Federal Single Circuit Filament Control.....	.35
Federal Double Circuit Filament Control.....	.50

FORMICA PANEL, Black or Brown, cut while you wait, SQ. IN.....1½c

We guarantee all merchandise purchased of us. Mail orders receive immediate attention.

BUY HERE FOR LESS

CHICAGO SALVAGE STOCK STORE

509 South State Street CHICAGO, ILLINOIS

HONEYCOMB COIL

1,500 Turns	\$1.50
1,250 Turns	1.50
1,000 Turns	1.25
750 Turns	1.00
250 Turns75
150 Turns60
100 Turns50
75 Turns40
50 Turns40
35 and 25 Turns.....	.40

CABINETS—MAHOGANY AND WALNUT

6x 5½" by 6" deep.....	\$1.45
6x 7½" by 6" deep.....	1.95
6x 14" by 6" deep.....	2.45
6x 10½" by 6" deep.....	2.95
6x 12½" by 7" deep.....	3.95
9x 10½" by 5½" deep.....	2.95
Sphacetti Tubing, yard.....	.10
Phone Caps, for mostly all phones.....	.25
Lightning Switches	2.65
Hydrometers, now at45
Rheostats45
Sponge Rubber Ear Caps, Pair.....	.50
Dials, 2, 3 and 3½ Inch.....	.25
Grewel Detectors	1.35
Signal Corps Super Sensitive Microphone	2.45
Transmitters40
Solid Copper Aerial Wire, 100 ft.....	.35

GOOD PORTABLE SET HOOK-UP

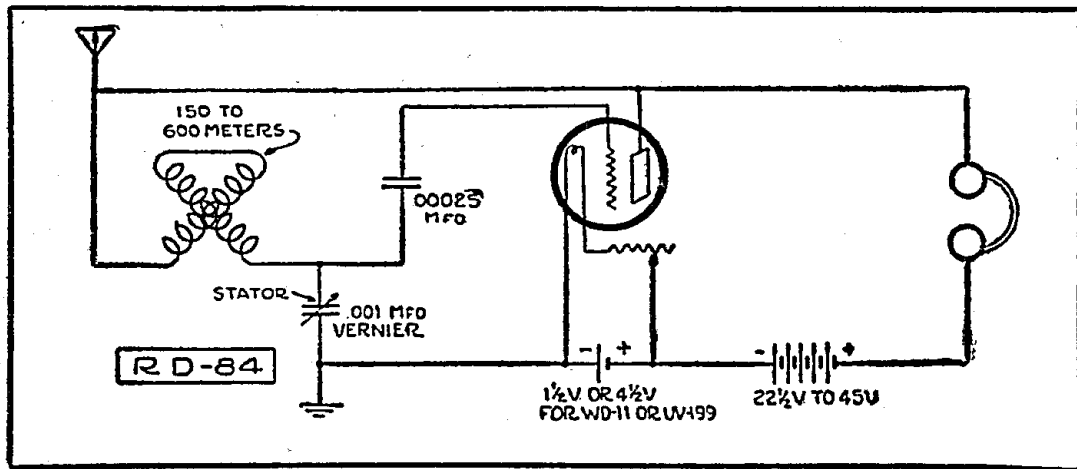

FOR the fan who contemplates building a very compact portable set the hook-up shown as R.D.-84 is recommended. Any of the tubes with low current consumption can be used. Naturally the proper rheostat to be used will depend on the tube and the source of filament current. The antenna circuit includes a variometer and a .001 mfd. vernier variable condenser in series. These two controls of wave length will permit extreme selectivity. The regenerative feature of the circuit guarantees plenty of volume in reception. The circuit is an adaptation of the Colpitts transmitting circuit named the "Gibbons."

If desired audio frequency amplification can be added in the usual manner. The plate voltage need not be more than 45 and in fact 22½ volts will do in most

cases. This depends on the tube. Since maximum results are expected, good apparatus should be used and care taken in assembly and wiring. Soldering joints should be properly made. Spaghetti insulation should be used in all compact sets thus reducing the possibility of short circuits to a minimum.

As a portable set, U.V.-199 or W.D.-11 tubes are convenient. The latter can be lighted by a single dry cell and the former needs only a large, tubular flashlight cell (yielding 4½ volts). The tube sockets should be mounted on sponge rubber or heavy felt batting to eliminate vibrations that breaks the filament, and micro-phonous tube noises when the set is in use. Short flexible leads to the socket and thence to the regular bus bar wiring will also aid in stopping these shocks.

Review of Books

Ideas for the Radio Experimenter's Laboratory. By M. B. Sleeper. The novice will find a wealth of information which will assist him in the designing, constructing and testing his set. Data on laboratory instruments are given. Price, 75 cents.

Experimental Wireless Stations. By P. E. Edelman. Simple directions are given in this book for making Radio equipment for the transmission of messages over long distances. Price, \$3.

Vacuum Tube Receivers. By O. F. Hessler. A book that tells how to make a simple set. How to make a cabinet. It includes a 27 by 36-inch layout blue print. Price, 75 cents.

The Armstrong Super-Regenerative Circuit. By George J. Eitz, Jr., E. E. This is a De Luxe edition of this famous circuit. Profusely illustrated and fully explained. Fifty-two pages. Price, \$1.

How to Retail Radio. A new book telling of tested plans and methods and policies for the dealer in Radio. Financing, location, store equipment and arrangement. Price, \$2.

Radio First Aid. Illustrated with working drawings and complete data as to the necessary equipment and cost of constructing from the simplest to the most modern Radio outfits at home. Price, \$1.

Home Radio—How to Make It. By A. Hyatt Verrill. This book is particularly adapted for the amateur who desires to know how to make Radiophones. Twelve full page illustrations and diagrams. Price, 75 cents.

Radio for the Amateur. By A. H. Packer and R. R. Haugh. The underlying principles of Radio thoroughly explained in simple language and understandable illustrations. This book will teach you how to construct and operate a receiving set successfully. Price, \$1.50.

The Radio Amateur's Handbook. By A. Frederick Collins. A new revised edition

of this book is just out. It is complete, authentic and informative work on Radio. Fully illustrated. Price, \$1.50.

Ideas for the Radio Experimenter's Laboratory. By M. B. Sleeper. This book tells in a simple way the how and why of Radio apparatus. Comprehensive data is given on such necessary laboratory instruments as the oscillator, wavemeter, direction finder, Radio compass, vacuum tube characteristic measuring set and detailed advice given on the winding of various kinds of standard inductance coils. Price, 75 cents.

The book department of the Radio Digest is prepared to send you any of the books on Radio published, whether listed in our Book Review or not. Let us know what book you want, send us your check and we will see that the book is mailed to you. Postage stamps in payment for books not accepted. Send money order or check. Radio Book Department, Radio Digest, 123 W. Madison St., Chicago, Ill.

We Live In Kansas

—but we receive programs from Atlanta, Minneapolis, Davenport, Fort Worth, Madison, Los Angeles, Dallas, Kansas City, St. Louis, Denver and San Antonio on Crystal without batteries. Your crystal set requires only easy inexpensive changes. Send stamp for further information or \$1.00 for copyrighted drawings and instructions. Everything explained. Satisfaction guaranteed.

LEON LAMBERT, 501 South Volusia, Wichita, Kansas

At Last!

You Can Buy a Real 1½-Volt Clear Tube

The W. D. 12's only Competitor. Functions at 1 to 1.1 Volts. Genuine Platinum Coated Filament.

Fits Standard Socket

Do not confuse this tube with common Silvered Tubes advertised as 1½-Volt.

Detector—Amplifier

Absolutely Guaranteed \$4.50

MAIL ORDERS FILLED PROMPTLY
Cash or Money Order (No Stamps)
Dealers write for Quantity Discount

TREXO TRADING CO.
200 Broadway (Suite 210), N. Y. City



FIRST STEPS IN RADIO

(Continued from page 11)

the potential between adjacent turns use is made of bank winding.

In a 2-bank winding the turns are laid on as numbered in the illustration. Two turns are first put on the tube, the third jumps back on top as shown, the fourth turn coming back to the tube and the fifth goes back alongside the third and so on. A 3-bank and a 4-bank are also shown. By this means the distributed capacity is reduced to a minimum and a compact coil results.

Since this type of winding is not suitable to machine (or even hand!) winding the honeycomb and duo-lateral coil was devised. In this winding the turns are spaced some distance apart and cross each other at an angle. Since adjacent turns are well separated and the layers cross at an angle the distributed capacity is effectively kept down while a large inductance is obtained in a small space.

Spider Web Winding

Instead of winding the turns of an inductance alongside of each other an attempt to wind them on top of one another in a flat spiral resulted in the spider web or staggered coil. Originally this form of winding consisted of a round wood form in which was inserted an uneven number of wood pegs or sticks. The wire was woven around the sticks to form a thin flat winding very suitable for use in tuners using a tickler coil inductively coupled to the secondary of a receiving set. The more modern spider web differs only in that a slotted form is used as a form for winding.

Another form of winding that is seldom used but possesses many advantages is the toroidal coil. In this form of inductance the coil is wound on a doughnut-

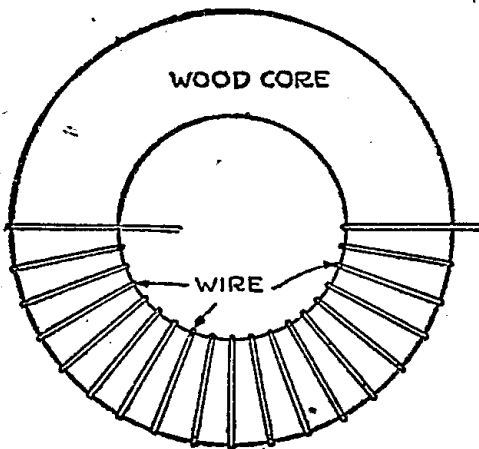

Figure 22—Showing How Toroidal Coils Are Wound

like form cut from wood as shown in Figure 22. It will be seen that the magnetic field is completed within the coil and such a coil will not act inductively upon another winding. This is a great advantage in some cases particularly where feedbacks in a set causes trouble. Thus this winding would be suitable for tuned Radio frequency amplifiers or for single circuit circuit tuners where inductive feedback is not employed.

Variometer Effect

So far we have considered industries that are variable only by tapping the winding at fixed places. In the variometer,

however, we have an inductance that can be varied in minute steps. The principle of this instrument is shown in Figure 23. The rotor and stator are represented by straight tubes for the sake of clearness. When the windings are connected in series the same current flows through both coils.

In a properly designed variometer the magnetic fields of the stator and rotor are of equal strength. When the rotor is in such a position that its poles are similar to those of the stator (or so their fields

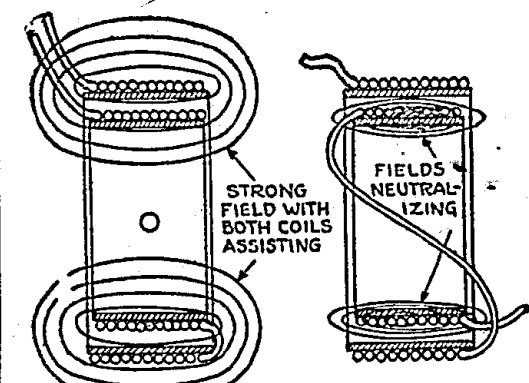

Figure 23—How the Variometer Functions assist each other) the inductance value is at a maximum as will be seen from the illustration where the two fields act together.

As the rotor is turned its field does not coincide with the stator field and the mutual inductance is decreased, reducing the total inductance proportionately. When a full half turn is made the fields from the two coils are in opposition and neutralize each other thus reducing the inductance to a minimum. Therefore, it is possible to vary the inductance very gradually for fine tuning.

In order to obtain a wide range of tuning it is necessary to have the minimum value of inductance as near zero as possible. For this reason the stator winding should come very close to the rotor so that the neutralization of the fields will be more nearly complete. In practice, about the greatest range is to reduce the inductance value to one-fifth of maximum value.

In the next chapter, "Tuners and How to Tune Your Set," we will take up the application of these inductances in the various tuning circuits.

(TO BE CONTINUED.)

To thoroughly understand the workings of triode tubes, the beginner should read a book on the subject.

ADJUSTABLE COIL MOUNTINGS FOR FLEWELLING CIRCUIT

Triple Coil Mounting.....\$5.00 List
Double Coil Mountings..... 3.50 List

A patented feature locks the coil in place and prevents the coil from being thrown out of adjustment once station is tuned in. Equipped with a silver finished calibrated dial.

Dealers write for special discounts

Licensed under U. S. De Forest Pat. 1365170

ASTORLOID MFG. CO., 416 Marcy Ave. Brooklyn, N. Y.

GOLD-GRAIN CRYSTAL DETECTORS

DEALERS—New List Attractive Discounts

HUDSON-ROSS

123 W. Madison St. Chicago

Federal Standard Radio Head Sets

Increase the Receiver's Efficiency

The high efficiency, wide distance-range and perfect clearness of Federal Standard Head Sets are the logical result of 22 years' experience in the making of precision communication apparatus.

Federal Standard Head Sets are nationally endorsed by experts. Use them and get PROFESSIONAL efficiency from your radio. Federal makes a complete line of radio apparatus.

Federal Standard Head Sets are made with 2200 Ohms and 3200 Ohms resistance.

Write for descriptive literature and price.

For sale by leading dealers

Federal Telephone and Telegraph Company

BUFFALO, NEW YORK

Western District Office: 417 South Dearborn St., Chicago, Ill.

Questions and Answers

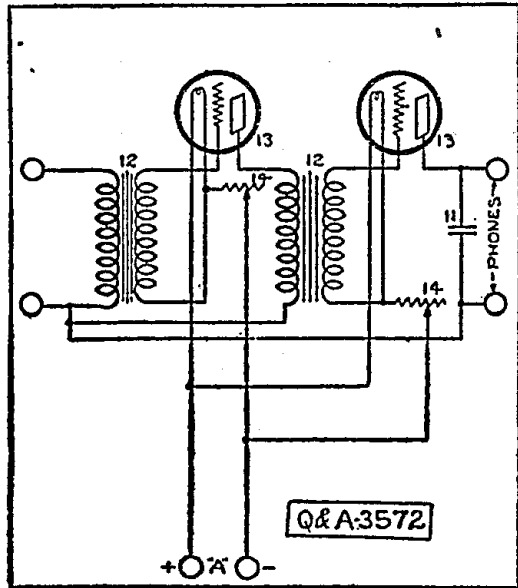
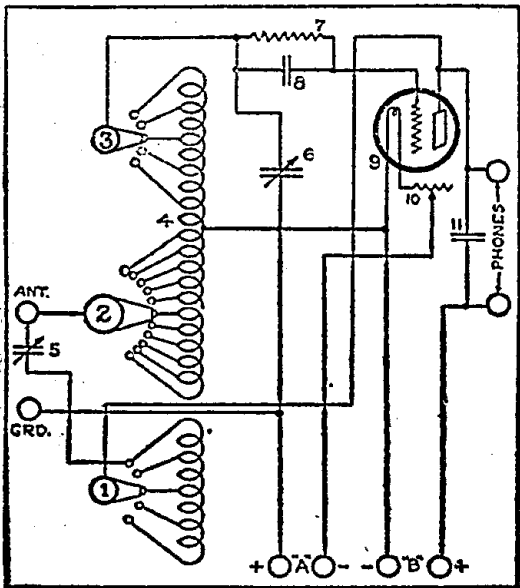

Reinartz Panel Set (3572) WJM, Rensselaer, N. Y.
I believe it would prove advantageous to many of your readers as well as many who never saw them to reprint the drawing of the Reinartz circuit that appeared in your paper November 25. I lent my copy to a friend but it has never been returned and I am very desirous of getting another.

I built my Reinartz through the aid of your specifications and it is my favorite set. It has proven very selective, which is desired by most owners, for it brings in the distant broadcasting stations exceptionally well. Often it is very poor on local stations and only last night I could not tune in a concert which was being sent out only about two miles away but could get WGR at Buffalo fine at the same time by a mere turn of the vernier condenser.

I have the detector with one stage and attempted to add a second stage but with no success. No better than one stage, although I have gone over wiring and all details without finding anything amiss. Some drawings show a plus to secondary of transformer, others a minus. Have tried both but no better. I am well pleased but would like to add the other stage so could use a loud speaker. I can get broadcasting from 4 p. m. until 4 a. m. nearly every day if I care to tune in. The farthest point reached is Omaha, Nebraska. This is no record but I am trying to improve my set to establish a rec-

ord. I desire to get the Pacific stations. I would like a drawing showing how to hook on the second stage of amplification showing the variations to make. Also data on choke coil and advantage and how to make and whether battery is used when the rheostats are turned off.

What I actually want to know is, if it is sufficient to turn rheostats of a battery off when not in use in order to not use either A or B battery or must the wires be taken from the binding posts of the A and B battery.

It seems peculiar that I cannot get my second stage to function. I have used the same wiring plan as the first on which I have, in my estimation, good results. I have tried using separate B batteries of 45 volts for the one stand second stage, also have tried making all connections on one B battery. I am using jacks so

If you should publish a diagram make jack connections plain.

A.—Answering your inquiry with reference to difficulty encountered in adding amplification to otherwise satisfactory functioning Reinartz circuit we are advising that it is our opinion that you have a faulty amplifying transformer. It might be, however, due simply to the fact that tube is not making a good contact in socket. Attention to these details should remove the limitation experienced.

In the matter of connecting transformer, secondary must go to the negative side of A battery.

Battery current is not consumed when rheostat is turned off.

We are directing your attention to page thirteen of March 3 issue of Radio Digest for a diagram of circuit in question showing method of adding two stages of amplification with jacks for plugging phones in on detector.

As per your suggestion we are repeating the hook-up illustration that appeared in the November 25 issue.

Loop Aerial (3444) FHG, Seward, Nebr.

What size loop do you recommend to work with a single tube reflex circuit, as shown on page 14 of the March 17 issue of Radio Digest? Also will it receive Radiophone messages and music?

"Good Luck" to "Logwood," and same to you. You publish a good, clean, clear paper and I look forward to it each week.

A.—Answering your inquiry, we are advising that an effective loop aerial is accomplished with ten turns of wire, paced one-half inch apart, on a three-foot square frame.

Frankly, we would not admit that a loop aerial will afford the satisfaction of an out-of-door aerial construction. The reflex circuit is effective and affords a reasonable degree of gratification in operation.

Chi-Rad Special!
for W.D. 11 tubes—

Standard, threaded rubber, Willard's specially adapted for use with W.D. 11 Tubes. Supply current at 2 volts to one W.D. 11 Tube for 210 hours on a single charge. Rechargeable. Brand new, size 4x5 1/2 x 7 inches—Chi-Rad guaranteed.

2-Volt Willard Charged... \$7.50
2-Volt Willard Dry... 6.50

These same Willards can be adapted to deliver 8 volts for pure D. C. for C. W. Transmitters. Better than a generator because no filter is necessary. Much less expensive.

In lots of 40 (320 volts) \$160.00
(Better prices on larger quantity)
Specify dry or charged when ordering.

Chicago Radio Apparatus Co.
415 S. Dearborn St., Chicago, Ill.

PHANTOM-CIRCUIT
Build Your Own. This marvel of mystery, using no loop, no aerial and no ground, brings in music instead of interference. We have heard stations 850 miles distant on one tube. By using W.D. 11 tube set can be entirely self contained. Very easy to build from our instructions, use your own spare parts, nothing complicated like radio frequency or super regenerative. Only one tuning control. Complete instructions, with hook-up and photo of circuit mailed to you for 80 cents. Stamps accepted.
VESCO RADIO SHOP, Box D-704, Vacaville, Calif.

TWO SUPERSENSITIVE CIRCUITS
(Both Copyrighted)
My Highly Improved Reinartz brings in all important stations on both coasts and Mexican border, loud, clear and without distortion. We dance to music from Atlanta received on one loud Baldwin unit. Build one of these wonderful sets from my blueprints and specifications, price 50c, or with a perfect and complete double wound spiderweb coil, \$3.00 by mail. No other windings used. Photo of my set on a glass panel with every order.
This copyrighted circuit is the most successful of any Reinartz modification yet produced, and is imitated the most. Thousands are in use.
My W. D. 11 Circuit is especially designed for use with the "Pickle" tube and brings out the full range of that little tube as no other circuit can. Stations 1000 miles away come in clearly on one tube. This set is small, complete, portable. For the man who wishes the highest efficiency, this is the set to build. Price of blueprint and specifications, 50c, or with complete and perfect windings, \$3.00. Photo of set with every order.
Either set is easy to build, easy to operate. Everything clearly shown.
Sets built from these plans will receive all broadcasting stations operating under the new laws. Their wave length range is from 140 to 670 meters.
S. A. TWITCHELL
1925 Western Ave. Minneapolis, Minn.

Electric Soldering Iron
\$2.50
A. C. OR D. C. CURRENT
DEALERS—Attractive Discounts
HUDSON-ROSS
123 W. Madison St. Chicago

Just Consider
—the essential features necessary to make an audio frequency transformer a good one—

1. High Amplification.
2. Minimum Distortion.
3. Low Interstage Linkage.
4. Convenient Mounting.
5. Compactness.

Cotoco transformers make these ideal features facts. And the finish will surely please you.

"Built First to Last"
\$5.00
At Your Dealer's

COTO-COIL CO. PROVIDENCE

"MAKE PERFECTION YOUR SELECTION"
We Carry Only STANDARD Advertised Radio Equipment. Every Product Sold on a MONEY BACK GUARANTEE.

FREE A \$1.25 VOLTMETER OR AMMETER GIVEN WITH EACH PURCHASE OF \$5. OR OVER **FREE**

MAGNAVOX LOUD SPEAKER, Type R. 3... \$24.95	FLEWELLING CIRCUIT Complete parts, including PANEL, Double Coil Mounting and 2 Honeycomb Coils, Mounted, ONLY Standard Equipment Used, FREE DIAGRAM... \$11.95
Nathaniel BALDWIN Phones List \$6.00. SINGLES, with Cord, ... \$4.60 Special ... \$8.95 List \$12.00. DOUBLES, with Cord and Band	REINARTZ CIRCUIT Complete parts for this remarkable set. FREE DIAGRAM... \$9.95
DE FOREST DV 6 TUBES. The popular De Forest tube detector or amplifier. List \$6.00... \$3.75	WESTERN ELECTRIC Phones. None better made. List \$12.00. Our price... \$7.95
N. & K. PHONES 6000 Ohms. None Better Made for DX Reception. Imported. List \$16.00... \$6.50	TUNGARA C. BATTERY CHARGER. General Electric quality product. \$18.00 List—2 Amp. \$14.95 Special ... \$22.95 \$28.00 List—5 Amp. Special
QUEENS VARIOMETER. Treated Mahogany. Guaranteed Quality. List \$6.00. Our Special Price... \$2.45	QUEENS 180° BAKELITE COUPLER. Silk Wound. List \$5.00. \$2.45 Our Price
COCKADAY CIRCUIT Complete parts for this wonderful circuit... \$13.50	Complete Parts for 2 STEP AMPLIFIER, including Panel, 1 10 to 1 Ratio Transformer, 1 5 to 1 Ratio Transformer "All American" Transformer used. \$13.50
TRIPLE MOUNTINGS, with Leads. List \$5.00. Our Price... \$3.25 DOUBLE MOUNTINGS with Leads. List \$3.50. Our Price... \$2.25	2 STEP AMPLIFIER Perfection Quality. Completely made, ready to use—Guaranteed... \$11.95
"B" BATTERIES EVEREADY—No. 763—22 1/2 Volts... List \$1.75 Our Price \$1.45 BRIGHT STAR—No. 767—35 Volts... 5.50 4.50 BRIGHT STAR—No. 15-50—22 1/2 V. 1.75 1.10 BRIGHT STAR—No. 15-03-6—22 1/2 V. 2.25 1.45 BRIGHT STAR—No. 30-90—45 Volts... 5.00 3.50 FRANCO—No. 1529V—22 1/2 Volts... 2.50 1.85 FRANCO—No. 3045V—45 Volts... 5.75 3.95	TUBES UV-199... \$6.50 UV-201A WD-11
PANELS—3/16" Thick Hard Rubber Bakelite 7x18... \$1.65 2.45 7x10... \$0.95 1.35 7x21... 1.85 2.75 7x12... 1.25 1.60 7x24... 2.15 3.25 7x14... 1.40 1.95	V. T. 2 TUBES Genuine Western Electric Tubes. The Best Amplifying Tubes Made... \$6.75
CABINETS Extra fine quality—Hinged top—Mahogany finish. 7x10... \$2.75 7x18... \$3.50 7x12... 2.95 7x24... 3.95 7x14... 3.25 12x14... 3.95	CROSLY One tube Regenerative Set. Will receive over 1000 miles... \$19.00 CROSLY 2 Step Amplifier to match above, Mahogany Cabinet... \$17.00 CROSLY 2 Step Amplifier to match above (same size Mahogany Cabinet) complete with two DeForest DV-6 Tubes. Special... \$21.50

PERFECTION RADIO CORPORATION, Mail Order Dept. 59 Cortland St., NEW YORK CITY
Stores also at 119 West 23d Street, 78 Cortland Street and 128 Chambers Street
WHOLESALE AND RETAIL

Radio Illustrated



Miss Elsie Janis, known to every doughboy who served in the A. E. F., and her mother in their Paris' apartment listening to a selection being rendered on the Wanamaker organ in Philadelphia by Marcel Dupre, organist at Notre Dame in Paris © Wide World

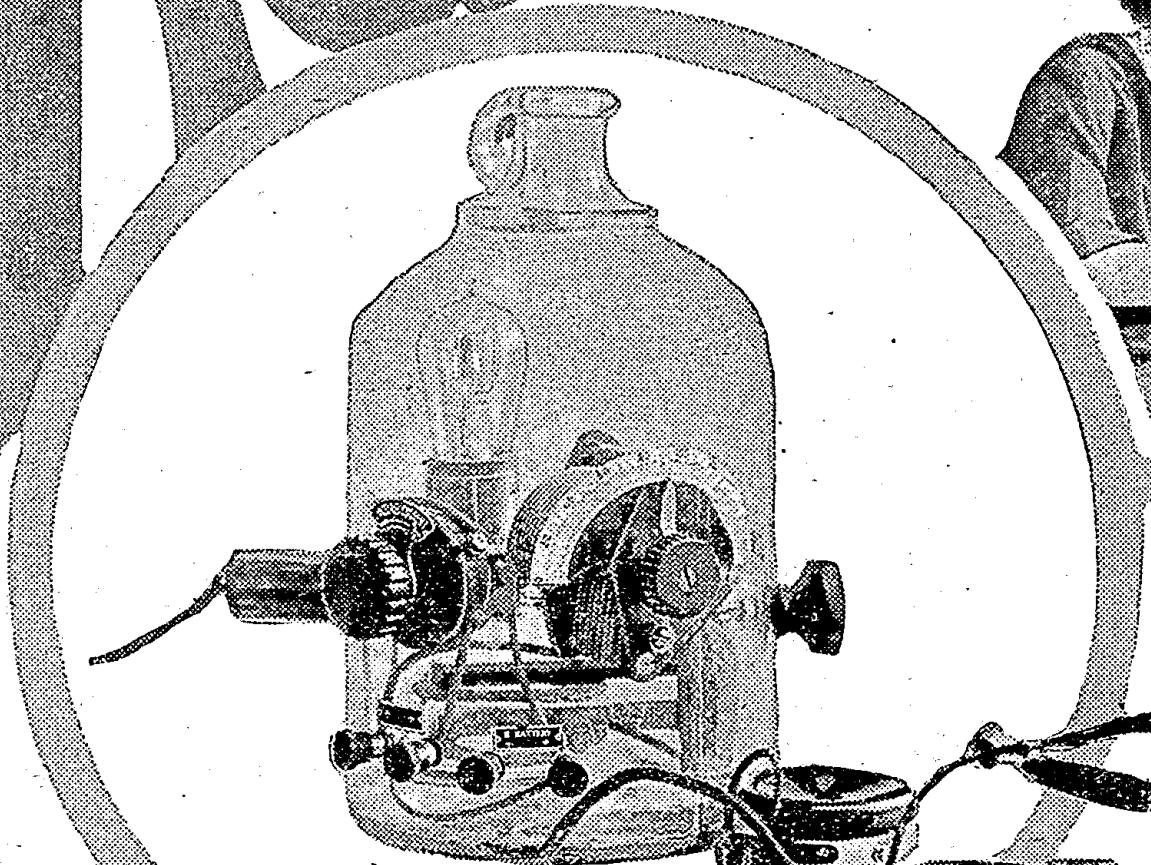

Flewelling is bottled at last! This famous set is shown placed in a bottle with all connections for batteries and phones coming through the glass sides. The builder of the set, Mr. Albert P. Langlois, claims to have picked up signals with this bottle set while speeding in an automobile and using a wire dragging along behind for an aerial



Outdoor concert for the members of the crew on a submarine. With connections to the set within, the loud speaker is brought on deck where the crew is assembled and listening to a concert. This is the crew of the Submarine S-50 © Fotograms

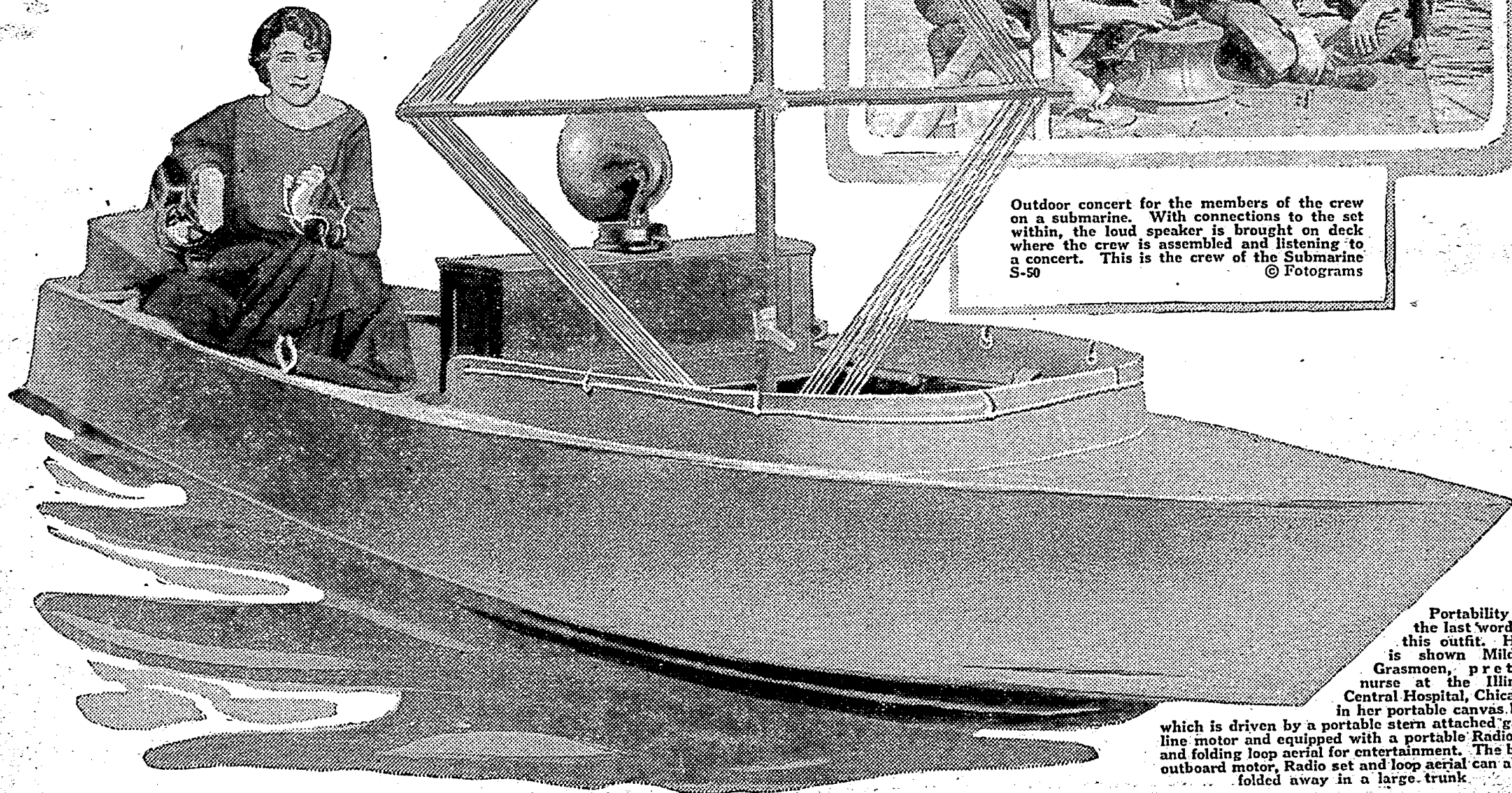

Portability is the last word for this outfit. Here is shown Mildred Grasmoen, pretty nurse at the Illinois Central Hospital, Chicago, in her portable canvas boat which is driven by a portable stern attached gasoline motor and equipped with a portable Radio set and folding loop aerial for entertainment. The boat, outboard motor, Radio set and loop aerial can all be folded away in a large trunk.