

New De Luxe Loop Aerial; Simplex; Flewelling

# Radio Digest

EVERY WEEK

# Illustrated

TEN CENTS

REG. U. S. PAT. OFF. & DOM. OF CANADA

Vol. VI

Copyright, 1923  
R. D. P. Co. Inc.

SATURDAY, SEPTEMBER 22, 1923

No. 11

## RADIO PREDICTS QUAKES

### SHOCK EXPERTS WILL MAKE AIRPHONE TO WARN PEOPLE

Dr. L. Day, Famous Seismologist, Suggests Ether Device as Forecaster—Jap Plant with Hero Operator Tells World of Earthquake

(Special to RADIO DIGEST.)  
LOS ANGELES.—No more will terrifying earthquakes catch a sleeping public in a horrifying holocaust! No more will hundreds of thousands of lives be sacri-

ficed as in the Japanese disaster, not if the recent suggestion of Dr. Arthur L. Day, famous seismologist, to apply Radio principles to the forecasting and warning of quakes, is acted upon and realized.

Dr. Day, director of the Carnegie Geophysical Laboratory in Washington, D. C., is responsible for the statement, made at a luncheon here of the Southern California Chapter of the Seismological Society of America, that the principles of Radio have great scientific possibilities in seismography, the study of earthquakes. Dr. Day was speaking before a group of internationally known earthquake specialists who were meeting here to discuss earth tremors and ways and means to eliminate such catastrophes, and the frightful loss of life following in their wake.

**Would Warn of Quake**  
Dr. Day believes that application of Radio principles and specially designed apparatus to the already sensitive and delicately adjusted seismographs, which register earthquakes, would enable the Radiophan in the threatened area to be warned in advance of the coming shock. Such a forecast would be possible early enough so that the inhabitants of the region could move to safe parts of the country, or at least to the open spaces where their lives would be less in danger.

Although the exact system the famous scientist has in mind was not divulged, he indicated that automatic seismograph stations equipped to send Radio alarms, were a part of his general plan. Such stations might be compared to the automatic Radio compass stations now used to send out bearings to ships at sea.

**Find Direction of Tremor**  
Such a system, Dr. Day believes, would enable the observers to calculate the strength and direction of the tremors so accurately that relief trains could be dispatched to remove the people from the threatened cities long in advance of the disaster, thereby saving the lives that would otherwise be lost.

(Continued on page 2)

Looking up giant 660-foot mast supporting the antenna of the Japanese station at Haranomachi, only means of communicating news of the Japanese disaster to the outside world. Below, center, is the heroic Jap operator, T. Yonemura, who stuck to his post, many times forced to make his own repairs to send the news. Below, right, is Irving Brown, commercial operator at San Francisco, who first heard Yonemura calling

Photos below © Int.

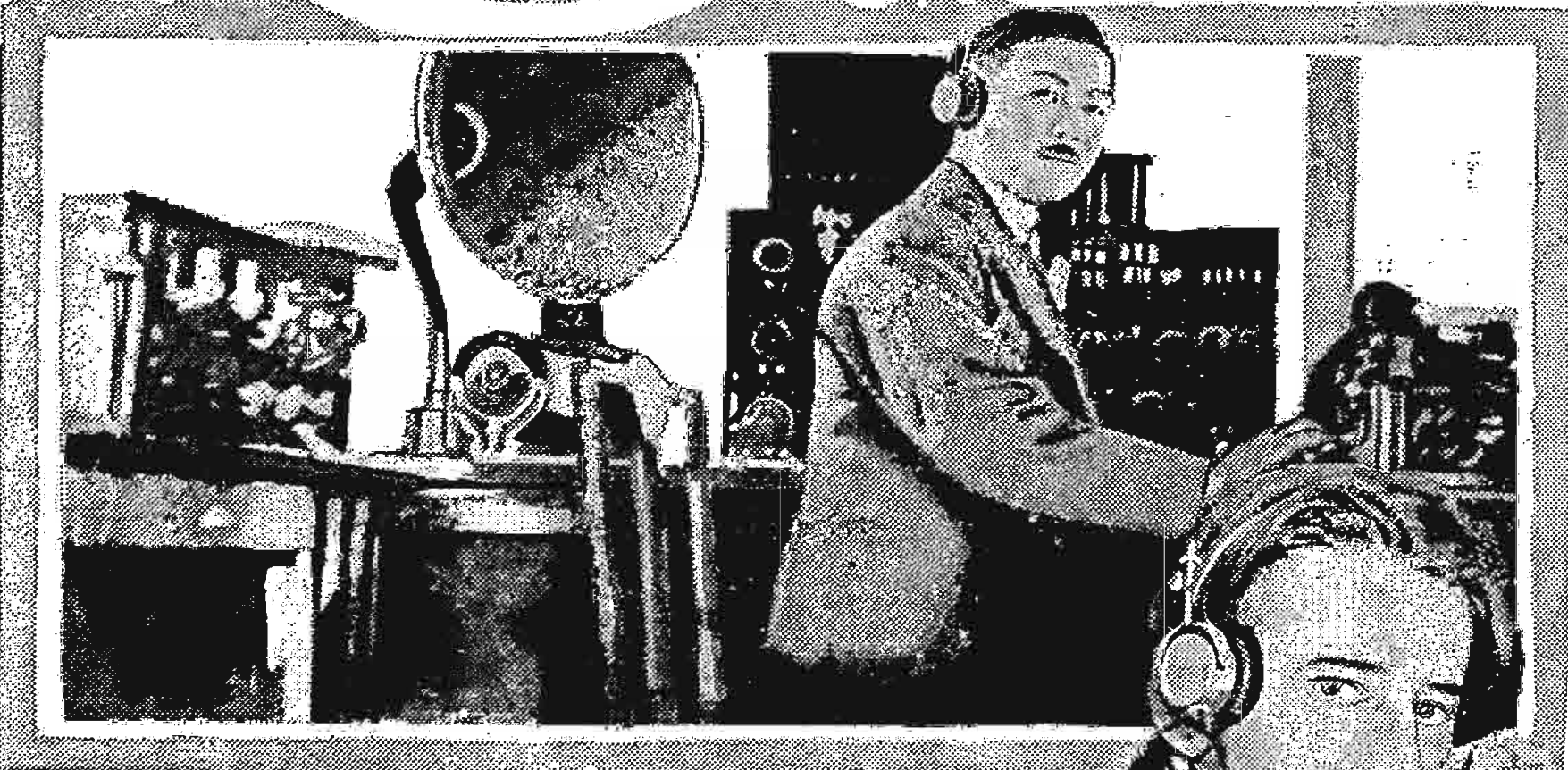
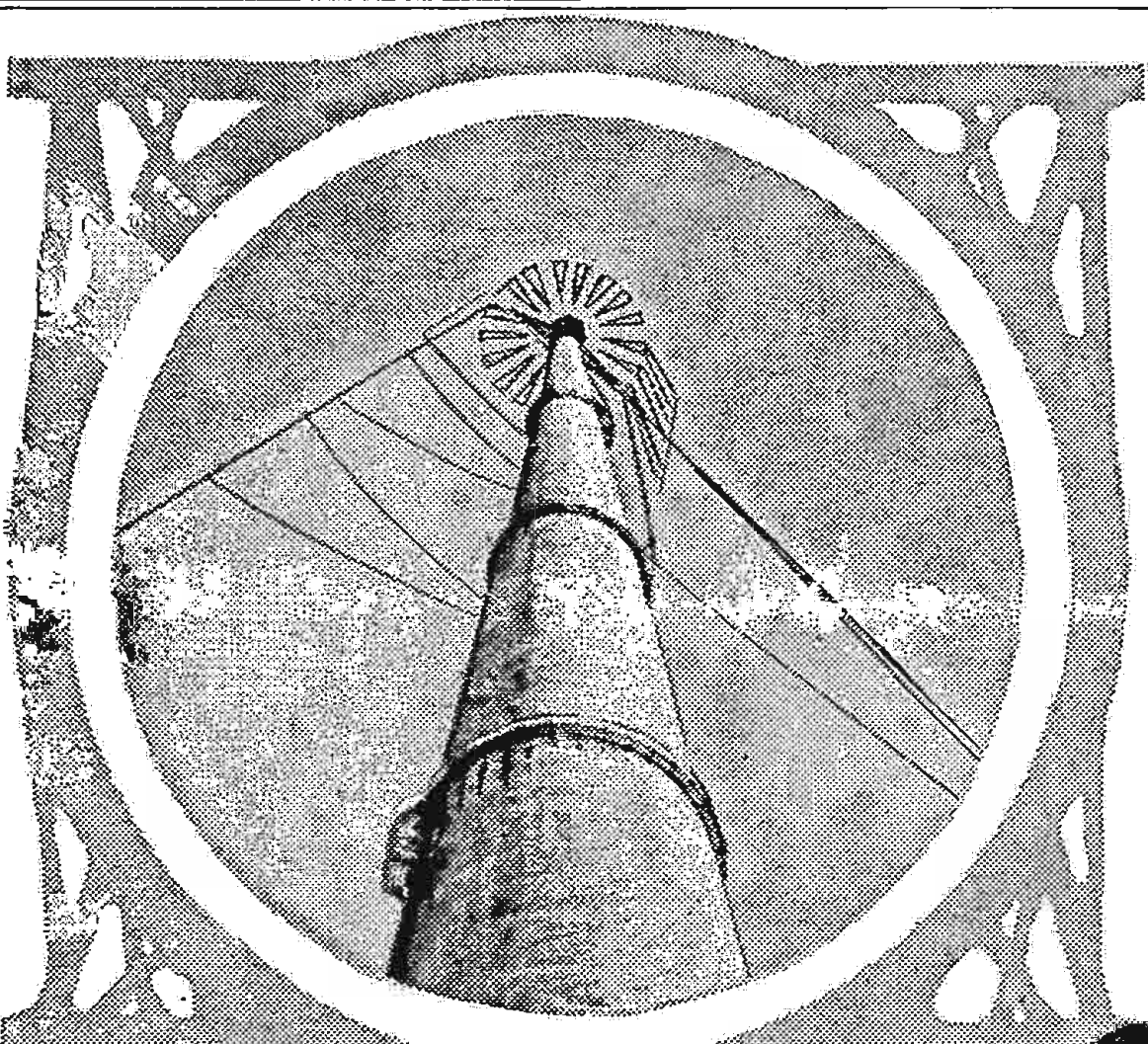

#### NEED A DERRICK FOR WQAL "BIG" PROGRAM

MATTOON, ILL.—Station WQAL of this city challenges all others to a night "bigger" than that which is recently observed when it broadcast a musical program given by five men who weighed more than 1,800 pounds. The artists were weighed together and required the use of a grain scale. Listeners in failed to realize the program was very "heavy."

#### Radio C. of C. Opens Eyes to Farming Field

Plans to Educate Tillers of Soil to Benefits

NEW YORK.—Realizing the great buying power of farmers in the United States, the National Radio Chamber of Commerce, assisted by manufacturers and distributors of Radio devices, has begun a campaign to educate tillers of the soil to the practical value of the airphone.



ORDERS FOR PARTS CLOG DIGEST MAIL

CLASS H GETS HEAVY ON-SLAUGHT FROM FANS

Appearance of Sixteenth Consecutive Coupon Shows Readers Have Been Saving Whole Series

SPECIAL REWARD OFFER Coupon Number 17. This Special Reward Coupon appears each issue in Radio Digest until further notice. When sent in, accompanied by necessary remittance, according to the rules governing same, apparatus can be secured. See apparatus list and rules of offer below. Save Me—I Am Valuable

With the publication of the sixteenth coupon of the special reward offer for regular Digest readers, as was expected, during the past week bags of mail poured into the publication's office containing letters from thrifty fans who had been saving the whole series in order to secure one of the many valuable accessories listed under Class H, and requiring sixteen consecutive coupons. Now coupon No. 17 appears. Even more orders from Radiophans are expected this week as a result of many readers starting with the second coupon of the series rather than the first.

In the meantime letters continue to flow in from fans who desire Radio parts listed in the classes of items requiring less coupons than those in Class H.

The onslaught of orders, however, will not delay shipments to readers, as the special offer department is fully prepared to meet the large demand. Subscribers are urged to be careful in sending coupons and remittances, to follow carefully

to Remember be emphasized to those taking advantage of the special offer that the coupons must be numbered in order, for example, 1, 2, 3, and so on, up to 16. The number of coupons necessary for the cash remittance, of course, depends on the item sought by the reader. There is no limit to the number of series turned in by any one reader.

Another point to remember is that cash, checks and money orders but no postage stamps will be accepted.

To make selection more simple the items have been divided into eight classes, each class depending on the number of consecutive coupons and amount of cash remittance necessary.

The complete list of parts obtainable, together with the number of coupons required, will appear here in next week's issue.

RADIO PREDICTS QUAKE

(Continued from page 1)

At the luncheon Dr. Day addressed were Ralph Arnold, chairman of the society, Dr. Perry O. Wood, research associate of the Carnegie Laboratory, who has charge of the earthquake experimental station at Mt. Wilson, Calif., A. M. Strong, a noted geologist, Dr. Ford Carpenter, writer and authority of meteorological subjects, and Dr. W. S. Kew of the United States Geological Survey.

Jap Disaster Proves Radio

Turning, however, from the suggestion for warning of quakes to the actual part played by Radio in the recent Japanese catastrophe, it can be said that commercial Radio was tried under very difficult conditions, and was not found wanting. Where all other means of communication failed, a little Jap Radio operator stuck to his post, repaired damages to his station, and gave the world information of the great earthquake.

Out of the appalling disaster has emerged proof of the unflinching dependability of Radio and a hero whose name will go down in history. When Tokio and Yokohama were first rocked by earthquakes and swept by flames, the cables and naval Radio stations were put out of commission.

Iwaki Unit Left Intact

At Tomioka, 155 miles north of Tokio, and at Haranomachi, 178 miles north of Tokio, the great 660-foot towers were, by some strange freak of the quakes, left standing. These two plants are together known as the Iwaki unit, the transmitting equipment being at Haranomachi, while the receiver and the key controlling the transmitter are at Tomioka.

Taki Yonemura, operator in charge of the Iwaki plant, is the man whose name will go down in history as one of the outstanding heroes of the Japanese catastrophe. Yonemura is the only man at the Jap station that understands English.

Even he has only a limited knowledge of the tongue. While the earth rocked and swayed, he for three days and nights sat at his key and flashed to the outside world the tidings of destruction and the urgent appeals for food and medical aid.

Sends Messages as Earth Rocks

His messages, picked up by the big receiving station at Bolinas near San Francisco, operated by the Radio Corporation of America, were for seventy-two hours the only source of information for the press associations and newspapers of this country. In the intervals between sending, he laboriously translated into English some 8,000 words of Japanese, and just as laboriously spelled it out, letter for letter, in the International Morse Code. His handicap can better be appreciated when it is stated that this is not the code ordinarily used by Japanese operators.

His tentacles were badly twisted and frequently, unable to express himself in English, he reverted to Japanese for whole sentences at a time. Time after time his story of the disaster was interrupted by heavy earthquake shocks which shattered parts of the apparatus and tore the wires from their connections. In one instance it was four hours before the damage could be repaired, but every time Yokemura replaced a part or traced the break and stuck to the job.

Cables Out of Commission

Without Radio and Yokemura, it would have been from twenty-four to forty-eight hours before news of Japan's plight could be sent to the outside world and relief supplies started on their way. The Pacific Commercial cable from Japan to Bering Island, reported submerged, and thence to Guam, was put out of service by the earthquake. Messages are now routed east via Manila, Shanghai and Nagasaki, or west via London.

It remained for Radio to carry the official dispatches and news reports across the Pacific to North America, and Radio has handled a tremendous amount of

traffic. Tomioka for some time had no means of communication inland. At the suggestion of the Japanese ambassador at Washington, however, a courier service was established to Tokio and now a regular schedule is in operation. A statement that communication was open to Tokio, by the state department, led some to believe that line wire communication between the station and Tokio was established. However, communication used in the old sense, means that the roads were open. According to the last reports no wires have been re-established.

Broadcast to Sea of Dangers

Radio was by other ways the means of getting news of the disaster to the new world on September 4. The master of the S. S. President Jefferson Radioed to his Shanghai office from the port of Yokohama direct. The American consul put the message on the cable for Secretary Hughes in Washington.

Facts relating the unsafe condition of the harbor at Yokohama were immediately broadcast by the naval hydrographic office there, that all ships might be warned of the hidden dangers in the harbor, the absence of lights, etc. Here Radio again served in its first recognized capacity, that of protecting life at sea.

U. S. Naval Radio Makes Link

The U. S. naval forces in Japanese waters are rendering official emergency service via Radio. The American Asiatic fleet is now at Yokohama and the destroyer Borie is stationed at Nagasaki as a Radio relay ship. Messages from the American flagship are picked up by the Borie, relayed to the naval Radio station at Cavite and thence to the naval station at San Francisco. Government west bound messages are sent from Washington via Annapolis Radio station or commercial land lines to San Francisco, where they are relayed via Honolulu, Guam and Cavite to the Borie and thence to the American fleet off Yokohama. The U. S. S. Sacramento is stationed at Woosung,

RADIO SPELLING BEE MAKES BOW IN WEST

"Exam" Queries Transferred from Blackboard to Air

SACRAMENTO, CAL. — Examination questions for California high school pupils have been transferred from the blackboard of the little red school house to the more up-to-date Radio broadcasting station.

The first Radio spelling bee in America, and probably the first in the world, was announced recently by Will C. Wood, state superintendent of public instruction.

Superintendent Wood will dictate the examination material to high school students in every section of California by means of Radio. The test will be limited to graduating classes and will take place at a date to be set in November.

Operator of WNAC Resigns to Sell Radio Apparatus

BOSTON, MASS.—Sam Curtis, who for the past year has been chief operator of the WNAC, The Shepard Stores station here, has resigned and will take immediate charge of the new Radio department established by the C. C. Harvey Company, dealers and manufacturers of pianos. When the Shepard Stores started their Radio department Mr. Curtis was placed in charge, and when John Shepard 3rd, established WNAC, Curtis was made chief operator. Curtis was for a number of years a naval Radio operator and later connected with the Radio Corporation of America.

ready to relay Radio messages. The naval service can now deliver official dispatches to Yokohama within twenty-four hours.

Many Radio experts feel that the terrible disaster and the severing of communication out of Japan will aid materially in establishing better Radio service between Nippon and the world. The policy of the Japanese government has been to control Radio, although American commercial companies have been endeavoring to provide better stations and transmission for some time. It is now hoped that an opportunity will be given American companies to establish high-powered stations in Japan.

CONTENTS

Radio Digest, Illustrated, Volume VI, Number 11, published Chicago, Illinois, September 22, 1923. Published weekly by Radio Digest Publishing Company, 123 West Madison Street, Chicago, Illinois. Subscription rates, yearly, Five Dollars; Foreign Postage One Dollar additional; single copies, Ten Cents. Entered as second-class matter at the postoffice at Chicago, Illinois, under the Act of March 3, 1879.

"All the Live News of Radio".....1 to 9
Flewellling Answers to Queries..... 4
On the Air in France and England; An Evening at Home with the Listener In; Receiving Record Hook-Ups..... 5
The Week's Advance Broadcast Programs..... 7
The Antenna Brothers, Comic Strip..... 9
Editorials; Indi-Gest; Condensed by Dielectric..... 10
First Step for Beginners in Radio, Chapter XVIII—Using Alternating Current on Tubes, by Thomas W. Benson..... 11
Simplex Picture Diagram, English Crystal and R. F. Amplifier Circuit..... 12
How to Make Loop Aerial De Luxe, by H. J. Marx..... 13
Human "Earful" Measured by Aid of Radio Tubes, by C. W. Tucker..... 15
R.D.-98, Three Tube Radio Frequency Circuit; The Reader's View; Reviews of Books..... 16
Receiving Set Built in a Match Box; Other Kinks..... 17
Questions and Answers..... 18
Radiophone Broadcasting Station Directory, Part II—Station Schedules..... 19
Radio Illustrated, a Page of Pictures..... 20

Looking Ahead

King Miloplex I—The Elaborate Excavations in Egypt become insignificant in comparison to the discovery of the Miloplex circuits. There are three of them, each one better than the last. We promised to divulge the first of this family of circuits this week but didn't have the space. But next issue it will be present—with bells on. Simple, efficient, and not expensive. Build a Miloplex.

How to Test Your Set—A Cracker-Jack Good Article by Thomas W. Benson next week. Mr. Benson will tell how to "shoot trouble" and give advice worth keeping for reference when your set goes dead.

The Story of Radio for Novices, Beginning Next Issue—A series by Marvin W. Thompson, known nationally as a Radio engineer and writer, and now associated with the Digest as a member of its staff. Tell your beginner friends to read Mr. Thompson's series starting with the first chapter.

Notes on the Reflex De Luxe—by H. J. Marx. This article, to appear in the September 29 issue, will tell the latest improvements on this popular set. It will include a simplified circuit for use with a loop aerial. Mr. Marx is planning a series of articles on building a Super-Heterodyne receiver. Watch for this!

Understood by Everybody. What? The Simplex Diagram, of Course. Next week it will illustrate the popular single tube super-regenerative set. You can't wire wrong with a Simplex Diagram.

A Book-Type Condenser You Can Make—Easy and few tools required. Read this how-to-make article along with other kinks next week.

R.D.-99, an Improved Ultra Audion Hook-Up—Has two stages of audio frequency amplification and a reputation for reliance. Wired for jacks, too! See it next issue.

Newsstands Don't Always Have One Left

WHEN YOU WANT

Radio Digest

YOU WANT IT!

BE SURE OF YOUR WEEKLY COPY BY SUBSCRIBING NOW

SEND IN THE BLANK TODAY

Publisher Radio Digest, 123 West Madison St., Chicago, Illinois. Please find enclosed check M. O. for Five Dollars (Six. Foreign) for One Year's Subscription to Radio Digest, Illustrated. Name, Address, City, State.

Ready for Immediate Delivery—ALL PARTS FOR THE

Acmedyne Circuit

as described by Mr. Lawrence Cockaday in the August issue of "Popular Radio," employed in the wonderful Melco-Supreme Receiver.

Tuned Radio-Frequency at Its Best

- Telos Vario-Transformer.....\$8.50
Telos Variometer.....\$6.00
AMSCO Compensating Condenser.....\$3.00
Complete knock-down parts for Melco-Supreme, including drilled engraved Bakelite panel, solid mahogany cabinet, and three No. 201-A Radiotrons.....\$80

All goods absolutely guaranteed by manufacturer and ourselves. Shipped immediately, prepaid, on receipt of purchase price. Write for price list on our complete line of quality apparatus.

RADIO & MECHANICAL TRADING CORP. 23 Warren Street NEW YORK CITY

WD-11 and WD-12 Tubes Repaired

- WD-11 or WD-12.....\$3.50
C-300 or UV-200..... 2.75
C-301 or UV-201..... 3.00
C-302 or UV-202..... 3.50
C-301A or UV-201A..... 3.50
Moorehead Detectors..... 2.75
Moorehead Amplifiers..... 3.00
DV-6 or DV-6A..... 3.00
Also the new UV-199..... 3.50
NEW DX 1 1/2 VOLT TUBES. 4.00

All tubes guaranteed to work like new. Mail Orders Given Prompt Attention "24 Hour Service"

RADIO TUBE CORP. 55 HALSEY STREET NEWARK, N. J.

Tubes Sent Parcel Post, C. O. D.

## AMATEURS TO RACE SOL CROSS COUNTRY

TEN STATIONS COMPETING WITH SUN'S RAYS

From Coast to Coast Amateurs Enter Speed Contest to Aid Science Research

HARTFORD, CONN.—On the morning of Sunday, September 23, Radio amateurs of both coasts will attempt to beat Old Sol across the continent in spectacular daylight tests. Their transmitters will be pitted against sunlight in their efforts to relay messages across the country between sunrise and sunset, according to F. H. Schnell, traffic manager of the American Radio Relay League.

At least ten picked amateurs on both the Pacific and Atlantic coasts will start messages as the sun comes over the horizon, and they will be relayed by intervening stations. By evening it is expected that most of the messages will have reached their destination, and for the brass pounders the contest with Father Time will end in a Radio victory.

### Tests Have Scientific Value

These tests have a real scientific value, since they will demonstrate to what extent the sun affects transmission. Every one familiar with Radio knows that reception over long distance is more difficult during the daytime than in darkness, this being caused, it is believed, by the ionization of the earth's atmosphere by the sun's rays.

The disastrous effect of sunlight upon Radio has been noticed, and it is confidently expected by league officers that definite comparisons may be drawn which will prove helpful in an investigation of this subject.

In this connection some interesting information may be gathered from the experience of Donald H. Mix, league Radio operator with the MacMillan Arctic exploration party, since he must transmit messages and news reports through both daylight and darkness from the Arctic seas to amateurs at home.

### Starting Points Kept Secret

No one will know from what stations the messages will start, says Mr. Schnell, referring to the daylight tests. He says everybody will have the same chance of picking up a message and relaying it along the line.

He advises all amateurs to keep a record of everything they hear, and whether they use standard or daylight saving time. These records should be sent to American Radio Relay League headquarters at Hartford, Conn., by October 1.

The starting gong rings as the sun rises!

## ALL-STAR YEARDAY FOR CANUCK PLANT

French-English Station to Mark Birth with Program of Choice Performers

MONTREAL, QUE.—Canada's popular station, CKAC, situated on the roof of La Presse, the French newspaper here, will celebrate its first anniversary September 29. For the occasion, Manager Jacques N. Cartier who announces in both French and English, is preparing a special program which will be given by the most popular artists who have performed during the last year. This program will be doubly interesting, since most all numbers will be either sung, or played, for the first time in America. It will be one of the best all star entertainments ever broadcast by any station and will be typically bi-lingual. The concert will begin at 8:00 p. m., eastern time. All messages received during the evening will be acknowledged.

During the first year, CKAC has had more than 4,000 artists performing singly and one hundred orchestras, besides a number of choirs and bands. During the summer months, over 3,000 American listeners in have visited the studio while touring the province of Quebec. Many have suggested that French courses be given from this station.

### Stenographers Copy Talk

by Air to Win Fair Prize

PHILADELPHIA.—Radiophans here who are stenographers were recently given an opportunity to win part of the \$100 in prizes offered by the management of the sesquicentennial exposition, which is to be held here in 1926 to commemorate the Declaration of Independence. A speech broadcast by Dr. John W. Stockwell from Station WMAQ, Chicago, was transcribed by competing stenographers. Dr. Stockwell spoke at the rate of ninety-five words a minute; contestants were obliged to submit their transcriptions within forty-eight hours. Dr. Stockwell spoke later from Stations KYW and WDAP, Chicago.

## SERIALIZE MYSTERY NOVEL FOR WJZ FANS

NEW YORK.—The present serialization of William Johnston's new mystery novel, "The Wedding Cipher," by Station WJZ of the Radio Corporation of America marks a new departure in the serialization of fiction.

A chapter of Mr. Johnston's story is being broadcast from the station here every Thursday evening at 8:45 p. m. eastern standard time.

## 'JERRY,' REAL DUMMY, TELLS 'EM FROM WOR

NEWARK, N. J.—"Jerry," the dummy who works for Marshall Montgomery, famous ventriloquist, broadcast a stunt and a new song for his master recently from Station WOR here. "Jerry" claims he is the first ventriloquist's dummy to broadcast from a Radio station. When interviewed on the subject, "Jerry" said that he enjoyed the experience very much.

## THE OLD FAMILY TOOTHBRUSH



Remember the old barber shop quartet song, "The Old Family Toothbrush"? Well, save the toothbrush, says Miss Shirley Vernon, above, who has found that dipping it in alcohol and scrubbing the surfaces of old crystals, is a great help to fanning cat whiskers © K. & H.

## PRAISE GRAIN PRICE SERVICE FROM WBAP

Huge Sums Change Hands Daily on Radio Reports

FORT WORTH, TEXAS.—WBAP (Star-Telegram) cotton and grain reports have become an indispensable innovation throughout the entire Southwest. Daily thousands of dollars change hands, based upon the quotations that go out into the ether hourly to interested listeners in every section of the cotton and grain belt.

Texas and Oklahoma farmers have the latest prices almost at the same time they are posted on the big exchanges of New Orleans, New York or Chicago.

WBAP frequently receives letters commending them for the service given and thankfulness for the messages the Cowbells (symbol of WBAP) bring. In country towns a leading drug or merchandise store often installs a Radio receiver for the benefit of members of the community. Prices are posted to apprise the sons of the soil of the worth of their products.

### Keystone Operators Organize

UNIONTOWN, PA.—In the home of Merton Crichton a meeting of Radio operators was held, during which steps were taken to form an organization of amateur operators holding government licenses. Important events in western Pennsylvania will be sent by the operator in whose district they take place.

## 4,000 Storekeepers Hear Unique Program of WSY

Birmingham Plant Entertains Huge Convention Audience

BIRMINGHAM, ALA.—One of the big entertainment features for the more than 3,000 Alabama retail merchants in all lines of trade, who held their annual convention in Birmingham, was a program by Station WSY here.

The entertainment was held at East Lake park, where a high power receiving set was installed especially for the occasion. Radio talks were also delivered by Col. R. A. Mitchell, vice president of the Alabama Power Company, and A. M. Kennedy, inventor of electrolytic arsenic. Special music was furnished by the WSY Serenaders.

This program was in some respects one of the most remarkable ever received and sent over WSY, due to the fact that it was one of the largest Radio audiences ever assembled in Birmingham, numbering close to 4,000 people. Another unique feature was that many of the Alabama merchants present were from small country towns, some of them also conducting stores far out in the country. There were several hundred in the audience who never had the opportunity of listening to a Radio before. A number of the small town merchants and the country merchants said they expected to order receiving outfits as soon as they reached home.

## NEW STATION KYW STRONGER IS PLAN

RUSH CHANGES ON CHICAGO PLANT FOR OPERA

Shortened Wave Length and Other Obstacles to Be Overcome by Westinghouse Engineers

CHICAGO.—Improvements in KYW, Westinghouse Station here, are being rushed to completion, to make the station the most powerful in the United States.

New equipment is being installed under the direction of Chief Engineer Walter C. Evans, who has had charge of the mechanical section of the station virtually since it inaugurated broadcasting in the West two years ago. Particular effort is being made to have the station operating at its peak by the opening of the football season, so that the fans again may witness by Radio the conference games at Stagg Field.

### To Broadcast Opera Again

Following the football season will come the opera season, when again KYW will broadcast to all parts of North America the music of the world's greatest voices from the Auditorium stage.

The difficulties encountered in changing to the 870-kilocycle (345-meter wave length) required by the government May 15, are being overcome. First there was the changing of the equipment to the new wave length, which was in itself an engineering feat. When this was done a new difficulty was encountered.

### Surmount Difficulties

The Commonwealth Edison building, on which the station is located, and the surrounding buildings were found to be so tuned as to prevent the station getting out at its full power. The entire Radio engineering staff of the Westinghouse Electric & Manufacturing Company, under the direction of C. W. Horn and Mr. Evans, was put to work, and it is believed that the defect has been remedied. Within a few weeks KYW will be itself again, with greater power and greater sending range.

Plans for additional service, musical, news and features are now being perfected by Director Wilson J. Wetherbee of KYW so that the Radio patrons may look forward to a greatly improved station when the equipment is remodeled.

## WHOLE CONTINENT HEARS CHILD CRY

Baby Wails in Midst of Quiet Intermission at Detroit Church Service

DETROIT.—A baby's cry that was heard all over the United States, parts of Canada and even down in old Mexico is an actual experience that took place recently from the Central M. E. church here. It occurred during a quiet intermission in the service that was being broadcast by WCX, the Detroit Free Press.

The child, in the arms of its mother in the north gallery of the church many feet from the microphone, becoming dissatisfied with its surroundings, suddenly started to wail. It was only for a second or two as the mother immediately hurried from the gallery. Nothing was thought of it at the time although the Radio engineer at the WCX studio in the Free Press building half a mile away said the wail came into the room so shrilly it almost startled him. The engineer said at first he thought the child might be in the studio.

Nothing more was thought of the instance until when a few days later letters began to come in making reference to the child's wail. Some writers declared the wail was almost uncanny in its reality.

## Radio Enables Woman, Deaf 60 Years, to Hear Music

POMONA, CALIF.—After having been deaf since she was three years of age, Mrs. Manley Everham, 63 years old, of this city, recently heard vocal and instrumental music by means of Radio. She said that when she first placed the 'phones to her ears she could hear only queer noises, but after a few minutes she was able to distinguish voices and the sound of instrumental music. During the demonstration Mrs. Everham became greatly excited, frequently clapping her hands in applause.

### Milwaukee "Bug" Club Resumes

MILWAUKEE, WIS.—The first meeting of the Milwaukee Radio Amateurs' Club, Inc., following the annual summer recess was to be on the evening of September 20, in the Trustees' Room of the Milwaukee Public Museum. On September 27 the society will hold its annual corporate meeting at which there will be an election of the members of the board of directors.

# COMMERCIAL RADIO MUDDLED IN ITALY

## ROME BARS RATE CUTTING BY COSTANO PLANT

### Germany's Offer of Transmitter as Part of Reparations Also Complicates Situation

ROME, ITALY.—Governmental and civil Radio experts in Italy are considering the advisability of accepting a Radio station as a part of Germany's reparations to this country. The new broadcasting plant at Coltano (near Pisa), operating under the supervision of the Italian navy, transmits messages daily to South America at a cost far below that required by cable companies.

But the imminent completion of the sub-sea line from Fiumicino, seventeen miles from Rome, to Rio de Janeiro and Buenos Ayres by way of Malaga and the Azores, 7,300 miles, presents a form of opposition to the German Radio and the Coltano outfit which cannot be underestimated.

#### Two New Cables Viewed

The new cable, which is being installed at great cost, must be assured a profitable revenue. Were it to compete with the Coltano plant's present rates gain would be impossible; if the new cable company were to lower its proposed tariffs the Coltano station would be placed under a heavy financial strain.

Another element of doubt enters the situation in the form of the projected cable to North America by way of juncture with the old German line on the Azores, which line was part of Germany's war indemnity to Italy.

As the Italian government has evidently assured the cable company that the Coltano station will not decrease its tariffs, the fate of that Radio plant is deemed uncertain. This situation, coupled with the fact that the German Radio station offered to Italy is obsolete, or soon will be, due to Marconi's research, it is considered inadvisable by many to accept the German outfit.

## KENTUCKY LISTENS TO CANADA "CO-OP" TALK

### CFAC, Calgary, Sends American Expert's Views to Thousands

CALGARY, ALTA.—The speeches in Calgary of Aaron Shapiro of San Francisco, internationally known as a co-operative marketing expert, were broadcast recently over CFAC, the Calgary Herald station here. He spoke in this province of the formation of a voluntary wheat pool to handle Alberta's bumper wheat crop.

Eight thousand persons attended meetings held here and hundreds of thousands heard Shapiro speak, even down in Kentucky, where he organized the Burley tobacco pool. In Edmonton, C.J.C.A. broadcast his addresses.

#### Tell History of Navy

WASHINGTON.—In view of the close relationship between the Navy Department and the Radio Corporation of America, the Radio Corporation has arranged to turn over to the Navy Department at least once a month its new broadcasting station here, WRC. On these nights, experienced naval officers will tell the story of the navy and the U. S. Marine Band will play.

Radio broadcasting stations in England operate on different wave lengths, the lowest being 369 meters and the highest 415 meters.

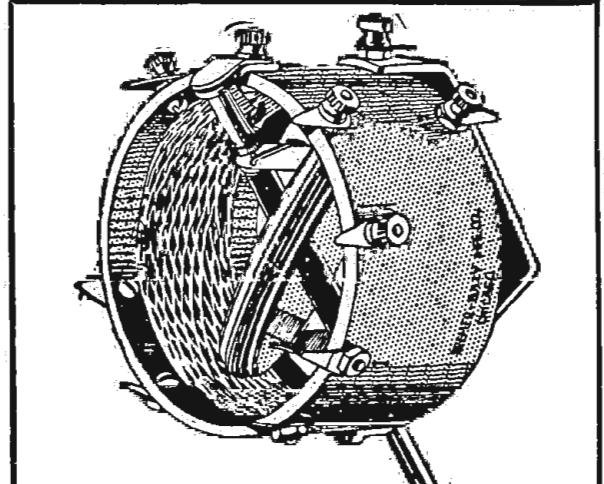

### The B.-T. Universal Tuning Unit

There is nothing on the market you can compare with the Bremer-Tully Universal Tuner. It is an entirely new instrument, that gives unequalled selectivity and control on practically all modern circuits. It replaces coils in Reinartz, Ultra Audion and other regenerative and non-regenerative circuits. In most circuits taps are not required. Also gives remarkable results in Radio Frequency and all Reflex Circuits.

Simple to connect, no soldering; connections made to binding posts, easily changed to any circuit. Photo diagrams of above, also special Bremer-Tully circuits, in addition to key of windings, furnished. Write today.

**BREMER-TULLY MFG. CO.**  
532 South Canal Street, CHICAGO, ILL.

# FLEWELLING ANSWERS TO QUERIES

By E. T. Flewelling

(Editor's Note.—This department is written by Mr. Flewelling, the inventor of the famous super circuit. From the questions sent him each week care of Radio Digest, he picks the one considered most informative for all and answers it in this column.)

#### Has Hollow Cistern Voice

(Submitted by F. S. W., Newark, N. J.)

Question. I have used a Flewelling set for some time and have had really unusual results with it. It is of the three condenser type and I would like to change over to the simplified single condenser circuit. I would appreciate a diagram showing the connections for 'phone jacks for the amplifier and also an answer as to why the set works better on a ground alone and why it will reproduce a voice as though it were in a hollow room or like a voice in a hollow cistern?

Answer. We expect to publish shortly a few notes on the amplifier for the Flewelling set and believe that they will give you the answer that you wish concerning that part of the outfit.

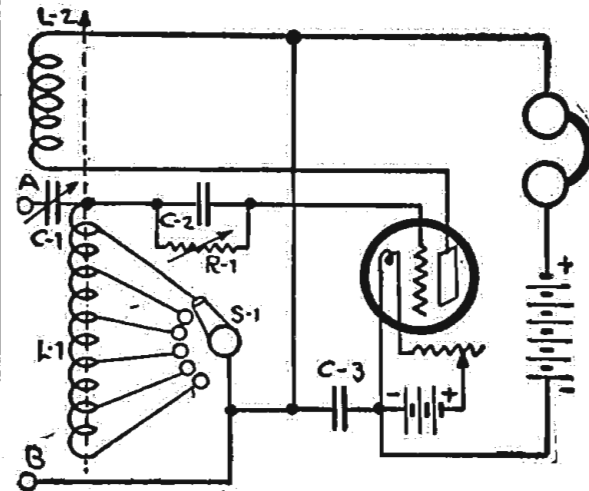

I have stated before that I cannot recommend the use of filament control jacks either in the Flewelling circuit or any other type of circuit. Were we to have available jacks that had no inherent capacity, it would be very convenient at times to use them and we could no doubt do so successfully. The jack on the market at the present moment unfortunately has, comparatively speaking, a large amount of capacity and is not at all suitable.

The fact that your set works best on a ground alone might be due to several conditions, which we have not the space to go

into. I have often seen such a condition, however, and invariably results were very comparable to those secured on a good antenna, so that I would not worry about this condition were I in your place.

Your last point in regard to the voices sounding as though it were in a hollow cistern brings up a point that I believe will be of great interest to the users of Radio sets in general and, of course, particularly to those owning the Flewelling set. It has been observed that if a regenerative circuit, particularly of the tickler coil type, is used with a stopping condenser either across the phones or the primary of the audio transformer, that several things happen, among these things being the tendency to more or less muffle the incoming signal phone, though it seems at times to increase the strength of the signal.

As a matter of fact, there is not much need for a stopping condenser in a regenerative circuit of the tickler type. Regeneration and oscillation may be secured to a sufficient extent by the use of the proper number of turns

of wire on a tickler coil itself and by proper B battery voltage on the plate. It works out something like this: If you have a circuit of this type and find that it will not oscillate and therefore not regenerate properly with the condenser at its full maximum value, and if the circuit is not too far out of proportion, you will be able to make it oscillate and regenerate by increasing the plate battery voltage or by placing a stopping condenser say to .002 mfd. across the transformer or phones.

These are, however, methods which are not considered to be the best practice. Proper oscillation and regeneration should be secured by the correct balancing of the coils in the set rather than by any auxiliary methods, although, of course, the B battery should be just to its correct point even with a properly designed set.

Your tendency to receive muffle signals will be increased as stopping condensers are used or the turns on the tickler coil are increased beyond their proper amount. The single condenser Flewelling layout was given with quite a large number of turns on the tickler coil because best average results were secured in this way, but it is easily conceivable that individual requirements might call for the cutting down of the number of turns, in which case there would be, of course, no objection.

## Extremely Simple to Operate

Although the two highest refinements in modern radio—Regeneration and Tuned Radio Frequency Amplification—are combined in

### The New GREBE Broadcast Receiver



this instrument is extremely simple to operate. A tuning dial, graduated in wavelengths, enables you instantly to locate a desired station.

Licensed under Armstrong U.S. Pat. No. 1,113,149

Write for "Grebe Radio in the Well-Appointed Home."

A. H. GREBE & CO., Inc. RICHMOND HILL, N.Y.

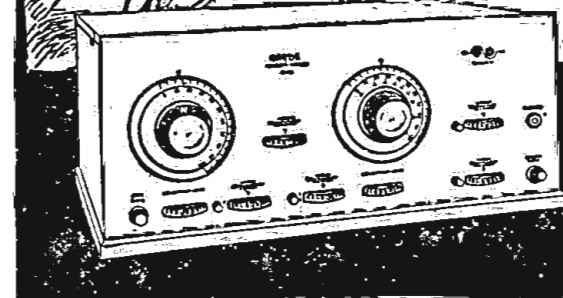

## Long Distance Receiver That Tunes Out Local Stations



Michigan "Midget" \$27.00

Wonderfully selective tuning. The tuning is done with two long levers. Distant stations have been brought in while local stations were broadcasting. Much quicker, easier and more accurate than knob-and-dial tuning. The front panel of the Michigan "Midget" Receiver slopes at an angle of 70 degrees, bringing controls into direct line of vision.

Cabinet—handsome mahogany finish—is only 14½ in. long; yet it holds three No. 6 dry cells and B battery.

The Receiver, without batteries, weighs only 6 lbs., making it easily portable.

Can be used with one or more sets of headphones; or by adding a Michigan two-stage amplifier, brings in distant signals through any good loud speaker.

Covers all wave lengths up to 600 meters. Works efficiently, with all standard 6-volt tubes, and especially adaptable for all dry-cell tubes.

The ideal home set because mother and the children can operate it quite as successfully as dad or big brother.

Price, without batteries or tube—\$27.00. Try your dealer first. If he does not handle it, remit direct and send dealer's name and address.

DEALERS: Don't miss this popular, quick-selling, nationally advertised radio masterpiece. Write for discounts, also information about the "Michigan" Two Stage Amplifier and our exclusive line of Condensers, Variocouplers, Variometers, Rheostats, etc. Every instrument guaranteed.

## MICHIGAN RADIO CORPORATION

GRAND RAPIDS, MICHIGAN

## PREMIER "HEGEHOG" AUDIO FREQUENCY TRANSFORMER

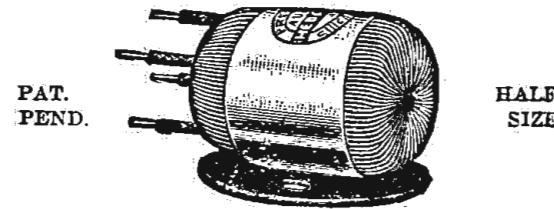

PAT. PEND. HALF SIZE  
MAXIMUM VOLUME MINIMUM DISTORTION 100 PER CENT SHIELDED MOUNTS ANYWHERE

PRICE \$3.50  
RATIOS—1 to 3, 1 to 4, or 1 to 5

The Most Efficient, Compact Transformer ever designed. Ask Your Dealer for the Premier "Hegehog."

Full Specifications on Request

**Premier Electric Company**  
Est. 1905  
3810 Ravenswood Avenue, CHICAGO, ILL.

## What About It?

Isn't it about time to stop experimenting with multiple control circuits and build one that, combining ease of assembly and operation, loudness, clarity and selectivity of signals, as well as beautiful appearance, is excelled by none?

## THE ELGIN SUPER-REINARTZ RADIO RECEIVING SET

Embodies all the advantages of the well known Elgin Reinartz (the set which was largely responsible for the popularity of this wonderful circuit) and many others. It is much louder, more selective, requires no storage battery, and can be used with excellent results on a short or loop aerial. It has brought in California stations two thousand miles from Elgin, clearly and without interference on a loud speaker with only one tube, and that while our powerful local station was broadcasting three miles away.

Could you ask for more? Write for circular giving one, two and three bulb hook-ups of this remarkable circuit. IT IS FREE.

**ELGIN RADIO SUPPLY CO.**  
207 East Chicago Street ELGIN, ILLINOIS

# ON THE AIR IN FRANCE AND ENGLAND

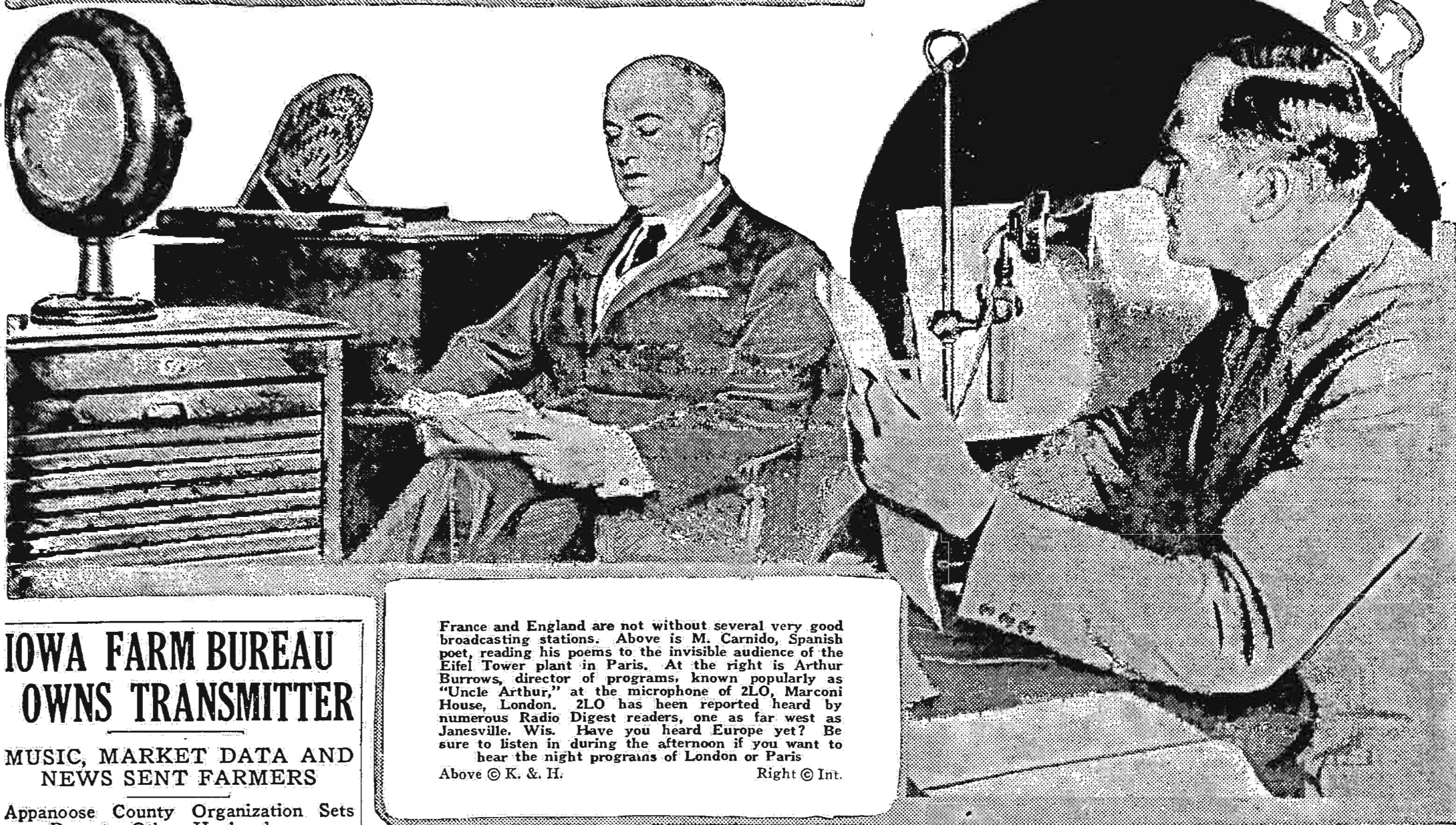

France and England are not without several very good broadcasting stations. Above is M. Carnido, Spanish poet, reading his poems to the invisible audience of the Eiffel Tower plant in Paris. At the right is Arthur Burrows, director of programs, known popularly as "Uncle Arthur," at the microphone of 2LO, Marconi House, London. 2LO has been reported heard by numerous Radio Digest readers, one as far west as Janesville, Wis. Have you heard Europe yet? Be sure to listen in during the afternoon if you want to hear the night programs of London or Paris.

Above © K. & H.

Right © Int.

## IOWA FARM BUREAU OWNS TRANSMITTER

MUSIC, MARKET DATA AND NEWS SENT FARMERS

Appanoose County Organization Sets Pace to Other Husbandmen of Hawkeye State

CENTERVILLE, IA.—Tillers of Appanoose county compose the first farm bureau organization in the United States which operates by means of Radio.

Recently they installed at their headquarters here a broadcasting outfit and receiving set of the latest type. They receive the markets, news and entertainment.

Station "XYZ," as it is known, has attracted wide attention in Iowa, due to the fact that it is under farmer control.

The broadcasting outfit, a 100-watt telephone, has an antenna current of four amperes. The maximum range is 1,200 miles; the normal range is 250 miles. A modified Hartley circuit is used.

There are eighty receiving sets on the farms of Appanoose county, besides that in the county agent's office. Each day at noon the latest news and market reports are sent to the farmers. The system takes the place of tedious hours at telephones, sending market news and like information to individuals.

The people of Iowa point to the Appanoose county station as an instance of the epoch marking Radio as a practicable means of communication.

## Atlanta Marvels at WSB's Portable Pick-Up Outfit

ATLANTA, GA.—A portable pick-up, ready to hurry to any point of interest, is a highly popular feature of WSB's summer Radio service. The outfit is mounted on a motor truck and may be put into action in a few seconds. Cooperation by the local telephone company, coupled with a relay system of astonishing simplicity designed by A. W. Tison, chief operator at WSB, supplies many innovations. A recent twenty-four hour motorcycle race, the Elks' parade, eye-witness broadcast of Atlanta baseball games, indoor and outdoor athletic events, meetings, celebrations and many other events were broadcast by the portable pick-up.

## Radio Bulbs Brighten Home as Iowa Storm Darkens It

WATERLOO, IA.—While John Hanson, Radio distributor of this city, was assisting his wife in the canning of tomatoes, a recent storm damaged the lighting system in his home. There were no kerosene lamps, not even a candle. Hanson studied the situation a minute, then brought out a Radio receiver, put in two one-ampere bulbs, and "There was light."

There are now about 50,000 privately owned Radio receiving sets in France—as compared to an estimated 2,000,000 in the United States.

## RECEIVING RECORDS? SEND 'EM IN—

(The following items are based on letters from Radiophans, who have been doing good distance work. Readers submitting letters for publication must diagram their sets.—DX Record Editor.)

**Many Controls; Easy to Tune**  
Although his set has a number of controls and might be called a double regenerator, Harrison Shays, 90 Cobourg Ave., Winnipeg, Canada, claims that it is extremely easy to tune and certainly brings in the stations across the boundary from coast to coast and from the far away gulf.

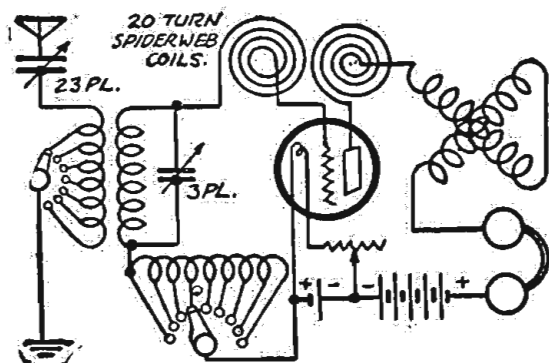

A tapped coil (about 60 turns tapped every 6 turns would suffice) is used to tune the grid circuit in resonance with the plate circuit. The latter is tuned by a variometer as shown in the diagram. In addition to the resonant regeneration, a feedback is supplied by two 20-turn spider web coils, mounted so as to be coupled closely or loosely, which are connected in the plate and grid circuits of the tube. A variocoupler with tapped primary provides the tuning unit. Several of the stations heard regularly by Mr. Shays are more than 1,500 miles distant.

**Excellent Work in July**  
Good summer work on a very simple set is reported by K. H. Emerson, Randolph, Vt., who says that he has heard 43 stations during

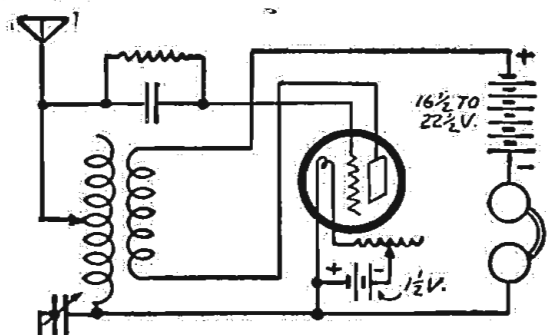

the month of July. The list he submits shows that he heard a number of plants ordinarily not classed as DX-ers, having only small av-

erage transmitting ranges, a truly worthy

His set, diagram for which is given, is a single circuit regenerator, using a homemade coupler constructed from a rolled oats box and wire taken from an induction coil given Mr. Emerson by the local telephone company. The coupler cost him five cents, exclusive of the dial. The diagram shows a 1 1/2-volt battery to supply the filament lighting current when using a WD-12 tube. This, however, is replaced by a 4 1/2-volt battery when a UV-199

tube is used. Both types of tubes were found to give equal results with this circuit.

## KYW Has "Farmers' Night"

CHICAGO.—Every Tuesday is now "farmers' night" at KYW, Westinghouse station here. Twenty-seven minutes between 9:01 and 9:28 o'clock, Eastern time, given over to the broadcasting of information for the benefit of farmers.

## AN EVENING AT HOME WITH THE LISTENER IN

Station and City	Met.	Monday	Tuesday	Wednesday	Thursday	Friday	Saturday	Sunday
CFCA Toronto, Ont.	400	6:00-7:00	6:00-7:00	6:00-7:00	6:00-7:00	6:00-7:00	6:00-7:00	4:45-5:45
CFCN, Calgary, Alta.	440	10:00-11:00	.....	.....	.....	11:30-1:30	11:00-1:00	.....
CKAC, Montreal, Que.	430	.....	6:00-9:00	.....	6:00-9:00	.....	.....	.....
KDKA, E. Pittsburgh, Pa.	326	4:00-9:00	4:00-9:00	4:00-9:00	4:00-9:00	4:00-9:00	4:00-9:00	6:30-7:30
KFAF, Denver, Colo.	360	9:00-10:00	9:00-10:00	9:00-10:00	8:30-9:00	9:00-10:00	9:00-10:00	.....
KFI, Los Angeles, Calif.	469	8:45-1:00	8:45-1:00	8:45-2:00	8:45-1:00	8:45-2:00	8:45-2:00	10:00-1:00
KGW, Portland, Ore.	492	9:30-2:00	12:00-1:00	10:00-11:00	12:00-1:00	9:00-2:00	12:00-1:00	9:00-10:00
KHJ, Los Angeles, Calif.	395	8:45-12:00	8:45-12:00	8:45-12:00	8:45-12:00	8:45-12:00	8:45-12:00	10:00-12:00
KPO, San Francisco, Calif.	423	10:00-12:00	10:00-12:00	.....	.....	10:00-12:00	.....	.....
KSD, St. Louis, Mo.	546	8:00-10:00	8:00-10:00	8:00-10:00	.....	8:00-10:00	8:00-10:00	.....
KYW, Chicago, Ill.	345	.....	7:00-9:00	7:00-9:00	7:00-9:00	7:00-9:00	7:00-9:00	.....
NAA, Radio, Va.	435	5:45-7:20	6:05-7:20	6:25-8:40	5:45-7:40	7:00-7:40	.....	.....
PWX, Havana, Cuba	400	.....	.....	8:00-10:30	.....	.....	8:00-10:30	.....
WBAP, Fort Worth, Texas	476	9:30-10:30	9:30-10:30	9:30-10:30	9:30-10:30	9:30-10:30	7:00-7:30	7:30-8:00
WBZ, Springfield, Mass.	337	5:00-8:00	6:30-8:00	5:00-8:00	6:30-8:00	5:00-8:00	6:30-8:00	7:30-8:30
WCX, Detroit, Mich.	517	7:30-9:00	7:30-11:00	7:30-9:00	7:30-9:00	7:30-9:00	.....	6:15-7:15
WDAF, Kansas City, Mo.	411	6:00-1:00	6:00-1:00	6:00-1:00	6:00-1:00	6:00-1:00	6:00-1:00	4:00-5:00
WDAJ, College Park, Ga.	258	7:30-11:30	7:30-11:30	10:30-11:30	7:30-11:30	7:30-11:30	7:30-11:30	7:30-11:30
WDAW, Chicago, Ill.	360	.....	6:00-1:00	6:00-1:00	6:00-1:00	6:00-1:00	6:00-1:00	8:00-11:00
WDAR, Philadelphia, Pa.	395	5:30-8:55	5:30-8:00	5:30-9:00	5:30-6:00	5:30-6:00	5:30-6:00	.....
WDT, New York, N. Y.	405	.....	.....	5:00-5:50	.....	9:00-10:00	.....	.....
WEAF, New York, N. Y.	492	.....	5:30-6:00	.....	5:30-8:00	5:30-6:00	5:30-8:00	.....
WFAA, Dallas, Tex.	476	8:30-9:30	8:30-12:00	.....	8:30-9:30	8:30-9:30	8:30-12:00	9:30-11:00
WFI, Philadelphia, Pa.	395	5:00-5:30	5:00-7:00	5:00-9:30	5:00-7:00	5:00-5:30	.....	5:30-6:30
WGL, Medford, Mass.	360	.....	5:00-7:30	5:30-8:00	5:00-7:30	5:30-8:00	5:30-8:00	6:30-10:00
WGM, Atlanta, Ga.	429	9:30-10:30	9:30-10:30	12:00-1:00	9:30-10:30	9:30-10:30	9:30-10:30	7:30-8:00
WGR, Buffalo, N. Y.	319	4:30-8:00	4:30-6:45	4:30-8:00	4:30-5:30	5:30-8:00	4:30-6:45	.....
WGY, Schenectady, N. Y.	380	6:45-9:00	6:45-9:00	.....	6:45-9:00	6:45-11:00	.....	5:30-6:30
WHA, Madison, Wis.	360	7:30-8:30	.....	7:30-8:30	.....	7:30-8:30	.....	.....
WHAS, Louisville, Ky.	400	.....	7:30-9:00	7:30-9:00	7:30-9:00	7:30-9:00	7:30-9:00	.....
WHAS, Troy, N. Y.	380	8:00-9:30	.....	.....	.....	.....	.....	.....
WHB, Kansas City, Mo.	411	.....	8:00-10:00	.....	8:00-10:00	.....	.....	8:00-10:00
WHK, Cleveland, O.	360	5:00-5:30	5:00-5:30	7:00-8:55	5:00-5:30	5:00-5:30	5:00-5:30	7:00-8:55
WIP, Philadelphia, Pa.	509	4:00-5:30	4:00-10:00	4:00-5:30	4:00-8:00	4:00-5:30	4:00-10:00	.....
WJAX, Cleveland, O.	390	.....	6:30-8:30	.....	6:00-8:30	.....	.....	.....
WJZ, Chicago, Ill.	448	.....	9:00-1:00	9:00-1:00	9:00-1:00	9:00-1:00	9:00-1:00	5:00-8:00
WJY, New York, N. Y.	405	.....	5:30-9:30	.....	5:30-9:30	5:30-9:30	.....	4:00-4:30
WJZ, New York, N. Y.	455	5:30-9:30	5:30-9:30	5:30-9:30	5:30-9:30	5:30-9:30	5:30-9:30	6:30-8:30
WKAQ, San Juan, P. R.	360	.....	9:00-10:55	.....	.....	.....	9:00-10:55	.....
WLAG, Minneapolis, Minn.	417	5:30-10:00	5:30-10:00	5:30-12:00	5:30-10:00	5:30-12:00	6:30-10:30	7:45-8:45
WLW, Cincinnati, O.	309	7:00-9:00	9:00-11:00	7:00-9:00	9:00-11:00	.....	.....	.....
WMAQ, Chicago, Ill.	448	.....	6:00-9:00	6:00-9:00	6:00-9:00	6:00-9:00	6:00-9:00	.....
WMC, Memphis, Tenn.	500	8:00-9:30	8:00-12:00	.....	8:00-9:30	8:00-12:00	8:00-9:30	.....
WOAI, San Antonio, Texas	385	.....	9:30-10:30	.....	7:30-8:30	.....	9:30-10:30	5:00-6:00
WOAW, Omaha, Neb.	526	9:00-10:00	9:00-10:00	.....	.....	9:00-10:00	9:00-10:00	9:00-10:00
WOC, Davenport, Ia.	484	7:00-8:30	.....	10:00-11:00	7:00-8:30	7:00-8:30	9:30-10:30	7:00-9:00
WOO, Philadelphia, Pa.	509	5:45-9:00	.....	.....	5:45-9:00	.....	.....	.....
WOR, Newark, N. J.	405	6:00-10:00	4:15-5:30	6:00-10:00	4:15-5:30	4:15-5:30	6:00-10:00	.....
WOS, Jefferson City, Mo.	441	8:00-9:30	.....	8:00-9:30	.....	8:00-9:30	.....	.....
WSAI, Cincinnati, O.	309	.....	7:00-9:00	.....	7:00-9:00	.....	9:00-11:00	.....
WSB, Atlanta, Ga.	429	8:00-12:00	8:00-12:00	8:00-12:00	8:00-12:00	8:00-12:00	8:00-12:00	7:30-9:15
WSY, Birmingham, Ala.	360	8:00-8:45	.....	8:00-8:45	.....	8:00-8:45	.....	7:30-8:30
WWJ, Detroit, Mich.	517	6:00-7:30	6:00-7:30	6:00-7:30	6:00-7:30	6:00-7:30	.....	7:30-8:30

Instructions for Use.—All the hours above are given in Central Standard Time. If your city uses Eastern Time, add one hour to each of the periods stated; if your city uses Mountain Time, subtract one hour; if your city uses Pacific Time, subtract two hours. If in addition your city is using Daylight Saving Time, add one hour to this result.

## Station WJZ Explains Use of Direct Wires in Sending Various Programs

Microphones, Usually Concealed in Manhattan Places of Amusement, Are Connected by Temporary Equipment to Main Circuits Thence by Lead-Offs to Main Artery System

By J. L. Bernard

NEW YORK.—Few people who read the Radio programs have a clear conception of what is meant by the phrase "this concert will be broadcast by Station WJZ by direct wire from the Theater" or wherever the event is held. The layman's imagination does not seem to favor the idea of using wires in connection with Radio broadcasting.

The heart of the "direct wire" system used by WJZ is composed of three main arteries. In addition to these three arteries there are nine additional permanent wires. From these lines are run underground to Aeolian Hall Building thence to the control room of the station. Various other net works of wires are tapped off, and which lead to the station from the main circuits. This artery system enables WJZ to reach many points in Manhattan, and affords the Radio audience a multitude of concerts, talks, and plays which they could otherwise never receive.

### Success of Play Determined First

When a Broadway production is to be broadcast, a member of the program staff is detailed to review the play about a week in advance of the proposed date—if the play has enough of its success in the songs and lines, it is considered a suitable Radio subject, while if its success is due to costumes and dancing, with no entertainment for a "blind" listener, it is of no value as a broadcast feature.

Assume that a show has been found suitable—what procedure is followed by the "outside crew" of the station? About two days before the broadcasting date a wireman installs the necessary backstage wire connections, which are of course temporary in the case of the theaters. On the afternoon of the day set for the performance the outside crew set up their equipment backstage. The microphone is concealed in the footlights in most cases, but may be suspended above the stage. Everything is in readiness by the time the first of the audience straggle in, and the announcer arrives in full evening regalia to introduce the theater audience to the Radio audience.

The announcer generally has a microphone just back of the scenes, so as to be in close touch with all that goes on, but occasionally is given a small dressing room, with interphone communication with the stage. As soon as the performance is over the microphones are removed.

### How Goldman Concerts Are Sent

In the case of the Goldman Band Concerts on the Mall, which are being sent out from WJY-WJZ, the wire is run through the trees in the park, well out of reach of passers-by, to the main circuit thence to the station by way of a lead-off. The wire is tied high up on one of the posts of the band stand, a table is requisitioned, and the microphone stands in full view of the leader. The announcer uses a separate microphone, and stands

as near the leader as possible so that one may time his actions to fit in with the leader.

In St. Thomas' Church the installation is permanent, the microphone being properly located to effect perfect transmission from all parts of the service. There is a permanent installation in the Mark Strand Theater, and the music which is broadcast from this theater every week has become one of the most popular of Radio concerts.

Everything is run according to a time schedule, with no allowance for hitches or mishaps (not one has ever occurred). The theater management has fitted up the screen room as a miniature broadcasting studio, and after the artists have completed their turns on the stage they may broadcast a purely Radio program.

### Behind in the Background

Visitors at the Waldorf-Astoria, Plaza, Commodore, and the Astor Hotels this past season have known the purpose of the little black disc suspended in the midst of the tea-room orchestra. The little black disc is the microphone, the only part of the transmitting apparatus visible to the public.

Hidden in the near background there are always two operators and an announcer. Because they always keep in the background very few of the diners and dancers at the various hotel roofs have realized that the music to which they danced was being sent out to all parts of the country—there is so little ostentation about the process that it seems uncanny.

### Cheers Porto Rico Lepers

SAN JUAN.—The leper colony on Cabras island, Porto Rico, recently watched with intense interest and excitement the installation of a receiving outfit. The exiles are now overjoyed to find themselves once again in contact with human affairs.

A variometer and a variable condenser make a set easily operated by beginners.

## HAWAII RE-SENDS CONCERTS IN U. S.

Honolulu Plant Picks Up Programs Broadcast by KHJ, Los Angeles

HONOLULU, T. H.—New honors are now being reaped by Station KHJ, the Los Angeles Times, this time consisting of the rebroadcasting of the Times' programs by a Honolulu station here, KGU, the Honolulu Advertiser.

This marks the first instance of transoceanic rebroadcasting, doubly remarkable in view of the difficulties of long-distance reception during the summer months in the South Pacific. However, KHJ is being heard nightly in all parts of the Hawaiian group.

During the cool part of last season several stations in the states featured rebroadcasting programs from KHJ, particularly in the South and Southwest. KGU, the Honolulu Advertiser, is only a fifty-watt station, but it makes KHJ programs available to a large area in the Pacific.



## Receive in Comfort —Get Long Distance

by using ALL-AMERICAN AMPLIFYING TRANSFORMERS

Once you have equipped your set with "All-American" Transformers, you will be impressed with the absence of distortion—the amazing volume.

Combined with these unusual qualities, there is that continuance of performance, day after day—week after week—and year after year.

It is not that they occasionally perform well, but that they do so consistently, that has made "All-American" Transformers the choice of the big majority of radio fans and their adoption as standard equipment by the leading receiving set manufacturers of America. Go to your dealer and ask to see "All-American" Transformers. If he can't supply, write us, giving his name. Book of successful hookup sent on receipt of 2c to cover postage.

**RAULAND MFG. CO.**  
200 No. Jefferson St., Chicago, Ill.

## State and City Officials Lead First Club, Chicago

CHICAGO.—The first Chicago Radio club to be incorporated and chartered has just been established in the 49th ward, from which it gets the name of "The 49th Ward Radio club, Inc." The president is Phillip J. Alt, of the city department of buildings. George A. Williston, a state representative, is vice-president and John E. Maloney, runner up in the aldermanic contest last spring is secretary.

The charter roll of members totals 400. The meeting place, temporarily, will be at 1359 Devon avenue.

It is now possible to send a Radio letter to London and Germany at rates only slightly higher than postage.

## Kellogg Radio Equipment For Better Results Transformers

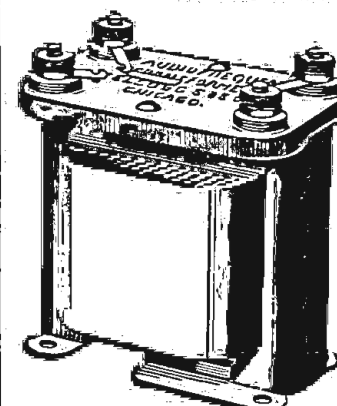

Kellogg transformers are designed to overcome defects of existing types and to furnish distortionless amplification of all audio frequencies. Built complete by the Kellogg Company, using highest grade wire, maroon enameled metal case, and molded Bakelite top. The primary and secondary binding posts are accessibly placed on top of the transformer.

These binding posts are plainly marked, so that there need be no error in assembling. Every Kellogg transformer is thoroughly tested before leaving the plant, and we guarantee the purchaser a product of exceptional efficiency.

No. 501 Ratio 4½ to 1.....\$4.50  
No. 502 Ratio 3 to 1.....4.50

**KELLOGG SWITCHBOARD & SUPPLY COMPANY**

1066 West Adams Street, Chicago, Illinois

### WATCH FOR OUR ANNOUNCEMENT

To those Radiophans who appreciate high-grade, standardized Radio apparatus we will offer parts designed by our Radio Engineer.

**E. J. Jewelling**

(Inventor of the Filter Circuit)



### BUELL MANUFACTURING COMPANY

Cottage Grove at 30th Street  
CHICAGO

### WATCH FOR OUR ANNOUNCEMENT

## Coast to Coast on One Tube and No Body Capacity

These popular hook-ups use UV-199, WD-11 or WD-12 Tubes. One hook-up gives selectivity and 1500 miles with absolutely no body capacity, while the other gives the remarkable distance of coast to coast. Both prints postpaid for 50 cents or any of the above tubes postpaid \$5.45.

**RADIO OUTFITTING & SUPPLY CO.**  
Box 1107 LANCASTER, PA.

## The New Grebe Broadcast Receiver



**Point No. 4** YOU MAY RECEIVE all broadcasting with this Receiver—its range 200—600 metres covers the wavelengths of all broadcasting stations.

Just One of its Seven Points of Satisfaction

Licensed under Armstrong U. S. Pat. No. 1,113,149

Ask Your Dealer

A. H. GREBE & CO., Inc.  
Richmond Hill, N. Y.

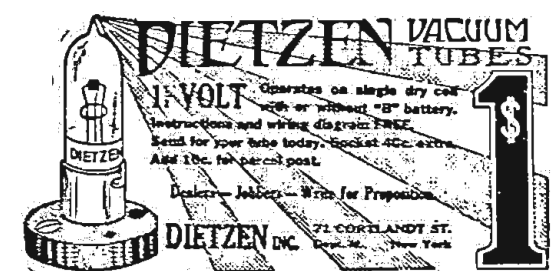
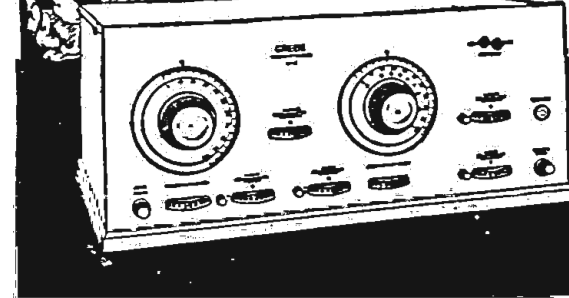

**RADIO VIA PARCEL POST AT N. Y. PRICES**  
Standard Parts Only, in Original Packing  
NO SALVAGED GOODS SOLD  
Where "Money Back Policy Prevails"

PHONES	For Parcel Post	Ins. Add
Dietzen 3,000 Ohm.....	\$3.75	\$0.12
Brandes .....	5.75	.14
Dicograph .....	5.75	.14
VARIABLE CONDENSERS		
Dietzen 14-Plate Vernier.....	2.65	.14
Dietzen 24-Plate Vernier.....	2.95	.16
Dietzen 46-Plate Vernier.....	3.45	.19
TRANSFORMERS (Audio Frequency)		
Dietzen .....	3.45	.12
Ames 4½ to 1.....	2.95	.12
TRANSFORMERS (Radio Frequency)		
Cotoco .....	2.45	.13
Owl .....	.95	.10
MISCELLANEOUS		
Reinartz Coils .....	1.25	.08
Sta-Put Plug .....	.40	.06
Freshman Grid Leak & Cond. combined .....	.85	.12
Dietzen Single Circuit Jack.....	.40	.06
Aerial Insulators .....	.10	.02
Ritter Portable Loop.....	1.00	.10
Argus Lightning Arrestor.....	.95	.09
Welsh Peanut Tube.....	2.00	.08
Peanut Tube Socket.....	.50	.03
Switch Lever, Padlock Type.....	.19	.06
Ammeter Testing B Battery.....	.49	.08
Hydrometers .....	.49	.08
Double Phonograph Attachment.....	.95	.08
Cockaday Coil .....	2.25	.14
2 Coll Honeycomb Mounts.....	2.95	.12
Wave Trap .....	4.95	.15
Electric Soldering Iron.....	3.95	.15
100 Feet Copper Antenna Wire.....	.39	.08
RHEOSTATS		
Dietzen, 6 ohm.....	.39	.06
Dietzen, 30 ohm.....	.49	.06
SOCKETS		
Bell V. T. & W. D. 11.....	.89	.10
V. T. Bakelite.....	.50	.10
DIALS		
2-inch .....	.25	.06
3-inch .....	.35	.08
4-inch .....	.49	.08

**Modell's**  
ESTABLISHED 1899

191 Fulton St., Dept. F-28, New York City  
9 New York Stores  
America's Greatest Radio Mail Order House

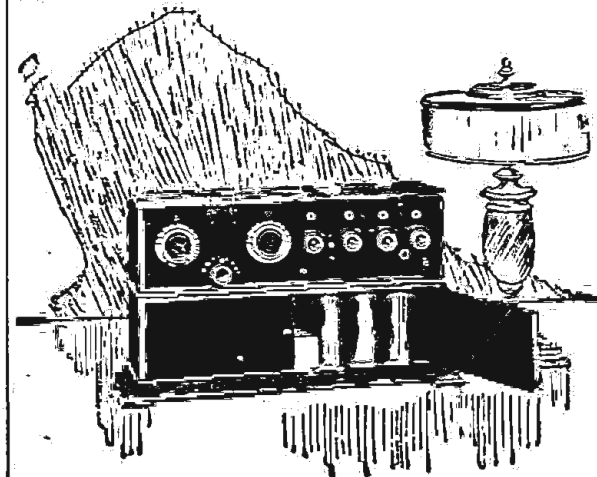

## Abroad at Home with a Crosley Model X-J Price \$65

Wonderful opera from New York, dance music from Chicago, stock quotations, current speeches, amusing stories from where you will—all these are brought to your home and fireside if you own a Crosley Model X-J.

This beautiful new Model, similar in construction to the famous Crosley Model X but with greater refinement of detail, is the last word in perfection among radio sets. Its low price—\$65—the battery cabinet pictured above costs \$16 extra—makes it doubly attractive and it more than lives up to the Crosley slogan—Better—Cost Less.

FOR SALE BY GOOD DEALERS EVERYWHERE

Write today for free Catalog which shows the complete Crosley Line

**Crosley Manufacturing Co.**  
9494 Alfred Street Cincinnati, O.

# The Week's Advance Broadcast Programs

## Tuesday, September 18

CFCA, Toronto, Ont. (Eastern, Daylight Saving, 400), 8:00-9:00 P. M., Selections from "Iolanthe," Star Concert Orchestra; "The Spirit Flower," Kate Jackson, contralto; "Nocturne in E Flat," Harry Adaskin, violinist; "Yearning for You," Star Concert Orchestra; "The Cry of Rachel," Kate Jackson; "Cavaleria Rusticana," Star Concert Orchestra; "Romance," Harry Adaskin; "Tales of Hoffman," Star Concert Orchestra; "Thank God for a Garden," Kate Jackson; Selections from "Maytime," Star Concert Orchestra.

KDKA, E. Pittsburgh, Pa. (Eastern, 326), 9:00 A. M., Music; 11:30, Victrola and Victor records, S. Hamilton Company; Piano and piano rolls, C. C. Mellor Company; 5:15 P. M., Dinner concert, Grand Symphony Orchestra; 6:45 Children's period; 7:05, "The White Collar Job," Dr. Thomas S. Baker, lecturer; 7:20, Concert, "A Necklace of Love," "I Hid My Love," "Less Than the Dust," "Till I Wake," "From the Land of the Sky Blue Water," Florence Bletcher, contralto; "Stars in a Velvet Sky," "Spring Song," "Rosary," "Sing Me to Sleep," Ronald Lavelle, cornetist; Marilla Kohary, accompanist.

KLW, Portland, Ore. (Pacific, 492), 3:30-4:00 P. M., Talk by Jeannette P. Cramer; 10:00-11:00, Dance Music, George Olsen and his orchestra.

KHJ, Los Angeles, Calif. (Pacific, 492), 12:30-1:15 P. M., News items; Music, 2:30-3:30, Matinee musicals; 6:45-7:30, Children's program, bedtime story, "Uncle John"; 8:00-10:00, Program, Ontario Business Men's Association; Simpson's Jazz Orchestra.

KSD, St. Louis, Mo. (Central, 546), 8:00 P. M., Program, male quartet; Arthur S. Schmitt, E. S. Wakefield, Walter H. Schmitt, Worth M. McCown.

KYW, Chicago, Ill. (Central, 345), 1:35 P. M., Studio program; 5:50, Children's bedtime story; 7:00-7:58, Musical program, Elyn Swanson Engel, director; Herbie Mintz, pianist; Sallie Meukes, accompanist; Isham Jones and his orchestra.

WDAP, Chicago, Ill. (Central, Daylight Saving, 360), 10:00 P. M., Fredrick W. Wright, pianist; Bob Angelo, accompanist; Other artist furnished by Alexander Nakutin; Jack Chapman and his dance orchestra.

WDAR, Philadelphia, Pa. (Eastern, Daylight Saving, 395), 12:00-12:54 P. M., Organ recital, Stanley Theater; dinner music, Arcadia Cafe Orchestra; 2:00-3:00, Concert, Arcadia Cafe Orchestra; Song recital; 4:30-5:55, Piano solos, Edna Finestone.

WDT, New York, N. Y. (Eastern, Daylight Saving, 405), 12:00-1:00 P. M., Popular song recital, by Luckey the pianist-composer, assisted by Lena Sanford Roberts; Paul Bass and orchestra.

WFAA, Dallas, Texas (Central, 476), 12:30-1:00, Address, DeWitt McMurray; 8:30-9:30, Harold Hart Todd, pianist; Henry Kramer, violinist; 11:00-12:00, Belcanto Male Quartet.

WFI, Philadelphia, Pa. (Eastern, Daylight Saving, 395), 1:00 P. M., Dinner music, Meyer Davis Bellevue Stratford Concert Orchestra; 3:00, Piano recital, Loretta Kerk; 7:00, Children's Ora Half Hour, Stories by Cousin Sue; 8:00, Boy Scout Program; 8:30, Concert; 9:00, Song recital; 10:30, Dance music, Bellevue Stratford Dance Orchestra.

WGI, Medford Hills, Mass. (Eastern, Daylight Saving, 360), 12:00 M., Selections on the Edison, Brunswick, Chickering-Ampico; Readings, H. D. M.; 3:00 P. M., Amrad Women's Club; Hospitality Talk; Marjorie Drew; Selections, Chickering-Ampico and Brunswick; 5:00, "Twilight Tales," Eunice L. Randall; 7:00, Kiwanis' Night, four speakers; Quartet contest of Kiwanis members.

WGR, Buffalo, N. Y. (Eastern, Daylight Saving, 360), 12:00-12:30 P. M., George Albert Bouchard, organist; 6:30-7:00, George Albert Bouchard, organist; 7:00, Digest of the day's news; scientific topics.

WGY, Schenectady, N. Y. (Eastern, 380), 1:00 P. M., Music and address, Mrs. E. C. Whitmyer; 7:45, Musical program; Orchestra selection, Publication Department; Orchestra; Address, Martin P. Rice; Ethel Thomas, soprano; H. M. Mott-Smith, cellist; J. F. Quinlan, baritone; Edward A. Rice, violinist; Quartet selections; Walter Reagles, tenor; L. De Witt Efner, saxophonist; Duet, Ethel Thomas, soprano, J. F. Quinlan, baritone; A. O. Coggeshall, tenor.

WHAS, Louisville, Ky. (Central, 400), 4:00-5:00 P. M., Concert, Mary Anderson Theater Orchestra, Ollie Jones, conductor; Selections played on Rialto Theater organ; 7:30-9:00, Concert, Ray Pfaff and his orchestra; Reading, "An Interesting Historical Episode."

WIP, Philadelphia, Pa. (Eastern, Daylight Saving, 509), 3:00 P. M., Artist recital; 8:02, Dinner music, Dick Regan's WIP Concert Orchestra; 7:00-7:30, Bedtime stories, Uncle Wip; 8:00, Short talk; 8:15, Song recital; 8:30, etc., "Twilight Tales," Eunice L. Randall.

WJAZ, Cleveland, Ohio. (Central, 390), 7:30 P. M., Concert program, Cleveland News-Leader; Dance music, Emerson Gill Orchestra; Vocal selections, Fred Irvine.

WJAZ, Chicago, Ill. (Central, Daylight Saving, 447.7), 10:00 P. M.-2. A. M., Selections, Oriole Orchestra, Dan Russo, director; "Bird of the Wilderness," "Somewhere a Voice Is Calling," "Indian Bird Song," "The Nighthale," May Goldberg, soprano; Violin solos, Roul Kantrow; "Kashmiri Song," "Serenade," R. C. Ball, baritone; "Etude in E Flat," "March Grottesque," Harriet Weeber, pianist.

WLW, Cincinnati, Ohio. (Eastern, 309), 10:00 P. M., Special Atonement program, Avondale Synagogue; Circle Orchestra, popular entertainment.

WMAQ, Chicago, Ill. (Central, Daylight Saving, 447), 4:30 P. M., Program, Gunn School of Music; 9:00-9:15, Hotel La Salle Roof Garden Orchestra; 9:15-10:00, Musical program, M. and Mrs. Paul Vernon.

WDC, Davenport, Iowa. (Central, 484), 12:30 P. M., Chimes concert; 3:30 P. M., A. G. Hinrichs, lecturer; 5:45, Chimes concert; 7:00, Special, Art Landry and his "Call of the North"; WLAG Orchestra.

WOD, Philadelphia, Pa. (Eastern, Daylight Saving, 509), 11:30-11:30 A. M., Organ recital, Mary E. Vogt; 12:00-12:55, Dinner music, Wanamaker Tea

Room Orchestra; 4:45-5:00, Organ recital, Mary E. Vogt.

## Wednesday, September 19

CFCA, Toronto, Ont. (Eastern, Daylight Saving, 400), 8:00-9:00 P. M., Overture, "Raymond," Star Concert Orchestra; "Which Love Fills Your Heart with a Song," Jean McLean, soprano; "Londonderry Air," Mannie Roth, violinist; "Serenade D'Amour," Star Concert Orchestra; "Love and Joy," Jean McLean; "Danse Trapac," Star Concert Orchestra; "Caprice Vieuxnois," Mannie Roth; "Yearning for You," Star Concert Orchestra; "Love la Meant to Make Us Glad," Jean McLean; Grand March, "Aida," Star Concert Orchestra.

KDKA, E. Pittsburgh, Pa. (Eastern, 326), 9:00 A. M., Music; 11:30, Victrola and Victor records, S. Hamilton Company; piano and piano rolls, C. C. Mellor Company; 5:15 P. M., Dinner concert, KDKA Little Symphony Orchestra; 6:30, Literary Program, Marjory Stewart; 6:45, Children's period; 7:05, "Saving the Engineer at Night," William E. Mott, lecturer; 7:20, Concert, Overture, "Jolly Robbers," "Musical Jig, Saw," "The Lost Chord," "Golden Cockerel," Italian Street Songs, "Faust," "Evolution of Dixie," EDKA Little Symphony; "Ritorna Vincitor," "The Wanderer," "Bon Tom, Suzon," "The Moon Drops Low," Erna Nidermeiser, soprano; D. de Vere Jamison, accompanist.

KGW, Portland, Ore. (Pacific, 492), 3:30-4:00 P. M., Children's program, Aunt Nell; 8:00-9:00, Concert Swetland's orchestra; 10:00-11:00, Dance music, George Olsen and his orchestra.

KHJ, Los Angeles, Calif. (Pacific, 492), 12:30-1:15 P. M., Florence Taylor Black, violinist; 2:30-3:30, Florence Taylor Black, violinist; 6:45-7:30, Children's bedtime story, "Uncle John"; 8:00-10:00, Harry C. Knox, flutist.

KSD, St. Louis, Mo. (Central, 546), 7:00 P. M., Concert, Aberg's Concert Orchestra.

KYW, Chicago, Ill. (Central, 345), 5:50 P. M., Children's bedtime story, 7:00-7:58, Musical program; Harry Geise, pianist; Mary Lee, soprano; Isham Jones orchestra; 8:05-8:25, Reviews, Llewellyn Jones.

PWX, Havana, Cuba. (Eastern, 400), 9:00-11:30 P. M., Municipal Band of Havana, classic and national music.

WDAP, Chicago, Ill. (Central, Daylight Saving, 360), 10:00 P. M., Joseph Steindel, violinist and other artists; Jack Chapman and his dance orchestra.

WDAR, Philadelphia, Pa. (Eastern, Daylight Saving, 395), 12:00-12:54 P. M., Organ recital, Stanley Theater; Dinner music, Arcadia Cafe Concert Orchestra; 2:00-3:00, Concert, Arcadia Cafe Concert Orchestra; Short talk on care of children; 4:30-5:55, Song recital and short talks; 7:30-8:00, Dream Daddy, bedtime stories; 8:00, Dance music, Howard Lanin's Arcadia Cafe Dance Orchestra.

WDT, New York, N. Y. (Eastern, Daylight Saving, 405), 12:00-1:00 P. M., Piano recital, Alfred J. Stone; Solo, Lillabelle Barton, Wm. Gibson, accompanist; 7:00-8:00, Piano recital, Dorothy Braman; Address, Katherine Parker Clivette; Song recital; Rosalind Fabian, Dorothy Braman, accompanist.

WFAA, Dallas, Texas. (Central, 476), 12:30-1:00 P. M., Address, Dr. J. F. Kimball.

WFI, Philadelphia, Pa. (Eastern, Daylight Saving, 395), 1:00 P. M., Dinner music, Meyer Davis Bellevue Stratford Concert Orchestra; 3:00, Concert; 6:30, Dance music, Meyer Davis Bellevue Stratford Dance Orchestra.

WGI, Medford Hills, Mass. (Eastern, Daylight Saving, 360), 12:00 M., Selections on the Edison, Brunswick, Chickering-Ampico; Readings, H. D. M.; 3:00 P. M., "Twilight Tales," Eunice L. Randall; 6:45, Girls' Hour, "Camp Fire Girls," by "Big Smoke"; 7:30, "Science Up to Date," by the "Scientific American"; Musical program, Charles L. H. Wagner, poet-composer.

WGR, Buffalo, N. Y. (Eastern, Daylight Saving, 360), 12:00-12:30 P. M., George Albert Bouchard, organist; 6:30-7:30, George Albert Bouchard, organist; 7:00,

Digest of the day's news; 9:00, Concert, Eleanor Taft and Associates.

WHAS, Louisville, Ky. (Central, 400), 4:00-5:00 P. M., Concert, Mary Anderson Theater Orchestra, Ollie Jones, conductor; Selections, Rialto Theater Organ; 7:30-9:00, Concert, Chimes Moyers Orchestra; Reading, "An Interesting Historical Episode."

WIP, Philadelphia, Pa. (Eastern, Daylight Saving, 509), 3:00 P. M., Program of popular songs; 6:02, Dinner music, Jordan-Lewis Dance Orchestra under direction of Bob Lewis; 7:00-7:30, Bed time stories, Uncle Wip.

WJAZ, Chicago, Ill. (Central, Daylight Saving, 447.7), 10:00 P. M.-2 A. M., Selections, Oriole Orchestra; "Until," "On the Road to Mandalay," "The Rosary," "Sweet Little Woman of Mine," Charles W. Green, tenor; Cello solos, Herbert, Wels; "Hoar No Ye Winds and Waves," "The Want of You," "At Dawning," "When You and I Were Young Maggie," H. Arnold Michal, baritone; Piano solos, Bessie Barnes; Dan Russo, violinist.

WLW, Cincinnati, Ohio. (Eastern, 309), 4:00 P. M., Crosley Forum; Piano solos, William Schmitt; 8:00, Special program, arranged by Mrs. O. B. Kaiser; Elmsr. Alchale Novelty Dance Orchestra; Songs by Joe Richards; Virginia Benham, accompanist; "Formation of Habit," M. D. Schrieber, lecturer.

WMAQ, Chicago, Ill. (Central, Daylight Saving, 447), 4:30 P. M., Program, Cosmopolitan School of Music and Dramatic Art; 7:00-7:30, Stories for children, Georgene Faulkner, story lady; 8:00-9:15, Hotel La Salle Roof Garden Orchestra; 9:15-10:00, Musical program, Ernest Dewey.

WOC, Davenport, Iowa. (Central, 484), 12:00 M., Chimes concert; 3:30 P. M., Music; Clyde G. Kern, lecturer; 6:30, Sandman's visit; 8:00, Pipe organ recital, Erwin Swindell; 10:00, Program, P. S. C. Choral Club.

WOD, Philadelphia, Pa. (Eastern, Daylight Saving, 509), 11:00-11:30 A. M., Organ recital, Mary E. Vogt; 12:00-12:55 P. M., Dinner music, Wanamaker Tea Room Orchestra; 4:45-5:00, Organ recital, Mary E. Vogt.

WTAM, Cleveland, Ohio. (Eastern, 390), 8:00 P. M., Initial program.

WWJ, Detroit, Mich. (Eastern, 517), 12:05 P. M., Detroit News Orchestra; 7:00, Detroit News Orchestra; Towu Crier; Anthony Bonall, tenor; Mrs. Laurencelle, soprano; Prof. Bonavia, pianist.

## Thursday, September 20

CFCA, Toronto, Ont. (Eastern, Daylight Saving, 400), 8:00-9:00 P. M., Selections from "Faust," Star Concert Orchestra; "Far Away," Estelle Fox, soprano; "Evening Song," Star Concert Orchestra; "Eill, Eill," Harry Adaskin, violinist; Suite No. II "Spanish Dances," Star Concert Orchestra; "Charmant Oiseau," Estelle Fox; "Badinage," Star Concert Orchestra; "Tango," Harry Adaskin; "Extase," Star Concert Orchestra; Soprano and solos, Estelle Fox; Intermezze, "Naida," Star Concert Orchestra.

KDKA, E. Pittsburgh, Pa. (Eastern, 326), 9:00 A. M., Music; 11:30, Victrola and Victor records, S. Hamilton Company; Piano and piano rolls, C. C. Mellor Company; 5:15 P. M., Dinner concert, Grand Symphony Orchestra; 6:45, Children's period; 7:20, Concert, Quartet numbers, "The Americans Come," "Katy Did," "Lassie O Mine," "Molly's Eyes," "Lassie O Mine," "The Old Flag Never Touched the Ground," "One Solemn Hour," Charles L. Billeter, first tenor; Homer R. Gardner, second tenor; J. A. Rogers, baritone; Willard Hamilton, basso; Violin solos, Samuel Gluck.

KGW, Portland, Ore. (Pacific, 492), 3:30-4:00 P. M., Woman's program, Child Training; 10:00-11:00, Dance music, George Olsen and his orchestra.

KHJ, Los Angeles, Calif. (Pacific, 492), 12:30-1:15 P. M., Program, Ray Fruth, saxophonist; Harold

Southwick, pianist; Jack Lawton, saxophonist; 2:30-3:30, Matinee musicals; 6:45-7:30, Program, Gago Christopher; Rev. Thomas Lutman.

KYW, Chicago, Ill. (Central, 345), 1:35 P. M., Studio program; 5:50, Children's bedtime story; 7:00-7:58, Musical program, Lillian Alleen Lindwer, soprano; Herbie Mintz, accompanist; Irene Vopat, pianist; Herbie Mintz, pianist; 8:05-8:25, Good reading, Rev. C. J. Pernin.

WDAP, Chicago, Ill. (Central, Daylight Saving, 360), 10:00 P. M., John Stamford, pianist; Jack Chapman and his dance orchestra.

WDAR, Philadelphia, Pa. (Eastern, Daylight Saving, 395), 12:00-12:54 P. M., Organ recital, Stanley Theater; Dinner music, Arcadia Cafe Concert Orchestra; 2:00-3:00, Concert, Arcadia Cafe Concert Orchestra; Piano solos, Edna Finestone; 4:30-5:55, Short talks and song recital; 7:30-8:00, Bedtime stories, Dream Daddy.

WDT, New York, N. Y. (Eastern, Daylight Saving, 405), 12:00-12:50, Song recital, Fred Taylor, Betty Walty, Vaughn ds Leath, accompanist.

WFAA, Dallas, Texas. (Central, 376), 12:30-1:00 P. M., "Keeping Fit," Dr. J. B. Cranfill; 8:30-9:30, William A. Sutherland, Jr., pianist.

WFI, Philadelphia, Pa. (Eastern, Daylight Saving, 395), 1:00 P. M., Dinner music, Meyer Davis Bellevue Stratford Concert Orchestra; 3:00, Concert of Ednyfed Lewis, tenor; John Vandersloot, bass; Loretta Kerk, pianist; 8:30, Dance music, Meyer Davis Bellevue Stratford Dance Orchestra; 8:00, Recital; 8:30, Dance music.

WGI, Medford Hills, Mass. (Eastern, Daylight Saving, 360), 12:00-1:00 P. M., Selections on the Edison, Brunswick, Chickering-Ampico; Readings, H. D. M.; 3:00 P. M., "Twilight Tales," Eunice L. Randall; 7:00, "State Government," F. W. Cook; Radio farce, "Converting Bruce," by the Amrad Players.

WGR, Buffalo, N. Y. (Eastern, Daylight Saving, 360), 12:00-12:30 P. M., George Albert Bouchard, organist; 6:30-7:00, George Albert Bouchard, organist; 7:00, Digest of the day's news, Boy Scout Radiograms, "The American Boy."

WGY, Schenectady, N. Y. (Eastern, 380), 1:00 P. M., Music and address, courtesy Modern Priscilla; 7:45, Travelogue address on India, Dr. Sigel Roubin; Instrumental selection, WGY Orchestra; Edward Rice, violinist.

WHAS, Louisville, Ky. (Central, 400), 4:00-5:00 P. M., Concert, Mary Anderson Theater Orchestra, Ollie Jones, conductor; Selections, Rialto Theater Organ; 7:30-9:00, Concert, Ella Sharrard Violin Quartette; Walter Bodeman, Christine Jansing, Dorothy Neat, Theodore Williams.

(Continued on page 8)

## Something You'll Want to Keep

**8 Free**  
Hook-Ups and Symbols

Just send a two-cent stamp and a dealer's name. No further obligation, but possibly a reminder that you need a perfect crystal. If so, slip 50 cents for both into the envelope, and thank yourself ever after that you tried a B-Metal Loud Talking Crystal. It's a piece of radio jewelry and works as good as it looks. Sold under our liberal Money Back Guarantee to Satisfy.

**B-METAL REFINING COMPANY**  
3134 TRUMBULL AVE., DETROIT, MICH.

**Loop Aerial**  
**\$1.25**

Postpaid in U.S.A.  
Complete with  
Binding Posts and  
55 ft. 22 gauge  
Wire.

Send for literature describing our  
Radio Desks, Cabinets and Loud  
Speaker Cabinets.

**ROBBINS WOODWORKING CO.**  
Dept. C LIBERTYVILLE, ILL.

## "RED-HEADS"

Better Radio 'Phones

HERE'S what we say about "Red-Heads"—they're EXTRA-ORDINARY radio receivers. We believe they're the best receivers on the market today. Superlatives are easy to say and hard to back up. Here's how we back up ours. We GUARANTEE that you'll like "Red-Heads." You take no risk in buying them. We'll refund your money plus postage if you don't agree with us after trial.

"Red-Heads" are the lowest priced, high-grade, aluminum-backed receivers on the market. Nine years of receiver experience are behind their quality.

**MODEL "F" \$6.50**  
Complete 3000-Ohm set with cord and head band; aluminum back; brown-red ear caps; small, light-weight; exquisitely sensitive and fine-tuned.

**"RED-HEAD" Jr. \$5.00**  
Complete 2000-Ohm set of new design; a remarkable production with the same workmanship and guarantee as our standard Model "F".

Since 1915 Pioneers in Radio—year after year striving to achieve one purpose—better and better radio receivers.

**THE GUARANTEE**  
Money back if after 7 days' trial you're not satisfied that "Red-Heads" are the BEST receivers on the market at the price.

**The NEWMAN-STERN Co.**  
Dept. RD, E. 12th St., Cleveland, O.

A new D. X. Dry Cell Receiving Set with headphones using Radio Frequency—\$87.00, without tubes or batteries

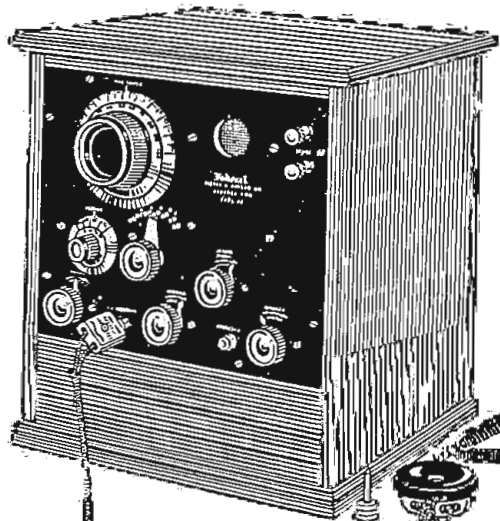

130 Federal Standard Radio parts offer the radio enthusiast a complete line of guaranteed parts of one quality—the best.

At last a dry cell set that will tune out interference and bring in D. X. stations when local stations are broadcasting.

A Buffalo user tuned in Tampa, Florida, on the loud speaker while a powerful local station was operating only four miles away. Federal engineering skill plus Federal quality make such feats simple.

**Federal**  
Radio Equipment

**Federal Telephone and Telegraph Company**  
Factory: BUFFALO, NEW YORK  
Boston New York Philadelphia Chicago San Francisco Pittsburgh  
Bridgeburg, Canada London, England

## CARTER NEW 15 POINT Inductance Switch

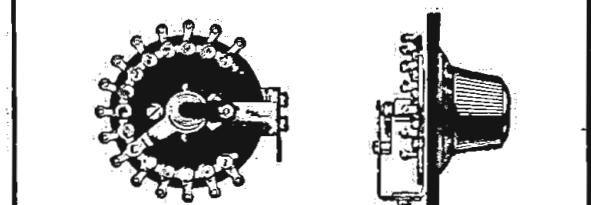

Self-contained. Only one panel hole. Easy to install. Pig-tail connection eliminates sliding contacts. Westinghouse Micarta insulation prevents leakage. Solder terminal and contact one piece. Adjustable stop pin. New type dial knob eliminates panel numbering. Can be used as "B" battery tap switch.

Price: \$2.00  
Ask Your Dealer Write for free Jack-switch hook-ups  
**CARTER RADIO CO.** 205 South State Street CHICAGO

ADVANCE PROGRAMS

(Continued from page 7)

WIP, Philadelphia, Pa. (Eastern, Daylight Saving, 509), 3:00 P. M., Song recital; 7:00, Bedtime stories and roll call, Uncle Wip; 8:00, Talk, "Where to Go and How to Get There," by Eugene E. Hogle, secretary of the Automobile Club of Philadelphia; 8:15, Dance music, Ace Brigade's Ten Virgilians from Hotel Walton Roof; 9:00, Organ recital, Karl Bonawitz from Germantown Theater; 9:15, Recital; 10:10, Dance music, Charlie Kerr and his orchestra from Cafe L'Aiglon.

Stratford Concert Orchestra; 3:00, Song and piano recital; 6:30, Dance music, Meyer Davis Bellevue Stratford Orchestra.

WGI, Medford Hillsides, Mass. (Eastern, Daylight Saving, 360), 12:00 M., Selections on the Edison, Brunswick, Chickering-Ampico; Readings, H. D. M.; 3:00 P. M., "Yes, We Have No Bananas," Talk Mrs. D. H. Goodwin; Selections on the Brunswick; Edison, Chickering-Ampico; 5:30, "Twilight Tales," Eunice L. Randall; 7:30, Housing Problems, E. T. Hartman; Concert, L'Origan Melody Girls.

WGR, Buffalo, N. Y. (Eastern, Daylight Saving, 360), 12:00-12:30 P. M., George Albert Bouchard, organist; 6:30-7:00, George Albert Bouchard, organist; 7:00, Digest of the day's news; 9:00, Concert, direction of J. P. Quinn.

WCV, Schenectady, N. Y. (Eastern, 360), 1:00 P. M., Music and address, Dr. William Burgess Cornell; 7:45, "A Night at the Club," Opening Chorus; Introduction and speech, John Puffitt; Musical selection, Jazz-Bu orchestra, "Good Night, Ladies," Entire Chorus; 10:30 Musical Program; Trio selection, Moonlight Serenaders, Casimir Ceglinski, violinist; Orlando di Masi, violinist; Arthur di Masi, Spanish guitar; Helen Griffin, soprano; Ernesto Frasso, Guitar solo; Gladys Robinson, contralto.

WHAS, Louisville, Ky. (Central, 400), 4:00-5:00 P. M., Concert, Mary Anderson Theater Orchestra; Ollie Jones, conductor; Selections, Rialto Theater Organ; 7:30-9:00, Concert, Silver King Sextette; Ollie Steffey, director, pianist; Joe Willis, drummer; Milton Haffner, trombonist; Irving Haffner, saxophonist; George Share, banjoist; Reading, "An Interesting Historical Episode."

WIP, Philadelphia, Pa. (Eastern, Daylight Saving, 509), 3:00 P. M., Selections by Dick Regan's instrumental Trio; Dick Regan, director and violinist; Joseph A. Doriat, Cellist; George A. Ehrenzeller, pianist; 6:45, "Radio Baseball Dope," Monte Cross, old-time ball player; 7:00, Bedtime stories, Uncle Wip.

WJAZ, Chicago, Ill. (Central, Daylight Saving, 447.7), 10:00 P. M.-2 A. M., Selections, Oriole Orchestra; "My Heart at Thy Sweet Voice," "Violets," "Minor and Major," "Noon and Night," Helen Davie, soprano; Helen Raub, pianist; "Where'er You Walk," "The Night Wind," Tom Dunlop, tenor; Abbie Jane Tuttle, harpist; Phyllis Feingold, violinist.

WMAQ, Chicago, Ill. (Central, Daylight Saving, 447.7), 4:30 P. M., Musical program; 7:00-8:00, Weekly Auto Trails, Rockwell Stephens; Weekly Boy Scout Talk; 9:00-9:15, Hotel La Salle Roof Garden Orchestra; 9:15-10:00, Musical program, Lyon and Healy.

WOC, Davenport, Iowa (Central, 484), 12:00 M., Chimes concert; 3:30 P. M., Music; Lecture, Karl G. Stephan; 5:45, Chimes concert; 6:30, Sandman's visit; 8:00, P. S. C. Orchestra.

WOO, Philadelphia, Pa. (Eastern, Daylight Saving, 509), 11:00-11:30 A. M., Organ recital, Mary E. Vogt; 12:00-12:54 P. M., Dinner music, Wanamaker Tea Room Orchestra; 4:45-5:00, Organ recital, Mary E. Vogt.

WVJ, Detroit, Mich. (Eastern, 517), 12:05 P. M., Detroit News Orchestra; 7:00, Detroit News Orchestra; Town Crier; Vocal selections, pupils of Bassilios Kyros and Gray Fowler.

Saturday, September 22

CFCA, Toronto, Ont. (Eastern, Daylight Saving, 400), 8:00-9:00 P. M., Suite, "Woodland Pictures," Star Concert Orchestra; Contralto solo, Mary Bothwell; "In Old Vienna," Harry Adaskin, violinist; "Pleading," Star Concert Orchestra; Solo, Mary Bothwell, contralto; "Rendezvous," "Reve Angeli," "Entry of the Gladiators," Star Concert Orchestra.

KDKA, E. Pittsburgh, Pa. (Eastern, 326), 9:00 A. M., Music; 11:30, Victrola and Victor records, S. Hamilton Company; Piano and piano rolls, C. C. Mellor Company; 5:15 P. M., Dinner concert, "Carmen," "American Dance, No. 1," "Idyll," "The Mill in the Forest," "Parade of the Dolls," "Funeral March of the Marionet," "The Skaters' Waltz," Overture "Merry Wives of Windsor," "Carry Me Back to Old Virginia," Westinghouse Band; 6:45, Children's period; 7:05, "Humor from Judge," 7:20, "The Bartered Bride," "Tarentella Forasetta," "A Day in Venice," "Dawn," "Gondoliers," "Venetian Love Song," "Good Night," "Dance in the Shadows," "Celebrated Organ," "Bowl of Panisies," "Humoresque," "Memories of the Opera," Westinghouse Band.

KGW, Portland, Ore. (Pacific, 492), 3:30-4:00 P. M., Children's program, Aunt Nell; 10:00-11:00, Dance music, George Olsen and his orchestra.

KHJ, Los Angeles, Calif. (Pacific, 492), 12:30-1:15 P. M., News Items; Music; 2:30-3:30, Matinee Musicale; 6:45-7:30, Children's bedtime story, "Uncle John"; 8:00-10:00, Program, Chamber of Commerce of Alhambra.

KSD, Central, 546), 8:00 P. M., Program, Missouri Theater.

KYW, Chicago, Ill. (Central, 345), 5:50 P. M., Children's bedtime story; 7:00-7:58, Musical program, W. W. Kimball Piano Company; Isham Jones and his orchestra; Harry Geise, pianist; Mary Lee, soprano; 8:05, Under the Evening Lamp, Youth's Companion.

PWX, Havana, Cuba (Eastern, 400), 9:00-11:30 P. M., Cuban dance music, Antonio Romeu's Orchestra.

WDAP, Chicago, Ill. (Central, Daylight Saving, 360), 10:00 P. M., Harmony Girls, Misses Carpenter and Ingram; Bob Brown, ukulele; Fred Rose, pianist; Betty Holmes, soprano; Melodians' Quartet; Jack Chapman's Orchestra.

WDAK, Philadelphia, Pa. (Eastern, Daylight Saving, 395), 12:00-12:54 P. M., Organ recital, Stanley Theater; Dinner music, Arcadia Cafe Concert Orchestra; 2:00-3:00, Concert, Arcadia Cafe Concert Orchestra; Song recital; 4:30-5:55, Dance music; 7:30-8:00, Bedtime stories, Dream Daddy.

WDT, New York, N. Y. (Eastern, Daylight Saving, 405), 12:00-12:55, "Tinkerman and the Winged Taxi," read by the author, Edith J. Crane; Banjo selections, John Martell; Song recital, Mabel Meredith; Guitar solos, Ann Carson; Banjo and Guitar duet, Ann Carson and John Martell.

WFAA, Dallas, Tex. (Central, 376), 12:30-1:00 P. M., Address, Dr. J. H. McGinnis; 8:30-9:30, Gussie Montgomery's Harmony Six Orchestra; 11:00-12:00, Walter J. Fried, violinist.

WFI, Philadelphia, Pa. (Eastern, Daylight Saving, 395), 1:00 P. M., Dinner music, Meyer Davis Bellevue Stratford Dance Orchestra; 3:00, Musical and literary program; 6:30, Dinner music, Meyer Davis Bellevue Stratford Concert Orchestra; 7:00-7:30, Children's Own Half Hour, Stories, by Cousin Eliza; 8:00, Dance music; 9:00, Program of popular music.

WGI, Medford Hillsides, Mass. (Eastern, Daylight Saving, 360), 7:30 P. M., Talk on New England business problems; Program of late releases, Uncle Eddie and Uncle John.

WGR, Buffalo, N. Y. (Eastern, Daylight Saving, 360), 12:00-12:30 and 6:30-7:00 P. M., George Albert Bouchard, organist.

WHAS, Louisville, Ky. (Central, 400), 4:00-5:00 P. M., Concert, Mary Anderson Theater Orchestra; Ollie Jones, conductor; Selections, Rialto Theater Organ; 7:30-9:00, Concert, Silver King Sextette; Ollie Steffey, director, pianist; Joe Willis, drummer; Milton Haffner, trombonist; Irving Haffner, saxophonist; George Share, banjoist; Reading, "An Interesting Historical Episode."

Jones, conductor; Selectious, Alamo Theater Organ; 7:30-9:00, Ten Best Foster Song Night, Courier-Journal Quartette; Mrs. Charles Shaanon soprano; Mrs. Carl W. Surman, contralto; Carl W. Surman, tenor; Albion S. Cornwall, baritone; Mrs. Albion S. Cornwall, accompanist; Reading, "An Interesting Historical Episode."

WIP, Philadelphia, Pa. (Eastern, Daylight Saving, 509), 3:00 P. M., Popular dance selections; 7:00, Bedtime stories and roll call, Uncle Wip; 8:00, Short talk; 8:15, Artist recital; 10:10, Dance music, Charlie Kerr and His Orchestra at Cafe L'Aiglon.

WJAZ, Chicago, Ill. (Central, Daylight Saving, 447.7), 10:00 P. M.-2:00 A. M., Selections, Oriole Orchestra; "Baby," "The Cactus," "Paddy," Helen Smith, soprano; Clarinette solos, E. E. Harder; Selections, Oriole Orchestra; "Little Woman Mine," "Araby," "Russian Lullaby," Aileen Strossberg, contralto; Orchestra; Guitar solos, Nic Lucas; "Where the Heart Is," "Trade Winds," Helen Smith; Clarinette solos (by popular request), E. E. Harder; Mark Love, bass; Norman Kling, baritone; Stella Barnhart, pianist; Orchestra selections.

WMAQ, Chicago, Ill. (Central, Daylight Saving, 447), 8:00-8:15 P. M., Hotel La Salle Roof Garden Orchestra; 8:15-9:00, Musical program, Eleanor Kaplan; 9:00-10:00, Weekly Chicago Theater program; WOC, Davenport, Iowa (Central, 484), 12:00 M., Chimes concert; 3:30 P. M., Lecture, C. C. Hall; Music; 5:45, Chimes concert; 6:30, Sandman's visit; 8:00, Dance program, P. S. C. Orchestra.

(Continued on page 9)

Workman Radio Service

Table listing various radio components and their prices, including variocouplers, variometers, condensers, vernier condensers, sockets, rheostats, and phones.

Friday, September 21

CFCA, Toronto, Ont. (Eastern, Daylight Saving, 400), 8:00-9:00 P. M., Suite, "Peer Gynt," Star Concert Orchestra; "There's a Land," Harry Jackson, baritone; "Extase," Star Concert Orchestra; "Who Knows," Harry Jackson; "Narcissus," "Pulcinello," Star Concert Orchestra; "Love Is Mine," Harry Jackson; Selections from "Chu Chin," Star Concert Orchestra; Cello solos.

KDKA, E. Pittsburgh, Pa. (Eastern, 326), 9:00 A. M., Music; 11:30, Victrola and Victor records, S. Hamilton Company; Piano and piano rolls, C. C. Mellor Company; 5:15 P. M., Dinner concert, "Carmen," "Symphony Orchestra; 6:30, Address to the Farmers, Frank E. Mullen; 6:45, Children's period; 7:20, "Se Saran Rose," "Boats of Mine," "Love's Pilgrimage," A Scene from Faust, "The King of Thule," Eva Spencer, soprano; Piano solos, Matthew Frey; "Farewell to Cucullain," "Liebesfreud," "In a Gondola," "Schoen Rosmarin," Edith Jenkins, violinist.

KGW, Portland, Ore. (Pacific, 492), 3:30-4:00 P. M., Woman's program; 8:00-8:15, Program, vocal music; 8:15-9:00, Studio program, George Olsen and his orchestra; 10:30-12:00, Hoot Owls.

KHJ, Los Angeles, Calif. (Pacific, 492), 12:30-1:15 P. M., News Items; Music; 2:30-3:30, Matinee Musicale; 6:45-7:00, Children's bedtime story, "Uncle John"; 7:00-7:30, Organ Recital, Arthur Blakeley; 8:00-10:00, R. LeMonte Parker and his Great American Band.

KSD, St. Louis, Mo. (Central, 546), 8:00 P. M., Program; 11:00, Dance music, Silverman's dance orchestra.

KYW, Chicago, Ill. (Central, 345), 5:50 P. M., Children's bedtime story; 9:00-10:30, Isham Jones' Orchestra; Herbie Mintz and Harry Geise, pianists; Sallie Menkes, accompanist; Mary Lee, soprano.

WDAP, Chicago, Ill. (Central, Daylight Saving, 360), 10:00 P. M., Regular Monthly Program, Suu Dodgers' Club; Jack Chapman and His Dance Orchestra.

WDAK, Philadelphia, Pa. (Eastern, Daylight Saving, 395), 12:00-12:54 P. M., Organ recital, Stanley Theater; Dinner music, Arcadia Cafe Concert Orchestra; 2:00-3:00, Song recital; 4:30-5:55, Program of popular dance music; 7:30-8:00, Bedtime stories, Dream Daddy; 8:00-9:00, Playlet by the Greenough Players; Songs by Harry Glyn; Dance music, Howard Lanin's Arcadia Cafe Dance Orchestra.

WDT, New York, N. Y. (Eastern, Daylight Saving, 405), 12:00-12:50 P. M., Piano Selections, Leslie Smith; Song, Rae Garden Leader; Selected songs, Helen Donny; Jewish Selections, by Jewish Artists; 11:00-11:55, Musical Vaudeville, by Jewish Artists; WDT Feature Orchestra; Clifton Meyer, pianist; George Lynch, violinist; Henry Hardgraves, saxophonist; Arthur Marden, saxophonist; Gilbert Walker, banjo, and Samuel Walker, drums.

WFAA, Dallas, Tex. (Central, 376), 12:30-1:00 P. M., Address, Dr. Robert Stewart Hyer; 8:30-9:30, Mrs. Albert Smith, musical recital.

WFI, Philadelphia, Pa. (Eastern, Daylight Saving, 395), 1:00 P. M., Dinner music, Meyer Davis Bellevue Stratford Dance Orchestra; 3:00, Musical and literary program; 6:30, Dinner music, Meyer Davis Bellevue Stratford Concert Orchestra; 7:00-7:30, Children's Own Half Hour, Stories, by Cousin Eliza; 8:00, Dance music; 9:00, Program of popular music.

WGI, Medford Hillsides, Mass. (Eastern, Daylight Saving, 360), 7:30 P. M., Talk on New England business problems; Program of late releases, Uncle Eddie and Uncle John.

Improved Ground Clamp

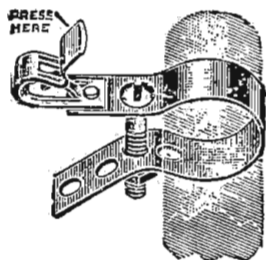

Equipped with Fahnestock Patent Wire Connectors Easily Attached No Soldering. For Radio Use Only At Your Dealers Fahnestock Electric Co. Long Island City, N. Y.

POSITIVE RESULTS are being obtained by thousands of satisfied users of the EASTERN COIL SETS for the COCKADAY CIRCUIT

The remarkable features which are making this circuit (4 circuit tuner) more popular each day are its simplicity of construction and control—wonderful selectivity—distance records—clearness and loudness of reception, and the fact that all capacity squealing, interference, etc., are eliminated. Made as per specifications of Mr. Cockaday, using No. 18 wire with D coil bank-wound. COMPLETE ASSEMBLED SET OF B, C AND D COILS. \$275 PRICE. Hook-up, directions and material list FREE. Mail Orders Filled. Dealers Communicate EASTERN RADIO MFG. CO. 22 Warren Street, Dept. R. D., NEW YORK, N. Y.

The "B" Battery is the Life of Your Radio Set

THIS IS NUMBER ONE OF A SERIES

THE only function of your Radio set is to produce sound-waves—those mechanical disturbances in the air caused by some rapidly vibrating body. So far as the Radio set itself is concerned the actual source of the sound is the "B" Battery. It is not an exaggeration to say that the "B" battery is the "life of your Radio"; for the set itself is simply a device to reproduce sounds, and the sounds all have their origin in the "B" Battery.

The "B" Battery is simply a box full of electrical energy; harnessed for you by experts. Without the Radio wave the flow of energy from the "B" battery is smooth, steady and silent. It is the final aim and purpose of all the many parts which go to make up a Radio receiving set, to convert the otherwise steady flow of electrical energy from the "B" Battery, into a rippling, vibrating, throbbing, audible current.

As the sound-waves—whether caused by the human voice in talking or singing, or by musical instruments—are modulated up and down—now high—now low; so does the current from the strongly vital "B" Battery follow the modulations and the variations, so that the original message, in all its delicacy of tone and vibration, comes clear and distinct through your Radio set.

Not a mere adjunct to the pleasure-giving quality of your Radio set is the "B" Battery—instead, it is the vital, life-giving part—the very heart of your Radio set.

Do not slight this vital part—give your Radio set the advantage of the best—use Eveready "B" Batteries.

Note: This is No. 1 of a series of informative advertisements which will appear in this magazine. They are designed to help Radio users get the most out of their Batteries and Radio sets. If you have any battery problem, write to G. C. Furness, Manager Radio Division, National Carbon Co., Inc., Long Island City, N. Y.

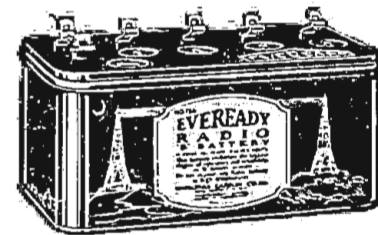

The New Metal Case Eveready "B" Battery (No. 766)

"The Life of Your Radio"

The same popular 22½ volt Eveready "B" Battery in a new, handsome, durable, waterproof, metal container. Eveready quality throughout. At all dealers, \$3.00.

The "B" Battery is the vital part of any radio receiving set. Eveready Batteries—especially made for Radio—serve better, last longer and give better results.

Manufactured and guaranteed by

NATIONAL CARBON COMPANY, Inc. Long Island City, N. Y.

EVEREADY Radio Batteries—they last longer

LISTEN! REFLEX FANS!



To this good news. Here is THE ONE THING NEEDED to make the REFLEX SINGLE TUBE set a GREAT instrument—A REAL LIVE PERMANENT DETECTOR to take the place of a crystal detector. No special wiring, connect the same as crystal detector. We have set aside 100 B-METAL REFLEX SPECIALS TUBE Type Non-Battery PERMANENT DETECTORS and having given them most exhaustive tests, are ready for your verdict, so fill out the attached coupon and mail at once as this offer is limited to the first 100 applicants, one detector to each.

B-METAL REFINING CO. 3134 Trumbull Avenue, DETROIT, MICH.

B-METAL REFINING CO. 3134 Trumbull Ave., Detroit, Mich. Send postpaid one B-METAL REFLEX DETECTOR. I will test same and return detector or price within five days. Mail to: Address:



THE ANTENNA BROTHERS

Spir L. and Lew P.

A Shocking Occurrence

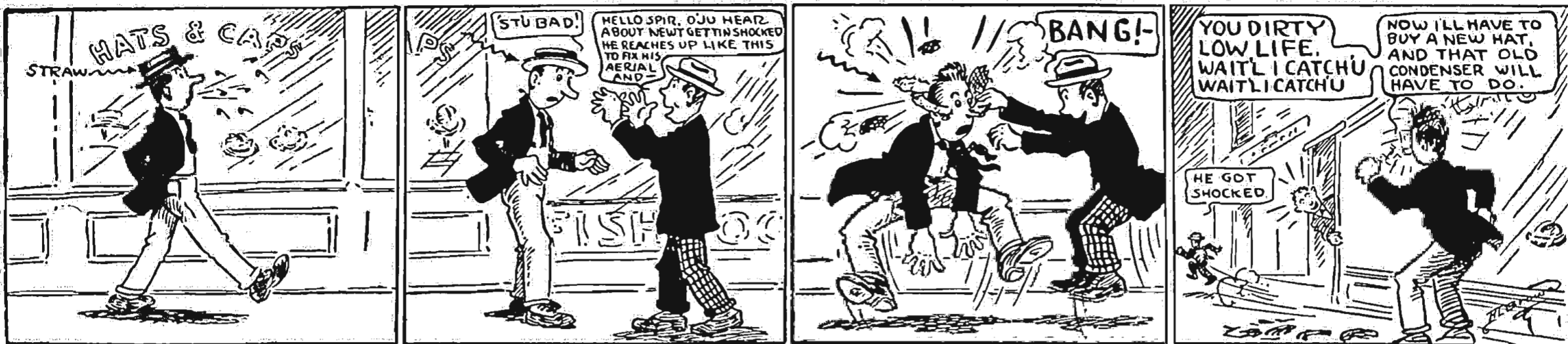

WWJ, FIRST PRESS PLANT, 3 YEARS OLD

HEARD IN ENGLAND, PERU AND HAWAII

Leader in Adopting Practical Designs Now Is Classed Among Finest Stations

DETROIT.—WWJ, the Detroit News has just celebrated its third birthday anniversary. It was the first newspaper in this country to enter the broadcasting field. The first broadcasting by The News was in the form of returns from the city, state and national primaries. At first the effective range of WWJ was only about 100 miles. Due to improvements the range now is much wider. It has been heard in England. It also has been heard in Hawaii and Peru.

The story of progress in Radio telephony has been the story of WWJ. Each new practical development was incorporated by the station. The studio of WWJ is now rated as one of the finest.

In May, 1922, the Detroit News became a leader by forming an orchestra for Radio concerts. This has become famous.

ADVANCE PROGRAMS

(Continued from page 8)

- WOO, Philadelphia, Pa. (Eastern, Daylight Saving, 509), 11:00-11:30 A. M., Organ recital, Mary E. Vogt; 12:00-12:54 P. M., Dinner music, Wanamaker Tea Room Orchestra; 4:45-5:00, Organ recital, Mary E. Vogt.
WTAM, Cleveland, Ohio. (Eastern, 390), 8:00 P. M., Concert.
WWJ, Detroit, Mich. (Eastern, 517), 12:05 P. M., Detroit News Orchestra; 7:30, Detroit News Orchestra.

Sunday, September 23

- KHJ, Los Angeles, Calif. (Pacific, 492), 10:00 A. M., Church Services; 10:30-11:00, Arthur Blakeley, Organist; 7:00-7:30, Organ recital; 8:00-10:00, Musical program.
KYW, Chicago, Ill. (Central, 345), 10:00 A. M., Church Services, St. Chrysostom's Episcopal Church; Rev. Norman J. Huton, rector; 5:00-8:00 P. M., Sisson Trio; A. L. Shyman, pianist; Theodore Ratzler, violinist; George Bass, cellist.
WDAP, Chicago, Ill. (Central, Daylight Saving, 360), 9:15 P. M., Henry Selinger and the Drake Concert Ensemble; Milla Ybarra, Mexican soprano.
WFAA, Dallas, Texas. (Central, 376), 2:30-3:30 P. M., Radio Chapel Bible Class, First Presbyterian Church; Dr. William M. Anderson, pastor; 9:30-10:00, Sacred music, Eray Street Baptist Church; 10:00-11:00, Harris Brothers Orchestra.
WFI, Philadelphia, Pa. (Eastern, Daylight Saving,

- 395), 10:15 A. M., Church Services, Arch street Presbyterian Church.
WGI, Medford, Hillside, Mass. (Eastern, Daylight Saving, 360), 4:00 P. M., "Twilight" Program, "Adventure Hour," Youth's Companion; Concert, Edison Laboratory Phonograph; Stories by Arturo; 8:30, Evening program.
WGR, Buffalo, N. Y. (Eastern, Daylight Saving, 360), 3:00 P. M., Vesper service, Dr. Charles D. Broughton, Episcopal.
WGY, Schenectady, N. Y. (Eastern, 380), 10:30 A. M., Church Service of First Baptist Church, Troy, New York. Rev. F. King Singler, pastor; 3:30 P. M., Lecture on Christian Science, Rev. Andrew J. Graham, C. S. B., First Church of Christ, of Boston, Mass.; 7:30, Church Service, First Baptist Church, Troy, New York, Rev. F. King Singler, pastor.
WHAS, Louisville, Ky. (Central, 400), 9:57 A. M., Organ music; 10:00, Church services, Fourth Avenue Baptist Church; Rev. Dr. John F. Fraser, pastor; 4:00-5:00 P. M., Concert, St. Peters Evangelical Church Choir; Robert Conner, director.
WHK, Cleveland, Ohio. (Eastern, 360), 8:00 P. M., Concert program, WHK Orchestra.
WJAZ, Chicago, Ill. (Central, Daylight Saving, 447.7), 10:00 P. M.-2 A. M., Oriole Orchestra; "Polonaise in A Major," "Nocturne in E Flat Major," Margaret Garrity, pianist; "Rhondino," "Melody," Edward Hagner, violinist; Oriole Orchestra; "Philosophy," "You," R. G. Ball, baritone; "Prelude in C Sharp Minor," Margaret Garrity, pianist; Orchestra; "The Dew is Sparkling," Edward Hagner, violinist; "To Show That I Was True," "O Little Mother of Mine," R. G. Ball; Isabella Walker Kuehne, soprano; Selections, Orchestra.
WWJ, Detroit, Mich. (Eastern, 517), 7:30 P. M., Church services, St. Paul's Episcopal Cathedral; 2:00, Detroit News Orchestra.

Monday, September 24

- WDAR, Philadelphia, Pa. (Eastern, Daylight Saving, 395), 12:00-12:54 P. M., Organ recital, Stanley Theater; Dinner music, Arcadia Cafe Concert Orchestra; 2:00-3:00, Concert, Arcadia Cafe Concert Orchestra; Short talks and piano solo; 4:00-5:55, Short talks and popular songs; 7:30-8:00 P. M., Bedtime stories, Dream Daddy.
WFI, Philadelphia, Pa. (Eastern, Daylight Saving, 395), 1:00 P. M., Dinner music, Meyer Davis Bellevue Stratford Concert Orchestra; 3:00, Artist recital; 6:30, Dinner music, Meyer Davis Bellevue Stratford Concert Orchestra; 7:00-7:30, Bedtime stories, Cousin Sue.
WGR, Buffalo, N. Y. (Eastern, Daylight Saving, 360), 12:00-12:30 P. M., George Albert Bouchard, organist; 6:30-7:00, George Albert Bouchard, organist; 7:00, Digest of the day's news; 9:00, Concert, Wheat Ice Cream Co., Orchestra, E. C. Sutton, director.
WGY, Schenectady, N. Y. (Eastern, 380), 1:00 P. M., Music and address, Mrs. Wm. J. Nunn; 7:45, Concert program, Helen A. Parker, pianist; Reading, Mrs. Robert Wilson; Margie Howard Morse, Contralto; Address, Samuel W. Mauger.
WHAS, Louisville, Ky. (Central, 400), 4:00-5:00 P. M., Concert, Mary Anderson Theater Orchestra; Ollie Jones, conductor; Selections, Rialto Theater organ.
WHAZ, Troy, N. Y. (Eastern, 380), 9:00-10:30 P. M., Program, Mrs. Harry Glass, soprano; Margaret Dexter Babbs, contralto; John C. Dandurand, tenor; C. Albert Cook, bass; Harry J. McCreedy, accompanist.
WIP, Philadelphia, Pa. (Eastern, Daylight Saving, 509), 3:00 P. M., Artist recital; 6:45, "Radio Baseball Dope," Monte Cross, old-time baseball player; 7:00-7:30, Bedtime stories, Uncle Wm.
WLW, Cincinnati, Ohio. (Eastern, 309), 4:00 P. M., Special Music, Jennie Kehrt; 8:00, Concert, Esberger's Band of Cincinnati; Walter Esberger, director; Helen Hofer, soprano; Roger Hill Dance Orchestra; Roger Hill, pianist; Clyde Tuxworth, saxophonist; Webb Planitz, clarinetist; Ralph Ross, trombonist; Claude Lawson, banjoist; Bernie Hagener, drummer.
WOO, Philadelphia, Pa. (Eastern, Daylight Saving, 509), 11:00-11:30 A. M., Organ recital, Mary E. Vogt; 12:00-12:54 P. M., Dinner music, Wanamaker Tea Room Orchestra; 4:45-5:00, Organ recital, Mary E. Vogt; 7:30, Dinner music from Hotel Adelphia Roof Garden; 8:30, Song recital; 9:30 P. M., Grand organ recital, Mary E. Vogt.

ALL NATION ENJOYS STATE FAIR OPENING

Concerts, Speeches at Detroit Broadcast to Millions

DEROIT.—The formal opening of the Michigan State Fair was heard by many thousands in various parts of the United States and Canada this year when Station WWJ connected its broadcasting outfit down town with apparatus at the fair grounds. At the same time it also located big horns at various points about the grounds where it was made possible to hear speakers on the grandstand and also the band concerts given every afternoon and evening on Belle Isle, several miles away.

Previous years prominent speakers, including even the governor, failed to hold the attention of the crowds on the grounds because they were so vast the speakers could be heard only a few feet away. This year, due to the efforts of WWJ, the Detroit News made it possible for everyone who cared, to hear every speaker on the grandstand and also to enjoy the finest of musical programs by gathering about the big horns.

Radio programs through loud speakers are furnished to inmates of the Ohio State penitentiary every evening between 6 and 7 o'clock.

Boston Listeners Form Club

BOSTON, MASS.—A new organization of broadcast listeners has been formed in Boston to be known as the Commonwealth Radio association. It is primarily a B. C. L. organization but includes all other amateurs. The members are chiefly old-time amateurs who want to be affiliated with the A. B. C. L.; all are members of the American Radio Relay league. The club has formed a traffic committee which will receive complaints from broadcast listeners and which will have at least one member listening during broadcast hours so as to log every amateur station.

U. V. 199 TUBES \$5.30

WD-11, WD-12 and UV-201A. These tubes require only 1/16 and 1/4 of an ampere and are the most popular of all tubes today.

Table with 2 columns: Tube type and Price. Includes VARIABLE CONDENSERS (Moulded Ends) and .65-ELECTRAD GRID LEAKS.

CROSLY RADIO

Table with 2 columns: Radio model and Price. Includes Model X (4 Tube Radio Freq.), Crosley V (One Tube), Crosley Two Stage, and Gen. Nat. Baldwin Phones.

Everything guaranteed as firsts. Don't delay getting Price List No. 9. Wonderful bargains. We pay postage.

RADIO SUPPLY STORES 254 West Stiegel Street Manheim, Pa.

WHEN you're wondering which radio set to buy, remember that De Forest invented the vacuum tube, without which present-day radio would still be a dream. Naturally it is De Forest Radiophones which give the greatest satisfaction. Go to your De Forest agent today and let him tell you why.

DE FOREST RADIO TEL. & TEL. CO. Dept. R. D. JERSEY CITY, N. J.

If Located West of Pennsylvania, Address DE FOREST RADIO TEL. & TEL. CO. Western Sales Division Dept. R. D. 5680 12th St., DETROIT, MICH.



Cotogrip

"Built First to Last"

This little beauty was approved by our engineers only when convinced that they had produced the one socket that combines all the essential features of a good socket.

- 1. Positive Cotogrip Contacts.
2. Hard Rubber Insulation.
3. Rugged Construction.
4. Compact Design.
5. Concealed Mounting.

It is impossible to show the unique mechanical action of Cotogrip contacts in a photograph. It is different from any other socket you have ever seen. This socket will interest you in every way.

You ought to have one. Ask Your Dealer

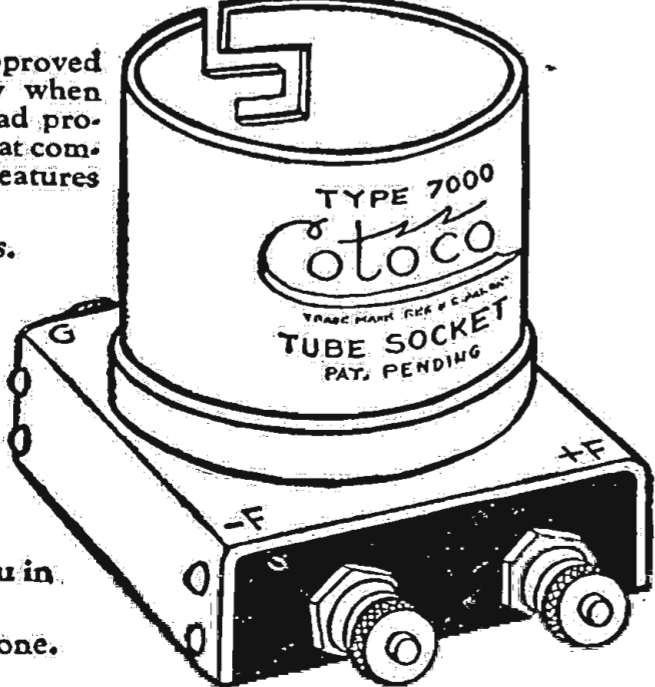

COTO-COIL CO. PROVIDENCE

PACIFIC COAST BRANCH: 329 Union League Bldg. LOS ANGELES

# Radio Digest Illustrated

REG. U. S. PAT. OFF. AND DOM. OF CANADA

Published by the Radio Digest Publishing Company, Inc.  
123 West Madison Street  
Telephone: State 4643, 4844, 4845  
Chicago, Illinois

E. C. RAYNER, Publisher  
Chas. F. Smisor, Editor Evans E. Plummer, Managing Editor  
H. J. Marx, Technical Editor M. W. Thompson, Associate Editor

Eastern Representative, Jacob Miller, Times Bldg., Times Square,  
New York; Telephone Bryant 4909

Pacific Coast Representatives  
E. J. Wood, 251 Kearney St., San Francisco  
Telephone Kearney 1472  
H. M. Morris, 417 Western Mutual Life Building, Los Angeles  
Telephone 12011

Member of the Audit Bureau of Circulations



PUBLISHED WEEKLY

SUBSCRIPTION RATES

Yearly in U. S. and Possessions and Canada, \$5.00.  
Foreign postage, \$1.00 additional. Single copies, 10 cents.

Vol. VI Chicago, Saturday, September 22, 1923 No. 11

## Will It Be Power by Radio?

Tests Show That There Are Possibilities in Energy Transmission

**I**F POWER can be transmitted by Radio waves then motors will drive machinery in factories, lights will burn in homes, elevators in buildings will be operated, street cars will be driven and machinery made to work by means of power transmitted great distances and delivered on the carrier wave without great loss.

This prophecy may be made because of recent successful experiments conducted by two experts in the United States bureau of standards. These men successfully directed Radio waves from a transmitter to a receiver in a beam like a searchlight. The waves were short so that much interference was eliminated.

The possibilities first suggested by this accomplishment are secret; direct communication, instead of turning a message loose through all space, may be centered on objects at a distance.

Radio may prove to be the greatest labor saving device yet discovered.

## Invalids Need Receivers

Let Some Shut-in Use Your Old Crystal Set

**S**HUT-INS are dependent on friends and relatives for their news and for world contact. Since the advent of the Radio conditions have changed; those confined in their homes have a chance to relieve the monotony and enjoy living by hearing about the great outside. The invalid looks forward to the Radio concert every evening.

In many instances some of those in hospitals or at home who are quite familiar with Radio receiving equipment would install and operate outfits if they had them. A great many Radio sets are not at present being used. Many who purchased crystal outfits have gradually put them aside in favor of the tube sets. These crystal outfits are performing the rather useless function of collecting dust in attic or closet. The number of broadcasting stations in the country has increased so rapidly that very few shut-ins with crystal receivers are now out of range of all stations. Why not turn that crystal set over to one of these persons? It is doing you no good and it may brighten the life of one not so fortunate.

## About That Lightning Hazard

Why Bluster with Something That Is of No Consequence?

**Y**OU would think, by the way most writers handle the subject of lightning hazards that they know just how to control a streak of lightning in spite of the storm king. Recently there appeared a whole page of text matter in a Sunday Radio section of a newspaper telling how and illustrating exactly where a forked bolt of "blue blazes" hits the Radio set, regardless of the ton of iron which usually constitutes the furnace, telephone poles, railroad tracks and tall chimneys. How a person really falls into these moods is more than the ordinary observer can understand.

There is a certain Radio set we know about which has two aerials on the roof of a tall apartment building. A storm recently came across the city; the air was full with what we mortals call an electric storm. The owner of the Radio set, while sitting in the railroad station waiting for a train, saw a heavy bolt of lightning, round in form, enter Lake Michigan a half mile out. Another struck an electric-wire pole just back of the apartment and another hit the tracks of the railroad where it flared up as a brilliant ball of fire. The insignificant little aerials, two of them, could not attract a single stray of the forked bolt. A dead piece of timber, a telegraph pole or post has always been the mark for lightning, not a copper wire. Think out the reason why, you Radiophans!

We wonder when Radio writers will stop throwing a "scare" into the fans when so few records show that an aerial is the real means of picking up a streak of lightning?

## RADIO INDI-GEST

### Radio in Cactus Center

(Part I. Written and Originally broadcast via WOR  
By Arthur Chappman.)

*It's hard to keep our punches at their tasks, out on the range,  
Sence a tenderfoot's upset 'em, with a dingbat new and strange;  
A Radio, he calls it—stuck the first on Simpson's ranch,  
And now he's got us locoed, plum from Lone Wolf to Comanch,  
And the cattle are deserted, 'cause the men all stick around  
For to hear what's in the air waves. Seems they hate to miss a sound,  
And they jest won't hit their blankets, though they bot a sleepy eye,  
Till they've had a bedtime story and a good-night lullaby.*

*We couldn't sovvy, pronto, quite the nature of the game,  
And we joked the gentle stranger, but he went on jest the same  
Puttin' up his queer antenny, as he called some wire things,  
And a bridle, with some car-muffs, that he'd patched up with some strings.  
Then at last speaks old Bear Howkins: "Are you oimin' to declare  
That this thing will ketch, in passin', all the noises of the air—  
That she'll rope and tie a sound wave, jest the same as any steer?"  
Says the stranger: "Don't this harness and then tell us what you hear."*

(Part II next week will conclude Mr. Chappman's poem.)

### A-B-C Lessons for Indigest Beginners

Chapter XIV—Run It with Gasoline, It's Cheaper

BY GOSH

**N**IS for Needs;  
Our set, has such a crew,  
And as we think of all we need  
The mortgages come due.

### Barely Saved from Incineration

Or Why the Cop Committed Suicide

**T**HE patrolman was slowly sauntering along his beat. The church clock a block away struck one. All was quiet. In this suburb there was a little chance of something happening as there was of getting a promotion. But it is the unexpected that always happens. Looking across the street his attention was attracted to a house all dark except a flickering glow of light at an attic window. At times it was almost gone and then again it would flare up. A curl of smoke could be seen when it was the brightest. To the officer's mind the solution was clear.

Crossed wires, family asleep, a chance for a rescue, his picture in the papers and a possible promotion. It all ran through his mind in a flash. The pulling of the fire alarm box on the corner was his first move. Then on a run he crossed the street and back to the house where the light still flickered in the attic. He could hear the bell ringing as he kicked the door with his heavy shoe. A light appeared at the head of the stairs and a figure was descending. In the distance the clang of the approaching fire department could be heard. The front door opened.

"Madam, your house is on fire—crossed wires in the attic. Leave the door open for the fire department." There was a mad scramble up the stairs. The second floor was reached, the attic door opened, and up again. Breathless, at the head of the stairs they stopped. A figure near the window was seated in an old rocking chair smoking a pipe. On a box in front of him was a Radio set and on either side of which stood a candle, well burned down and sputtering.

"What do you mean by this, Pa?" the woman gasped. "I thought you were in bed long ago." There was the raising of a hand indicating silence. No other movement of the figure with the head phones. Then they heard him whisper, "S-h-h-h, I think I've got KFI."

H. K. C.

*Beneath this green sod  
Lies good J. DeCam—  
He spread on his bread  
Soldier paste for jam.*

### Paging Polly W. That's 'Nuff

To Polly W.: That new-fashioned guy who "buttonholds" you and tells you about all the long distance stations he heard the night before—does he chew snuff?

Well, then YOU have nothing to worry about!!

BRIGHTON EARLY.

### INDI-GEST KINKS? SEND A DOLLAR—

**T**HERE are many little Indi-Gest kinks worked out in the home that would hamper your fellow Radioknut and cause him much worry. Indi-Gest is very much interested in securing such material and is willing to accept a dollar for each kink printed. Send a stamped envelope so rejected copy may be returned. Under no circumstances will the dollar be sent back.

INDI-GEST KINKS DEPARTMENT

### No, Mike and Izzy Are Very Modest

Dear Indi: I am herewith enclosing one (1) poem. (I don't care what you say, I think it's a poem, so there!) Give this poem to the Office Squirrel, or send it to Mike and Izzy, if you don't think it will make them sick, but don't under any circumstances, publish it in your valueless column. I was listening to Station BLAH the other night on my own modification of the Stebbins Sooper Degenerative Circuit (See enclosed hook-up) and kept hearing a raspy noise in the headphones. (I mean earmuffs.) I think this was caused by either Mike or Izzy scratching his fleas in front of the microphone. Am I right? Ann Tenna, signing off at 13:01, Eastern Standard Time. Good Night.

ANN TENNA.

(Indi's Note: Modified Stebbins hook-up and so-called poem coming later. Stand by.)

## Fun on the Air



## Condensed

By DIELECTRIC

Impresarios complain of artists being too temperamental, causing them annoyance at crucial moments. Judging from the experience Radio operators had at station WDAR, in Philadelphia, on a recent occasion I imagine the same fault will be attributed to microphones and their unionized adjuncts. Operators and announcers had planned to broadcast a program featuring themselves at that time, but the plant refused to function. They enjoyed an evening off with speeches and Radio dancig, which was no doubt a treat.

We listeners in have been privileged to listen to many men and women of prominence in various walks of life. Actors and actresses have addressed us whose names loom large in theatrical circles, yet it is seldom that such "perform" for us; an unfortunate circumstance. When WDAP announced the inimitable Chick Sale the other night in his perfected characterization of a minister (of a type) Radio audiences were aware of an unusual feature. Pity there are not more Sale broadcasts. An entertainment of this kind is well worth putting on the air.

Who will win the prize offered by WGY for the best Radio drama to be submitted during the next three months? Since I am not competing you all have a chance. It is a timely scheme of the General Electric people to urge greater thought along this line. As it is generally understood that dramas for Radio transmission require handling a little different from those intended for the stage, to be entirely successful, a new field is open to playwrights. The drama finally chosen will be broadcast this winter when conditions are most favorable.

Perhaps the majority of Radio listeners are ever ready to share their receiving sets with those less fortunately placed in the matter of hearing broadcasting. After reading of the experience of one fan in San Francisco, whose generosity had led to his being robbed of a hundred dollars, I question whether some of us will hand a headset to a stranger, however entrancing. The young woman who listened to KPO while getting the gate receipts was very clever. She possibly has introduced a new phase of criminal procedure. We'll see!

The details of prize fights, baseball and football have preceded the announcement of golf strokes but now we have these also. Station WSB gave to enthusiasts in Atlanta a Radio picture of Bobby Jones as he covered the golf course in winning fashion on the links on Long Island, N. Y. A leased telegraph wire enabled the station to provide this much appreciated service. Contests of whatever nature in which a large majority of the public is interested may easily be broadcast all over the country.

Despite the oft repeated assertion that the City of Brotherly Love is several steps behind other municipal marchers it is to be noted that as to Radio installation it is slightly in the lead. Hotels and apartments equipped with Radio receiving sets have multiplied in number quite rapidly. In the proposed structures to be erected in Philadelphia the most advanced plans for Radio reception by guests is contemplated. Not one of the least novel features is a Radio paging system.

While it is true that France, for instance, began testing the medium of Radio for warning shipping during heavy fogs, no country at present ranks with ours in the extent or efficiency of Radio fog signaling. At present the all-weather range of these signals is thirty miles or a thousand meter wave. One of the greatest achievements was to make the device automatic after being started by a keeper. The value of such fog signals to shipping cannot be overestimated, especially since the range can be increased beyond the thirty-mile limit.

# First Steps for Beginners in Radio

## Chapter XVII—Using Alternating Current on Tubes

By Thomas W. Benson, A. M. I. R. E.

**BEGINNERS** will find the accompanying series by Mr. Benson very helpful in learning the rudiments of the popular science of Radiotelephony. The articles yet to appear are:

- Chapter XVIII—Testing Radio Instruments.
- Chapter XIX—Locating Trouble in the Set.
- Chapter XX—Useful Information and Formulas.

**T**HIS may seem a rather advanced subject to be considered in a beginners' series but experience has shown that minds not too close to a given subject often conceive the greater improvements. Witness the rise of Radio broadcasting when many amateurs made the greatest discoveries. Let us therefore discuss the difficulties yet to be overcome in the using of alternating current from the house lighting mains in a Radio set.

The possibility of simply connecting into a convenient socket as a source of energy for the filament and plate circuits of the Radio set is not beyond reason; in fact it has been accomplished in an experimental way but by methods too complicated for the ordinary man. Its realization

nect one side of the secondary circuit to the filament terminal the polarity of this terminal would be rapidly changing from negative to positive and back again many times a second; with each change a varia-

is to rectify the alternating current; make it direct. For reception the electrolytic rectifier is not a satisfactory device, principally because it lets a little of the unwanted half of the cycle to leak through.

as flowing in one direction in the primary circuit. At that moment one end of the secondary will have a positive potential, and the other negative, in relation to the center tap. The tube, having its plate connected to the positive terminal at that instant, will permit current to flow to the filament, thence to the plate circuit of the set and back to the center tap. The other tube will not permit current to flow. However, when the current reverses, the other tube permits a flow of the current while the first one checks it. In this manner the alternating current is converted to a direct current; but it is pulsating.

### Direct Current Obtained

This action is shown in Figure 62. At A is shown the original alternating current; at B the lower halves of the cycles are turned up, so to speak, giving a unidirectional current flow; but it rises and falls in voltage with each half cycle. Before it is suitable for use on the plate of a tube it must be smoothed; the ripples must be removed.

Here again we have recourse to a well known effect to obtain a given result. We also learned that an inductance acts to resist a change in the strength of cur-

(Continued on page 12)

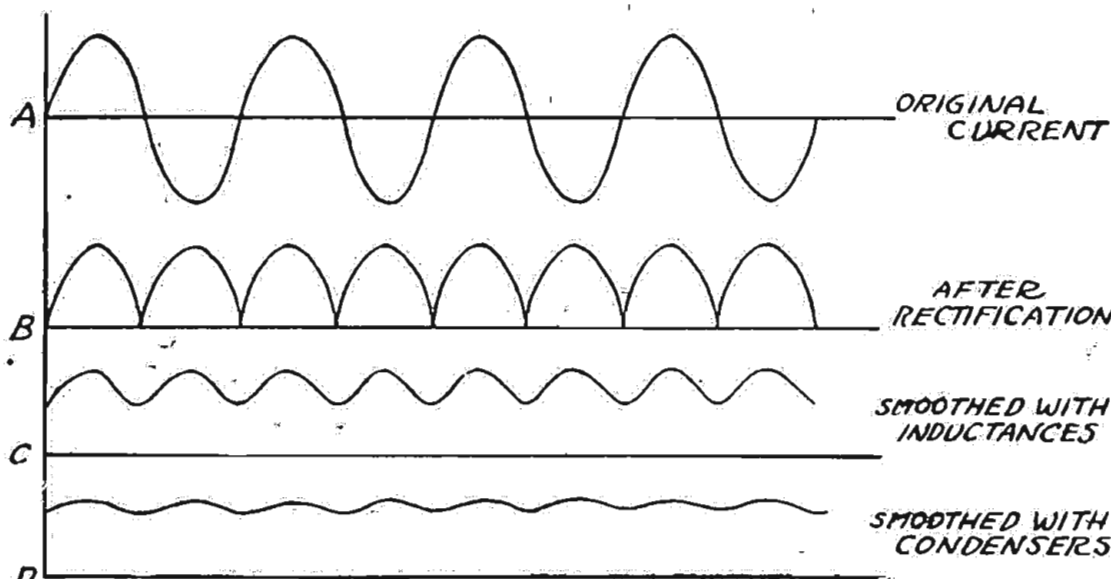

Figure 62—Showing various stages in converting A. C. to D. C. for use in plate circuits

tion in the grid potential would result. The plate circuit would then be affected and a roar would result. To offset this effect use is made of a potentiometer connected across the secondary of the transformer. The purpose of this potentiometer is not to vary the potential of the grid as usual but to locate the electrical center of the filament circuit. Even though the potentials at the ends of the potentiometer are continually changing it is apparent that at some point on the resistance there would be no change in potential as to the center of the filament.

### Source of the Hum

This circuit will work but it is impossible to eliminate the hum because, though we locate a point on the potentiometer where there is no potential difference with the center of the filament, there is a difference between that point and the sides of the filament, hence the hum. For those troubled by storage batteries this arrangement may prove very satisfactory on local stations where the signals are strong. The transformer should have a rating high enough to supply all the tubes in use. Allow 6 watts for each UV-200, UV-201 and C-300 or C-301. The allowance for other tubes can be readily calculated by multiplying the volts required by the rated filament current to give the watts. The potentiometer of standard construc-

Use then is made of electronic rectifiers which are nothing but two element tubes. We learned early in the series how a vacuum tube functions as a rectifier; we can put this principle to use in rectifying current for the plate circuit.

The circuit for accomplishing this is shown in Figure 61. A special transformer having a tap in the center of the secondary winding is employed. The outer terminals of the secondary terminals connect to the plates of the two element vacuum tubes, the filaments of which may be lighted from a winding on the same core as the tapped secondary. The tap on the secondary forms the negative terminal, the positive being the filaments of the tubes. The action of the arrangement is simplicity itself. Consider the current

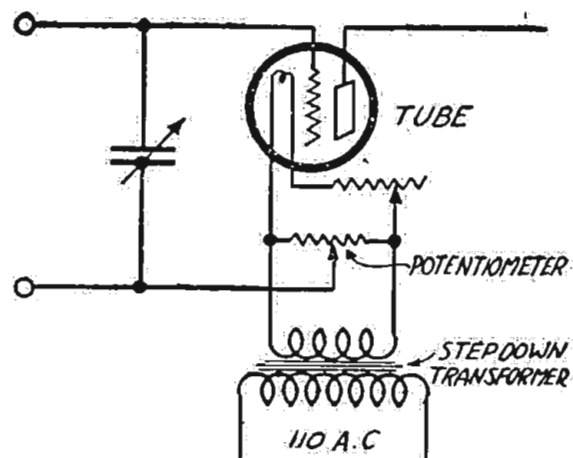

Figure 60—How A. C. is used in lighting filament

zation would solve many of the harassing problems, particularly the upkeep, of the larger receiving sets.

### Noise Caused by Break in Current

We have found from previous chapters, if not by actual experience, that any disturbance in the steady flow of the filament or plate battery current would give

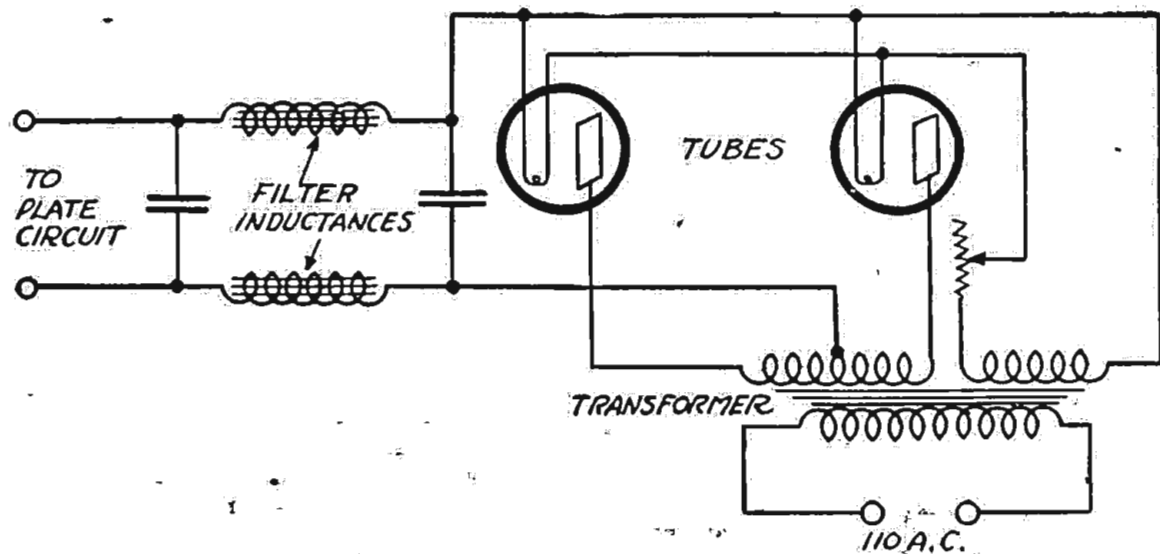

Figure 61—Using A. C. on the plates

an annoying sound in the phones. Were we then to attempt to use an alternating current, with its constant change in voltage and direction of flow, there would be encountered a loud hum in the phones or, properly speaking, a roar.

The reason for this action when A. C. is used on the filament will be apparent from a consideration of Figure 60. Here is shown an arrangement that is often used for the purpose and has operated successfully for many experimenters. It consists of a step down transformer, the primary being connected to the A. C. mains, the secondary having the rated voltage output needed for the tube filament. A rheostat in series serves to control the filament brilliancy. Now were we to con-

tion may have 200 or 400 ohms' resistance as desired.

**Application of the A. C. Current**  
We may now consider the application of A. C. to the plate circuit of the set. Here we have a more difficult problem, for it is absolutely necessary to have a steady direct current. The first problem

## RADIO SCHOOL

All our graduates are placed.  
Shortage still exists.  
Wages are still going up.  
Our school holds best records in New England for qualifying operators.  
Send for Catalog  
**MASSACHUSETTS RADIO & TELEGRAPH SCHOOLS, Inc.**  
18 Boylston St. Boston, Mass.  
G. R. ENTWISTLE, Radio Director

## THE AUDIOPHONE

Quality of reproduction such as only the original itself can equal. Speech that is so distinct that the voice heard is the actual voice of the speaker. Music that requires no tolerant imagination to be recognized as music of the finest type.

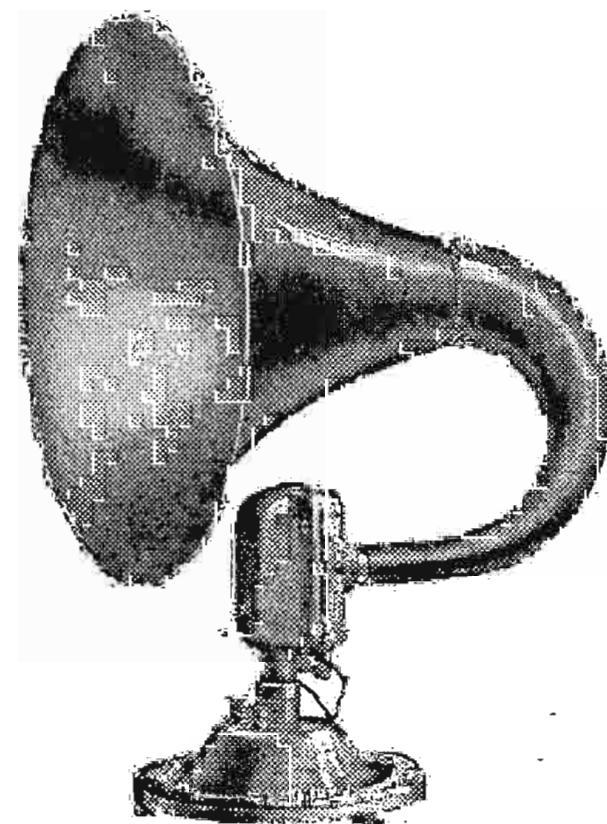

## Bristol's Single Stage Power Amplifier

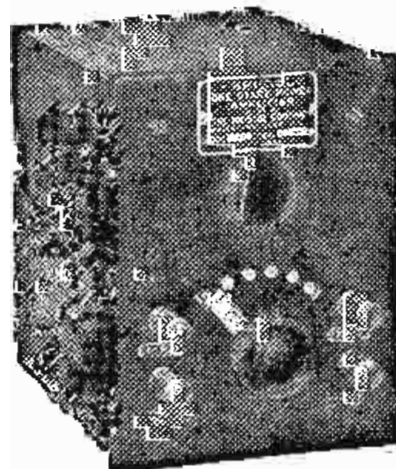

gives additional VOLUME with any two stage amplifier. No separate batteries required. It provides the additional volume necessary to bring in very distant stations on the loud speaker.

Write for bulletin and address of the nearest dealer handling our instruments

## THE BRISTOL COMPANY

WATERBURY, CONN.  
Boston New York Philadelphia Pittsburgh Detroit Chicago St. Louis San Francisco

### ATTENTION!

The New **RELIABLE SINGLE TUBE RECEIVING SET**. Excellent workmanship. Enclosed in finished solid mahogany cabinet. Reception unusually clear and loud. Stations heard within 1,000 mile radius. An ideal Receiver for only \$12.50  
Write for Full Particulars  
Reliable Radio Co., 1175 Flatbush Ave., Bklyn., N. Y.

ENGLISH CRYSTAL AND R. F. AMPLIFIER CIRCUIT

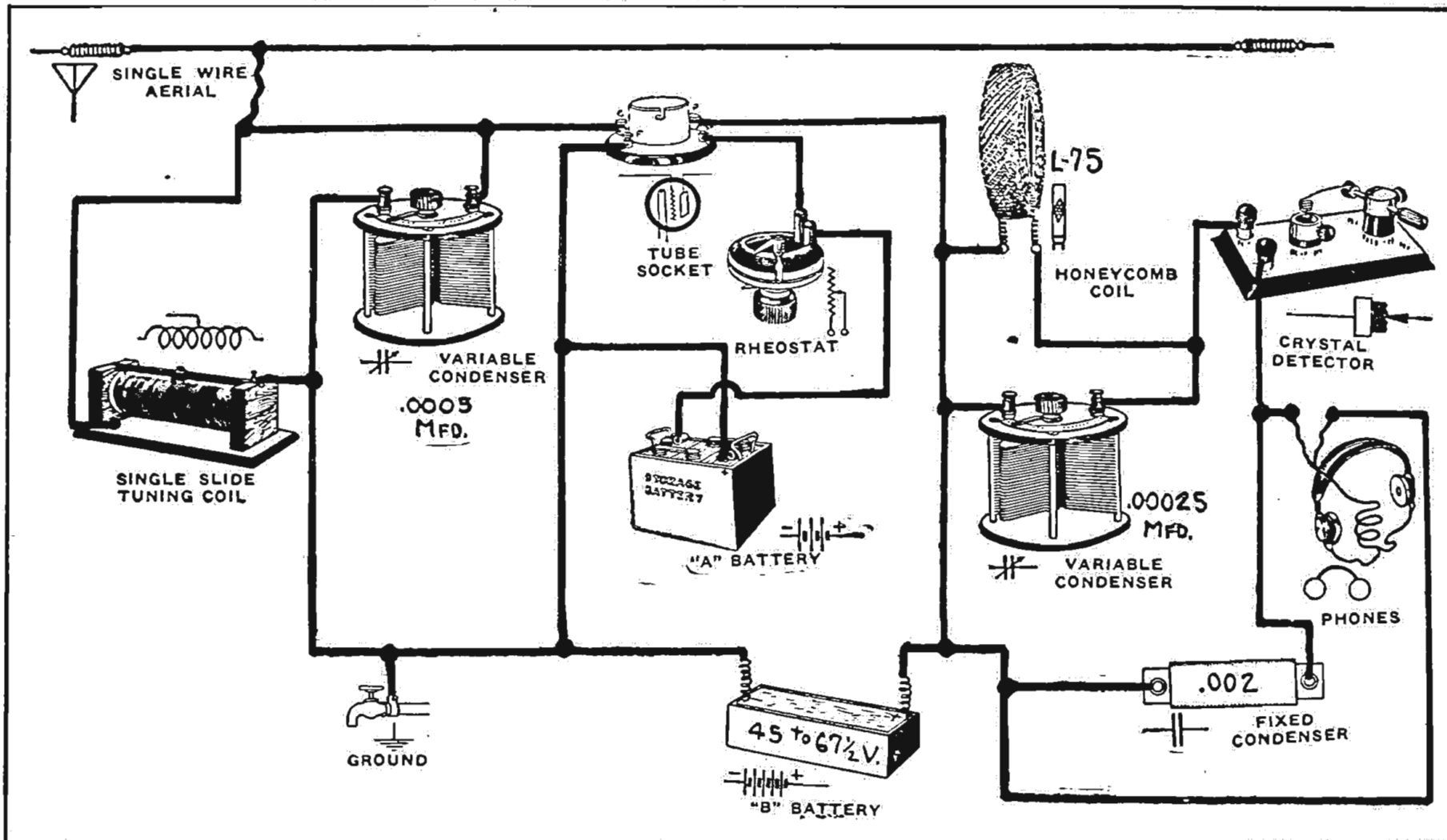

**A**N ENGLISH circuit combining Radio frequency amplification with a crystal detector in the form of an inexpensive and simple set, is shown in the Simplex Diagram.

A single slide tuning coil, with a .0005 mfd. variable condenser across it, comprises the initial tuning unit. The de-

tor circuit is tuned by means of another .0005 mfd. variable condenser across a 75 turn honeycomb coil. For lower wave lengths a 50 turn coil can be substituted. The tube, an amplifier, can be of the dry cell type with rheostat and socket to conform with the requirements of the tube.

The phones are by-passed by a .002 mfd. fixed phone condenser. The plate voltage for the tube should be 45 or 67 1/2 volts. For the fan who wants to expand his crystal set this circuit is especially recommended because of its simplicity and low expense coupled with a very favorable receiving range.

FIRST STEPS IN RADIO

(Continued from page 11)

rent flowing through it. Were inductances inserted as shown in the illustration, when the voltage tended to rise, the inductance would cause it to lag; when the voltage falls, the inductance again would act to keep it flowing. The result then would be to "smooth" the wave form, giving something like the wave shown at C. Still this is not smooth enough for our purpose; so use is made of condensers. As shown, (Fig. 61) a condenser is connected on either side of the two inductances. These condensers act as a reservoir for the electricity. When the voltage builds up the condensers ahead of the inductance it is charged and as the voltage falls off, it discharges back through the inductances into the circuit. The other condenser acts as a reservoir from which energy is drawn for the plate circuit. It is kept constantly charged by the current from the transformer, the plate circuit drawing current as required for the operation of the tubes.

Voltage of the Transformer

The overall voltage of the transformer should be twice that required for the tubes, for the voltage of half of the winding is used only at one time. Its rating may be very low; 10 watts is sufficient in an efficient transformer. The inductances used in the filter should be very high, 2 to 5 henries, while the condenser should be of 4 mfd.

The explanation here covers the principles at present used in applying alternating currents to vacuum tubes. But they are not finding wide application as yet. The art is still young. For cheapness as to first cost and portability the batteries are far ahead but with the more common use of Radio sets in places of amusement, stores and restaurants, the

A. C. set is as sure to come as the generator distanced the primary battery as a source of power. The solution of the problem is a challenge to the entire experimental field, for to it has gone many of the successes in the past.

(TO BE CONTINUED)

**Fans** List of **Free** RADIO Bargains  
**RADIO BARGAINS**  
 17 North LaSalle St., Chicago



ON APPROVAL FOR 30¢  
 ZOBEL-STEIN LABORATORIES  
 322 9TH ST. BROOKLYN, N.Y. SOUTH 2650

**FORMICA**  
 A Laminated Phenolic Condensation Product  
 SHEETS TUBES RODS  
**RADIO PANELS**  
 POLISHED BLACK FINISH

CUT PERFECTLY SQUARE TO ANY SIZE

1/32" THICK	1/2¢ PER SQ. INCH
1/16" THICK	3/4¢ PER SQ. INCH
3/32" THICK	1¢ PER SQ. INCH
1/8" THICK	1 1/2¢ PER SQ. INCH
3/16" THICK	2¢ PER SQ. INCH
1/4" THICK	2 1/2¢ PER SQ. INCH
3/8" THICK	4¢ PER SQ. INCH
1/2" THICK	5 1/4¢ PER SQ. INCH

SEND FOR COMPLETE PRICE LIST  
 PROMPT ATTENTION TO MAIL ORDERS  
 DEALERS PRICES ON APPLICATION

**STARRETT MFG. CO.**  
 519 SOUTH GREEN ST. CHICAGO

RADIO SPECIALS—WHY PAY MORE?

- UV-201A, UV-199, WD-11, WD-12 Radiotrons... \$ 5.49
  - SIMPLEX 3000-Ohm Guaranteed Phones... 3.45
  - BRANDES "SUPERIOR" Phones... 4.86
  - ERLA REFLEX TRANSFORMERS... 3.96
  - Large size 22 1/2-Volt Variable "B" Battery... 1.95
  - Large size 45-Volt Variable "B" Battery... 3.76
  - 30-Ohm Rheostats, 55c; 250-Ohm Potentiometer .65
  - Crosley Model V with 1 1/2-V. Tube, Batteries and Phones... 28.95
  - Crosley Model 3B with 1 1/2-V. Tube, Batteries and Phones... 51.86
  - Crosley Model X with 1 1/2-V. Tube, Batteries and Phones... 78.31
- Simplex Radio Sales, 1806 Lafayette, St. Louis, Mo.

TWO SUPERSENSITIVE CIRCUITS

(Both Copyrighted)  
 My Highly Improved Reinartz brings in all important stations on both coasts and Mexican border, loud, clear and without distortion. We dance to music from Atlanta received on one loud Baldwin unit. Build one of these wonderful sets from my blueprints and specifications, price 50c, or with a perfect and complete double wound spiderweb coil, \$3.00 by mail. No other windings used. Photo of my set on a glass panel with every order.

This copyrighted circuit is the most successful of any Reinartz modification yet produced, and is imitated the most. Thousands are in use.  
 My W. D. 11 Circuit is especially designed for use with the "Pickle" tube and brings out the full value of that little tube as no other circuit can. Stations 1000 miles away come in clearly on one tube. This set is small, complete, portable. For the man who wishes the highest efficiency, this is the set to build. Price of blueprint and specifications, 50c, or with complete and perfect windings, \$3.00. Photo of set with every order.

Sets built from these plans will receive all broadcasting stations operating under the new laws. Their wave length range is from 170 to 800 meters.  
**AUXILIARY TUNER**  
 This new instrument connected to your present receiving set with one wire enables you to easily bring in both the long and short wave stations which you cannot get with your present equipment. It also enables you to eliminate that local interference so you may listen to distant stations.

Copyrighted diagram and complete instructions for building and operating this instrument, 50c, or with all parts, including Condenser, Coils, Switches, and Panel, \$3.50. Complete instrument, \$15. All goods prepaid.  
 These instruments are easy to build, easy to operate. Everything clearly shown.

**S. A. TWITCHELL**  
 1925 Western Avenue, Minneapolis, Minn.

ERLA REFLEX

Bulletin 14 Now Ready

Dealers: Attractive Discounts.

Note: We are the largest exclusive Radio Jobbers in the Middle West.

**HUDSON-ROSS**  
 123 W. Madison St. Chicago



**YELLOWTIP**  
 MICROMETER ADJUSTING  
**CRYSTAL DETECTOR**

Any adjustment made in a moment—fixed instantly! Hold indefinitely, until you wish to change, then—"A Twist of the Wrist—It's Set." Ideal for \$2 reflex and other circuits.

Write for folder, and name of your nearest dealer

**Wholesale Radio Equipment Co.**  
 Exclusive Factory Representatives  
 35 William Street, Newark, N. J.  
 Dealers and Jobbers—Write for Attractive Proposition

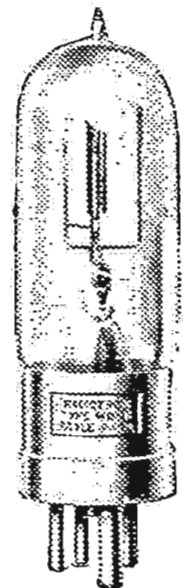

**Radiotron UV-200**  
 The long distance detector \$5.00



**Radiotron WD-11**  
 The ideal dry battery detector and amplifier \$6.50

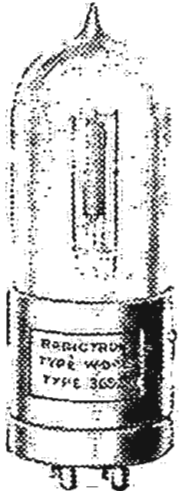

**Radiotron WD-12**  
 The standard base dry cell tube, \$6.50

**Radiotron UV-201-A**  
 The super-amplifier tube, \$6.50

**Radiotron UV-199**  
 The little tube of big performance, \$6.50



This symbol of quality is your protection

**3,600,000 Radiotrons/**  
 already made and sold!

This one fact reveals at a glance the growth of radio! 3,600,000 RADIOTRONS already sold! It was the perfection of the RADIOTRON that made popularization of radio possible—and every vacuum tube set needs RADIOTRONS for clear reception and amplification—for sensitivity—and long distance reception.

Radio Corporation of America  
 Sales Dept., Suite 3002; 233 Broadway, New York

District Sales Offices:

10 South LaSalle Street, Chicago, Ill. 433 California Street, San Francisco, Cal.

**Radiotrons**  
 REG. U. S. PAT. OFF.

# How to Make Loop Aerial De Luxe

## Constructional Detail Suitable for Parlor Use

By H. J. Marx

THE average fan has had little opportunity for real loop aerial reception. First, on account of the very few loop aerials that are on the market and at a price within their means; second, because of the lack of complete details on the construction of a really efficient loop aerial. The broad band of wave length

give very good reception results, is as small as possible and covers the necessary wave length range. Its design is based on experiments made with a number of different types and sizes. It can easily be made up by any of the fans who have that knack of handling tools and take pleasure in making their own apparatus.

four side frames; 2 pcs. fiber tubing 24 inches long, 3/8 inch outside diameter, 1/4 inch inside diameter for vertical and horizontal arms; 1 pc. brass rod 3 inches long, 1/4 inch diameter for the upper and lower pivots; 1 pivot nut-thread to suit pivot stud; 2 pcs. brass 3/4 x 3/4 x 1/8 inch for pivot bearings; 7 pcs. brass 5x2x1/8 inch for the base plates; 6 pcs. brass 2x2x1/8 inch for the corner plates; 3 2-inch flat head wood screws, iron; 12 1/2-inch flat head wood screws, brass; 36 1/2-inch round head wood screws, brass.

made and finished. The shoulder at one end holds the end of the adjacent side in position. Two of the 1 1/2-inch flat head wood screws should be used at each corner, drilling and countersinking the wood first. The six brass corner plates can then be finished and fastened on both sides of three of the corners with the 1/2 inch round head wood screws.

The frame is then mounted in the seat, and held in place with four of the 1 1/2-inch wood screws through from the inside of the frame.

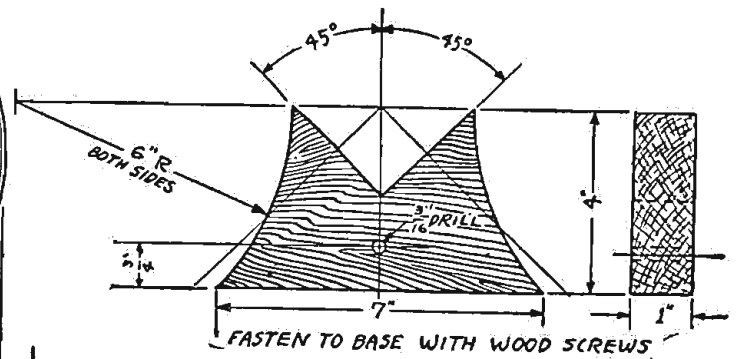
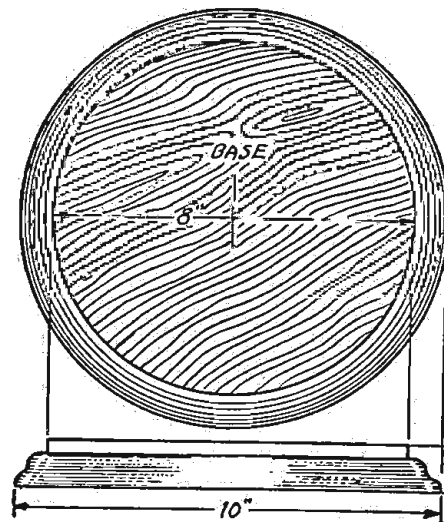
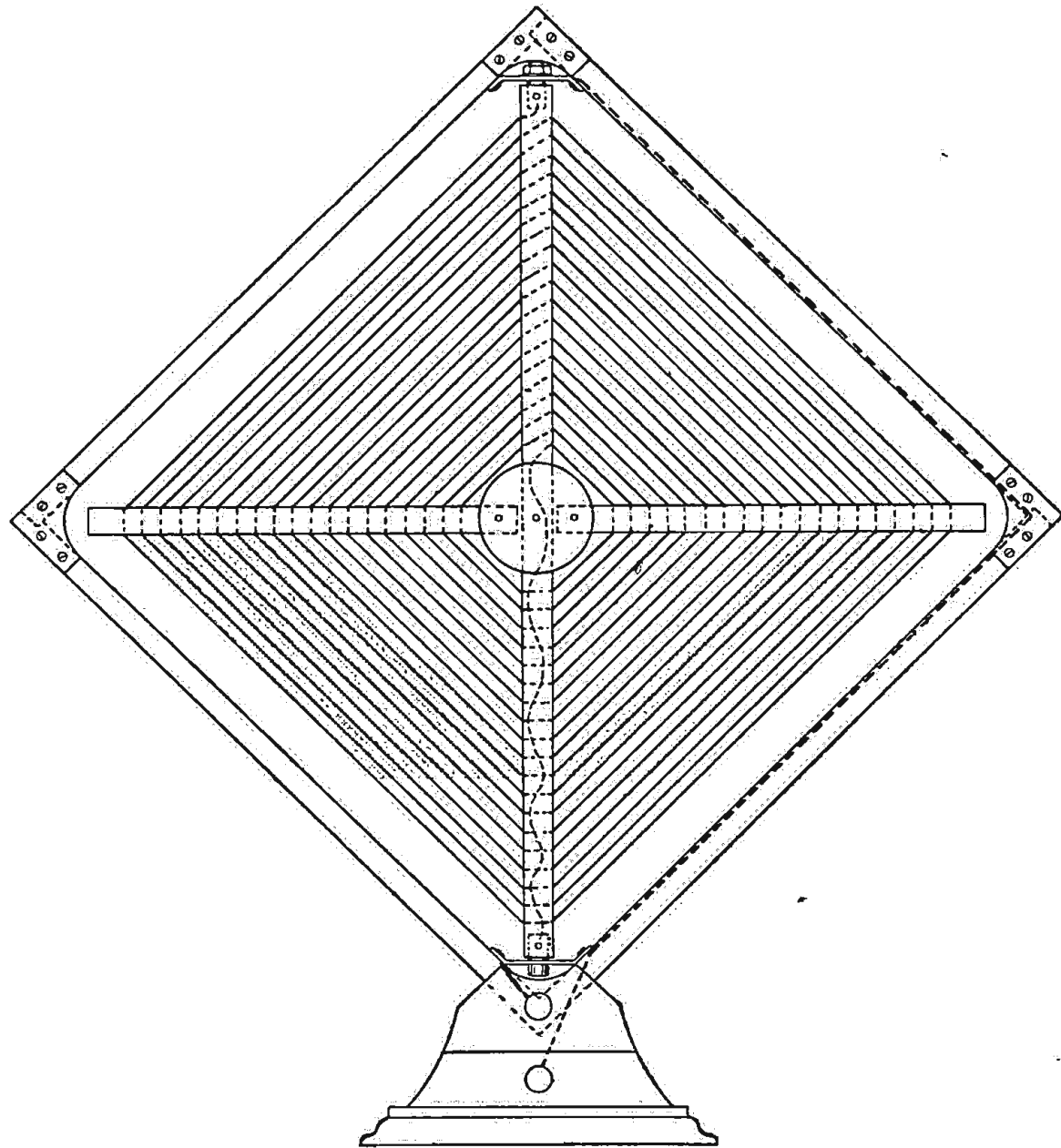

### Cutting Material

The base is turned in a wood lathe to the overall dimensions given. The design on the ends is left to the taste of the wood turner. All wooden parts should be well sandpapered and smoothed down before assembly.

The base seat is cut to size and finished. This can then be mounted on the base. The three (2-inch) flat head wood screws come through from the bottom of the base and hold the seat firmly in position. It is advisable to first drill and countersink the holes in the base and then use a small drill for the seat in order to properly direct the screws and avoid splitting of the wood.

The four side frames should next be

The two brass base plates are cut and fastened in position on each side with eight of the 1/2-inch round head wood screws.

### Assembly of Loop Cross Frame

The center crosspiece is another wood turning job. The two 3/8-inch holes are drilled by hand, but care must be taken to see that they run true and at right angles to each other. If not drilled true, it de-

(Continued on page 14)

range at present utilized in Radiophone broadcasting makes it difficult to get a loop that really serves the purpose. Another factor lies in the appearance of the loop. There is a decided tendency to try and eliminate the outdoor antenna, but it is based on the possibility of substituting a good loop aerial.

A good loop aerial does not mean one so bulky that it not only takes up too much room but is usually entirely inappropriate for an attractive room at home.

### The Requirements in Loop Aerials

The essential points of a good loop aerial are:

- (1) Efficiency over present operating wave lengths.
(2) Reasonable price.
(3) Compactness, and easily handled.
(4) Attractive and workmanlike in appearance.

Large loops have their advantages, but some form of compromise is necessary. The loop under discussion was found to

If dimensions and detail instructions are carefully followed, it will fit together without difficulty.

### Material Required

The material required is: 65 ft. of No. 20 double silk covered wire; 2 binding posts, 1 1/2 inch machine screws to fit; 1 pc. birch 10 1/2 x 10 1/2 x 1 inch for the base; 1 pc. birch 7 1/2 x 4 1/2 x 1 inch for the seat; 1 pc. birch 3 1/2 x 3 1/2 x 1 inch for the center crosspiece; 1 pc. birch 20 x 4 x 1 inch for the

## Bunch Your Orders Don't Scatter Them

Dealers who form the good habit of "putting all their eggs in the H-R basket" WIN OUT—save a lot of time, worry, mistakes, delays and money.

We are distributors of the largest and most responsible manufacturers of nationally advertised radio equipment in the U. S. and carry complete stocks, for immediate shipment in any quantity. We have abolished mistakes and delays by our double-check, time-stamp system of handling orders. We represent:

- Atwater-Kent, Eral, United Mfg. Co., Murdock, General Radio Corp., Carter, Dubilier, All American, Howard, Federal Tel. & Tel. Brands, Radi-Un Loops, Baldwin, Coto Coil, Tungar Chargers, Bradleystats, Univermier, Eveready B's and A's, Celeron Panels, C. R. L., Acme, Hilco

Send for literature and discounts, stating lines on which you wish immediate quotations.

We are the largest exclusive Radio Jobbers in the middle west.

HUDSON-ROSS 123 W. Madison St. Chicago

## 562 Page RADIO Handbook, only \$1

Just off the press! The greatest book on Radio ever written. 562 pages. Compiled by Harry F. Dart, B. S. E. E., formerly with the Western Electric Co., and U. S. Army Instructor of Radio. Technically edited by F. H. Doane.

Filled with sound, practical, tested information for every radio fan, from beginner to hard-boiled owl. Send \$1 to-day and get this 562-page I. C. S. Radio Handbook before you spend another cent on parts. Money back if not satisfied.

### Mail the Coupon Today

INTERNATIONAL CORRESPONDENCE SCHOOLS Box 8275-B, Scranton, Penna.

I enclose One Dollar. Please send me—postpaid—the 562-page I. C. S. Radio Handbook. It is understood that if I am not entirely satisfied I may return this book within five days and you will refund my money.

Name ..... Address .....

## Cyclone Famous

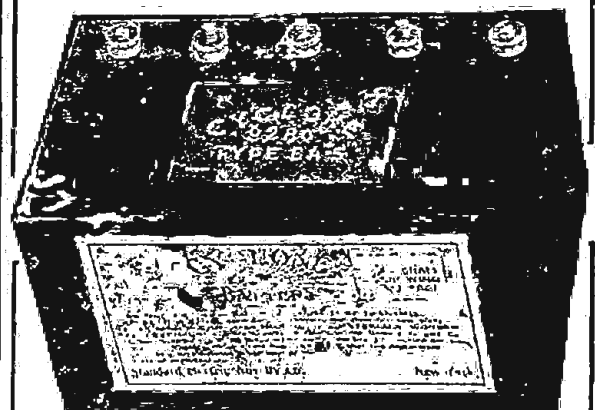

### World's Best

"A" and "B" BATTERIES specially built for your Radio Set in all types. Highest quality GUARANTEED for DISTANCE, CLEARNESS, and LONG LIFE.

STANDARD ELECTRIC NOVELTY CO.

New York City

Best proposition for Jobbers and Dealers. Some territory still available for New Distributors. Write for details at once.

### NEUTRODYNE CIRCUIT

Complete parts for 5 tube set. Bakelite Panel, drilled and engraved. Only the best known parts used. Satisfaction guaranteed.

\$27.75

## Morrison

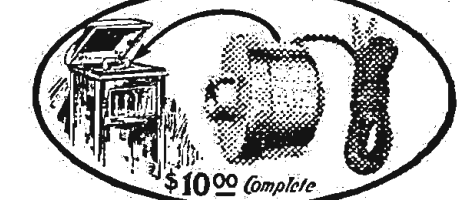

Loud Speaker \$10.00 Complete

### ERLA REFLEX CIRCUIT

Works a Loud Speaker on one tube. Complete parts, including Erla Reflex Transformer, Franco Audio Transformer and Bakelite Panel. Special.

\$27.50

### MORRISON LOUD SPEAKER \$10.00

"Renowned for Sound!"

### EVEREADY "B" BATTERIES

45 Volt, Large ..... \$3.50 22 Volt, Large ..... 2.25

### PHONES

Table listing various phone models and their prices, including Western Electric, Dr. Seibt, and Nathaniel Baldwin models.

## Perfection Radio Corporation

59 CORTLAND STREET NEW YORK CITY

Six New York Retail Stores Add Parcel Post Do Not Send Stamps 208 page complete Radio catalogue free with orders of \$5.00 on request. Otherwise prepaid for 25 cents.

Advertisement for Chas. Freshman Co. Inc. featuring 'Variable Resistance Leaks FOR PANEL MOUNTING' and 'Radio Condenser Products'. Includes a diagram of a condenser and contact information for 106 Seventh Ave. New York.

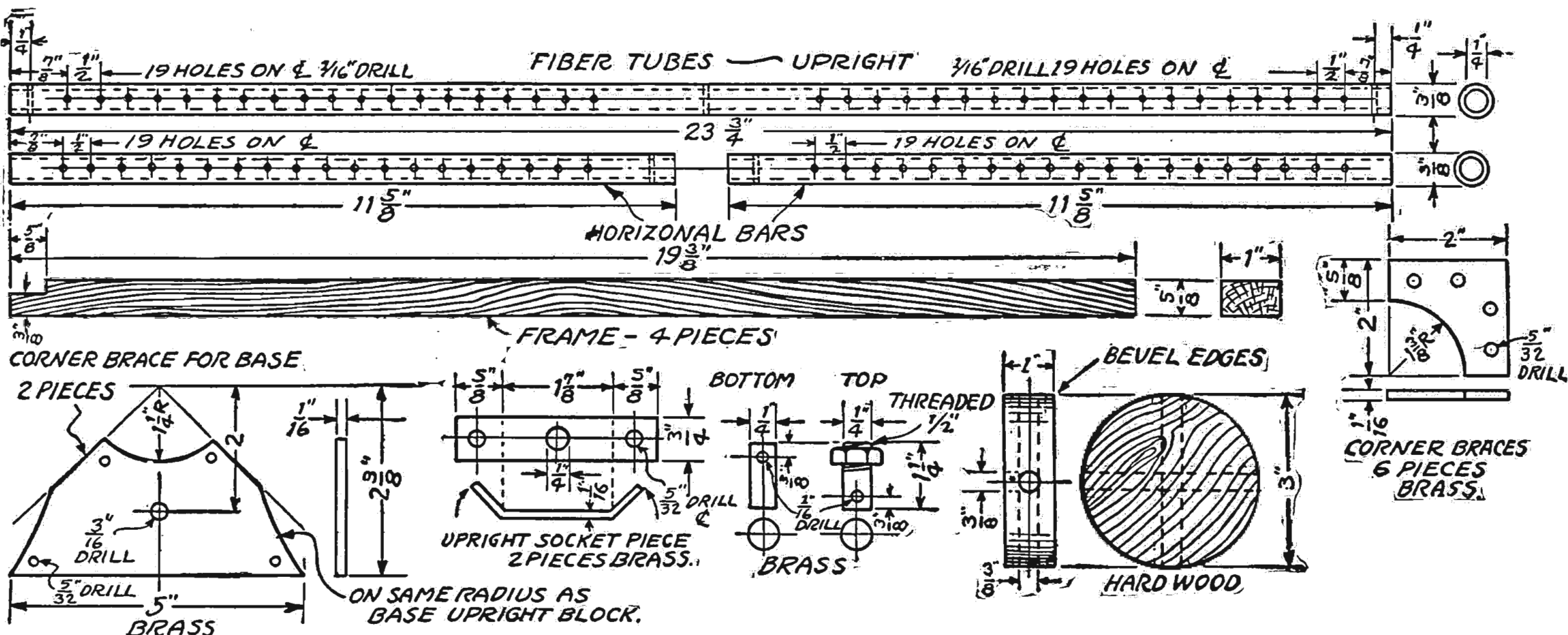

### DE LUXE LOOP AERIAL

(Continued from page 13)

tracts considerably from the appearance of the loop.

The fiber tubing is first cut to the proper lengths. Then the holes are carefully laid out and drilled as shown in detail drawings. The long vertical tube is passed through the center crosspiece. A hole, 1/8-inch, is drilled at the center of the crosspiece passing through the tube. An ordinary brad or nail slightly larger than 1/8-inch in thickness is then forced through and cut off level on each side. The two horizontal tubes are then inserted and locked in position in the same manner.

#### Wiring the Loop

The loop is now ready for wiring, which must be pulled through the holes. This

is started on the inside turn, passing the end through the upper inside turn and leaving about 6 inches of wire project from the lower end of the tube. This will have to be held in place so the wires can be wound taut. Winding from there on consists of passing the full length of the wire through the holes for each successive turn as indicated in the assembled view. This is a tedious job but not necessarily a long one. See that the wires are kept taut throughout, as the appearance of the wires has a lot to do with the appearance of the whole unit.

After the wiring has been completed the brass pivot studs are slipped in place, and locked with a 1/8-inch brad or nail in the same manner as the cross arms in the center crosspiece. The ends of the loop wires should make contact with the two studs.

The pivot plates should be made up and screwed into place with the 1/2-inch round head wood screws. The top one however must be removed again for assembly. It is passed over the upper stud and the pivot nut screwed down. The loop is then placed inside of the frame, with the lower stud in its pivot plate and the screws of the upper pivot plate are again fastened in place. By turning the pivot nut the loop can be suspended equidistant between the two plates.

#### Binding Post Connections

The binding posts are then put in place, the upper post being connected to the lower pivot plate. A wire is run on the inside of the frame from the upper pivot plate to the lower binding post. It is suggested that a pigtail connection be made between the studs and plates so as to insure more perfect electrical connection, as the lower pivot contact may produce a very poor connection.

#### Finish of the Frame

To improve the appearance of the loop, all brass plates and wood screws should be nickel-plated. The frame and base should be stained and varnished before

assembly. The fiber tubing can be obtained in black, red or light yellow (straw color).

One advantage of this construction is the fact that the base need not be rotated. The loop will rotate in any direction inside of the frame.

The average life of a standard B battery is about nine months.

### Steel Tape Makes Aerial

While with an engineering party on a railroad survey we made a trip off the line into the mountains. Anticipating the fact that we would have several lonely evenings I carried with me a two tube portable regenerative receiver.

It was not until the first night's camp that I announced the surprise to the rest of the boys only to have my hopes for an evening's entertainment dashed when I discovered I had failed to include the coil of insulating wire that I used for an aerial. We were entirely out of the line of communication with not even a barbed wire fence to which to hook our set.

The five of us set our heads to working, the result being that we took two of our fifty foot steel tape lines, clamped them together, hooked one end on top of a pine and the other to the set. One of our metal stakes made an excellent ground and we received KHJ, KFI and KPO in great shape.

Upon returning I took the case from an old cloth tape line and cut the line off. Then I wound up 100 feet of 1/4-inch copper on the spool. This was not enough better to discard the ordinary steel tape. So I now make it a point to carry a 100 foot steel line for my portable set. I cannot imagine anything better for a

portable aerial as it takes up very little room and is very efficient.—G. L. King, Winslow, Ariz.

### Protect Your Filaments

The addition of an ordinary 25-watt incandescent lamp in series with the plate and telephone receivers of your receiving set will not hinder the normal operation of the set in any way and will protect the filament from burning out in case the B battery is accidentally connected to the wrong terminals.

## The Condenser Sensation of Modern Radio



Through the accuracy and dependability of Freshman Condensers, hook-ups and circuits have been perfected which have completely revolutionized the art of Radio Reception.

*These little Storers of energy and rectifiers of Radio Current are the very heart of a well-built radio set.*

The proper fixed condenser will make all the difference in the world in the reception, clarity and selectivity your set affords.

Capacity	Each	Capacity	Each
.0001	.35	.002	.40
.00015	.35	.0025	.50
.0002	.35	.003	.60
.00025	.35	.004	.75
.0003	.35	.005	.75
.00035	.35	.006	.75
.0005	.35	.008	1.00
.0006	.40	.01	1.00
.0008	.40	.015	1.50
.001	.40	.02	2.00
.0015	.40	.025	2.50

The FRESHMAN is so designed that constant equal pressure is exerted on the condenser plates over the entire area. They are the only condensers that do this and therefore the only condensers that avoid noises, which are due to variable pressure on the plates.

At your dealers, otherwise send purchase price and you will be supplied postpaid.

**Chas. Freshman Co. Inc.**  
Radio Condenser Products  
106 Seventh Avenue New York

## DEALERS!!

"NEUTRODYNE" — Have you given it the proper thought and attention? We distribute the Famous GAROD-TYPE-RAF.

This set will be the biggest money-maker of the season. Write for descriptive literature and discounts on this marvelous Coast to Coast set.

#### WE ALSO REPRESENT

King Quality	United
Acme	Eisemann
Morrison Loud Speaker	Jofferson
Pioneer	Bremser Tully
Dubilier	Grewol
Saturn	Steinmetz
All-American	Portabloop
Federal Tel. & Tel.	True Tone
Leich	Amperite
Howard	Filkostats

Besides above lines we have connections with other leading manufacturers in U. S. and Europe. Let us know your wants, we will supply.

Send for literature and discounts. We are prepared to present immediate quotations and real service.

RADIO DEPARTMENT  
**OVERSEAS TRADING CO.**  
Tel. Central 6552  
116 South Michigan Ave., CHICAGO

### ANY ARTICLE

listed in the sets below may be purchased separately at our cut prices.

## BUILD YOUR OWN SET

ALL INSTRUCTIONS INCLUDED ALL PANELS DRILLED—READY TO MOUNT

### FLEWELLING CIRCUIT COMPLETE!!

	Reg. Price	Our Price
6x14 Formica Panel	\$1.26	\$1.10
23 Plate Variable Condenser	3.30	1.45
Three .006 Mica Condensers	3.00	2.25
CRL Variable Grid Leak	1.85	1.35
Grid Leak	.40	.25
2 Coil Adjustable Honeycomb Coil Mounting with Knobs	4.00	2.65
50 Turn Honeycomb Coil	.75	.40
75 Turn Honeycomb Coil	.75	.40
2 Coil Mounts with Straps	1.20	.80
1 Bakelite Socket	1.00	.45
Variable Rheostat	1.50	1.35
1 Bakelite 3" Dial	1.00	.25
8 Binding Posts	.80	.40
1 Baseboard for Mounting	.30	.20
1 Blueprint with Complete Instructions for Assembly and Wiring	1.00	.50

Regular Price .....\$22.16

Our Price  
**\$12<sup>45</sup>**

**THORDARSON**  
HIGH AND LOW RATIO TRANSFORMERS  
**\$2.45**

### AUTOMATIC ELECTRIC \$10.00 VALUE HEAD SETS

**\$3<sup>65</sup>**

40,000 head sets—the entire stock of the Automatic Electric Co., of Chicago—for us a single purchase. Here is but one of the many opportunities our enormous buying power offers you—in this special case a splendid Automatic Electric \$10 head set for only \$3.65.



The Automatic Electric head set embodies a style and design proved by use and experiment to be the best. Coil wound with about 6500 turns of No. 40 enamel coated copper wire. Direct current resistance approximately 1600 ohms. Impedance at average music and voice frequency (800 cycles) is 21,000 ohms.

### HAZELTINE NEUTRODYNE

CIRCUIT COMPLETE!!

ALL PARTS LICENSED UNDER HAZELTINE PATENTS

- 1 7x21x3/16 drilled formica panel
- 1 Howard rheostat
- 3 John Firth bakelite sockets
- 8 Binding posts
- 3 23 plate variable condensers
- 1 Wave control neutroformer
- 2 Radio frequency amplifying neutroformers
- 2 Grid neutralizing condensers
- 1 .00025 micron grid condenser
- 1 Marco variable grid leak
- 1 Base board for mounting
- 25 feet tinned copper bus bar wire and complete instructions for assembling and wiring.

**\$28<sup>60</sup>**

**ELECTRIC SOLDERING IRON**  
ONE YEAR GUARANTEE  
**\$2.45**

### "THE LARGEST RADIO STORE IN AMERICA"

ALL MDSE. GUARANTEED BY US TO BE OF FIRST QUALITY



ALL MAIL ORDERS, LARGE OR SMALL, SHIPPED TO YOU PROMPTLY

509 South State St., Dept. D 8-15, CHICAGO, ILL.

# Human "Earful" Measured by Aid of Radio Tubes

## Device Shows 300,000 Tones Audible to Normal Ear

By C. W. Tucker

**L**END us your ears; in a few minutes we can tell you by means of the audiometer whether you receive full measure when you get an "earful." You know there are earfuls and earfuls, just as there are types of ears. Most everyone has observed the many different kinds of ears. Some are small, some large; some are pinned back close to the head; others stand out like wings; some can be wiggled and others can't. But, of course, that is only the outer ear.

The inner ear, the part that actually does the hearing, is inside the head; its peculiarities cannot be observed by the innocent bystander. But from what the scientists of the Bell System laboratories of the Western Electric company tell us, there are as many variations in the inner ear and its hearing quality as there are in the outer ear. Therefore, there has never been evolved a standard unit of measure for an earful.

By measuring the hearing of a number of normal ears there has now been established a standard for the normal hearing. This is done by finding out the total number of pure tones audible to the person with normal hearing. A pure tone is one in which there is no mixture of other tones; it is specified by pitch and loudness. The pitch is determined by the rate of vibration and the loudness by the intensity of the vibration.

These findings are plotted on a chart, as shown below. The lower line is established by finding the lowest intensity at which the tones can be heard. The tones are spaced an octave apart on the musical

scale, the total number of pure tones perceptible to the normal ear would be the product of these two numbers, or 405,000 tones. But as the ear is not as sensitive to the higher and lower tones there are

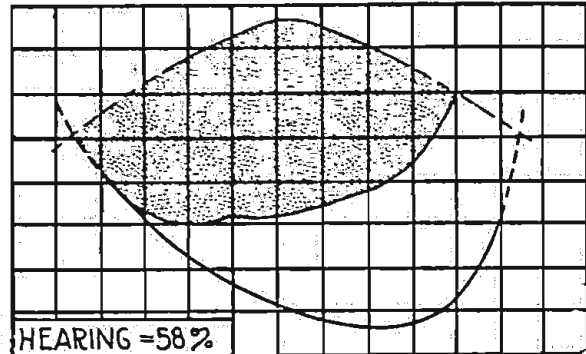

300,000 sounds which are audible to the normal ear.

Having determined the number of pure tones audible to the normal ear by the same method, the degree of deafness of a person with abnormal hearing can just as easily be ascertained. The upper charts show the percentage of the normal hearing that two persons, A and B, possess. Mr. A when he gets an earful gets

only 12 per cent. of the news that the person with the normal hearing gets under the same conditions. B hears 58 per cent. of all that the person with normal audibility hears.

One of the distinct advantages of this

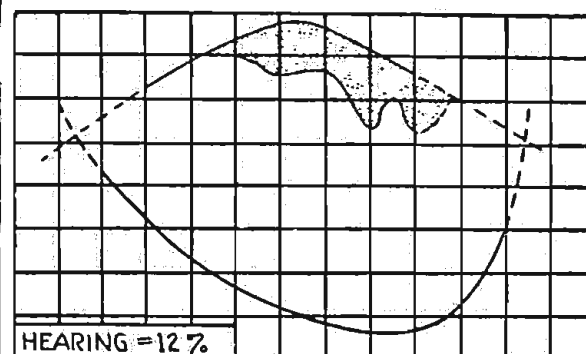

method of measuring the hearing is that it is possible to find just what tones cannot be heard. This gives the doctors a very good clue as to what is causing the deafness. It may then be possible to remove the cause and in some cases restore normal hearing to the afflicted.

The audiometer is very useful in legal cases. Considerable confusion exists in courts where the degree of deafness is

involved, as there are a number of laws which prevent persons with poor hearing from engaging in certain kinds of work. For example, one cannot operate an automobile if he has a certain degree of deafness. At the present time there is a wide variation between the standards of various doctors in different parts of the country. The audiometer measures deafness with such accuracy that there is little opportunity for dispute.

The audiometer is composed of vacuum tubes, coils and adjustable resistances. By a proper arrangement of circuits the vacuum tube is capable of generating an oscillating electrical current of any desired frequency. This electrical vibration is transferred into sound vibration by means of a telephone receiver. Between the receiver and the oscillator a wire network, called an attenuator, is interposed which makes it possible to regulate the volume of sound. The theory of the receiver used to calibrate the audiometer has been worked out so that it is possible to calculate its acoustic output from the electrical energy it is absorbing. In this way it is possible to calculate the pressure produced in the outer ear canal while a tone is perceived.

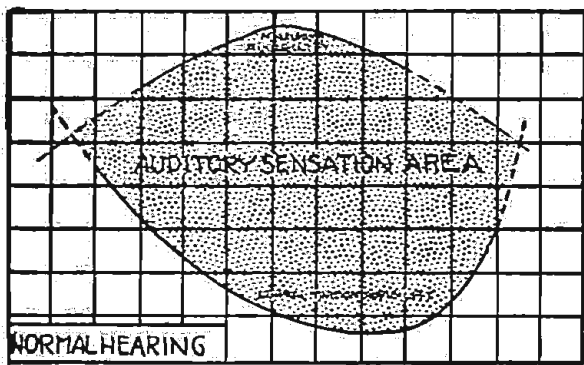

scale. You will see by this figure that the intensity or loudness of the higher and lower tones must be considerably greater to be audible than the tones near the middle of the scale. This makes the line of minimum audibility a curved line, as shown, instead of a straight one. The upper line, marked "maximum audibility," shows the maximum intensity at which these tones can be heard without hurting the ears. Likewise this is a curved line, because the higher and lower tones hurt the ears with less intensity or loudness than do those near the middle of the scale. The area between these two lines shows the area of normal hearing.

The question naturally arises in the reader's mind as to how many pure tones are audible to the normal ear. It has been determined that at high C, or C3, there are 270 graduations of volume which can be sensed one from the other. At the line of intensity or loudness, where the area is widest on the normal chart, 1,500 tones can be perceived as having different pitches. If the ear were equally sensitive

*You Can't Afford to Miss*

THE SECOND ANNUAL

# American Radio Exposition

*Under the auspices of the*

American Radio Exposition Company

of New York

OCTOBER 6-13, 1923

(EXCEPTING SUNDAY)

Grand Central Palace

NEW YORK

*Hundreds of Features for the Fans!*

A big Amateur Contest for the best home-built set  
Open to ALL Amateurs—Valuable Prizes—Write for details  
Sets from all over the country will be entered.

Motion Pictures on Sensational Radio Topics. Unusual Scenics and Educational Displays, Showing Recent Developments in Radio Industry.

*Applications for space and all communications regarding the Exposition should be sent to*

American Radio Exposition Co., 120 Broadway, N. Y.

J. C. JOHNSON, GENERAL MANAGER

## PROTECT

The Heart of Your Radio Set

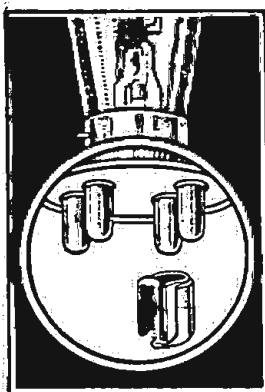

Vacuum Tubes are costly and extremely delicate. A battery or any other excessive current applied for only a fraction of a second to the filament leads will burn out your tubes. You have probably already had this experience and it is apt to happen again at any time. A burnt out tube means money lost—the set out of commission—inconvenience to you.

### WHY TAKE THESE CHANCES WHEN RADECO SAFETY FUSES

will absolutely protect your tubes. Applied in an instant to the filament terminals. Will fit any standard tube or go in any standard socket. Fully guaranteed. 50 cents each. Sent Postpaid. Delay may be costly. Write now. Specify type of tube used.

DEPT. 6

RADIO EQUIPMENT COMPANY

630 Washington Street Boston, Mass.

New England's Oldest Exclusive Radio House. Distributors of many other successful Radio Specialties. Dealers:—Write for our proposition and full details.

### THREE TUBE RADIO FREQUENCY CIRCUIT

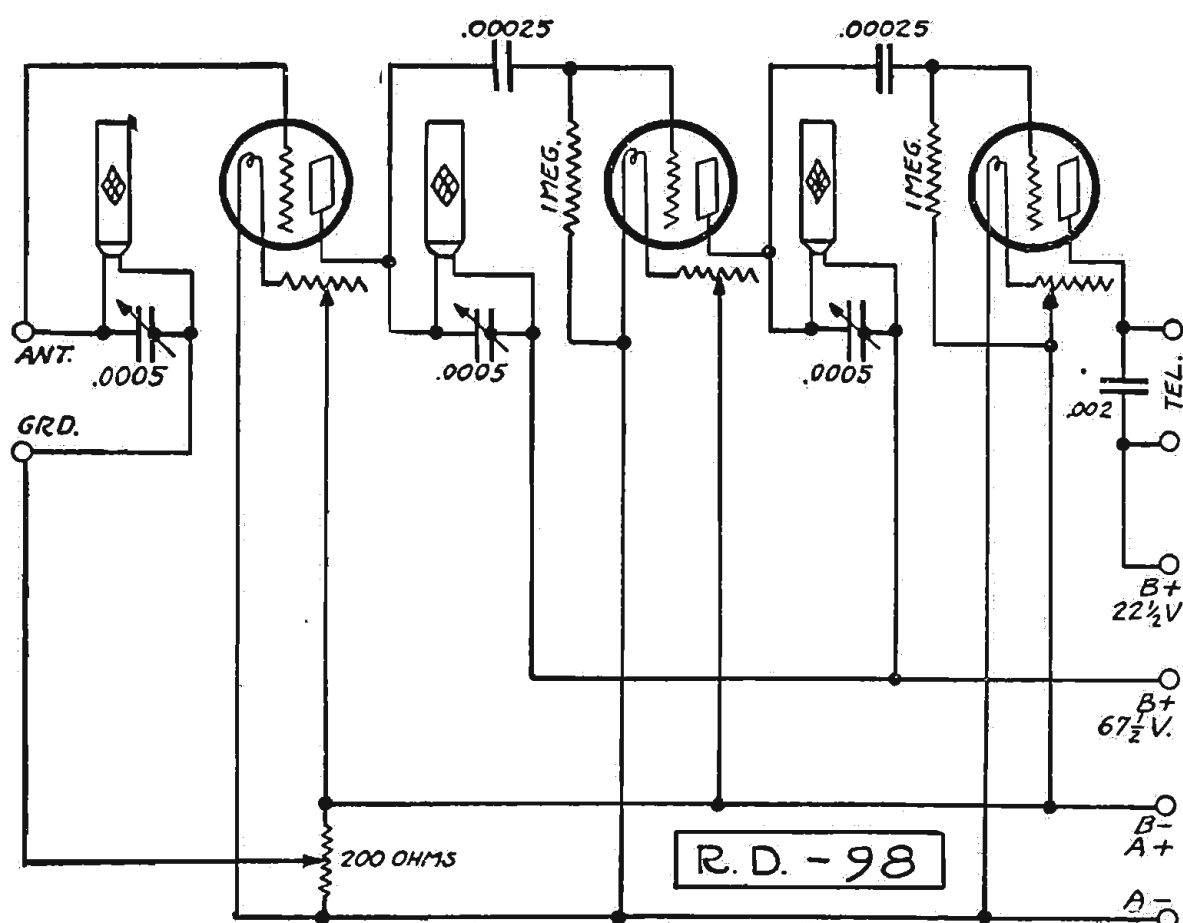

THERE have been many inquiries for a good tuned impedance coupled Radio Frequency receiver. The selectivity of this type of circuit is unusually good and the circuit is recommended for fans who plan long distance receiving for the fall. A two stage audio frequency amplifier can be added in cases where loud speaker volume is desired.

Three sets of three different coils can be kept on hand for all the music broadcasting wave lengths. These three are 35, 50 and 75 turns. When tuned with the .0005 condensers the required wave length range is well covered. Naturally the coils as used will be the same in the three stages; that is, either all 50 turn coils or all of 35 or 75 turns. This means nine coils to be kept on hand.

The fan must remember however that each stage must be tuned to the proper

wave length in order to get satisfactory reception.

If dry cell tubes are used, the potentiometer should be of the high resistance type. The resistance of the rheostat is determined by the type of tubes used. The first two tubes are Radio frequency amplifiers, the last tube is a detector. Three fixed condensers are required, two of .00025 mfd. capacity and one .002 mfd. phone condenser. Two 1 megohm grid leaks are used.

The detector tube requires 22½ volts on the plate but the two amplifier tubes should have 67½ volts. The honeycomb coils should not be placed in inductive relation to one another. Three single coil mounts should be used. A good single wire aerial about 80 to 100 feet long and as high as possible is recommended for distance receiving.

### The Reader's View

#### Phone Transmission

I would like to see a law passed allowing phone transmitting without the knowledge of code. Say on a 175 meter power limit—about 20 watts.

There are lots of people interested in Radiophone communication who are too old to learn the code. Men who could probably develop circuits and apparatus more efficiently than those used today. Men such as electrical engineers, mechanical engineers, etc.

In the neighborhood where I live there are several amateurs, and I know I would like very much to be able to talk to them, and I think I am not alone in this.—W. Arnold Force, East Orange, N. J.

#### Future of Broadcasting

As a Radiophan interested in development I take the liberty of requesting your fine publication to consider seriously the problem of the future of broadcasting.

It is evident that the programs of the broadcasting stations are becoming inferior due to numerous reasons. If Radio as a means of entertainment is to be saved from a serious setback some radical step must be taken to assure the present owners and future purchasers of Radio sets that they will be able to receive programs worthy of their time and money invested. To the ordinary fan broadcast phonograph music, automatic piano music, inferior artists and other stuff are poor returns on the money invested.

I could name stations which daily are broadcasting the same pieces; this is a farce. If this continues and the prospective purchasers of sets "get wise" the manufacturers of Radio equipment will lose most and the people will lose a valuable means of entertainment.

After owning a set for a few months and after the wonder of being able to "tune in" has lost some of its interest, after one has listened to the best that the stations offer, one starts to wonder "is it worth while?" Yet one lives on hope; we all hope the situation will improve.

In the hope that the situation may be improved, I request that you endeavor to obtain the approval of your readers to the following plan:

The government should license every Radio receiving set on a graduated scale to be determined according to its range or value, with a minimum charge yearly

### Reviews of Books

**An Introduction to Radio.** A real book for the amateur. This treatise comes in two volumes. 96 pages in each volume, fully illustrated with flexible leather covers. Price two volumes, \$1.

**How to Retail Radio.** A new book telling of tested plans and methods and policies for the dealer in Radio. Financing, location, store equipment and arrangement. Price, \$2.00.

**Vacuum Tube Receivers.** By O. F. Hessler. A book that tells how to make a simple set. How to make the cabinet. It includes a 27 by 36-inch layout blueprint. Price, 75 cents.

**The Armstrong Super-Regenerative Circuit.** By George J. Eltz, Jr., E. E. This is a De Luxe edition of this famous circuit. Profusely illustrated and fully explained. Fifty-two pages. Price, \$1.00.

**Home Radio—How to Make It.** By A. Hyatt Verrill. This book is particularly adapted for the amateur who desires to know how to make Radiophones. Twelve full page illustrations and diagrams. Price, 75 cents.

**Radio for the Amateur.** By A. H. Packer and R. R. Haugh. The underlying principles of Radio thoroughly explained in simple language and understandable illustrations. This book will teach you how to construct and operate a receiving set successfully. Price, \$1.50.

**Radio Reception.** By Harry J. Marx, Technical Editor Radio Digest Illustrated, and Adrian Van Muffling. A simple treatise on Radio reception. Beginning with the elementary principles of electricity it carries the reader on into the essentials of Radio telephony. The most successful methods of Radio reception are explained and special reference given to practical tuning, 230 pages, with 130 illustrations. Price, \$2.00.

The book department of the Radio Digest is prepared to send you any of the books on Radio published, whether listed in our Book Review or not. Let us know what book you want, send us your check and we will see that the book is mailed to you. Postage stamps in payment for books not accepted. Send money order or check. Radio Book Department, Radio Digest, 123 W. Madison St., Chicago, Ill.

Do not use a hydrometer in a lead cell and then try it with a nickel iron cell. It will ruin the latter.

### Ready When Friends Call

Is your radio receiving ready when friends call, or do you have to make apologies—and as minute after minute slips by—do you feel yourself getting more and more embarrassed because your set—the one you made, won't work?

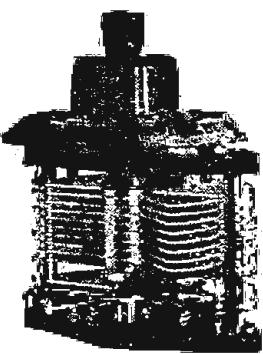

The way to be ready when friends call, to have that assurance that no matter when—your set will work, is to put into it only good parts. That's why Walnut parts are selling in greater and greater volume. They cost no more than the other kind, and you can always rely on them.

**Walnut Variable Condensers**—plates fitted into grooves, no nuts and washers to work loose and short circuit, in the following sizes: 3, 5, 13, 23 and 43 plate. Prices from \$1.50 to \$3.50, plain and vernier. \$4.25 for 13 plate, \$5.00 for 23 plate, \$6.00 for 43 plate.

**Walnut Inductance Switch.** 10 different switch points, all in one. Only one hole to drill in panel; quickly and easily installed .....\$1.00

**Walnut Tube Sockets**  
**Walnut Variable Grid Resistance**  
All tested and proved the best.

**Walnut Friction Vernier Adjuster.** Fits any panel, only one hole to drill—enables you to tune close and sharp and bring in stations you would otherwise pass by...\$0.25

All above will be sent postpaid on receipt of price; but ask your dealer first.

**WALNUT ELECTRIC MFG. CO.**  
Dept. 401 1219 West Van Buren Street CHICAGO, ILL.

of one dollar. The money raised by this taxation should be used to equip and maintain broadcasting stations in different parts of the country.

This proposal like every other would have its faults in that it may enable "graft" but with many thousands of highly interested fans daily listening in there would be but little chance for "rotten service."

It is estimated that there are 2,000,000 receiving sets in operation in this country which when taxed would amply provide daily broadcast entertainment from at least twelve powerful government stations each with entertainers of the very best.

Such a system would help to promote Radio equipment sales, lift the burden of the cost of broadcasting from the shoulders of the manufacturers and provide entertainment for the fans.—W. R. Spangle, Elkhart, Ind.

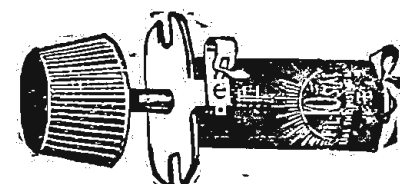

### MISSING WHAT YOU GET

YOUR set is probably bringing in DX stations you never hear because your rheostat cannot control your filament action. The Fil-Ko-Stat gives infinite adjustment and enables you to magnify the weak stations and bring them in strong and clear.

Full resistance 30 Ohms, adjusted to ALL TUBES. "Avoid the use of inferior powdered carbon rheostats."

At All Dealers in High Grade RADIO SUPPLIES

### FIL-KO-STAT

Made and Guaranteed by Dx Instrument Co., Harrisburg, Pa. Sole International Distributors. Radio Stores Corp., 218 W. 34, N. Y. City



WD-11-12, UV-199, UV-201-A, C-301-A .....\$3.50 each  
UV-200, C-300, AP Detectors..... 2.75 each  
UV-201, C-301, AP Amplifiers..... 3.00 each  
DV-6, DV-6-A ..... 3.50 each  
UV-202 ..... 4.00 each  
And Guarantee Them Equal to New

### ATTENTION

OUR NEW 6V. ¼ AMP. DETECTOR AND AMPLIFIER \$4.10  
THIS TUBE IS A REVELATION

**QUICK SERVICE**—Include with your order remittance to cover repair plus parcel postage for one pound per tube. If preferred, tubes will be returned C. O. D. repair charges.

**SPECIAL**  
**LOUD SPEAKER**, nickel-plated—21" high. Undistorted reproduction.  
Regular Price ..... \$15.00  
Our Price ..... 9.50  
Shipped prepaid.

ABALENE RADIO, 14 Vesey St., New York, N. Y.

### METALECTRIC SOLDERING IRON

(The All-Metal Instrument)

A Solution to the Small Soldering Problem of the Discriminating Assembler. Unbreakable Construction — Economical Operation on any Electrical Circuit—Interchangeable Tip.

**\$5.50**

From your dealer or write

**Post Electric Co., Mfrs.**  
Dept. 509, 30 East 42nd St. New York City



### SUPER-VALUES LOUD SPEAKERS

List Price	Our Price
\$ 60.00 MAGNAVOX TYPE R3.....	\$ 51.00
35.00 MAGNAVOX TYPE R2.....	29.50
25.00 ATLAS AMPLITONE.....	19.50
161.00 WESTERN ELECTRIC 10 A.....	125.75
55.00 WESTERN ELECTRIC 10 D.....	44.00
30.00 MUSIC MASTER.....	24.50

PHONES	
Brandes.....	\$5.25
N & K German.....	5.50
Dictograph.....	5.50

CONDENSERS	
3 Plate Vernier.....	\$0.90
23 Plate Vernier.....	2.50
43 Plate Vernier.....	2.75
23 Plate Plain.....	1.50
43 Plate Plain.....	1.90

FADA NEUTRODYNE PARTS	
List Price	Our Price
\$25.00	\$18.75

TUBES	
U V 200 Radiotron.....	\$3.95
U V 201A Radiotron.....	5.75
U V 199 Radiotron.....	5.75
WD 11 Radiotron.....	5.75
WD 12 Radiotron.....	5.75

AUDIO TRANSFORMERS	
List Price	Our Price
\$4.50 All American..... 3 to 1 Ratio	\$3.95
4.75 All American..... 5 to 1 Ratio	4.10
4.75 All American..... 10 to 1 Ratio	4.10
4.25 Jefferson..... 4 to 1 Ratio	3.75
7.00 Jefferson..... 10 to 1 Ratio	5.55
List Price	Our Price
\$4.50 Thordarson..... 6 to 1 Ratio	\$3.95
4.00 Thordarson..... 3½ to 1 Ratio	3.60
4.50 Kellogg (501)..... 4½ to 1 Ratio	3.95
4.50 Kellogg (502)..... 3½ to 1 Ratio	3.95
5.00 Gen'l Radio..... 3 to 1 Ratio	4.25
7.00 Amertran.....	5.55

All Mail Orders Shipped Promptly. Send Money Order, including Postage.  
WRITE FOR OUR CATALOGUE  
**HANES-ZENER CO.** The RADIO Mail Order House  
Known for Low Prices  
3 WEST 29th STREET, NEW YORK CITY



# Receiving Set Built in a Match Box

## Inexpensive Receiving Set with Special Coil

This receiver costs about twenty cents to build. It will operate very well as far as eight miles from a broadcasting station, due to the winding of the inductance. The best wire for this purpose is Number 36

### WORKSHOP KINKS? EARN A DOLLAR—

THERE are many little kinks worked out at home that would aid your fellow Radio worker if only he knew about them. There are new hook-ups, new ways of making parts and various unique ways of operating sets that are discovered every day. Radio Digest is very much interested in obtaining such material. Send them in with full details, including stamped envelope, so rejected copy may be returned. The work must be entirely original, not copied.

RADIO KINKS DEPARTMENT,  
Radio Digest,  
123 W. Madison St., Chicago

dec, but the wire on the secondary of a Ford coil may be used. Procure a heavy piece of cardboard, 1½ by ¾ inches, and make two pinholes ¼ inch apart at the ends. Weave one end of the wire through the holes at the end of the cardboard and wind from one side of the cardboard to the other. The sketch shows how to wind the wire by layers.

Five layers will be sufficient for an antenna with a fundamental wave length of about 150 meters. If you have a large antenna, take off one or two layers of winding. The detector may be obtained cheaply at a dealer's supply house. The base of the type shown will measure 1½ by 1¼ inches. This will just fit into the top of the match box cover; with a nut and bolt run through the base of the detector it may be fastened in place.

The completed coil is slightly moistened with glue and attached to the bottom, inside of the safety match box. Two binding posts are fastened through each end of the box, making four binding posts in all, two at each end. Wires are run from the inductance coil to the detector through holes on the edge of the box cover. No by-pass condenser was used; the usual length of telephone cord compensated.—F. E. Monsch, St. Louis, Mo.

## HEAR STATIONS EIGHT MILES

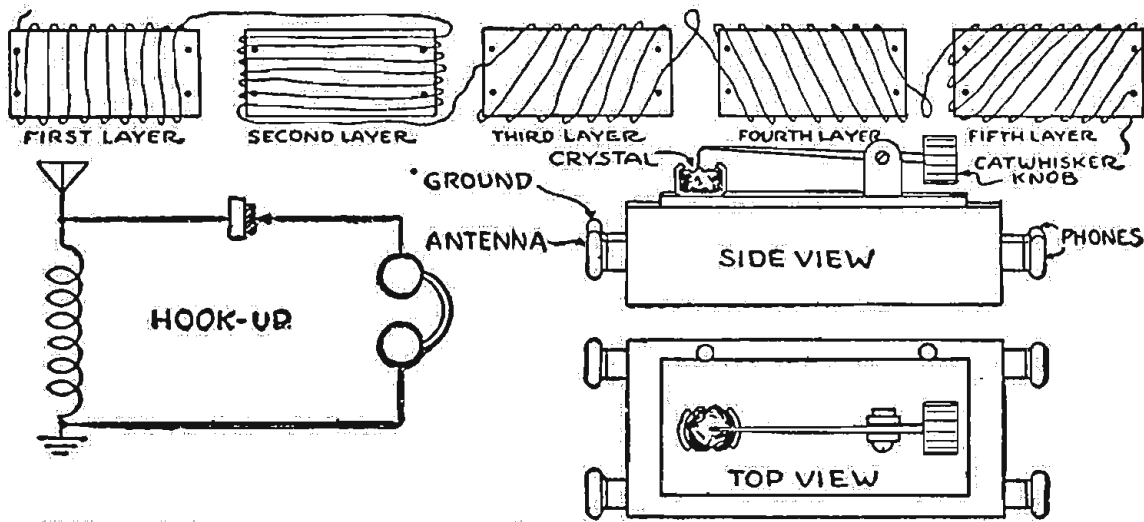

### Connecting Transformers

The secondary winding of the amplifying transformers used in receiving circuits employing audio-frequency amplification should be connected to the negative side of the filament battery to prevent the grids of the amplifying tubes from becoming positively charged. If the secondary of the transformer were connected to the positive terminal of the A battery the grid would assume positive charge; consequently there would be a flow of electrons from the filament to the grid. This action would in effect constitute a shunt path for the electronic flow, which would greatly interfere with amplification within the tube.

Placing the filament control rheostat in the negative filament lead and connecting the transformer secondary to the negative side of the A battery, the grid of the amplifier tube will be one volt negative with respect to the negative end of the filament. This is because of the fact that the A battery supplies 6 volts, allowing a potential drop of 5 volts across the tube and 1 volt drop in the filament rheostat itself.—Peter J. M. Clute, Schenectady, N. Y.

### Type of Grid Condenser

The correct capacity of the grid condenser for purposes of reception may be determined by experimenting with various values from .0002 to .0005 microfarads. Grid condensers in transmitting sets are usually of about the same capacity but are insulated to withstand much higher voltages.

### Steep Tube Curves

The steeper the characteristic curve of a receiving tube the greater will be the regenerative tendency. The best amplifier tubes have very steep portions on the curves.

## Two-Slide Tuner Used In a Single Tube Set

The circuit shown illustrates a new use for an old two-slide tuner. This circuit has been found to be very efficient for a small set. The signals received have a high degree of strength because of the

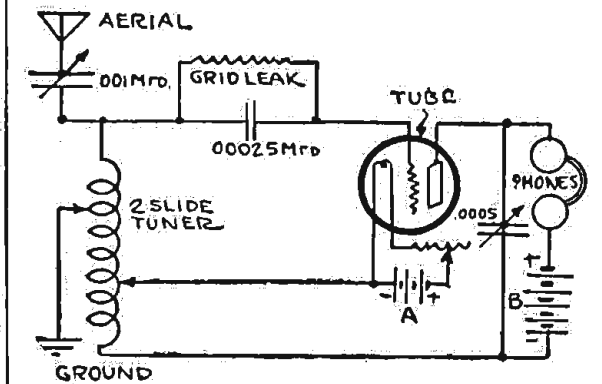

regenerative effect. Both ends of the coil must be used. Either the 1½ volt or the 6 volt tubes may be used.—Leo Schechter, St. Louis, Mo.

GENUINE EDISON ELEMENTS (new) for making "B" Batteries, obtained from U. S. Government. A positive and negative element—6c; glass tube—3c; all other parts at reasonable prices. Postage, etc., 50c extra per order. Free instructions. TODD ELECTRIC COMPANY, 109 West 23rd Street, New York.

## COME TO CANADA

For your Radio-frequency circuit. Our circuit developed for the Royal Air Force, gives amazing results on only two tubes. It is easy to build, and easy to operate. Regenerative sets can be converted to the wonder circuit in a few minutes. Here in the Canadian Northwest we hear Raleigh, N. C., Havana and Porto Rico. Atlanta heard on the loud speaker. Now look at the map and see where we are located. Circuit and full constructional details sent prepaid on receipt of a dollar bill. No further charges.

We want a number of radiophans with reliable sets to collect data on static and fading signals. Write today.  
INDEPENDENT RADIO ENGINEERS  
1732 14th Ave. W., CALGARY, CANADA

## RUSONITE

THE PERFECT SYNTHETIC CRYSTAL DETECTOR, SENSITIVE OVER ENTIRE SURFACE. No Hunting for "Spots." Loud and Clear. Endorsed by thousands of satisfied users. Sensitivity Guaranteed. 50c Price, Mounted.

14 K. GOLD SUPERSENSITIVE RUSONITE CATWHISKER. Permanent. Will Not Oxidize. Price, Mounted, 25c

RUSONITE REFLEX CRYSTAL. Manufactured Expressly for Reflex Circuits. Will Stand Up Under Heavy Plate Voltage. Guaranteed. Price, Mounted, \$1.00

Order from your dealer or direct from  
RUSONITE PRODUCTS CORP.  
15 Park Row New York, N. Y.

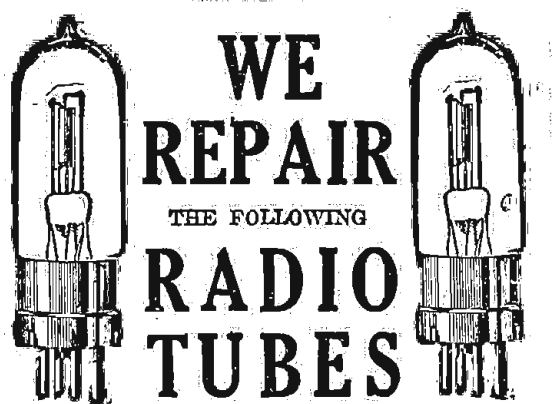

Dealers and Agents write for Special Discount Mail Orders Solicited and Promptly Attended to

WD-11	OUR SPECIALTIES	5 WATT	
WD-12		TRANSMITTERS	
UV-199	\$3.50	C-299	\$3.50
UV-200	2.50	C-300	2.50
UV-201	3.00	C-301	3.00
UV-201A	3.75	C-301A	3.75
WD-11	3.50	WD-12	3.50
DV-6	3.00	DV-6A	3.75
UV-202	4.00	C-302	4.00

H. & H. RADIO COMPANY  
P. O. Box 22-A  
Clinton Hill Station NEWARK, N. J.

## TRIGGER OF NEW YORK RADIO

EVERYTHING SOLD ON MONEY-BACK GUARANTEE. WE HANDLE NO BOOTLEG MERCHANDISE.

BRANDES	\$5.25	PANELS, Fine Grade	
ROYAL	3.50	7x10	\$0.85
COCKADAY		7x14	\$1.25
Best parts, complete, GUARANTEED	\$12.50	7x18	1.45
ERLA REFLEX		7x24	1.90
One Tube Sets will operate loud speaker; guaranteed. Complete parts.	\$22.50	ATLAS	\$16.50
WONDERFUL 1 tube set, guaranteed, all assembled	\$15.00	Loud Speaker, List \$25	
ERLA Radio Transformers	\$4.50	Our 2-tube assembled set works loud speaker	\$25.00
ACME	3.45	We save you money on anything you buy.	
KLOSNER 6 & 30 Ohm Rheostat	1.25		
TILLMAN 6 & 30 Ohm Rheostat	.65		
TILLMAN Socket	.50		
REMLER Socket	.60		
W. D. 11 & U. V. 199 Socket	.50		
23 plate Condenser	1.65		
43 plate Condenser	\$1.85		
23 plate Vernier	2.85		
43 plate Vernier	3.75		
D. C. Battery Charger	4.25		
ACME Transformer	3.75		
AMBASSADOR 3000 Ohm Phones	3.98		
CRYSTAL Detectors	.45c, 60c, 90c and 1.50		
FRESHMAN Var. Grid Leak & Condenser	.70		

We carry a complete line. Let us know your wants. Merchandise is shipped IMMEDIATELY. Postage prepaid on orders of \$5.00. All others please include postage.

## TRIGGER OF NEW YORK

160 East 59th Street, Near Third Avenue, New York City

## At Last The Genuine Reinartz

Covers all broadcasting wave lengths now used  
Each coil bears a facsimile of John L. Reinartz's signature

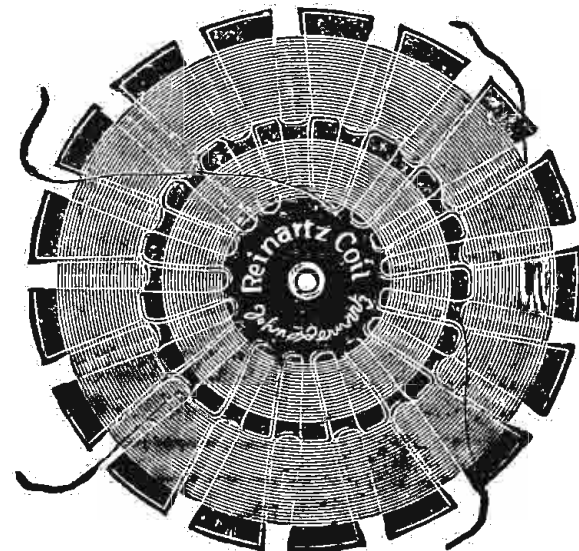

Made under John L. Reinartz's specifications by the Eugene T. Turney Laboratories, Inc., exclusively

Primary Coil ..... 57 turns 8 taps  
Secondary Coil ..... 45 turns 2 taps  
Diameter 5½ inches. Bakelite cores

Packed in individual boxes. With new copyrighted Reinartz hookup. List, \$2.50. Standard packages, 3 doz.

Jobbers and Dealers write for discounts

## Tristan Sales Corporation, Dept. C.

1 UNION SQUARE

Sole National Distributors

NEW YORK

Baker-Smith & Co.,  
741 Cali Building,  
San Francisco, Calif.  
Walter I. Ferguson & Co.,  
208 Baltimore Bldg.,  
Kansas City, Mo.

Amalgamated Lamp Co.,  
220 West 6th St.,  
Cleveland, Ohio.  
J. H. Lyte  
65 North 63d St.,  
Philadelphia, Pa.

O. P. Smith Co.,  
205 W. Harrison St.,  
Chicago, Ill.  
C. L. S. Holmes Co.,  
601 Boston Block,  
Minneapolis, Minn.

# Questions and Answers

### Single Circuit Hook-Up

(4794) CBK, Rock Island, Ill.  
Will you please give the hook-up diagram for a single circuit set having one stage of audio frequency amplification and that will operate satisfactorily with WD-17 tubes?

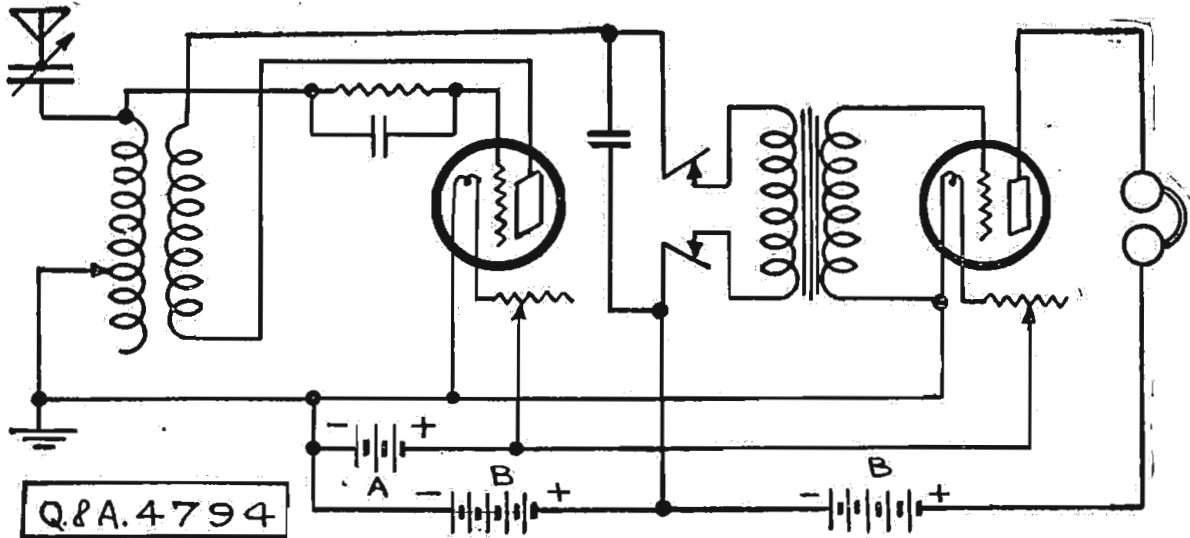

A.—The diagram requested is shown on this page. This circuit will work quite well.

### Two Aerials

(4567) LLJ, Le Mars, Ia.  
I would like to ask a question—One of my neighbors wants to attach his aerial to my aerial pole. If this is done the two aerials would be about 25 feet apart at the nearest point and would lead away from each other in the shape of a V, being about 70 feet apart at the widest point. I would like to ask if these two aerials fastened on the same pole would interfere with each other. If so, what effect would it have on the efficiency of our sets? We use the audio frequency system. Would a transformer of a ratio of 6 to 1 work all right in the first stage of an audio frequency set? If so, would it require any more B battery than a 3 1/2 to 1 transformer?

A.—The connection of two antenna systems in the manner suggested will be practicable if you are not using regenerative circuits, in which case they should be separated as far as possible and at

right angles to each other. Otherwise you will experience decided interference. The system described could be used only with non-regenerative or Radio frequency circuits.

Six to one transformers will require no more B battery than a lower ratio, ratio

having no relation primarily to B battery voltage.

### Loop Aerial, Honeycomb Coils, Etc.

(4642) E. C. Wichita Falls, Texas.  
With reference to the Flewelling circuit on page 6, Flewelling answer department, I ask the following questions: Is this variation of the original Flewelling circuit as good as the original?

Could a loop antenna be used with success?

### YOU DON'T NEED

**Tubes** to get out of town. If you want new stations on your crystal set WRITE ME TODAY. Mine works 400 to 1,000 miles without tubes or batteries! Thousands have bought my plans and now get results like mine. Changes often cost less than a dollar. Send self-addressed envelope for further information.  
Leon Lambert, 501 South Volusia, Wichita, Kan.

### Another Columbia Scoop

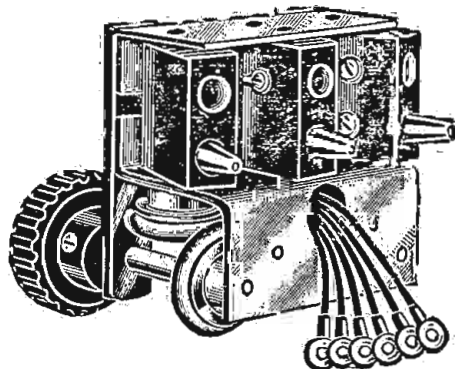

A Geared Coil Mounting for Inside Panel Mounting, made of moulded Bakelite and mirror nicked brass—for those who prefer their bulky coils on the inside of the cabinet hidden from view.

Ask your dealer for it. All good dealers stock it.

Price \$7.00

COLUMBIA RADIO CORP.  
157 NO. UNION ST. CHICAGO

What size honeycomb coil should be used to cover the new wave lengths?

What size condenser (variable) should be used?

What size fixed condenser should be used?

I intend using a C-299 tube; how much plate voltage should be used?

Can a Flewelling set of this type be successfully loaded for high wave lengths? How?

A.—There is no fundamental difference from the original; the results will be equal.

A loop aerial can be used with this circuit but a short wire connected as antenna and ground will be found far more effective.

The present wave lengths will be covered with 75 and 100 turn honeycomb coils.

A 23-plate vernier condenser is desirable. The fixed condenser employed is of .006 mfd.

Fifty volts plate potential will be correct with a C-299 tube. Do not attempt to use less than 45 volts, otherwise the circuit will not function as a super. A 6-volt tube is recommended as much better than a C-299 tube.

### Arlington Time Signals

(4611) DW, Wheeling, W. Va.  
Will you please tell me how to receive the correct time by the Arlington Time signals?

I know many Radiophans would like to have the same question answered.

A.—The second dots begin at 2 seconds before the hour and continue until the 58th second. The 59th second is omitted; the 60th is made 2 seconds long; the beginning of the dash is the exact hour.

### SOMETHING NEW—Necessary for Your Set

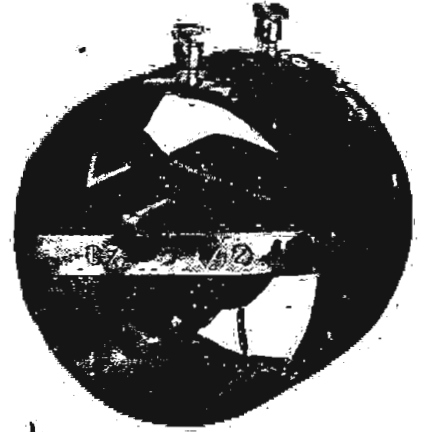

### Horne VERNI-TUNER

(Trade Mark)

Primary, Secondary and Condenser—All within a short 4" tube.

### A Great Space-Saver

Sharper tuning than possible with any other coupling and at one-half the cost. \$4  
Used for the following circuits: Regenerative, all types; Tuned Radio-Frequency; Reflex—Reinartz—Ultra Audion.

At your dealer or postpaid on receipt of purchase price. Also write for free booklet showing all circuits.

HORNE ELECTRIC & MFG. CO.  
Mercer & Colgate Sts., Jersey City, N. J.

### —Of special interest to Radio Dealers!

One of Chicago's oldest and largest exclusive radio stores sold more Mu-Rad Receiving Sets in 1922-23 than all other types of Receivers combined!

### Mu-Rad sells—and sells!

That fact has been repeatedly verified by our many other Mu-Rad dealers in the middle-west. Why not join them? Why not enjoy as they do the ASSURED PROFITS of good radio merchandise well advertised?

### Write for a Mu-Rad Franchise

To get complete details of our special Mu-Rad proposition will not obligate you. Write also for a copy of our handbook catalog of other profitable Radio merchandise. Write today before someone else in your neighborhood gets exclusive Mu-Rad privileges.

### Chicago Radio Apparatus-Company

Jobbers of Good Radio Merchandise  
General Offices: 407 South Dearborn  
CHICAGO

**\$3** Brings you a Genuine **UNDERWOOD** TYPEWRITER

**10 DAYS FREE TRIAL** Your \$3.00 unconditionally returned if at end of 10 days you are not satisfied with this late model UNDERWOOD typewriter rebuilt by the famous Shipman Ward process.

**GREAT PRICE SAVING** Direct to you from the largest typewriter factory in the world by our money saving methods.

**EASY MONTHLY PAYMENTS** So small that you will not notice it while you enjoy the use of this wonderful machine.

**FREE BOOK OF FACTS** Explaining Shipman Ward's wonderful system of rebuilding typewriters and also valuable information about the typewriter industry both instructive and entertaining.

Act Today! Mail Coupon **5 Year Guarantee**

Shipman Ward Mfg. Company  
2686 Shipman Building  
Montrose & Ravenswood Aves., Chicago

Please send me a copy of your free book of facts, explaining bargain offer.

Name.....  
St. and No.....  
City..... State.....

## RADIO AMSCO FANS!

Your Reliable Road from  
**COAST to COAST in SUMMER**  
**CONTINENT to CONTINENT in WINTER**

is via

### THE ACMEDYNE CIRCUIT as employed in the **MELCO SUPREME** Tuned Radio Frequency Receiver

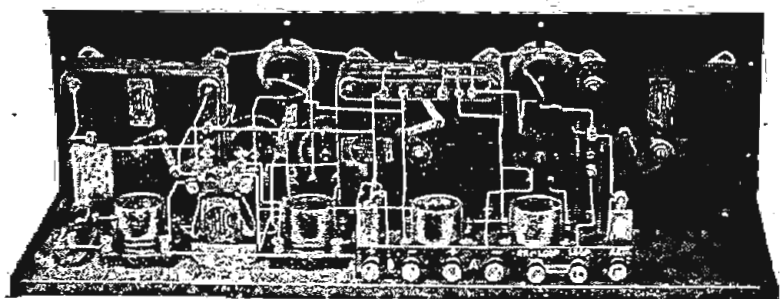

This set operates with and without Loop, Aerial and Ground

### ESSENTIALS

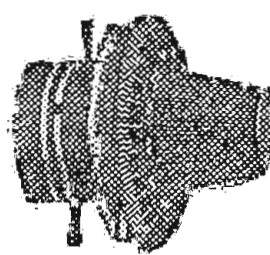

AmSCO Compensating Condenser

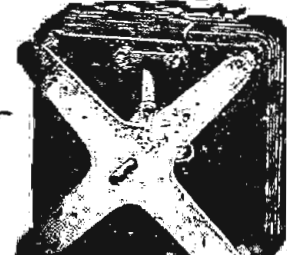

Telos Variometer and Variotransformer

**BUILD ONE YOURSELF**  
All parts complete with Cabinet, Drilled and Engraved Panel Ready for Assembly **\$60.00**

**AMSCO PRODUCTS, Inc.**  
Broome and Lafayette Streets NEW YORK, N. Y.

**World Storage Batteries Save You 50% And You Get a Written 2-Yr. Guarantee**

We maintain the same high quality material and workmanship found on the most expensive batteries and still are able to allow our remarkably low sale price by greatly reducing our overhead and sale costs.

Special 2 Volt Storage Battery for WD-11 and WD-12 Tubes.....	\$5.00	6 Volt 60 Amp.....	\$ 8.50	6 Volt 100 Amp.....	\$12.50
Special 4 Volt Storage Battery for UV-199 Tubes.....	\$8.00	6 Volt 80 Amp.....	10.00	6 Volt 120 Amp.....	14.50
200 Hours' service on one charge. Rechargeable.		6 Volt 140 Amp.....	16.50		

SEND NO MONEY. We ship C. O. D., subject to inspection, or will allow 5% discount for cash with order. Shipment made same day order is received. Save 50% on your next battery and get better service and longer life. Our written guarantee is your proof of satisfaction. The Big Fall Radio Season is on now. To get the full benefit of it order your new WORLD battery today!

**WORLD BATTERY CO.**  
60 EAST ROOSEVELT ROAD, CHICAGO, ILLINOIS

Radiophone Broadcasting Stations

Corrected Every Week—Part II

(NOTE)—The second part of the schedule list appears below. The first appeared last week and the third part will appear next week.

KUD, San Francisco, Calif. 360 meters. 1,500 m. San Francisco Examiner. Slogan, "The Voice of the West." Daily ex Sun, 9-10 am, chat to housewives; 11-12, reports; 12:30-1:30 pm, lecture, news; 9 am, 12 m, 6:45 pm, weather reports. Sun, 9-10 am, 5-8 pm, news, Pacific.

WBW, Chicago, Ill. 286 meters. 100 m. City of Chicago. Daily ex Sun, 10:15-10:30 am, 11:45-12 m, 4:15-4:30 pm, police reports. Mon, Wed, Fri, 3:30 pm, 7:30, speeches. Central Daylight Saving.

WEAD, Atwood, Kan. 208 meters. Henry Radio & Elec. Supply Co. Temporarily discontinued.

WHAB, Galveston, Tex. 360 meters. 500 m. Clark W. Thompson Co. Slogan, "The Gateway to the Southwest and Treasure Island of America." Daily ex Sun, 9:45 am, 11:30 am, 5, reports, music, news.

(The third part of the station schedules will appear next week.)

# Radio

## Illustrated



Broadcasting of drama has become quite popular. Here is Howard Lang in the part of "Emmett Sheridan," in "Thumbs Down," thriller-drama recently broadcast via Station WOR, L. Bamberger & Co., Newark, N. J. This eastern station has found Radio matinees of Broadway hits not only entertaining to the afternoon listeners in, but profitable for the theater box offices

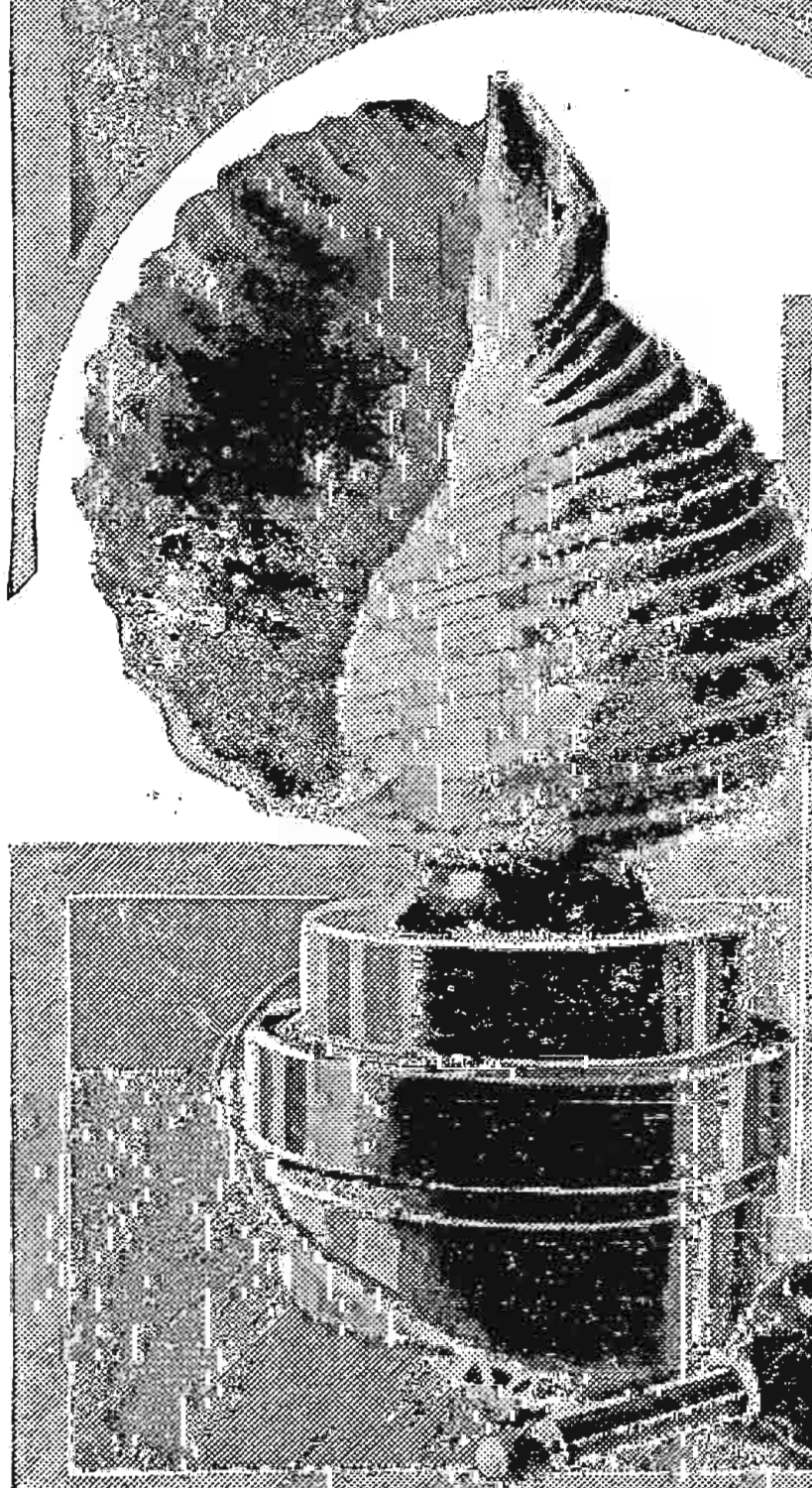

A seashore-Radio enthusiast is responsible for the sea shell loud speaker pictured at left. The curling spiral chambers of the shell make it ideal for a compact horn, and its tonal qualities are said to be very good. Arapahoe Indians (above), from the Wind River Reservation, Wyoming, enjoy their first Radio concert camping in their tepees in the heart of New York City while en route to England

Left © Atlantic

Above © K. & H.