

© C. B. 11033

51 Stations' Advance Programs; Operating and Trouble Finding Data; Amplifying the Crystal Without a Tube; 4-Tube Reflex Neutrodyne Set

Radio Digest

EVERY WEEK

PROGRAMS Illustrated

TEN CENTS

REG. U. S. PAT. OFF. & DOM. OF CANADA

Vol. VIII

Copyright 1924
By Radio Digest Publishing Co.

SATURDAY, MARCH 8, 1924

No. 9

NEW CIRCUIT INVENTED

WBZ MUSIC TEACHER FIRST TO ASK FEE

WESTINGHOUSE SEES FANS PAY FOR TUITION

Plant in Springfield, Mass., Plans Eight Lessons by Expert Who will Examine Students

SPRINGFIELD, MASS.—Perhaps the first attempt in the United States, perhaps in the world, to collect fees for instruction received by Radio will be that of Station WBZ, Westinghouse, here, in co-operation with Elisha S. Olmsted, professor of music in Smith college, Northampton, Mass.

The course, which is to consist of tuition in all phases of music, its history, expression, effects, its presentation by voice and instrument and as interpreted by the dance, is to begin on March 6 at 7 o'clock p. m. Eastern time. There will be eight lessons on Thursday of as many weeks.

Those of the listeners in who pay \$1 fee for instruction will be entitled to examination by mail by Professor Smith or his associates. Only those who pay the fee will receive printed information as to how to proceed in their study. The first lessons in the course will deal with the expression of self by means of music.



ONE CONTROL, SIX STEP R.F. SET DIVULGED

"Super-Pliodyne" Name of Revolutionary Receiver Developed by C. L. Farrand

Gives Values for Making

Three Million Times Amplification Claimed by Inventor Before Radio Club of America

NEW YORK.—A bomb was exploded in technical Radio circles recently when the construction and operation of the much-heralded but mysterious "super-pliodyne" receiver was disclosed by C. L. Farrand, consulting engineer of this city. Mr. Farrand, in addressing a meeting of the Radio Club of America, displayed a receiver over a yard long that was revolutionary in both circuit and construction.

Whether the new hook-up is any decided improvement over previous sets now on the market remains to be seen, but such points as eight condensers on a single shaft and six stages of Radio frequency transformers on two-inch tubes, are distinctly novel.

Why Six Stages Are Possible

It has been recognized for many months that if each stage of Radio frequency amplification could be tuned to the incoming

(Continued on page 7)

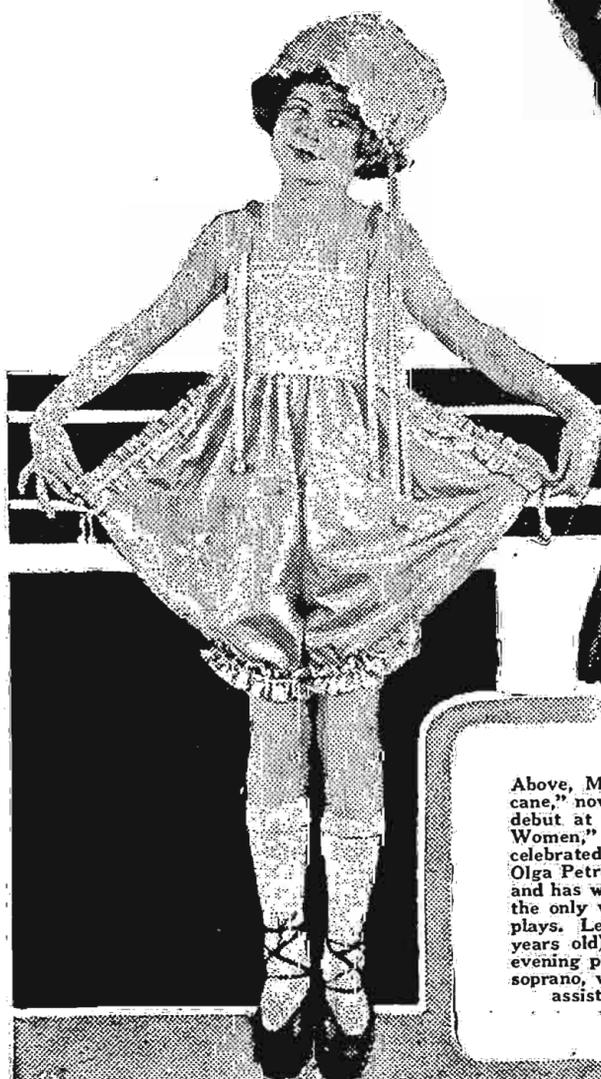

Above, Mme. Olga Petrova, here portrayed as the star of "Hurricane," now playing at the Frolic theater, New York, made her Radio debut at WOR recently in the series "Half Hours with Successful Women," which has proven so popular. A talk and songs by the celebrated actress constituted her contribution to the Radio program. Olga Petrova is not only a brilliant actress; she is also a playwright, and has won fame as a musician, singer and composer as well. She is the only woman on our stage who writes, directs, and acts her own plays. Left, Alice Glasser, a youthful prima donna (she's only ten years old) who performed with much success at WHN's Saturday evening program not long ago. Right, Lela Gordon Soling, dramatic soprano, who opened Station KPO, San Francisco, last year, and also assisted at the anniversary celebration, January 16, this year.

RADIO FACES CRISIS WHEN LONG EXPECTED PROGRAM WAR BREAKS IN NEW YORK

A. T. & T. Company Accused of Forcing Question "Who Will Pay for Broadcasts?" by Queer Practices and Ether Monopoly Attempt

NEW YORK.—Radio rapidly approaches its most serious crisis. Mr. Radiophan sits comfortably at home listening to the ever-changing, always-interesting programs unaware that beneath the calm, serene outward appearance, the Radio program competition seethes and boils and threatens to explode at any moment.

The question of "Who will pay for broadcasting?" has been one that all connected with the presentation of programs have dodged for a year. That is the climax which has now arrived. It had been hoped that the crisis was many months away—that it was something to be worried over next season—any time in the dim, distant future.

Like a bombshell the formation of the Radio Music Fund destroyed the pleasant suspension in which all were floating. Right down to hard earth and brass tacks are the managers and backers of five hundred broadcasting plants. Who will survive, who will become past history, future developments will show. That there will be broadcasting is a certainty; the public need have no fears on that point. Who will be doing it, is the question to be settled.

Music Fund Only a Temporary Solution
The formation of the Radio Music Fund Committee is only a temporary solution of the problem of getting concert and opera stars before the microphone, but the storm it has created is terrific. Charges and countercharges fly back and forth.

"We are broadcasting the programs of the Radio Music Fund for nothing; we do it for the good of Radio," says WEAF, the company.
The smaller stations, "Who the American Telephone & Telegraph company doing anything for us?"

stars get paid, our theatrical and vaudeville headliners get paid," roars the Producing Managers' Association.
"Playwrights and authors must get a fee if their work is put on the air," says the American Dramatists' Society.
And so it goes.

Station WEAF States Its Position
Interviewed in regard to the center of all this storm, the Radio Music Fund, William E. Harkness, vice-president of the A. T. & T. Co., had this to say:
"We are in the broadcasting field because the study of voice communication is within our work. Our scores of laboratories and hundreds of engineers do nothing but study the transmission of the human voice. We would be ashamed of ourselves if we could not perfect apparatus that would do this work more perfectly.

"Station WEAF is the result of that study and experimental work. If the Radio Music Fund committee believes its modulation and transmission of music to be more perfect than those of other stations and selects WEAF as the outlet for its programs, we are glad to get this famous musical talent. The committee sought us; the idea originated some time ago with them."

"Cleverly Devised Scheme," Others Say
Such is the stated attitude of WEAF and those who operate it. The other side of the discussion, the attitude of scores of other stations and thousands of listeners is quite well expressed in the following statement made by George Schubel, secretary of the Radio Broadcasting Society of America, speaking for its members:
"E. H. Felix, of the American Telephone and Telegraph company, has issued a denial of the statement that the American Telephone and Telegraph company will charge the Radio Music Fund for broadcasting its programs. He says that the telephone company will not use the funds collected for broadcasting expense, but for hiring high-priced artists.

"On the face of it, this seems quite generous, but whoever heard of the American Telephone and Telegraph company doing anything for charity? The telephone company is collecting even from the Y. M. C. A. at present \$400 an hour, and \$100 for ten minutes broadcasting, but in order to make the public stand for this commercialization, the company must, of course, sandwich its paid stuff in between programs that have the appearance of being offered to the public by philanthropic persons.

"When the Christian Endeavor Society sought the use of the American Telephone and Telegraph company's broadcasting facilities recently, it was told that the charge was \$100 for ten minutes."
The keynote of the opposition, the actual

putting into words of the suspicion in the minds of thousands, is Mr. Schubel's next statement:

"The Radio Music Fund is a cleverly devised scheme—a stroke of business genius in fact—which enables the telephone company to get high-priced artists to embellish and surround its advertising matter at the expense of good souls with money to give away.

"A magazine or newspaper must pay good money to get news articles, editorials and features to put across the medium which carries the advertising. The telephone company has devised a scheme called the Radio Music Fund, which makes the philanthropically inclined pay the money to supply the features which help to put across their paid broadcasting."

Who Invited Who?
One thought that has been expressed is that WEAF may have put the thought into the Music Fund committee's mind and that

WHY?

WASHINGTON, D. C.—The American Telephone and Telegraph company and the Western Electric company (subsidiary of the A. T. & T. Co.), have requested the Federal Trade Commission to allow them thirty days extension in which to answer the complaint against the Radio Corporation of America and other respondents. The complaint was to have been answered February 27.

while, to all appearances, the moving spirit is the committee, the American Telephone and Telegraph company may be the guiding brains beneath. Such things are done every day.

A dinner engagement, a talk over cigars afterwards, a subsequent telephone conversation or two on details, and then a statement is made to the press that So-and-So has been invited to participate in a new project by a disinterested, philanthropically inclined group. The invited party sees the opportunity to advance its interests by the project, but it would sound much better to be invited.

How WEAF Gets Money for Programs
For those unfamiliar with the situation, some details on the operation of Station WEAF may make the attitude of all parties clear. This station is the only one which has a fixed charge for those who wish to use it, because the A. T. & T. company controls, through patents and manufacture, certain vital Radio parts and can dictate to other stations whether they may enter "the commercial field."

Concerns wishing to use Station WEAF to get on the air are charged rates of \$100 for ten minutes or \$400 an hour. Over

CONTENTS

Radio Digest, Illustrated, Volume VIII, Number 9, published Chicago, Illinois, March 8, 1924. Published weekly by Radio Digest Publishing Company, 123 West Madison Street, Chicago, Illinois. Subscription rates, yearly, Five Dollars; Foreign Postage One Dollar additional; single copies Ten Cents. Entered as second-class matter at the postoffice at Chicago, Illinois, under the Act of March 3, 1879.

"All the Live News of Radio".....1 to 8
Operating and Trouble Shooting for Owners of Standard Receivers.....9, 10
Simple Explanation of Radio for Everybody, Chapter XII, Part II—Radio Frequency Amplification, by M. W. Thompson.....11
An Evening at Home with the Listener In.....14
Advance Programs for the Current Week.....15 to 18
Meditations by the Inventor of King Miloplex, Part XXII, by the Mystery Man.....19
Editorials; Indi-Gest; Condensed, by Dielectric.....20
First Aid and Helpful Hints for Listeners In, Chapter II—Peculiarities of Regenerative Receivers, by Peter J. M. Clute.....21
Improvements in the R.D.-102 Single Tube Reflex, by J. P. Flaherty.....23
Construction of a Four Tube Reflex Neutrodyne, Part III—Assembly and Wiring, by H. J. Marx.....25
Amplifying Crystal Set without Tube.....27
Good Results with an Old Circuit, R.D.-115.....28
Antenna Arrangement in Place of Wave Trap.....29
Questions and Answers.....30
Radiophone Broadcasting Station Directory, Part I.....31
Radio Illustrated, a Page of Pictures.....32

Looking Ahead

Lee DeForest, Inventor of the Three Element Vacuum Tube—is the headline attraction in next week's Digest. The man who invented the tube you can hardly do without, will discuss the advantages Radio presents to the American public with regard to musical education.

More About Wave Traps, by the Mystery Man—next week, with more of his interesting comments so well punctuated with valuable information. Then, too, there's to be an article describing a wave trap built and operated with much success by a New England reader. Cut out that interference!

Super-Heterodyne Variations will be considered by H. J. Marx in his next weekly contribution. Builders of the Rolls-Royce Radio receiver will be interested in this dissertation.

Operating and Construction Suggestions will be given by Peter J. M. Clute next issue as the third instalment of his series, "First Aid and Helpful Hints to Listeners In." Great reading for the dial twister, isn't it? Then, too, the regular feature, "Operating and Trouble Shooting," next week will be devoted to another standard receiver of well-known manufacture.

Answers to Questions on the Green Circuit, by Myron Green, will help many builders of this famous set. Coming next issue. Details of the variocoupler will be given.

M. W. Thompson Knows Radio Frequency Amplification—but best of all, he knows how to tell other people about it. Read the conclusion of his discussion on this subject next week.

But Before You Turn on, see page 5 for the notice of a new beginner's series of articles by P. E. Edelman. They begin March 22.

Newsstands Don't Always Have One Left WHEN YOU WANT

Radio Digest

YOU WANT IT! BE SURE OF YOUR WEEKLY COPY BY SUBSCRIBING NOW

SEND IN THE BLANK TODAY
Publisher Radio Digest, 123 West Madison St., Chicago, Illinois.
Please find enclosed check M. O. for Five Dollars (Six, Foreign) for One Year's Subscription to Radio Digest, Illustrated.
Name
Address
City..... State.....

MUSIC FUND SEEKS MONEY FOR WHAT?

BELIEVE PLAN SCHEME TO FEED WEAFF COFFERS

Public Asked by Self-Appointed Committee to Donate to Only Station Having Revenue Already

NEW YORK.—An organization known as the Radio Music Fund committee is announced by four men known for their activities in support of good music—Clarence H. Mackay, Felix M. Warburg, Frederic A. Juilliard and A. D. Wilt, Jr. The committee believes that "broadcasting offers a wide and hitherto undeveloped field for stimulating the increasing public interest in good music," and it hopes through the Radio Music Fund to bring to thousands of people who for any reason are unable to attend concerts and the opera, the opportunity of hearing the world's best musical talent.

"Prominent broadcasting stations," says the committee's statement, "have received hundreds of letters from the Radio audience not only expressing appreciation of programs but offering to contribute financially toward the immense cost of maintaining programs. The Radio Music Fund committee offers the organization through which the Radio audience can contribute to the financial support of Radio music programs.

But Statement Doesn't Tell Everything
So reads the published statement of the committee, but one cannot help but wonder why Station WEAF is designated as the exclusive outlet for the programs provided by this fund. There are other high-class, high-power stations in the metropolitan area being run at tremendous expense to provide those listeners making the contributions with consistently good entertainment. Why are WJZ, WJY and WOR omitted as stations from which the promised stars of the opera and concert stage will broadcast?

Another interesting point lies in the question, "How are fees to be collected?" If a single company did all the transmitting and that or any other one company manufactured all the apparatus, there would be no problem. But, as things are, it is difficult to see how listeners are going to be made to pay. That they should pay something for what they want and get, seems only right, but unless all pay, and pay equally, any payment is unfair, or merely a type of charity.

250 firms and individuals have thus used that station during the past year, among them being the American Tobacco Company presenting the Lucky Strike Orchestra, Gimbel Brothers putting on Vincent Lopez, United Cigar Stores with its sports talks by Thornton Fisher, United Candy Stores amusing with Billy Jones and Ernest Hare, and the Bank of America and other financial institutions.

WEAF Claims No Profit Made
"We are not trying to put WEAF on a profit making basis immediately," says Mr. Harkness. "We are merely experimenting to determine some of the controlling factors in broadcasting.

"We are not expecting or attempting to make a large profit. But certainly it is our aim to develop broadcasting to the point where it will be established on a revenue-paying basis."

In that last line, it is asserted by many, is the sole motive of the American Telephone and Telegraph company, and, it is alleged, the A. T. & T. company wants to have a monopoly and do any and all the broadcasting that is done.

Program Competition Splits Big Companies
The sore point of program competition has even made a break in the hitherto concerted, united action of the several companies named recently by the Federal Trade Commission as having "combined and conspired for the purpose of creating a monopoly." Will the A. T. & T. company lease its lines to its fellow respondents that they may put on the air events which occur at distant points? It will not!

Do WJZ and WGY, operated by the Radio Corporation of America and the General Electric Company, respectively, get ready use of the miles of wire available to WEAF? Not at all! WJZ and WGY had to negotiate with and secure "pick-up" lines from the Western Union.

Why They All Want to Broadcast
To the Radiophan all this competition for programs and the right to broadcast may appear something of a puzzle.

"Why," he will ask, "do all these concerns fight for the privilege of spending \$20,000 to \$100,000 a year to give us entertainment?"

Why? Because the ultimate gain to the victors will be tremendous. The operation of a "toll" station such as WEAF may well be compared to the publishing of a magazine. Millions will listen to hear and enjoy the "editorial matter" consisting of concerts and comedians, but think of the revenue to be derived from advertisers wishing to reach the "circulation" of five to ten million persons. If advertisers will pay over \$7,000 a page to catch the passing glance of 2,500,000 people, they will pay far more than that to be placed for ten minutes in 5,000,000 homes.

THIRD OF A BILLION RADIO COST IN 1924

BABSON PREDICTS LARGE SALES FOR INDUSTRY

**Broadcast Field, While New, Gives Es-
tablished Industries Race for
Crown—Where Money Goes**

CHICAGO.—More than a third of a billion dollars will be expended by the people of the United States for Radio goods during 1924, according to a statement made by Roger W. Babson, famous economist and business authority, after a careful investigation of the "infant" industry. In his report Mr. Babson says:

"It has been my experience that very few people realize just how important, from a business standpoint, the Radio industry has become. Just because an industry is comparatively new is not a reason for assuming that it is unimportant. The Radio industry is new, but it has grown so rapidly in the past two or three years that it compares very favorably with many of the important long-established industries.

Will Spend \$350,000,000 for Radio in 1924

"On the basis of figures for the year nineteen twenty-three it is probable that the American people will spend approximately three hundred and fifty million dollars for Radio equipment during the present year.

A conservative estimate of the business in vacuum tubes alone is about fifty million dollars. At last five times as much, or two hundred and fifty million dollars, will be spent for Radio sets and parts. The sales of batteries, both dry cell and storage batteries, will very likely amount to over forty-five million dollars. Miscellaneous equipment such as battery chargers, loud speakers and specialties may account for fifty million dollars more."

Compares Radio to Other Industries

"It is interesting to see how the Radio industry compares in dollars and cents with other large industries. Available figures on sporting goods, cameras, etc., show a value of about one hundred and eighty-five millions annually. Sales of Radio equipment are running nearly twice as large as all kinds of sporting goods.

"The value of Radio business is nearly twice as great as that of the carpet and rug business. For every dollar spent on furniture thirty-three cents is spent on Radio. For every dollar spent for boots and shoes twenty-five cents is spent for Radio. For every dollar spent for musical instruments of all kinds, including phonographs, pianos, organs, etc., seventy-five cents is spent for Radio. The value of Radio business amounts to nearly three-fourths of the jewelry business as a whole, including clocks, watches and novelties.

"Radio Past Fad Stage"

"I have given you these illustrations in order that I might emphasize the growing importance of Radio from a business standpoint. It is not necessary for me to tell you of Radio's importance from an educational and social standpoint. I see no reason why the Radio industry should not continue to expand. There has been a decided improvement in the character of the broadcast programs, and we may doubtless look forward to still greater improvement in this direction.

"To sum the matter up, Radio has passed through the fad stage and has become a utility. It has rightly achieved its proper permanent status among the important industries of the country."

FAMOUS ORGANIST OF PARIS PLAYS AT WJZ

Marcel Dupré Called "Paganini of the Organ"

NEW YORK.—The recital by Marcel Dupré, the young French organist who has recently completed the largest tour ever booked for an organist in America, was recently broadcast by Station WJZ here

ORDERS ONE ICEBERG AND GETS PART OF IT

CINCINNATI.—Powell Crosley, jr., recently asked, from Station WJAZ, Chicago, Donald MacMillan, explorer, whose ship is a few degrees from the North Pole, for one iceberg to be placed in the yard of Crosley's home here. A Radiogram from MacMillan that he had received the order and that the iceberg had been shipped, was received by the Chicago station.

"MIKE" JAZZES UP "U" MUSICAL CLUB

LANSING, MICH.—Prospect of working in a broadcasting studio as part of the Radio programs sent from Station WKAR, East Lansing, has livened interest and increased attendance at glee club, orchestra, band, and mandolin club rehearsals of the Michigan Agricultural college, it was reported here a few days ago, by the chairman of a program committee.

DISTANCE LENDS ENCHANTMENT



Miss Gertrude Lawrence, one of the trio of stars of Charlot's Revue, the London production now playing at the Times Square Theater, New York, singing at Station WJAZ. She is a favorite with the heir to England's throne and cabled the prince that she was to broadcast and received word from him that he would listen in in an effort to catch her voice on his side of the Atlantic. K. & H. Photo

direct from the Wanamaker Auditorium. Dupré is acclaimed by the critics, by the audiences, and by European and American musicians as "Paganini of the Organ."

Marcel Dupré startled the musical world in 1920 by the almost incredible feat, theretofore unaccomplished, of playing perfectly from memory the entire organ works of Bach, in a series of ten extraordinary recitals at the Paris Conservatory.

News Resume Weekly at WSAI

CINCINNATI.—A resumé of national and international news is now a weekly feature of Station WSAI here. Rutherford J. Cox, an attorney, prepares the data, so as to give events of world-wide interest in a concise and entertaining manner. The news feature is broadcast Saturday nights.

NAVY POLAR TEST DYING; ARMY READY

CONGRESS AND PRESIDENT KILL ZRI'S PLANS

**Flight to Top of World Too Risky and
Costly Declare Those in
Opposition**

WASHINGTON.—So far, there has been no official opposition to the proposed flight of United States army planes around the world, to begin on March 15 from Los Angeles. But the obstruction to the exploratory cruise of the navy dirigible Shenandoah to the pole recently caused orders to abandon the trip. The polar expedition is being blocked because of what is described as the risk to men and equipment, and the cost, \$350,000.

Army to Use Radio Part Way

The journey around the earth is to be lightened and expedited only in part by Radio. When the army fliers arrive at Hull, England, from the Orient, one of their planes is to be fitted with a transmitting and a receiving set for the flight across the Atlantic ocean to the United States. Thus the greater part of their journey will have been without Radio.

The combined weight of the Radio apparatus is to be about 100 pounds. The transmitter is to be of the 200-watt, non-synchronous, rotary spark type; its plane to ground range is to be 100 miles. A 600-meter wave will be used. There will be a super-heterodyne receiver but no Radio compass. Spare parts will be carried.

Radio Proved Life Saver

Despite the experience of army, navy and civilian pilots, despite the almost daily demonstration of Radio as a life saver and as a savior of ships and trains, the latter especially during the recent blizzard in the middle west, despite the fact that only by means of Radio was the Shenandoah recently guided to safety at Lakehurst, N. J., after having been torn from her moorings by a gale, certain members of Congress ridicule and by other means hinder the much-heralded dash to the pole.

BEDTIME STORIES NOT FOR PASTOR

**Reverend Asks Neighbor's Set Be
Ruled a Nuisance—Can't
Sleep Nights**

CHICAGO.—Is Radio a nuisance? Reverend T. Yeoman Williams, pastor of the South Congregational Church here, says it's fierce. So he filed a complaint recently with Health Commissioner H. M. Bundesen, asking that his neighbor's Radio be declared a nuisance and be restrained from nuisanceing.

Rev. Williams' next door neighbor has a Radio set with a good, strong loud speaker. His neighbor believes in using the loud speaker at all times—even at 2 and 4 o'clock in the morning. But the pastor wouldn't care if it were not for the fact that his neighbor runs his lead-in through quite a crack in the window sash, which allows plenty of music to escape and flow into the pastor's sleeping room, which is only twenty feet away.

The pastor couldn't sleep; he lost his health and he reported to the Health Department.

The reverend doesn't know how much sleep he would lose if he himself were a Radiophan—he says the bedtime stories have all ceased when he is forced to listen in, and nothing but drum-accented jazz is on the air.

Western Reserve President Will Broadcast Greetings

CLEVELAND.—Broadcast listeners claiming Western Reserve University as their alma mater will enjoy a program to be broadcast from WJAX on Thursday, March 13, at 8:00 p. m. Dr. Robert E. Vinson, President of the University, will greet the present and absent members of the Alumni Association.

THE ANTENNA BROTHERS

Spir L. and Lew P.

No. 1—Don't Try This Circuit

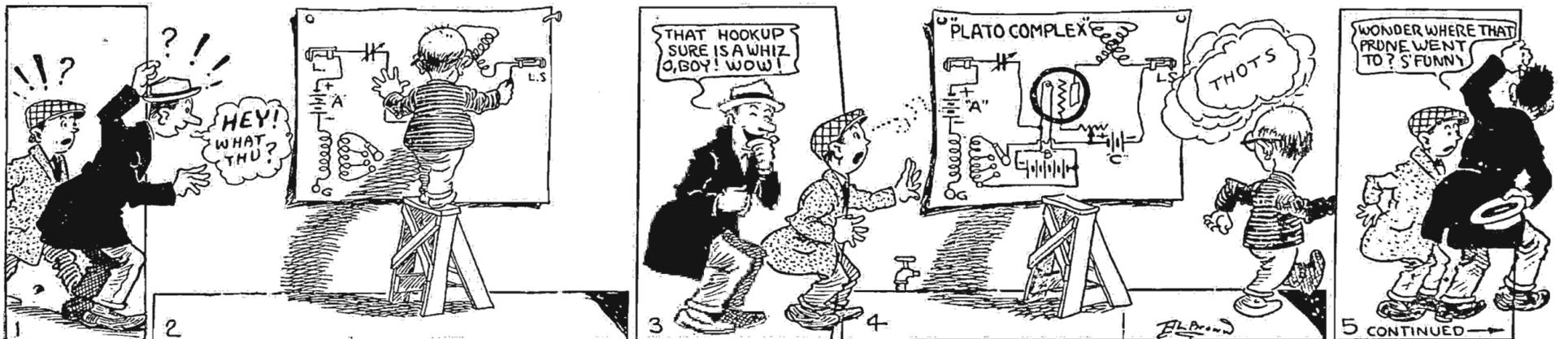

PWX WINS FORTUNE AND HUBBY FOR HER



Señorita Carmen Fernandez Ramos, Cuba's Beauty Queen, whose engagement has been announced as a climax to her series of unusual triumphs, all made possible by her telephone girl friends and broadcasts from Station PWX, Cuban Telephone company. (Story at right.) Photo by Blez

RADIO GIRL WINS AS CUBAN BEAUTY

GETS HER VOTES BY AIR-WAVE CAMPAIGN

More Than That, Senorita Carmen's Victory Gets Her a Husband and \$8,000

HAVANA.—The engagement of Señorita Carmen Fernandez Ramos, Cuba's Beauty Queen, has been announced, thus providing a climax to a series of unusual triumphs, and proving the value of feminine charms backed by Radio and friends.

Six months ago, this orphan girl was poor and obscure, her perfect Cuban type of beauty known only to her fellow-operators at the long distance switchboard of the Cuban Telephone Company in Havana. Today, because of that beauty and because of those fellow-operators, she is one of the most stylishly gowned women in the Cuban capital, she has \$8,000 in cash, is to marry Havana's exclusive photographer of the wealthy and the socially prominent, and her name and features are known in North America from Atlantic to Pacific.

Radio Conducts Campaign; Use PWX

When El Mundo, one of Havana's leading newspapers, offered a \$5,000 prize for the prettiest girl in the Republic, the telephone operators decided to back their charming comrade against the formidable field. And it was formidable, for Cuba

produces at least as many pretty girls to the acre as any country on earth.

The Cuban Telephone Company operates Station PWX, the source of entertainment of thousands of Radiophans in the island and many more in the United States and Canada. The operators decided to conduct their campaign by Radio.

Other candidates could not compete with the Radio Girl. Carmen was elected Beauty Queen of Havana by a large majority.

Enter the Photographer

But we are ahead of our story. As the selection of the prettiest girl of each province was made from photographs by a jury of Cuba's best known artists, Señorita Carmen's operator friends determined to take her to pose before the camera of the socially favored specialist in portraits, Joaquin Blez.

When Señor Blez stepped to the door of his reception room, and his eyes saw the exquisite features and form of the telephone girl, enhanced by the Parisian creation of Mme. Cumont, the disinterested professional glint faded forever from his eye, as far as that particular señorita was concerned.

There was something more than pride of his art that Señor Blez put into the photography of Carmen. His friends admitted that he had outdone himself. The jury of artists returned a quick and unanimous verdict. Señorita Fernandez Ramos was named the fairest exponent of feminine pulchritude in the province; subsequently she won the title of Beauty Queen of Cuba, and with it the \$5,000 prize.

Then the Havana City Council, out of tribute to the capital's fair daughter, voted \$3,000 to enable her to buy a home.

The Beauty Queen has posed for other

Special Concert Fills Sunday Gap at Atlanta

ATLANTA, GA.—To fill the gap in the ether between 11 o'clock and midnight Sundays, Lambdin Kay, director of Station WSB, the Atlanta Journal, recently added a musical program to the already very complete schedule of his station. The new program for "The Voice of the South" begins Sundays at 10:45 p. m., Central time, and supplies entertainment for fans who may be tuning in at this hitherto practically silent period.

Iowa "U" Introduces New Class B Station

IOWA CITY, IA.—WHAA, the University of Iowa's new, class B, 500-watt broadcasting station, got on the air for the first time recently, with a program of talks by members of the faculty interspersed with music by members of the school of music faculty and campus organizations. The station uses a wave length of 484 meters.

Cuban artists. Of course she has been approached by the movies. She has also been put forward as a candidate in the international beauty contest at Nice. Various other offers have been made to her. But she continues working for the Cuban Telephone Company, among the loyal girl friends who brought her victory.

And now comes the announcement of her engagement to Señor Blez. Naturally, she chose a party at the home of the chief telephone operator as the occasion for making the announcement.

Batum, Russia, Picks Up Minneapolis Regularly

"Mystery Set" Smuggled Abroad Piece by Piece

MINNEAPOLIS.—WLAG, Twin City Radio Central, operated by Cutting & Washington Radio Corporation, has been notified of the frequent reception of its broadcast in Batum, Russia, 6,623 miles away.

Major E. A. Eckman, recently in charge of Near East Relief in Batum but now living in Minneapolis, declares a mystery Radio set, smuggled part by part into the Russian Black Sea port, regularly picks up WLAG. Floyd Gibbons, former Minneapolis newspaper man, is named by Major Eckman as an American journalist who knows of the location of the receiver.

During March and April, 1923, Major Eckman was regularly informed of activities in the United States by reports on the broadcasts from the Twin Cities.

Batum is a city of about 200,000 inhabitants located at the east end of the Black Sea. From this point, oil from the newly developed Baku field is shipped to all parts of the world.

New Speaker Carries Organ Tones Perfectly

Reproduces Deep, Rich Notes as Clearly as Higher Ones

PHILADELPHIA.—In a demonstration and technical paper delivered here before the midwinter convention of the American Institute of Electrical Engineers by W. H. Martin and H. Fletcher, a thorough discussion of quality in broadcast reproduction of music was given.

A most remarkable piece of apparatus employed during the demonstration was a new and experimental form of loud speaker. Two of these were hung over the stage and two in the upper rear of the ballroom of the Bellevue Stratford hotel. The arrangement made it possible to reproduce the famous Wanamaker organ and its echo organ in the ballroom with astonishing fidelity, the deep rich tones of the pedals coming through with the same clearness as the higher tones. The loud speakers are a recent development not yet on the market.

San Francisco Schools to Be Equipped with Radio

SAN FRANCISCO.—San Francisco schools are to be equipped with Radio receiving sets, it has been announced by the board of education. One of the receivers has already been set up in the new Galileo high school. The plan is part of the board's \$12,000,000 school expansion program.

Type CR-14—A 3-tube dry cell Regenerative Receiver \$11000
(Accessories extra)

Bedtime Stories for the Kiddies

WHEN chubby faces smile up into yours and beg for a story, how pleasant to tune in the Man in the Moon or Uncle Wiggly! Then there are Sunday night concerts and scores of other things you want to hear. Tune in on this world of entertainment with a dependable

GREBE Broadcast Receiver

Built in two highly efficient types. The result of more than ten years of skillful development, each is an Instrument of grace and beauty. The rich walnut cabinets house all necessary batteries.

A. H. GREBE & CO., Inc.
RICHMOND HILL, N.Y.

WESTERN BRANCH:
451 East 3rd St., Los Angeles, Calif.

Type CR-12—4 tubes. Combines Regeneration and Tuned R. F. \$17500
(Accessories extra)

Licensed under Armstrong U. S. Pat No. 1,113,149

WJAX MOVES UPSTAIRS 20 STORIES

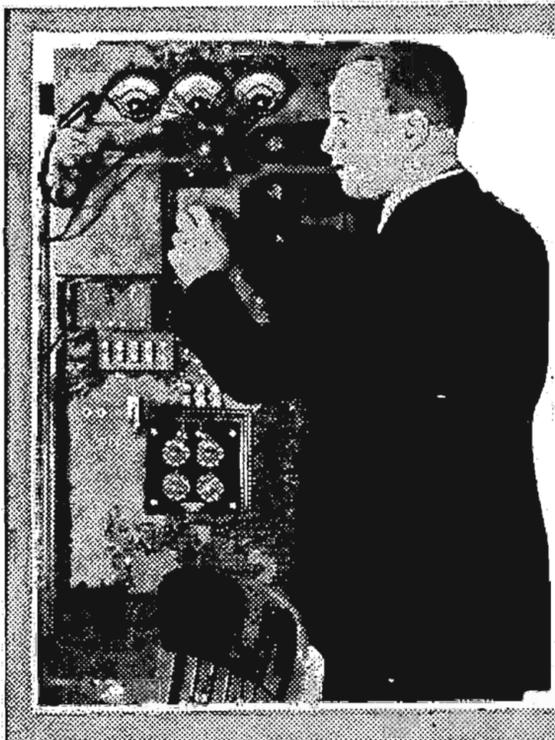

"Lake Erie Wave" Takes New Home

Cleveland Station Moves into Improved Quarters Atop New Union Trust Skyscraper

By P. A. Price

CLEVELAND.—If "The Wave from Lake Erie" comes rolling into your receiver with even more of the volume and clarity than has always distinguished this station. Just say: "Thank you, Mr. Thorburn; here's to your very good engineering work!" For James M. Thorburn, Radio engineer and operator of WJAX, is the man who is directly responsible.

WJAX is now in its permanent home on the top floor of the Union Trust Company's new twenty-story office and bank building at Ninth street and Euclid avenue, here; and the imposing span of the 4-wire aerial swings between two 125-foot towers on the roof of the building, 325 feet above the street; one of the highest aerials in the United States.

Disseminates Bank News

The Union Trust Company is one of the largest financial institutions between New York and Chicago, and it takes a particular pride in its broadcasting station, WJAX, which made its debut August 22, 1922, and is operated during business hours every day of the week, with musical programs on Tuesday and Thursday nights. The station is used primarily for dissemination of financial news to the Trust Company's affiliated banking interests throughout Ohio and to member banks of the Cleveland Federal Reserve District.

A suite of six connecting rooms in the new building are reserved for the broadcasting station. The reproducing room has floor space of twenty-two by twenty-five feet, providing for accommodation of a large orchestra or chorus. The ceiling is treated acoustically by the Johns-Manville process and the walls and windows are hung with monk's cloth. An indicator signal system connects the reproducing and transmitting rooms. A commodious reception room is provided for the comfort of contributing artists.

Has Control Table for City Pick-Ups

The transmitting apparatus is located in a large, well-lighted room and consists of equipment with an output power of 500 watts. Two 150,000-volt lead-in insulators are brought through the roof and ceiling of this room; one for the aerial and the other for the probable later installation of a counterpoise.

The transmitting room is also provided with a control table designed by Mr. Thorburn. On this table are centered the control circuits and signal equipment from the reproducing room and from the desk where the financial news is received and broadcast. The table is equipped with a miniature switchboard for termination of the cable that provides circuits for telephone lines and wires to the Cleveland Public Auditorium, Masonic Temple, and other public buildings from which programs are broadcast by remote control equipment. All microphone circuits are centered and controlled from this table and adequate monitoring facilities are provided by which the operator can determine the quality of output and regulate the gain.

WJAX has a special i-point frequency meter designed and built by Mr. Thor-

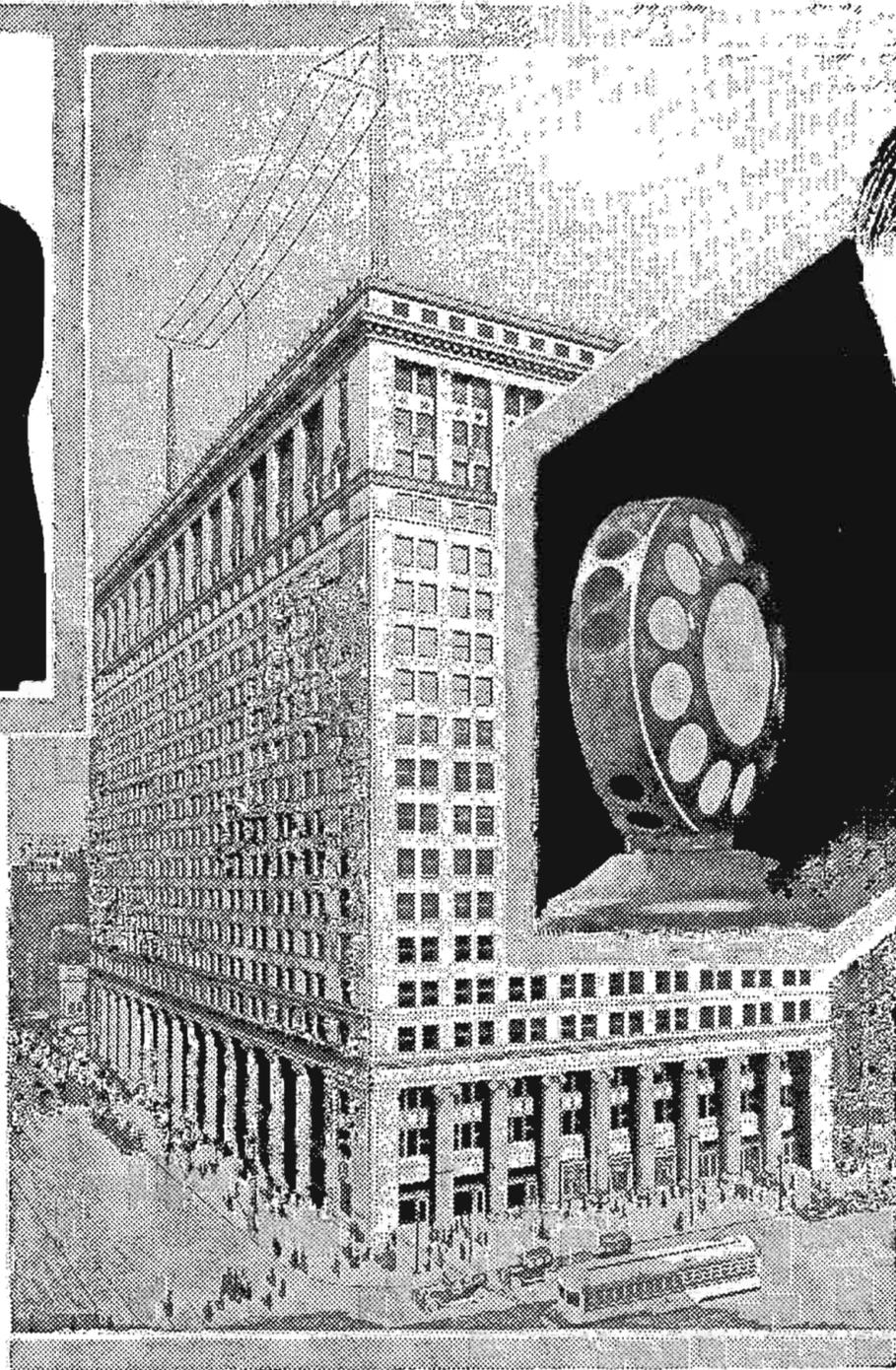

Left, James Thorburn, the engineer and operator; above, Elmer G. Johnson— he of the million-dollar voice—who has been heard from Honolulu to Wales and from Labrador to Panama, both of WJAX, Cleveland, whose new home is shown in center.

burn and calibrated by the Bureau of Standards to read 770 kilocycles, plus or minus 2 kilocycles. Its constant use assures listeners with superheterodyne and neutrodyne sets of being able to mark their dials for definite settings on this station. The station's wave length is 390 meters or, on the new basis, the frequency is 770 kilocycles.

James M. Thorburn, the engineer and operator of WJAX, is a modest, unassuming young fellow who would rather talk about his station than himself. Radio is his hobby and has been since its first use as a means of communication. He learned code as a youngster and pounded brass for the Clark Wireless Company at Port Huron, Mich. Then came the war, and Mr. Thorburn saw overseas service, first as operator on the U. S. Cruiser "Columbia," and later as Chief Radio Operator on the destroyer "Mayrant." After the war he returned to private life, installing the first Radio set for the Detroit Edison Company. He was later with the Ford Motor Company, doing development work, and for two years was wireless operator on Henry Ford's yacht, the "Sialia." In 1922 Mr. Thorburn came with the Union Trust Company, installing their original station and remaining to become their

Radio engineer. He is an associate member of the A. I. E. E. and the I. R. E., and keeps in close touch with the latest developments in applied Radio engineering problems.

Heard in Buenos Aires Once?

E. G. Johnson, announcer at WJAX, is also an operator, but his pleasing voice renders him of particular value before the microphone. Mr. Johnson is a young chap, good-looking and ever so popular with the feminine portion of his invisible audience. It may be said that this audience is almost world-wide since letters of applause have come in from Wales in the British Isles, from the Bahamas, from Bermuda, from Cuba and Porto Rico, from Panama and the Hawaiian Islands, all States in Mexico and in the United States and from every province of Canada.

There is every reason to believe that WJAX was heard in Buenos Aires, S. A., but the log was not satisfactory enough to make it a matter of official record. With the higher aerial Mr. Thorburn confidently expects a greatly increased range of transmission, so Europe, Asia, Africa and Australia must not be surprised if "The Wave from Lake Erie" should reach their shores.

Teaching the Radio A-B-C's:

"THIRTY-MINUTE A-B-C Lessons for Radio Beginners," a series of extremely well-worded articles on Radio by P. E. Edelman, begins in two weeks. Radio Digest believes it has found in Mr. Edelman the first and only real writer for the Radio novice. His diagrams and explanations portray with the utmost simplicity exactly what happens when a program is broadcast and received by the listener in. In other words, the series gets down to "ham and eggs" and bedrock without enveloping the beginner with a barrage of meaningless technical words, phrases and diagrams. Begin the series March 22 with the first article, "A Radio Night's Entertainment." Here is told what a broadcast listener finds out, how programs are transmitted and heard, that Radio is energy, what modulation means, and what receiver essentials are.

BRITISH HEAR U. S. NIGHTLY IN 1929

Experts Work on Relay Instruments to Bring Forecast True

LONDON.—In five years British Radiophans will, according to Capt. Eckersly, chief engineer of the British Broadcasting company, listen to a nightly program something like the following.

8:30 o'clock, the American President speaks to Great Britain; 9 o'clock, the British prime minister replies; 9:15, a song from the backwoods of Australia; 9:30, an opera from Berlin; 9:45, a message from China; 10, native music from India; 10:15, an instrumental number from Moscow; 10:30, a nightingale duet from Surrey.

The first effort toward bringing the forecast true is in perfecting instruments to relay American programs. It is predicted that within ten years British receivers will be listening in on United States broadcasts, relayed regularly through stations in London. KDKA has already been relayed by 2LO here.

Circus Calliope Music Interrupted by Cops

But They Put Back Their Club When WSB Explains

ATLANTA, GA.—The strident strains of a circus calliope, unexpectedly disturbing the midnight quiet of a staid Atlanta neighborhood recently, brought minions of the law swooping down from all directions and gave WSB's audience an innovation productive of responses from Maine to California.

The calliope was parked on a side street while en route to Florida and the carnival harmony was picked up by a hastily installed relay line from the Atlanta Journal's station. Peanuts and pink lemonade were the only items lacking in making the aerial parade complete, according to hundreds of listeners. The constabulary entered into the spirit of the affair after learning the facts.

Griffis' Speech Breaks Silent Night at WLW

CINCINNATI.—Station WLW of the Crosley Radio Corporation, this city, recently broke its customary Friday evening silence for an event that proved of interest to listeners in of many parts of the country—an address by Corliss H. Griffis, whose abortive attempt to kidnap Bergdoll and subsequent confinement in a German prison has been given much publicity. Griffis was also heard previously from Station WJAX, Zenith-Edgewater Beach Hotel, Chicago.

"THE AIR IS FULL OF THINGS YOU SHOULDN'T MISS"

EVEREADY Radio Batteries

—they last longer



Eveready gives you the right battery for every radio use!

EACH Eveready Radio Battery represents thirty years of battery building experience. Each Eveready Battery represents millions of dollars invested in men, methods and machinery. Overseeing Eveready production is the greatest battery laboratory known to science, where every particle of raw material is required to pass Eveready's exacting tests. To insure Eveready serviceability, batches of Eveready Batteries are constantly being set aside for performance tests. And, finally, daily shipments keep dealers supplied with fresh Eveready Batteries, packed full of power.

To be certain of battery satisfaction, insist on Eveready Radio Batteries—they last longer.

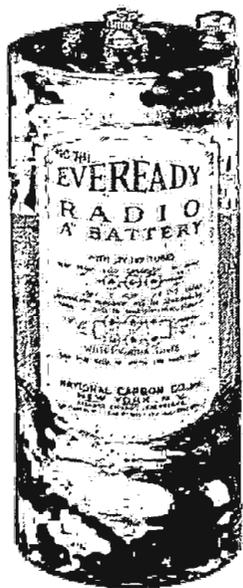

The radio dry cell triumphant

For economical, satisfactory radio, light the filaments of your dry cell tubes with the Eveready Dry Cell Radio "A" Battery. Will unfailingly outlast any other at 1/8 ampere current. Full instructions for getting this Economical Eighth, on labels and in our booklets. This battery will exceed your expectations in economy and performance.

Equal to all demands

Power flows from your "B" Battery, power that gives life to your head-phones or loud speaker. Some tubes draw more "B" Battery current than others, but whatever the tube or tubes you use, Eveready "B" Batteries will give you maximum results. Always use the biggest possible battery, for it contains more energy in proportion to cost, and lasts longer. Where table space is limited, buy No. 764, the compact but capacious vertical 22 1/2-volt "B."



This battery is a wonder worker



Eveready's biggest contribution to economical and more satisfying radio is the Eveready "C" Battery, a triple-use, universal battery. It will make the loud speaker respond with a new fullness and naturalness of tone, and save much money by making the "B" Battery last still longer. Connect it with the grids of audio frequency amplifiers and notice the big difference. Can also be used as an "A" Battery for 199-type tubes in portable sets, and as a "B" Battery booster. Eveready Radio Battery No. 771—use it!

NATIONAL CARBON COMPANY, Inc., New York—San Francisco
Headquarters for Radio Battery Information

CANADIAN NATIONAL CARBON CO., Limited. Factory and Offices: Toronto, Ontario

Informative and money-saving booklets on radio batteries sent free on request. If you have any radio battery problems, write to G. C. Furness, Manager, Radio Division, National Carbon Co., Inc., Thompson Ave. and Orton St., Long Island City, N. Y.

SUPER-PLIODYNE IS NEW ONE TO BUILD

BUT NOT UNLESS YOU GET
NINE TUBES FIRST

C. L. Farrand Invents Six Stage Radio
Frequency Set Tuned by One Con-
trol—Claimed Efficient

(Continued from page 1)
signal, far greater amplification per tube used would be obtained than is possible when untuned transformers are used to couple the stages. The difficulty has been, heretofore, that each stage of tuned Radio frequency amplification added meant another control and construction had to stop at two stages because listeners are only endowed with two hands.

In the super-pliodyne six stages of tuned Radio frequency are used with a detector and two stages of audio frequency amplification.

How R. F. Transformers Are Made

In the drawing shown herewith it will be noted that nine tubes are placed across the rear edge of the baseboard and that between the first seven, small Radio frequency transformers are placed. These are of novel construction, although similar in many respects to neutroformer coils.

The secondaries, which are connected in the grid circuits, consist of one hundred turns of No. 26 wire wound on a tube two inches in diameter and about 2 3/4 inches in length. The primaries are wound with twenty-five turns of the same size wire on tubes 1 3/4 inches in diameter and placed within the secondaries. The twenty-five turns of the primary are spaced so that they occupy the same length of tubing as do the one hundred turns of the secondary.

Resistances Stop "Howling"

Contrary to usual practice, the turns of the primary are wound in the opposite direction to those of the secondary. The end of the primary winding under the grid end of the secondary is connected to the B battery. The remaining terminals are connected in the usual way, as shown in the diagram.

The small condensers shown, connected from the grid to plate of each tube, are not neutralizing condensers. The inherent capacity of the tubes which is the cause of "howling," or oscillating, is nullified by the resistance in series with the condensers

SUPER-PLIODYNE DIAGRAM AND LAYOUT OF PARTS

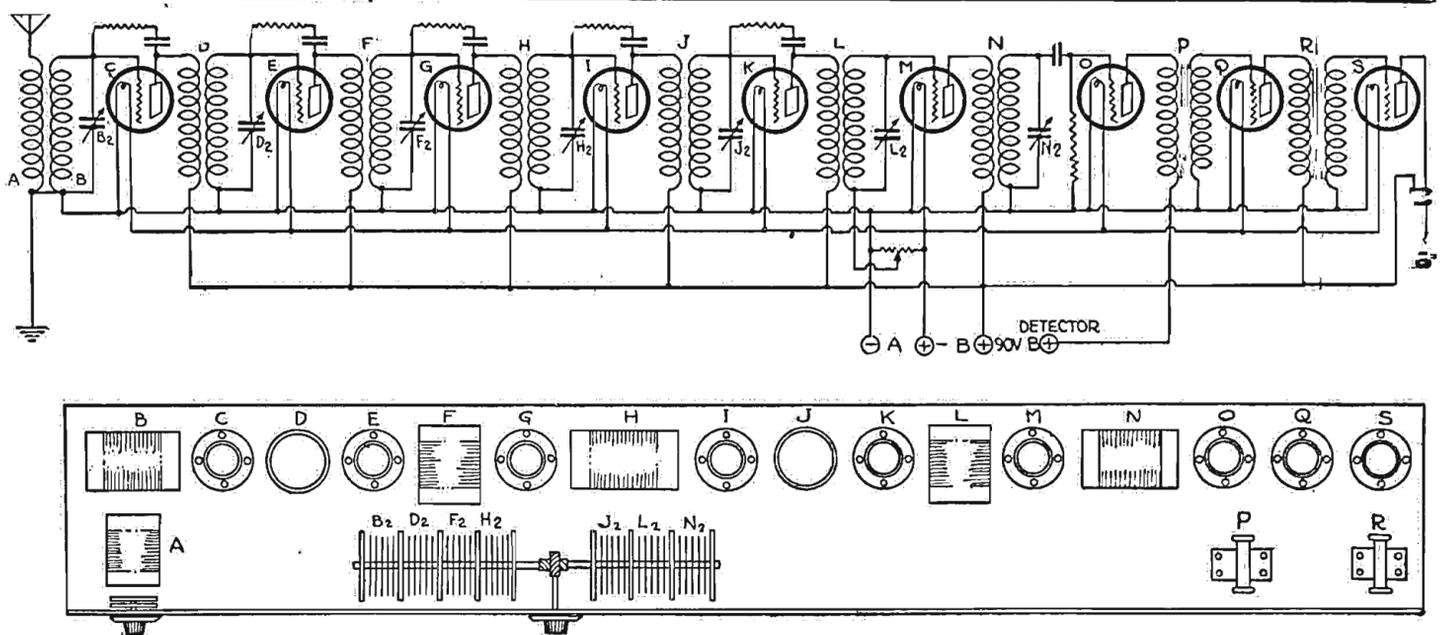

mentioned, and the condensers merely serve to keep the B battery voltage off the grid. Were they not present the grids would be 90 volts positive in relation to the filaments.

The small resistances are 20,000 to 30,000 ohms for storage battery tubes and 90,000 to 120,000 ohms for dry cell tubes. They are not critical, but should be of the non-inductive variety, such as the cartridge or lavite types. The small condensers in series with those resistances may be anything from .0001 to 1.0 microfarad in value, as they are merely for blocking off the plate voltage. "O" is the detector tube and "Q" and "S" the audio stages.

Amplifies 3,000,000 Times?

While Mr. Farrand stated that his measurements indicated an amplification of twelve per stage, there was an error somewhere in his tests, as this would give a total amplification of 3,000,000 over the six stages and no vacuum tubes now used in reception would carry this energy. The first five stages of this receiver are non-regenerative, but regeneration is permitted to enter the last stage of Radio amplification before the detector (see diagram) by omitting the nullifying resistance and con-

trolling the tendency to oscillate by means of a potentiometer.

Tuning Is Effected by One Dial

The control of eight condensers is most ingenious. The shaft to which the dial is attached projects straight back into the cabinet about three inches. On the end of it is a large worm gear. Directly below it is another large worm at right angles attached to a shaft running parallel to the panel. On this shaft are the rotary plates of eight condensers, which revolve within the fixed plates divided into eight groups.

Since one side of all the condensers goes to the negative "A" battery terminal, the shaft is a common terminal of all eight condensers. Each group of fixed plates is, of course, insulated from its neighbor and is connected to a grid. Between each group of fixed plates is a circular disk which touches neither the shaft nor the fixed plates and is grounded, forming a shield. Each condenser has a maximum capacity of about .00025 mfd.

In concluding, Mr. Farrand stated that: "Additional improvements in selectivity have been made which, unfortunately,

cannot be disclosed at the present time and will have to form the subject of a later paper." Digest readers will have these data as soon as released, but sufficient is given here to enable experimenters to go ahead.

Union Musicians Play 10-Day Series at WSB

ATLANTA, GA.—The entire strength of the Atlanta Federation of Musicians, local chapter of the national professional body, the American Federation of Musicians, recently mobilized to present a ten-day series of special concerts at WSB. Every orchestra, band or soloist at Atlanta theaters, hotels, parks, dance halls or other entertainment centers helped in taking over the station's entire schedule for a fortnight. "Specialty" programs, themed on grand opera, international, Dixie, old time, movie, Canadian, and other music, were presented at individual broadcasts. Recognition of Radio's value in boosting the musical union's annual benefit ball gave WSB's audience the gala period of entertainment.

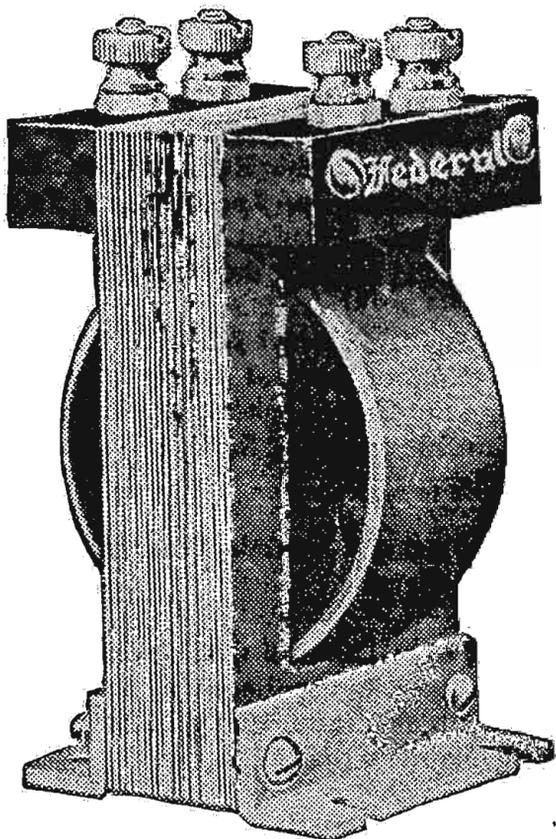

The now famous No. 65 Audio Frequency Transformer is but one of over 130 radio parts designed, manufactured, and guaranteed by Federal.

\$7.00



Federal

Standard RADIO Products

When You Buy Federal Radio Parts You Are Purchasing

the perfected result of over a quarter century research and experimentation,

an iron-clad performance guarantee of an organization which has reached leadership through its willingness and ability to fulfil both the letter and the spirit of its obligations,

the satisfaction that the part or set is built for permanency of performance as well as for today's gripping thrills.

Thus the 130 radio parts, designed, manufactured and guaranteed by Federal offer every possible advantage and safeguard to those who want the joys of home assembly.

Federal Telephone and Telegraph Company

Factory: BUFFALO, N. Y.

Boston New York Philadelphia Chicago San Francisco
Pittsburgh Bridgeburg, Canada London, England

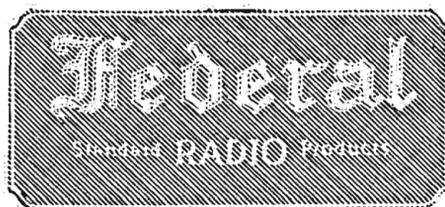

The Sign of Reliable Radio Dealers

VAN FLEET BALKS ON TRUST REPORT

SO DIGEST INVESTIGATES PAST LIFE AND HISTORY

Was "Democrat Ouster" and Friend of Senator Watson, "Arch Enemy of Trade Board"

CHICAGO.—Not many weeks ago the Federal Trade Commission filed a complaint against the Radio Corporation of America and the companies linked with it, because, it was said, they had "combined and conspired for the purpose . . . of restraining competition and creating a monopoly, etc."

However, at the end of the complaint appeared the significant note, "By the Commission; Commissioner Vernon W. Van Fleet, dissenting." Or, in other words, Mr. Van Fleet, the newest member of the Federal Trade Commission, seemed to have his own opinion about the complaint against the R. C. A., and was opposed to filing it.

Let us examine Mr. Van Fleet a little closer—

Had Job as "Democrat Ouster"

Vernon W. Van Fleet, of South Bend, Ind., was sworn in as a Federal Trade Commissioner on June 30, 1922, for a term of seven years. Just prior to his appointment as a Commissioner he was employed in the Department of Justice as a special assistant to the attorney general, which position he occupied from March, 1921, until the time he was appointed to the Commission.

While he was appointed to give his attention particularly to reorganization work of the department it is understood that his main job was to weed the Democrats out of the department.

Van Fleet for Crooked Business?

When his name was sent to the Senate by President Harding for confirmation there was no serious objection to the confirmation except from Senator LaFollette, of Wisconsin. Van Fleet was Harding's pre-convention manager in Indiana and he came to Washington for his job as soon as the new Administration could find a place for him.

Judge Van Fleet's chief booster in the Senate for confirmation was Senator James E. Watson of Indiana, called the arch enemy of the Trade Commission. At the

IS VAN FLEET BIASED FOR "BIG" BUSINESS?



Vernon W. Van Fleet was the only member of the Federal Trade Commission casting a dissenting vote when it filed its complaint against the Radio Corporation of America.

time of the appointment it was rumored in Washington that Van Fleet shared Watson's views and it was thought at the time that the appointment could be regarded as the administration's first step to put an end to the Commission's efforts to regulate crooked business.



BRISTOL SINGLE CONTROL RADIO RECEIVER

(NON REGENERATIVE)

Using Grimes Inverse Duplex System

ONE CONTROL ONLY Makes It Most Simple to Operate.

SIMPLICITY OF OPERATION is the outstanding feature of this Receiving Set. One Control Dial includes every adjustment. To tune in, turn this Dial. A station once located can always be brought in again at the same setting.

NOT CONFINED TO LOCAL BROADCASTING—this four-tube set has power equal to six. Because the Grimes Inverse Duplex System utilizes the first two tubes for both Radio and Audio Amplification.

ANTENNA OR LOOP—either may be used to suit conditions.

SOLID MAHOGANY CASE with walnut finish encloses the complete Receiving Set. It is a beautiful piece of furniture fully in keeping with the most luxurious room.

The Price

Bristol Single Control Radio Receiver

\$190.00

Ask for copy of Bulletin AY-3013 describing this set.

THE BRISTOL CO.
Waterbury, Connecticut

IF it's the outdoor antenna that's been holding you off, you want D-7-A or D-10 Portable, the De Forest Radiophones that use an indoor loop aerial the size of a small picture frame—and bring in the broadcast of half the American Continent.

Authorized agents everywhere.



DE FOREST RADIO TEL. & TEL. CO.
Dept. R. D. 8 JERSEY CITY, N. J.

OPERATING AND TROUBLE SHOOTING

For the Owner of an



Radiola VII Receiver

“OPERATING and Trouble Shooting” is a Radio Digest feature whose purpose is to study the late models of various standard receiving sets and to show the newly initiated broadcast listener, who has purchased such a set, how he can operate it to get the best there is in it and how he can overcome minor difficulties which may be causing some trouble. On pages 9 and 10 this week the R.C.A. Radiola VII Receiver is described. Radiophans with other sets will also find these articles worth reading, particularly the notes on trouble finding.

RADIOLA VII is designed for use with radiotron UV-199, which operates entirely from dry cells. Electrically, it consists of a highly selective two-circuit tuner and a five-tube detector-amplifier, self-contained and ready to connect to antenna and ground (or to a loop antenna) and a loud speaker.

The design is such that all batteries contained within the cabinet. The wave length range covers the entire broadcasting band of 220 to 550 meters.

The set may be used with a loop, an indoor antenna or an outdoor antenna. For indoor antenna use, a wire 15 to 20 feet long stretched about the room will give very good results, while for an outdoor antenna a single wire, 20 to 180 feet long and 20 to 50 feet in height, is the usual practice.

There is included with the set a Faradon socket antenna, which may be substituted for the indoor or outdoor antenna. In using the socket antenna, it is only necessary to screw it into a lighting socket in the same manner as an ordinary lamp.

Batteries Required

Six ordinary dry cells, 1½ volts each, for lighting the filaments; two 45-volt plate batteries (two 45-volt units are recommended instead of four 22½-volt units); and two 3-volt negative grid bias batteries.

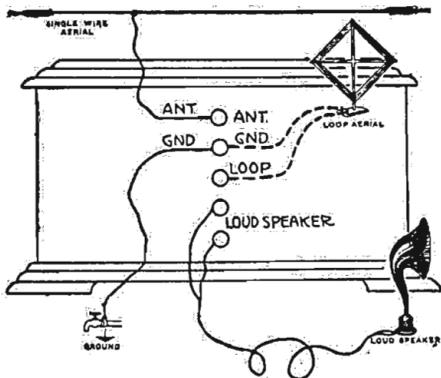

Installation of Batteries

The A batteries are held in place by the bakelite clamping plate secured by two wingnuts. They should be connected in two parallel groups, each of three cells in series, as shown in illustration.

The method of connecting the B battery is shown clearly. After this is done, two units should be placed in the cabinet and fastened down with the clamp and wingnut provided. The units should be placed in the cabinet one at a time. The leads are sufficiently long to permit making connections outside the cabinet for convenience.

Great care should be taken to keep the battery connections tight, as failure to do so may result in objectionable noises or complete inoperation of the set.

To insert the C battery, first bend the long battery prongs out straight (to lie parallel to axis of cells). With prongs toward top of cabinet, slip downward into spring, then over toward center of box until the prongs are firmly pinched by the small jaws provided for contact. The same jaws are placed at different heights in order to properly take the long and short prongs provided on the flashlight batteries.

Be sure that all tubes are removed from

their sockets when installing batteries.

Additional Adjustments

If this set is to be used with an outdoor antenna or with the socket antenna, the small switch inside the cabinet and back of the C battery support should be in the open position. If a short indoor antenna is to be used, such as a 20-foot wire about the room, the switch should be in the closed position. For long distance work an outdoor antenna is preferable.

In the instance of either an outdoor or indoor antenna being used, a ground connection must be made. This is made preferably to a water pipe, but if this is inconvenient, a radiator or steam pipe will usually serve the purpose. In making the ground connection, the pipe should be scraped clean and the ground wire firmly connected.

When the Radiola VII is used with a loop, no antenna or ground connections are necessary. As shown, the loop connections are the second and third binding posts from the top.

The two binding posts at the bottom of the receiver, in the back, are for the externally connected loud speaker. Head telephone reception is also possible by connecting the tips of the telephone cord to the plug and plugging in the jack at the lower right corner of the panel. This automatically disconnects the loud speaker. Do not attempt to use the loud speaker plugged into the telephone jack,

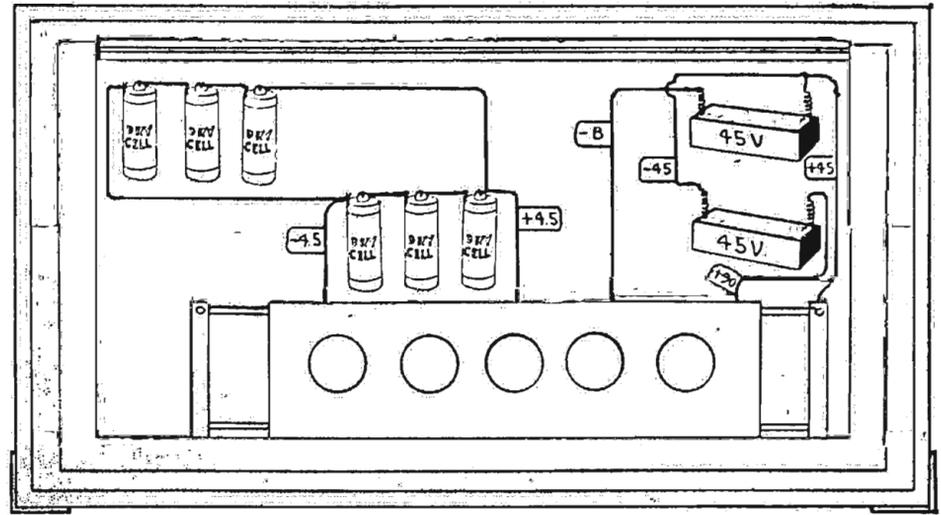

as the volume will be insufficient to operate it. The jack is intended only for head telephones. In connecting the loud speaker, it is well to try reversing the leads, as with some loud speakers this increases the volume and improves the quality.

With Outdoor, Indoor or Socket Antenna

1. Be sure that set is properly connected.
2. Be sure that white button 1 of push

switch is out.

3. Insert tubes in their bayonet sockets by pressing down slightly and turning to the right.

4. Adjust vernier condenser controls 7 and 8 so that white lines will be vertical.

5. Be sure filament control 5 is turned as far as it will go to the left.

(Continued on page 10)

Earn \$500 to \$2000 a Day in RADIO

You can! Hundreds of ambitious men are already earning thousands of dollars in this wonderful new industry—many working only in their spare time. Mail coupon below for Free Book which describes fully the amazing money making opportunities in Radio and tells how YOU can earn from \$500 to over \$10,000 a year!

The astounding growth of Radio has created thousands of big money opportunities. Millions of dollars were spent during the past year on Radio—and thousands of young men are needed right now to meet the ever increasing demand of work. Never before has there existed so many and such remarkable opportunities for making money in this wonderful new field.

Men are needed to build, sell and install radio sets—to design, test, repair—as radio engineers and executives—as operators at land stations and on ships traveling the world over—as operators at the hundreds of broadcasting stations. And these are just a few of the wonderful opportunities!

Easy to Learn Radio At Home In Spare Time

No matter if you know nothing about Radio now, you can quickly become a radio expert, by our marvelous new method of practical instruction—instruction which includes all the material for building the latest up-to-date radio apparatus.

Scores of young men who have taken our course are already earning from \$75 to over \$200 a week. Merle Wetzel of Chicago Heights, Ill., advanced from

lineman to Radio Engineer, increasing his salary 100% even while taking our course! Emmett Welch, right after finishing his training, started earning \$300 a month and expenses. Another graduate is now an operator of a broadcasting station, PWX of Havana, Cuba, and earns \$250 a month.

Still another graduate, only 16 years old, is averaging \$70 a week in a radio store.



Wonderful Opportunities

Hardly a week goes by without our receiving urgent calls for our graduates.

“We need the services of a competent Radio Engineer”—“We want men with executive ability in addition to radio knowledge to become our local managers”—

“We require the services of several resident demonstrators”—these are just a few small indications of the great variety of opportunities open to our graduates.

Take advantage of our practical training and the unusual conditions in Radio to step into a big paying position in this wonderful new field. Radio offers you more money than you probably ever dreamed possible—fascinating easy work—a chance to travel and see the world if you care to or to take any one of the many radio positions all around you at home. And Radio offers you a glorious future!

1000 Mile Radio Set FREE

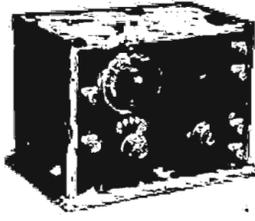

In order to complete your practical instruction at home, learning by actual experience, this splendid regenerative receiving set is now included without the slightest additional cost.

Send for FREE BOOK

Learn more about this tremendous new field and its remarkable opportunities. Learn how you can quickly become a radio expert and make big money in Radio. Find out what remarkable successes our graduates have had—even a few weeks after their training finished.

We have just prepared a new 32-page booklet which gives a thorough outline of the field of Radio—and describes our amazing practical training in detail. This Free Book, “Rich Rewards in Radio” will be sent to you without the slightest obligation. Mail coupon for it now!

National Radio Institute

Dept. 55 CA
Washington, D.C.



National Radio Institute, Dept. 55CA, Washington, D.C.

Please send me without the slightest obligation your Free Book, “Rich Rewards in Radio” and full details of your special Free Employment Service.

Name

Address

City

State

Radio Firms—Secure practical Radio Experts among our graduates. Write us today.

OPERATING AND TROUBLE SHOOTING

(Continued from page 9)

6. Press white switch button. This should light the tubes dimly. Caution: The tubes used in this set burn dimly as compared with the older types of tubes.

7. Advance filament control pointer 5 as far as the word "Increase" on the dial.

8. Place pointer of control 2 in the position on the "antenna" or upper part of the dial, including the wave length (as marked on the dial) it is desired to receive.

9. Place stabilizer pointer at the maximum position and decrease when "carrier beat" of station desired is heard, as explained below. It should be borne in mind that when two stations of different wave lengths are operating simultaneously, it is usually possible to separate one from the other. This separation can usually be made when stations differ in wave lengths by 10 meters or more, and sometimes when the stations differ by only a few meters, depending upon the skill of the operator. No receiver can separate stations working on exactly the same wave length, although a powerful local station may be easily heard through a weaker and more distant station.

10. With this receiver, when control 2 is on the "antenna" side, seven settings of the "secondary tuning" control for seven different wave lengths are given in the table below:

Dial Setting	Wave Length Switch Position	Wave Length
To be filled in by operator	220-280.....	250
	280-370.....	300
	370-460.....	350
	460-550.....	400
		450
		500
		550

To pick up a station, the secondary tuning control should first be set to the approximate wave length of the station it is desired to hear, using the above table for first setting. Then the antenna tuning control 4 should be moved slowly over the scale until signals are heard.

11. When a station is picked up, it should first be carefully adjusted on the secondary tuning control, and then on the antenna tuning control. Finer adjustment can be made with the two small vernier knobs 7 and 8. Signals may be made louder by moving the stabilizer control toward "increase."

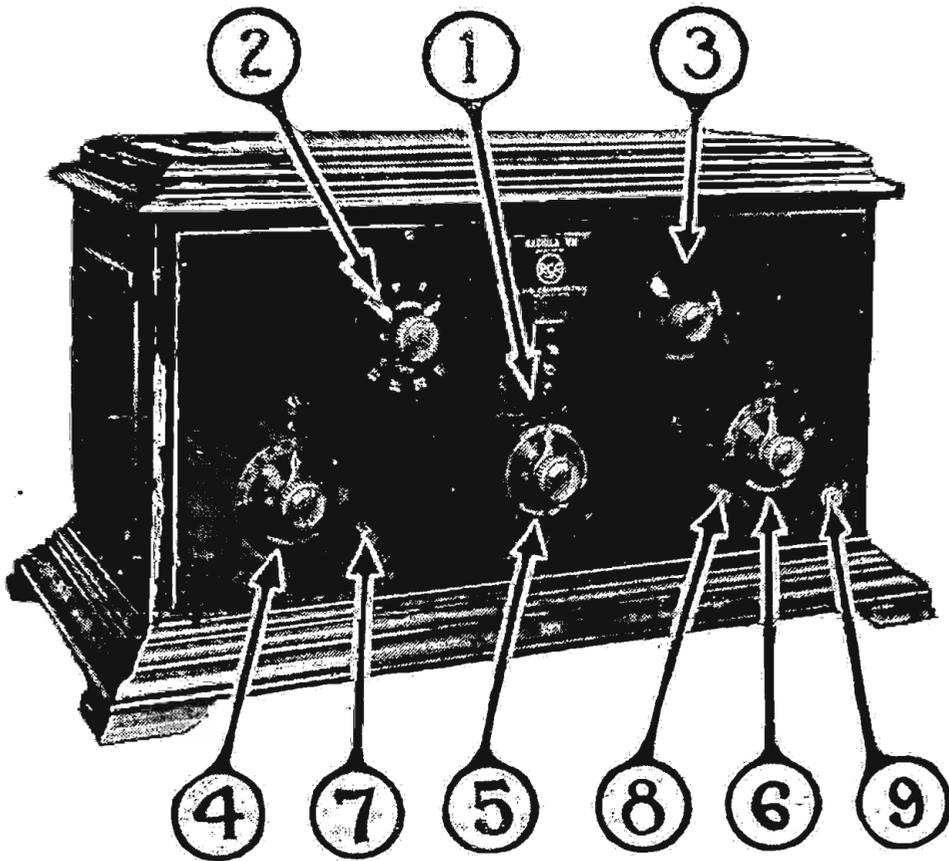

The best stabilizer position will be found at a point just below what is termed the "oscillation point." When this point is exceeded and the secondary control 6 is moved through the broadcasting range, whistling sounds known as "carrier beats" will be heard. While receiving a "carrier beat" the procedure is to lower the stabilizer a trifle, at the same time manipulating the secondary vernier 8 until the carrier beat note disappears, indicating that oscillation has ceased and the station is heard without distortion. To strengthen the signal, bring the antenna circuit into

tune by varying antenna controls 4 and 7. When tuned to maximum intensity by this means, gradually increase stabilizer until still further volume is attained. Bear in mind that the stabilizer is an adjustment of sensitivity and not of tuning. Care should be taken that set is not left in oscillating condition.

Increasing the filament current may also help the signal volume, but this control should be kept low as possible to obtain good results, or else the life of the batteries and tubes will be prematurely shortened by the excessive current.

Operation With Loop Antenna

1. Place control 2 in the position on the "loop" side, including the wave length it is desired to receive.

2. Other precautions and instructions for tuning remain the same as when used with outdoor or indoor antenna, except that the antenna tuning controls 4 and 7 are automatically cut out of use, or removed from the circuit.

The loop should be rotated about its vertical axis until reception reaches a maximum volume. Interference from an undesired transmitter may also be eliminated by making use of the directional properties of the loop, turning it until the undesired signal is weakened as much as possible.

It is advisable when using a loop to remove the antenna and ground leads from the rear binding posts to improve the directional qualities of the loop.

Caution

When the set is not in use, the black button of the filament switch should be pushed in to turn off the filaments of the tube. It is detrimental to both tubes and batteries if they are permitted to burn unnecessarily. Handle the tubes carefully and do not insert them in the socket while the filament switch is on.

Replacements

With average use the A batteries should last about three months. They require replacement when the filament control 5 must be kept at maximum for best reception, and when the tubes light but dimly with the pointer in that position. The old cells can be removed by disconnecting all wires from battery binding posts and removing the wingnuts. Then the cells may be taken out and new ones connected in their place.

The B batteries should outlast two sets of A batteries. The best way is to obtain a voltmeter which will indicate up to 100 volts at least. The meter should show at least 80 volts when across two new batteries, and batteries are exhausted when total voltage gets below 70 volts.

The C batteries should be removed every three months to insure proper functioning of this receiver. This procedure may be carried out quite readily by reference to the section which treats with the installation of these batteries.

(ANOTHER SET NEXT WEEK)

1c SALE

One of Six Large New York Stores

The RADIO-SHACK

58 Dey Street - New York City
Goods shipped C.O.D.
Just pay the postman

EVERY ARTICLE SOLD ON WRITTEN MONEY-BACK GUARANTEE

Send No Money. We'll Ship Anything C. O. D.

1c SALE

They Won't Let Us Stop

Letters are pouring in from all over the United States asking us for more 1c sale items. Many requests have been made for more time in which to buy. We feel obligated to our many friends and are happy to announce that the prices in the Feb. 9th issue of the RADIO DIGEST will be good for one more week.

<p>SUPERTRON TUBES Just received a new shipment. Oh boy, what an amplifier! Better than ever. At this price they'll go fast. The 201 A's are 6 volt, dry cell or storage battery operated, and the W. D. 12 type uses 1 1/2 volt dry cell. Better get your order in now. Both types, 1 for \$6.49. 2 FOR \$6.50</p>
<p>VARIABLE CONDENSERS Just get these points! 1. Heavy moulded end plates. 2. Phosphor-bronze contacts to heavy binding posts. 3. Processed aluminum plates that retain their alignment. 4. Aod the list price is double what we ask. 11 plate 1 for \$1.99 23 plate 1 for \$2.49 43 plate 1 for \$2.99 VERNIER CONDENSER with dial. Same as above. 11 plate vernier..... \$4.99 23 plate vernier..... 5.69 43 plate vernier..... 5.99 2 FOR 1c MORE</p>
<p>VARIOMETER Let's tell you about the new variometer! First of all, it's moulded. Of course, it has pigtail connections for efficiency. And a positive stop. Split? Oh, yes. Can be split for any circuit. Green silk windings and takes 800 meters. 1 for \$5.49. 2 FOR \$5.50</p>
<p>SOCKETS A new process enables us to offer an unheard of value. By this new method a nickel tube is forced into a moulded base under heavy pressure. This assures perfect contact with the phosphor bronze springs. Easily worth 75c each. 1 for 69c. 2 FOR 70c</p>
<p>PHONES For this sale we are going to let you have TURNER 3,000 ohms phones for a very low figure. 1 pair for \$5.89. 2 FOR \$5.90</p>
<p>DIALS Mahogany colored dials with exceptionally heavy brass bushing. Will dress up your set. Change your dials and make your friends think you have a new set. List \$1.00. 1 for 69c. 2 FOR 70c</p>
<p>The following "hard to get" apparatus in stock at special prices. Eria Transformers, Hilco Couplers, Eria Crystals, Rathbun Condensers, Premier Jacks, Eria Blueprints, Eria Sockets, Lavite resistances 48,000 ohm, Amplex Grids, All-American Push-Pull Trans., Amseo Condensers and rheostats.</p>

INDEPENDENT LICENSED BY RADIO MANUFACTURERS INC.

NEUTRODYNE

UNDER HAZELTINE PATENT NO. 1458088
OTHER PATENTS PENDING
REG. U.S. PAT. OFF.

The Shack Neutrodyne! That is all the fans seem to be talking about. The wonderful distance-getting power of the Neutrodyne and the low price of the genuine Neutrodyne parts at the Radio Shack. Licensed under the original Hazeltine patents. Licensed parts are your protection. They always work.
Complete list of parts for building five tube set. **\$25 97**

A Special Dial Screwdriver Free With Every \$2.00 Purchase

<p>D. L. COILS 35-50-75-100 Just the size for Three Circuit. 1 FOR 69c. 2 For 70c</p>	<p>GOLD BUS BAR Most Efficient. Allows high frequency currents least resistance. Used in finest sets. Reg. 15c. 1 FOR 15c. 2 For 61c</p>
<p>VERNIER CONTROL For any Dial. Makes a Vernier out of any make condenser. Very efficient. Reg. 75c. 1 FOR 49c. 2 For 50c</p>	<p>TRANSFORMERS Audio Frequency well known standard make. Ratio 4-1. Reg. \$5.50. 1 FOR \$5.49. 2 For 5.50</p>
<p>DIALS DeForest Type Remarkable value. Knurled knob with heavy brass bushing. 1/4 and 3/8 shafts. 2 inch..... 39c 2 1/2 inch..... 44c 3 inch..... 54c 4 inch..... 74c 2 FOR 1c MORE</p>	<p>LITZ WIRE Most Efficient. A double silk covered wire with 37 strands of No. 38 wire, each strand enameled. Wonderful for Coils, Loops, etc. 1 FT. FOR 4c. 2 For 5c</p>
<p>AERIAL WIRE 7 Strand Tinned copper wire gives excellent results on OX work. Reg. \$1.00. 100 ft. 99c. 200 For 1.00</p>	<p>VERNIER RHEOSTATS The famous TECO. Needed for your detector tube. 1 FOR 89c. 2 For 90c</p>
<p>HYDROMETERS Very Accurate. Packed in wooden moisture proof box. Reg. 75c. 1 FOR 59c. 2 For 60c</p>	<p>VARIOCOUPERS 180 Degree Wound on Genuine Bakelite tubing with green silk wire. Reaches 600 meters. Reg. \$5.00. 1 FOR \$3.89. 2 For 3.90</p>
<p>JACKS Single or Double German Silver Contacts. Nickel finish. Reg. 90c. 1 FOR 59c. 2 For 60c</p>	<p>TUBE PROTECTORS It is possible to blow your tubes if you attach these to end of socket for 1/4 or 1 amp. tubes. 1 FOR 49c. 2 For 50c</p>

Simple Explanation of Radio for Everybody

Chapter XII, Part II—Radio Frequency Amplification

By M. W. Thompson

IN Figure 93 we have a novel and distinctly different circuit devised by Captain Anatole Gollos and called the "Sunset." Sharp tuning is obtained by coupling the antenna circuit to the first tube by a single turn of wire, L_2 , which is wrapped around L_4 . Ordinarily this would result in loss of volume, but this loss is more than offset by the fact that the single stage of R.F. amplification operates at peak efficiency and without introduction of resistance into the circuit.

Construction of the Coil

Those who would like to do some experimenting with this hook-up should use a tube $9\frac{1}{2}$ inches long and 3 inches in diameter and wind 64 turns of number 18 dsc. wire at one end. This is the inductance called L_3 in the diagram. Leave $\frac{1}{8}$ inch

compose the inductance L_4 , and the single turn of litz is L_2 . After completing L_4 , leave $\frac{1}{8}$ inch and wind 64 turns, forming L_3 . Since the two variable .00025-mfd. condensers shunted across L_2 and L_4 are always at identical settings, they may both be mounted on a single shaft. To do this, get a piece of rubber or bakelite tubing that fits over the rear end of the shaft of one condenser and the front end of the shaft of the second condenser, and fasten with setscrews. It will be found convenient to place the dial controlling C_2 and C_3 in the center, with C_1 to the left and C_5 to the right.

Cotton Circuit

When the above had a multiplicity of parts and controls, we now come to one (Figure 94) with a minimum of parts and

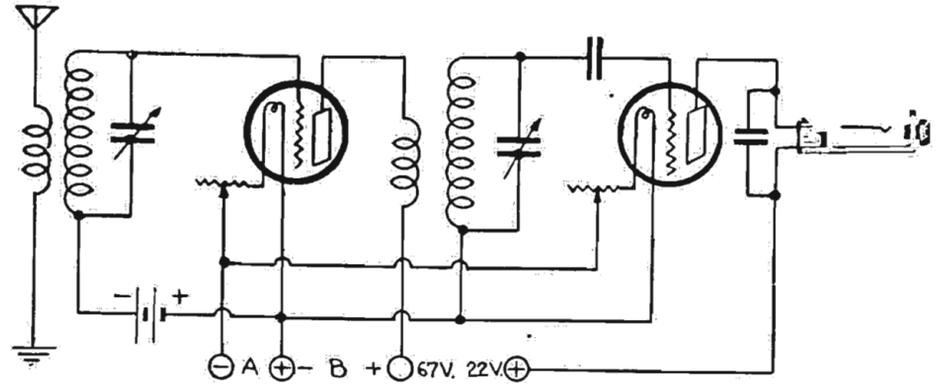

Figure 94—The Cotton fixed coupler receiver permits one to have a stage of R.F. amplification with but one control.

eliminates controls, seemingly without much loss in efficiency, due to not tuning circuits to resonance.

The couplers may be made by winding 52 turns of wire on a 3-inch tube and slipping over this a short tight-fitting tube on which are 6 turns of wire constituting the primary. To cover the entire broadcasting range the secondaries should be shunted by vernier .0005-mfd. condensers. In laying out this set, place the first condenser at left of the panel with the first coupler behind it. The next condenser and coupler are about 3 inches to the right and between them is the R.F. tube. The detector and audio frequency amplifiers are placed to the right of the second condenser and its coupler.

Altering the Peak Efficiency

In circuits using untuned transformers to couple the tubes, the chief difficulty has been that the transformers had a peak efficiency on a certain wave length and much lower efficiencies on other wave lengths. The hook-up shown in Figure 95 is a method of altering the peak efficiency of the transformers to the wave length on which it is desired to receive. In addition to the usual primary and sec-

ondary windings, there is a third winding one end of which is always connected to the grounded or negative side of the filament battery. A switch whose center top is also connected to the grounded side is used to short-circuit more or less turns, which changes the impedance and hence the resonance point of the transformers. A resistance is introduced into the grid circuit of the first tube to prevent its oscillation, while a C battery keeps the grid of the second tube at the proper point of its characteristic curve.

The Radio amateur has undoubtedly done more to advance Radio technically than any other single group in the art. Limited in the amount of power he can use for transmission and in the wave lengths on which he can talk to his friends, he has developed reception to its present high plane—and learned much. The circuit shown in Figure 96 is typical of this. Such a set is not one for the average fan to attempt to build with any assurance of success. Its controls are many, its operation unstable. Probably only its inventor can operate it, or some other very experienced amateur. But it as

(Continued on page 13)

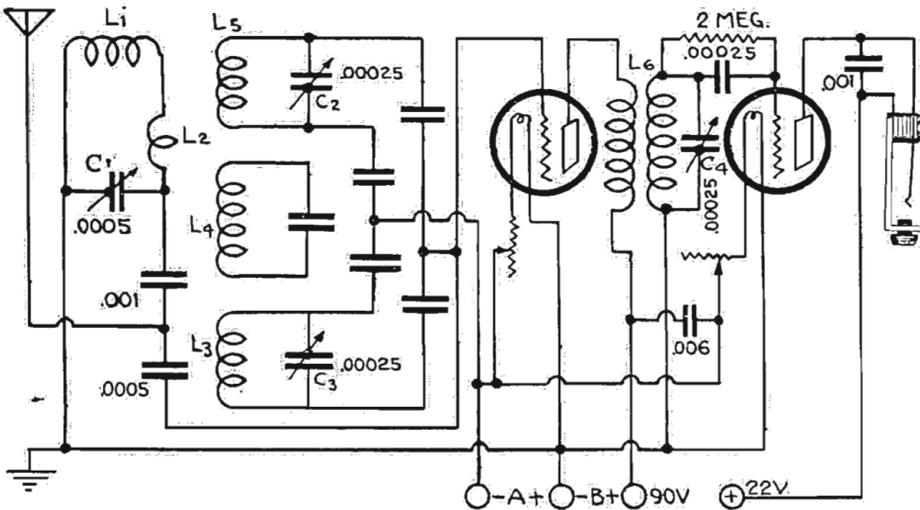

Figure 93—The "Sunset" utilizes counter E.M.F. (electromotive force) to stabilize and aid in selectivity.

on tube and wind 16 turns, then one turn of litzendraht, and continue the 16 turns with 16 more. The two 16-turn sections controls. This was first assembled by Mr. Cotton of Boston and gives truly marvelous results. The use of fixed couplers

RADIO TALKS

A great many of us are very liable to overlook the advantages to be secured by the use of better variable condensers for our tuning units. Great strides have been made in condenser design during the last year and a change for a later and better type will often prove a good investment.

E. J. Flewelling

Genuine—
E. J. Flewelling
Radio Apparatus
De Luxe

The much discussed Flewelling Condenser will soon be available in the .0005 microfarad capacity. It is an instrument we are justly proud of. The capacity reading at 0 setting is so low this condenser can be used in circuits calling for slightly smaller size without loss in efficiency. It is fast being realized that the quality of your condenser determines the quality of your set. Improve your reception with Flewelling Apparatus De Luxe.

BUELL MANUFACTURING COMPANY

2977 Cottage Grove Ave.
CHICAGO

Flewelling
SOCKETS
\$1.00

Flewelling
CONDENSER
[.0005]
\$7.00

Flewelling
TUNERS
\$8.00

BLUE PRINTS



Make Your Own Sets

Miloplex

Three Tube Receiver
Detector and Two Stage
Audio Frequency Amplifier
Assembly Details
Tuning Instructions
Blue Prints

Reinartz

Three Tube Receiver
Detector and Two Stage
Audio Frequency Amplifier
Assembly Details
Tuning Instructions
Blue Prints

Reflex De Luxe

Three Tube Receiver
Full Details for Assembly
Blue Prints
Tuning Instructions
How to Make a Loop Aerial De Luxe

Flewelling

Three Tube Receiver
Detector and Two Stage
Audio Frequency Amplifier
Assembly Details
Tuning Instructions
Blue Prints

Neutrodyne

Five Tube Receiver
Full Assembly Details
Blue Prints
Tuning Instructions

Send Only Money Orders. No Checks or Stamps.
Coins at Your Own Risk.

RADIO DIGEST PUBLICATIONS
123 West Madison St., Chicago

RADIO DIGEST PUBLICATIONS
123 West Madison Street, Chicago, Ill.
Check Books Desired

- Reflex De Luxe.....5 c
- Miloplex50c
- Reinartz50c
- Flewelling5 c
- Neutrodyne5 c

I am enclosing M. O. for \$

Name
Address
City Statc.....

Automatic Electric Headsets



\$10.00
VALUE
\$3.65

Complete Parts for Erla Single Tube Reflex

Consisting of	Our Price
1 Variocoupler	\$3.45
23-Plate Variable Condenser	1.45
2 Erla Sockets	1.30
1 Erla Reflex No. 1 Transformer	4.45
1 Erla A. F. Transformer	4.85
1 Erla .002 Mica Condenser	.30
1 Erla .001 Mica Condenser	.30
1 Erla .0025 Mica Condenser	.25
1 Erla Fixed Crystal Detector	1.00
1 Howard Rheostat	1.00
2 Bakelite Dials	.50
8 Binding Posts	.40
1 Dozen Switch Points and 4 Stops	.30
2 Switch Levers	.50
1 6"x14x1/2 in. Formica Panel	1.37

Our Price **\$20.90**

Complete parts for 2-Stage Amplifier

To amplify Ultra-Audion, Reinartz, Flewelling, Knocked-Down Short-Wave Receiver, Crystal or any receiving set so that loud speaker or phonograph can be used in place of headset.

Reg. Price	Consisting of	Our Price
\$1.05	7x9 Formica Panel (other suitable size)	\$.95
4.75	High Ratio All-American or Thordarson Transformer	3.95
4.50	Low-Ratio All-American or Thordarson Transformer	3.95
2.20	2 Howard Rheostats	2.00
2.00	2 Bakelite Sockets	.90
3.00	3 Double Patent Jacks	1.50
1.30	13 Binding Posts	.65
.30	Baseboard	.15

\$21.00 Our Price **\$12.95**
Value Price

Complete parts for Wave Trap

Consisting of	Our Price
6x6 1/2 Mission Finished Oak Cabinet	\$.95
6x6 1/2 Formica Panel Drilled and Engraved	.50
Specially Wound Wave Trap Coil	1.95
23-Plate Variable Condenser	1.35
Bakelite Dial	.25
4 Binding Posts	.20
Construction Sheet FREE	
Very Special	\$5.25

Complete Parts for 1 & 3 Tube REINARTZ

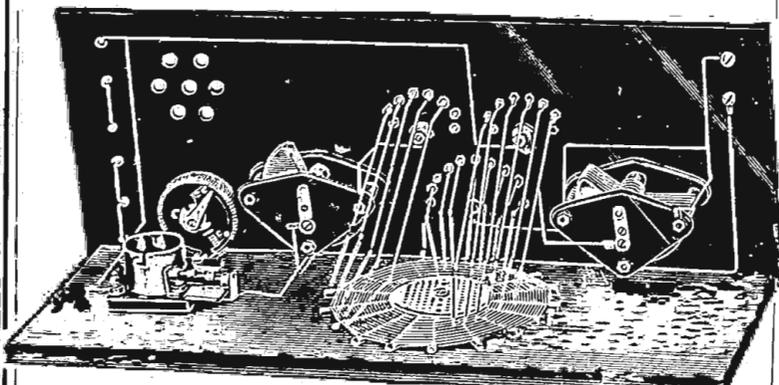

Complete Parts for Regular

Price	Consisting of	Our Price
\$1.89	7x18 Formica Panel	\$1.70
1.00	Bakelite Socket	.45
1.50	Howard Ver. Rheostat	1.35
3.30	23-Plate Var. Condenser	1.45
3.10	11-Plate Var. Condenser	1.35
1.50	3 Switch Levers	.75
.80	2 Dozen Switch Points	.40
3.09	1 Schoonhoven Reinartz Coil	1.95

MAIL ORDERS

Address
DEPT. D-6
Chicago, Ill.



MAIL ORDERS

Address
DEPT. D-6
Chicago, Ill.

RADIO

Where Shall I Buy My Radio Parts?

Let us help answer that question for you once and for all—or rather let the 5,000 or more radio fans that come to our store daily help you decide. Ask any of them why they always come to the world's greatest radio store for all their radio needs, and they will give you these three mighty good reasons:

SALVAGE Means SAVE SERVICE SATISFACTION

When you buy radio parts from the Chicago Salvage Stock Store, you can be sure of these three things:

1. You will save money through the hundreds of Radio bargains made possible by an enormous buying power.
2. You will be served intelligently by men who are qualified Radio experts.
3. Nothing but genuine brand new quality apparatus will be offered to you—guaranteed to give you complete satisfaction.

Complete Parts for 1 & 3 Tube

COCKADAY

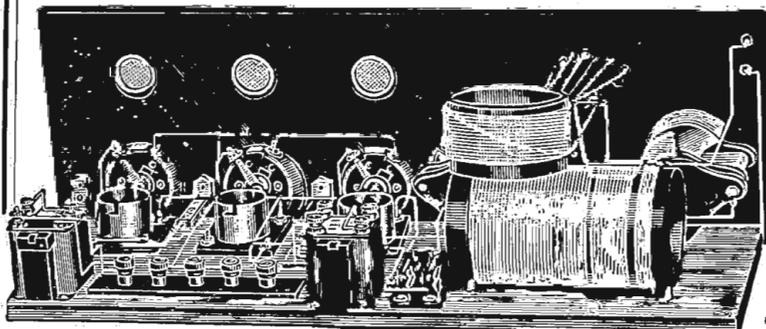

Complete Parts for 3 & 5 Tube NEUTRODYNE

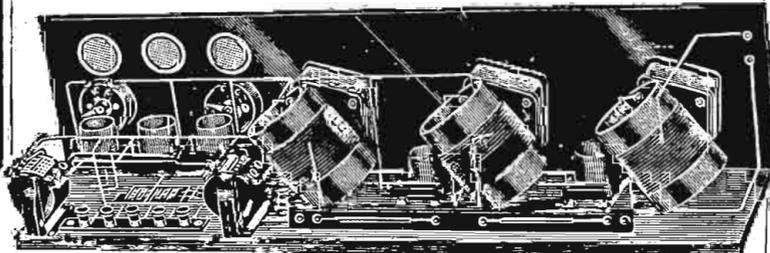

For best Neutrodyne results experienced amateurs and fans invariably use genuine FREED-EISEMAN or FADA licensed parts. Follow their example, be assured of satisfaction by looking for the FREED-EISEMAN or FADA label on every Neutroformer, Neutrodon, etc., that you buy.

Parts for 5-Tube Set:

7x28x7/8 drilled and engraved panel with baseboard	
2 Audio Frequency Transformers	
3 Erla Bezels	
1 .001 Mica Condenser	
1 I. M. F. D. By-Pass Condenser	
3 Filament Control Jacks	
3 4-Inch Dials	
1 Howard Vernier Rheostat	
1 Howard Plain Rheostat	
Strip of Bakelite	
8 Binding Posts	
2 Firth Sockets	
1 3-Gang Firth Socket with mounting and screws	
20 feet Bus Bar Wire	
Screws, nuts, and miscellaneous set	
Construction Book and Schematic Print	
Grid Leak and Mica Condenser	
3-Tube Set	\$28.60
5-Tube Set	\$46.25

Radiola CRYSTAL SET

Complete with Murdoch Phones \$9.45

Completely Made-Up 2-STEP AMPLIFIER

(Without Cabinet)
A Regular \$30.00 value \$16.50

Build Those Sets—NOW!

Save Money by Our Special Prices on Complete Parts for ALL Receivers

No matter what Receiver you want to build, our special prices on complete parts will save you money. You'll build a better set with them, too! Our parts for sets are carefully chosen and tested—GUARANTEED to give the best results!

Important

Any individual part (except the drilled panels, in any of the four outfits here) may be purchased separately at the special reduced prices listed under column headed "Our Price."

PANELS DRILLED

Specially drilled panels are included with each outfit. No additional charge for drilling.

COMPLETE INSTRUCTIONS

For assembling, and blue-prints for wiring are included with each outfit. Instructions written so everyone can understand them. No special skill or technical knowledge required—a few hours and you're ready to tune-in New York, Los Angeles—any of 'em.

Parts for 3 Tube Set:

	Our Price
7x21x7/8 Drilled Panel and Baseboard	\$2.94
1 Complete Cockaday Coil	1.95
Comsco 26-Plate Vernier Condensers with Dials and Vernier Knobs	6.90
2 Standard Audio-Frequency Transformers	8.00
1 Howard Vernier Rheostat	1.35
2 Howard 25-Ohm Rheostats	2.00
3 Firth Sockets	1.35
Switch Lever	.25
7 Points, 2 Stop and 8 Binding Posts	.55
Binding Post Strip	.05
2 Patent Double Circuit Jacks	1.00
1 Patent Single Circuit Jack	.35
3 Erla Bezels	.45
20 feet Bus Bar Wire and miscellaneous screws, nuts, etc.	.25
Schematic Blueprint	.50
Grid Leak and Mica Condenser	.65
1-Tube Set	\$11.95
3-Tube Set	\$27.95

LOUD SPEAKER

With Genuine Nathaniel Baldwin Unit
Special at \$10.00

Genuine World Seal Phones

Sold the World Over for \$8.00 \$3.65

Western Electric

VT-2 Tubes \$7.45

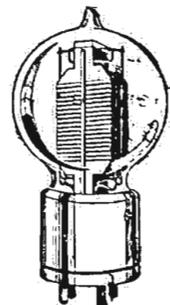

All other Tubes at Reduced Prices

Complete Parts for

Herald and Examiner Set, at	\$ 5.95
Honeycomb Receiver	17.95
Ultra Audion at	8.95
Overland Circuit, at	8.25
Haynes DX, at	9.95
Superdyne Receiver, at	15.85
Long-45 Circuit, at	16.25

AMRAD UNITS

Consisting of Detectors, Variometers and Couplers
Values up to \$25.00 \$4.95

DAYFAN VARIOMETERS or VARIOCOUPERS

\$5.45

Thordarson Rectifying Transformers



Regular light-circuit storage battery charger complete, with Tungar bulb.

Very Special \$9.95

Simple Explanation of Radio for Everybody

(Continued from page 11)
possibilities and this is the status of all circuits when first brought out.

Three Stages of Radio Frequency

This circuit, which we will call the "IXP" from its designer's call letters,

lated, while C_3 is also mica, but only .0005. The grid leaks are very important, that on first tube being capable of adjustment as low as 10,000 ohms. It will be found that, once the grid leaks have been adjusted so that oscillations do not occur at any setting of the dials, most

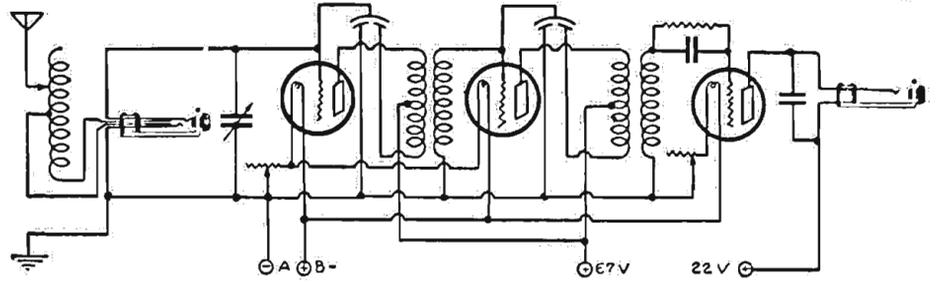

Figure 97—In this system of R.F. amplification the tubes are prevented from oscillating by splitting the primaries of the transformers and introducing small condensers.

and each unit should be tuned. The small condensers between the grid and plate of each R.F. tube require but little adjusting and are for neutralizing the inherent capacity of the tubes that is the cause of oscillations. This leaves but three adjustments in tuning, namely, the variable condenser and the two transformers. It should be mentioned that these transformers are of a most unusual type, and the

comb or other coil that can be varied in its relation to the feedback coil, which is also of 50 turns. The plate coil of the second tube is a 50-turn coil; all three variable condensers are .001-mfd. capacity. Both of the fixed grid condensers shown are .00025-mfd.; the first grid leak will probably be about 2 megohms and the second about half that. Both should be variable. It has been suggested for any

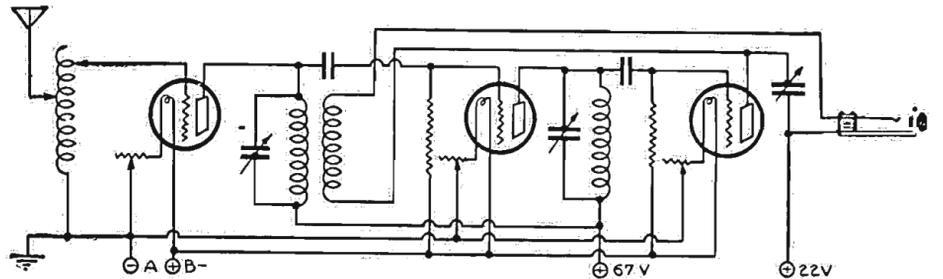

Figure 98—An English circuit in which regeneration includes not only the detector but a step of R.F. amplification as well.

ordinary variocoupler or adapted variometer would not give good results.

The English amateurs and experimenters having been limited for many years to reception only, have naturally developed receiving sets to extreme sensitivity. In the matter of receivers, they surpass us to some extent. An excellent English hook-up is shown in Figure 98, including not only detector tube but also one stage of R.F. amplification. To adapt this to American equipment it would probably be necessary to insert neutralizing condensers across the grids and try several other well-known methods of preventing uncontrolled oscillations. The inductance in the plate of the first tube is a 50-turn honey-

type of R.F. amplification—and the writer would certainly advise it on this set—that three sets of B battery be employed; 67 volts on the R.F. amplifying tubes (three batteries), a separate battery of 22 volts on the detector, and 90 volts (four more batteries) on the audio frequency amplifiers. Eight B batteries may seem a rather heavy initial investment, but it will be found that the detector B will last more than three times as long as it would if used for triple duty, while each of the others performs far more than twice as long as it would if employed in the usual hook-up.

(TO BE CONCLUDED.)

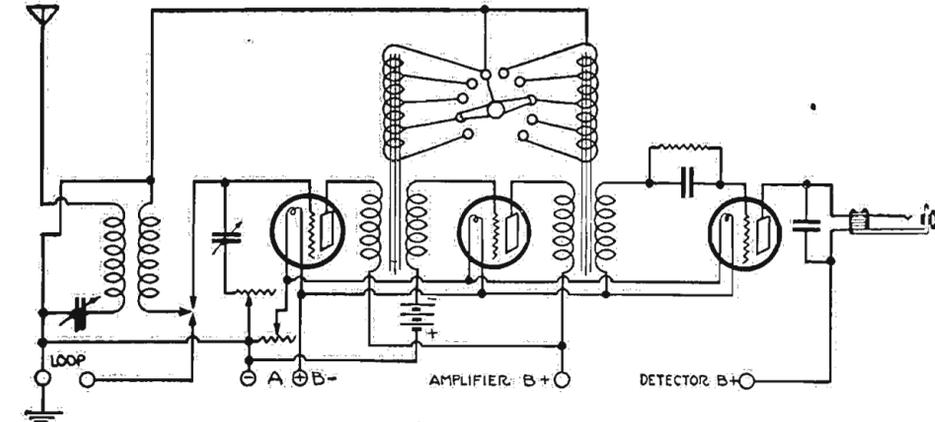

Figure 95—This hook-up enables one to shift the "peak efficiency" of the R.F. transformers to any frequency.

contains three stages of variometer-coupled, tuned Radio frequency. There is no need for a double circuit tuner, as the selectivity is remarkable and without re-radiation. The inductance L_1 consists of a tapped inductance, either 60 turns on a 4-inch tube tapped every 10 turns, or one of the new basket-weave type. Condenser C_1 is .0005-mfd. The variometers L_2

stations will be heard in the first third of the first variometer's rotation, in the middle third of the second variometer's arc, and in the last half of the third variometer's rotation. Properly made of good parts, this set should be surpassed only by a good super-heterodyne.

Condensers between Grid and Plate

An interesting set was brought out

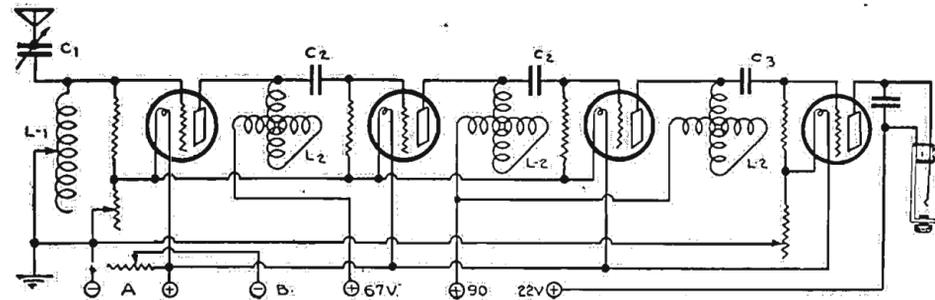

Figure 96—Another type of tuned impedance R.F. amplification designed by Leon Bishop, IXP.

should cover the 200 to 600-meter range and be wound to contain air cells and of basket winding.

some months ago, utilizing the circuit shown in Figure 97. The coupling units between the tubes have variable coupling between the primaries and secondaries,

Condensers C_2 are .001-mfd. mica insu-

SUPER VALUES

WHAT'S NEW IN RADIO?

Hazeltines Neutrodyne

The ultimate receiver for local and long distance Radio concert reception

THE MOST TALKED ABOUT SET OF TODAY

1. SIMPLICITY (A child can operate it)
2. SELECTIVITY (You can tune out local stations)
3. STABILITY (Always ready to entertain)
4. DISTANCE (Average range about 2000 miles)
5. NOISELESS (No squeals, no howls, no whistles)

Complete Parts for Building This Master Receiver **\$49⁶⁵**
AS LISTED BELOW, ONLY

Stock No.	Quantity	Description	Price
201 A.	1	Bakelite panel, 24x7x3/8, drilled and engraved.....	\$ 6.50
202 A.	1	Baseboard, 23x6.....	.75
203 A.	5	Standard sockets.....	1.95
204 A.	3	Neutroformers.....	15.00
205 A.	2	Neutrodons.....	1.50
206 A.	2	High ratio transformers.....	11.10
207 A.	1	A battery switch.....	.75
208 A.	3	4" Pathe dials, taper knob.....	2.10
209 A.	1	Plain rheostat.....	1.00
210 A.	1	Fada type 150 A. vernier rheostat	1.25
211 A.	7	Eby engraved binding posts.....	1.40
212 A.	1	Closed circuit Jack.....	\$ 0.80
213 A.	1	3 spring automatic Jack.....	1.00
214 A.	27 ft.	Spaghetti tubing.....	2.10
215 A.	27 ft.	Bus bar.....	.25
216 A.	2	Condensers, .006 mfd.....	1.00
217 A.	1	Grid leak, 2 megohms.....	.50
218 A.	1	Grid leak and condenser, .00025	.60
219 A.	1	Package screws, nuts, terminals, etc.	.10
220 A.	1	Fada instruction book.....	49.65

Accessories Necessary to Complete Set for Operation

Stock No.	Quantity	Description	Price
221 A.	5	Bonded tubes.....	\$22.00
222 A.	1	Loud speaker, genuine Baldwin type C unit.....	12.75
223 A.	4	Columbia or Red Seal A battery	1.60
224 A.	2	45 volt B batteries.....	\$ 9.00
225 A.	1	Set complete aerial equipment..	2.00

OUR SPECIAL COMBINATION OFFER

To each purchaser of the parts and accessories for the HAZELTINE NEUTRODYNE RECEIVER at the low price of \$97.00 we will, without cost to you, ship a Genuine HANES-ZENER special hand rubbed solid mahogany cabinet. Value \$10.00. Each of the above parts are of the highest standard grade, and carry the HANES-ZENER guarantee and can be purchased separately at our special prices.

RESISTANCES—Genuine P. L. Original Lavite
48,000 OHMS.....\$1.00 100,000 OHMS.....\$1.00

We Are Prepared to Supply Dealers. Write for Our Proposition.

REINARTZ CIRCUIT Complete

	List Price	OUR Price		List Price	OUR Price
Reinartz Coll.....	\$2.50	\$2.00	3 Switch Levers with Knobs.....	\$0.75	\$0.35
One 7x10x3/8 Radlon Panel.....	1.25	1.00	One Baseboard for Mounting.....	.75	.40
National Bakelite Socket.....	1.00	.40	One Fixed Phone Condenser.....	.40	.25
Vernier Rheostat.....	1.50	1.00	One Single Jack.....	1.00	.25
Two 23 Pl. Var. Condensers at \$3 each.....	6.00	3.00	Blue Prints with complete instructions for assembly and mounting.....	.50	.50
Switch Points and Nuts.....	.80	.40			
Six Switch Stop Points and Nuts.....	.40	.20			
Freshman Grid Leak and Condenser.....	1.00	.65			
Seven Binding Posts.....	.70	.35			
25 Ft. Tinned Bus Bar.....	.50	.30			
			Regular Price.....	\$19.05	

OUR PRICE \$11.05

All the necessary screws, nuts and miscellaneous small parts which are necessary to complete the set are included in the above prices. Any part in either of these circuits may be purchased independently at the advertised cut prices.

Cockaday Four-Circuit Receiver 3000 MILES

Parts as specified by Mr. Cockaday

- | | |
|------------------------------------|----------------------------------------|
| 1—Cockaday Coil | 1—Como Push-Pull Transformer—Output |
| 2—Amsco 26-Plate Condensers | 2—Switch Levers |
| 2—Amplex Grid-Condensers | 11—Switch Points |
| 1—Bradley Leak, 1/2 to 10 meg. | 2—Switch Stops |
| 5—Melco Sockets | 1—Dubilier Condenser—.0005 |
| 1—Amsco 6 ohm Rheostat | 1—Dubilier Condenser—.00025 with Mount |
| 3—Amsco 20 ohm Rheostats | 1—Durham Variable Grid Leak |
| 1—Pacnet Single Jack | 3—Lavite Resistances—48,000 ohms |
| 2—Pacnet Double Jacks | 1—Amsco 400 ohm Potentiometer |
| 2—Amertran Transformers | 1—7x24 Panel |
| 1—Como Push-Pull Transformer—Input | 1—3"x2 1/4" Sub Panel |
| | 1—12"x12" Panel |

Our Price **\$59⁰⁰**

We Have Just Received a New Shipment of **THE NEW MODEL D. N. K. & K. PHONES** Our Price **\$6.50**
MADE IN GERMANY

WE GIVE A 20% DISCOUNT on All Standard Radio Apparatus Not Listed Above

WRITE FOR OUR CATALOG "B"

All Mail Orders Shipped Promptly
Send Money Order, Including Postage



1480 Broadway, Corner 42nd St., New York City

The Radio Mail Order House—Known for Low Prices

AN EVENING AT HOME WITH THE LISTENER IN (SEE INSTRUCTIONS FOR USE BELOW)

Table with columns: Station and City, Met., Monday, Tuesday, Wednesday, Thursday, Friday, Saturday, Sunday. Lists various radio stations and their broadcast times.

Instructions for Use.—All the hours above are given in Central Standard Time. If your city uses Eastern Time, add one hour to each of the periods stated; if your city uses Mountain Time, subtract one hour; if your city uses Pacific Time, subtract two hours. This table includes only the evening broadcasts, and, on Sunday, the late afternoon program.

BRINGS IN EVERYTHING

BEAUTIFUL MAHOGANY NEUTRODYNE

When you get this magnificent looking set wired and hooked up, you will be able to hear all stations without interference. All parts are same as illustrated in Radio Digest, Feb. 2nd. Panel is mahogany with beautiful mahogany dials—a set fitted for the most exclusive home.

Panel drilled, all parts mounted on panel and baseboard ready for wiring. PAY NO MONEY Just Pay the Postman

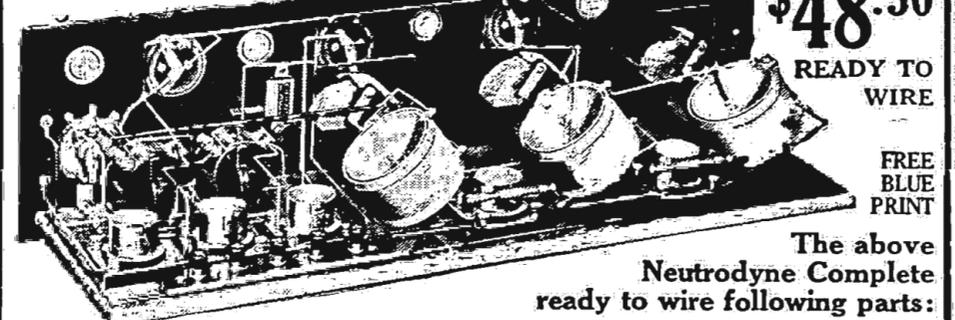

Only \$48.50

READY TO WIRE

FREE BLUE PRINT

The above Neutrodyne Complete ready to wire following parts:

- 5 Genuine DX Tron Tubes... \$25.00
1 110 Ampere Storage Battery... 18.00
1 Deluxe Homecharger... 18.00
1 Genuine Baldwin Headset... 12.00
1 Complete Aerial Equipment... 1.50
1 45 Volt B Battery... 5.50
2 2 1/2 Volt B Batteries... \$ 6.00
1 Fultone Loud Speaker... \$36.00
TOTAL... \$95.50

The above parts and equipment complete would cost you \$144.00! Our Price \$125.00

It Works—NEUTRODYNE—All Standard Parts

- 3 Rheostats, 30 ohms... \$ 2.00
1 Rheostat, 6 ohms... .90
3 Air Core R. F. Transformers... 20.00
1 Potentiometer, 600 ohms... 1.85
3 Jacks... 2.70
1 Condenser... .40
1 Grid Leak... .65
5 Sockets... 5.00
2 Transformers... \$ 9.50
9 Readem Binding Posts... .85
1 8x28 Mahogany Panel... 3.64
4 Bezels... .80
3 Dials... 4.50
1 Baseboard... .50
24 ft. Square Brass Bus Wire... .60
Total... \$53.89

Only \$45.50 with blue prints FREE

Limited Supply BALDWIN PHONES

Genuine Baldwin double head phone receivers with head band complete, list price, \$12.00. \$6.25 Special as they last, only NOT MORE THAN TWO TO EACH CUSTOMER

A Few Left—BALDWIN UNITS

Genuine Baldwin Type C unit with mica diaphragm, list, \$6.00. Only \$3.19 ONLY TWO TO A CUSTOMER

Special Sale on Webster Condensers, None Better Made

Variable Condenser, .0005 (Same as 23 plate) \$2.98 Variable Condenser, .001 (Same as 45 plate) list, \$5.50. While they last—Bargain at \$2.98 list, \$6.00. Big buy at \$2.98

SALE OF FINE CABINETS—High Mahogany Finish

9x14x8 with baseboard. List, \$12.00... \$5.98 7x16x8 with baseboard. List, \$12.00... \$5.98

We Are Responsible Folks, Money Promptly and Cheerfully Refunded If You Are Not Satisfied All Orders Mailed Promptly. Parcel Post Prepaid on \$5.00 or Over. No Stamps Accepted.

Everything in Radio Write Us

Quality Merchandise at Low Prices Economical Radio House 4600 LINCOLN AVENUE, CHICAGO

We Personally Guarantee All Goods

Scientific Lecture for "Bugs"

CHICAGO.—The Chicago Radio Traffic association, an organization which governs Chicago amateurs, has adopted a plan whereby scientific entertainment will be

provided for members and guests at the bi-monthly meetings. Various Radio engineers will address the association on the first and third Thursday of every month. Only licensed amateurs may be members of the association.



Save on Guaranteed Radio Equipment

Write us a post card—Address Dept. 41-R

and we will send you free this 52 page catalogue of radio sets and parts. It also contains explanation of radio terms, map and list of broadcasting stations and much radio information, including an explanation of successful hook-ups and circuits.

You will be amazed at the low prices Ward's quote. A complete tube set having a range of 500 miles and more, including tube, head set, batteries, and antenna equipment, as low as \$23.50.

This catalogue contains everything for the expert and amateur. Complete sets and every improved part for building sets, all the most up-to-date devices—at the lowest possible prices.

Headquarters for Radio

Montgomery Ward & Co. is headquarters for Radio, selling everything direct by mail without the usual "Radio-profits." Why pay higher prices? Ward quality is the best and the prices will often save you one-third. Everything sold under our Fifty Year Old Guarantee—Your Money Back if You Are Not Satisfied. Write today for your copy of this complete 52-page Radio Book.

Write to our house nearest you Address Dept. 41-R

Chicago Kansas City St. Paul Portland, Ore. Ft. Worth Oakland, Cal.

This Radio Catalogue FREE

Montgomery Ward & Co. Established 1872 The Oldest Mail Order House is Today the Most Progressive

PROTECT YOURSELF

Use Instruments Experts Recommend THE ORIGINAL AUTOMATIC



BULL DOG GRIP TELEPHONE PLUG

(Licensed under Pat. Pend. Serial No. D 3010—No. 578540)

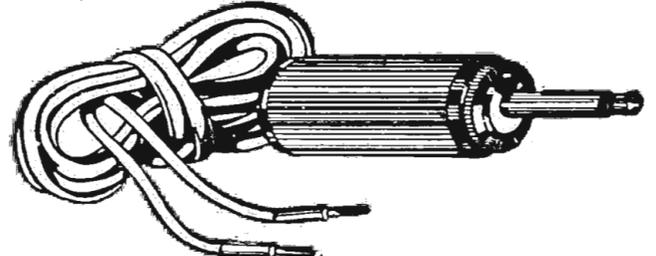

WE GUARANTEE

that this plug will not demagnetize your phones, ruin your transformers, short circuit your batteries, have battery kicks or break your finger nails. The COMSCO PLUG is the last link in perfect reception. At a small cost it is the final refinement for your set.

For One Pair Phones... \$1.00 For Two Pair Phones... 1.50

YOU CAN DEPEND ON THE COMSCO PLUG IT'S MADE BY THE MAKERS OF

COMSCO CONDENSERS

THE MOST INGENIOUS VARIABLE AIR CONDENSER EVER CONCEIVED. NO OUTSIDE SPRING CONNECTIONS—TRUE CAPACITIES.

AND BRONZE BUSHINGS FOR PERMANENT CONTACT

ASK FOR COMSCO AT YOUR DEALER

Otherwise send purchase price direct to us and you will be supplied

GENERAL INSTRUMENT CORP.

123 Liberty Street NEW YORK CITY



"OUR MARY" SINGS ON PACIFIC COAST

Tuesday, March 4

CKAC, Montreal, Can. (Eastern, 425), 4:00 p. m., Music; 7:00, Kiddies stories in French and English; 7:30, Mt. Royal Hotel Concert Orchestra; Rex Battie, director; 8:30, French vocal selections, Raoul Venant, director; 10:30, Dance program, Mt. Royal Hotel.

KDKA, E. Pittsburgh, Pa. (Eastern, 326), 6:15 p. m., Dinner concert, Grand Symphony Orchestra; 7:15, "Men and Management," F. K. Singer; 7:30, Children's period; 8:15, "The Autobiography of Benjamin Franklin," Dr. John Ray Ewers; 8:30, Concert, Bloomfield Liedertafel Singing Society; Helen Mangold, cornetist; Nicolas Cartus, tenor; Beatrice Roberts Macrelli, pianist; Mrs. Agnes Vogel Roberts, soprano; John Faumburger, reader; 10:00, Barn dance, National Stockman and Farmer; 11:30, Concert, Queen City Orchestra.

KFI, Los Angeles, Calif. (Pacific, 469), 6:45-7:30 p. m., Concert, George J. Birkel Music Co.; 8:00-9:00, Concert by Ambassador-Lyman's Coconut Grove Orchestra; 9:00-10:00, Examier Concert; 10:00-11:00, Concert by Sol Cohen, violinist and associates.

KFKX, Hastings, Neb. (Central, 341), Rebroadcasts program of KDKA.

KFSG, Los Angeles, Calif. (Pacific, 278), 3:30-4:30 p. m., Musical program; 7:00-7:30, Children's hour, Bible story by Mother Kennedy; 8:00-9:30, Musical program. Evening service by Aimee Semple McPherson.

KGO, Oakland, Calif. (Pacific, 312), 8:00 p. m., "The Hottentot" KGO Players; KGO Orchestra.

KGW, Portland, Ore. (Pacific, 492), 12:30 p. m., Concert, Clivio Music Club of Portland; 3:30, Talk, Jeanette P. Cramer; 7:45, Talk for farmers.

KHJ, Los Angeles, Calif. (Pacific, 395), 12:30-1:15 p. m., Concert; 2:30-3:30, Matinee Musicale through courtesy of Southern California Music Co.; Mrs. John E. Loomis, mezzo-soprano; 6:45-7:30, Children's program featuring the weekly visit of the "Sandman" and "Queen Titania"; Charles Bradt, Robert Spaeth, saxophonists. Bedtime story by "Uncle John"; 8:00-10:00, Program presented by Studebaker Six of Long Beach, Calif., Leo A. McGuire, Irish songster;

Headliners of the Week

KHJ IS again proud to announce that Mary Garden, the "Our Mary" of Chicago, will sing over their microphone today. This is the prima donna's second Radio appearance in the West. The drama is becoming so much a part of the Radio program that KGO the new Oakland Station is putting on the three-act play called "The Hottentot" this same evening. WJAX will broadcast the first act of "Vanities of 1924" in which that famous vamp Peggy Joyce appears. This is in fact her own production. It is too bad that Radio cannot as yet reproduce and that we did not have time to publish the picture of the beautiful girls in the Snow Chorus of this show. Irene Richard, Amy Frank, John Byam, and Joe Cook are other well known folks who will entertain you.

Those of you who have not as yet heard Anton Lang, the Christus of the famous Oberammergau Players, will have another chance over KDKA Wednesday. This modest actor of a small German village has become during his American tour a well known Radio artist.

Here is just a little tip. If you want to get rich quick, get WOC this same night. They are scheduled for a lecture on how to make diamonds.

If being decorated by a king can be heard over the ether, Capt. Kilroy Harris' voice ought to sound extremely decorated. This famous hero who will give a travel talk for WJAX Thursday was decorated four times by King George of England for bravery in action during the World War.

Friday the students and faculty of the Synodical College will give a musical program over WOS. Look below and see if you do not think it worth your while listening in to.

Saturday you may travel with Wirt Barnitz through Belgium, and while this will be more peaceful than your travels in Switzerland and the Far North with him, it promises to be humorous and amusing.

Monday the student Orchestra and Glee Clubs of the Rensselaer Polytechnic Institute expect via WIAZ to reach Europe and other foreign lands.

Deliverly," WLAG Players; 5:30-6:00, Children's stories, Macalester College Girls; 6:00-6:15, "Fishing," W. C. Vogt; 6:15-7:00, Dinner hour concert, Minneapolis Athletic Club Orchestra; 7:30-8:15, "Yellowstone National Park," E. H. Hawley; "Medium Red Clover," C. A. Burdham; "Minnesota Cannery and Canned Food Week," Carey Emerson.

WLW, Cincinnati, Ohio (Central, 309), 4:00 p. m., Topics of interest to women; 6:00-6:15, "Fishing," W. C. Vogt; 6:15-7:00, Dinner hour concert, Minneapolis Athletic Club Orchestra; 7:30-8:15, "Yellowstone National Park," E. H. Hawley; "Medium Red Clover," C. A. Burdham; "Minnesota Cannery and Canned Food Week," Carey Emerson.

WMAQ, Chicago, Ill. (Central, 447.5), 1:00 p. m., Lyon & Healy program; 4:20, Items of Interest to women; 4:30, Glenn Dillard Gunn School of Music; 5:00, Weekly child life talk for children, Marjorie Burruss; 7:00, Travel talk, Clara E. Lauhill; 7:30, Literary Association debate; 8:00, Harry Harris, literary editor of the News; 8:10, LaSalle Orchestra; 9:00, American Institute of Banking banquet.

WMC, Memphis, Tenn. (Central, 500), 8:00 p. m., Apollo Club; 11:00, Frolic by Britling Orchestra; Prof. Chin Chin, director.

WOAW, Omaha, Neb. (Central, 526), 6:30 p. m., Dinner program, The Original Music Masters, Felerman and Havlicek, leaders; 9:00, Program, Frank Marsh, director; Helen War, violinist; Hazel Leaverton, accompanist; Mrs. Mabel Reed, violinist; Gladys Furness, violinist; Dorothy Minturn, contralto; Alice Horn, violinist; Violin quartet; Edward Kutilek, violinist; William Kutilek, violinist; Male quartet, Fanny Flah, violinist; Clara Schneider, violinist; Harry Robinson, violinist; Dan Hurley, flutist; Mrs. E. F. Moriarty, pianist; Eleanor O'Toole, soprano.

WOC, Davenport, Iowa (Central, 484), 12:00 p. m., Chimes; 3:30 p. m., "Appendicitis," A. G. Hinrichs, 5:45, Chimes.

WOO, Philadelphia, Pa. (Eastern, 509), 11:00 a. m., Organ recital, Mary E. Vogt; 12:02 p. m., Wanamaker's Crystal Tea Room Orchestra; Robert E. Golden, director; 4:45, Organ recital, Mary E. Vogt; 5:00, sports results and police reports.

WOR, Newark, N. J. (Eastern, 405), 2:30-2:45 p. m., Recital by Gene Savage Trimble, mezzo-contralto;



Miss Kathleen Havlin, above, of St. Louis, Missouri, is the first alto of the Synodical College's girls' quartette of Fulton.

The four girls presented on this page compose the Fulton, Missouri, Synodical College's girls' quartette, which will appear on the program from WOS on Friday, March 7, at 8:00 p. m. (Central Standard time).

To the left, above, and in the circle, the remaining members of the quartette are, in the order given, Miss Lorraine Hinde, second alto; Miss Frances Bentley, second soprano, and Miss Frances Harrison, soprano.

Mary Garden, prima donna; 10:00-12:00, Art Hickman's Orchestra.

KPO, San Francisco, Calif. (Pacific, 423), 12:00 m., Reading of the Scriptures; 1:00-2:00 p. m., Rudy Seiger's Fairmont Hotel Orchestra; 2:30-3:30, Theodore J. Irwin, organist; 4:30-5:30, Rudy Seiger's Fairmont Hotel Orchestra; 5:30-6:30, Children's hour, stories for children by "Big Brother" of KPO, Book of Knowledge; 7:00-8:00, Rudy Seiger's Fairmont Hotel Orchestra; 10:00-11:00, E. Max Bradford's Palace Hotel Dance Orchestra.

KSD, St. Louis, Mo. (Central, 546), 8:00 p. m., Banquet of the American Electric Railway Association.

KYW, Chicago, Ill. (Central, 536), 11:35 a. m., Table talk, Mrs. Anna J. Peterson; 2:35-3:30, Studio program; 6:50, Children's bedtime story; 7:00-7:30, Dinner concert, Joska DeBabary and his orchestra; Clyde Doerr and his orchestra; 8:01, Special program; 8:20-8:48, American Farm Bureau Federation program; 8:48-9:30, Chicago Musical College, D. Paul Bretwiser, director; 9:15, University of Illinois Concert Band.

WAAM, Newark, N. J. (Eastern, 363), 8:00-8:45 p. m., "Star Spangled Banner"—Orchestra of the Men's Community Bible Class of Roselle Park, N. J.; 8:45-9:00, "The Best Photoplays of the Year," Alice Belton Evans, secretary, National Committee for Better Films; 9:00-9:30, Memphis Synopators, offering "Thirty Minutes in Harmonyland"; 9:30-9:45, James Clark, pianist and Harmon Sherman, tenor, in popular numbers; 9:45-10:00, Humorous readings, Lucile Wilson, society entertainer; 10:00-10:15, Al Novins, tenor; Clinton Sommer, pianist; 10:15-10:30, Porter Grainger and his Three Rosebuds, recording artists in their classic "Blues" repertoire; 10:31-11:00, Continuation program by Orchestra of the Men's Community Bible Class of Roselle Park, N. J.

WBAP, Fort Worth, Texas (Central, 478), 7:30-8:30 p. m., Concert, talent from Commerce; 9:30-10:45, Concert, Orchestra of the First Christian Church.

WBZ, Springfield, Mass. (Eastern, 337), 7:00 p. m., "The Art of Investment," Donald McClench; 7:30, Bedtime story for the Kiddies; 7:40, Concert, Mrs. Tel. J. Bourassa, soprano; Mrs. V. P. Sevrault, soprano; Bernadette Bourbonnais, accompanist; 8:30, Story for Grown-ups, Orisou S. Marden.

WCAE, Pittsburgh, Pa. (Eastern, 462), 4:30 p. m., The Sunshine Girl; 6:30, Dinner concert, William Penn Hotel; 7:30, Uncle "Raybe" 7:45, Lew Kennedy, popular singer; Irene Setzler, pianist; 8:30, Musical program, Mrs. Rhea Northrop Sommerfeld.

WCAL, Northfield, Minn. (Central, 360), 9:45 a. m., St. Olaf College Chapel services; 11:00, "The Children's Feet," Julia H. Post; "Economy in purchasing Foods," Prof. Anna E. Drotning.

WDAF, Kansas City, Mo. (Central, 411), 3:30-4:30 p. m., Eddie Kuhn's Kansas City Athletic Club Orchestra; 6:00-7:00, School of the Air, Piano Tuning

in number on the Duo-Art; Address, E. O. Moffatt; Address, J. Frank Smith; Children's story and information period; Fritz Hauke's Trianon Ensemble Hotel Muehlebach; 11:45-1:00 a. m., Nighthawk frolic, The "Merry Old Chief" and the Coon-Sanders Novelty Singing Orchestra.

WDAP, Chicago, Ill. (Central, 360), 7:00-8:00, Drake Concert Ensemble and Blackstone String Quintet; 8:00-8:30, Barton Organ played by Ralph Emerson; 10:00 p. m., A. Hassell and Elmer Jacobs, two pianos, Rosemary Hughes, Fred W. Agard, Bob Cough, Voris Worthley, Jennie Donshowe Vinje, Jack Chapman's Orchestra.

WDR, Philadelphia, Pa. (Eastern, 395), 11:45 a. m., Daily Almanac; 10:02 p. m., Organ recital, Stanley Theater; dinner music, Arcadia Cafe Concert Orchestra; piano solos, Edna Finestone; 7:30, Bedtime stories, Uncle Jim; 7:50, Arnold Abbott's dramatic reviews.

WEAF, New York, N. Y. (Eastern, 492), 11:00 a. m., Board of Education; 11:15, N. Y. Tuberculosis Society; 11:30, Motion Picture Talk; 11:50, U. S. Dept. of Agriculture; 4:00 p. m., Esther Sager, pianist; 4:15, Thomas Keating, baritone; 4:30, Beatrice Godwin, soprano; 5:00, John Martin and Helen Avakio; 7:30, Thornton Fisher; 8:00, Eveready Trio; 8:30, Brooklyn Daily Eagle News Review; 9:00, Eveready Quartette; 9:30, Program by Columbia Phonograph Co.; 9:45, Lucille Nadler, pianist and Charlotte Nadler, violinist; 10:30, Mary Bennett, contralto.

WFAA, Dallas, Texas (Central, 476), 12:30-1:00 p. m., Address, DeVitt McLurray; 8:30-9:30, Mozart Choral Club, Earle D. Behrends, director; 11:00-12:00, Hawaiian song and instrumental music, Edith and Grace MacDowell.

WFI, Philadelphia, Pa. (Eastern, 395), 1:00 p. m., Meyer Davis Bellevue Stratford Concert Orchestra; 6:00, "Sunny Jim, the Kiddies' Pal"; 6:30, Meyer Davis Bellevue Stratford Orchestra; 10:10, Charlie Kerr's Symphonic Dance Orchestra.

WGI, Medford Hillside, Mass. (Eastern, 360), 12:00 m., Selections on the Ampico in the Chickering; Amrad Round Table; Selections on the Brunswick; 3:00 p. m., Amrad Women's Club program; 3:45, "Tuesday Tea Talk," David McGregor Cheney; 7:00, "Africa from Cape Town to the Congo," A. S. Flint; Amrad Big Brother Club Concert.

WGR, Buffalo, N. Y. (Eastern, 319), 12:30-1:00 p. m., George Albert Bouchard, organist; 2:30-4:00, The Radio Dealers' Orchestra; 4:00, Tea time music, Martha Gombh, harpist; Katherine Stang, violinist; 6:30-7:30, Vincent Lopez Hotel Statler Orchestra; 7:30, Digest of the day's news.

WGY, Schenectady, N. Y. (Eastern, 380), 2:00 p. m., "Beauty Resolutions for the Housewife"; 6:30, Instrumental Trio of Hotel Ten Eyck; 7:45, WGY Orchestra; Mrs. L. Garland Coons, soprano; "The Super-Heterodyne Receiver," R. H. Langley; Ruth M. Kingsbury, pianist; Alice Dutton, contralto; "Doc-

tor Trees Injured by Storm," U. S. Dept. of Agrl.

WHAA, Iowa City, Ia. (Central, 484), 8:00 p. m., University of Iowa, lecture, "Spring Birds," Prof. Dayton Stoner, ornithologist, music.

WHAS, Louisville, Ky. (Central, 400), 4:00-5:00 p. m., Strand Theater Orchestra; Alamo Theater organ; 7:30-9:00, Full concert, Mrs. Robert K. Van Pelt; Reading, An Interesting Historical Episode.

WHN, New York, N. Y. (Eastern, 360), 3:45-4:30 p. m., Bob Schaefer and his entertainers; 4:30-5:00, Leo Feist and his entertainers; 9:30-10:00, Fletcher Henderson's Alabam Club Orchestra; 10:00-10:10, Hon. Milton W. Sulton of National Security League; 10:10-10:15, Com. Conrad, composer; 10:15-10:45, Stanley Bernstein Music Co.; 10:45-11:15, Buddies Society Dance Orchestra; Morty Koenigsberg, leader; 11:15-11:30, George Blundon, baritone; 11:30-12:00, Bob Schaefer and his entertainers.

WIP, Philadelphia, Pa. (Eastern, 509), 1:00 p. m., Organ recital, Karl Bonawitz; 6:05, Dick Regau's WIP Symphony Orchestra; 7:00, Uncle Wip's bedtime stories; 8:00, Elliott Lester, WIP dramatic critic; 10:20, Ted Weem's Cafe L'Aiglon Orchestra.

WJAX, Cleveland, Ohio (Eastern, 390), Program arranged by the Cleveland News-Leader; 7:30 p. m., Bedtime story, E. G. Johnson; "Pa and Ma Jenkins," humorous reading, Edna K. Wooley; "Piano-log," Bud Cross; The first act of "Vanities of 1924," broadcast from the stage of the Ohio Theater.

WJAZ, Chicago, Ill. (Central, 448), 10:00 p. m.-1:00 a. m., Rudolph and Anton Wacek, zither solos and duets; Blanche Bond, pianist; Mrs. William DeWindt, contralto; Blanche Keyser, soprano; Orlole Orchestra.

WJY, New York, N. Y. (Eastern, 405), 7:30 p. m., Readings from Robert Bacon, "Life and Letters"; 7:50, William Meuzer, steel Guitarrist; 8:05, "Broadcasting Broadway," Bertha Brainerd; 8:20, "Human Nature in Advertising," Bruce Barton; 8:30, Pious New Orleans Orchestra; 9:30, Dinner in honor, Col. William Hayward.

WJZ, New York, N. Y. (Eastern, 455), 1:00 p. m., Hotel Ambassador Trio; 2:00, New York Board of Education Program, Dr. William J. O'Shea; 3:00, Afternoon Auditorium Concert, Wanamaker Auditorium; 4:00, Harper's Bazaar Fashion; 4:10, "Department of English," Prof. Howard R. Driggs; 4:45, Josephine Yellante, soprano; 5:00, "The Home Beautiful," Dorothy Ethel Walsh; 5:15, Josephine Yellante, soprano; 7:00, "Further Talk on Postage Stamps," E. B. Power; 7:15, Supper music, Paul Specht's Alamac Hotel Orchestra; 8:15, Tollefson Trio; 9:15, "Naval Radio," Admiral Samuel S. Robison; 10:30, Dance program, Hotel Astor Orchestra.

WLAG, Minneapolis-St. Paul, Minn. (Central, 417), 10:45-11:15 a. m., Household hints; 11:35-12:00 m., Surprise program; 2:00-2:30 p. m., Woman's Club, talk for league of women voters; 2:40-4:00, "The Late

3:30-3:45, Recital by Gene S. Trimble; 6:15-6:30, Music while you dine, by Halsey Miller and his orchestra; 6:30-7:00, Man in Moon Stories; 7:00-7:30, Music while you dine, by Halsey Miller and his orchestra.

WSB, Atlanta, Ga. (Central, 429), 12:00 m., Atlanta Federation of Musicians; 4:00-4:30 p. m., Howard Theater overture; 5:00-5:30, "Home Garden," William B. Decker; 5:30, Bonnie Barnhart's songs; Burgess bedtime story; 8:00-9:00, Atlanta Federation of Musicians; 10:45-11:45, Atlanta Federation of Musicians.

WWJ, Detroit, Mich. (Eastern, 517), 9:30 a. m., "Tonight's Dinner," Woman's Editor; 9:45, "Ironing Day," Fred Shaw; 3:00 p. m., Detroit News Orchestra; 7:00, Detroit News Orchestra; Thaddeus Wronski.

Wednesday, March 5

CKAC, Montreal, Can. (Eastern, 425), 1:45 p. m., Classic concert, Mt. Royal Hotel Concert Orchestra; 4:30, Dance program, Joseph C. Smith and his Mt. Royal Hotel Orchestra.

KDKA, E. Pittsburgh, Pa. (Eastern, 326), 6:15 p. m., Dinner concert, Pittsburgh Athletic Association, Gregorio Scalzo, conductor; 7:15, Anton Lang, "Christus" of the Passion Play presented in Oberammergau; 7:30, Children's period; 8:00, Address, Dr. Cora Helen Coolidge, president of the Pennsylvania College for Women; 8:15, "State Railways of Europe and Their Service," Charles Latus; 8:30, Concert, National Male Quartet, of the Redpath Chautauqua Bureau.

KFAE, Pullman, Wash. (Pacific, 330), 7:30 p. m., "The Fertility of Irrigated Soils," Prof. F. J. Sievers; "Household Budgets and Expenditures," Dean Florence Harrison; "Parts for Radio Receiving Sets and How to Use Them," Dean H. V. Carpenter; Vocal selections, E. W. Thorpe; College Revue Orchestra; "Boys and Girls' Clubs," Filmina White; "The Prevention of Acute Contagious Diseases," Dr. D. T. Ford.

KFI, Los Angeles, Calif. (Pacific, 469), 6:45-7:30 p. m., Detective stories by Detective Nick Harris; Concert; 8:00-9:00, Evening Herald concert; 9:00-10:00, Examiner concert; 10:00-11:00, Concert presented by the Hollywood Community Orchestra; 11:00-12:00, Concert by Ambassador-Lyman's Coconut Grove Orchestra.

KFKX, Hastings, Neb. (Central, 341), Rebroadcast program of KDKA.

(Continued on page 16)

PLAY ARTISTS ON AIR THIS WEEK



Below is another of Jimmy Clark's White Way entertainers, Nellie Curzon, contralto. She also will be on WOR's program on the same date.



Virgil B. Rochte, popular baritone, whom you may tune in on WOC on March 6 and 8.

6:15-6:30, Albert E. Som, Newark Sunday Call; 6:30-7:30, Tom Cooper's Country Club Orchestra.
WWJ, Detroit, Mich. (Eastern, 517), 9:30 a. m., "Tonight's Dinner." Woman's Editor; 3:00 p. m., Detroit News Orchestra; 7:00, Detroit News Orchestra; Carmen Chaussee, soprano; Rev. Augustus P. Record, speaker; Paul Smith, tenor; Grace W. Phillips, soprano; 10:00, Dance music, Jean Goldkette's Orchestra.

Friday, March 7

CKAC, Montreal, Can. (Eastern, 425), 1:45 p. m., Rex Battle and his Mt. Royal Hotel Concert Orchestra; 4:30, Dance program, Joseph C. Smith and his Mt. Royal Hotel Orchestra.
KDKA, E. Pittsburgh, Pa. (Eastern, 326), 6:15 p. m., Organ recital, Lucile Hale; 7:15, "The Beginning of the Monarchy," Dr. R. L. Lanning; 7:30, Children's period; 8:00, Radio Boy Scout Meeting; 8:30, Concert, Monessen Volunteer Firemen's Band; 10:30, Mass. Institute of Technology Meeting.
KFAE, Pullman, Wash. (Pacific, 330), 7:30 p. m., "Cost of Careless Spraying," Dr. A. L. Melander; "Ductless Glands: Their Relation to the Human Body," Clairmont Sickerman; vocal solos, Glade M. Burnett; William Just, violinist; Florence Carpenter, pianist; "Shelter for Swine," C. M. Hubbard; "Talk on New Books," Alice Lindsay Webb.
WFI, Los Angeles, Calif. (Pacific, 469), 6:45-7:30 p. m., Concert and Bedtime story; 8:00-9:00, Evening Herald Concert; 9:00-10:00, Examiner Concert; 10:00-11:00, Concert presented by Myra Belle Vickers; 11:00-12:00, Concert by the Ambassador-Lyman's Cocomat Grova Orchestra.
KFKX, Hastings, Neb. (Central, 341), Rebroadcast program of KDKA.
KFSG, Los Angeles, Calif. (Pacific, 278), 3:30-4:30 p. m., Special Musical program; Talk by Sister McPherson; 7:00-7:30, Children's program; International Sunday School lesson, Mother Kennedy; 8:00-9:30, Musical program and Revival service, Aimee Semple McPherson.
KGW, Portland, Ore. (Pacific, 492), 12:30 p. m., Concert; 3:30, "Texture and Pattern Effects," Esther E. Cooley; 8:00, Accordion solos, Johnny Sylvester; 8:15, Dance music, George Olsen's Metropolitan Orchestra; 9:00, Educational lecture, University of Oregon Extension Dept.; 10:30, Hoot Owls.
KHJ, Los Angeles, Calif. (Pacific, 395), 12:30-1:15 p. m., Concert; 2:30-3:30, Matinee Musicale, courtesy of Southern California Music Co.; 4:00-5:00, Children's program featuring Richard Headrick, screen juvenile; Bedtime story, "Uncle John"; 7:00-7:30, Organ recital from First M. E. Church, Arthur Blakeley, organist; 8:00-10:00, Program presented by the Kiwanis Club of Glendale, Calif.; "Early History of California," Walter P. McEneaney, lecturer.
KPO, San Francisco, Calif. (Pacific, 423), 1:00-2:00 p. m., Rudy Selger's Fairmont Hotel Orchestra; 2:30-3:30, Theodore J. Erwin, organist; 4:30-5:30, Rudy Selger's Fairmont Hotel Orchestra.
KYW, Chicago, Ill. (Central, 536), 11:35 a. m., Table talk, Mrs. A. J. Peterson; 6:50 p. m., Children's bedtime story; 7:00-7:30, Dinner concert, Joska DeBabary and his orchestra; Clyde Doerr and his orchestra; 10:00-12:00, Midnight revue.
WAAM, Omaha, Neb. (Central, 360), 8:00 p. m., Les-sons in Bridge, Mrs. Purdy.
WBAP, Fort Worth, Texas (Central, 476), 7:30-8:30 p. m., Concert, Texas Christian University, Prof. H. D. Guelick, director; 9:30-10:45, Concert, Blue Devil Band of the Howard Payne College.
WBZ, Springfield, Mass. (Eastern, 337), 6:00 p. m., Dinner concert, WBZ Orchestra; 7:00, "The Lost Mine," Youth's Companion; Current Book Review, R. A. MacDonald; 7:30, Bedtime story for the Kid-dies; 11:00, Chamber music, WBZ Orchestra; Francis Deane, soprano.
WCAE, Pittsburgh, Pa. (Eastern, 462), 4:30 p. m., The Sunshine Girl and Uncle "Kaybee"; 6:30, Dinner concert, William Penn Hotel; 7:30, Uncle "Kaybee"; 8:30, Musical program, Monaca Male Quartet.
WCAL, Northfield, Minn. (Central, 360), 9:45 a. m., St. Olaf College Chapel services; 8:30, Book talk, "Alfred Noyes and John Masefield: Two New Old-fashioned Poets," Dr. George Weida Spohn.
WDAF, Kansas City, Mo. (Central, 411), 3:30-4:30 p. m., Regular "request" program, Leo R. Davis; "Radio" Orchestra; 6:00-7:00, Piano tuning in number on the Duo-Art; Address, speaker from the Kansas City Children's Bureau; Address, Major M. G. Farris, children's story and information period; Fritz Hanlein's Trianon Ensemble; 8:00-9:15, Popular program, WDAF minstrels with Jack Riley's Plantation Serenaders; 11:45-1:00 a. m., Nighthawk frolic, The "Merry Old Chief" and the Coon-Sanders Novelty Singing Orchestra.
WDAP, Chicago (Central, 360), 7:00-8:30 p. m., Drake Concert Ensemble and Blackstone String Quintet; 10:00, Anna Burns, Pianist; Cambridge Sisters; Geo. R. Hill, Jr., Baritone; Barton Organ played by Ralph Emerson; Jack Chapman's Orchestra.
WDAR, Philadelphia, Pa. (Eastern, 395), 11:45 a. m., Daily almanac; 12:02 p. m., Organ recital, Stanley Theater; Arcadia Cafe Concert Orchestra; 2:00-2:30, Arcadia Cafe Concert Orchestra; 7:30 p. m., Uncle Jim's bedtime stories.
WJAZ, Chicago, Ill. (Central, 448), 10:00 p. m.-1:00 a. m., Colonial Serenaders; Schubert Vocal Quartet; Edmund Zygan, violinist; Oriole Orchestra.
WJY, New York, N. Y. (Eastern, 405), 7:30 p. m., Burr McIntosh, the Cheerful Philosopher; 7:50, Marion Christian, soprano; 8:05, "Golf," Innis Brown; 8:20, Marion Christian, soprano; 8:30, "Simp or Simpatico," Playlet; 9:00, Mayor Hylan's Peoples Concert; 10:00, Theresa Obermeyer, pianist.
WJZ, New York, N. Y. (Eastern, 455), 2:00 p. m., New York Board of Education program; 3:00, Afternoon Auditorium Concert; 4:00, Sam Wooding's Orchestra; 4:30, Readings, Mrs. E. A. Stewart; 5:00, Bernice Offen-berg, coloratura soprano; 7:00, "Jack Rabbit Stories," Uncle Dave Cory; 7:30, Union League Club Dinner, Navy League Club; U. S. Navy Band; Speakers, Gen-eral Robert Lee Bullard, Admiral Coontz, Admiral Robison, Admiral Plunkett, Admiral Wiley, Cap-tain Gleason; 10:30, Harold Stern and his Hotel Majestic Orchestra.
WLAG, Minneapolis-St. Paul, Minn. (Central, 417), 11:35-12:00 m., Surprise program; 2:00-2:30 p. m., Woman's club; Weekly dancing lesson, Tess Cooper-man; 2:40-4:00, Margarette Katerk; pianist; Maude McMurray, soprano; 4:00-4:30, Mildred Simons, reader; 5:30-6:00, Children's stories, Catherine Water-veid; 6:15-7:00, Minneapolis Athletic Club Orchestra; 7:30-8:15, Farm lectures; Special program, Capitol City Sportsman's Association.
WLW, Cincinnati, Ohio (Central, 309), 4:00 p. m., Adella Apple, pianist; 10:00, Special concert, Sigma Alpha Iota Sorority, Grace Record, Ruth Crumfue, Alicia Cheney; Radario in one act, Fay Bond, Roberta Maple, Helen Zeigler; Negro Spirituals, Blanche Neel; Marjorie Garrigus, pianist; Jolly Band; 11:00, Doherty's Melody Boys.
WMAQ, Chicago, Ill. (Central, 447.5), 2:35 p. m., Lyon & Healy; 4:20, Items of interest to women; 4:30, Illinois Federation of Women's clubs, Talk, Mrs. George W. Plummer; 6:45, Talk, Segfried Wag-ner; 7:00, Boy Scouts weekly talk; Rockwell R. Stephens, auto editor; Golf lessons, B. A. Andrews; 8:40, LaSalle orchestra; 9:00, Northland Trio.
WMC, Memphis, Tenn. (Central, 500), 8:00 p. m., Chisca Hotel Philharmonic Orchestra, Clara Ahern, director.
WOAW, Omaha, Neb. (Central, 526), 6:30 p. m., Din-ner program, Goldenrod Orchestra; 9:00, Concert, 17th U. S. Infantry Band.
WOC, Davenport, Iowa (Central, 484), 12:00 m., Chimes; 3:30 p. m., "Lobar Pneumonia," Karl G. Stephan; 5:45, Chimes; 6:30, Sandman's Visit; 7:00, P. S. C. Orchestra; V. B. Roche, baritone.
WOO, Philadelphia, Pa. (Eastern, 509), 11:00 a. m., Organ recital, Mary E. Vogt; 12:02 p. m., Wana-maker Crystal Tea Room Orchestra; 4:45, Orgau rec-ital, Mary E. Vogt.
WOR, Newark, N. J. (Eastern, 405), 2:30-2:45 p. m., Dr. Wm. R. P. Emerson of Boston speaking on Nutri-tion; 2:45-2:55, Joint program by Helen B. Sutton, pianist and soprano, and Marie Thomas; 3:30-4:00, Joint program by Helen B. Sutton and Marie Thomas;

Where to Hear Talks

TALKS, instructive, serious, humorous and even frivolous, are broad-cast daily and below are listed the stations.

Tuesday: KDKA, KGW, KYW, WAAM, WBZ, WCAE, WCAL, WDAF, WEA, WFAA, WGI, WHN, WJY, WJZ, WLAG, WMAQ, WOC, WOR.
Wednesday: KDKA, KFAE, KGO, KYW, WAAM, WBZ, WDAF, WEA, WGI, WHA, WJZ, WLAG, WMAQ, WOC, WOR, WOS, WWJ.
Thursday: KDKA, KYW, WAAM, WAAW, WBZ, WCAE, WDAF, WEA, WFAA, WGI, WGY, WJZ, WLAG, WMAQ, WOC.
Friday: KFAE, KGW, KHJ, KYW, WBZ, WCAL, WDAF, WEA, WFAA, WGI, WGY, WHA, WJY, WJZ, WLAG, WMAQ, WOC.
Saturday: WBAP, WDAF, WFAA, WGI, WLAG, WMC, WOC.
Monday: KFAE, WEA, WFAA, WLAG, WOC.

Saturday, March 8

WEAF, New York, N. Y. (Eastern, 492), 11:00 a. m., Country Life Magazine; 11:15, Musical America; 4:00 p. m., Mabel Wright, soprano; and Adele Giordano, contralto; 4:45, Ellis Cohen, violinist; 5:00, Edna Towar, pianist; 7:30, Thornton Placer; 7:40, Win-fred T. Barr, pianist; 7:50, Battery Talk; 8:00, Billy Jones and Ernest Hare; 8:30, Estelle Ashton Sparks, dramatic soprano; 8:50, Joint Coffee Trades; 9:00, Astor Coffee Dance Orchestra; 10:00, Stellar Male Quartet.
WFAA, Dallas, Texas (Central, 476), 12:30-1:00 p. m., "Reign of King Saul," Dr. Robert S. Hyer; 8:30-9:30, Faculty recital, Southern University.
WFI, Philadelphia, Pa. (Eastern, 395), 1:00 p. m., Meyer Davis Bellevue Stratford Concert Orchestra; 3:00, Piano solos, Loretta Kerk; 6:00, "Sunny Jim, The Kiddies' Pal" 6:30, Meyer Davis Bellevue Strat-ford Concert Orchestra.
WGI, Medford Hillside, Mass. (Eastern, 360), 12:00 m., selections on the Ampico in the Chickering; Am-rad Round Table; Selections on the Brunswick; 3:00 p. m., Amrad Women's Club Program; talk, Dorothy H. Goodwin; Afternoon musicale; 6:30, Big Brother Amrad Club; 7:30, Selected verses, Charles L. H. Wagner, Radio Poet; Red Cross Health Talk, Henry Copley Green; Musicale.
WGR, Buffalo, N. Y. (Eastern, 319), 12:30-1:00 p. m., Georga Albert Bouchard, organist; 2:30-4:00, the Radio Dealers' Orchestra; 4:00, Tea time music, Martha Gomph, harpist; Katherine Stang, violinist; 6:30 and 11:30, Vincent Lopez Hotel Statler orchestra; 7:30, Digest of the day's news; 9:00, Concert, direc-tion of Mrs. E. F. Fisher.
WGY, Schenectady, N. Y. (Eastern, 380), 2:00 p. m., "Mildred's Spring Footwear," Hall A. Brown; 6:30, Children's program; 7:45, Radio drama, "If I Were King," Justin Hartley, McCarthy, WGY Players; WGY Orchestra; 10:30, Special program.
WHA, Madison, Wis. (Central, 360), 7:30 p. m., Read-ings from Literature; Prof. C. F. Gillen.
WHAS, Louisville, Ky. (Central, 400), 4:00-5:00 p. m., Walnut Theater Orchestra; Strand Theater Orches-tra; Alamo Theater Organ; 7:30-9:00, Worth's No-velty Orchestra, Everett Hickerson, director; Theodora Richbourg, pianist; Reading, An Interesting Historical Episode.
WHK, Cleveland, Ohio (Eastern, 283), 9:00 p. m., con-cert program arranged by the Cleveland Radio Deal-ers' Association, music by Louis Rich's Orchestra.
WHN, New York, N. Y. (Eastern, 360), 2:15-2:30 p. m., Jimmy Moore and Blattie Delman; 2:30-2:45, Ross Fowler, baritone; 2:45-3:00, Con Conrad, song writer; 4:15-4:30, "Dumb Dora" and "Why Don't My Dreams Come True," Larry McCarthy and Joe Hol-lander; 4:30-5:00, "Snappy Trip," 5:00-5:30, Jack Fox's Melody Belles Orchestra from Clover Gardens; 9:30-10:00, Fletcher Heuderson's Alabam Club Or-chestra; 10:00-10:30, Whitehouse Review; 10:30-11:00, Charles Hathway's Orchestra.
WIP, Philadelphia, Pa. (Eastern, 509), 1:00 p. m., Gimbel's Tea Room Orchestra, Ray Steen, director; 6:05, Jordan-Lewis Dance Orchestra; 7:00, Uncle Wip's bedtime stories.
WJAZ, Chicago, Ill. (Central, 448), 10:00 p. m.-1:00 a. m., Oriole Orchestra.
WJY, New York, N. Y. (Eastern, 405), 7:30 p. m., Harold Toft, Wright, tenor; 8:15, Fran Shaffer, ban-jolist; 8:30, "The Work of the New York Assembly," Julius Berg; 8:45, "Songs With the Uka," Richard Douglas; 9:00, "The Vegetable Garden"; 9:15, Breau and Tobias; Vincent Laine, tenor; 9:45, Concert, Campbell Weston.
WJZ, New York, N. Y. (Eastern, 455), 12:00 m., Fri-day noon hour of music, Brick Presbyterian Church; 1:00 p. m., Hotel Ambassador Trio; 2:00, New York Board of Education program; 3:00, Leo Riggs, organ-ist; 4:00, Women's wear; 4:05, Georgia Melodians of the Cinderella Orchestra; 4:45, "The Larger Aspect of World Affairs," International Interpreter; 5:00, John Page, tenor; 5:15, "Systematic Psychology," Dean James E. Lough; 7:05, Memphis Fiva of the Rosemont Orchestra; 7:30, Guy Hunter, blind en-tertainer; 7:45, Localat Current Topics; 8:00, Guy Hunter; 8:15, Anne Lewis Pierce, "Lenten Fare"; 10:30, Dance program, Paul Specht's Alamac Hotel Orchestra.
WLAG, Minneapolis-St. Paul, Minn. (Central, 417), 2:00-2:30 p. m., Woman's Club talk, "Community Fund"; 2:40-4:00, Daylight concert; 4:00-4:30, Read-ing; 5:30-6:00, Children's stories, Earle R. Buell; 7:30-8:15, "Farm Life Problems," D. A. Martin; "Canned Food Week Means Better Eating and Bet-ter Times," Carey Emerson; 9:30-10:45, Musical pro-gram, St. Cloud Commercial Club.
WLW, Cincinnati, Ohio (Central, 309), 4:00 p. m., Half hour lecture recital.
WMAQ, Chicago, Ill. (Central, 447.5), 4:20 p. m., Items of interest to women; 4:30, Pupils of Bush Conserva-tory; 7:00, Weekly "Wide Awake Club," Mrs. Frances M. Ford; 7:30, Music memory contest, Mrs. Mary E. Oberndorfer; 8:40, La Salle Orchestra; 9:00, Cosmo-politan School of Music.
WMC, Memphis, Tenn. (Central, 500), 8:30 p. m., Program arranged by H. R. Lindsey; 11:00, Pipe or-gan recital, Scottish Rite Cathedral, H. O. Nichols, organist.
WOAW, Omaha, Neb. (Central, 526), 6:30 p. m., Din-ner program, Ackerman's Orchestra; 9:00, Omaha Technical High School Orchestra, Will L. Hether-ington, director; Clara Procopio, vocalist; Ed Ras-mussen, saxophonist; Frances Taylor, flutist; Vi-oletta Deutsch, pianist; Cornet duet, Arthur Miller, Milton Brewer; Vincent Immanuel, piccoloist.
WOC, Davenport, Iowa (Central, 484), 12:00 m., Chimes; 3:30 p. m., "Structure of the Hair, Skin and Nails," Dr. Maybach; 5:45, Chimes concert; 6:30, Sand-man's visit; 7:20, Sunday school lesson, Dr. Frank Willard Court; 8:00, Program, First Methodist Epis-copal Church Orchestra.
WOO, Philadelphia, Pa. (Eastern, 509), 11:00 a. m., Organ recital, Mary E. Vogt; 12:02 p. m., Wana-maker Crystal Tea Room Orchestra; 4:45, Organ recital, Mary E. Vogt.
WOR, Newark, N. J. (Eastern, 405), 2:30-2:45 p. m., Recital by Manly Price Boone, tenor; 2:45-3:00, Rec-ital by Gloria Marshall, composer; 3:30-3:45, Recital by Manly Price Boone; 3:45-4:00, Recital by Gloria Marshall; 6:15-6:30, Piano solos by Lena Kiewsky; 6:30-7:00, Weekly Moon Stories; 7:00-7:30, Fred J. Whitehouse Song Revue.
WOS, Jefferson City, Mo. (Central, 440.9), 8:00 p. m., Varied musical program, students and faculty mem-bers of Synodical College.
WWJ, Detroit, Mich. (Eastern, 517), 9:30 a. m., "To-night's Dinner," Woman's Editor; 12:00 m., Dance music, Jean Goldkette's Orchestra; 3:00 p. m., De-troit News Orchestra; 7:00, Detroit News Orchestra; Anne Campbell, Detroit News Poet; Gladys Allen, baritone; Leon Zannl, tenor; Rev. Edward K. Cant-well, speaker.

(Continued on page 18)

ADVANCE PROGRAMS

(Continued from page 17)

Science: 10:15. Ted Weems and Cafe L'Alston Orchestra.
WJAZ, Chicago, Ill. (Central, 448), 10:00 p. m.-1:00 a. m. Indiana Male Quartet; Helen Smith, soprano; Orlole Orchestra.
WJZ, New York, N. Y. (Eastern, 455), 8:00 p. m. Georgia Newman pianist; 8:30, E. McKnight, soprano; M. A. Grogan, contralto; 4:00, Tea concert; Helen Belmont Stringed Ensemble; 5:00, Renato M. C. Iera, baritone; 7:30, Margaret Friedle, soprano; 7:45, "In Brightest Africa," Carl E. Akeley; 8:00, Margaret Friedle, S. L. "Belgium," Wirt Barnitz; 8:30, Le dekrauz Annual Orbes ra Concert.
WLAB, Minneapolis-St. Paul, Minn. (Central, 417), 1:30-12:30 p. m., Weekly meeting of Postcard Club. E. R. Buell 2:30-3:30, "Stage and Screen Review." 4:30-5:30, Short reading, Mildred Simons; 4:30-5:00, Talk - Ray R. Sweet; 5:30-6:00, Meeting of Ch... 's Rad... Health and Toothbrush Club of Sullivan; 6:00-9:30, "The Growing Influence of Christianity in the World To-day," Dr. George W. Truett; 9:30-11:00, Jack Gardner's Orchestra.
WFI, Philadelphia, Pa. (Eastern, 395), 7:30 p. m., Services, Arch street Presbyterian Church.
WGL, Medford Hills, Mass. (Eastern, 360), 4:00 p. m., Twilight program, "Adventure Hour," Youth's Companion; Musical; 8:30, "World Unity," Greater Boston Federation of Churches; Westminster Quartette.
WGR, Buffalo, N. Y. (Eastern, 319), 3:00 p. m., Vesper service, the Rev. Adolph F. Kreuger, Salcu Lutheran Church; 4:00-5:00, Robert Munn, organist.
WGY, Schenectady, N. Y. (Eastern, 380), 10:30 a. m., Service, Scotia Baptist Church, Rev. Nelson Reynolds; 3:30 p. m., WGY Symphony Orchestra; Mrs. Edwin Newkirk, contralto; 7:30, Memorial service, Truth Lodge No. 388, Knights of Pythias; Scotia Baptist Church.
WHAS, Louisville, Ky. (Central, 400), 9:57 a. m., Organ music; 10:00, Church service, Broadway Baptist Church, Rev. Russell J. Pirkey, pastor; 4:00-5:00, Concert, auspices Violette N. Code, Laura Butler.
WHK, Cleveland, Ohio (Eastern, 283), 8:00 p. m., Concert program by the WHK Orchestra, Lula VanCamp, soloist.
WHN, New York, N. Y. (Eastern, 360), 3:00-4:30 p. m., Queens County Christian Endeavor Union; 4:30-4:40, John D. Flynn of the National Security League; 4:40-5:10, WJLN Radio Five Dance Orchestra; 5:10-5:20, Alms, Alberts in songs; 5:20-6:00, Temple Club Orchestra; 9:30-12:00, Classical program.
WIP, Philadelphia, Pa. (Eastern, 509), 4:00 p. m., Germantown Y. M. C. A. meeting; 7:30, Services, Holy Trinity Church, Rev. Floyd Tompkins, minister; 9:30, Sunday night symphonic concert, direction Bed Stad, with Karl Bonawitz at organ.
WJAZ, Chicago, Ill. (Central, 448), 6:00-9:00 p. m., Orlole Orchestra; Children's program.
WLW, Cincinnati, Ohio (Central, 309), 9:30 a. m., School, Editorial Staff of Sunday School Publications of the Methodist Book Concern; 11:00, Service, Church of the Covenant, Dr. Frank Stevenson, minister; 7:45, Services, Evangelical Lutheran Emmanuel Church, Rev. P. L. Dannenfeldt, pastor.
WOAW, Omaha, Neb. (Central, 526), 9:00 a. m., Radio Chapel service, Rev. R. R. Brown, pastor; 6:00 p. m., Bible study hour, Mrs. Carl R. Gray; 9:00, Musical Chapel service, Temple Israel, Frederick Cohn, Rabbi; Vernon C. Bennett, organist; Helen Sommer, violinist; Bell Von Mansfield, cellist; Mrs. Harry Rosenfeld, pianist; Laura Goetz, soprano; Duet, Harriet Metz, soprano; Cecelia Feller, contralto; Lawrence S. Dods, tenor; Harry S. Disbrow, baritone.
WOC, Davenport, Iowa (Central, 484), 9:00 a. m., Sacred Chimes; 1:30 p. m., Orchestra Concert; P. S. C. Orchestra; 6:45, Musical program; 8:00, Church service; 9:30, Musical program, Erwin Swindell, director; P. S. C. Orchestra.
WOS, Jefferson City, Mo. (Central, 440.9), 7:30 p. m., First Presbyterian Church of Jefferson City, Rev. W. Hooper Adams, pastor; Mrs. Mary Armstrong, organist; Mrs. John V. Jobs, director of Vested Choir.
WVJ, Detroit, Mich. (Eastern, 517), 2:00 p. m., Detroit News Orchestra; 7:30, Services, St. Paul's Episcopal Cathedral.

Sunday, March 9

CKAC, Montreal, Can. (Eastern, 425), 4:30 p. m., Sacred concert.
KFI, Los Angeles, Calif. (Pacific, 469), 10:00-10:45 a. m., Church services by Los Angeles Church Federation; 4:00-5:00 p. m., Vesper service by Los Angeles Church Federation Musicians; 6:45-7:30, Concert and bedtime story; 8:00-9:00, Concert by Ambassador Hotel Orchestra; 9:00-10:00, Examiner concert; 10:00-11:00, Concert, presented by Theron Bennett's Packard Six.
KFKX, Hastings, Neb. (Central, 341), Rebroadcasts program of KDKA.
KFSS, Los Angeles, Calif. (Pacific, 278), 10:30-12:30 p. m., Full church services, including sermon by Almee Semple McPherson; 2:30-4:30 p. m., Musical program; 7:00-7:30, Service; 8:00-10:00, Service.
KHL, Los Angeles, Calif. (Pacific, 395), 10:00 a. m., Sermon; 10:30 a. m., Entire service and organ recital from First M. E. Church, Rev. E. E. Helms, pastor; Arthur Blakeley, organist; 7:00-7:30, Organ recital, Arthur Blakeley.

Monday, March 10

CKAC, Montreal, Can. (Eastern, 425), 1:45 p. m., Mt. Royal Hotel Concert Orchestra; 4:30, Mt. Royal Hotel Dance Orchestra.
KFAE, Pullman, Wash. (Pacific, 330), 7:30 p. m., "Analysis of Commercial Mixed Feeds," Dr. J. L. St. John; "Hardening and Tempering Tools," Prof. H. Henton; Vocal numbers, High School Women's Sextet; Bernice Metz, pianist; "Better Dairying in Snohomish County and Its Effect on the State," R. M. Turner.
KFI, Los Angeles, Calif. (Pacific, 469), 8:00-9:00 p. m., Evening Herald concert; 9:00-10:00, Examiner concert; 10:00-11:00, Concert by Ambassador-Lyman's Coconut Grove Orchestra.
KFKX, Hastings, Neb. (Central, 341), 9:30 p. m., Old time concert.
KPO, San Francisco, Calif. (Pacific, 423), 1:00-2:00 p. m., Rudy Selger's Fairmont Hotel Orchestra; 2:30-3:30, M. Martin Lippitts, baritone; 4:30-5:30, Rudy Selger's Fairmont Hotel Orchestra; 5:30-6:30, Children's hour, stories for children, by "Big Brother" of KPO, Book of Knowledge; 7:00-8:00, Rudy Selger's Fairmont Hotel Orchestra; 8:00-9:00, Theodore J. Irwin, organist; 9:00-10:00, San Francisco Conservatory of Music; 10:00-11:00, E. Max Bradford's Palace Hotel Dance Orchestra.
WAOW, Omaha, Neb. (Central, 526), 7:30-9:00 p. m., Musical program, direction of the Union Pacific System.
WBAP, Fort Worth, Texas (Central, 476), 7:30-8:30 p. m., Concert, Guy Pitner, pianist; Brooks Morria, violinist; 9:30-10:45, Concert, Band of the Texas Agricultural and Mechanical College of College Station.
WCBZ, Zion, Ill. (Central, 345), 8:00 p. m., Brass Quartet, Newcomer, Mason, Schultz, Dunn; Hire Trio; William C. Dunn, euphonium player; Mrs. G. R. Sparrow, contralto; Mark Whiteside, baritone; P. B. Newcomer, cornetist; Mary Sweeney, pianist; G. R. Sparrow, tenor; Mrs. G. R. Sparrow, contralto; Sydney Stewart, violinist; Ladies' Trio.
WOAR, Philadelphia, Pa. (Eastern, 395), 11:45 a. m., Daily Almanac; 12:02 p. m., Organ recital, Stanley Theater; dinner music, Arcadia Cafe Concert Orchestra; 2:00-3:00, Arcadia Cafe Concert Orchestra; 4:30, Piano solos, Edna Finestone; 7:30, Uncle Jim's bedtime stories; 7:50, Moving Picture review by James A. Nassau; 8:00, Weekly Opera talk by Samuel A. Lecair; 10:10, Howard Lanin's Dance Orchestra from Arcadia Cafe.
WEAF, New York, N. Y. (Eastern, 492), 4:00 p. m., Rosa Powell, contralto; 4:30, Joseph M. White, tenor; 5:00, Mother's program; 7:15, "Sixty Years With Girls," a talk; 7:30, Thornton Fisher; 7:40, Frederick E. Bensen; 8:10, Sales Literature, Inc.; 8:30, Associated Glee Clubs of America.
WFI, Philadelphia, Pa. (Eastern, 395), 1:00 p. m., Meyer Davis Bellevue Stratford Concert Orchestra; 6:30, Sunny Jim, the Kiddies' pal; 6:30, Meyer Davis Bellevue Stratford Concert Orchestra.
WGR, Buffalo, N. Y. (Eastern, 319), 12:30-1:00 p. m., George Albert Bouchard, organist; 2:30-4:00, The Radio Dealers' Orchestra; 4:00, Tea time music, Martha Gomph, harpist; Katherine Stang, violinist; 6:30-7:30, Vincent Lopez Hotel Statter Orchestra; 7:30, Digest of the day's news; 9:00, Convention, The Merchants' Mutual Casualty Co.

WGY, Schenectady, N. Y. (Eastern, 380), 2:00 p. m., U. S. Dept. of Agriculture; 7:45, Male quartet, Crack-A-Jack Four; Frank Bentz, violinist; Helen Grose, reader; George A. Lauterborn, pianist.
WHAS, Louisville, Ky. (Central, 400), 4:00-5:00 p. m., Walnut Theater Orchestra.
WHAZ, Troy, N. Y. (Eastern, 380), 9:00 p. m., Concert, Fifth Avenue Baptist Church Choir; Readings; 9:30, "History of Arctic Exploration," Dr. J. Lewi Donhauser; Forest Conservation; 12:00, Midnight transcontinental concert, Students' Symphony Orchestra and Glee Club.
WIP, Philadelphia, Pa. (Eastern, 395), 1:00 p. m., Gimbel's Tea Room Orchestra; 6:05 p. m., St. James Hotel Dinner Dance Orchestra; 7:00 p. m., Uncle Wip's bedtime stories.
WLW, Cincinnati, Ohio (Central, 309), 8:00 p. m., College of Music students in "An Hour With Beethoven"; Biographical sketches and descriptive readings, Fred Smith, Estelle Whitney; Rosemary Ellerbrock, violinist; Dorothy O'Brian, violinist; Orpheus String Quartet; Crosley theatrical review; George Webb's Hawaiian Entertainers; Woody Meyer's Dance Orchestra; Songs, Margaret Baker.
WMC, Memphis, Tenn. (Central, 500), 8:30 p. m., Concert, Hotel Gayoso Orchestra, Prof. Gaspar Poppalardo, director.
WOAW, Omaha, Neb. (Central, 526), 6:30 p. m., Dinner program, Randall's Royal Orchestra; 9:00, Program, Lee G. Kratz, director; Pearl Memorial Male Chorus; Mrs. L. N. Smernoff, soprano; Walter Yuenger, baritone; Fred Davis, tenor; Opal Burt, soprano; Dr. O. S. Ringler, bass; Ruth Correa, pianist; Mrs. Gladys Williams, alto; Nate Battaglio, tenor; Mrs. Hazel Bauer, soprano; Gracey Jackson, soprano; Bernard Combs, bass.
WOC, Davenport, Iowa (Central, 484), 12:00 m., Chimes; 5:45, Chimes; 6:30, Sandman's visit; 8:00, Musical program; 10:00, Musical program, Erwin Swindell, director.
WOO, Philadelphia, Pa. (Eastern, 509), 11:00 a. m., Organ recital, Mary E. Vogt; 12:02 p. m., Wanamaker Crystal Tea Room Orchestra; 4:45, Organ recital, Mary E. Vogt.
WOR, Newark, N. J. (Eastern, 405), 2:30-2:45 p. m., Recital by Mildred A. Watson, pianist; 2:45-3:09, Readings by Catherine M. Lockwood; 3:30-3:45, Recital by Mildred A. Watson; 3:45-4:00, Readings by Catherine M. Lockwood; 6:15-7:00, Paul Van Loan's Cinderella Dance Orchestra; 7:15-7:30, Fred J. Bendel, sport writer, Newark Morning Ledger; 8:00-9:15, Gene Ingraham's Bell Record Orchestra; 10:00-11:00, Gotham Entertainers of New York.
WTAM, Cleveland, Ohio (Eastern, 390), 9:00 p. m., Regular Saturday evening dance program by the WTAM Dance Orchestra; Vocal solos, Mr. E. J. Brisbane, tenor.
WVJ, Detroit, Mich. (Eastern, 517), 9:30 a. m., "Tonight's Dinner," Woman's Editor; 3:00 p. m., Detroit News Orchestra; 7:30, Detroit News Orchestra; Harold Kean, baritone.

Broadcasting Station or Parts Wanted

Persons or firms able to supply parts or complete equipment for a high power broadcasting station, from 500 to 2,000 watts antenna input, will be interested in communicating with this box number. State what estimated costs are, and delivery dates, together with possibilities for installation. Box RD-3824, Radio Digest, 123 W. Madison St., Chicago, Ill.

Improve Your Set

WITH Union Radio Tip Jacks (Patent Pending)

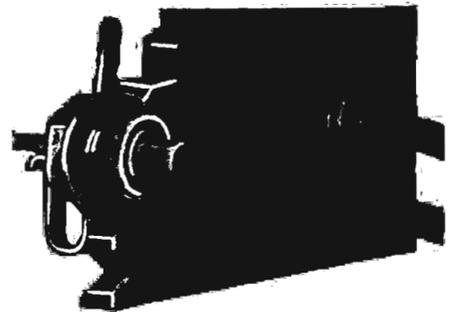

No more trouble with binding posts, no more noises from poor connections. You should use Union Radio Tip Jacks for all antenna, ground and battery connections and contacts. They give you quickly made, positive connections, and improve the appearance of your set. Extensively used by leading set manufacturers.

Two sizes for all mountings. STANDARD TYPE A for panels up to 1/4" thick. SPECIAL TYPE B for panels, cabinet walls and partitions from 1/8" to 1/2" thick. Will firmly grip all wires from No. 11 to No. 24 B & S gauge and can be reamed to hold antenna wire.

No parts to chip, lose or deteriorate. All parts heavily nickel plated. Price in U. S., 25c; in Canada, 35c a pair.

Other Union Radio Parts

Dial adjusters for minute variations in capacities of variable condensers. Price, 60c.

Tube sockets of molded condense highly polished. Phosphor Bronze contact springs. Reinforced bayonet slot prevents breakage. Accommodates all standard tubes. Price, 70c.

Should your favorite Radio Store not carry Union Radio Tip Jacks and Guarantee Parts send your order direct to us; also write for your copy of The Union Radio Catalog "H."

RETAILERS AND WHOLESALE

Samples of our guaranteed reasonably priced "Quality Products" sent on request. Our terms and trade discounts are liberal. Write for our proposition. Also write for your copy of the Union Radio Catalog "H"

UNION RADIO CORPORATION 200 MT. PLEASANT AVENUE, NEWARK, N.J. NEW YORK OFFICE - 116 WEST 32nd STREET

Radio Veterans Demand



The finest instrument of its kind that money and science can produce. Moulded Bakelite cases and ear caps; single bar Tungsten steel magnets; light weight; exceptional tone and volume. A \$12.00 quality for \$7.65

TRIMM Head Sets

Positively the only headset on the market sold with a life-time guarantee that covers every detail of materials and workmanship excepting only cords and shells which cannot be guaranteed against breakage if dropped. Absolutely no charge at any time for repairs, replacements or for re-magnetizing. The head sets to buy; the head sets to sell.



Standard bi-polar construction. Aluminum case. Splendid finish; beautiful appearance. Wonderful volume and clarity of tone. Compare the Trimm "DEPENDABLE" with any \$6.50 to \$8.00 headset on the market. Money back if not satisfied with any TRIMM product



"The Voice of the Nation"

NO LOOPS - NO ANTENNA

THE RADIODYNE is operated by simply grounding to a water pipe or radiator, and throwing a few feet of wire on the floor. Uses any standard tubes—dry cell or storage battery. Extremely selective. Simple to operate—only two controls.

Stations within a radius of 2000 miles can be picked up on the loud speaker; any wave length from 200 to 700 meters. You can select the best programs with the Radiodyne.

PRICE \$150.00

For use in apartments, boats, automobiles, railroad trains, etc., the RADIODYNE is enjoyable where other receiving sets would not be practical.

When interference, strays, static, etc., make other types of reception utterly useless, the RADIODYNE picks up broadcast programs clear and distinct.

Write for illustrated folder which describes the RADIODYNE in detail. Every radio fan will be interested in this new type (antennaless) receiving set.

Western Coil & Electrical Co. 312 5th St. Racine, Wisconsin

SEE! HEAR! THE Trimm Loud Talkers

\$10.00 Acousticola Phonograph Attachment

\$22.50 Acousticola Composition Horn

\$35.00 Acousticola Grand with Cast Aluminum Horn

All fitted with Special TRIMM jumbo size loud Talker Unit. Write for folder. Or order samples with privilege of return after 5 days' examination and test.

Trimm Radio Mfg. Co., Dept. 63, 24-30 S. Clinton St., Chicago, Ill.

Meditations by the Inventor of King Miloplex

Part XXII—Spark Interference Wave Traps

By the Mystery Man

I SEE by the papers that just because fate stepped in causing my weekly "composium" of "Gimmie, have you got, can you get" to be omitted, excuses enough to appease Maggie for 13 days came forth to apologize for me. Yet, to you who mob the newsstand each week, its absence apparently thoroughly spoiled "a perfect day." Mercy! I didn't think "My Gang" was so much concerned, and like Mark Twain I am quite pleased to now inform

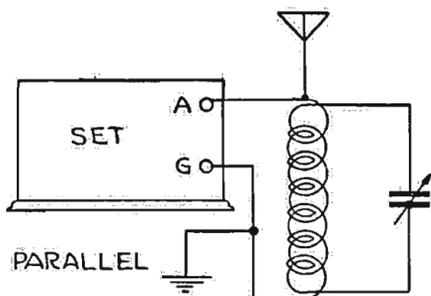

those who were worried, that, the reports of my death were greatly exaggerated; in fact, I was even unable to accumulate a "certified headache," Maggie opining that I wasn't even lucky enough to get caught in one of my wave traps, and even if I did, she would still have to put up with a lot of interference.

But the inside story is I tried to be courteous and polite to a most worthy gentleman of the East, who came to Chicago and decided that the "piece de resistance" of our luncheon should and would be sauerkraut and in order to keep it well covered, he would furnish the stomach abuse through eating cream puffs! Think it over; visualize, if you will, a guest eating sauerkraut and cream puffs. He went through it like Rockefeller juice through

Henry's Elizabeth; but I—well, you know how it is; if you don't, then glance once more at Maggie's picture and decide whether you believe you could even get her to say sauerkraut.

Series-Parallel Wave Trap

The King still lives, however, and in order to keep peace with you, my gang, we will now try to add an improvement to the series-parallel straight receptor trap we built last week.

Probably some, yet not many of you, knew, or realized that the inductance in parallel with the variable condenser described last week constitutes a wavemeter whose accuracy (provided a good condenser is used) should not vary much over three or four per cent. In order to use it as such, it is only necessary to mark on the face of the panel zero, where the marking on the dial will coincide when the rotor plates are entirely out of mesh with the stator or fixed plates. The condenser is at maximum capacity when the rotor plates are totally in mesh with the stator plates. With the minimum and maximum points known it is then a simple matter to note the numeral position of the dial when set for a station of known wave length, and thus to log on, as we might say, calibrate it. Many will be quite surprised by the apparent accuracy of this most simple device.

While a wave trap or meter of this character operates best when connected in series with either the antenna or ground, it may be used, without removing your usual antenna and ground connections to the receiving set, by connecting the trap directly onto the antenna and ground connections, and thus fair selectivity secured. The trap, as described last week, is pri-

marily only effective when used in series with your antenna or ground for the elimination of phone or, as we call it, broadcasting interference, and will not be of much assistance for the elimination of spark or wireless code telegraph stations.

Spark Interference Trap

Therefore, as Maggie says, "Cut out the Da-La-Dit guys," and methinks, you likewise care little for their buz-buz conversation, though personally I'm for them one thousand and two per cent and for you B. C. L.'s as well. However, it's wave traps you want, so wave traps it shall be. And wave traps it must be, which will allow you to cut out both phone and spark interference. And as Casey says: "The only reason a dog has fleas is as a constant re-

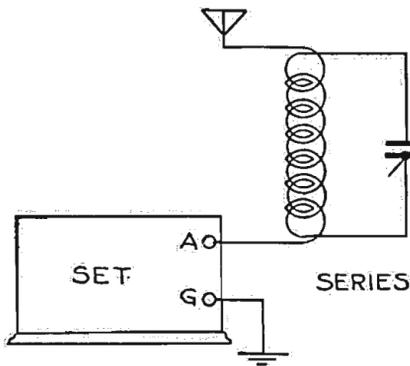

minder that he is a dog," I opine that we will now add a "doodad" or two to the trap we built last week, a sort of flea-on-a-dog

scheme which will cut out both spark and phone. But before doing so I want to be every positive in the statement that at times there are conditions prevailing in which

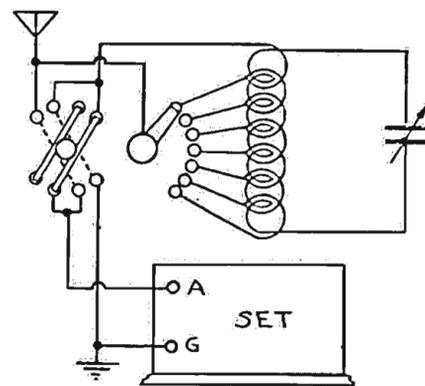

SERIES PARALLEL (SWITCH CONNECTIONS)

no known eliminating device or plan will be of any assistance whatever. Such cases fortunately are very unusual and obtain most often when your receiver is located so close to the broadcasting station that the force of its transmitter is such as to cause what is known as "shock excitation," or the putting up of oscillations within the tuning inductance, which in turn gives rise to audible signals in the phones. One's only recourse in such cases is the removal of both antenna and ground, or to close up shop, spending the evening writing kicks to Radio editors and bawling out

(Continued on page 24)

Get today the

Easily kept Radio Record Book

Where I Go by Radio.

Unique system. Every line complete Record.

Accurate List Radio Stations. Other features, too.

Now used everywhere.

Popular Edition. Space 300 Records, 2 for \$1.00

Holiday Edition, 700 Records \$1.00

Dealers get Discount. For Sale at all News-stands, Bookstores and Radio Dealers.

Show them this adv. If they won't carry book in stock order direct today from

Radio Book Department

PROGRESS PRESS

Union, South Carolina, U. S. A.

The New

KEYSTONE

RADIO \$150

LIGHTNING ARRESTERS

The new Keystone Arrester is made of genuine Bakelite with moulded-in binding posts and provides maximum protection against lightning and static charges. Fully approved by Underwriters—should be in every aerial lead the year 'round. Absolutely weather, dust and damp proof and has no vacuum to lose—it will operate for years. This pioneer arrester is backed by 31 years' experience in lightning arrester design. Sold in a red box by Dealers everywhere.

ELECTRIC SERVICE SUPPLIES CO.

17th & Cambria Streets
PHILADELPHIA

Monadnock Bldg. Chicago
50 Church St. New York

MAKE PERFECTION YOUR SELECTION

PERFECTION

<p>118 Nassau Street 118 West 23rd Street</p>	<p>78 Cortlandt Street 59 Cortlandt Street</p>	<p>128 Chambers Street 368 Livingston St., at Flatbush Ave., Bklyn.</p>
---------------------------------------------------	----------------------------------------------------	-----------------------------------------------------------------------------

<h3 style="text-align: center;">COCKADAY</h3> <p style="text-align: center;">3 TUBE SET</p> <table style="width: 100%; font-size: 0.8em;"> <tr> <td>1 Cockaday Coil</td> <td>2 Double Jacks</td> </tr> <tr> <td>2 17-Plate Plain Condensers</td> <td>1 Single Jack</td> </tr> <tr> <td>2 Switch Arms</td> <td>12 ft. Bus Bar, gold plated</td> </tr> <tr> <td>10 Switch Points</td> <td>1 7x18 Panel, Formica</td> </tr> <tr> <td>4 Switch Stops</td> <td>8 Binding Posts, initialed</td> </tr> <tr> <td>3 Sockets, Bakelite</td> <td>2 Audio Transformers, Jefferson</td> </tr> <tr> <td>3 Rheostats, Bakelite</td> <td>1 .001 Condenser</td> </tr> <tr> <td>1 Grid Leak</td> <td>Free Diagram</td> </tr> <tr> <td>1 Grid Cond., .00025</td> <td></td> </tr> </table> <p style="text-align: center;">VALUE \$30.00 Special Price \$19⁷⁵</p>	1 Cockaday Coil	2 Double Jacks	2 17-Plate Plain Condensers	1 Single Jack	2 Switch Arms	12 ft. Bus Bar, gold plated	10 Switch Points	1 7x18 Panel, Formica	4 Switch Stops	8 Binding Posts, initialed	3 Sockets, Bakelite	2 Audio Transformers, Jefferson	3 Rheostats, Bakelite	1 .001 Condenser	1 Grid Leak	Free Diagram	1 Grid Cond., .00025		<h3 style="text-align: center;">ERLA</h3> <p style="text-align: center;">ONE TUBE SET</p> <table style="width: 100%; font-size: 0.8em;"> <tr> <td>1 Pioneer Bakelite Coupler</td> <td>1 .001 Mica Condenser, Erla</td> </tr> <tr> <td>1 23-Plate Vermier Condenser</td> <td>1 .0025 Mica Condenser, Erla</td> </tr> <tr> <td>1 Socket, Erla</td> <td>1 .00025 Mica Condenser, Erla</td> </tr> <tr> <td>1 Erla Audio Transformer</td> <td>1 7x14 Panel, Formica</td> </tr> <tr> <td>1 Erla Fixed Detector</td> <td>1 Erla Bezel</td> </tr> <tr> <td>1 Erla Reflex No. 1 Transformer</td> <td>6 Binding Posts, initialed</td> </tr> <tr> <td>1 Jack</td> <td>1 Erla Blueprint Bus Wire, gold plated</td> </tr> <tr> <td>1 Rheostat</td> <td></td> </tr> </table> <p style="text-align: center;">VALUE \$30.00 Special Price \$19⁴⁵</p>	1 Pioneer Bakelite Coupler	1 .001 Mica Condenser, Erla	1 23-Plate Vermier Condenser	1 .0025 Mica Condenser, Erla	1 Socket, Erla	1 .00025 Mica Condenser, Erla	1 Erla Audio Transformer	1 7x14 Panel, Formica	1 Erla Fixed Detector	1 Erla Bezel	1 Erla Reflex No. 1 Transformer	6 Binding Posts, initialed	1 Jack	1 Erla Blueprint Bus Wire, gold plated	1 Rheostat		<h3 style="text-align: center;">REINARTZ</h3> <p style="text-align: center;">3 TUBE SET</p> <table style="width: 100%; font-size: 0.8em;"> <tr> <td>1 Reinartz Coil (John L. Reinartz signature on each coil)</td> <td>1 Grid Leak</td> </tr> <tr> <td>1 23-Plate Condenser</td> <td>8 Binding Posts, initialed</td> </tr> <tr> <td>1 11-Plate Condenser</td> <td>12 ft. Bus Bar, gold plated</td> </tr> <tr> <td>3 Rheostats, Bakelite</td> <td>3 Switch Arms</td> </tr> <tr> <td>3 Sockets, Bakelite</td> <td>1 doz. Switch Points</td> </tr> <tr> <td>1 7x21 Panel, Formica</td> <td>6 Stops</td> </tr> <tr> <td></td> <td>2 Double Jacks</td> </tr> <tr> <td></td> <td>1 Single Jack</td> </tr> <tr> <td></td> <td>2 Audio Transformers, Jefferson</td> </tr> </table> <p style="text-align: center;">VALUE \$25.00 Special Price \$18⁹⁰</p>	1 Reinartz Coil (John L. Reinartz signature on each coil)	1 Grid Leak	1 23-Plate Condenser	8 Binding Posts, initialed	1 11-Plate Condenser	12 ft. Bus Bar, gold plated	3 Rheostats, Bakelite	3 Switch Arms	3 Sockets, Bakelite	1 doz. Switch Points	1 7x21 Panel, Formica	6 Stops		2 Double Jacks		1 Single Jack		2 Audio Transformers, Jefferson
1 Cockaday Coil	2 Double Jacks																																																					
2 17-Plate Plain Condensers	1 Single Jack																																																					
2 Switch Arms	12 ft. Bus Bar, gold plated																																																					
10 Switch Points	1 7x18 Panel, Formica																																																					
4 Switch Stops	8 Binding Posts, initialed																																																					
3 Sockets, Bakelite	2 Audio Transformers, Jefferson																																																					
3 Rheostats, Bakelite	1 .001 Condenser																																																					
1 Grid Leak	Free Diagram																																																					
1 Grid Cond., .00025																																																						
1 Pioneer Bakelite Coupler	1 .001 Mica Condenser, Erla																																																					
1 23-Plate Vermier Condenser	1 .0025 Mica Condenser, Erla																																																					
1 Socket, Erla	1 .00025 Mica Condenser, Erla																																																					
1 Erla Audio Transformer	1 7x14 Panel, Formica																																																					
1 Erla Fixed Detector	1 Erla Bezel																																																					
1 Erla Reflex No. 1 Transformer	6 Binding Posts, initialed																																																					
1 Jack	1 Erla Blueprint Bus Wire, gold plated																																																					
1 Rheostat																																																						
1 Reinartz Coil (John L. Reinartz signature on each coil)	1 Grid Leak																																																					
1 23-Plate Condenser	8 Binding Posts, initialed																																																					
1 11-Plate Condenser	12 ft. Bus Bar, gold plated																																																					
3 Rheostats, Bakelite	3 Switch Arms																																																					
3 Sockets, Bakelite	1 doz. Switch Points																																																					
1 7x21 Panel, Formica	6 Stops																																																					
	2 Double Jacks																																																					
	1 Single Jack																																																					
	2 Audio Transformers, Jefferson																																																					
<h3 style="text-align: center;">COCKADAY</h3> <p style="text-align: center;">ONE TUBE SET</p> <table style="width: 100%; font-size: 0.8em;"> <tr> <td>1 Cockaday Coil</td> <td>1 .00025 Condenser</td> </tr> <tr> <td>2 17-Plate Condensers</td> <td>1 Jack</td> </tr> <tr> <td>1 Switch Arm</td> <td>8 ft. Bus Bar, gold plated</td> </tr> <tr> <td>7 Switch Points</td> <td>1 7x14 Panel, Formica</td> </tr> <tr> <td>2 Switch Stops</td> <td>8 Binding Posts, initialed</td> </tr> <tr> <td>1 Socket, Bakelite</td> <td>Free Diagram</td> </tr> <tr> <td>1 Rheostat, Bakelite</td> <td></td> </tr> <tr> <td>1 Grid Leak</td> <td></td> </tr> </table> <p style="text-align: center;">VALUE \$14.00 Special Price \$9⁹⁵</p>	1 Cockaday Coil	1 .00025 Condenser	2 17-Plate Condensers	1 Jack	1 Switch Arm	8 ft. Bus Bar, gold plated	7 Switch Points	1 7x14 Panel, Formica	2 Switch Stops	8 Binding Posts, initialed	1 Socket, Bakelite	Free Diagram	1 Rheostat, Bakelite		1 Grid Leak		<h3 style="text-align: center;">NEW REINARTZ</h3> <p style="text-align: center;">ONE TUBE SET</p> <table style="width: 100%; font-size: 0.8em;"> <tr> <td>1 Reinartz Coil (Genuine John L. Reinartz signature on each coil)</td> <td>1 Socket, Bakelite</td> </tr> <tr> <td>1 23-Plate Condenser</td> <td>1 7x12 Panel, Formica</td> </tr> <tr> <td>1 11-Plate Condenser</td> <td>1 Grid Leak</td> </tr> <tr> <td>1 Rheostat, Bakelite</td> <td>8 Binding Posts</td> </tr> <tr> <td></td> <td>8 ft. Bus Bar</td> </tr> <tr> <td></td> <td>3 Switch Arms</td> </tr> <tr> <td></td> <td>1 doz. Points</td> </tr> <tr> <td></td> <td>6 Stops</td> </tr> </table> <p style="text-align: center;">VALUE \$14.00 Special Price \$9⁹⁰</p>	1 Reinartz Coil (Genuine John L. Reinartz signature on each coil)	1 Socket, Bakelite	1 23-Plate Condenser	1 7x12 Panel, Formica	1 11-Plate Condenser	1 Grid Leak	1 Rheostat, Bakelite	8 Binding Posts		8 ft. Bus Bar		3 Switch Arms		1 doz. Points		6 Stops	<h3 style="text-align: center;">ULTRA AUDION SET</h3> <table style="width: 100%; font-size: 0.8em;"> <tr> <td>1 Variometer Patlle</td> <td>1 Socket Bakelite</td> </tr> <tr> <td>1 23 Plate Condenser</td> <td>1 Rheostat Bakelite</td> </tr> <tr> <td>1 Grid Leak and Condenser</td> <td>8 Binding Posts initialed</td> </tr> <tr> <td>1 7x12 Panel Formica</td> <td>8 ft. Bus Bar gold-plated</td> </tr> <tr> <td></td> <td>1 .001 Condenser</td> </tr> </table> <p style="text-align: center;">VALUE Our Special Price \$8⁹⁰</p>	1 Variometer Patlle	1 Socket Bakelite	1 23 Plate Condenser	1 Rheostat Bakelite	1 Grid Leak and Condenser	8 Binding Posts initialed	1 7x12 Panel Formica	8 ft. Bus Bar gold-plated		1 .001 Condenser										
1 Cockaday Coil	1 .00025 Condenser																																																					
2 17-Plate Condensers	1 Jack																																																					
1 Switch Arm	8 ft. Bus Bar, gold plated																																																					
7 Switch Points	1 7x14 Panel, Formica																																																					
2 Switch Stops	8 Binding Posts, initialed																																																					
1 Socket, Bakelite	Free Diagram																																																					
1 Rheostat, Bakelite																																																						
1 Grid Leak																																																						
1 Reinartz Coil (Genuine John L. Reinartz signature on each coil)	1 Socket, Bakelite																																																					
1 23-Plate Condenser	1 7x12 Panel, Formica																																																					
1 11-Plate Condenser	1 Grid Leak																																																					
1 Rheostat, Bakelite	8 Binding Posts																																																					
	8 ft. Bus Bar																																																					
	3 Switch Arms																																																					
	1 doz. Points																																																					
	6 Stops																																																					
1 Variometer Patlle	1 Socket Bakelite																																																					
1 23 Plate Condenser	1 Rheostat Bakelite																																																					
1 Grid Leak and Condenser	8 Binding Posts initialed																																																					
1 7x12 Panel Formica	8 ft. Bus Bar gold-plated																																																					
	1 .001 Condenser																																																					

5 TUBE NEUTRODYNE SET

Complete parts for 5 tube Neutrodyne Set including licensed Workrite Neutroformers and genuine mahogany cabinet for..... **\$59⁵⁰**

We will make this set for you absolutely free if you purchase the parts from us.

Numbers of our satisfied customers have reported receiving California stations on a loud speaker with this wonderful set.

2-STEP AMPLIFIER

Convert your one-tube set to a distance getter on a loud speaker with

1 7x10 Panel, Formica	VALUE \$15.00
2 Double Jacks	Our Price
1 Single Jack	\$9⁹⁰
2 Jefferson Audio Transformers	
6 Binding Posts	
2 Rheostats, Bakelite	
2 Sockets, Bakelite	
8 ft. Bus Bar, gold plated	

Radio Digest Illustrated

REG. U. S. PAT. OFF. AND DOM. OF CANADA

Published by the Radio Digest Publishing Company, Inc.
123 West Madison Street
Telephone: State 4843, 4844, 4845
Chicago, Illinois

E. C. RAYNER, Publisher
Chas. F. Smisor, Editor Evans E. Plummer, Managing Editor
H. J. Marx, Technical Editor M. W. Thompson, Associate Editor

Eastern Representative, Jacob Miller, Times Bldg., Times Square,
New York; Telephone Bryant 4909

Member of the Audit Bureau of Circulations

58
PUBLISHED WEEKLY

SUBSCRIPTION RATES
Yearly in U. S. and Possessions and Canada, \$5.00.
Foreign postage, \$1.00 additional. Single copies, 10 cents.

Vol. VIII Chicago, Saturday, March 8, 1924 No. 9

Popularity Grows

Homemade Apparatus Advanced the Science

ACCORDING to scientists, Radio has been adopted universally and more rapidly than any other invention. Radio sets are economical; they can be made at home; their range of reception is wide and the entertainment more diversified than any other form which comes direct to the home. Three years ago there was no broadcasting. Today there are about 550 stations.

Radio Interference

Oscillations Transmitted from Local Sets

WE CANNOT find words to express our ideas better than those in a letter which came to the editor's desk. It is given here as it was written Mr. James B. Rowney.

"That Radio is rapidly becoming one of the foremost forms of public entertainment, no one can doubt for a moment. Listeners in are multiplying daily by thousands all over the world, and manufacturers of receiving sets have their hands full trying to keep pace with the demand for apparatus.

"But when you bring your friend to hear your set, you invariably are obliged to offer a multitude of excuses and apologies, because you cannot get a thing decently; you are at a loss to understand why; your batteries are in good condition, and it came in fine last night! Your friend has heard that same tale before, and you feel like two cents.

"Why is it so? What is the cause? About 98 per cent of the trouble is caused by interference. Interference is our great obstacle, and I voice the viewpoint of the listener in when I say we must have more perfect reception; and the only way to have it is to get together, to organize in an effort to clear the air.

"We have already won a victory in this direction by getting N. S. S. to lay off for a period of the evening broadcasting, as this station's harmonics are a source of great disturbance between 400 and 500 meters.

"Now the point I am driving at is right here: The greatest offense, to my mind, is the reception of howling, sirenlike oscillations transmitted from local regenerative receivers. This is caused by improperly tuning in and it is true that most listeners are ignorant of the fact that the squeals they make with the dials are being transmitted to and received by their neighbor; although there are some who deliberately prolong these noises knowing full well that they cause annoyance to others.

"Imagine you were enjoying an interesting program at the theater when suddenly a member of the audience created a disturbance. What would happen? Why, the offender would soon be located and punished. I know of a case where a man was fined \$50.00 merely for sneezing during a show, and because he made a practice of one loud sneeze just to get a laugh.

"What we badly need are 'Radio cops' to keep a lookout for deliberate offenders, and to regulate the traffic of the air as that of the streets.

"I listened in on my seven-tube neotrodyne receiver to the message of our President on the evening of February 12; it was an elaborate joint broadcast, most of the other stations remaining silent out of courtesy to the President. It came in perfectly wonderful for a while, until somebody started to play jazz on their tickler knob, that uncanny 'song' of wails and moans; then a ship operator broke loose with his call for position, and it was good and broad too—he sat on his key to make sure he would get it over anyone else.

"This goes to show how a powerful signal, even joint broadcast, can be absolutely ruined by interference from wild oscillations or spark signals of local origin. The task of eliminating spark transmission of ships and installing C. W. on a suitable wave length is difficult, and it seems very inconsistent for the listening public to expect commercial Radio to cut out all interference, while we make no effort to control our own diabolical oscillations and put an end to re-radiation of our receivers.

"If we want more perfect Radio reception, we should begin to improve it right at home, by learning to tune properly and by studying our instrument or equipment and the tricks of the Radio wave. Thus, if every listener does his part, we shall all have more pleasure in satisfaction, and there'll be no need for excuses."

RADIO INDI-GEST

The cannery has been strengthened by the addition of another aged and pensionable joke. Yes, we mean that one about Adam having had the first loud speaker, and its multitudinous variations. Try to make the column with it once!
Indi.

Why a Hook-Up After the Lightning?

Dear Indisgust: i gota da radeeio. i gota da chine ona beeu (shust a vase). me no likie slowa da signals so greezie da anten. segual coma da 2 fast. put ona da brakes like youall southerners. beema noa workie likie beeu should. i gota da rheostat, ceastal, anten, count or piose, & static aid-de-camp frum zee \$witzlanders. mi anten gota da hit bi da litening. ples publish hickup fur ze abuv mensioned things. Yurs Troolie
P. S. mi neerst relatives iss G. Rid & mi most disstant re late ive iss Phill A. Mint.
Dr. P. L. ATE.
Dr. P. L. A.

Ah, the Radio Lollypop Co., Ins. (Insulated)

Dear Indi: Yes we have no more rosin core solder and also have no 22 dec or sc wire, etcetera, but will have some pdq again. This reminds us of the Reinartz coil—which will make it necessary for us to buy seventeen chöcolate suckers and throw away the candy end just to get the handles, dowel pins, or spokes—as you will have it. Therefore why not have some candy company broadcast the information that for making spider web coils, THEIR particular brand of lollypop has high-grade bakelite handles, well adapted to use as spokes on aforementioned coils. WARNING: Don't give your children bakelite suckers. They may become Radio-knuts.
HANS.

Miss Terry Mann's Souper Improvement

Dear Indi: I am enclosing Kink herewith which I know will supersede the Stebbin's Souper-Degenerative set. It took me 1461 days (four years, one a leap) to perfect this—and at last, I give the public a set that will send and receive QRM from coast to coast. Now let me explain.

The nearest thing to the antenna is a grid leak. This distributes the impedance of the arrows on the variable high-jinks. Notice the aerial is connected to the ground. This is unique. (It certainly is.—Indi.)

The lead-in is tapped by a thirteen-turn coil. I should have used a pre-Volstead spiggot to tap the lead-in but I wanted undamped waves. The coil is marked A. From here we go to the special triplex coil C, which splits up the waves in three parts for the three-part governor below. The governor holds down the speed of the set, preventing the fox trots from becoming one steps.

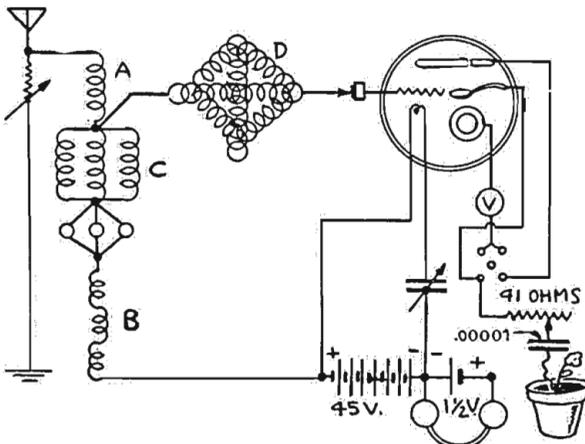

Tapped ahead of C is my special fixed variometer. (Drive a nail through the stator into the rotor, and you have it.) Then a crystal is impinged for rectification purposes etc., before entering the five-element tube. Now go back to the governor.

The governor shoots the juice through a twice reversed-English becwax coil B and thence to the 45-volt battery used to light the 6-volt filament. However, I cannot claim this last idea is original, although it never has been patented. The variable condenser in the filament lead incapacitates the battery effectively, thus preventing the filament from alighting. Note that the phones are connected to a 1 1/2-volt filament heating battery which keeps the phones hot when using them in the winter.

The special 5-element tube embracing a complete silverware set for the reception of dinner music. The knife also gives very sharp tuning while the spoon scoops up all escaping electrons which will, like peas, drop off the knife. The voltmeter attached to the plate is there for some reason but I can't remember what it is now, while the 5-point switch below allows variations too numerous even to mention. The spoon is grounded to a flower pot through a .00001 fixed condenser and 41-ohm rheostat (odd size so the manufacturers will have something new to manufacture).

Be sure to have all the condenser plates engraved with your initials so the announcers will know who they are talking to.
MISS TERRY MANN.

I'm Stuck on the Radio "Glues"

Hush! and listen!
Hush! and listen!
I've got the Radio "Glues";
Sit up closer to me dear
(Anything you want to hear)
Tell me baby what you want to choose.

There's a man in Indiana
A playin' the piano
Such harmony we never want to lose;
Another one in Maine
Can't quite get his sayin'
So let's tune in on New York for the news.

Don't you worry, Honey!
We don't need no money
For we'll never get a bill for the dues;
Yes, I'm getting thinner—
Don't care dear for dinner
Since I've got the Radio "Glues."
A. C. M.

They Request Him to Leave the Studios

Dear Indi: Can you please tell me who this Mr. Request is? I hear him regularly at different stations. How does he get from one place to another so quickly? The station announce a song or musical selection to be sung or played by Request.
S. TEDDY LISSENER.

Maybe Her Iron Was a Radio Flat

Dear Indi: Clipping from Cleveland News says that at Urbana, Ohio, a farmer's wife was ironing in the kitchen when she heard very faint music. Going outside, she heard no music. Returning to her ironing the music resumed. She claims the flatiron was shimmying on its point to the tune, "After the Wash Is Over." She blames Radio for the "phenomenon." We say people in Ohio have great imaginations. What do you say?
ARCH.

Is It Too Warm for You, Mr. E. C. Mills?

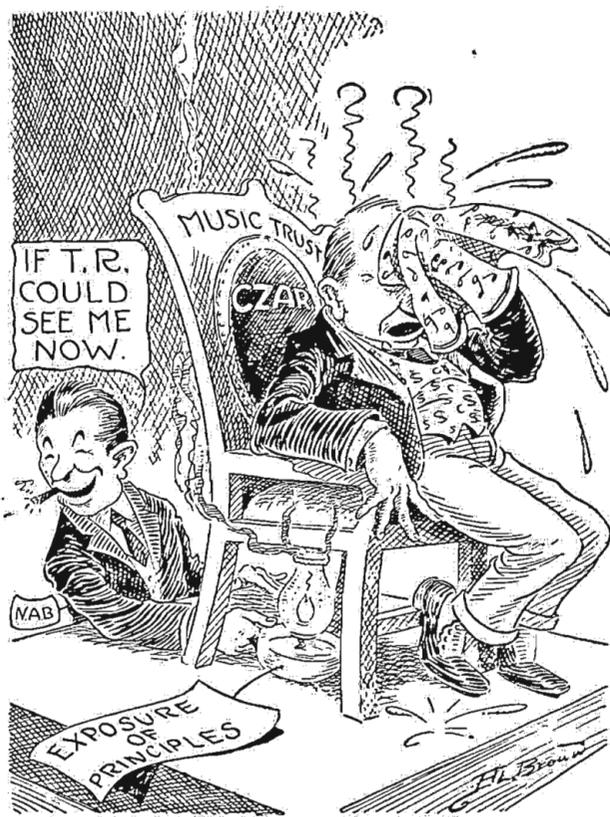

Condensed

By DIELECTRIC

Two rather interesting features connected with Radio broadcasting in Canada are: the number of stations and the proposal for a new one, out of the ordinary. The Canadian Government exacts a license fee from all owners of receiving sets in the Dominion, the number of whom has been estimated at over 100,000, and interest is increasing very rapidly as the sales of sets testifies. As in the United States, the total of broadcasting stations has fallen off since last year. Instead of sixty-three there are now thirty-eight. Many stations in the States are picked up regularly, in addition, by their Radio audiences. It is planned to install Radio equipment in the House of Parliament for broadcasting principal speeches made there. If this plan goes through, it is likely there will be a "Radio master" to prevent anyone monopolizing "mike."

Since so many tests have been made, it has been pretty well established that many seemingly totally deaf have found to their joy the ability to hear sound when received in a Radio set. Not only are their sources of pleasure added to by this discovery, but in a large number of cases acuteness of hearing has steadily improved. Radiophony cannot do so much for thousands afflicted with blindness, in so far as remedial measures go, although from a purely entertaining viewpoint their advantage is great. In most of the blind the sense of hearing is far superior to that of a normal person and with it, often, goes a retentive memory. This last attribute has enabled a young musician of Elk City, Kansas, to get much of value from his receiving set. He wrote to WEAJ stating his condition and expressing appreciation of hearing the latest popular music, which he learned in this way.

It does look as though some of the mighty are beginning to see the light! Mr. Quigley was once one of those who supported the claims of the society responsible for stirring up all the fuss about broadcasting music. Today he is one of the increasing number who see in broadcasting a distinct benefit. So impressed has he become with the value of Radio to music publishers that a special Radio department has been established by him. Mr. Quigley is general manager in the United States for a Canadian music publisher and is located in Chicago. Waterson and Rossiter have also seen the light.

Our schools are affording splendid chances for ambitious students to acquire thorough knowledge of Radio. That some do is proven by the recent two-way code transmission between England and the United States under the supervision of a school boy of eighteen representing the former. The Mill Hill school, near London, established communication with Haverford College, Pittsburgh, and Maine University, besides Montreal and Halifax, N. S. This is probably the first time Radio societies in educational institutions, both here and abroad, have conversed, and I am one of those who hope for many more such "get togethers."

Reception of Radio broadcasts over long distances is still an infrequent occurrence, and each report of successful attempts of this character incites new interest. Not long ago the broadcasting station of the General Electric company at Schenectady, N. Y., received a letter from Cape Town, South Africa, an air line distance of 7,880 miles, containing the log of a program broadcast from their station. Every number contained in the log checked with the program as broadcast. Those who are in the habit of listening in for the purpose of trying to pick up an American station must feel a thrill when any of our call letters are heard. We try to entertain everybody.

First Aid and Helpful Hints for Listeners In

Chapter II—Peculiarities of Regenerative Receivers

By Peter J. M. Clute

THE proper method of manipulation of a regenerative receiver can only be fully acquired as the operator learns to completely understand the functions of all the devices which constitute the receiver, and acquaints himself with the various peculiarities of operation.

In regulating the filament current of the vacuum tube, the rheostat should be varied until clear signals are heard, after tuning them into maximum strength. The loudest and clearest signals are generally obtained when the filament rheostat is adjusted to the point just below where the clicking sound is heard in the phones. Inasmuch as the plate potential for most vacuum tubes is critical for best results, either a B battery of the variable voltage type can be used or a rheostat can be connected in series with the battery in the plate circuit, or for most accurate adjustment, a potentiometer may be used with the B or plate battery. The use of a potentiometer affords a very delicate control for plate potential regulation.

Place of Detection

When the vacuum tube is employed as a detector, it is usually preferable to connect the grid return to the positive side of the filament with the rheostat in the negative side, as in Figure 1. This is done in order to get the correct free grid potential for the tube, so that it will operate on the right portion of the characteristic curve for the tube. Detection takes place at the lower portion of the curve where the change in slope is great. By changing the rheostat position, the grid potential may be so regulated that the operation of the tube will be shifted to that portion of the characteristic curve where best results are obtainable.

Each detector tube, even among tubes of the same type, has a definite value of grid leak resistance at which it performs most efficiently. The exact value for maximum efficiency is found by trial. When the grid is charged at a negative potential by an incoming impulse, the plate current is thereby reduced, inasmuch as this charge repels the negatively charged electrons trying to pass from filament to plate. Vice versa, a positive grid charge allows

the electrons to pass freely to the plate, causing an increase in plate current.

When no signals are being received, the electron flow from the heated filament is continuously causing the grid to be negatively charged, and if this condition persists, the plate current would eventually cease to flow. In order to prevent this, a

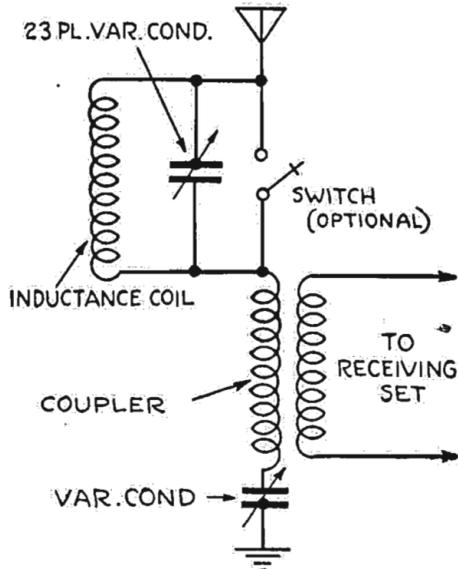

Figure 1.

grid leak is provided so that the accumulated negative grid charge may leak off whenever it becomes excessive. Hence the value of grid leak resistance selected determines the maximum negative charge that can accumulate on the grid. An adjustable or variable grid leak should be provided, so that the proper value of resistance may be obtained, thus helping to keep the free negative grid potential at the correct value for best operation as a detector.

Adjustment Maintained

Once adjusted, a regenerative set will

maintain its adjustment fairly well and only occasionally will tuning adjustments be necessary. Regulation of the rheostat in the filament circuit may also be required at times to improve the quality or strength of reception.

Frequently operators of regenerative sets will search for stations by throwing the vacuum tube circuits into oscillation, and by simultaneous adjustment of both grid and plate circuits, keeping the circuits in oscillation while varying the wave length over a wide range. In this condition, the vacuum tube acts as a generator of Radio oscillations, which are transferred to the antenna circuit and radiated into space. Even the three-circuit receiver may cause interference in nearby sets when the vacuum tube circuits and antenna or primary circuit are approximately in resonance.

Tuning in distant stations is often accompanied by squealing and howling. A reduction of the plate potential of the detector tube will eliminate some of the oscillations causing this trouble, which will be more noticeable in DX reception than in local reception. Local signals are stronger than the self-oscillations, but distant signals are distorted because they are weaker, and hence are partially drowned out by the self-oscillations of the detector tube. Reducing the plate voltage will cut down the local oscillations and the plate variometer or tickler coil may be used to control regeneration to a much finer degree.

Sensitivity and Selectivity

From the standpoint of both sensitivity and selectivity there is little to choose between the two methods of tuning the grid circuit, that is, with a variometer in series with the secondary or with a

variable condenser in shunt with the secondary winding. Both schemes employ the same principles of electrical resonance, except that in one case the inductance is predominant while in the other case the capacity predominates.

The variometer method would be preferable from the standpoint of sensitivity, inasmuch as it allows greater inductance in the secondary circuit, with a correspondingly higher turn ratio between primary

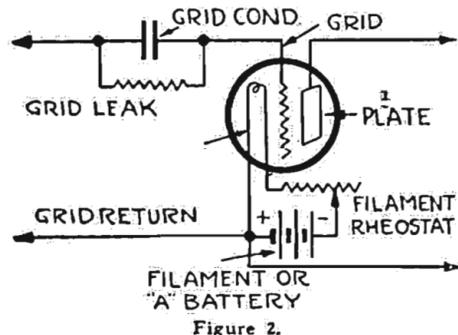

Figure 2.

and secondary circuits. This would produce a higher grid potential provided other conditions of resonance are fulfilled. It is only possible to use this method on the lower or broadcasting wave lengths.

The condenser-tuned method would be desirable from the selectivity standpoint, giving an oscillatory circuit in which the frequency is variable with a change in capacity. The condenser capacity is large in comparison with the tube capacity and body capacity, thus indicating that the latter will have no appreciable effect upon

(Continued on page 22)



WHOLESALE RADIO SERVICE COMPANY

9 Church Street
New York City

Formerly at 39-41 Cortlandt St., New York City.

5 TUBE NEUTRODYNE SET

Consists of:

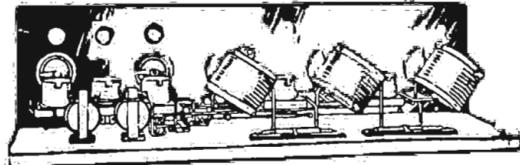

- 1 7x26 Baseboard
- 3 Neutroformers.
- 1 Columbia Neutrodons
- 5 Nat'l Bakelite Sockets
- 2 Jefferson Transformers
- 2 Filament Control Jacks
- 1 Cut-Hammer Battery Switch
- 1 Bestone Power Rheo and Dial
- 1 30 ohm Bestone Rheo and Dial
- 1 7x20 Drilled Panel
- 1 .00025 Dubilier Condenser
- 1 2 Neg. Leak
- 2 .006 Mica Condensers
- 8 Binding Posts Spaghettd, Wire, Blueprint and Booklet.

When this set is hooked up you will be entertained by broadcasting stations thousands of miles away. You will enjoy a revelation of selectivity, volume, distance and clarity. With the dial readings of a station recorded, it can always be tuned in again to the same settings, maintaining at the same time loud-speaking intensity and clarity of natural reproduction.

\$32.50

Included in the set is drilled panel, ready for mounting and wiring.

A FADA book FREE. Complete 5-TUBE NEUTRODYNE, built of genuine FADA parts, in a fine mahogany cabinet, ready to operate and pull in the long distance stations on the loud speaker, only **\$85.00**

(This does not include tube or batteries)

8 TUBE SUPER-HETERODYNE

The popular 8-tube Super-Heterodyne Receiving Kit, consisting of the following parts:

- 1 Oscillo-Coupler Type S. W. 21
- 1 Tuned Filter Coupler Type No. 34
- 1 ATX Audio Transformer
- 1 AT 3 Audio Transformers
- 2 C 1000 Bypass Condensers
- 3 Radio Frequency No. 1716, 5000 to 25,000 Meter Intermediate Frequency Transformers
- 1 Super-Heterodyne 65-Page Manual—blueprints, panel layout and templates Complete for only **\$65.00**

3-Tube Regenerative Long Distance Receiver Built in a good-looking mahogany cabinet ready to operate **\$49.50**

Radio Corporation Radiola VI—6-tube set ready to operate. Regular price, **\$85.00** \$275. Our Price **\$85.00**

A limited number on hand

ORDERS SENT C. O. D.

WE SELL RETAIL AT WHOLESALE PRICES

The Radio Corporation's NEW RADIOLA III 2 TUBE SET

The Radio Corporation unconditionally guarantees this two-tube set to receive from broadcasting stations 2,000 miles distant on the loud speaker. This receiver complete with 2 W.D.11 Tubes, Phones and "B" Batteries for only **\$39.75**

These sets are difficult to get, but we have a limited number, so act at once!

Freed Eisemann 5-Tube Neutrodyne Knock-down **\$72.50**

Freed Eisemann Neutrodyne Kit—3 Neutroformers and 2 Neutrodons... **22.50**

Fada Neutrodyne Kit—3 Neutroformers and 2 Neutrodons... **23.75**

Columbia Neutrodyne Kit—3 Neutroformers and 2 Neutrodons... **15.50**



RADIO AT N.Y. PRICES



Via Daily Parcel Post

The Prices Quoted Below Deliver Goods to Your Door HOW TO ORDER—Write your order plainly; state number, description and price of items wanted. Send Post Office or Express Money Order, personal check or bank draft. REFERENCES: R. G. Duns, Bradstreet, Corn Exchange Bank, N. Y. City.

Build your own favorite circuit at a great saving. Note the prices of these knockdown combinations, made up of guaranteed parts, complete, ready for assembling.

COCKADAY SET COMPLETE

- 1 Cockaday Coil.
- 2 .0005 Variable 23 pl. Condensers.
- 1 Socket.
- 1 Panel 7x18.
- 2 3-inch Dials.
- 1 Grid Leak & Condenser.
- 1 Rheostat.
- 1 Switch Lever.
- 7 Switch Points & 2 Stops.
- 8 Marked Binding Posts.
- 5 Lengths Bus Bar.
- 1 Base Board.
- Diagrams and Instructions.
- 7 Pig Tail Connections.
- D242 All guaranteed parts, complete... **\$11.45**



5-Tube Neutrodyne Complete with Standard Parts, including Drilled and Engraved Bakelite Panel.

OUR PRICE **\$38.50** D244

DIETZEN SUPER SET COMPLETE

- 1 Dietzen Super Coil.
- 1 .0005 Variable Vernier 23 pl. Condenser.
- 1 Socket.
- 1 Rheostat.
- 1 Switch Lever.
- 1 7x10 Drilled Panel.
- 7 Pig Tail Connections.
- 8 Marked Binding Posts.
- 2 3-inch Dials.
- 4 Lengths Bus Wire.
- 1 Grid Condenser .00025.
- 1 Grid Leak.
- 7 Switch Points—2 Stops.
- 1 Base Board.
- Diagrams & Instructions.
- D243 All guaranteed parts, complete... **\$11.45**



WAVE TRAP Simplifies tuning. Eliminates interfering stations, thereby improving the selectivity of your set. Selects between conflicting stations. Special while quantity lasts.

D131 Each... **\$4.95**

RASLA REFLEX SET COMPLETE

- 1 Bakelite Silk Wound Variometer.
- 1 .005 Variable 23 Plate Condenser.
- 1 Socket.
- 1 Rheostat.
- 1 7x12 Drilled Panel.
- 8 Marked Binding Posts.
- 1 Modern 13 to 1 Transformer.
- 1 Rasla Reflex Transformer.
- 2 3-inch Dials.
- 1 Fixed Crystal Detector.
- 1 Base Board.
- 4 Lengths Bus Bar.
- Diagrams & Instructions.
- D240 All guaranteed parts, complete... **\$19.85**



REINARTZ SET COMPLETE

- 1 Reinartz Coil.
- 2 .0005 Variable.
- 1 Socket.
- 1 Rheostat.
- 3 Switch Levers.
- 1 7x14 Panel.
- 8 Marked Binding Posts.
- 2 3-inch Dials.
- 4 Lengths Bus Wire.
- 1 Grid Condensers .00025.
- 16 Switch Points—6 Stops.
- 1 Grid Leak.
- 1 Base Board.
- 16 Pig Tail Connections.
- Diagrams & Instructions.
- D241 All guaranteed parts, complete... **\$12.45**

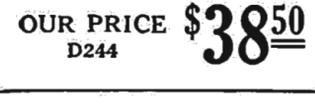

DIETZEN SUPER HEAD SET D181 2200 Ohms **\$2.95**



Reg. Price, \$5.00 per Pair. Since we are wholesale distributors for this wonderful headset we pass this bargain on to you. The Tone quality is of unusual volume. These phones can be used as a loud speaker unit. Sold with a money back guarantee, if not satisfactory.

- D164 Synthetic Crystal... **\$0.30**
- D165 Ground Clamps... **.17**
- D166 Black Rubber Binding Posts... **.05**
- D167 Nickel Plated Binding Posts, 2 for... **.05**
- D168 No. 18 Annunciator Wire, half lb. coil... **.39**
- D169 6 ft. Phone Cord with Tips... **.79**
- D170 20 ft. Extension Cord with Tips... **1.95**
- D171 Wall Insulators, Porcelain... **.10**
- D172 Tubular Porcelain, Lead-In Insulators, 6... **.10**
- D173 Reinartz Coil... **1.95**
- D174 Cockaday Coil... **2.45**
- D175 2-in. Dial and Knob... **.25**
- D176 3-in. Dial and Knob... **\$0.35**



RADIO CABINETS

Highest grade Mahogany piano finish Cabinets. Hinged top. These cabinets are being sold at less than one-half regular value.

- D57 Wood Cabinet; panel size 7"x10". Each... **\$2.95**
- D58 Wood Cabinet; panel size 7"x12"..... **3.45**
- D59 Wood Cabinet; panel size 7"x14"..... **3.95**
- D60 Wood Cabinet; panel size 7"x18"..... **4.45**
- D61 Wood Cabinet; panel size 7"x21"..... **4.95**
- D62 Wood Cabinet; panel size 7"x24"..... **5.75**
- Baseboards (Mah. Stained) for above cabinets
- 7x10.....25c 7x14.....35c 7x21.....45c
- 7x12.....30c 7x18.....40c 7x24.....50c
- D177 Switch Arm Tapered Knob... **.19**
- D76 Indoor Loop Aerial Knob... **.79**
- D132 Double Phonograph Attachments... **.85**
- D180 Single Phonograph Attachments... **.49**
- D140 3 Coil Honeycomb Mountings... **3.79**
- D142 Single Honeycomb Mountings... **.40**
- D120 Two Phone Plugs... **.49**
- D118 1 Spring Open Circuit Jack... **.39**
- D119 2 Spring Close Circuit Jack... **.49**
- D110 23 Plate .0005 Mfd. Variable Cond... **1.75**
- D115 23 Plate Vernier Variable Cond. with Knob and Dial... **3.45**

Modell's ESTABLISHED 1925

71 Cortlandt Street
NEW YORK, N. Y.
America's Greatest Radio Mail Order House
ELEVEN NEW YORK STORES

HINTS FOR LISTENER IN

(Continued from page 21)

the tuning. If the capacity of the condenser is too high, the signal strength will be lessened and tuning will become extremely critical. Also with exceedingly low minimum capacity, the capacity of the circuit will approach the value of body capacity, and it may be affected thereby.

Simultaneous Adjustment

If, while tuning a regenerative receiver, the antenna circuit and the vacuum tube circuits are kept in approximate resonance and if the incoming signal strength is sufficient to give audible sounds, the station can be brought in by a simultaneous adjustment of both grid and plate controls, the relative settings of both being maintained so that the circuits are just below the point of oscillation. If a station has been picked up by an adjustment of the wave length of the vacuum tube circuits, the antenna or primary circuit should immediately be regulated for maximum strength. A slight readjustment for greater signal strength may then be made in the vacuum tube circuits, with a very slight shifting of the coupling control setting.

With the receiver circuits in oscillation and the wave length settings varied so as to tune quite closely to the wave length of a broadcasting station, the oscillations transmitted from the broadcasting station will be impressed upon the circuit, in addition to the local oscillations produced by the receiver. The superimposing of these two trains of oscillations results in a series of "beat notes," if there exists even

a slight difference in frequency between the local oscillations and the oscillations from the broadcasting station. "Beat reception" is the phrase applied to signal reception by this method. While the receiver is in oscillation and so adjusted that its oscillations have exactly the same frequency as the incoming oscillations, there will be so-called "zero-beat reception," inasmuch as there is no frequency difference, and hence no beat note.

Grid Circuit Controlling Feature

Since the circuits in a receiving set are all electrically interlinked, it is obvious that a slight change in one will react upon the others in proportion to the degree of coupling between them. If the grid circuit has been carefully adjusted, a little variation of either the coupling, the antenna or the plate circuit control will necessitate a corresponding change in grid circuit control setting. In all cases, the setting of the grid circuit is always the controlling feature.

For making final adjustments of controls, vernier attachments should be used if possible. Perhaps the most bothersome of troubles in any set is that due to body capacity effects. Body capacity causes the wave length to which the set is tuned to vary when the operator's hand is brought near to or taken away from the tuning dials. After tuning in a distant station and making careful adjustments, it is very discouraging to have the signal fade away as soon as the hand is removed from the dial. The use of a metallic shield is sometimes resorted to, although the presence of such shields within the magnetic field surrounding the coils in

the set gives rise to losses. Body capacity effects may be eliminated by the intelligent disposition of the various units and the wires connecting them, so that those parts of the units near the panel or projecting through it and those leads nearest the panel are at earth potential, at least insofar as Radio frequency currents are concerned.

Howling Noises

One of the effects of advancing the adjustments of the regenerative control above the setting of the grid circuit is to produce a disagreeable howling noise, due to the condition existing when the circuits are oscillating and a charge accumulates on the grid of the detector tube much greater than the grid will dissipate. The alternate accumulation and gradual leaking off of these heavy grid charges results in the effect cited above. This effect is not very noticeable in soft or gas-content vacuum tubes, but it will nearly always be quite pronounced when the hard

or highly evacuated type of tube is employed as detector. Careful adjustment of the grid leak will be necessary to provide a suitable path for charges to leak off the grid as fast as they accumulate.

With ordinary tuning equipment, receiving sets located near powerful broadcasting stations find great difficulty in tuning out such stations to listen in to stations at a distance. To accomplish this a wave trap, such as shown in Figure 2, should be used to assist in obtaining sharper tuning. The wave trap consists merely of a 40 or 50-turn coil shunted by a 23-plate variable condenser and connected in series in the antenna circuit. A switch may be placed, as shown, to shunt the trap when not needed. It should be left open when the trap is being used to tune out the nearby broadcasting station.

Reducing Spark Interference

Reducing spark signal interference, (Continued on page 24)

PEERLESS RADIO, 349 Fulton St.

BROOKLYN, N. Y.

Parcel Post prepaid on all orders above \$5.00. Express Money Order, Certified Check, Bank Draft accepted; also C. O. D. Guarantee with all merchandise.

LOUD SPEAKERS Magnavox (new type).....\$27.25 Music Master.....25.45 Pathé (new type).....16.50 Dictogrand.....13.25 Stromberg Carlson.....17.75 Mercury with Baldwin Unit.....9.95 Natl. Baldwin Type C Unit.....4.85 Manhattan Electric.....22.50 Brandes Table Talker.....9.95 Acousticola Phonograph Unit.....9.45	HEATH'S RADIAN VERNIER CONDENSERS 13 Plate.....\$4.75 23 Plate.....5.25 43 Plate.....5.95 VARIOCOUPERS Fisher, 180°.....\$2.35 Shamrock.....2.65 Sleeper, no taps.....3.75 Workrite.....2.95 Gillfillan, small.....5.95 Gillfillan, large.....7.45 Pathé.....3.25 Genuine All Wave.....5.35 Cockaday Coil.....1.85 Unxid, 180°, Bakelite.....1.95	PHONES Neroo.....\$2.35 Pacent.....3.45 Brandes Superior.....4.85 Federal.....4.95 National Baldwin Type C.....7.95 Dr. Seibt, German Phone, 6000 ohms.....5.85 Western Electric.....8.85 Ambassador.....3.50 Potter Precision.....4.25 Wiener Phones.....3.95
VARIABLE CONDENSERS 11 Pl. Admiral or Signal.....\$1.35 17 Pl. Admiral or Signal.....1.60 23 Pl. Admiral or Signal.....1.65 43 Pl. Admiral or Signal.....1.75 11 Pl. Montrose Vernier Cond.....2.55 17 Pl. Montrose Vernier Cond.....2.75 23 Pl. Montrose Vernier Cond.....2.85 43 Pl. Montrose Vernier Cond.....3.65 11 Pl. U. S. Tool.....3.35 23 Pl. U. S. Tool.....3.65 43 Pl. U. S. Tool.....4.10	VARIOMETERS Fisher, large, 600 meter.....\$2.55 Shamrock.....2.65 Sleeper.....5.65 Workrite.....2.95 Gillfillan, small.....4.95 Gillfillan, large.....7.45 Pathé.....2.85	TRANSFORMERS Acme Audio and Radio.....\$ 3.90 All-American (all ratios).....3.90 Federal No. 65.....5.95 Modern.....4.95 Thordarson.....3.95 Erla Reflex and Audio.....4.45 Akrcy.....3.35 Modern Push-Pull.....10.75 Como Push-Pull.....10.75 Rasia Transformers.....3.95
CYCLONE BATTERIES Small 22½ Volt.....\$.75 Large 22½ Volt.....1.75 Medium 45 Volt.....2.30 Large 45 Volt.....3.45 Large 22½ Volt Eveready Battery.....2.35 Large 45 Volt Eveready Battery.....3.65 Small 22½ Volt Eveready Battery.....1.15 Eveready "C" Battery, 4½ Volt......55	HARD RUBBER PANELS 7 x 10.....\$.70 7 x 12......90 7 x 14.....1.00 7 x 18.....1.40 7 x 21.....1.65 7 x 24.....1.85	MAHOGANY CABINETS 7 x 10.....\$2.45 7 x 12.....2.65 7 x 14.....2.80 7 x 18.....3.05 7 x 21.....3.35 7 x 24.....3.65
MISCELLANEOUS Bell Socket, Bakelite Panel Mounting.....\$.69 Amco 6 ohm Rheostat......95 Amco 20 ohm Rheostat.....1.15 Amco 30 ohm Rheostat.....1.25 Amco 400 ohm Potentiometer.....1.40 Cutler-Hammer 6 ohm Rheostat, Plain......95 Cutler-Hammer 6 ohm Rheostat, Vernier.....1.20 ELECTRAHOT Solder Iron.....2.50 New Improved Cockaday Coil.....5.50 Pathé Pairsformers.....\$8.50 New Improved Cockaday Coils, silk wound.....5.50 Cutler-Hammer 30 ohm Rheostat, Plain.....1.20 Cutler-Hammer 400 ohm Potentiometer.....1.20 Filokstat.....1.85 Bradleystat or Bradleyleak.....1.70 Bruno 14 Tap Inductance Sw......70 Sta-put Phone Plug......35 Phone Plug for 6 pr. Phones.....1.25 Phone Plug for 2 pr. Phones......60 Single Circuit Jacks......35 Double Circuit Jacks......45 4" Dials, Fada Type......45 3" Dials, Fada Type......30 Triple Sockets, Fada Style.....2.65 Marked Eby. Bind. Posts, Ea......17 Ambassador Coil.....5.95 Shelton Midget Vernier.....1.40 Freshman Grid Leak & Cond......75		

\$25 for \$10

The Famous Bel-Canto Acoustical Amplifier

Direct from Manufacturer to You!

YOU cannot buy the Bel-Canto through any dealer; only direct from us. We save you these three profits—Distributor, Jobber and Dealer.

Delivered C. O. D. Free to your door

Sent prepaid to any part of U. S. and Possessions

PRICE \$10

Bel-Canto Mfg.

BENSIL-BONIS, INC., Dept. R. D.
General Office & Factory, 417-419-421 E. 34th St., N. Y. C.
Telephone 8959 Vand.

7 POINTS OF BEL-CANTO SUPERIORITY

1. Our own Fiber horn. Crystalline finish.
2. Our Own adjustable loud speaking unit, giving a wide range of tone quality and volume without dist.
3. The base of cast iron, weighing four pounds, eliminating top heaviness.
4. All other metal parts are of heavy cast aluminum, highly polished.
5. Complete instrument stands 24 inches high, 19-inch bell.
6. Guaranteed for one year from date of purchase against all mechanical defects of any kind.
7. No auxiliary batteries required. Just plug in on 2d stage.

Guarantee

Money back any time within ten days if dissatisfied. We further guarantee to the publication carrying this advertisement that each and every speaker sold will be exactly as advertised in this issue.



Your Choice FREE Limited Supply

Your prompt action gives you one bound volume with each annual subscription. New or renewal.

Greatest Collection of Radio Information

A. B. C. Lessons for Radio Beginners.
Two, Three, and Four Tube Reflex Circuits.
The Famous Mitelplex with Various Hook-ups.
Reinartz Long Distance Circuits—Ultra Reinartz.
Flewellling Popular "Fliver" Circuit.
Single Tube Reflex Circuits—Super-Heterodyne.
Five Tube Neutrodyne, Special R. D. Hook-ups.

In addition to these features, the current issues give you all the live news of Radio. The popular Q. and A. Department, How to Operate Your Set, Advance Broadcasting Stations Programs, and a correct list of all Broadcasting Stations.

RADIO DIGEST, 123 W. Madison St., Chicago

Check Offer Desired

One year's subscription, and choice of one volume. Send Vol. Enclose.....\$3.00

One year's subscription, and choice of two volumes. Send Vols..... 7.00
Additional Bound Volumes at \$2.00 each.

Name.....
Address.....
City..... State.....

65 Copies

Serving as a Radio Reference Library
You receive 52 issues with your Subscription and 13 issues in each bound volume
Bound Volumes 3, 4, 5 and 7 now ready.

This offer good only in U. S. and Possessions, and Canada.
This offer not good through dealers or subscription agencies, but must be sent us direct with the full subscription price. Remittance must be by check, money order or draft.

SELECTIVITY

A Committee in Philadelphia hears 49 stations from Cuba to Los Angeles sign off in 8½ hours (2 tubes used)

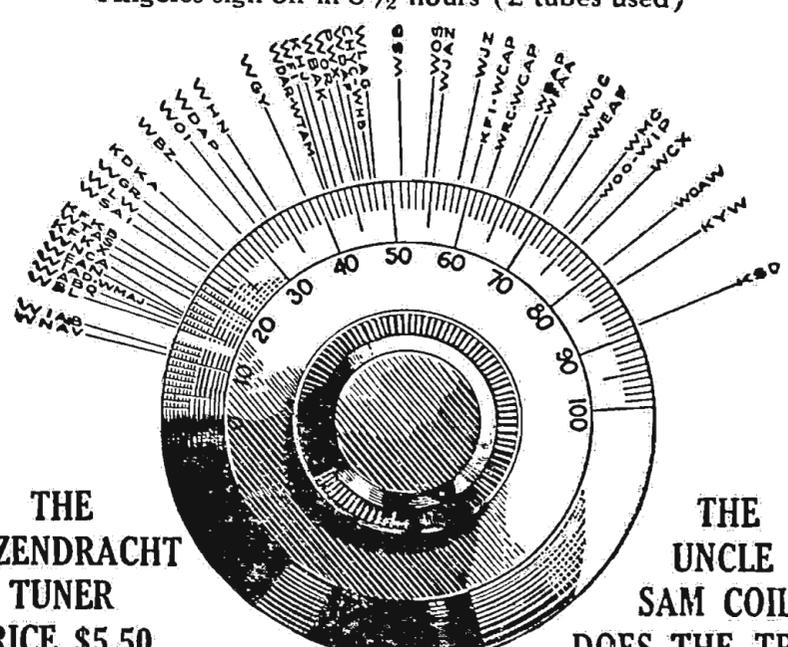

THE LITZENDRACHT TUNER

PRICE \$5.50



THE UNCLE SAM COIL DOES THE TRICK

REMEMBER THE NAME—UNCLE SAM—THE ORIGINAL 3-CIRCUIT TUNER. IN THE RECENT "NEW YORK EVENING WORLD" DX TEST A SET USING THIS COIL WAS THE ONLY ONE WITH A PERFECT SCORE.

Ask your dealer or write direct for free hookup

UNCLE SAM ELECTRIC CO., Plainfield, N. J.

Improvements in the R.D.-102 Single Tube Reflex

Distance Reception Is the Qualification of This Circuit

By J. P. Flaherty

COMPLYING with the demand of the vast number of Radiophans who have become very much interested in the reflex circuit published in the November 10 issue of Radio Digest, as R. D.-102, for further information concerning its construction and operating factors, the designer has decided, through the courtesy of Radio Digest, to republish this circuit in full detail, including some improvements, together with a complete list of parts and facts regarding its operation.

The first matter of importance is that all apparatus must be of very best quality; second, the values indicated in the diagram must not be altered, since a small change will, in most cases, cause the two frequencies to become unbalanced, and result in a jumble of sounds, instead of voice and music; third, a little patience is necessary before one becomes acquainted with its peculiarities in tuning, and when this is accomplished, the circuit is no more difficult to tune than any other. It should

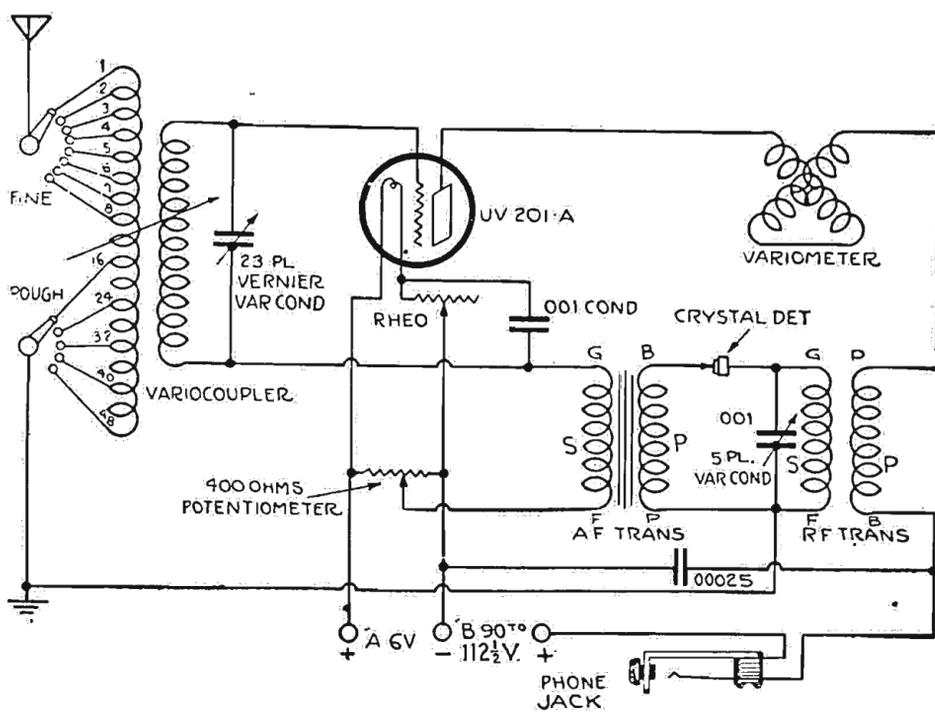

changes shown in the crystal detector circuit. Formerly the crystal was merely "throwing" a crystal detector between the two transformers. The variable condenser proves to be a big advantage in the crystal circuit. The crystal detector may be of the cat whisker type, or a fixed one; the latter is my choice. It is a fact, that a crystal which gives excellent results in a straight crystal set will sometimes prove valueless in the reflex. Therefore many should be tried in order to find a good one.

Wiring the Set

In wiring the set, prevent leads from coming in inductive relation to each other. It is important that grid lead is separated as far as possible from ground leads.

For the benefit of the beginner the following suggestions for tuning the set are given: If a fixed crystal is used, turn up filament about one-half of rheostat resistance; set all variable instruments at one-half their maximum value; then cut in primary of coupler, beginning with a few turns and increasing one turn at a time, until a signal is heard, or when the tube starts to oscillate. In the latter case, adjust variometer till signal clears up; then proceed tuning more sharply by adjusting rotor of coupler and secondary condenser. At this stage, if the signal is not clear, adjust potentiometer and then

(Continued on page 24)

LIST OF PARTS

- 1 R. F. transformer, reflex type.
- 1 A. F. transformer, ratio 9 to 1, shielded type.
- 1 201 A tube.
- 1 tube socket.
- 1 25-ohm rheostat.
- 1 400-ohm potentiometer.
- 1 phone jack.
- 1 fixed mica condenser, .001 mfd.
- 1 fixed mica condenser, .0025 mfd.
- 1 23-plate variable condenser, .0005 mfd., vernier.
- 1 5-plate variable condenser, .0001 mfd., plain.
- 1 variometer.
- 1 variocoupler, 90-degree type, loose coupled.
- 1 crystal stand and crystal for 1 fixed crystal.
- 13 contact switch points and 4 stops.
- 2 switch arms.
- 6 marked binding posts.
- Block of B batteries, 90 to 112½ volts.
- 1 6-volt storage battery.
- Number 14 wire for connections.

be realized that this circuit is very critical and sensitive; therefore care should be used in tuning.

Important Parts of Set

The following are data of importance in this hook-up: Beginning with the aerial, it is 100 feet long and of average height; 90° variocoupler is used, loosely coupled. The stator is wound with 48 turns of number 22 sec. wire, having 8 taps of units to the aerial, and 5 taps of 8 turns each to the ground. The rotor has 50

turns of number 24 sec. wire. Forty-eight turns on the coupler stator are sufficient for all broadcast wave lengths; all over this number tend to decrease signal strength through dead end loss in the coil.

The variometer should have not more than 60 turns on the rotor and the same number of turns on the stator, and the wire should be not smaller than number 20. The rotor winding should oppose those of the stator.

Transformers Used

Much care should be taken in selecting transformers. The audio should be well shielded, and of good construction. The 9-to-1 ratio may seem a bit high, but with proper tuning, and if the transformer is correctly constructed, little or no distortion will be noticed. The R. F. transformers should be of the reflex type, of one-tube design, and lateral-wound. Care should be taken to connect the transformers correctly, as indicated in diagram. Be sure that R. F. transformer has at least a 4-inch clearance from all other inductance. This is very important and the downfall of many good reflex sets.

Changes in Hoop-Up

Note, some changes have been made which add to the efficiency of the hook-up, in that more volume is obtained. Ex-

Campbell XX RADIO CABINETS

"from the lumber to you"

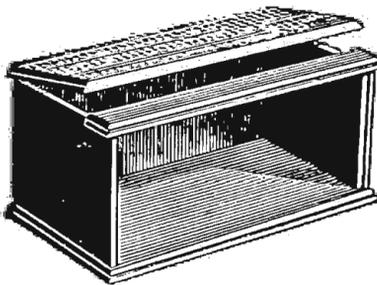

Campbell XX Radio Cabinets, designed by expert Cabinet Makers, are made absolutely accurate in size, and will fit standard panels perfectly.

Made of extra dry high-grade lumber, in solid Mahogany or Walnut, also, Mahogany or Walnut high piano rubbed or bright finishes.

WILL NOT WARP OR CRACK

Manufacturers' and Distributors' inquiries solicited.

THE PERKINS-CAMPBELL CO. (Established 1879)
410-440 New St., Cincinnati, O. Reference Dun or Bradstreet's

PRICES

Cash with order, prepaid east of Missouri River, west add 15 cents to quoted price.
Send Post Office Money or Express Order or Bank Draft.

Panel Sizes	Walnut or Mahogany Finish	Genuine Walnut or Mahogany
6 x 7	\$2.74	\$ 4.80
6 x 10½	3.36	5.96
6 x 14	3.54	6.70
6 x 21	4.86	8.72
7 x 7	2.94	5.52
7 x 10½	3.54	6.28
7 x 12	3.68	6.38
7 x 14	3.84	7.12
7 x 18	4.24	7.30
7 x 21	5.50	10.06
7 x 24	6.52	11.48
7 x 26	8.78	14.50
7 x 28	9.00	15.00
Special Cockaday	9.40	15.50

SPECIAL SIZES TO ORDER

Thrills from Radio

No. 14 of a Series Featuring Experiences of "ALL-AMERICAN" Users

Others May Fail—but not All-American!

By Clarence E. Richards, Milwaukee, Wis.

"I have been using 'All-American' Audio Frequency Transformers with great success after failing to get anywhere near satisfactory results with several other makes.

"My confidence in your product, therefore, tempts me to try different 'hook-ups' for still greater improvement, using your Book of Tested Hook-ups as the guide."

As popular with radio enthusiasts as



For "Push-Pull" Circuits: All-American Power Amplifying Transformers (Input and Output). Each \$6.

the All-American Audio and Radio Transformers, are the latest All-American Power Amplifying Transformers. For maximum volume (wholly undistorted) and an astounding roundness, richness, depth and purity of tone, these newest All-Americans have no equal. On any good loud speaker the results will delight you.

Special Offer
All-American Power Amplification diagram - circular and Book of 22 Tested Hookups sent for 4c in stamps to cover mailing.

All the better dealers sell the "ALL-AMERICAN"

RAULAND MFG. CO., 2650 Coyne St., CHICAGO
PIONEERS IN THE INDUSTRY

Audio and Radio Frequency Power Amplifying (input and output)

More than 500,000 in use Standard on the better sets



ALL-AMERICAN

AMPLIFYING TRANSFORMERS

Largest Selling Transformers in the World

2-LO, LONDON, ENGLAND ON ONE TUBE

Another Record for the

ELGIN SUPER-REINARTZ

Tuesday, November 27, during the test period between 9 and 9:30 P. M., Rev. E. A. Cole in the residence of J. A. McIver, of Roodhouse, Ill., while operating a set made of materials and in accordance with the hookup furnished by the ELGIN RADIO SUPPLY CO., tuned in 2-LO, London, England, using receivers and but one tube. Later another tube was lighted and the loud speaker used, so that four people could hear the program and concluding announcement. The numbers, time, and the order in which they were played were

Officially Confirmed

by the St. Louis Post Dispatch in conjunction with the National Association of Broadcasters, who had charge of the tests. (See page 34, St. Louis Post Dispatch, Dec. 2, 1923.) This same hookup has been advertised extensively as the one which brings in stations 2000 miles overland on a loud speaker and one tube; and this has been demonstrated so often as to need no repetition.

Send a two-cent stamp for circular giving one, two, and three tube hookup, and price list of parts for this remarkable circuit. Address the

ELGIN RADIO SUPPLY CO.

207 Chicago St.

ELGIN, ILL.

MILOPLEX WAVE TRAP

(Continued from page 19)

broadcasting stations. Better still would be to go to the station and talk to Mike the Microphone—you know what I mean—some of those evenings when you want to give the station poison. But prelude it with a lot of cuss conversation.

Description of Trap

All right, let's go. Dig up the wave trap you made last week and cover its windings on the coil with two or three layers of fish or insulating paper. This not being easily obtainable, it is quite permissible to use varnished cambric, while in emergency very good insulation may be secured by using rubber friction tape, which all Radio, electric or bicycle dealers carry in stock. This accomplished wind 10 turns of number 18 dcc or dsc. wire on the coil, spacing the turns approximately 1/4 inch apart and bringing out taps at turns 3, 5 and 8. These taps with the start and finish of the winding, will furnish 5 leads which should go to switch points (see drawing). This outer winding is not in any manner connected to the wave trap, becoming a part of it, merely by being inductively coupled to it.

Connecting the Trap

Several methods for connecting this really very efficient trap may be suggested, yet Maggie says, "He who wish will never do," and who wants to have a heluva time changing from thisaway to thataway, so s'posin' we do it right in the beginning and not have to "wish" later. All right, let's go. Install a series-parallel switch and make both receiver and wave trap connections to it. We can then "wish" and by a simple twist of the wrist our "wish" comes true.

The diagram clearly shows the manner of connecting both the wave trap and receiver to the switch, and "me noes" you will be glad you used it. You know, a series-parallel switch is one device that should be in every bug's workshop (now watch the switches start pouring in for my O. K.). By referring to the diagram it will be noted that when the blades of the switch are in the position indicated by the solid lines, then the trap is connected in series with the antenna. And that's 'nuff for this week, as Maggie's gentle (?) voice is calling.

Let's eat.

(TO BE CONTINUED.)

Japan's Radio system, while the sole source of communication with the outside world following the earthquake, suffered demollition at many points. Because of this emergency land lines have been put up to link Tokio with other points in the empire.

SINGLE TUBE REFLEX

(Continued from page 23)

build up volume by means of variometer and condenser, which is across secondary of R. F. transformer.

If volume is built too high a point will be reached at which the tube will burst into oscillations. If this occurs, touch grid lead with your finger and at the same time turn rotor of variometer back a bit to compensate for the excess regeneration.

It is well to know that the temperature of the filament is rather critical, there being three different positions upon the rheostat at which points signals are clearest, while each succeeding point renders the signals louder. Any change in the filament temperature will also necessitate a change in grid potential, by means of the potentiometer.

Kind of Crystal

If a cat whisker type crystal is used, first remove cat whisker from crystal and turn in almost all resistance of rheostat, which causes filament to burn at a very low temperature; then proceed tuning primary of coupler till signal is heard. The signal, in this case, is very weak, since the tube is acting as detector instead of the crystal. Next turn up filament to one-half of resistance of rheostat, which will cause the tube to oscillate; then, by adjusting crystal properly, oscillation will cease and the signal will again be audible and of greater volume. Then proceed as above.

It is advisable in tuning to utilize as few turns on the coupler as necessary. If a signal does not come in clearly the station is not tuned in properly, and you will nearly always find the trouble in the primary of the coupler. It is evident that stations varying by more than 200 meters in wave length may be tuned in by means of secondary circuit only, but unless the primary of coupler is also varied, the signal will not be perfectly audible.

Loud Speaker May Be Used

Many letters were received inquiring whether this hook-up will operate a loud speaker. In reply the writer will state that stations within 50 miles are very satisfactory on a Magnavox, and with one added stage of A. F. stations at 1,000 miles can be heard on the speaker with plenty of volume. Voice and music are also exceptionally clear from the speaker.

HINTS FOR LISTENER IN

(Continued from page 22)

while trying to receive modulated CW signals or broadcast programs, may be accomplished by following the "zero beat" method given above. This method distorts and suppresses the spark signals and increases to a greater degree the amplification of the signals desired. When the wave lengths of the two signals are nearly the same, it may be possible to cut out the spark interference by changing the frequency of the desired signals to the place where the carrier frequency of the modulated CW signal is beyond the audible range. Adjustment of the coupler may also be made to eliminate spark interference.

(TO BE CONTINUED.)

Battery Logic

Laying a dry battery of any kind, A or B, on its side will shorten its life considerably. The battery is made to stand on its end, and when on its side all the moisture on the inside will gradually go over to the underside of the zinc con-

tainer and soon eat through. If the dealer keeps his dry batteries on his shelf so that they are in this position, it will be wise to purchase elsewhere.

Keep the high-tension battery well ventilated or it will soon deteriorate.



RADIO "B" BATTERIES

At Factory Prices
Greatest Radio "B" battery on market. Full number voltage taps; QUALITY GUARANTEED; LOWEST PRICES; brings in concerts LOUDER AND STRONGER; will work on any tube or loud speaker. Order by number TODAY with check, money order or pay postman C. O. D.
No. 322B—22 1/2 volt, variable, regularly \$2.25 \$1.52
No. 322A—22 1/2 volt, variable, regularly \$3.00 \$1.85
No. 345A—45 volt, 8 taps, regularly \$5.50 \$3.25
AYRES BATTERY CORPORATION, Cincinnati, Ohio



\$3.50

1/2 Actual Size

The Peak of Quality—
PREMIER PARTS

\$2.50

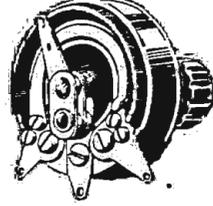

"HEGEHOG" Audio-Frequency TRANSFORMER

We back this little wonder to the very limit. For all around efficiency and compactness it is unexcelled. Give it a thorough try-out. Install it in Neutrodyne, Autodyne, Superdyne, Miloplex, Autoplex, or any of the latest "hook-ups." Judge it for volume, tone quality and consistent performance. Give it every possible test. Then consider its size and price. If you do not find the "HEGEHOG" unsurpassed in every way, your money will be gladly refunded. We guarantee it unconditionally. Make this test. Ratios 1 to 3, 1 to 4, 1 to 5—\$3.50; 1 to 10—\$4.50.

"Double Disconnect" "POTENTIOMETER"

One outstanding feature is the Double circuit breaker, which automatically disconnects A and B battery circuits, thus positively eliminating A battery drain (as heretofore present in all Potentiometers) and at the same time absolutely preventing accidental burning out of tubes with B battery voltage.
Genuine Nichrome wire wound. Bakelite base. Silver etched dial. Price, 250 ohm, \$2.50; 500 ohm, \$3.00.
Our Free Bulletin No. 92 gives complete list of Premier Radio parts priced right.

19 Years Making Quality Electric Products Premier Electric Company 3810 Ravenswood CHICAGO Ask your Dealer for "Premier" Parts

Ask Your Dealer for Kellogg Radio Parts

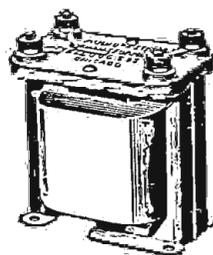

Transformers
Built and designed correctly, delivering maximum amplification with minimum distortion. Connections clearly marked. Properly designed brass shield permits close mounting.
No. 501 Ratio 4.50
4 1/2 to 1
No. 502 Ratio 4.50
3 to 1
No. 501

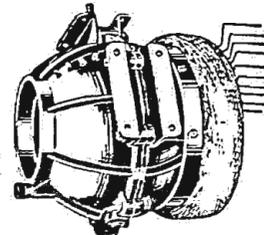

Variocouplers
Furnishes efficient coupling. No sliding contacts. Bakelite shells. High induction, low distributed capacity.
No. 501 Variocoupler \$9.00
No. 502 Tuner Coil 3.00
No. 501 with 502 Tuner Coil

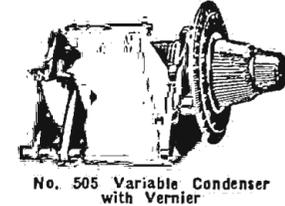

Variable Condensers
Decimeter type, 11, 23 and 43 plate with and without vernier. Arranged for panel mounting.
No. 605, 43 plate with vernier \$8.75



Head Sets
Extremely sensitive. Small in size. Easily adjusted. Thoroughly efficient.
No. 69A Head Set, 2400 ohms \$10.00
No. 74A Head Set, 1000 ohms 5.00
No. 69A Head Set

KELLOGG SWITCHBOARD & SUPPLY COMPANY
1666 W. Adams St. CHICAGO, ILL.

FAHNESTOCK'S RADIO PRODUCTS

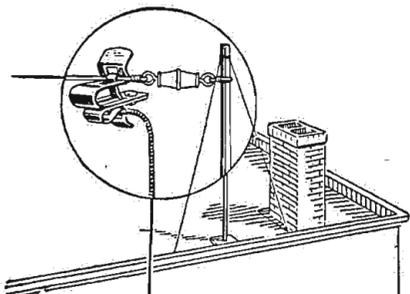

No. 31

The Antenna Connector

Snap larger connector over Antenna Wire; insert Lead-in Wire into smaller clip and a perfect connection is the result.

Improved Ground Clamp

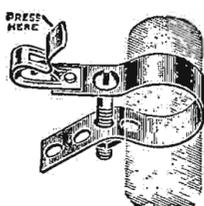

Equipped with Fahnestock Patent Wire Connectors Easily Attached.

FAHNESTOCK ELECTRIC CO.

Long Island City, N. Y.

No Soldering—For Radio Use Only

Our name stamped on all our products. None genuine without it.

Dealers can obtain Fahnestock Products from following distributors:

- BOSTON: Wetmore-Savage Co., F. D. Pitts Co.
- DETROIT: Detroit Electric Co.
- CHICAGO: Barawik Co.
- MILWAUKEE: Jullus Andrae & Sons Co.
- PHILADELPHIA: H. C. Roberts Elec. Supply Co.
- PITTSBURG: Ludwick, Hommel Co.
- WESTERN DISTRIBUTORS: Marshall & Co., Los Angeles, Cal.

WALNART New Inductance Switch

One to ten points. Only one hole to drill, smooth, positive contact. Solder terminals. Genuine Bakelite numbered dial. Simply and quickly installed. Fits any panel.



\$1.00 List Variable Grid Resistance

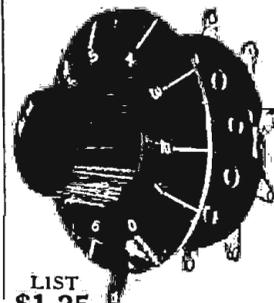

LIST \$1.25

WRITE FOR ILLUSTRATED FOLDER

The base of this instrument is Continental Bakelite Dielecto XX, the perfect dielectric insulation (licensed under Bakelite patents).

WALNART ELECTRIC MFG. CO.

Complete with Dial 1249 W. Van Buren St. Dept. 425 CHICAGO

STARITE RADIO BATTERIES SAVE YOU 60%

And Guarantee You in Writing 2 Years of Better Battery Performance
STAR-ITE RADIO BATTERIES are made especially for Radio and the big saving is made possible by coming direct to you instead of thru distributors, dealers, etc. Boxes are made of oak, finished in mahogany and the plates very thick and will give a steady discharge over a long period. No premiums, just good, honest battery value.

TRY TO BEAT THESE PRICES

2 Volt for W. D. 11 and 12	\$4.00	6 Volt 60 Ampr.	\$ 7.50
4 Volt for U. V. 199 Tubes	7.00	6 Volt 80 "	8.50
RADIO B. STORAGE Glass Jars, Heavy Plates—Case of 12 Cells, 24 V.	4.90	6 Volt 100 "	10.00
		6 Volt 120 "	12.10
		6 Volt 150 "	14.00
		6 Volt 200 "	17.00

Get Yours Today—NOW—Send No Money

The batteries are fully guaranteed in writing and shipped subject to examination on the day your order is received. You pay on delivery or deduct 5 per cent if full cash accompanies order. You may deduct 10 per cent if two or more are ordered at one time.

STARITE BATTERY CO.

Department 5

LOUISVILLE, KY.

Construction of a Four Tube Reflex Neutrodyne

Part III—Assembly and Wiring

By H. J. Marx

THE assembly of this receiver makes such a compact unit that the fan wonders how he is going to be able to wire the set. The writer has found that reflex circuits always give better results when the apparatus is kept close together inasmuch as this provides for very short leads.

In assembly, mount all parts on the subpanel except the two audio transformers, then assemble the subpanel on the main panel.

As was previously stated, shielding decidedly stabilizes the action of the set and eliminates any body capacity effects, but will be found to reduce the volume somewhat.

The two screws that hold the spring assembly together on each jack are replaced with longer ones which pass through the two holes in the subpanel.

This mounting of the subpanel on the jacks will be found sufficiently solid to hold the subpanel very rigid. The audio transformers are left off in order to first make all filament and rheostat connections.

The air core transformers were mounted in their usual angular position on the ends of the variable condensers. All fixed condensers, grid leak and grid condensers, and the neutrodons with their mounting strips should be mounted last.

Wiring

First make all connections from the +A binding posts to the four sockets, the third air core transformer, its variable condensers and to the —B binding post.

Then connect the three rheostats and the —A binding post. Connect also to the ground post the secondary of the second air core transformer and its variable condenser. Then make the connections from the air core transformers to the sockets, battery terminals, etc. Make all the remaining connections possible before mounting the two audio transformers.

Mount the one on the right side (rear view) first and make all the connections to it, then mount the other one in the same manner.

After all this wiring is finished, add the grid leak and condensers. This is connected on the under side of the panel (not

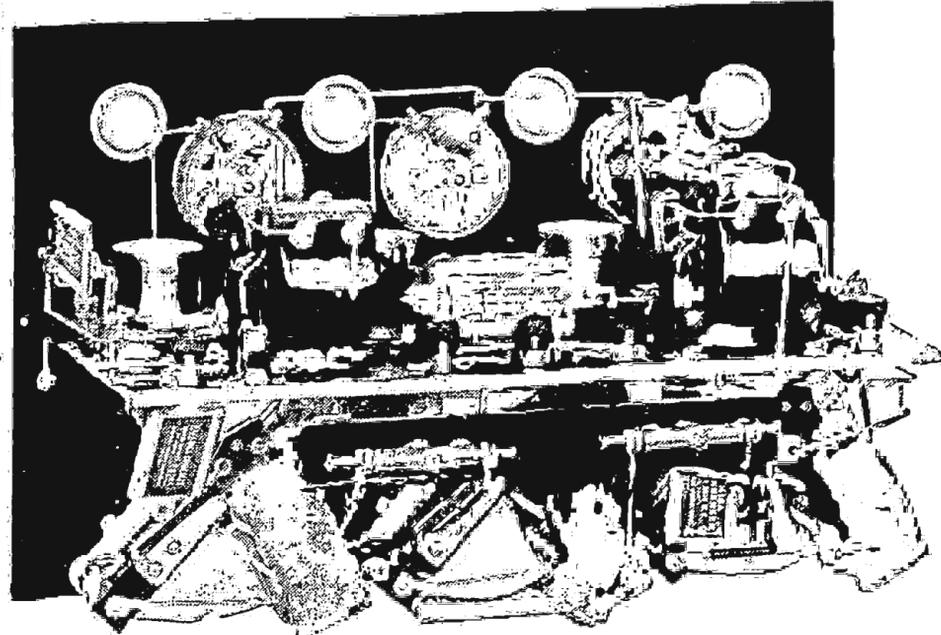

visible) and is entirely supported by the two wires connected to it.

All fixed (by-pass) condensers can now be added. Of course, wherever wires run in close proximity and there is possibility of short circuit, spaghetti tubing should be used generously.

The neutrodons are mounted on a piece of scrap panel stock 1 inch wide and 6 inches long. This is fastened to the subpanel by means of two brass angles. The connections from the neutrodons to the tap on the coil and the grid are made with braided pigtail wire and insulated with some spaghetti tubing.

Testing

After you have it all finished and tried it out and find that it won't work first crack out of the box, don't go up in the

air and write, razzing us about untested circuits.

Every set published is made up and tried out to our satisfaction before we pass it on. That's why we publish the photos, so you may feel convinced that we make the set as passed on to you. The letters from fans who do make their work cheer us up and help to encourage some fan to locate his trouble.

The experience of the writer with this set may help somebody in his difficulties. After finishing the wiring, the set was looked up for reception. To say results were disappointing would be putting it mildly. The problem was to locate the trouble. Easily said, but try and do it! All coils, transformers, condensers, etc. were tested for short circuits, open circuits, poor connections and what not. Hook-up was checked over and still no results.

Now, the writer assembles five and six sets weekly, each one different from the other, so it certainly looked as if the circuit design was the trouble. Time was flying and the hour was late, so the only thing to do was to set it aside. In removing the tubes it was found that very faint reception was audible, although the two center tubes were removed. This led to further investigation. Analysis of this reception led to this conclusion. The first tube functioned as a very poor detector, and the last tube acted as an audio frequency amplifier.

Evidently the entire trouble was in the first tube. A very detailed check showed that the grid of the audio frequency transformer was connected to the wrong side of the single wiring of the first air core coil. This left the lower end of the coil with its condenser open, thus cutting out the Radio frequency stage entirely and making it an audio amplifier which did a poor job of rectification: hence no reception except a few faint sounds that managed to trickle through.

Repairing the trouble set everything going right and life looked more rosy again. So if at first it don't work, try, try again. Radio demands plenty of patience. Many of us lack it.

(Continued on page 26)

THORDARSON



POWER AMPLIFYING TRANSFORMERS

Price per pair, \$13.00

The new Thor Larson Power Amplifying Transformers (push pull) are designed for use as third stage audio frequency amplifiers, to provide high power amplification for operating loud speaking devices.

With power amplification, not only is it possible to increase volume, but, since two tubes replace the usual one, the distortion and howling which usually accompany the overloading of a single tube on the third stage is done away with entirely.

The Thor Larson Power Amplifying Transformers are well constructed electrically and are capable of indefinitely carrying the additional load without breaking down.

In tonal purity these transformers equal the Thor Larson Super Audio Frequency transformer whose rich quality and even amplification has made it the popular transformer of the day.

THORDARSON ELECT. MFG. CO.
500 W. Huron St. CHICAGO

CROSLLEY
for the Radio World

New Two Tube Set at \$18.50
REGENERATIVE

THE most astounding value ever offered in radio—a new two-tube receiver, Crosley Model 51, consisting of Armstrong regenerative detector and one stage of audio frequency Amplification. Licensed under Armstrong U. S. Patent No. 1,113,149.

This wonderful set gives loud speaker volume on local stations at all times and on distant stations under fair receiving conditions. Otherwise head phones should be used for distant reception.

Be sure to see this receiver.

For Sale by Good Dealers Everywhere. Free Catalog Sent on Request

The Crosley Radio Corporation
Powel Crosley, Jr., President
Formerly the Precision Equipment Company and Crosley Manufacturing Company
3492 Alfred Street, CINCINNATI, O.
The Largest Manufacturer of Radio Receivers in the World

Coto
"Built First to Last"

New Coto Compact Moulded Variocoupler

Size is only 3/4x3x3 1/2. (Variometer to match 3/4x1 1/2x3 1/2.) Just what you have been looking for to make a beautiful, efficient and portable set. Eight taps for use with primary condenser. Pigtail connection to rotor. Range 200 to 600 meters.
Type 9000.....\$5.50

If your Dealer fails you write us at Once.

COTO-COIL CO.
87 Willard Ave., Providence, R. I.

BRANCH OFFICES: Los Angeles, 329 Union League Bldg.; Minneapolis, Geo. F. Darling, 705 Plymouth Bldg.; Atlanta, C. P. Atkinson, Atlanta Tr. Co. Bldg.; Canada, Perkins Elect. Co., Ltd., Montreal, Toronto, Winnipeg.

UV-201-A

Radiotron UV-201-A is a high-power vacuum tube which, while suitable for a detector, is intended primarily to be used as an amplifier, at either radio or audio frequency.

It is famous for volume, for clearness and for economy of service—drawing but .25 ampere.

Price \$5.00

Radio Corporation of America
Sales Offices—Dept. 313
233 Broadway, New York
10 South LaSalle St., Chicago, Ill.
433 California St. San Francisco, Cal.

Be sure that every vacuum tube you buy is marked **RADIOTRON**.

Radiotrons

5.00 ea.
send purchased

REG. U. S. PAT. OFF.

FOUR-TUBE NEUTRODYNE

(Continued from page 25)

Neutralizing

In the February 23 issue of Radio Digest, Mr. John P. Davis gives a good method of neutralizing. It will be found very effective for this receiver, so it is repeated for convenience:

"As you know, practically everyone who

second R. F. tube, put a piece of paper under the positive filament pin of the tube, or if you have separate rheostats (which is best), turn it back until the filament is cold. The music will still be heard, probably in good volume. Unless the second neutrodon is already adjusted, you will find that the middle dial has a tuning value. One point on the dial the music will come in much stronger.

it is infallible. It can be done in five minutes."

(THE END.)

The Reader's View

Sets Decline in Efficiency

In your issue of September 8, 1923, on page 15 you publish a letter from "R. L.," Toronto, Canada, in which he asks your suggestions as to the cause of the gradual decline in the efficiency of his set.

I would like to mention a possibility which you did not speak of. Recently I had a similar experience with a Cockaday set that I built, and it took me considerable time to discover the trouble. After ripping apart the whole outfit (including the two-stage audio amplifier), I located the cause of the trouble in the tuning condenser. Soldering flux had worked into the bearings and corroded them. The gradual action of the flux explained the fact that the set lost its efficiency slowly. After I had taken the condenser apart and

wiped the black deposit off the bearings and reassembled the parts, the locals came in "like a load of bricks." A day or two later I picked up Drake Hotel, Chicago, and WJAX, Cleveland, very nicely on the detector alone.—Charles G. Kitterner, Clifton, N. J.

Brings Record Buyers

Looking over an old Digest I re-read your Exposé of Music Trust. This recalls to me a personal experience. One evening while listening to WJAZ, I heard Miss Bruce sing "Marcheta." A short time afterwards my brother and I were in Omaha; he bought two Marchetas for his Victrola; I bought two for my Edison and also a copy of the sheet music.

This is being done in every state in the Union every day. What in _____ is the trust howling about when Radio does more to advertise good music than the publishers do?—Jas. H. Green, Creighton, Nebraska.

The use of a horn in connection with the telephone receivers generally does not give good results, unless the signal can be heard well at least one or two feet from the telephones without using the horn.

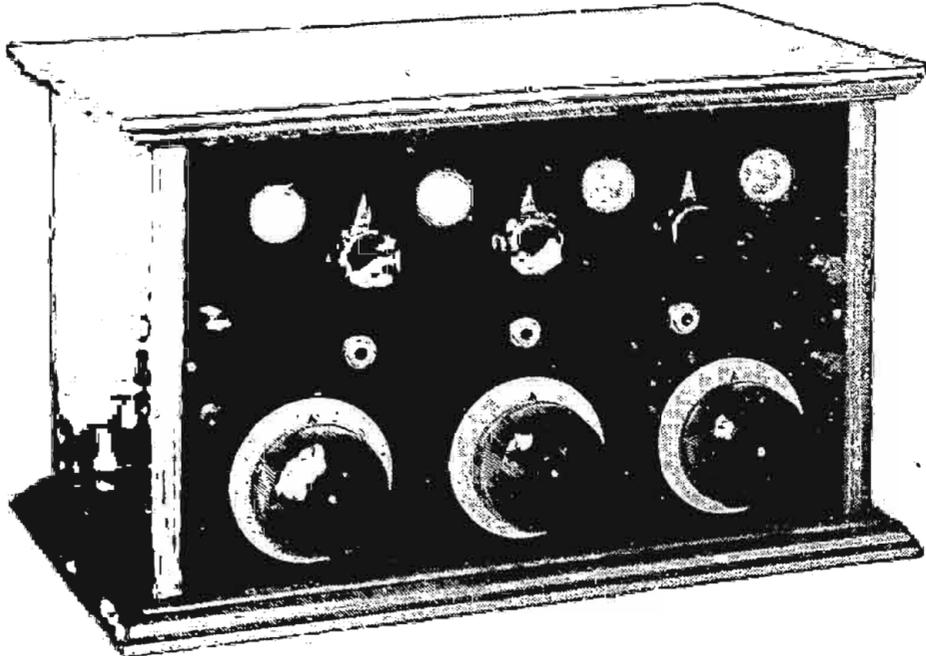

has assembled a neutrodyne receiver has had trouble with the heart of the set—the neutralizing condensers.

"After my own experience, I am sending a simplified and much more critical method of obtaining the correct value of the neutrodons.

"Do not select too powerful a sending station to adjust on. I should say a 50-watt station at 10 miles or a 500-watt station at 50 or more miles.

"Carefully tune in this station; if the R. F. Tubes oscillate, turn down the rheostats until the music is clear and be sure that the volume is strong. Start on the

"Adjust the neutrodon until the middle dial has no tuning value. The music will come in at an even volume at all points on this dial when the neutralizing has been accomplished. You can even spin the dial without hearing a click. This adjustment will then be positively correct on the second neutrodon.

"Beware of neutrodons on the market in which the inherent capacity between the parts making up the condenser is too great, or perhaps the adjustment is too coarse.

"I have adjusted quite a few neutrodyne sets by the above method and know that

91 1/2% of All Radio Tubes Are Needlessly Destroyed



Accurate estimates show that less than 9 out of every 100 tubes give their full normal service and 91 are destroyed—usually burnt out from excess current.

The chances are 10-1 against you unless you use

Radeco Safety Fuses

These tube savers are now saving thousands of tubes. They are endorsed by the leading Radio Publications.

They slip on the filament terminals of the tube and in no way interfere with the operation of the set.

Price \$0.50 each
(The cheapest insurance)

Install Radeco Safety Fuses now and whenever you buy a new tube insist on a Radeco Fuse to protect it.

JOBBERs—We want a few live distributors to whom we can offer a very attractive proposition.

RADIO EQUIPMENT COMPANY
New England's Oldest Exclusive Radio House
20 Stuart Street BOSTON, MASS.

Standard Merchandise Only	S. HAMMER RADIO CO. 303 ATKINS AVE. BROOKLYN, N. Y.	Anything and Everything in Radio
\$80.00 FREED-EISEMANN PARTS FOR 5 TUBE NEUTRODYNE SET.....	\$72.50	\$120.00 FADA 4-TUBE NEUTRODYNE SET NO 160.....
\$90.00 Genuine Parts for 4 TUBE MELCO SUPREME RECEIVER.....	\$85.00	
PHONES	2.00 Comsco 1.75	10.00 Brandes 9.50
\$ 5.00 Turney, 3000 ohms... \$ 2.75	1.60 Amsco 1.30	17.50 Pathé 16.00
12.00 Western Electric..... 10.50	23-PLATE	Baldwin Unit 4.65
6.00 Brandes 4.75	2.50 Signal 1.60	Amer. Radiophone Unit..... 3.95
12.00 Baldwin 7.95	2.75 Admiral 1.65	RHEOSTATS
7.00 Federal 4.95	2.75 Comsco 2.25	1.00 Fada 30 ohm..... .90
6.00 Potter Precision..... 4.15	2.30 17-PI, Amsco 1.65	1.50 Federal 25 ohm..... 1.25
5.50 Stromberg Carlson..... 4.50	2.50 Amsco 1.95	1.00 Amsco 6 ohm..... .85
2.75 Patent, 3000 ohms... 3.35	43-PLATE	1.25 Amsco 20 ohm..... 1.00
12.00 Dr. Seibt 6000 ohms 5.75	2.75 Signal 1.65	1.30 Amsco 30 ohm..... 1.10
TRANSFORMERS	3.25 Admiral 1.80	1.50 Cutler Hammer 6 ohm Ver..... 1.15
7.00 Federal No. 65..... 5.45	3.50 Comsco 2.85	1.50 Cutler Hammer 30 ohm PL..... 1.15
5.00 Acme 3.85	3.50 Amsco 2.75	.90 Klossner 6 or 30 ohm..... .80
5.00 All-American 3.85	VERNIER CONDENSERS	1.00 Patent 6, 20 or 30 ohm..... .90
7.00 Amertran 5.75	11-PLATE	2.00 Filkostat 1.85
4.50 Thordarson 3.75	6.00 Hammarlund 4.95	1.80 Bradley-Stat 1.70
12.50 Como Dup..... 10.50	4.50 U. S. Tool..... 3.50	1.80 Bradleyleak 1.70
12.50 Modern P. P..... 10.50	5.50 U. S. Tool..... 4.25	2.00 Erncostat 1.70
5.00 Eria 4.25	5.00 Comsco 3.75	POTENTIOMETERS
12.00 All-American P. P. 10.00	5.50 Sexton 4.50	1.25 Patent 1.10
4.00 Rala R. F..... 3.75	5.00 U. S. L..... 3.45	1.50 Amsco 1.25
5.00 Duratran R. F..... 4.50	4.50 Amsco 3.35	1.50 Cutler Hammer 1.15
5.00 General Radio..... 4.35	43-PLATE	1.50 Klossner 1.25
TUBES AND SOCKETS	5.50 Hammarlund 6.25	3.50 Fisher 2.50
Valvite..... .45	5.50 U. S. Tool..... 4.25	3.50 Workrite 180 deg..... 2.95
Valvite..... .80	5.50 Comsco 4.75	8.00 Gillilan 6.00
..... .65	5.50 Comsco 4.75	4.00 Simplex 2.60
..... .80	6.50 Sexton 5.45	3.25 Shamrock 2.60
..... 2.50	6.50 Sexton Automatic..... 5.45	4.00 Sleeper Fixed 3.25
..... .45	5.00 Amsco 3.95	7.00 All Wave 5.50
..... .65	4.50 Amsco 17-PI..... 3.35	MISCELLANEOUS
..... 1.20	5.50 Amsco 26-PI..... 4.10	Cockaday Coils, Precision..... 4.50
..... .55	3.00 Compensating Condenser..... 2.65	Cockaday Coils, Eastern..... 3.35
..... .90	LOUD SPEAKERS	Amplex Grd Denser..... 1.25
PLUGS	\$30.00 Music Master..... \$24.00	Lavite Resistances, 48,000 ohms..... 1.10
..... .70	35.00 Magmarox..... 29.00	\$2.00 Reinartz Coll..... 1.40
..... .60	30.00 Herald..... 26.00	Eria Crystals..... .95
..... 1.20		
..... .55		
..... .90		
SOCKETS		
..... \$ 1.40		
..... 1.45		

SHIPPED PROMPTLY. Orders over \$5.00 will be shipped prepaid. Money orders or C.O.D. insured unless insurance charges included. Write for Price List.

B-METAL
Loud Talking Qualities

SUCCESS BRINGS IMITATIONS

LOOK FOR OUR NAME on the B-Metal box and be certain of getting the kind of B-Metal Crystals you expect to buy i. e., the B-Metal that has become famous for its loud talking qualities, and First, Last, and Always has been sold under this label. READ B-METAL REFINING COMPANY ON THE BOX OR PASS IT BACK TO THE DEALER for if our name is not there, our well-known and well-tested guarantee is not behind it.

B-METAL WAS NEVER ON THE MARKET UNTIL WE PUT IT THERE, and we stand squarely behind every B-Metal product bearing our name printed plainly on the package.

We do not offer premiums to assist the sale of REAL B-Metal.

B-METAL REFINING COMPANY
525 WOODWARD AVENUE DETROIT, MICH.
Formerly at 3134 Trumbull Avenue
Chicago Branch: 53 West Jackson Blvd., Chicago, Ill.
New York Branch: 222 Fulton Street, New York City

PRICE 50 CENTS

An Absolute Guarantee with every instrument made them famous!

SHAMROCK
FOR SELECTIVE TUNING

180° Vario-Coupler

DOUBLE DUTY PIG-TAIL Variometer

list price \$3.50 each

SHAMROCK MFG. CO.
318 E Market St. Newark N. J.

Buy a **STAR** FIXT CRYSTAL DETECTOR

Price \$1.25

YOU'LL NOT BE DISAPPOINTED WITH A STAR

Built by engineers who know the problems of crystal detection. Sold by all wide-awake Jobbers and Dealers.

Used by the Radio owners who have hoped and dreamed of such an accomplishment, and gaining a host of friends daily. We are doing our best to meet the demand, so please say STAR FIXT CRYSTAL to your Dealer or Jobber early and get your STAR when you want it.

Star Crystal Company
525 Woodward Ave.
Detroit, Mich.
Chicago Branch, 53 W. Jackson Blvd., Chicago, Ill.
New York Branch, 222 Fulton St., New York City

Amplifying Crystal Set without Tube

Crystal Amplification Gives Increased Range

A crystal set may be amplified without a vacuum tube by using the diagram shown. While this does not increase the range of the set greatly, it amplifies the signals without the usual other noises

WORKSHOP KINKS? EARN A DOLLAR—

THERE are many little kinks worked out at home that would aid your fellow Radio worker if only he knew about them. There are new hook-ups, new ways of making parts and various unique ways of operating sets that are discovered every day. Radio Digest is very much interested in obtaining such material. Send them in with full details, including stamped envelope, so rejected copy may be returned. The work must be entirely original, not copied.

RADIO KINKS DEPARTMENT,
Radio Digest,
123 W. Madison St., Chicago

found in tube amplification. Be sure that sensitive crystals are used, such as Galena, and that the wire coming from the first amplifying crystal is hooked to the secondary of the second transformer and not to the primary, as this would not work.

The parts for this amplifier are: Two good crystal detectors, two audio frequency transformers, two small phone condensers, .001 mfd., and one 22½-volt B battery to force the signals through the amplifying transformers.

The phone terminals of the set are hooked to the primary of the first transformer.—Lee H. Bolen, Hamilton, Mont.

In winding a loose coupler, both coils are wound in the same direction.

NO AUDIO FREQUENCY TUBES USED

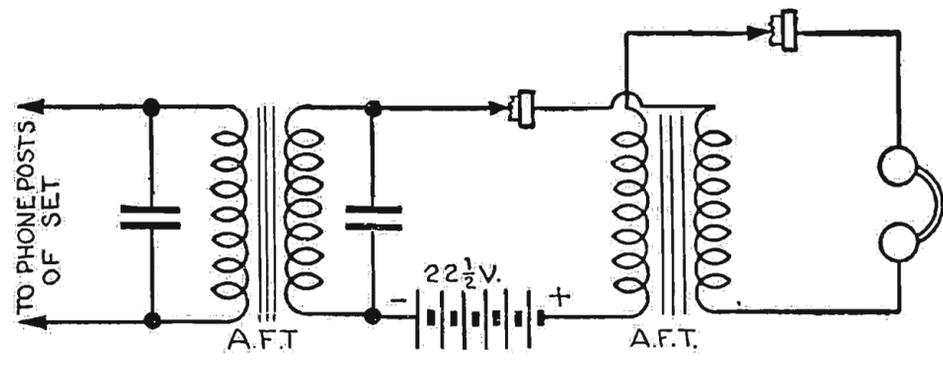

Efficiency of Batteries

A Radio set will not work satisfactorily when the storage battery or B batteries are nearly run down. Have the storage battery charged and get new B batteries. B batteries should last at least six months, and in many instances several years.

Cleaning Phone Diaphragms

The diaphragms of some types of telephone receivers sometimes become slightly rusted after much use and the pole pieces themselves become slightly cov-

Laboratory Tested Tubes

Insure best reception. Each tube individually tested for perfect reception and high electron emission. Standard R. C. A. tubes, laboratory tested, at no increase in price.

UV-200, 201-A, 199, 11, 12 { \$5.00 each postpaid
C-300, 301-A, 299, 11, 12

Central Radio Bureau

2140 Storm Street. AMES, IOWA

ered with rust, interfering with the vibration of the diaphragm. The remedy for this is to remove the cap and carefully wipe off the magnets and diaphragm with a soft cloth dampened with sewing machine oil.

RADIO SUPPLIES

CV200-CV201A-UV199-WD11 & 12 \$ 4.25
RCA RADIOTRON TUBES.
D12-V200-Dutch Radio Tube 2.50
Guaranteed tubes.

WORKRITE NEUTRODYNE KIT COMPLETE 15.00
\$8.00 Crystal Sets 3.50
\$3.00 Crystal Sets50
All American Audio or Radio Transformers 3.80
\$3.00 Electric Iron 2.00
Bus Wire tinned, 10 feet20

VARIABLE CONDENSERS

3 Plate \$0.90 43 Plate .001 1.35
5 Plate 1.00 7 Plate North75
11 Plate 1.00 23 Plate North 1.00
21 Plate .00025 1.20

\$5.00 True Tone Phone \$4.00
\$5.00 Ambassador Phones 3.50
\$6.00 Peerless Double Coil 4.50
3 & 4 inch Dial25

We have a complete stock of all radio parts, let us know your wants we will quote you lowest price on same, we ship C. O. D.

KINGS RADIO SALES CO.

1166 N. Kingshighway, ST. LOUIS, MO.

Adjusting the Earpieces to Match Phone Tones

After using a pair of receivers for several months, it often happens that one receiver works a little louder than the other. This may be due to one earpiece losing magnetism. In most cases, simply tightening the cap on the receiver will help a great deal. If this does not help, unscrew the cap and turn the diaphragm over on the other side and replace the earcap.

A well constructed Milloplex circuit will undoubtedly be found worthy of your good opinion.



RUSONITE
RADIO CRYSTAL
Entire Surface Sensitive
The Recognized Standard Crystal Rectifier
Used All Over the World
Hundreds of Thousands of Satisfied Users.
Rusonite Has Revolutionized Crystal Radio Reception.
"THE PERFECT SYNTHETIC CRYSTAL"
Guaranteed
Price mounted 50c
Rusonite Catwhisker 14K Gold
Supersensitive; will not oxidize
Price 25c
Order from your dealer or direct from
Rusonite Products Corporation
15 Park Row, New York, N. Y.

Try the NEW
Pfanstiehl
TUNING UNIT
in the Efficiency hook-up
and hear stations
you never heard before

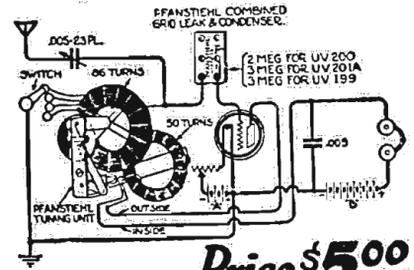

Price \$5.00

Postpaid or at your dealers
PFANSTIEHL RADIO SERVICE CO.
Highland Park, Ill.

Use the NEW
Pfanstiehl
SILENCER
"Traps the Enemy Wave"
and listen to those stations you want to hear



Inductively Coupled
Guaranteed to give satisfaction by effectively eliminating undesired signals. Three alternative hook-ups furnished.
Price \$8.00
Postpaid or at your dealer's
PFANSTIEHL RADIO SERVICE CO.
HIGHLAND PARK, ILL.

REINARTZ

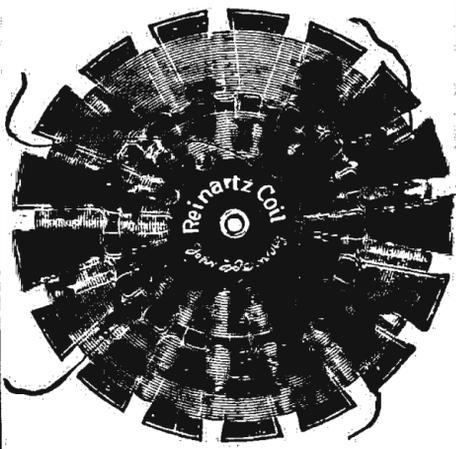

The coil that talked with France
In November, 1923, messages were transmitted between John L. Reinartz at his home in South Manchester, Conn., and M. Leon Deloy, Nice, France, conversation covering several hours.
The Genuine Reinartz Coil bears the signature of John L. Reinartz. If your dealer cannot supply, send us \$2.50 Money Order, for coil with his latest copyrighted hookup and instructions.
TRISTAN SALES CORPORATION
National Distributors
Dept. C, No. 1 Union Square, New York City

No Outside Wires Needed

Use the
ANTENELLA
attached to any lighting socket, eliminating the inconveniences in Radio such as unsightly outdoor aerials, insulators, lightning arresters, lead-ins, etc.
Hundreds of unsolicited letters from satisfied users are on file in our office, showing that the
ANTENELLA
is not only a real distance getter, but also successfully overcomes static annoyances.
ANTENELLA
The complete, efficient and inexpensive aerial.
Price Only \$1.25
At your dealers—otherwise send purchase price and you will be supplied postpaid.

Chas. Freshman Co. Inc.
Radio Condenser Products
106 Seventh Avenue NEW YORK

Workman Radio Service
"THE ACCENT IS ON SERVICE"
14-16 Vesey St. NEW YORK

VARIOCOUPERS
\$3.50 Workrite 180° Silk Wound \$2.95
3.50 Fisher, Large, 90° 2.75
2.75 Fisher, 180° 2.25
4.25 Special Bank Wound Coupler for Haynes Circuit (with diagram) 3.25
7.00 Ambassador Coil (with diagram) 5.50

VARIOMETERS
\$3.50 Workrite \$2.95
5.00 Pathé Moulded 2.25
3.50 Fisher, Large 2.85

CONDENSERS
\$2.00 R. C. 11 plate \$1.05
2.35 R. C. 23 plate 1.35
2.75 R. C. 43 plate 1.65

VERNIER CONDENSERS
\$4.00 R. C. 23 plate \$2.25
5.00 R. C. 43 plate 2.95

PHONES
\$18.00 DR. SEIBT IMPORTED "SUPER" \$5.90 HEADSET
\$12.00 N. & K., Imported \$5.90

The above items are just a few of our numerous attractive priced articles, which are contained in our BULLETIN OF RADIO PARTS. Gladly sent to you upon request.

We specialize in the FAMOUS AMBASSADOR LONG DISTANCE CIRCUIT. Write for list of parts for this set. Either single or three tube set. Price of parts for single tube set \$15.60
Price of parts for THREE TUBE SET 28.90
We are headquarters for "Radion" and "Bakelite Dilecto" Panels. The best panel material available. Mail orders promptly attended to. All orders amounting to \$5.00 or more will be shipped prepaid. Will ship C. O. D., unless remittance accompanies order.

ON ONE TUBE
Broadcasting from Atlantic Coast, Canada, Mexico, Cuba and Hawaii heard in California by users of the CROSS COUNTRY CIRCUIT. Range due to Simplicity. One tuning control. ANY NOVICE can build easily and cheaply. Dry cell tubes used. No soldering. Complete instructions, Blue print panel layout, Assembly Photo, etc., postpaid 25 cents. Stamps accepted.

WHAT USERS SAY
EAST—Am more than pleased with the parts ordered from you. The first night I hooked it up and received Omaha. Since then Minneapolis and Los Angeles. It works better without amplification than most sets with two stages.—Donalds, S. C.
WEST—I am sending you a list of some of the stations heard on one tube: WSB, WGY, KDKA every night. PWX, WWJ, WTAM, WLW every night. CFAC, CHCB. Not long ago I purchased another set of parts from you and first night got WGR, Buffalo, and KDKA. Ione, Calif.
NORTH—Received coils O. K. If I had with same results with these that I had with last will be wanting more. I am 1,500 miles from nearest station and have picked 56 to date. Chicago, Havana, Mobile, New Orleans and TWO IN ENGLAND
Lunenburg, Canada.

Send stamp for further information
BOX RN-117
Vesco Radio Shop OAKLAND, CALIF.

OFFICIAL REPORT
ELECTRICAL TESTING LABORATORIES
East 80th Street and East End Avenue, New York City

proves the high efficiency and remarkably low phase angle loss of less than 1 minute and a voltage breakdown test of 8,000 volts on the
"FRESHMAN SELECTIVE"
Variable Condenser

It is the only variable condenser the plates of which vary in area—an engineering feat never accomplished before—making it most efficient for fine adjustment and selective tuning.

For Transmission or Reception
No Leakage. No Plate Vibration. Absolutely Quiet. Cannot Short Circuit.

Chas. Freshman Co. Inc.
Radio Condenser Products
106 Seventh Avenue, NEW YORK

All Molded Parts and Dial of Finest Bakelite

.0003 MF (Equiv. to 17 pl.) } \$ 5.00
.0005 MF (Equiv. to 23 pl.) }
.001 MF (Equiv. to 43 pl.) } 5 ea.

At your dealer's, otherwise send purchase price and you will be supplied

GOOD RESULTS WITH WELL-KNOWN CIRCUIT

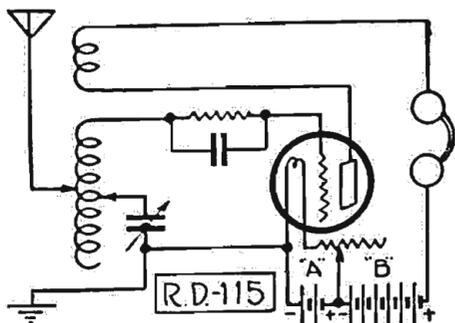

Mr. M. L. Potter of Sioux Falls, S. D., sent to us this circuit, which we name R.D.-115, and the unusual part of it is the fact that he doesn't claim it to be his own invention. That alone deserves the credit of recognition.

Besides this, he doesn't try to tell us he gets 2LO. England, consistently. Figure out yourself whether we are right in printing it. His letter is as follows:

"This circuit is probably older than I am, but I wonder if any of the new circuits will get the distance and volume that this will? I use a 23-plate condenser with vernier and ground the rotor plates. An ordinary \$3.00 variocoupler will fill the bill for primary and secondary. I use a WD-11 tube and a 4-meg. grid leak of the fixed capacity type. I receive both coasts and most Canadian stations and use an inside aerial, 130 feet of bare copper wire in the attic. If you have never published this circuit you may do so now. I will give operating details if anyone wants them. I use five taps on both ground and antenna, and connect wires to both taps on same place on stator of variocoupler. I use this as a portable set, as it is very compact. Total cost, including large B battery and phones, is less than \$25."

Distorted Signals

One cause of distorted signals is the B battery. If a B battery is dead, partially dead or even one-quarter dead,

one may always expect noises of all kinds. Plate voltage must be fairly well maintained, and therefore the B battery must be up to voltage, alive at all times. Sometimes a dead B battery will cause noises similar to static or a loose battery connection.

Audions of the same make require different plate voltage for best operation. Therefore, it is a good plan to experiment.

JOBGING RIGHTS WANTED

Well organized and established and financially sound selling organization having exclusive distributive rights for standard high-grade phonographs and pianos for Chicago and middle west states is adding radio department and is desirous of securing jobbing rights for Chicago market for high-grade radio equipment. Have exceptional facilities for successfully marketing radio to music dealers. Correspondence invited. Bank and commercial references furnished. Address R. D. 1, care Radio Digest, 123 West Madison Street, Chicago, Ill.

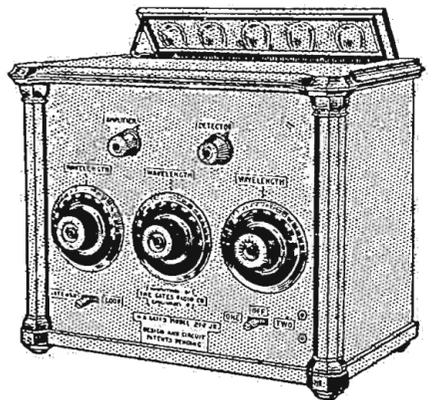

Gates Model 2-1-2 Jr.

Dealers! Here's the receiver that's getting countrywide acclaim. Beautifully designed in mahogany—surprising in tone and volume.

Write for Circular

Dealers only write for catalog A1001

WAKEM & McLAUGHLIN INC
225 E. ILLINOIS ST., CHICAGO



NASSAU CABINETS

SOLID MAHOGANY

Assembled Knockdown with Rounded & Finished Screws and Hinges
 14 x 7 x 7.....\$ 6.00 14 x 7 x 7.....\$2.50
 21 x 7 x 7..... 7.50 21 x 7 x 7..... 3.50
 26 x 7 x 7..... 8.50 26 x 7 x 7..... 4.50
 36 x 7 x 7..... 10.00 36 x 7 x 7..... 5.50
 All other sizes, any length, height, and depth at corresponding prices. Sent C. O. D.

'NASSAU CABINET CO.,
20 NASSAU STREET, NEW YORK

Guaranteed Head-Sets

RED-HEADS are guaranteed radio phones. You run no risk when you buy them. Money back if, after 7 days' trial, you're not satisfied that they're the best receivers on the market at the price. Why not act right now and get a pair? It'll mean getting the maximum from broadcasting from the day you put them into use.



RED-HEAD RADIO RECEIVERS

NOW READY

The new 1924 Model F | The new "Red-Head" Jr.
 \$6.50 Per Pair | \$5.00 Per Pair
 Complete Complete

"Red-Heads" sent prepaid on receipt of price if you are unable to get them at your dealer's.

THE NEWMAN-STERN COMPANY
Dept. R. D., Newman-Stern Bldg., Cleveland

Crosley "Harko Sr."

1-Tube Receiving Sets
 Non-regenerative type. Brand new, in original boxes.
WERE SOLD FOR \$20
 My Price
\$7.50
 NO CIRCULARS—ORDER FROM THIS AD
 Prepaid While They Last
TWITCHHELLS RADIO HOME
 1925 Western Ave. Minneapolis, Minn.



The new TWITCHHELL AUXILIARY TUNER connected to your present set will enable you to bring in the long and short wave stations which your present set cannot get. It also cuts out all local stations so you may bring in distant any time without local interference. Copyrighted diagram of this tuner 50c, or with all parts \$9.00. Complete instrument in walnut cabinet, ready to use, \$15.00. Transportation prepaid.

MY HIGHLY IMPROVED REINARTZ brings in all important stations on this Continent loud, clear and without distortion. We dance to music from Atlanta and Los Angeles.

Build one of these wonderful 3 tube sets from my blueprint and specifications, price 50c, or with a complete and perfect double-wound spiderweb coil \$3.00 by mail. Picture of this set on a glass panel with every order. This copyrighted circuit is the most successful of any Reinartz modification yet produced, and is limited to the most thousands in use. My W. D. #11 Circuit is especially designed for use with the "Pickle" tube and brings out the full value of that little tube as no other circuit can. Stations 1000 miles away come in clearly on one tube. This set is small, complete, portable. For the man who wishes the highest efficiency, this is the set to build. Price of blueprint and specifications, 50c, or with complete and perfect windings, \$3.00. Photo of set with every order. Sets built from these copyrighted plans will receive all broadcasting stations operating under the new laws. Their wave length range is from 170 to 800 meters. All goods prepaid. These instruments are easy to build, easy to operate. Everything clearly shown.

S. A. TWITCHHELL
1925 Western Avenue Minneapolis, Minn.

DEALERS PROMPT SHIPMENTS LIBERAL DISCOUNTS

"ERLA" New Type Reflex Transformers

All Erla reflex parts in stock including Hilco Variocouplers and Rathbun Condensers.

Dealers send for Catalog and discounts



Note!! We are the largest exclusive Radio Jobbers in the Middle West

HUDSON-ROSS
123 W. Madison St. Chicago



Dealers! We offer you merchandise at prices below competition! Write now for our amazing offer!

- \$18.50 Westinghouse Rectiron Charger, A. C. \$14.63
- \$18.00 Homecharger "Gold Seal" A. C. 14.95
- Westinghouse B Batteries..... 6.30
- \$35.00 Magnavox R-3..... 31.50
- \$5.00 Acme Audio & Radio Freq. Transformers 3.95
- \$5.00 Erla Audio Freq. Trans. 3 1/2 to 1-6 to 1 4.25
- \$5.00 Erla R.F. Type AB1-2-3 Transformers..... 4.25
- Ford Mica High Ratio Transformers..... 3.25
- Globe High Ratio Transformers..... 3.45
- \$10.00 Brunet French Phones, 4000 ohms..... 6.50
- \$6.00 Brandes Superior Phones, Genuine..... 4.75
- Hydrometers, small..... .35
- Radio Soldering Iron, furnished with solder and one box of soldering paste..... 1.60
- \$2.50 Genuine Reinartz Coll..... 2.00
- \$3.50 Improved Cockaday Coils..... 4.75
- Amsco Vernier Variable Condensers, 23 Plate 4.00
- 43 Plate..... 4.50
- Twin Cell Batteries, 1 1/2 V. 240 hours..... .50
- SUPER HETRODYNE PARTS..... on sale

MONEY ORDERS MUST INCLUDE POSTAGE
 SEND FOR OUR FREE MONTHLY PRICE LIST
 DEPT. R. D.

MARVEL RADIO CO.
132 NASSAU ST., NEW YORK

Instruments of Excellence

- Langbein & Kaufman Variocouplers and Variometers.....\$ 7.00
- Malone-Lemmon Condensers..... 7.50
- Control-O-Meters..... 12.50
- Ballantine Tuned Radio Frequency Transformers... 9.60
- Units..... 15.00
- Curcoids—The Supreme Inductance by Means of Precision Coupling Coils. 7.50

PARTS FOR ACMEDYNE NOW IN STOCK

- Amperites.....\$1.10
- Meyers Hi-Mu Tubes..... 4.35

Radio and Mechanical Trading Corp.
23 Warren St. New York City

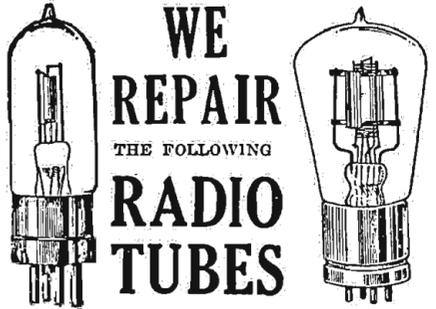

WE REPAIR THE FOLLOWING RADIO TUBES

Dealers and Agents write for Special Discount
 Mail Orders Solicited and Promptly Attended to

WD-11, WD-12, Our Specialties

- | | |
|------------------|--------------------------|
| WD-11.....\$3.00 | DV-6A.....\$3.00 |
| WD-12..... 3.00 | UV-199..... 3.00 |
| UV-200..... 2.75 | C-299..... 3.00 |
| UV-201..... 3.00 | UV-201A..... 3.00 |
| C-300..... 2.75 | C-301A..... 3.00 |
| C-301..... 3.00 | Marconi..... 3.00 |
| DV-6..... 3.00 | Moorhead..... 3.00 |
| DV-1..... 3.00 | 6 V. Plain Det..... 2.75 |
| DV-2..... 3.00 | 6 V. Plain Amp..... 3.00 |

H. & H. RADIO COMPANY
P. O. Box 22-A
Clinton Hill Station NEWARK, N. J.

The Dependable Radio Receiver



FADA "ONE SIXTY" with the NEUTRODYNE CIRCUIT

The FADA "One Sixty" is the four-tube Neutrodyne radio receiver that in selectivity, volume, distance and clarity equals the best results of any five-tube set of any type or make. Owners say: "If we don't get 'em on the loud speaker, we don't count 'em." Consistent performance on loud speaker from stations 1500 to 2000 miles away and sometimes much further.

Price \$120 at dealers
 Extra for tubes, batteries and 'phones
F. A. D. ANDREA, Inc.
1581 Jerome Ave., New York City

Fada RADIO

Bradleyswitch PERFECT BATTERY SWITCH

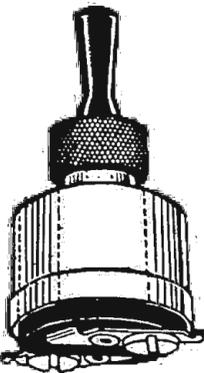

Retail Price 60c

At all Radio Dealers and Jobbers

Protect Your UV-199 Tubes

Think of it. If you let your UV-199 tubes burn accidentally, overnight, the life of the A-battery is shortened more than from a week of ordinary service. The same is true of the tubes. A Bradleyswitch prevents the accidental discharge of batteries and pays for itself in a short time. Get one now!

ALLEN-BRADLEY CO.
290 Greenfield Ave., Milwaukee, Wis.

Burned Out or Broken RADIO TUBES REPAIRED

All Tubes Guaranteed to Work Like New
 Mail Orders Given Prompt Attention

24 HOUR SERVICE—All Tubes returned P.P. C.O.D.

- | | |
|-------------------|--------------------|
| RADIOTRONS | CUNNINGHAMS |
| WD-11 or 12 | C-11 or 12 |
| UV-200 | C-300 |
| UV-201 | C-301 |
| UV-202 | C-302 |
| UV-201A | C-301A |
| UV-199 | C-299 |
| DV-1 or 2 | DV-6 or 6A |

\$275

RADIO TUBE CORP.
70 Halsey St. Newark, N. J.

SEND TO NEAREST REPAIR BRANCHES
 "RADIO TUBES"
39 West Adams St. Chicago, Ill.
 RADIO TUBE SPECIALISTS
137 Market St. Phila., Pa.

GLDBE ELECTRIC CO. 609 Cham. of Com. Bldg. Pittsburgh, Pa.
 WELLSTON RADIO CO. 1478 Hodiament Ave. St. Louis, Mo.

RIDENOUR, SEAVER & KENDIG
Caxton Bldg., Cleveland, Ohio

Split Stator For All New Hookups

The New All-Circuit

Columbia Moulded Variometer

This variometer, moulded in genuine black bakelite, represents the latest advance in construction for reason that it permits ALL of the new hook-ups of present and future. Stator is moulded in two halves with no metal bearing post in front nor in rear. Green silk wire used throughout. Silk pig-tail connections. Latest suggested hook-ups with each instrument.

No. C 109 A.....\$5.50

COLUMBIA RADIO CORPORATION
155 N. Union St. Chicago, Ill.

It's Columbia So it's Good!

Antenna Arrangement in Place of Wave Trap

Selectivity Obtained and Local QRM Cut Out

By F. J. Mehrtens

IN THE endeavors of the amateur—who likes Radio for its own sake—to obtain selectivity so as to hear distant stations through the QRM of a local station, many coupling and wave trap devices have appeared; but few seem to have thought of solving the problem by a modification of the antenna system. In the following suggestions the ideal is described. Limitations in space, materials, etc., may prohibit some from erecting an

ideal antenna system, but with the aid of the following suggestions a system may be erected as nearly ideal as possible.

Two aeriels, somewhere near 150 feet in length (one wire each) are stretched parallel to each other and as far apart as possible. Parallel to one of these aeriels, and about 6 feet away from it, is a third 100-foot single-wire aerial; while parallel to and about the same distance from the other is a fourth about 75 feet in length.

Finally, a 125-foot wire is run either diagonally between the two long aeriels or at right angles to them. The lead from each aerial unit is brought in separately, where each can be connected to a binding post on a panel provided for the purpose, or other convenient arrangement.

To obtain selectivity by this method, a number of combinations may be used with varying effects. If the QRM of a local station is troublesome when using one of

the long aeriels, the 125-foot aerial, which is diagonal to the two long ones (or at right angles to them) may be tried. If this does not prove satisfactory, one of the long aeriels may be used as an antenna and the other as a counterpoise, or a long one as an aerial and a short one, near to it or farther away from it, as a counterpoise, and vice versa. Two aeriels used in this way give greater selectivity with little or no decrease in volume.

Hints about Soldering of Radio Connections

Three things must especially be remembered while soldering. It is always important to have the surface or surfaces to be soldered perfectly clean. Emery cloth or a fine file may be used in some cases. Unclean surfaces do not permit the solder to flow freely.

The second point to bear in mind is to tin the surfaces properly. This is done by first applying a soldering flux, such as resin, acid or paste, to the surfaces, and then the well-tinned iron is run over them. This will leave a thin coating of solder

on the surfaces, thus making them ready for the connection.

The final operation should not be attempted unless the soldering copper is of the proper heat. It should never be heated above the point where the solder begins to turn gray. To tin the iron, dip the end in the soldering flux and rub a piece of solder on the surface. A thin coat of solder will remain on the soldering tip.

When soldering, the iron is placed on the surfaces to be joined together. When the solder has melted around the parts being soldered, the iron is removed and the solder will quickly set. Care should be taken not to jar the pieces while the

solder is setting and also to allow only a minimum amount of solder to flow; thus preventing an unsightly joint.

Type of Catwhisker Wire

Copper wire not larger than number 26 gauge is ideal for catwhiskers on crystal detectors. Phosphor bronze, silver and gold wire make good contact points. Brass and copper wire will be found well suited for contact with silicon, galena and iron pyrites.

RECEPTION Louder Clearer More Natural



Celerundum "DE-TEX-IT"
A perfect fixed detector **\$1.25**

Celerundum Products carry a **MONEY BACK GUARANTEE**

Celerundum Radio Products Co.
Laboratory and Office Standard Radio Corp.
170 Summer St., Boston Chicago

RADIO TUBES, Sold, Exchanged, Repaired. Free Circular. AMERICAN RADIO TUBE WORKS, IRVINGTON, N. J., U. S. A.—Adv.

C R L Non-Inductive Potentiometer

Gives complete control of plate potential or grid bias without the choking effect of wire resistors. This feature of the C R L Potentiometer alone (freedom from inductance) entitles it to your most careful consideration. And when you see

how ruggedly simple (and really is) and how superior to other potentiometers in strength, neatness and mechanical construction, you will agree with the thousands who now use them, that the C R L Non-Inductive Potentiometer is "the best on the market."

The pure graphite resistor is not touched by the sliding contact and hence is free from wear. A brass disc can be brought to bear at any one of an infinite number of points smoothly, gradually and noiselessly. A transparent cover protects the working parts from dust and moisture and permits a clear view of the interior.

No. 110 (400 Ohms) .. \$1.75
No. 111 (2000 Ohms) .. 2.00
(BY PARCEL POST, 10¢ EXTRA)

Every instrument is carefully tested and fully guaranteed.
Central Radio Laboratories
312 16th Street, Milwaukee, Wisconsin
Non-Inductive



TUBES \$1.49
Phonotron 6 Volt Detector
Only few left at this price

Variometer parts\$ 0.49
Work Rite horns 8.49
Baldwin Standard horns 21.00
Switch levers 19
V. T. 1 tubes 4.95
Dials 23
Dayton 3001 Condensers 2.49
Dayton 3005 Condensers 1.95
180° varcouplers 1.49
Variometers, green wire 1.49
Mu Rad Rad. freq. transformers 2.98
Cash or C. O. D. Write for complete list	

MARTIN HARDWARE COMPANY
Hamilton, Missouri

RADIO CABINETS
Superior Type

H. R. Panels	Size	Cabinets
\$0.95	7x10	\$2.45
1.15	7x12	2.75
1.25	7x14	2.95
1.65	7x18	3.45
1.95	7x21	3.70
2.20	7x24	3.95

Baseboards for use with above Cabinets
7x10.....25c 7x14.....35c 7x21.....45c
7x12.....30c 7x18.....40c 7x24.....50c

Shipped Any Way Desired
NEW YORK RADIO SUPPLY COMPANY
944 Rogers Place Bronx, N. Y.

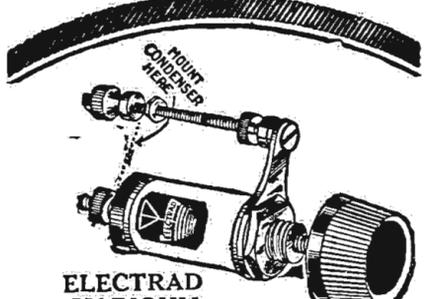

ELECTRAD VARIOHM
Doubles Your Distance
Eliminates Circuit Noises

The Variohm enables you to get exactly the correct grid resistance for your tubes and set. Any resistance from 1/4 to 30 Megohms by simply turning the knob. Once set, stays permanently. Built like a watch, yet never gets out of order. Moisture proof and non-microphonic. Can be used with any standard fixed condenser. Price, 75¢; mounted, \$1.00.

At your dealers, or direct. Satisfaction guaranteed or money back.

ELECTRAD, Inc.
428 Broadway, New York, N. Y. Dept. 00

Duo-Reflex
Tube for Tube—the Most Powerful Circuits Ever Built. Write for free Bulletin No. 16

Electrical Research Laboratories
CHICAGO. ERLA

World's Greatest BATTERY BARGAIN

FREE Written 2-Year Guarantee Your Proof of Performance

Save 50%

Thousands of Radio Digest Readers will profit by this amazing offer. They will buy the famous 2-year guaranteed World Battery at the lowest price ever quoted. They will get a hydrometer and a "B" Battery FREE. And they get the best battery built.

Compare These Prices

Special 2 Volt Storage Battery\$5.00	For UV-199 Tubes, Same features as 2 Volt.
For WD-11 and WD-12 Tubes. Will run 200 hours on one charge. Rechargeable. Special 4-v. Storage Battery\$8.00	6 Volt, 60 Amps. \$ 8.50 6 Volt, 80 Amps. 10.00 6 Volt, 100 Amps. 12.50 6 Volt, 120 Amps. 14.50 6 Volt, 140 Amps. 16.00

Send No Money. Just clip this ad and mail with your name and address. The battery you specify will be shipped to you the day your order is received. When the battery arrives, inspect it—read our 2-year guarantee before you pay one penny. Get the "B" Battery and hydrometer FREE. Order today.

WORLD BATTERY CO.
Dept. "L,"
60 E. Roosevelt Road
Chicago, Ill.

18 times more



ADJUSTED TO ALL TUBES

FILKO-STAT has a fine adjustment area many times greater than any other rheostat. It is the only rheostat assuring minute control over the maximum audibility range of the vacuum tube; bringing in DX stations you never heard before and eliminating tube noises.

30 ohms full resistance. No adjustment to puzzle. No discs to break. No Carbon Powder.

\$2 AT ALL DEALERS

FILKO-STAT
Made and Guaranteed by
DX Instrument Co., Harrisburg, Pa.
Radio Stores Corp., 218 W. 34th St., New York
Sole International Distributors



MAGNATRON! That's a name that guarantees tube satisfaction and real tube performance!

The MAGNATRON DC 201A and the MAGNATRON DC 199 stand foremost among tubes today. At the new low list of \$5 they are an outstanding value.

Your Dealer Has Them!

CONWEY ELECTRIC LABORATORIES
309 Fifth Avenue NEW YORK CITY

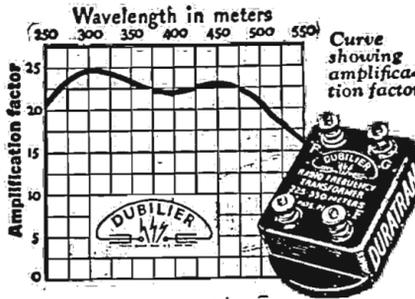

The Dubilier Duratran

The radio frequency transformer that amplifies uniformly over all broadcasting wave lengths. Price \$5.00 at good dealers.

Dubilier Condenser and Radio Corp.
44-50 West Fourth Street, New York

AT LAST
Intermediate Radio Frequency Transformers



R-91



R-90

Now you can build a Super Heterodyne receiver with the confidence that you will have "The best there is." You can log all stations and select them at will, with clear, loud speaker volume and minimum interference.

Branson Special Transformers have been designed for this work. Rigorous tests prove them far superior to anything heretofore available.

Our publication "Super Heterodyne Construction" makes it possible for the amateur to construct a complete and efficient Super Heterodyne Receiver.

Prompt delivery. At your dealer's or write for all information.

CHAS. A. BRANSTON, Inc.
835 Main St., Buffalo, N. Y.
In Canada—Chas. A. Branston, Ltd. Toronto, Ont.

and Smiles



Don't Waste Your Time

Looking for stations you have had, simply copy the readings of your set according to the stations you receive in a **KASPER RADIO RECORD BOOK**. Then, when you want IT—IT'S THERE. Daily programs are kept separate, and ample space is allotted to record 30 different stations in each daily section that you will want to hear week after week. "KASPER'S" is recognized as the only copyrighted RADIO RECORD BOOK on the market in which one can readily copy a complete reading of his set, not only the dials and switches but also the location of each rheostat controlling the detector and amplifiers. Can be used with any set—No set complete without one. Contains up-to-date list of broadcasting stations; Time the world over; Illustrations and instructions, HOW TO RECORD STATIONS. 50¢ per copy postpaid.

For your convenience send a one dollar bill for two copies or P. O. Money Order; no checks nor stamps. Silver coins at your own risk.

For sale at Radio Shops and News Dealers everywhere, or order direct from

KASPER BROTHER'S COMPANY
317 Lorain Street Bnk Bldg.
Cleveland, Ohio, U. S. A.

Questions and Answers

B Battery Leakage

(06066) CLE, Amboy, Ill.
I have a Crosley Model X receiving set with a push and pull switch mounted in the panel, to which the A wire is connected. The A + wire is connected from battery to set at all times, only the A - wire being cut out by means of switch when set is not in use. All B battery wires are connected all the time.

1. If any leakage from B battery can occur because of A + wire being connected and only A - wire cut out.

2. If any leakage from B battery can occur when wires are all left connected, only A battery being cut out.

3. If any leakage from B battery can occur when phones are left connected all the time, or if phones should be disconnected when set is not in use.

A.—There would be no leakage from B battery incurred by the method of connection of A battery as given. The only time when B battery is consumed is when tubes are lighted.

Miloplex

(5910) JM, Altoona, Pa.
I have built a Miloplex from the hook-up given in the October issue of the Digest. My knowledge of Radio is not of much account, so I put my trouble before you, possibly you can help me out. I bought the parts with a cabinet and panel 12 by 7. My posts are mounted on the panel front.

I get a strong hum through set even with rheostat turned off. When I turn it on, it cuts it down a little but not much. Would it help to use panel strip and have posts in rear? Could you give me a rough sketch of the arrangement of wiring to give best results? I am a regular reader of your paper and this is my first attempt at building my own set, and would like to make it a go. I might say that the set is very selective. I could tune the local station out at any time and would be highly pleased with the Miloplex if I could get rid of the hum.

I thought my trouble might be in the antenna and so tried the hook-up of the Digest, September 29, and got no hum through set. That convinced me that the trouble was not there. I have two good grounds on a water pipe in cellar.

A.—From your description we are inclined to believe that the hum is due to your house lighting system. If your set or antenna is close to these service lines hum will be noticeable. The proximity of an electric light or wire leading to one would cause the same disturbance. The remedy, of course, is to remove the source of hum or the receiver from its vicinity.

RD-77

(06120) ASH, Asbury Park, N. J.
Can I use hook-up RD-77 on standard short wave regenerative set?

Can I use tapped coil instead of single slide tuning coil?

If so, how many turns on a 4-inch tube,

For distance and selectivity with only two controls send One Dollar for the Haywood Type R Inductance Coil and Diagram. J. W. Haywood, 621 East 182nd Street, New York City.

YOU'VE GOT TO GET 'UM TIGHT
Send me \$1.00 and I will mail you a set of three nifty little socket wrenches that will do the trick. H. La Thoma, Melrose Park, Ill.

Build your own. Bring in stations 2200 miles away with one stage radio, frequency receiver using short indoor antenna. Blueprints and full instructions, \$1.00. Downing Co., Box A, White-water, Wis.

RADIO BARGAINS

Columbia Moulded Coupler.....	\$1.98 ea.
5 plate Variable Condenser.....	.49 ea.
5 plate Variable Condenser.....	.59 ea.
13 plate Variable Condenser.....	.76 ea.
23 plate Variable Condenser.....	.85 ea.
43 plate Variable Condenser.....	.95 ea.
11 plate Ace Vernier Condenser.....	1.75 ea.
13 plate Ace Vernier Condenser.....	1.98 ea.
43 plate Ace Vernier Condenser.....	2.29 ea.
Ace Varico-Coupler—150"—Bakelite.....	1.75 ea.
A Variometers—Bakelite—looks like a Shamrock.....	1.75 ea.
Air-Way Bakelite Couplers.....	.75 ea.
Pat. Moulded Variometers.....	1.98 ea.
Pat. Moulded Variometers.....	1.98 ea.
Ajax Panel Type Rheostat and Socket Combination.....	1.69 ea.
Freshman Panel Type Variable Leak.....	.49 ea.
Freshman Panel Type Variable & Condenser.....	.69 ea.
Peerless Double Rotor Tuning Coils.....	1.98 ea.

We carry "Everything in Radio." You save CONSIDERABLY when you buy from us. Write for FREE price list on Radio Bargains. Goods Shipped C. O. D. Money Order, Bank Draft or Personal Check Accepted.

ACE RADIO CO.
710-712 Broadway Schenectady, N. Y.

CATALOG

Latest Reflex Neutrodyne and Super-Heterodyne Circuits. 40 Diagrams, latest Hook-ups. Largest Complete Stock.

SPECIAL Super-Sensitive Crystal, 35c ea. Hot as Hot, Every Spot. Hear stations clearly. GUARANTEED ONE YEAR

Jobbers and Dealers write for Quantity Discounts.

AMERICAN RADIO MFG. CO.
Dept. V 150 W. 23rd St. New York City

514-Page RADIO Handbook Only \$1

Just off the press. The greatest book on Radio ever written. 514 pages. Compiled by Harry F. Dart, B.S.E.E., formerly with the Western Electric Co., and U. S. Army Instructor of Radio. Technically edited by F. H. Doane. Filled with sound, practical, tested information for every radio fan, from beginner to hard-boiled owl. Send \$1 to-day, and get this 514-page I. C. S. Radio Handbook before you spend another cent on parts. Money back if not satisfied.

Mail the Coupon To-day

INTERNATIONAL CORRESPONDENCE SCHOOLS
Box 8279-F, Scranton, Penna.

I enclose One Dollar. Please send me—postpaid—the 514-page I. C. S. Radio Handbook. It is understood that if I am not entirely satisfied I may return this book within five days and you will refund my money.

Name.....
Address.....

\$25.00 LOUD SPEAKER

with Unit and Cord for \$9.50

10 inch Bell, Height 24 inches. Colors: Black, Mahogany, Olive Green.

On account of the unethical methods pursued by the average Radio dealer, I have decided to sell my product direct to the consumer, thus eliminating the factory sales agent, the distributing jobber and dealer, and saving for the consumer four profits. My speaker would sell in the retail store for \$25.00. Buy direct and save the difference. My price, \$9.50, delivered anywhere in United States or Canada. Orders filled in rotation.

EMIL DECLYNE
15 Park Row, Room 612, NEW YORK CITY
Send M. O. or C. O. D. Dept. R. D., Barclay 6298

No. 804 \$15.00

complete with Baldwin Type C Loudspeaker unit.

At Last! the true, pure voice of RADIO

The "Madera" Die-cast Wood "CLEARSPEAKER" made from an artificial wood, twice as dense as natural wood, with acoustic properties that will give your radio set a power and tone-quality you never dreamed possible. If your Dealer does not have it, write us, giving his name and address.

American Art Mache Co.
347 West Austin Avenue CHICAGO

and where should the taps be placed?
What size and kind of wire should be used in making coil?
A.—RD-77 can be used on a standard short wave regenerative set. A tapped coil can be employed, as suggested. It can be made by winding 56 turns, tapped at every seventh turn, using number 20 scc. wire.

Broadcasting and Code

(05517) GCP, Canton, N. C.
Is there a circuit that will receive Radiophone and will not receive spark telegraph signals? If there is such a circuit will you give it to me, that is, a copy of it.

A.—There is no circuit developed at this stage of Radio communication that will not receive spark signals.

PANELS

7 x 10..\$0.95	7 x 15..\$1.65	7 x 26..\$2.40
7 x 12.. 1.10	7 x 21.. 1.95	7 x 28.. 2.60
7 x 14.. 1.30	7 x 24.. 2.25	7 x 30.. 2.75
9 x 14.. 1.75	9 x 18.. 2.25	9 x 21.. 2.50
12 x 14.. 2.25	12 x 18.. 3.00	12 x 21.. 3.50

*"thick—Black—" add 25%
Send money order or pay Postman
UNION RADIO COMPANY
144 N. Union St. Akron, Ohio

CRYSTAL IS REMOVABLE & REPLACEABLE
CUP TURNS IS ADJUSTABLE
EASILY MOUNTED
ALL METAL COVERED KEEP SUN & DUST OUT
SOLID GOLD CAT WHISKER
CAT WHISKER TURNS & IS REMOVABLE
SPECIALLY ADAPTED FOR REFLEX WORK

"LINCOLN" DETECTOR

Creating tremendous sensation. Enclosed, fixed, adjustable. New. Kills reflex troubles. Brings in distant stations loud and clear. You need it. Ask your dealer or write—today. Price only \$2.00. Absolutely guaranteed for one year.

Jobbers, Dealers: Wire or write. Mention this ad. Address: Dept. N.
LINCOLN MFG. CO.
Los Angeles, Calif.

RADIO BY MAIL

UV-200, UV-201A, UV-199, WD-11, WD-12 \$4.24
GENUINE RADIOTRON TUBES..... \$4.24

"COCKADAY" Cotton Wound Coils..... \$2.19
"COCKADAY" Bakelite Silk Wound Coils..... 3.38
48,000 OHM LAITTE RESISTANCES..... 1.19

COMO Duplex Audio Push-Pull Transformers..... \$9.38

BRANDES "SUPERIOR" PHONES..... \$4.69
BRANDES "TABLE TALKER"..... 8.12

2 AMP. Battery Charger with "Tungar" Bulb..... \$9.38

5 Amp. Size..... 18.45

"ERLA" Audio and Reflex Transformers..... \$3.96
"ACME" Audio and R. F. Transformers..... 3.94
"HEGHEGHO" Audio Transformers..... 2.79
ALL AMERICAN Push-Pull Transformers..... 9.57

VARIABLE CONDENSERS
(Moulded End Plates Guaranteed)

11-Pl. Regular..... \$.94 Vernier with Dial..... \$1.89
23-Pl. Regular..... 1.19 Vernier with Dial..... 2.19
43-Pl. Regular..... 1.34 Vernier with Dial..... 2.49

BREMER-TULLY "Vernier Tuner"..... \$3.94
No. 2156 LARGE 224-V. "B" Batteries..... 1.76
No. 2306 LARGE 45-V. "B" Batteries..... 3.54

\$25 Set NEUTRODYNE Transformers, \$13.95
Condensers and Neutrodynes.....

"ERLA" Crystal Detectors..... \$.89
"UNCLE SAM" Tuning Coil..... 4.76
"HILCO" Lattice Wound Variocoupler..... 5.87
0 to 50 Volt Pocket Voltmeter..... 1.12
"VALLEY" (New Style) Battery Charger..... 15.49
"GOLD SEAL" Homecharger..... 15.72

CASH OR C. O. D.—SEND FOR COMPLETE LIST

SIMPLEX RADIO SUPPLY CO.
1806 Lafayette Avenue ST. LOUIS, MO.

CARTER Portable Jack \$1.50

Can be used as extension for operating phones or loud speaker at a distance. Attach Portable Jack to Radio set by cords (or wires) any length desired. Accommodates any standard Plug.

Same high Carter standard
Send for catalog of other Carter Products

Carter Radio Co.
205 S. STATE STREET CHICAGO

However, there are many efficient circuits of such selectivity, that when operated in a skillful manner, they will entirely eliminate interference of this nature. Complaints of and annoyance from telegraph signals are mainly due to inefficient receiving circuits and operation.

A Radio amateur should not expect a set to work the first time it is hooked up.

Super-Heterodyne

Standard and special parts for all Super-Heterodyne and Neutrodyne Circuits in stock.

Aeriola Sr. Style Tuner Units
Push-pull Transformers
Bishop Phantom Super Tuner Units

Special parts you cannot get elsewhere
Send for new dealers' list
"SILVERTONE"

The remarkable new Hi-Power receiver
QUALITY RADIO SHOP, Richmond, Ind.

YOU DON'T NEED TUBES

to hear concerts from out of town. If you want to get new stations ON YOUR CRYSTAL SET write me today. I get new records every day from people using my plans who hear programs on Crystal from stations 400 TO 1000 MILES AWAY.

No tubes, batteries or amplifying apparatus necessary. I hear KDKA (Pittsburgh Pa.) on Galena. You may already have everything you need and just have it connected up wrong. Send self-addressed envelope for picture of my set, and reasons why you need my plans.

LEON LAMBERT
501 South Volusia, Wichita, Kan.

The Cabinet You Are Looking For

Highest Quality **CORBETT'S** Latest Designs

OUR STANDARD
This cabinet is hinged to base with loose pin hinges, permitting entire clearance for removal for ventilation. Top and base snap in, latter being raised to allow clearance for wiring and screws underneath. Panels to be fastened to base, and top as required.

Panel	Depth	Price	Panel	Depth	Price
6x10 1/2"	7"	\$2.60	7x18"	8"	\$3.80
6x21"	7"	3.85	7x21"	8"	4.35
7x10"	8"	3.15	7x24"	8"	4.90
7x12"	8"	3.50	7x26"	8"	5.10
7x14"	8"	3.50	7x14"	10"	4.35

All sizes, also furnished in old style hinged top and grooved front; no screws required. Price 10¢ above list.

Genuine oak, dark finish, or hand rubbed mahogany finished hardwood. (Old size—order, Disc.) to jobbers and dealers—our cabinets will sell for the counter. Guaranteed to please or money refunded. Shipped C. O. D. Plus Postage.

Corbett Cabinet Mfg. Company
5323 N. Carlisle St. Philadelphia, Pa. 5814 Forbes St. Pittsburgh, Pa.
Plant—St. Marys, Pa.

For Better Tuning

The B-T Vernier Tuner has no equal
It's the Original Tuner

Better Tuning B-T
Price 10c

Our Better Tuning booklet will improve your knowledge of Radio. It tells you why and shows you how. At your dealers or sent for 10c.

BREMER-TULLY MFG. CO.
532 S. Canal Street, Chicago

Radiophone Broadcasting Stations

Corrected Every Week—Part I

AA3, Denver, Colo. 440 meters. Fitzsimmons Gen. Hospital (Educational Dept. U. S. Army). Fri. 8-9 pm, music, entertainment. Mountain.

AO6, Canton, O. 425 meters. Hdqrs. 135th Field Artillery. U. S. Army.

AS6, San Antonio, Tex. 360 meters. U. S. Army, Ft. Sam Houston. Mon, Thurs, irregular.

AV7, St. Paul, Minn. 400 meters. 6th Inf. Minn. Nat'l Guard, St. Paul Army. Irregular schedule. Central.

AW5, Dayton, O. McCook Field, U. S. Army. Experimental work only.

BE1, Tacoma, Wash. 400 meters. 50 watts. Camp Lewis. U. S. Army, Third Signal Corp. Discontinued indefinitely.

CFAC, Calgary, Alta., Can. 420 meters. 500 watts. Calgary Herald. Daily ex Sun, 1 pm, 3:30-4:30 pm, 7:30-9 pm; Wed, 7:45-8:45 pm; Mon, Thurs, 9-10 pm; Fri, 11 pm, music, entertainment, news, market, weather. Dance orchestra Sun, 11 am, 7:30 pm, church services. Mountain.

CFCA, Toronto, Ont., Can. 400 meters. Toronto Star. Daily ex Sun, 12 m. weather, news, stock; 5:30-6 pm, news; 8-9 pm, music, Sun, 7 pm, church services. Eastern.

CFCF, Montreal, P. Q., Can. 440 meters, 400 watts. Marconi Wireless Tel. Co. Daily 1-1:30 pm, Mon, 7:30-9 pm; Wed, 8-8 pm; Fri, 7:30-12 midnight, music, entertainment, reports. Eastern.

CFCH, Iroquois Falls, Ont., Can. 400 meters, Albitibi Power & Paper Mills. Daily, 9 pm, reports, music, entertainment. Experimental station. Eastern.

CFCL, Quebec, Que., Can. 410 meters. La Cie de L'Evenement.

CFCK, Edmonton, Alta., Can. 410 meters. Radio Supply Co. Daily ex Sun, 8-8:45 pm, music. Sun, 3:30-4:30 pm. Concert. Mountain.

CFCL, Victoria, B. C., Can. 400 meters. 500 watts. Centennial Methodist Church. Slogan, "Where Religion Cheers." Tues, 8:30-10:30 pm, concerts, lectures. Sun, 11 am, 7:30 pm, church services. Pacific.

CFCN, Calgary, Alta., Can. 440 meters. 500 watts. W. W. Grant Radio Ltd. Slogan, "Voice of the Prairies." Mon, 11 pm, music. Wed, 10-11 am, dance music. Sat, 8-12 pm, dance music. Test program, Sat. after midnight. Mountain.

CFCO, Bellevue, P. Q., 450 meters. Semmelhaack-Dickson, Ltd. Daily ex Sat, Sun, 9:45-10:30 pm, news, markets, reports, sports, time, music. Sat, 9:30-11 pm, music. Sun, 9:15-10:45 pm, sacred music. Eastern.

CFCQ, Vancouver, B. C., Can. 450 meters. 10 watts. Radio Specialties, Ltd. Mon, Thurs, Sat, 7:30-8 pm. Music. Tues, 7:30-8 pm, children's evening, Wed, 4-5 pm. Music. Sun, 8:30-9:30 pm, classical music. Pacific.

CFCR, Sudbury, Ont., Can. 410 meters. 200 watts. Laurentida Air Service, Ltd.

CFCW, London, Ont., Can. 420 meters. 500 watts. The Radio Shop. Tues, Fri, 8:30-9:30 pm. Eastern.

CFCD, Nanaimo, B. C., Can. 430 meters. 10 watts. Sparks Co. Mon, Wed, Fri, 7:30-8 pm. Pacific.

CFCE, Sask., Sask., Can. 400 meters. 50 watts. The Electric Shop, Ltd. Slogan, "The Hub City of the West Where No. 1 Northern Hard Wheat Grows." Daily ex Sun, 1-1:30 pm, markets, reports, music. Mon, Tues, Thurs, Fri, 7:30-9 pm, news, reports, markets, entertainment. Sun, 9-9:45 pm, church services. Mountain.

CFCC, Kingston, Ont., Can. 450 meters. Queen's University.

CFUQ, Montreal, P. Q., Can. 400 meters. Univ. of Montreal.

CHAC, Halifax, N. S., Can. 400 meters. 20 watts. Radio Engineers.

CHBC, Calgary, Alta., Can. 410 meters. The Alberta Pub. Co. Daily ex Sat, 8:45-9 pm, news, stock quotations, music. Mountain.

CHCD, Quebec, Que., Can. 410 meters. Canadian Wireless and Electric Co. Mon, 7:30-9 pm; Wed, 8-9; Sat, 8-10, music. Eastern.

CHCE, Victoria, B. C., Can. 310 and 400 meters. Western Canada Radio Suppl. Ltd. Slogan, "The Voice of the Island." Daily ex Sun, 7-8 pm, music, stock reports, entertainment. Sun, 9-10 pm, music, entertainment. Pacific.

CHCL, Vancouver, B. C., Can. 440 meters. 2000 watts. The Vancouver Merchants Exchange, Ltd.

CHOM, Calgary, Alta., Can. 440 meters. 500 watts. Riley & McCormick Ltd. Thurs, 7:30-8:30 pm, musical. Mountain.

CHYC, Montreal, Que., Can. 341 meters. 500 watts. Northern Elec. Co. Wed, 8:30 pm, Sun, 7 pm, Eastern.

CICA, Edmonton, Alta., Can. 450 meters. 500 watts. Edmonton Journal, Ltd. Slogan, "The Sunniest Spot in Sunny Alberta." Club, "Igloo Hut." Daily ex Sun, 12:30 pm, weather, markets, 7:30-8 pm, children's half hour. 8:30-9:30 pm, concert, reports. Thurs, 11:15 pm, Igloo Hut meetings. Mountain.

CJCD, Toronto, Ont., Can. 410 meters. T. Eaton Co. Daily ex Sat, Sun, 4-4:30 pm, music. Eastern.

CJCE, Vancouver, B. C., Can. 420 meters. Sprout-Shaw Radio Co. Daily ex Sun, 12:30-1:30 pm. 3:30-5-10, music, news. Pacific.

CJCI, St. John, N. B., Can. 400 meters. Maritime Radio Corp., Ltd. Mon, Wed, Fri, 7:30-9 pm, music. Sat, 9-11 pm, music. Eastern.

CJCM, Montreal, P. Q., Can. 400 meters. 250 watts. Dr. J. L. P. Landry. Slogan, "Three weeks below Quebec where civilization nearly ends." Daily ex Mon, 12-1 pm, news. Daily, 5-6 pm, 11-12:30 midnight. Mon, Tues, Thurs, Fri, Sat, 9-9:30 pm, music. Wed, Sun, 8-10 pm. Eastern.

CJCN, Toronto, Ont., Can. 410 meters. Simons, Agnew & Co. Signals.

CJCK, Olds, Alta., Can. 400 meters. 200 watts. Percival W. Shackleton. Slogan, "Echo from the Rockies." Daily ex Sun, 6-6:45 pm, music, news, time, entertainment. Mountain.

CJGC, London, Ont., Can. 430 meters. London Free Press. Daily ex Sun, 9:30-10 am, 12-1 pm, 9:30-6 pm, news, market and weather, 8-9, music, entertainment. Eastern.

CJSC, Toronto, Ont., Can. 430 meters. The Evening Telegram.

CKAC, Montreal, Que., Can. 425 meters. 1,200 watts. La Presse. Daily ex Sat, Sun, 4 pm, music; 4:30, weather, markets, stocks. Tues, Thurs, Sat, 7 pm, children's hour; 7:30, concert; 10:30, specials. Sun, 4:30 pm, sacred concert. Eastern.

CKCD, Vancouver, B. C., Can. 410 meters. 2,000 watts. Vancouver Daily Province. Daily ex Sun, 8:30-9:30 pm, music, news, entertainment. Pacific.

CKCE, Toronto, Ont., Can. 450 meters. 750 watts. Can. Ind. Telephone Co. Occasional programs.

CKCH, Ottawa, Can. 435 meters. 500 watts. Canadian National Railway.

CKCK, Regina, Sask., Can. 420 meters. 500 watts. Leader Pub. Co. "The Queen City of the West." Daily ex Sat, Sun, 9:34, time; 10-10:30 am, 1:15-2 pm, 7:30-8:15. Tues, 7:30-9 pm, music, entertainment, news, market, weather. Sat, silent night. Sun, 9, service. Mountain.

CKXC, Calgary, Alberta, Can. 440 meters. 500 watts. P. Burns & Co., Ltd. Tues, Fri, 9-10 pm, music. Mountain.

CKOC, Hamilton, Ont., Can. 410 meters. 20 watts. Wentworth Radio Supply Co., Ltd. Slogan, "In the Garden of Canada." Mon, Wed, Fri, 8-9 pm, music, entertainment. Sun, 7-8 pm, church services. Eastern.

CKY, Winnipeg, Man., Can. 450 meters. 2,000 watts. Manitoba Tel. System. Daily ex Sun, 12:30-1:30 pm, music, lectures, etc.; 2 pm, grain markets, weather. Sun, 7 pm, church services; 9, sacred concert. Central.

CYB, Mexico City, Mex. 425 meters. 500 watts. El Buen Tono. Tues, Sat, 7:30-9 pm. Thurs, 8-10 pm, concert. Mexican time.

CYL, Mexico City, Mex. 500 meters. 500 watts. Tues, Fri, 9-10:30 pm. Mexican.

KDKA, E. Pittsburgh, Pa. 324 meters. 1,000 watts. Westinghouse Elec. & Mfg. Co. Daily ex Sun, 9:45-10 am, 12-1 pm, market reports, music; 6-10 pm, news, features, markets, concert; 9:55-10, time. Sun, 10-45 am, church service; 2:30 pm, Bible story; 2 pm, concert; 4:45 pm, 3:30, church service. Eastern.

KDPM, Cleveland, O. 270 meters. Westinghouse Elec. & Mfg. Co.

KDPT, San Diego, Calif. 244 meters. 100 watts. Southern Elec. Co. Slogan, "At the End of the Trail." Daily ex Sun, 1:30-2:30 pm, 6:00-8:45. Wed, 9:00-10:00 pm. Sun, 10:00-11:30 am. Pacific.

KDVL, Salt Lake City, Utah. 360 meters. 100 watts.

Newhouse Hotel. Slogan, "Better Radio." Daily ex Sun, 6:30-8 pm, news, music, entertainment. Mountain.

KDWM, San Diego, Calif. 280 meters. 100 watts. Savoy Theater. Mon, Wed, Fri, 8-10 pm, music, entertainment. Pacific.

KDYO, Portland, Ore. 360 meters. 100 watts. Oregon Institute of Technology. Slogan, "The Radio School." Educational programs.

KDYW, Phoenix, Ariz. 360 meters. 20 watts. Smith Hughes & Co. Temporarily discontinued.

KDYX, Honolulu, T. H. Hawaii. 360 meters. 100 watts. Honolulu Star-Bulletin Co., Ltd. Daily ex Sun, 12:15-1:15 pm, reports; 6:30-7:30 pm, entertainment, music, talks. Mon, Wed, Sat, 9:15-10:15 pm, dance music. Sun, 11 am-12:15 pm, church services. 12:0th Meridian.

KDZB, Bakersfield, Calif. 210 meters. 100 watts. Frank Siebert. Daily ex Sun, 8-9 pm, reports, music. Sun, sacred program, irregular. Pacific.

KDZE, Seattle, Wash. 270 meters. 100 watts. The Rhodes Co. Daily, 12:30-1:30 pm. Pacific.

KDZI, Wenatchee, Wash. 360 meters. 50 watts. Elec. Supply Co. Temporarily discontinued.

KDZQ, Denver, Colo. 360 meters. Nicholas Academy of Dancing.

KDZR, Bellingham, Wash. 261 meters. 50 watts. The Bellingham Pub. Co. Daily and Thurs, 7-8 pm. Pacific.

KFAD, Phoenix, Ariz. 360 meters. 100 watts. McArthur Brothers. Daily ex Sun, 7:30-8:30 pm, news, weather, stock reports, music. Mountain.

KFAE, Pullman, Wash. 330 meters. 500 watts. State College of Washington. Slogan, "Your Service Station." Mon, Wed, Fri, 7:30-9 pm, lectures, music, readings. Pacific.

KFAF, Denver, Colo. 360 meters. 500 watts. Western Radio Corp. Slogan, "Voice from the Rockies—Out Where the West Is." Mon, Tues, Fri, Sat, 8-9 pm; Thurs, 7:30-8, music, reports, news. Wed, silent. Mountain.

KFAJ, Boulder, Colo. 260 meters. 100 watts. Univ. of Colo. Tues, Thurs, Sat, 9 pm, time, music, addresses by faculty. Sat, 2:30-5 pm, football. Mountain.

KFAM, Moscow, Ida. 360 meters. 50 watts. The Electric Shop.

KFOA, Seattle, Wash. 455 meters. 500 watts. Mon, Wed, Fri, 8:30 pm. Pacific.

KFAR, Hollywood, Calif. 280 meters. 200 watts. Studio Lighting Service Co.

KFAU, Boise, Ida. 270 meters. 150 watts. Boise H. S.

Club, "Radio Bats." Daily, 4-4:30 pm, children's hour; Wed, 8:30-10 pm, music; Sun, special afternoon program. Central.

KFDS, San Francisco, Calif. 380 meters. John D. Sl-Kea.

KFDV, Fayetteville, Ark. 360 meters. 200 watts. Gilbrech & Sons N. Slogan, "Southern Gateway to the Ozarks." "Land of a Million Smiles." No regular schedule.

KFDX, Shreveport, La. 260 meters. 100 watts. First Baptist Church. Sun, 11 am; 7:30 pm. Central.

KFDY, Brookings, S. D. 360 meters. 50 watts. S. D. State College of Agr. & Mech. Arts. Tues, 11 am, music lectures, news. Wed, 8:15 pm. Music, lectures. Central.

KFDZ, Minneapolis, Minn. 231 meters. 5 watts. Harry O. Iverson. Sun, 6-7 pm, pipe organ. Central.

KFEJ, Portland, Ore. 360 meters. 50 watts. Meier & Frank Co., Inc. Daily ex Sun, 12 m. weather, reports; 4-5 pm, music; 6:30 pm, weather, crop, markets, reports. Thurs, 9-10 pm, concert. Sat, 11 am 12 m. children's hour. Pacific.

KFEL, Denver, Colo. 360 meters. 50 watts. Winner Radio Corp. Daily ex Sun, 9 am, 10, 11, 11:45, stock reports; 2-4 pm, music. Mon, Fri, 9-10 pm, concerts. Sun, 9-10 am, church services. Mountain.

KFEQ, Oak, Neb. 360 meters. 100 watts. J. L. Scroggin. Tues, 9-10 pm. Central.

KFER, Fort Dodge, Ia. 231 meters. 20 watts. Auto Electric Service Co.

KFEW, Casper, Wyo. 263 meters. 250 watts. Casper Radio Club. Daily, 8:30 am, weather warnings, entertainment. Tues evening program. Sun, 3 pm, services; 8 special program. Mountain.

KFEX, Minneapolis, Minn. 261 meters. 100 watts. Augsburg Seminary. Tues evening music. Central.

KFEY, Kellogg, Ida. 360 meters. 10 watts. Bunker Hill & Sullivan Mining Co. Slogan, "Voice of the Coeur d'Alene." Mon, Wed, Sat, Sun, 7:30-8:30 pm. Pacific.

KFEZ, St. Louis, Mo. 360 meters. 100 watts. American Society of Mech. Engrs. Wed, 8:30-9:30 pm, Engineering program. Central.

KFFB, Boise, Ida. 273 meters. 10 watts. Jenkins Furn. Co. (Owyhee Hotel). Tues, Thurs, Sat, 8-10 pm, concert. Mountain.

KFFE, Pendleton, Ore. 360 meters. 10 watts. Eastern Ore. Radio Co. Daily ex Sun, 8:30-9:30 pm, music. Pacific.

Thurs, Sat, 8:30 pm. Fri, 1:30 pm, 3:30, 6:30. Sat, 4:30, 8:30. Sun, 1 pm, 3, 4:30, 7:15. Pacific.

KFHS, Lihue, Hawaii. 275 meters. 30 watts. C. Ord J. Dow.

KFHX, Hutchinson, Kans. 229 meters. 200 watts. Robert Nelson.

KFI, Los Angeles, Calif. 469 meters. 500 watts. Earle C. Anthony, Inc. Slogan, "The Radio Central Station." Daily ex Sun, 5-6 pm, 6:45-7.0 pm, 8-11 pm, Wed, Fri, Sat, 8-12 pm. Sun, 12-10:45 am, 4-5 pm, 6:45-7:30, 8-11. Pacific.

KFID, Lila, Kas. 114 m. 100 watts. Ross Art-buckles Garage. Slogan, "The Garden Spot of the State." Daily, 5:15-5:45 pm. Tues, 9-10 pm. Central.

KFIF, Portland, Ore. 360 meters. 100 watts. Beau-nd T. h Student Body.

KFIL, Louisville, Kans. 231 meters. 30 watts. Wundisch Elec. Farm Equip. Co. Wed, Sat, 8-10:30 pm. Sun, 11-12 m. church services. Central.

KFIO, Spokane, Wash. 252 meters. 50 watts. N. th Central High School.

KFIQ, Yakima, Wash. 242 meters. 50 watts. Yakima Valley Broadcasting Assn. Slogan, "The Station That Will Make 234 Famous." Mon, Wed, Fri, 7:30-8.0 pm, concert. Sat, 7:30-8 pm, S. S. lesson. Sun, 4-5 pm, music. Pacific.

KFIU, Juneau, Alaska. 226 meters. 10 watts. Alaska Elec. Light & Power Co. Mon, Wed, Fri, 7:30-9 pm. Pacific.

KFII, Independence, Mo. 240 meters. 250 watts. Reorganized Church of Jesus Christ of Latter Day Saints. Tues, Thurs, 9 pm. Sun, 11 am, 7:30 pm. Central.

KFIZ, Fond du Lac, Wis. 273 meters. 160 watts. Daily Commonwealth and Oscar A. Huelshman. Daily ex Sun, 5 pm, music news, markets, weather. Central.

KFJB, Marshalltown, Iowa. 248 meters. 10 watts. Iowa Elec. Co. Slogan, "Marshalltown, the Heart of Iowa." Tues, Fri, 8:30 pm. Central.

KFJC, Seattle, Wash. 270 meters. 100 watts. Post Intelligencer. Slogan, "Broadcasting from the 'Charmed Land.'" Daily ex Sun, 3:30-4:30 pm, music; 5:30-10, programs, dance music. Tues, Thurs, 7-7:30 pm, code. Sat, 8:30-12 m. dance. Pacific.

KFJF, Oklahoma City, Okla. 252 meters. 20 watts. National Radio Mfg. Co. Slogan, "Radio Headquarters." Daily ex Sun, 3 pm, concert; 8:30, pop. announcements. Tues, Fri, 8:30 pm, concert. Central.

KFJA, Astoria, Ore. 252 meters. 10 watts. E. E. Marsh and Liberty Theater Organ. Daily ex Sun, 6:30-7:30 pm. Sun, 9:30-10:30 pm. Pacific.

KFJK, Bristow, Okla. 233 meters. 100 watts. Delano Radio & Elec. Co. Daily ex Sun, 3-4 pm, music. Thurs, 8-9:30 pm, music. Sun, 7:30 pm, church services. Central.

KFJL, Ottumwa, Ia. 242 meters. 10 watts. Harborside Mfg. Co. Club, "Boiled Bugs." Mon, Wed, Fri, 7:30-8:30 pm. Central.

KFJM, Grand Forks, N. D. 280 meters. 100 watts. University of North Dakota.

KFJN, Grand Forks, N. D. 230 meters. 5 watts. Val-ley Radio Div. of Elec. Constr. Co.

KFJR, Stearns, Mont. 253 meters. 6 watts. Ashley. C. Dixon & Son. Slogan, "The Bitter Root Valley Broadcasting Station." Fri, Sun, 8-9 pm, music, readings. Mountain.

KFJV, Dexter, Ia. 224 meters. 10 watts. Thomas H. Warren. Daily ex Sun 9:15 am, 10:25, 1:45 pm, weather, markets. Tues, Fri, 8:30 entertainment. Central.

KFJW, Towanda, Kans. 226 meters. 10 watts. Lo grande Radio Co. Mon, Thurs, 8:45-10:45 pm. Wed, Sat, 7-8:30 pm. Sun, 7:30-9 pm, church services. Central.

KFJX, Cedar Falls, Iowa. 229 meters. 50 watts. Iowa State Teachers College. Educational programs.

KFJY, Fort Dodge, Iowa. 246 meters. 50 watts. Tun-wall Radio Co. Daily ex Sun, 9-10 am, 12 m, 5 45 pm, markets, news, weather; 9:45, weather. Central.

KFJZ, Fort Worth, Texas. 254 meters. 20 watts. Texas National Guard, 12th Cavalry. Wed, 8:30-9:30 pm. Sat, 8:30-10 pm, program. Central.

KFKA, Greeley, Colo. 273 meters. 50 watts. Colorado State Teachers College. Mon, Tues, Wed, Thurs, Fri, Sat, 8:40-9 am. Sun, 9:30-10:30 pm, concert. Mountain.

KFKB, Milford, Kans. 286 meters. 500 watts. Brink-ley-Jones Hospital Assn. Slogan, "The Home of Grand Transplantation." Mon, Wed, Fri, 7-8 pm, 8-10, 11-12, 12:45-2:30. Sat, 11-2:30 am, Early Bird Concert. Central.

KFKC, Conway, Ark. 224 meters. 100 watts. Conway Radio Lab. Daily ex Sun, 12 m, weather, market reports. Tues, Fri, 8 pm, music. Sunday evening, church services. Central.

KFKV, Butte, Mont. 283 meters. 50 watts. F. F. Gray. Tues, Thurs, 8-10 pm. Pacific.

KFKX, Hastings, Neb. 341 meters. 1000 watts. West-inghouse Elec. & Mfg. Co.

KFKZ, Colorado Springs, Colo. 234 meters. 32 watts. Nassour Bros. Radio Co. Daily ex Sun, 12-1 pm, 5-6, matinee musicale. Mountain.

KFLA, Butte, Mont. 253 meters. 5 watts. Abner R. Willson.

KFLB, Menominee, Mich. 248 meters. 5 watts. Signal Elec. Mfg. Co.

KFLD, Franklinton, La. 234 meters. 20 watts. Paul E. Greenlaw.

KFLE, Denver, Colo. 263 meters. 100 watts. National Educational Service. Daily, 7-7:30 pm. Broadcasts for schools on request. Mountain.

KFLH, Salt Lake City, Utah. 261 meters. 50 watts. Erickson Radio Co., Inc.

KFLI, Cedar Rapids, Iowa. 240 meters. 20 watts. R. C. H. Foster.

KFLJ, Little Rock, Ark. 261 meters. 20 watts. Bizzell Radio Shop. Mon, 8-9 pm, music. Tues, Thurs, 8-9:30 pm, revival services. Sun, 11:00-12:00 m., 8-9:30 pm, church services. Central.

KFLR, Albuquerque, N. M. 254 meters. 100 watts. University of New Mexico. Fri, 8 pm, educational program. Mountain.

KFLU, San Benito, Texas. 236 meters. 20 watts. Rio Grande Radio Supply House.

KFLV, Rockford, Ill. 229 meters. 100 watts. Rev. A. T. Fryman.

KFLX, Galveston, Tex. 240 meters. 10 watts. George B. Clough.

KFLY, Fargo, N. D. 231 meters. 20 watts. Fargo, Radio Supply Co. Tues, Thurs, Sat, 5-6 pm, Sun, 3-4 pm. Central.

KFLZ, Atlantic, Ia. 273 meters. 100 watts. Atlantic Automobile Co. Wed, 6-7 pm, dinner program; 9-11, music. Sat, 11-12, midnight, dance music.

KFMQ, Fayetteville, Ark. 263 meters. 100 watts. C. of Arkansas.

KFMR, Sioux City, Ia. 261 meters. 10 watts. Morn-Inside College.

KFMS, Duluth, Minn. 275 meters. 100 watts. Frei-ling Dept. Store.

KFMT, Minneapolis, Minn. 231 meters. 5 watts. Dr. George W. Young. Thurs, 10:45 pm, Sun, 12:15-1:45 pm, 2-3:30. Central.

KFMU, San Marcos, Tex. 240 meters. 20 watts. Stevens Bros.

KFMW, Houghton, Mich. 266 meters. 50 watts. M. G. Sater.

KFMX, Northfield, Minn. 283 meters. 500 watts. Carleton College. Wed, 7:30 pm. Central.

KFMY, Roswell, N. M. 25 meters. 500 watts. Ros-well Broadcasting Club.

KFNC, Corsicana, Texas. 234 meters. 20 watts. Alonzo Monk, Jr.

KFNF, Shenandoah, Ia. 266 meters. 500 watts. Henry Field Seed Co.

KFNG, Coldwater, Miss. 254 meters. 10 watts. Wooten's Radio Shop. Wed, 8.9 pm, Sat, 9:30-10:30 pm. Sun, 4-5 pm. Central.

KFNH, Springfield, Mo. 236 meters. 20 watts. Stato Teachers College.

KFNJ, Warrensburg, Mo. 234 meters. 50 watts. War-rensburg Elec. Shop. Tues, Fri, 8-10 pm. Central.

KFNK, Peabody, Kan. 240 meters. 10 watts. Peabody Radio Service.

KFNV, Helena, Mont. 261 meters. 5 watts. Montana Phonograph Co.

KGB, Tacoma, Wash. 252 meters. 50 watts. Tacoma Daily Ledger. "This is KGB in Tacoma, Wash-ington, the Lumber Capital of America." Mon, Wed, Fri, 7-9 pm. Pacific.

(NOTE—The second part of the station data list will appear next week.)

CHALLENGE!

ONE DOLLAR will be paid to the first Radiophon submitting the most errors in any station's listing. Letters must reach Radio Digest office not later than one week from date of issue corrected. Readers are not limited to correcting one station. Turn in corrections for as many stations as you can find—if you can find errors! Use separate sheet of paper for each station submitted and place name and address on each sheet. That's just how sure Radio Digest is that this Radiophone station directory is correct! To make the challenge fair for everyone, broadcasting stations and their employees are barred from this offer. Why? Because the broadcasters are the source of all the data given herein. They are (or should be) interested enough to answer the inquiry sent them every time data on their station appears. This inquiry contains a proof of their last listing and must either be corrected or oked as correct and returned to the Digest. Nevertheless, sometimes the stations

are careless, and mistakes are made. But Radio Digest is so sure of the exactness of this directory that this challenge is made unconditionally. With reference to the directory: It appears in four parts, serially continuously; the first three parts are station data listings, arranged alphabetically; the fourth part is a state, city index of stations. The information contained in each station data listing is given in the following order: Call letters, city, state, wave length used, estimated sure range (by Radio Digest) in miles, owner's name, slogan used, if any, name of listener in "club," schedule of operating hours, and kind of time used. Four successive issues of Radio Digest will give one the most complete and accurate list of broadcasting stations obtainable. This service is original with this publication, and has been maintained from the start. Right of reproduction without permission of any or all of the data contained herein is denied.

Daily ex Sat, Sun, 3:30-4:15 pm, markets, weather, news. Mon, Wed, Fri, 8-9 pm, concert. Mountain.

KFAW, Santa Ana, Calif. 261 meters. 10 watts. Radio Den. Daily ex Sun, 4:30-5 pm, news, reports, music. Mon, Thurs, 6:30-7:30 pm, concert. Pacific.

KFAY, Medford, Ore. 283 meters. 50 watts. W. J. Virgin. Temporarily discontinued.

KFBB, Havre, Mont. 360 meters. 50 watts. F. A. But-try Co. Discontinued temporarily.

KFBC, San Diego, Calif. 278 meters. 20 watts. W. K. Achill. Thurs, Sun, 8-9 pm, Bible lesson, sermon. Pacific.

KFBE, San Luis Obispo, Calif. 360 meters. 50 ml. R. H. Horn. Temporarily discontinued.

KFBG, Tacoma, Wash. 360 meters. 50 watts. First Presbyterian Church. Sun, 11 am-12:15 pm, 7:30-9. Pacific.

KFBK, Sacramento, Calif. 283 meters. 100 watts. Kim-ball-Upton Co. Slogan, "Heart of California." Daily ex Sun, 6-6:45 pm, concert, news, codes. Wed, 8-9:30 pm, concert. Pacific.

KFBL, Everett, Wash. 224 meters. 10 watts. Lesse Bros. Daily ex Sun, 7:15-8:15 pm. Sun, 2-3 pm. Pacific.

KFBS, Trinidad, Colo. 360 meters. 15 watts. Chronicle News & Gas & Elec. Supply Co. Mon, 8-10 pm. Mountain.

KFBV, Laramie, Wyo. 283 meters. 50 watts. Bishop N. S. Thomas. Irregular schedule.

KFCB, Phoenix, Ariz. 278 meters. 78 watts. Nelson Radio Supply Co. Slogan, "When It's Wintertime in Michigan, It's Summertime Down Here." Daily, 7-7:30 pm, bedtime stories. Mountain.

KFCF, Walla Walla, Wash. 360 meters. 50 watts. Frank A. Moore. Mon, Fri, 8-9:30 pm. Pacific.

KFCM, Billings, Mont. 360 meters. 10 watts. Electric Service Station, Inc. Wed, Fri, Sun, 7:30-9 pm, music. Sun, 11 am-12:30 pm. Mountain.

KFCN, Richmond, Calif. 244 meters. 100 watts. Rich-mond Radio Shop. Slogan, "Out Where the West Ends." Daily ex Sun, 1-2 pm, music. Tues, Fri, 8-9 pm, music. Pacific.

KFCP, Ogden, Utah. 360 meters. 25 watts. Ralph W. Flyers.

KFCV, Houston, Tex. 360 meters. 10 watts. Fred Mahaffey, Jr. Daily ex Sun, 7:30-8 pm, mar-kets, entertainment. Sun, 2-3 pm, entertainment. Central.

KFCW, La Mars, Ia. 252 meters. 50 watts. Western Union College, Wed; 10-11 pm, music, educational. Central.

KFCZ, Omaha, Neb. 258 meters. 100 watts. Central H. S., Mon, Tues, Wed, Thurs, Fri, 3-4 pm. Mon, Tues, Thurs, 7-8 pm. Central.

KFDA, Baker, Ore. 360 meters. 5 watts. Adler's Music Store. Daily ex Sun, 5-6 pm, 7:30-8, music. Sun, 6-8 pm. Pacific.

KFDD, Boise, Idaho. 252 meters. 10 watts. St. Mich-ael's Cathedral. Sun, 11:15-12:30 pm, 7:30-9:15, church services. Mountain.

KFDH, Tucson, Ariz. 360 meters. 50 watts. Univ. of Ariz. Irregular schedule.

KFDJ, Corvallis, Ore. 360 meters. 50 watts. Oregon Agr. College. Mon, 8-9 pm, Thurs, 8-9 pm. Pacific.

KFDO, Bozeman, Mont. 248 meters. 40 watts. H. Everett Cutting. Mon, Wed, Sat, 8-9 pm. Mountain.

KFDR, York, Neb. 360 meters. 10 watts. Bullock's. Slogan, "The Little Station with the Big Kick."

KFFO, Hillsboro, Ore. 229 meters. Dr. E. H. Smith. Daily, 6-7 pm, music, sports, news. Fri, 9-10 pm, Chamber of Commerce Community Program. Pacific.

KFFQ, Colorado Springs, Colo. 360 meters. 100 watts. The Marksheffel Motor Co. and W. D. Pyle. Wed, 11-12 midnight. Mon, Fri, 8-9:30 pm, special program. Mountain.

KFFR, Sparks, Nev. 226 meters. 100 watts. Jim Kirk. Thurs, 7-8 pm. "Sagebrush Canaries." Pacific.

KFFV, Lamoni, Iowa. 380 meters. 100 watts. Grace-land College. Tues, 7 pm, music. Thursday, 7 pm, educational program. Sun, 6:30 pm, religious services. Central.

KFFX, Omaha, Neb. 275 meters. 100 watts. The Mc-Graw Co. Daily, 2:30-3:50 pm. Central.

KFFY, Alexandria, La. 270 meters. 100 watts. Pin-cus & Murphy, Inc.

KFFZ, Dallas, Tex. 360 meters. Al G. Barnes Amusement Co. (Portable Set). Moving soon to Los Angeles.

KFGC, Baton Rouge, La. 254 meters. 100 watts. Louisiana State University. Fri, 8-9 pm. Central.

KFGD, Chickasha, Okla. 248 meters. 200 watts. Okla. College for Women, Chickasha Radio & Elec. Co. Tues, Thurs, Sat, 8 pm, music, lectures. Wed, 10 am, chapel service; 11 pm, special jazz program. Central.

KFGH, Stanford Univ., Calif. 222 and 286 meters. 500 watts. Leland Stanford Junior University. No regular schedule.

KFGI, St. Louis, Mo. 266 meters. 250 watts. National Guards Missouri 138th Inf. Mon, 7:30-10:30 pm, Fri, 10:30 pm-1 am. Sun, 2-4 pm. Central.

KFGL, Arlington, Ore. 234 meters. 5 watts. Arling-ton Garage. Fri, 7:30-8:30 pm. Pacific.

KFGQ, Boone, Ia. 226 meters. 10 watts. Crazy Hardware Co.

KFGV, Ute, Neb. 224 meters. 10 watts. Eldbreder Radio Supply Co. No regular schedule.

KFGX, Orange, Tex. 250 meters. 500 watts. First Presbyterian Church. Sun, 11 am, 7:30 pm, church services. Central.

KFGZ, Berrien Springs, Mich. 268 meters. 500 watts. Emanuel Missionary College. Temporarily discon-tinued.

KFHA, Gunnison, Colo. 252 meters. 50 watts. West-ern State College of Colorado. "Where the Sun Shines Every Day." Daily ex Sun, 8:30 am, weather, markets. Tues, Fri, 7:30 pm, entertainment. Mountain.

KFHB, Hood River, Ore. 280 meters. 5 watts. A. S. Kohstad, Rialto Theater. "Where the Big Apples Grow." Mon, Wed, Fri, 6:30-7 pm, music. Special program 11 pm. Pacific.

KFHD, St. Joseph, Mo. 226 meters. 125 watts. Utz Electric Co. Daily ex Sun, 5:30-6 pm; Tues, Thurs, Sat, 8-9:30 pm, concert. Central.

KFHF, Shreveport, La. 266 meters. 150 watts. Central Christian Church. Sun, 10:55 am, 7:30 pm. Central.

KFHH, Neah Bay, Wash. 261 meters. 50 watts. Am-brose A. McCue. Tues, Thurs, 9-10 pm; Sat, 9-11 pm, dance. Pacific.

KFHJ, Santa Barbara, Calif. 360 meters. 100 watts. Fallon & Co. Wed, Thurs, Fri, Sat, 6-6:45 pm; Wed, Fri, 9-10 pm; Sun, 10 am, church services. Pacific.

KFHR, Seattle, Wash. 283 meters. 200 watts. Star Elec. & Radio Co. Mon, Tues, Wed, Thurs, 4:30, 5:30 pm, 6:30. Mon, Wed, Fri, 7:30 pm. Tues,

radio

Illustrated

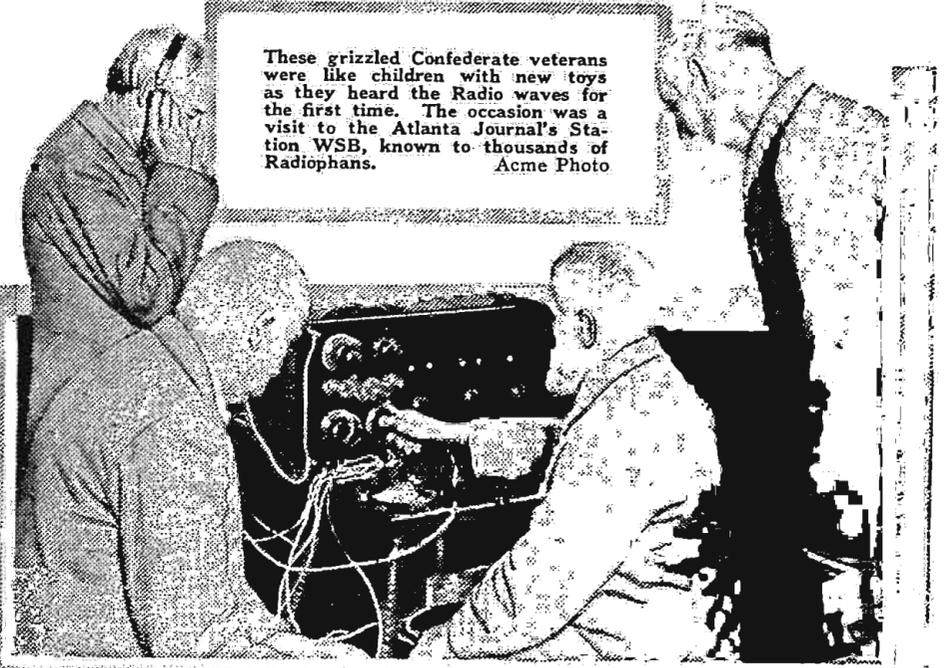

These grizzled Confederate veterans were like children with new toys as they heard the Radio waves for the first time. The occasion was a visit to the Atlanta Journal's Station WSB, known to thousands of Radiophans. Acme Photo



Below, a driver for the Rochester (N. Y.) Gas and Electric Corporation, receiving orders from headquarters on his Radio equipped wagon. This company is said to be the first to use this system.



Here and to the left above we present two pictures of two-year-old Jenna Josephine Brady, of Ada, Oklahoma,—or Jenna Joe as her fond parents call her. The two photos show her "before" and "after" tuning in, which she does herself. Photos by Stahl's Studio

