

Newest Super-Heterodyne Hook-Ups; 53 Stations' Programs for Week; Wave Trap Design; Article by Dr. De Forest; Trouble Shooting Sets

Radio Digest

EVERY WEEK **Illustrated** PROGRAMS **TEN CENTS**

REG. U. S. PAT. OFF. & DOM. OF CANADA

Vol. VIII

Copyright 1924
By Radio Digest Publishing Co.

SATURDAY, MARCH 15, 1924

No. 10

R.C.A. HOLDS UP TUBES?



LACK OF ONE TYPE CAUSES FIELD SURVEY

Dealers Claim Corporation Trying to Sell Dry Cell Tube Over-Production

Say Congress Should Quiz

CHICAGO.—Recent survey of the retail Radio business in Chicago, perhaps the largest distributing center in the world, showed, in answer to the bewildered plaints not only of dealers but of hundreds of thousands of listeners, a number of supposed causes for what was described as the greatest and most acute scarcity of tubes in the history of the industry.

Officials here of the Radio Corporation of America, which controls the sale of tubes made by the General Electric and

(Continued on page 2)

Bright Hope for Radio Telephony

WCAP Official Explains Why His Company Is in Field of Broadcasting

WASHINGTON, D. C.—The Chesapeake & Potomac Telephone Company, which operates Station WCAP in this city (and is a branch of the American Telephone & Telegraph Company), has expended in excess of \$60,000 on its broadcasting station. That is, this statement was made recently when officials of the company appeared before the Commissioners of the District of Columbia in connection with telephone rates.

"We are in it because we believe it is an undeveloped field of telephony, and that we should keep up in the art of Radio just as we do in the art of telephony. We are in it because we believe it is necessary. There may be a time, and I personally believe there will, when Radio telephony will be a regular adjunct of wire telephony."



Top, Jean Smalley, a smiling beauty of the sunny West, who has whistled herself into popularity with all Radiophans that have heard her. She appeared recently in a KFI evening program. Witzel Photo

"Dream Daddy" on Tour
BOSTON.—"Dream Daddy" from WDAR, Philadelphia, recently broadcast a special children's half hour of music and stories from Station WNAC, Shepley stores here. "Dream Daddy" is Harry E. Ehrhart, out of the studio and is the one about whom a popular song has been written. He is on a tour of stations.

NEWS LOUD MAKERS TO STREET

CHICAGO.—One man was painfully injured, three others were thrown to the ground and bruised and scores of loud speakers were thrown into the street recently when a small eating boiler exploded in the rear room of the workshop of Nathaniel Edwin, Inc., here, manufacturers of radio equipment.

Batavia, N. Y., Offers \$50 to Find Interference Cause

BUFFALO.—Here's a chance for the Antenna brothers! Radio fans in Batavia, N. Y., afflicted by interference lately, have offered a reward of \$50 to the person or persons discovering and eliminating the cause of the disturbance. It is greatest when the weather is damp or when there is a high wind. Some fans believe that a defective circuit of the street lighting system affects reception.

Station WDAR, Lit. Brothers, Philadelphia, gave its listeners in an agreeable surprise the other evening when Irene Bordoni (right), the comely comedienne, was featured by "The Morning Glory Club."

Left, Mrs. Ruth Bradley-Keiser, celebrated pianist. One of her late concerts was given from Washington State College's Station KFAE, Pullman, Wash.



DOCTOR TELLS HOW TO KEEP UP "PEP"

GIVES FIVE EXERCISES TO MAKE HEALTH

Expert Conducts Gym Class by Air; in Series of Talks from WMAQ

CHICAGO.—"Pep" can be kept up by a daily program of exercises and hygienic rules of living, according to Dr. E. A. Allen, physical work secretary of the Y. M. C. A. here, who is giving a series of talks from Station WMAQ, the Daily News.

- The following program of exercises will require eight or ten minutes, said Dr. Allen. "Rest about one minute between group exercises. Breathe deeply and regularly during the exercises. Do not hold your breath during any of the movements, and perform all exercises vigorously, but be sure you do them correctly, with the chest elevated, head and chin up. Five Exercises to Try: Group I. Rise on toes, swing arms side-wise upward. Large arm circles forward and backward. (Ten counts each.) Group II. Stand with feet apart, hands on hips. 1. Bend body forward, sideward, backward. 2. Twist body to left and right. (Twelve counts each.) Group III. Feet apart, hands on hips. 1. Trunk circumduction—that is, body circled left, then right. (Ten counts each.) Group IV. Lie down on floor. 1. Bend knees up close to chest. 2. Same as 1; also swing arms overhead. (Ten counts each.) Group V. Standing. 1. Jump on both feet (in place). 2. Run (in place), lifting knees high. (Twenty counts each.)"

VACUUM TUBES SCARCE

(Continued from page 1) the Westinghouse companies, which tubes are practically sold out in the market, said that the only reason for the shortage was "inability to meet the demand." But many retailers and other dealers contended that the corporation had willfully curtailed production so as to create artificial scarcity of one kind of tubes which would force the purchase of another kind.

Urges Congressional Investigation So embittered were a number of dealers, supposedly representative of the opinion of most of them here, that they urged immediate investigation by Congress or by the Federal Trade Commission. The chief examiner of the latter body, in indirect answer to telegraphic inquiry, reported that "while charges have been made at one time that the Radio Corporation of America had tried to curtail the production of tubes, the commission had found evidence to that effect; no comments had reached the commission recently. . . . It knew nothing about the scarcity of tubes."

Little if any encouragement was given listeners as to when they would be enabled again to buy 201A tubes, made by the Radio Corporation of America. Officials in Chicago of the corporation reluctantly and, in one instance angrily, said in answer to questions as to the cause of the lack of tubes—"The only reason is that the Radio Corporation of America has been, is and will continue to be perhaps during the next 90 days unable to supply the extraordinary demand caused in large part by the sale of five-tube sets."

Says R.C.A. Unwinding Dry Cell Tubes Explanations of the R.C.A. were refuted by an executive of one of the largest manufacturers of sets. "The facts as to the scarcity of tubes are that the R.C.A. is or until recently was overstocked in relation to dry cell tubes and, to relieve the situation, withheld the manufacture of 201A and storage battery tubes which course would force the purchase of dry cell tubes," said he.

"There seems to be no foundation for the contention of the R.C.A. that the sale of neutrodyne and super-heterodyne sets had so increased the demand for tubes as to create the scarcity. We are in a position to know that the sale of super-heterodyne sets is very small and that the average daily sale of neutrodyne sets is 600, thus requiring about 3,000 tubes daily. The R.C.A., rather the General Electric and Westinghouse, are equipped to manufacture and do manufacture many more tubes every day."

UV-199 White Elephant for R.C.A. The owner of one of the largest Radio mail order firms in the United States, that is, in the world, declared that it seems to be the consensus of dealers that the R.C.A. was lowering the production especially of 201A tubes because of an excess supply of UV-199s. "The R.C.A.," he said, "is evidently trying to clear the field for the sale of tubes for a new circuit or set which it controls."

Investigators who tried to learn the cause of the shortage of tubes were hindered greatly by wholesalers or jobbers and retailers. There seemed to be a fear of "talking too much." Tubes in R.C.A. Warehouse Efforts to communicate by phone with the warehouse of the Radio Corporation of America were blocked by persistent

queries as to the identity and intent of the surveymen. Hasty inspection of the storerooms of the concern showed a supply of what were supposed to be tubes which supply occupied about one-half of the available floor space. "We receive a small supply every week," said an employe. But he didn't know why he didn't receive enough to fill back and current orders. Inquiries in the plant of the Westinghouse company, about two blocks away, resulted in the declaration that no Westinghouse Radio tubes were stored there nor elsewhere in Chicago. Dealers Denounce Scarcity as Untruth Attempts to question dealers in or makers of "independent" or "bootleg" tubes were frustrated usually by fear of lawsuit alleging infringement of patent or praying for injunction. "I know several 'bootleg' firms in Chicago," said the head of a large wholesale Radio supply house, "but I won't tell you they are."

One of the R.C.A. distributors here, perhaps one of the largest in the United States, reported that the demand for tubes was so insistent a number of dealers had secretly surveyed his stock in warehouse and had afterward angrily denounced as an untruth his plea of "scarcity."

G. E. and Westinghouse Have Large Facilities

What seemed to puzzle not only dealers but listeners in as well, was the fact that the General Electric and the Westinghouse companies should be in a position to produce a sufficient supply of one or more kinds of tubes, yet be unable to make an adequate quantity of another kind. According to the recent reports of what are considered expert business surveymen of the plant of the General Electric in Kearney, N. J., was enlarged not long ago to increase the volume of production. Like measures were adopted, it was said, in relation to the company's plant in Warren, O. The statisticians reported that the

sales of the Radio Corporation of America were 60 percent General Electric tubes and 40 percent Westinghouse. "Seems peculiar," said an influential jobber here, "that such an efficient concern as the General Electric, working with the Radio Corporation of America, could not see far enough ahead, could not expand its production enough to supply the increased demand."

Same "Hold Up" as Last Year

The Radio Corporation of America, according to the reports of the United States department of commerce, sold in 1922 more than \$11,000,000 worth of its goods; in 1921 its sales aggregated more than \$14,000,000; in 1923 the gross earnings were \$23,000,000, of which almost \$5,000,000 were net. These statistics were cited as "evidence" that the growth of the Radio business had compelled the R.C.A., rather the General Electric and the Westinghouse, to expand proportionately and that the plea of mechanical inability to meet the demand did not suffice.

Dealers reported that the present tube situation resembled that of last year when, they said, the production or distribution of OV-1 and C-1 tubes was "held up" for 201A and 801A tubes.

Scarcity Entirely Up to R.C.A.

Illustrative of the dearth of tubes in Chicago especially were the reports of two of the largest mail order houses in the world that they "were out of 'em," of the largest department store that "it had none," and of a small retailer that "I sell 200 tubes a day but I receive sometimes only 50 a week." The assistant buyer of one of the mail order firms said that he had asked R.C.A. distributors why tubes were scarce but had been told—nothing. And that's about all the listeners in or buyers of tubes know about the situation—nothing. Whether or not they will be able to obtain tubes within the next 60 days depends, it is said, on the Radio Corporation of America.

CONTENTS

Radio Digest, Illustrated, Volume VIII, Number 10, published Chicago, Illinois, March 15, 1924. Published weekly by Radio Digest Publishing Company, 128 West Madison Street, Chicago, Illinois. Subscription rates, yearly, Five Dollars; Foreign (outside the Dollar countries), single copies, Ten Cents. Entered as second-class matter at the postoffice at Chicago, Illinois, under the Act of March 3, 1879.

"All the Live News of Radio".....1 to 8 Before They Thought of "Mikes"..... 5 Operating and Trouble Shooting for Owners of Standard Receivers..... 9, 10 Musical Education by Radiophone Broadcasting, by Dr. Lee De Forest..... 11 Green Circuit Variocoupler: The Reader's View..... 12 An Evening at Home with the Listener In..... 14 Advance Programs for the Current Week..... 15 to 18 First Aid and Helpful Hints for Listeners In..... 19 Operating and Construction Suggestions, by Peter J. M. Clute..... 19 Editorials; Indi-Gest; Condensed, by Dielocrite..... 20 Meditations by the Inventor of King Miloplex, Part XXVIII, by the Mystery Man..... 21 Simple Explanation of Radio for Everybody, Chapter XII, Part III—Radio Frequency Amplification..... 23 The Latest in Super-Heterodyne Hook-Ups, Part I—Circuit Diagrams, by H. J. Marx..... 25 How to Use an Electrolytic Rectifier..... 27 Simple One-Tube Circuit, R.D.-116..... 28 Questions and Answers..... 29 Radiophone Broadcasting Station Directory—Part II..... 31 Radio Illustrated, a Page of Pictures..... 32

Looking Ahead

"Thirty-Minute A-B-C Lessons for Radio Beginners" Starts Next Week—P. E. Edelman's series of beginners' lessons is the easiest reading a beginner can find. Every article is self-explanatory and so simple a child can understand. Not an idle boast! Read Part I—"A Radio Night's Entertainment," next issue.

Neutrodyne Receivers in General will be the next subject of M. W. Thompson in his "Radio for Everybody" series. Neutrodyne fans can hardly afford to miss this. Is your neutrodyne set letter perfect? Perhaps Mr. Thompson's article will put your troubles to an end.

Super-Heterodynes Are Popular Nowadays, so H. J. Marx will tell you more about the circuits "with the long names." Part II of his series, "The Latest in Super-Heterodyne Hook-Ups," will be devoted to an explanation of the action taking place, and will include data on some French developments.

The Mystery Man's Wave Traps Bid Fair to Rival His Miloplex Circuits—Both are mighty good and effective. Something new about wave traps every week. Read his coming article.

Trouble Shooting Your Receiving Set will be discussed by Peter J. M. Clute next issue, as well as in the regular department on this subject as applied to standard manufactured sets.

Something New in Portable Sets—as used when touring by a reader who is also a motor car fan—is another surprise. Three tubes are used with a single circuit tuner. The rest will be told next issue.

Taking the Hum out of the Green Circuit is Myron P. Green's next contribution.

Advance Programs for Every Big Broadcaster—every week in advance so you can use them. Fifty-three stations having 500 watts or more of power, are represented in this issue. Convenient? Tell your friends.

Newsstands Don't Always Have One Left WHEN YOU WANT

Radio Digest

YOU WANT IT! BE SURE OF YOUR WEEKLY COPY BY SUBSCRIBING NOW

SEND IN THE BLANK TODAY

Publisher Radio Digest, 128 West Madison St., Chicago, Illinois. Please send enclosed check W. O. for Five Dollars for the Year's Subscription to Radio Digest, Illustrated. Name..... Address..... City..... State.....

Ask Your Dealer for Kellogg Radio Parts

Transformers Built and designed correctly, delivering maximum amplitude with minimum distortion. Connections clearly marked. Properly designed brass shield permits close mounting. No. 501 Ratio 4 1/2 to 1..... \$4.50 No. 502 Ratio 3 to 1..... 4.50

Variocouplers Furnishes efficient coupling. No sliding contacts. Bakelite shells. High induction, low distributed capacity. No. 501 Variocoupler..... \$9.00 No. 502 Tuner Coil..... 3.00

Variable Condensers Decrementer type, 11, 23 and 43 plate with and without 3 plate vernier. Arranged for panel mounting. No. 505 Variable Condenser with Vernier..... \$8.75

Head Sets Extremely sensitive. Small in size. Easily adjusted. Thoroughly efficient. No. 69A Head Set, 2400 ohms..... \$10.00 No. 74A Head Set, 1000 ohms..... 5.00

KELOGG SWITCHBOARD & SUPPLY COMPANY 1066 W. Adams St. CHICAGO, ILL.

THORDARSON

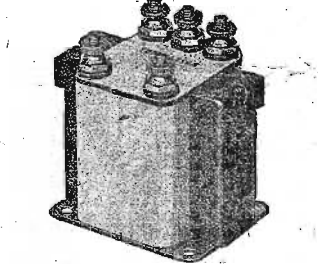

POWER AMPLIFYING TRANSFORMERS Price per pair, \$13.00

The new Thordarson Power Amplifying Transformers (push pull) are designed for use as third stage audio frequency amplifiers, to provide high power amplification for operating loud speaking devices.

With power amplification, not only is it possible to increase volume, but, since two tubes replace the usual one, the distortion and howling which usually accompany the overloading of a single tube on the third stage is done away with entirely.

The Thordarson Power Amplifying Transformers are well constructed electrically and are capable of nately carrying an additional without breaking down.

In tonal purity these transformers equal the Thordarson Super Frequency transformer whose quality and even amplification has made it the popular transformer of the day.

THORDARSON ELECT. MFG. CO. 500 W. Huron St. CHICAGO

SIFT SCHEMES FOR BROADCAST FUND

CONFLICT OF INTERESTS REVEALED BY INQUIRY

American Radio Corporation Investigation with Eye to Square Deal for Public

NEW YORK.—Indications are apparent of an open race for public contribution of funds to finance the payment of artists appearing at the leading broadcasting stations of the country, according to an announcement made today by the executive committee of the newly organized American Radio Association, whose headquarters are at 50 Union Square, New York city.

This committee includes Professor J. H. Morecroft of Columbia University; E. L. Bragdon, M. W. Thompson and A. H. Lynch.

"Just what method to be adopted and just what appeal will result in the greatest good to the greatest number of Radio listeners," says the statement, "is yet to be determined, and in the meantime, for the safeguarding of public interest, our association has undertaken an inquiry into the various plans now under consideration which will best serve the public interest.

Public May Contribute, But—

"Perhaps no other question affecting the public interest is being considered by the industry at large with a greater study than the question 'Who is to pay for broadcasting?'"

"There is a very strong feeling on the part of the amateur and the Radio public in general that the expense of broadcasting programs and the payment of leading artists in the professional field should be borne by those companies manufacturing or otherwise profiting by the sale of Radio apparatus. At the same time it can be safely said that a large proportion of the public stands ready to make contributions to a general fund which will in return give them still greater benefits as listeners in. The three plans now being most generally discussed are as follows:

Three Plans Proposed

1. That a fund be subscribed by the industry for the support of musical, artistic and educational programs.

2. That a fund be subscribed by public contributions.

3. That a low tax be placed upon the manufacture and sale of Radio apparatus to be applied to a broadcasting fund.

"The Executive Committee of the A. R. A. is of the opinion that the public are the ones to whom all plans should be submitted for a choice, although it is by no means certain that the expense problem will be solved entirely by any one or all of the foregoing proposals.

Keep Fund Away from "Broadcast Trust"

"It should not be forgotten that although some of our leading broadcasting stations are sponsored and their expense borne by such companies as the American Telephone & Telegraph Co., Radio Corporation of America, General Electric and the Westinghouse Companies, nevertheless the majority of the important broadcasting stations are conducted by commercial enterprises and some of the leading newspapers of the country."

The formation of the Radio Music Fund committee utilizing Station WEAFF brings up the question as to what station or system of stations will be employed by any one committee appealing for public funds and how the distribution of this fund will affect the already established broadcasting stations. Can such a single fund be created that will solve the problem of the various conflicting interests in the industry on one hand and the public on the other?

The question is also asked: Is it advisable to give the support to any single group which has in mind the creation of a broadcasting trust to the exclusion and possible detriment of any smaller stations now in the field?

BISHOP DIES WHILE 'HIS' SONG IS SUNG

DALLAS, TEX.—At the time the news of the unexpected death of Bishop Alexander C. Garret, of the Episcopal Diocese here, was communicated to the studio of Station WFAA, thirty members of Dallas Male Choir were before the microphone singing "The Bells of St. Mary." This was an impressive coincidence, as much of the life of the deceased was devoted to the founding of St. Mary's College here.

RADIO WAKES BIRD SONGLESS FOR YEARS

VANCOUVER, WASH.—Restoring the lost voice of a canary that has been dumb for several years can be credited to Radio, according to Mrs. George La Londe, of this city. The canary stopped singing five years ago, but was familiar with music then in vogue. When nearby stations commenced broadcasting old-time favorites recently, Mrs. La Londe turned on the loud speaker. The bird burst into song.

RIVALRY SINGING CHARMS MARY



Mary Garden—Chicago's "Our Mary"—the famous diva, is quite a Radiophan. Not only is she on familiar terms with "Mike," but she enjoys listening in too. Here she is shown hearing her sister stars of the Chicago Civic Opera—Mary Fabian, Irene Pavluska and Florence Macbeth—broadcasting from WJAZ, and there is nothing but pure rapture in her expression, rivaled of hers though the singers in a sense may be. © U. & U.

Prescription Given Sailor
PORT ARTHUR, TEXAS.—Answering a call from the American steamship Scottsburg, coming from a point in Pacific Ocean, 1,000 miles west of Panama, Dr. D. Davidson, local physician, prescribed

for a seaman, G. O. Donald, by Radio. Local stations picked up a call from the steamship, giving the seaman's symptoms and Dr. Davidson was communicated with and gave a prescription which was immediately broadcast.

ASKS CONGRESS TO SWAMP MUSIC BAN

NEW BILL SEEKS FREE USE OF MATERIAL

Publishers' Society Squirms to Keep Grasp on Rule Set Up Years Ago

WASHINGTON, D. C.—Radical revision of the copyright laws that were drafted before the broadcasting stations came into use, is the goal sought by Representative Walter H. Newton, of Minnesota. He has introduced a bill in Congress that will permit the free use of copyrighted music by the movies, theaters, hotels and Radio stations.

The measure is practically the same as that introduced on June 21, 1921, by Representative Lampert and an effort will be made to secure early consideration of the bill by the committee on patents. It is likely the bill will come up for action by the House this session. An attempt is being made by The American Society of Composers, Authors and Publishers to apply the law that was passed years before the advent of the broadcasting station, to cover the playing of music that is copyrighted by their members.

Public Performances Boost Music Sales

That such methods are wrong, is alleged by the new bill introduced by Representative Newton, who believes the playing of copyrighted music for movies, theaters, hotels and Radio stations, is for the benefit of the public and without remuneration to the players. He holds that such public performances popularize the music and increase its sale to the public and he believes that the popularizing medium should not be required to make payment to the music publishers.

Representative Newton also complains that certain publishers, acting through secret representatives posing as patrons, have induced movies, theaters, hotels and Radio stations to play certain copyrighted music, and then have demanded payment of a license fee because of such "unauthorized" rendition.

Coal Miner Chiefs Sift Wage Issue Over WEAFF

Debate in New York Like That as to Dry Law

NEW YORK.—A feature of a recent program by Station WEAFF here was "Resolved, that the coal miners shall receive more wages," with Ellis Searles, editor of the United Mine Workers Journal of America on the negative side of the question and Byron R. Newton, formerly assistant secretary of the treasury, now legal advisor to the mine operators, on the affirmative.

The debate was held under the auspices of the Government club, Mrs. George E. Owens presided. She was chairman of the Wheeler-Gillette debate last spring on "Shall the prohibition act be repealed?" which elicited thousands of votes from the Radio audience.

HOSPITAL PATIENTS NEED LOUD SPEAKER

Lack of Equipment Prevents 255 Tuberculars from Listening In

CHICAGO.—Lack of a loud speaker is all that prevents 255 tubercular patients at the Cook County hospital here from listening in on Radio programs. John Johnson, 58 years old, a patient, told of the crying need of the Radiophans.

"If someone would only give us a loud speaker we would be just fine," said Johnson. "We have an outfit but no loud speaker, and the only way the boys get the program is in pieces. First one man will listen in, then the phones are passed onto the next fellow. In this way we lose part of the program and but a few of us have the chance to listen in."

THE ANTENNA BROTHERS Spir L. and Lew P. No. 2—The Hook-Up Must Be Good!



DOES AURORA BALK RADIO RECEPTION?

AERIAL LEAGUE HANGS UP PRIZES FOR DATA

Contest, Ending April 15, Seeks Facts as to Interference from Northern Lights

NEW YORK.—That the aurora borealis or northern lights are the cause of much of the interference, instability, static and varying results experienced with Radio receivers is the belief of the Aerial League of America, which in an attempt to solve the question and find means of nullifying these interferences, offers prizes to Radio listeners everywhere for reports.

The first monthly contest (for reports received between January 15 and February 15) was won by Professor Adair of Amherst College for data he had collected and studied. His report was an excellent specimen of scientific work, it was said here recently.

Second Contest Ends April 15

The second contest which will run April 15 is called "a preliminary aurora check-up." From data compiled by Admiral Peary, Captain Amundsen, Professor Todd and scores of other scientists, it is plain that anyone with a receiving set may register the aurora—therefore every one interested in Radio may participate.

Application for rules and information regarding both of the contests now running, the world Radio checkup and the aurora checkup, should be addressed to the Aerial League of America, 230 Madison avenue, New York city.

The aurora problem and its solution are explained by Henry Woodhouse, president of the league, as follows:

"Were it possible for Radio fans to view the whole earth when the receiver registers the clicks and rattlings of "static" and "atmospherics" they would probably find that polar lights are flashing their dazzling streamers from points ranging from 60 to 100 miles above the north and south polar regions, probably elsewhere, and extending skyward several hundred miles.

BRILLIANT "EXPO" HOLDS ON COAST

Crystal Settings Flash Bright Under Lights at Los Angeles Radio Show

LOS ANGELES.—Suffused in the jewel-like setting of crystal chandeliers with floodlights of color-shafts thrown on the exhibits, the showroom and foyer of the Biltmore Hotel here recently presented a scene of dazzling splendor on the occasion of the second annual Radio and Electrical Exposition.

Special days were named during the exposition. Opening with Los Angeles Day, others were, San Joaquin Valley, Long Beach Night, Northern California Day, Southern California Counties Day, and closing with Motion Picture Day. Speakers included city officials, men of national prominence and leading authorities in the Radio and electrical world.

In the evenings, Station KFI, Anthony's entertained at the exposition by having well-known artists of the musical and silver-sheet world broadcast in person from the exposition.

KFI, in its booth, kept open house in the afternoons and evenings, during which the public and listeners in were welcomed by "Uncle John" the voice of KFI and other artists who have entertained from The Times.

Man Born Deaf Listens to Guitar Played Miles Away

BIRMINGHAM, ALA.—The story of how Roy Clark, a young man of Dallas village, near Huntsville, Ala., born deaf and dumb, has heard for the first time by means of Radio, has been reported here. Mr. Clark attended a Radio party one night recently and was invited to put on the headset. He did so with a great deal of hesitancy.

Immediately, he made signs that he was hearing. He seemed to be amazed and the company did not realize for a moment what a strange thing was happening, until some one remarked that Clark had been deaf and dumb all of his life. Clark told in sign language that he was hearing a violin play, but it proved to be a guitar several hundred miles away.

Bahama Islands Listens in to WJAX, Cleveland

CLEVELAND.—Station WJAX, the Union Trust Company here, under the direction of James M. Thorburn, Radio engineer in charge of operation, has been stepping out a considerable distance during winter evenings. The Cleveland News concert recently was heard in Nassau, Bahama Islands. Two letters have been received verifying the record.

RADIO COMPELS DRY CELL TESTS

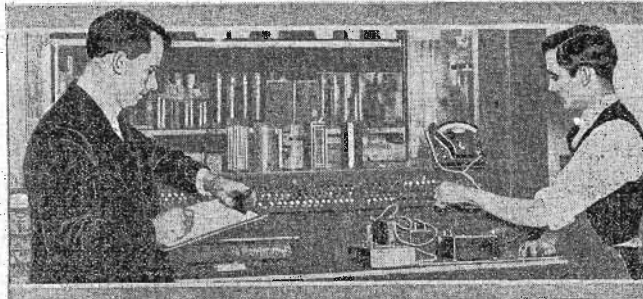

Radiophans when buying dry cells want to know for sure their voltage yield and approximate life. Therefore, the Bureau of Standards submits all American-made cells to rigid tests before they are pronounced fit to be put on the market. Photo shows J. P. Schrader, left, and A. F. Baillie making tests in the "constant temperature room."

Banjo Sheik on WEA F

NEW YORK.—Brooke Johns, Broadway's "banjo sheik," one of the most popular artists who has broadcast programs through WEA F, two years ago came to Broadway from Washington. He was then unknown. He has his own orchestra, he composes music and lyrics; he sings for the records and acts in the "movies." Listen in to Brooke Johns.

Show Crystal Sets for Prizes

CHICAGO.—Owners of home-made crystal sets resident of Roseland, Pullman, West Pullman, Burnside, Gano, Morgan Park and Beverly Hills, south side suburbs of this city, will display their handiwork in competition for prizes at a Radio show to be conducted by the South Park commissioners in the park hall at Palmer Park, March 17 to 20.

Columbia, WEA F Teach Governance

Station in New York, Owned by A. T. and T., and "U" Join to Instruct Public

NEW YORK.—The recent course of lectures as to the poetry of Robert Browning which were broadcast by Station WEA F under the auspices of Columbia University by Professor Fairchild has proved, it was said here recently, that serious educational work can find a real place on Radio programs.

The number of persons who subscribe to the Browning course encourage WEA F to present a series of lectures as to "Practical American Politics," by Schuyler C. Wallace of Columbia university.

Politics Taught by Radio

The listener will be introduced to major problems of government, political organization and public policy. Attention will be given to analysis of public opinion, to the functioning of political parties and the choice of a president. Investigation will be made into the framing of a constitution, the growth of national power, legislative control of cities versus home rule, constitutional devices to check tyranny, and the questions of proportional representation, committee system and leadership in legislative bodies.

The lectures will be given every Wednesday evening from Station WEA F at 8 o'clock. There will be 10 lectures in the series, each lecture to last 20 minutes.

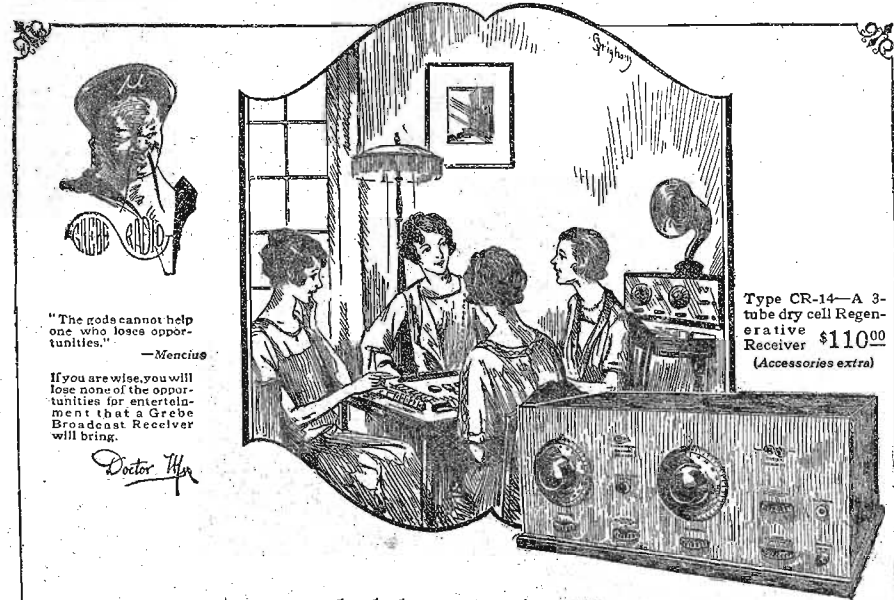

"The gods cannot help one who loses opportunities."
—Mencius

If you are wise, you will lose none of the opportunities for entertainment that a Grebe Broadcast Receiver will bring.

Doctor Hye

Type CR-14—A 3-tube dry cell Regenerative Receiver \$110.00 (Accessories extra)

The Dependable Radio Instrument

WHEN friends drop in for a visit you can count upon radio concerts when you own a dependable

GREBE Broadcast Receiver

Built in two efficient types, each an easily operated Instrument in a beautiful walnut cabinet that has compartments for all necessary dry batteries. Every detail of craftsmanship adds charm and grace to your living room.

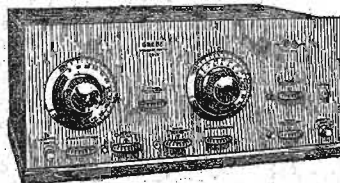

Type CR-12—4 tubes. Combines Regeneration and Tuned R. F. \$175.00 (Accessories extra)

Ask your dealer to demonstrate.

A. H. GREBE & CO., Inc. RICHMOND HILL, N. Y.

WESTERN BRANCH: 451 East 3rd St., Los Angeles, Calif.

Licensed under Arms/long U. S. Pat. No. 1,113,149

BEFORE THEY THOUGHT OF "MIKES"

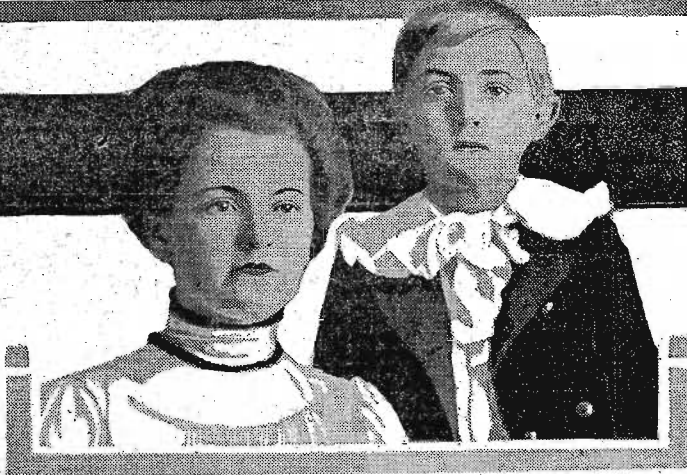

"Before They Thought of 'Mikes'" is glad to announce that it will be a regular feature, making its debut this week. But who are they? They are famous voices every listener in would recognize, once tuned in, but the pictures were taken more or less years ago before their voices resounded from Alaska to Florida and Southern California to Russia. Next week we'll give you their pictures as they appear today, and we'll tell you, if you don't guess first, just who they are. Here are a few hints: The baby at the left is a girl, and therefore grew up to be a lady announcer—and now is program

director of a station having 500 watts in its antenna. But what does 500 watts mean? Well, there are but fifty or so stations boasting that power, and very few of them have lady program directors. Now guess who she is—if you can. At the right we have the justly proud mother of the young gentleman to the right. His name is Paul and he helps the lady program director as chief announcer of the same station. He doesn't wear the same kind of collar nowadays, but he still resembles his youthful picture. Know him? You will next week.

DELAY LOOMS AS WHITE BILL PERIL

FAILURE OF PASSAGE IS AGAIN INDICATED
 Sponsor of Issue, However, Is Hopeful of Prompt Consideration of His Proposals

WASHINGTON.—The new White Radio Bill has been approved in its major features by the Department of Commerce, the Navy Communications Service and the Signal Corps, as well as most of the commercial interests, and has just been introduced in the House. Congressman White, of Maine, reports "hopeful" progress.

The delay, unavoidable as it may have been, is considered unfortunate by some Radio enthusiasts and interests. Last week, Senator McNary of Oregon, reintroduced the old bill which failed to pass the Senate last year. Evidently he and Congressman White had not gotten together, and as a consequence two Radio bills will soon be under consideration, although the White Bill, if it passes the House, may later be substituted for the McNary Bill now referred to the Senate Commerce Committee.

Operator's Licenses Will Be Required
 Generally, the White Bill, a modification of the 1923 bill, still carries the anti-alien ownership and the anti-trust provisions. It provides for the licensing at specified fees of all transmission stations and operators by the Secretary of Commerce. No mention of receiving stations is made. Details prescribing penalties for infractions of rules, such as operating without licenses, were not worked out at the last report, but it is expected the revocation of licenses and seizure of equipment, as well as fines, will be provided.

Abandonment of the requirement for operator's licenses, suggested by some, was understood not to have

met with the approval of Mr. White, who is said to favor, as in his previous bill, standard operator's requirements and licenses as a means of aiding their control by the Department of Commerce. This also has the approval of both commercial and amateur operators, as well as most commercial companies.

May Not Be Enacted
 Indications now are that the Radio bill will not be enacted into law. There has been too much delay in having the bill introduced.

At the present time Congress is so taken up with investigations that it seemingly has no time for constructive legislation. It is believed, by those in a position to know, that it would be practically impossible to get any legislation of this kind through Congress before the proposed adjournment in June.

School Day Friendship Is Awakened by Radio

Detroit Woman Hears Concert of Her Girlhood Chum

DETROIT.—A friendship started during high school days was renewed recently when Mrs. Frank Smith, sitting in her home in Cleveland, heard Juanita Lorgion Berry announced as a soloist on a Free Press Radio program. A letter in care of Station WCX brought word of the pleasure that the announcement had brought.

Mrs. Smith was Miss Ruth Habercorn, of Detroit. She was a schoolmate of Mrs. Berry. In the years that followed the friendship was allowed to lag.

Mrs. Berry is a violinist of much ability and last week was one of the members of the Detroit Tuesday Musicals on a WCX program. Mrs. Smith was reading while her husband was operating the Radio set and was surprised by the announcement of the name of her old friend. The letter followed and both young women are now praising Radio for the happy reunion.

Paris-Orient Link Forged
 PARIS.—The new Radio circuit between here and Saigon was formally opened recently. The station at Saigon is now the

most powerful Radio unit in the Orient, and its opening to general communication marks the completion of another link in the French colonial communication system.

Electrasote Radio Panels Are 25 to 50% Lower Priced

Yet Electrasote is a quality material, in every respect equal to or better than other high-grade radio-panelling. It is the very latest addition to the famous "sote" products which have made

The Pantasote Company, Inc.

internationally famous.

The laboratory tests of experts and the practical installations of users have proved that Electrasote has an exceedingly low phase difference and a high surface and volume resistivity. Its complete absence of abrasive means, besides, that it is easy to work with, cuts clean, and won't dull tools.

Beautifully finished with a high piano polish on one side and a fine satin-grain on the other, Electrasote can be used either way. Every panel is individually packed in a separate envelope.



Electrasote is now on sale at good radio dealers almost everywhere. Certain desirable territory, however, is still open and offers a most attractive proposition to jobbers and dealers. Write to us for complete information.

M. M. FLERON & SON, Inc. Trenton, N. J.

Exclusive Sales Agents for Electrasote Radio Panels

There's a Radiola

for every purse

New and Remarkable
Radio Achievements
in the new Radiolas

Radiola III, an improved two tube receiver of antenna type, sensitive and selective. Complete with two WD-11 Radiotrons and headphones (everything except batteries and antenna) . . . \$35

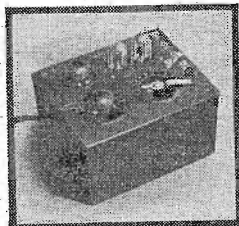

Radiola III Amplifier
Two tube balanced amplifier for Radiola III, including two Radiotrons WD-11 . . . \$30

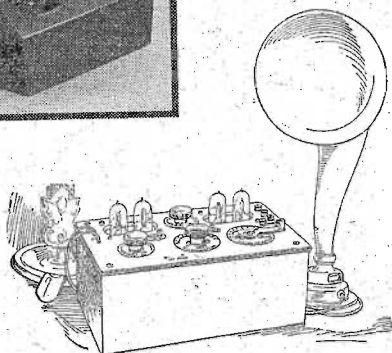
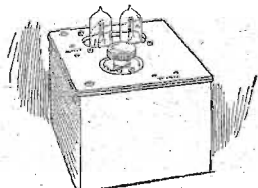

(above)

Radiola III-A, which is Radiola III and its balanced amplifier complete in one cabinet, including four WD-11 Radiotrons, headphones, and Radiola Loudspeaker. Everything except antenna and batteries . . . \$100

Same as above, but without Radiola Loudspeaker . . . \$65

\$35	\$206
65	220
100	245
150	286

\$425

This symbol of quality



is your protection

It is impossible to give here full description of these remarkable new sets. Send this coupon for an illustrated booklet that tells the story completely, with detailed description of every set. Then see the dealer nearest you.

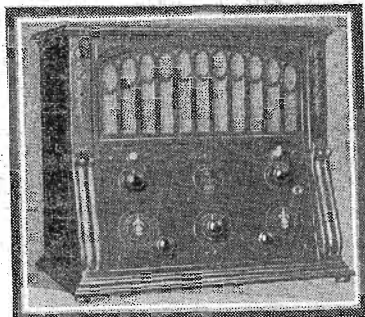

(above)

Radiola X—ultra refined receiver of the antenna type, selective and non-radiating. Remarkable for distance reception and perfect reproduction. Built-in new type loudspeaker. Complete with four WD-11 Radiotrons—everything except batteries and antenna. . . . \$245

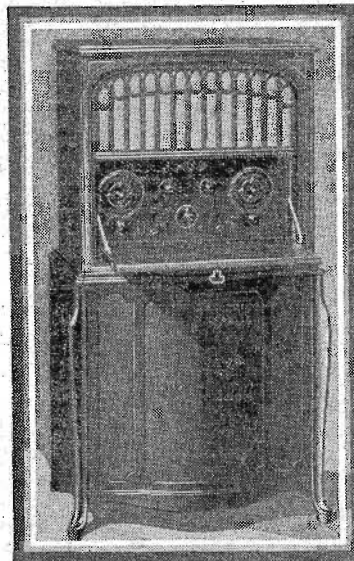

Radiola Super-VIII—an improved Super Heterodyne. Selective and non-radiating. With no antenna, and no ground connection, it receives far distant stations, even while local ones are operating. Loudspeaker built in. Complete with six UV-199 Radiotrons—everything except batteries . . . \$425

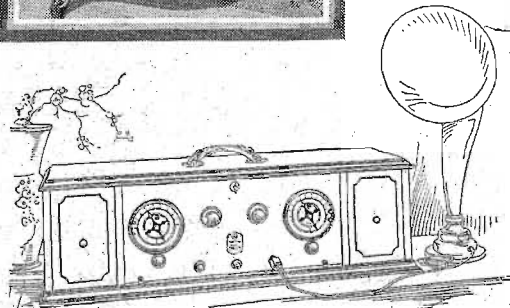

(above)

Radiola Super-Heterodyne (second harmonic) same as Super-VIII but semi-portable in mahogany finished cabinet with separate Radiola Loudspeaker. With six UV-199 Radiotrons, but without batteries, \$286
Same as above, but without Radiotrons or Loudspeaker . . . \$220

(below)

Radiola Regovoltex, a modified Radiola X, in mahogany cabinet, with external loudspeaker. With four WD-11 Radiotrons and Radiola Loudspeaker, but less batteries and antenna . . . \$205
Same as above, but without Radiotrons and Loudspeaker . . . \$150

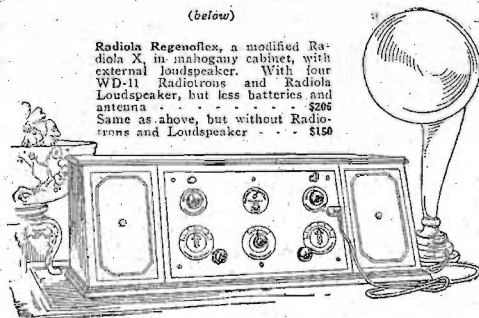

Radio Corporation of America

Sales Offices

233 Broadway, New York, 10 So. La Salle St., Chicago, Ill., 433 California St., San Francisco, Cal.

Radiola

REG. U. S. PAT. OFF.

RADIO CORPORATION OF AMERICA
Dept. 313. (Address office nearest you.)
Please send me your new free Radio Booklet.

Name _____
Street Address _____
City _____
State _____
R. F. D. _____

PLAYWRIGHTS THINK RADIO HURTS THEM

DRAMATIST BODY PASSES RESOLUTION OPPOSING

But Producers Are Sold on Broadcasts—Cite Hopkins, Hammerstein and Shuberts Success

NEW YORK.—Undeterred by the losing fight of the Society of Composers, Authors and Publishers against the desire of the American public to have good popular music via Radio, the American Dramatists have gone on record as being opposed to the broadcasting of plays. Not only does this society oppose it but adopts a resolution "refusing absolutely to allow any of the plays written by its members to be sent over the Radio without compensation to the author."

Passing resolutions is one thing; forcing members and the Producing Managers Association to abide by them, is another. Plenty of reason exists to doubt whether a playwright or any organization made up of dramatists can prevent a manager from lecturing one of the broadcasting stations put a microphone in front of the stage during a performance.

Authors May Evade Ruling

Since it would be a simple matter for the manager to purchase the author of the play that broadcasting materially increases the box office receipts and, therefore, the playwright's percentage, is an interesting question also whether authors will abide by the decision.

The text of the resolution leaves no room for doubt as to the attitude of the playwrights concerning the question of Radio presentation of their plays. The resolution in part follows:

"Resolved: That henceforth the American Dramatists will not permit the broadcasting of the plays of any member without the written consent of the member to the broadcasting station:

"That it is essential to the best interests of the members of the American Dramatists that their plays be not broadcast without their written consent, since in the estimation of the American Dramatists broadcasting is injurious to the production value of a play and tends to lessen the desire of the public to attend the regular performance."

Fenny Wise and Pound Foolish?

So it seems the playwright would rather receive a few dollars direct from the station than have his box office percentage increased by the thousands of dollars which would result if the production were put on the air.

In defining the attitude of the playwrights, Edward Childs Carpenter, president of the Society of American Dramatists said:

"I have been asked," said Mr. Carpenter, "the attitude of the American Dramatists concerning the broadcasting of plays. One of the great elements that enter into the enjoyment of a given play is that of surprise, or newness. Once a playgoer knows all there is to know, what would induce him to go to a theater and see it?"

Producers Favor Use of Radio

But contrary evidence is interesting—Would Arthur Hopkins, producer of "The Old Soak," have permitted the broadcasting of "The Laughing Lady" if the previous broadcasting of "The Old Soak" had not helped his box office returns? Hardly. Mr. Hopkins is a shrewd business man and a gifted producer.

Arthur Hammerstein's office exists to make money. "Wildflower" was put on the air and the effect on the number of people passing through the doors was most marked. "Mary Jane McKane," another Hammerstein show, was therefore put on the air recently and the same favorable reaction was noted.

Radiophans would never have enjoyed "The Passing Show" if the Shuberts had not found Radio an excellent means of drawing people to their doors. "Caroline," "Dew Drop Inn," "Sally, Irene & Mary" and "The Dancing Girl" are Shubert shows previously put on the air.

WBAP MARCHES PAIR TO OKLAHOMA ALTAR

Fort Worth Station's Music Broadcast for Wedding

MARLOW, OKLA.—B. L. Lewis and Miss Catherine Lewis, married here recently, marched to the altar to the strains of Mendelssohn's "Wedding March" played 200 miles away in Fort Worth, Texas.

In response to a telegram asking that WBAP play a wedding march, the Rialto Theater organ recital in Fort Worth, was stopped to enable the theater manager to announce the request. Miss Margaret White, organist, who plays for each Sunday afternoon, then played the wedding march. Music was received here by loud

FINE REPRODUCTION WITH CONCH SHELL

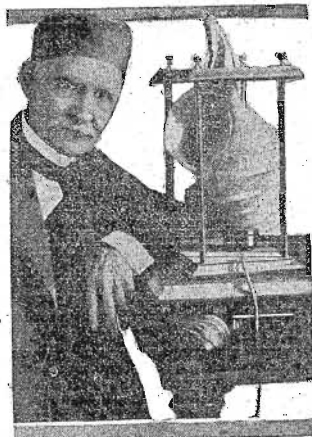

Dr. J. Harris Rogers, the famous Radio pioneer and inventor of submarine Radio devices, is shown here trying out a conch shell as a loud speaker horn. It does away with the "metallic ring" that marks the tone of most other speakers, according to Dr. Rogers, but he discloses the originator of the idea.

Int. Photo

Teaching the Radio A-B-C's:

THIRTY-MINUTE A-B-C Lessons for Radio Beginners," a series of extremely well-words articles on Radio by P. E. Edelman, begins next issue. Radio Digest believes it has found in Mr. Edelman the first and only real writer for the Radio novice. His diagrams and explanations portray with the utmost simplicity exactly what happens when a program is broadcast and received by the listener in. In other words, the series gets down to "ham and eggs" and bedrock without enveloping the beginner with a barrage of meaningless technical words, phrases and diagrams. Begin the series March 22 with the first article, "A Radio Night's Entertainment." Here is told what a broadcast listener finds out, how programs are transmitted and heard, that Radio is energy, what modulation means, and what receiver essentials are.

Invents Signal to Tell Kind of Entertainment

Broadcast Call Is for Convenience of Absent Fan

PHILADELPHIA.—An invention whereby Radio users can leave their sets and be notified through distinctive audible signals whether music, lectures or other forms of entertainment are being received in their absence was described by Charles S. Damarest, Milton L. Almqvist and Lewis L. Clement, well-known Radio engi-

neers. Details of the device were given in a paper read before the convention of the American Institute of Electrical Engineers in session here.

The invention, it was pointed out, will also eliminate long hours of sitting with receivers to the ear by operators aboard ships, while its selective features will enable Radio listeners everywhere to choose entertainment.

Rio de Janeiro Fans Organize

WASHINGTON, D. C.—A Radio society has just been organized in Rio de Janeiro. The principal purpose is for broadcasting. It is planned to install a high-power broadcasting station.

A Freed-Eisemann KNOCKDOWN NEUTRODYNE RECEIVER

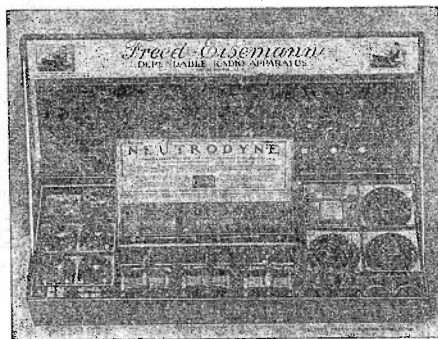

Unassembled Model KD-50, Freed-Eisemann Neutrodyne Receiver

NOW the opportunity is presented to obtain a complete set of parts, recommended by the manufacturer, to work with each other in building your Neutrodyne set. An illustrated 32-page book on how to build the Neutrodyne with full-sized diagrams and templates included.

Complete with Full Instructions
\$80

Dealers Write for Name of Nearest Distributor



Front View KD-50, Neutrodyne Being Assembled

NEUTRODYNE has taken the country by storm. It is the remarkable distance getting, powerful, non-oscillating and non-whistling receiver.

A 32-page book answers every question. The panel is accurately drilled. A baseboard is furnished; in fact, everything down to the very last screw and nut, including all necessary parts excepting the cabinet.

Besides the book there is furnished schematic blueprints and template for drilling the baseboard, also full-size pictorial perspective wiring diagram, so that it will hardly be possible for the amateur with ordinary care and skill to make an error.

Remember that here are licensed parts—not a collection of apparatus trusting to luck that they will assemble properly. Each part is designed and fitted to work with each other part in this particular set. The instructions are so complete and the parts so accurately matched that you will be grateful for the manner in which we have eliminated guesswork in the amateur construction of this receiver.

For sale by dealers of the better class throughout the country, for amateur and experimental building. Builders are cautioned against attempting to build a Neutrodyne Set with parts which are not recommended and designed by the manufacturer to work with each other.



32-page illustrated book of instructions on "How to Build the Neutrodyne" with full size pictorial wiring diagram and full-size panel and baseboard templates, \$1. At your Radio Dealers.

Freed-Eisemann Radio Corporation

SPERRY BUILDING MANHATTAN BRIDGE PLAZA BROOKLYN, N. Y.

DARK AND WILLOWY ONES WIN AT WLW

FIRST RADIO BEAUTY CONTEST SUCCESSFUL

Unique Telegraphic Vote Polls Best for Mathilda Brooks—Is Slender Supple Brunette

CINCINNATI.—Slender, willowy brunettes, with the dark and seductive eyes of a Russian Princess, are beloved by Radio listeners to be the most beautiful women in the world, according to results in the first Radio beauty contest in history, held here recently by the Crosley Radio Corporation station, WLW.

The contest was unique because votes were cast without the voters having an opportunity of seeing the girl they were choosing.

Honors were carried away by Miss Mathilda Brooks, 20 years old, of 310 Magnolia street, this city, who won by a large majority over three other contestants.

Heavy Telegraphic Vote

The contest was a telegraphic one, meaning that only those votes sent by telegraph were counted, and nearly a thousand telegrams were received. Two telegraph operators were kept busy for six hours receiving the votes sent from all parts of the country.

When the contest was started the four girls were described without giving their names but giving their numbers from one to four. At the completion of this description, each of the contestants was permitted to say a few words by Radio in order that the listeners might have some idea of her voice.

Description That Puled the Votes

The description of Miss Brooks, the description that met the approval of a majority of the voters follows:

"Hair, raven black; eyes, of a Russian Princess, dark and seductive; nose, full feminine; mouth, with lips full and cherry red; complexion, brunette, decidedly; figure and size, slender, willowy—a replica of Nazimova; smile, full and sympathetic; accomplishments, sings beautifully; personality, 80 and 44-100 percent."

Shouldn't she have won the prize?

Mary Costello, who won second prize, was described as having bobbed hair, with bangs and marcelle effect on top and a confusion of curls encircling her head, with a small dimpled chin and with a smile that is "hesitating but captivating."

ANOTHER REASON FOR COAL RAISE

Ship's Officer Discovers a Lump Goes Well as a Make-Shift Detector

WASHINGTON.—Back in 1906, when there were no such things as tube receiving sets and no fixed crystal detectors, a Naval officer, now in charge of Radio development and research work of the Bureau of Engineering of the Navy, tells of an early make-shift detector.

On board the U.S.S. Georgia, during some gunfire tests, the operators experienced great difficulty in copying code, even from the ships in the immediate vicinity. Every time the shtp fired a salvo, the crystal detectors jumped off and had to be readjusted.

Something had to be done: the Radio officer secured a lump of hard coal and a heavy needle from the ship's tailor. Driving the needle into the lump of coal, he provided a fixed crystal detector—perhaps the first known detector of this type. It functioned poorly, although it stayed fixed. By putting on the Georgia's very best operator, messages from the flagship, which was 400 yards away and transmitting at full power, came in faintly, were copied, and no more reports were missed.

R. C. A. Seeks Place on Gotham Stock Exchange

NEW YORK.—It is announced by Major General G. Harbord, president of the Radio Corporation of America, that after certain changes have been made in the unit sizes of that concern's stock, application will be made to list it on the New York stock exchange.

According to the statement just made public business in the Radio industry has been so good that holders of R. C. A. preferred will this year receive the 7% dividend cumulative from January 1, 1934. At the stockholder's meeting to be held in May, it is planned to amend the charter of the Corporation that there will be but one-tenth as many preferred and one-fifth as many common shares as now exist.

Chimes Play at WSAT

CINCINNATI.—Station WSAT, the United States Playing Card Company here, has installed a set of chimes, and the first chimes concert was given recently.

95 Schools, 22 Churches, 46 Papers Run Plants

Census Shows Every State Has at Least One Station

WASHINGTON.—Educational institutions, churches and newspapers have recognized the value of broadcasting, according to late reports from the Department of Commerce.

A census shows that 95 stations are owned by universities, colleges or schools. It lists 46 newspapers or publishers operating their own stations, and 20 churches, not including many which utilize other stations.

Every state has at least one station broadcasting entertainment, lectures, weather reports, etc. Two stations broadcast date from their market bureaus, and nine municipalities, chambers of commerce or boards of trade have stations serving police forces, or other community interests.

The grid leak in an ultra-audio circuit should never be shunted across the grid condenser, but connected from the grid to the filaments, minus or plus.

ENTIRE BROADWAY COMEDY OVER WJZ

DISTANT LISTENERS "SEE" THE WHOLE SHOW

"Mary Jane McKane," Especially Well Adapted to Broadcast Purposes, Made Big Hit

NEW YORK.—For the first time in several months listeners in recently had the opportunity of attending a Broadway musical show via Radio, and of "seeing" the performance from first to final curtain, when Station WJZ broadcast the entire performance of "Mary Jane McKane" direct from the Imperial Theater. The production, in which Mary Hay and Hal Skelly are starring, is one of the liveliest and most tuneful of the season, and is admirably adapted for Radio, giving as it does an abundance of clever musical and verbal entertainment.

Few Shows Meet Radio Demands

Only in exceptional cases is the broadcasting of an entire performance of a

theatrical production acceptable to the Radio audience, for an unusually happy coincidence of acoustics in the theater, of bright musical numbers, and of entertaining lines, is essential before the invisible audience can be assured of maintained interest and enjoyment during the two hours and a half which such a performance fills.

In "Mary Jane McKane," the first Radio show which the metropolitan listeners-in have been offered this winter, these conditions were so admirably met as to amply warrant the broadcasting of it in its entirety.

Three New Wave Length Tests to Be Made by U. S.

WASHINGTON.—Commencing at 11 p. m., on March 20, and April 4 and 21, the Bureau of Standards, Station WVVV, will again transmit standard frequencies or wave lengths for testing transmitting and receiving apparatus and calibrating wave-meters. The accuracy of the emitted waves is three tenths of one percent. Signals should reach all stations east of the Mississippi River, the bureau states.

The schedule covers frequencies between 500 and 2000 kilocycles, or 500 to 150 meters wave length.



The Neutrodyne parts illustrated below sell at \$25. The complete parts for a 4-tube set, everything included down to the last screw, sells at \$54. For those who wish to build a 5-tube Neutrodyne receiver the complete knockdown parts are sold at \$55.00.

FADA parts for NEUTRODYNE Radio Receivers

The Neutrodyne receiver has proved to be the most efficient yet devised for broadcast reception. In selectivity, distance getting, volume and clarity it has no equal.

To make a Neutrodyne receiver requires care in construction and the use of parts that are mechanically and electrically perfect. The electrical characteristics of the Neutroformers and Neutrodons are so exact in their requirements that their manufacture requires radio engineering knowledge and skill of the highest order.

FADA parts for Neutrodyne receivers

are made under the direction of experienced and expert radio engineers. Every part is mechanically and electrically perfect. Those who have used them testify to the wonderful results produced by sets made with FADA parts and following FADA instructions. Your dealer can furnish FADA parts for four and five tube Neutrodyne sets.

Our booklet, "How to Build Neutrodyne Receivers"

is included with each combination of FADA parts, or may be had direct or from dealers at 50 cents per copy.

F. A. D. ANDREA, INC., 1581 Jerome Avenue, New York City



F. A. D. ANDREA, INC. 1581 Jerome Avenue New York City

Gentlemen:

Enclosed find fifty cents Stamps P. O. Order for which send me your book on "How to Build Neutrodyne Receivers."

Name..... Street Address or R. F. D..... City or Town..... State.....

OPERATING AND TROUBLE SHOOTING

For the Owner of a
GATES
Model Two-One-Two
Receiver

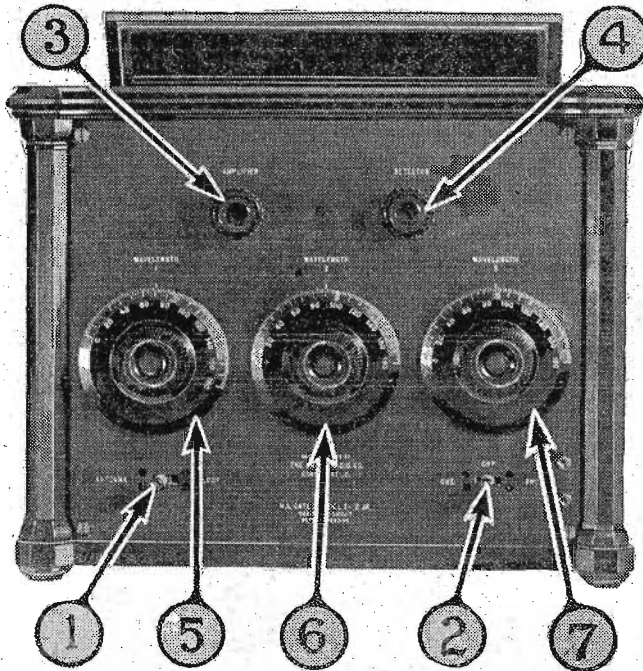

“OPERATING and Trouble Shooting” is a Radio Digest feature whose purpose is to study the late models of various standard receiving sets and to show the newly initiated broadcast listener, who has purchased such a set, how he can operate it to get the best there is in it and how he can overcome minor difficulties which may be causing some trouble. On pages 9 and 10 this week the Gates Model Two-One-Two Receiver is described. Radiophans with other sets will also find these articles worth reading, particularly the notes on trouble finding.

THE Gates Radio receiver is manufactured by the Gates Radio Company of Cincinnati, and is the result of a long series of experiments along new lines of research and was fully developed before it was placed on the market.

Tuning and Interference

The two major difficulties for the average amateur in Radio work has been simplified to such an extent that anyone can get perfect results with this instrument. Local broadcasting, however powerful, can be eliminated entirely and with ease. Tuning in any desired station

within the range of the instrument is merely a detail of setting the dials on the panel to certain fixed numbers which are logged, and instantly the station is heard clearly.

Range

The range of this instrument is from 200 to 600 meters. Distances up to 2,000 miles have been tuned in repeatedly and

easily with clearness of volume and steadiness of reproduction. Low notes of the organ and high notes of the violin are reproduced in their exact tone and volume.

Simplicity

Two particular qualifications of this instrument commend it to the user. Stations are recorded at the same setting, and tuning in only means the turning of

the calibrated dials to certain fixed numbers. Volume may be varied at will without the loss of definition or quality, by throwing a single switch in the circuit.

Tubes

Five tubes are required. These may be five of the A-type tubes but the use of a soft detector is recommended for the center socket.

Connections

Two antenna posts are provided, one for a long antenna, such as 80 feet or over including lead-in, while the post marked S is for use with an antenna where the total length is around 60 feet or possibly less. Two posts are provided for loop reception.

The A battery may consist of dry cell units or a storage battery as desired.

When a soft detector tube is used the second post from the left side (rear view) should be connected to the taps on a 22½-volt B battery unit, testing for the voltage (16½ to 22½) which will give best results. If an A tube is used in the detector, it may be necessary to increase this to 45. The total amplifier voltage may run from 67½ to 120 volts, depending on the volume desired.

The Controls

Switch 1 controls the selection of the outdoor or loop antenna as desired. When in the center position, both are disconnected. When thrown to the left, the outdoor aerial is in use, to the right the loop is connected.

Switch 2 controls the stages of audio amplification and also acts as a battery switch. When left in the center, or neutral position, the batteries are disconnected. When thrown to the left, one stage of audio amplification is in use; to the right, both stages are in use.

Knob 3 is the rheostat controlling the lighting of the four amplifier tubes; knob 4 takes care of the detector tube only.

Dials 5, 6, and 7 are the major tuning controls and will operate in conjunction with one another so that the same graduation setting for one will be found true for all. In order to tune out an interfering station a slight detuning or changing of the uniformity of dial setting will often be found beneficial. The loud speaker is connected by inserting the cord tips into the single connection jacks in the lower right-hand corner of the front of the set.

(Continued on page 10)

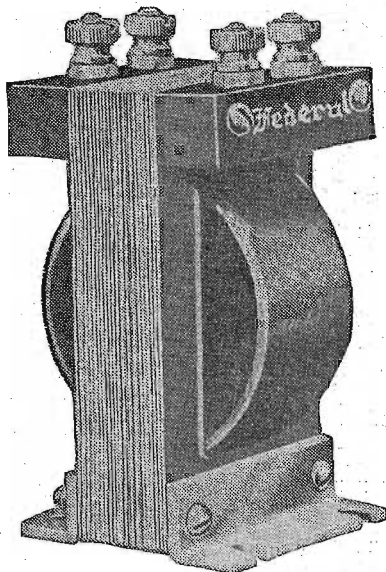

The now famous No. 65 Audio Frequency Transformer is but one of over 130 radio parts designed, manufactured and guaranteed by Federal.

\$7.00



Federal
Standard RADIO Products

The Thrill that now comes many times in a lifetime

YES, and we might have said “many times in an evening.” for who does not tingle when getting some distant station or “listening in” on some hitherto denied program?

And if you use Federal Standard Radio parts—including the now famous Federal No. 65 Audio Frequency Transformer—your set reproduces with the fidelity that can be made possible only through such experiment and research as Federal’s tremendous resources allow.

Federal Telephone and Telegraph Company

Factory: BUFFALO, N. Y.

Boston Pittsburgh New York Philadelphia Bridgeburg, Canada Chicago San Francisco London, England



The Sign of Reliable Radio Dealers

OPERATION, TROUBLES

(Continued from page 9)

Tuning

Throw switch 1 to the left and 2 to the right, then turn rheostat knob 3 about one-half to three-quarters the way around, depending on the type of tubes used. Then turn knob 4 until the usual purring sound is heard, indicating an approximate adjustment.

From the wave length chart furnished, set the three dials, 5, 6 and 7, in the proper position for the wave length of the nearest broadcasting station on the air. Dial 5 will require a slight readjustment in some cases, due to the variations of the antenna

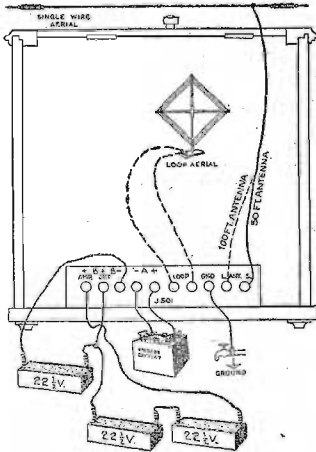

used. Once having received a station make a record of it in a log book, with the call letters, wave length and dial settings. These settings will hold true at any time it is desired to get the station. In final adjustments, the rheostats should be turned to the position of maximum and clearest volume.

To shut off the set, just throw the switches 1 and 2, into the neutral position without touching the rheostat knobs.

General Information

Use an aerial not more than 80 feet

long and see that it is well insulated. Have your aerial as high as possible. If you must use a long lead-in wire, then see that the horizontal part of aerial is short. If the lead-in wire is short, use longer aerial. In any case, never use more than 120 feet of wire for aerial and lead-in. Number 14 stranded copper wire is best for aerial. Wires connecting batteries and leading from batteries to set should be at least 18 gauge copper wire. The larger the wire the less resistance. Use insulated wires for connecting up set to prevent touching and shorting.

Tubes

Even though a tube may light and be new, it may be defective. If proper results are not obtained, take an extra tube and insert in each socket to see whether the replaced tube is functioning properly. Trouble also occurs frequently in batteries. Test your B batteries with a voltmeter and your A battery with a hydrometer. When a 22½-volt B battery tests below 18 volts, throw it away. When A battery gets below one-fourth charged, it is time to recharge it.

Ground Wires

Attach to water pipe or other metal leading deep into the ground. Clean pipe first and attach wire tightly.

On local stations, clearer results will be obtained by using only one step of amplification or removing the aerial wire entirely.

Use from 16 to 30 volts on the detector and 67 to 90 volts on the amplifiers. This can be adjusted after the set is completed. Various tubes require different voltages for best results.

(ANOTHER SET NEXT WEEK.)

Inductance Coils

The coils used are very important. The turns should be spaced to lower the distributed capacity between adjacent wires. This is accomplished in honeycomb, spider web and bank-wound coils. The honeycombs seem difficult to handle on short waves, but the spider web coils are almost an ideal inductance. They are small, compact, efficient, self-supporting, durable and can be easily made and mounted. Don't paint the coils with shellac or varnish. If an adhesive agent is necessary use collodion. This keeps the wires in place, dries quickly, and does not appreciably affect the efficiency of the coil. Be careful in handling collodion as it is very inflammable. Single layer coils are most common and easily made, though they are not the most efficient.

Don't burn vacuum tube filament above rated amperage and voltage.

THE AUDIOPHONE



Quality of reproduction such as only the original itself can equal. Speech that is so distinct that the voice heard is the actual voice of the speaker. Music that requires no tolerant imagination to be recognized as music of the finest type.

Bristol's Single Stage Power Amplifier



gives additional VOLUME with any two stage amplifier. No separate batteries required. It provides the additional volume necessary to bring in very distant stations on the loud speaker.

Write for bulletin and address of the nearest dealer handling our instruments

THE BRISTOL COMPANY
WATERBURY, CONN.

Boston New York Philadelphia Pittsburgh Detroit Chicago St. Louis San Francisco

RADIO TALKS
Every bit of resistance that you can remove from your receiving system means just so much better reception. Every joint in your connecting wires, or tap on the coils that you are using is a move in the wrong direction. Eliminate taps, joints and poor apparatus and you can expect proper returns for your work.

Genuine - E.T. Flewelling Radio Apparatus De Luxe

The new Flewelling Condenser is now being delivered in the 23 plate size. Its capacity test is interesting—Maximum—.0005119 mfd. Minimum—.0000099 mfd. This shows a range of 51.7 to 1 which means that with a certain fixed inductance this condenser will permit you to tune over a large wave band. It is a genuinely good condenser and you will be proud of the performance of a set built with these condensers as a basis.

BUELL MANUFACTURING COMPANY
1977 Cottage Grove Ave. CHICAGO

- Flewelling SOCKETS \$1.00
- Flewelling TUNERS \$8.00
- Flewelling CONDENSER [.0005] \$7.00

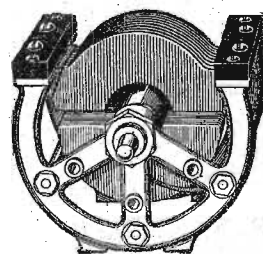

BRINGS IN EVERYTHING BEAUTIFUL MAHOGANY NEUTRODYNE

WHEN you get this magnificent looking set wired and hooked up, you will be able to hear all stations without interference. All parts are same as illustrated in Radio Digest, Feb. 2nd. Panel is mahogany with beautiful mahogany dials—a set fitted for the most exclusive home. Panel drilled, all parts mounted on panel and baseboard ready for wiring

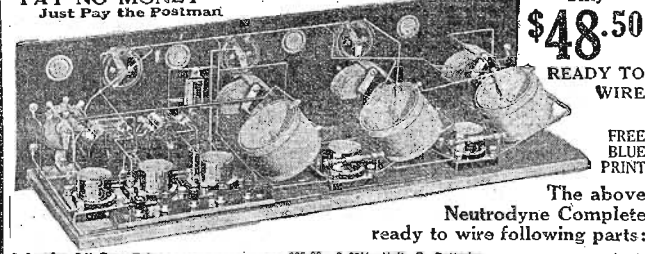

PAY NO MONEY Just Pay the Postman
\$48.50 READY TO WIRE
FREE BLUE PRINT
The above Neutrodyne Complete ready to wire following parts:

5 Genuine DX Tron Tubes	\$25.00	2 22½ Volt B Batteries	\$ 6.00
1 110 Ampere Storage Battery	18.00	9 Random Binding Posts	\$6.00
1 Deluxe Homecharger	15.00	1 Futtone Loud Speaker	9.50
1 Genuine Baldwin Headset	12.00	1 Complete Aerial Equipment	1.50
1 Complete Aerial Equipment	1.50	45 Volt B Battery	5.00
1 45 Volt B Battery	5.00		
TOTAL		\$95.50	

The above parts and equipment complete would cost you \$144.00! **Our Price \$125.00**

It Works—NEUTRODYNE—All Standard Parts

3 Rheostats, 30 ohms	\$ 2.00	2 Transformers	\$ 5.50
3 Rheostats, 8 ohms	.50	1 Random Binding Posts	.35
3 Air Core R. F. Transformers, mounted on condensers, and 2 balancing condensers	20.00	1 8x26 Mahogany Panel	3.54
1 Potentiometer, 600 ohms	1.50	4 Bezels	.80
3 Jacks	2.70	3 Dials	4.50
1 Condenser	.45	1 Baseboard	.30
1 Grid Leak	.65	24 ft. Square Brass Bus Wire	.60
5 Sockets	5.00		
		Total \$55.89	

Only \$45.50 with blue prints FREE

CABINET FOR YOUR REFLEX NEUTRODYNE
Same Cabinet as shown on page 26, Radio Digest, March 8th issue
With Baseboard, High Mahogany Finish—Fine Cabinets 9x14x8. **\$5.98**
List \$12.00. Only 7x16x8—Same quality \$5.98

A Few Left—BALDWIN UNITS
Genuine Baldwin Type C unit with mica diaphragm, list, \$6.00. Only **\$3.19**
ONLY TWO TO A CUSTOMER

Special Sale on Webster Condensers, Fine for Super-Heterodyne
Variable Condenser, .0005 (Same as 23 plate) **\$2.98** Variable Condenser, .001 (Same as 45 plate) list, \$5.50. While they last—Bargain at **\$2.98** list, \$6.00. Big buy at **\$2.98**

We are responsible folks, money cheerfully refunded within ten days if you are not satisfied. All Orders Mailed Promptly. No Stamps Accepted. Send Check or Money Order. Quality Merchandise at Low Prices. **Economical Radio House** 4600 LINCOLN AVENUE, CHICAGO. We Personally Guarantee All.

Musical Education by Radiophone Broadcasting

Air Waves Turn Americans into Opera-Loving People

By Dr. Lee De Forest



Dr. Lee De Forest peers into the product of his mind and sees—a musical America.

and not until then, will we see a genuine American opera—one worthy to rank with those of Verdi, Bizet or Puccini—and destined to live.

If this were the only application of the Radiophone, its ability to educate our people in good and noble music, that alone would amply justify the Government, or our musical societies, in endowing and maintaining such a service as I have just described. In this field of opera and symphony, of high-class concert and chamber music, secrecy of Radiophone transmission is quite unthinkable. The better the music, the more general is its value, the more the necessity for making the service quite free to all who can hear. The musical organizations which give freely of their product will suffer no loss; on the contrary, they will earn the grateful interest of multitudes who would otherwise never learn of their superb art. And from these new ranks will flock new patrons, new recruits, new lovers of music.

Opera on Ocean Liners

When I crossed the Atlantic in February, 1908, taking with me the first telephone transmitter for installation at the Eiffel Tower, Paris, I was asked to give a talk at the ship's concert on the new invention and its possibilities. I dwelt

particularly then, on the proposition that when Radiophone music, opera, etc., were broadcast nightly from New York and Paris, every ship on the Atlantic Ocean could have its own concert, where only the very finest of the world's music need be heard. That day, that night, lies still in the future. But it draws near. The Radio reception of music from shore is not important to the big liners, whose orchestras discourse nightly such music as they have (partially) mastered, and are ever at the command of the dancers aboard; although I dare say many passengers would sit up very late of night to hear, in at least one salon or lounge of the largest ships, by contrast, echoes from the Metropolitan Opera. But consider the hundreds of smaller vessels, without orchestras. To them what a boon from heaven, this music of the future from distant shores! These ships will be equipped with special antennas, amplifiers, and loud speakers in their salons, and there, whenever "Sparks" above is not answering a code call—and perhaps even then—this music or entertainment from the largest broadcasting stations, and therefore the best of the short program will come rippling in to afford such respite from the monotony of a sea voyage as never before dreamed of.

WHEN, in 1909, I first prophesied the coming era of Radio broadcasting, I laid prime stress on what it would mean to the public generally and to producers of opera especially, to send this form of noble music to every corner of the land. We Americans are by no means a musical people as compared with most of the European nations. Familiarity with and liking of opera music is unfortunately limited with us to a very small percentage. Almost every effort heretofore attempted to make opera at popular prices self-sustaining has met with failure. Excellent organizations like the Gallo Grand Opera Company fail to draw even fair houses longer than a very few weeks in any city.

Making Americans Opera Lovers

To turn Americans into an opera-loving people, despite the yearly influx from Europe, would in the natural course of events require decades, perhaps centuries. Not that we cannot quickly learn to appreciate good music when such is often heard, but to induce the audiences to go first to hear, and then again and again to hear, then to appreciate, to understand, to love good music, is the difficulty. So to one whose greatest joy and relaxation was to hear good opera this ability of the Radiophone to bring into every home, not second-class opera, not phonographic reproductions, but the voices themselves of the highest-salaried artists of the Metropolitan and Chicago Opera companies, appealed with a fascination and aroused a faith which is today with me as keen and strong as when the idea was first born.

Influence of Opera Broadcasting

Opera impresarios and directors do not, or at least should not, fear that if their productions are heard in every home in New York or Chicago, their box-office receipts will suffer one whit. For from every twenty who thus hear the arias and more or less fragmentary gems at home, without seeing the gorgeous stage pictures which accompany these, one at least who would never otherwise know what loveliness he was missing, will feel irresistibly compelled to go to Grand Opera. Thus the number of regular opera-goers, and lovers, will be greatly increased. Nation-wide education in the best of opera, repeated familiarity with the actual voices of the best artists, cannot but immensely benefit the business of opera. I am very sure, therefore, that whenever our Radio distributors really and zealously awake to their opportunity they will find the opera directors ready to co-operate with them to place in the wings and in the orchestra pits properly designed sound-collectors which will convert the music into perfectly modulated telephone currents, to be transmitted by wire to distant high-power Radiophone transmitters, say, four or five scattered throughout the United States.

What Government Could Do

The Government should set aside a special zone of wave lengths reserved exclusively for opera and symphony orchestras, so that, on every night of the musical season, listeners can tune in to the Metropolitan or Chicago Operas; or to the Boston, Philadelphia, Kansas City or San Francisco symphony programs, and at his own distant fireside drink in the very best of the world's music.

Musical Awakening in Ten Years

What will this exquisite musical service mean to the American people, hitherto strangers, for the most part, to that fine life and education? Maintain it for ten years and we shall witness a national musical awakening, the like of which history does not record! Then,

and now!—the All-American Long Wave Radio Frequency Transformer (Type R-100); 4,000 to 10,000 meters (75 to 30 K. C.); suitable for all long wave radio frequency circuits such as Super-Heterodyne, Ultradyne, Reflex, etc. Placed on the market only after long and thorough tests. Again All-American leads.

Windings of extremely low capacitance, properly treated and impregnated. Housed in a handsomely nickel-plated shell of same physical design as All-American

Audio Frequency Transformers—to insure ease of assembly and neatness. Shielded to prevent inter-stage coupling or reaction.

RAULAND MFG. CO., 2650 Coyne Street, CHICAGO

Pioneers in the Industry

SOLD BY ALL THE BETTER DEALERS

STANDARD ON THE BETTER SETS



ALL-AMERICAN

Amplifying

TRANSFORMERS

LARGEST SELLING TRANSFORMERS IN THE WORLD

Green Circuit Variocoupler

Questions Answered on This Set

By Myron P. Green

AMONG the many inquiries received on the Green circuit that appeared in this magazine on February 2 and 9, there were several from fans who did not understand the nature of the variocoupler used and wrote me requesting personal letters, but as it would take far too much time to answer them all individually, I will answer them collectively in this article.

The Coupler

This instrument can be of any standard make wound to receive up to 600 meters. Any good coupler with from 12 to 14 taps can be used. The rotor should have from 45 to 50 turns. This is necessary in tuning finely. Otherwise, all that is required is that these instruments be of substantial size and lightly wound.

As to the best tube to use with this circuit, it is the UV-200 if employing a storage battery with a plate voltage of from 18 to 22½, depending upon the tube characteristics. If a dry cell, I recommend the UV-199 with 45 volts on the plate. If the latter is used, mount the socket on a resilient base to avoid microphone noises. A rheostat of 20 to 50-ohm resistance is necessary. As mentioned in my previous articles, the variometers can be of the wooden type and as long as they are properly wound any make with 60 turns on the stator and from 40 to 50 on the rotor, will do.

Several letters spoke of a low steady hum in the phones with no signal received, and the variometers having no effect whatsoever. My suggestion is that the A battery leads be changed or that the jack may be the seat of trouble.

Carl F. Donald, Ripley, Ohio.—There are no other parts to buy. Just follow the diagram. Send me a self-addressed envelope if you require further help.

R. J. Howard, Hyde Park, Mass.—It is not necessary to wind your own coupler. Any good make will answer your needs nicely. Refer you to above article.

M. E. Jester, St. Louis, Mo.—Do not recommend Radio frequency with this circuit. Radio frequency is used with the idea of bringing in DX, but this circuit, properly hooked up, will bring them in

without it. Any two stages will work, just carry your A battery through and take your output from your jack to primary leads of transformer.

Fred W. Govang, Somerville, Mass.—It is not necessary to make your own instruments. Buy the standard makes.

E. C. West, Tiffin, Ohio.—Recommend that you cut down your aerial to about 50 feet. It is better to cut down local interference when out after DX.

T. F. Coleman, Providence, R. I.—Any good phone will serve the purpose. Yes, I think the Brown phone an excellent one. You can operate this set nicely without a grid leak if you use a UV-200 tube.

Wm. F. Schirmer, Chicago, Ill.—It is useless to have a four-wire aerial for receiving. It is only a waste of wire. Suggest a single wire the same length. Soldered connections are more efficient, and strongly recommend them.

F. J. Westland, Lynchburg, Va.—To comply with the Board of Fire Underwriters it is necessary that you install lightning protection. You can ground inside, but in your case it is easier to use the outside type.

W. E. Kohner, New York City.—Yes, there are dead spots in New York, but since WEA-F uses its additional power, it comes through all right. I have received WEA-F, Baltimore, fine. They only broadcast about twice a week.

Leonard F. Johnson, St. Paul, Minn.—Change your tube to a UV-200. Discontinue your grid leak. Cannot tell just what is wrong—would have to see the set.

Odd Crystal Set

While experimenting with different types of crystal sets I stumbled upon the one shown in the illustration. The only equipment required for the set is ½ pound of number 20 dec. magnet wire, some stiff cardboard, one crystal detector and crys-

tal, four binding posts and one baseboard, 8 by 8 by ½ inches. A panel is not necessary as all the parts can be mounted on the baseboard. The building of the set is as follows:

With a compass draw a circle 5 inches in diameter on the cardboard. Mark nine points at equal distances apart on the circle. At each of these points draw a

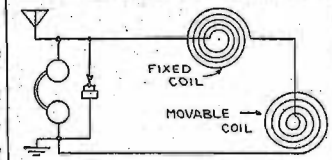

line to the center. Next cut a slit, ¼ inch wide and 1½ inches long, at each end of the nine points. On this form wind 26 turns of number 20 dec. magnet wire. There will be 13 turns on each side of the form. Make two of these coils. One is to be tacked to the base and the other is movable. You will have some wire left with which to make connections on the set.

The connections are clearly shown in the illustration. The capacity of the phone condenser is .001 mfd. If the set does not function, reverse the leads of the movable coil.—Harrison P. Doty, Milwaukee, Wis.

Plate Voltage

The plate voltage should be reduced if a bluish glow appears in one of the tubes. This shows the voltage is high. If kept up it may overheat the tube and shorten its life. It is a very fine electrical spray and is somewhat similar to high frequency discharges and the aurora borealis. It will occur at a much lower plate voltage in soft detector tubes than it will in hard amplifier tubes, and this is one of the reasons why detector tubes can not be used successfully as amplifiers.

A Radio controlled aeroplane has flown from Paris to Tours and back

The Reader's View

Again! Come on, Stations, Announce
Will you kindly publish a request through your columns for religious services conducted over Radio to announce occasionally their city? Often one tunes in to a sermon and can't find out where it is. Wherein a minister could easily say, "Here in"—whatever city it may be. I think this would inspire interest. We often tune out stations that talk too long without announcing the station.—Dorothy Macintosh, soprano soloist, WTAM, Cleveland, Ohio.

About the Liars' Club

In your issue of December 1, 1923, there appeared an item headed "The Reader's View," in which some fan from Cleveland, Ohio, says that "most people place Radio bugs preeminent in the Liars' Club." That does not apply here "by a long shot." Radio is taken seriously in the North and anyone found telling anything but "the truth, the whole truth and nothing but the truth" concerning his receiving set and its performance, or exaggerating or distorting news received by Radio would be considered a reprobate indeed.—David McAtulay, Nipawin, Sask., Can.

Spark Station Interference

In reading Mr. Campbell's article in Radio Digest on reradiation, he spoke of Radiophans giving Radio a sound foundation.

We cannot give Radio a sound foundation until all commercial spark stations are given a high wave length, and amateur broadcasters a low wave length, so that we will not hear them when listening in to local and out-of-town stations.

Fifty per cent of Radio interference is caused by spark stations, twenty per cent by amateur broadcasters, 15 per cent by reradiation and 15 per cent by defective street arc lights.

Until we all get together and have these interference causes stopped, Radio will be no pleasure.—A. J. T., Cleveland, Ohio.

Pay No Money

Until the postman arrives with the items you ordered. Then pay him. This is more convenient than if you went to a store.

The RADIO-SHACK
55 Vesey Street - New York City
Goods shipped C.O.D.
Just pay the postman
EVERY ARTICLE SOLD ON WRITTEN MONEY-BACK GUARANTEE

NOTE NEW ADDRESS

In order to facilitate deliveries and service, address all mail to our Executive Offices
55 VESEY STREET
NEW YORK

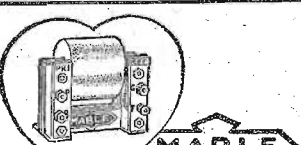

Radio & Audio Frequency TRANSFORMERS

"The Heart of a Good Receiver"

PERFECT amplification is the boon you secure when you buy a Marle Transformer. Radio impulses are magnified to the uttermost limit without a sign of distortion. True over the widest range of frequencies. Special folders, showing the hookups for standard circuits, sent upon request.

Write for Hookups and Illustrated Folder TODAY!

Your Dealer Sells Marle Transformers, or Write to us for the names of the nearest Marle Dealers.

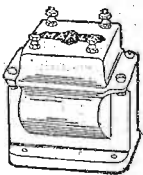

MARLE
Engineering Company
ORANGE, New Jersey

Audio F Type A7 Ratio of 3 1/2 to 1



Radio F Type R1 and R2

Build Your Own FIVE TUBE



With This Complete List of Parts

- 1 Set Hazeltine Neutrodyne complete mounted on molded condensers
- 2 Genuine Hazeltine Neutrodyne
- 1 Freshman Fixo Grid Condenser
- 1 Glass Grid Leak
- 1 Single Circuit Filament Control Jack
- 1 Double Circuit Jack
- 1 7x24 Panel DRILLED
- 20 Feet Bus Bar
- 7 Engraved Binding Posts
- 2 Fitzgerald Type A Transformers
- 1 6 Ohm Rheostat
- 1 30 Ohm Rheostat
- 1 Full Size Blueprint
- 1 .006 Freshman Micon Condenser
- 1 .002 Freshman Micon Condenser
- 5 Brunswick Sockets
- 3 3/8" Brass Bushing Dials

\$25.97

For Engraved Panel Add \$1.50 Extra

For Comsco Precision Variable Condenser add \$1.75 Extra.

WARNING

People all over the country constantly write us asking how we can possibly sell genuine parts at the ridiculously low prices at which we advertise them. Even fellow dealers ask "How do you do it?" In their desire to APPEAR to give as good value as we do, others advertise the same parts and combinations for complete sets BUT DO NOT SPECIFY "GENUINE" or "LICENSED" in their ads. We therefore give

WARNING

to all our customers to insist upon Genuine Licensed parts. When bought from us they cost you less than substitutes sold elsewhere. For proof—look thru any Radio paper!

Teach Your Dollars to Have More Cents!

Crosley XJ Four Tube Sets

BRAND NEW AT A BRAND NEW PRICE
Sells regularly at \$55.00
\$47.50

Supertron Tubes

TYPE UV 201A.....\$3.45
TYPE WD 12.....

Dependable tubes guaranteed not only by us but also by the manufacturers. You can buy tubes just as good for more money but you cannot get a better tube at any price.

Send 10 Cents for Our New 54-Page Catalog

Neutrodyne Tubes

A set of 5 type 201A tubes each thoroughly tested in a Neutrodyne Set before shipment thereby assuring entire satisfaction.

Packed in Set of Five
\$19.50

Comsco Condensers

	List	Our Price
11 plate	\$2.00	\$1.25
17 plate	2.25	1.40
23 plate	2.75	1.69
43 plate	3.50	2.35
16 plate vern.....	4.00	3.25
26 plate vern.....	4.50	3.65
46 plate vern.....	5.50	4.05

You cannot buy a better condenser at any price. Try one on our money-back guarantee at no risk to yourself.

MAIL THIS AT ONCE!

THE RADIO SHACK.
Please put my name on your Mailing List for your Weekly Specials. I am also enclosing the names of my friends who would like to be put on this list.

Name

Address

City

Simplified Reflex Gives Volume on DX Stations

ONE of our fan readers wanted to help out his fellow bugs and submitted his Reflex set. We have reproduced it in simplex form with all values. For your benefit we present parts of his letter:

"Just a few lines and a diagram will help some other Radio bug who, like myself, was sick of bringing in static instead of music. While others here are cursing and complaining about loud speakers and how they amplify static and not music, and finally giving up in disgust, I sit at home and with a single-tube reflex set, get music as clear as a bell, without a trace of static, from stations as far as Dallas and Fort Worth, Tex.; Baltimore, Md., and Omaha, not to say all the local stations, the closest being KSD, St. Louis, 110 miles. I am enclosing my hook-up. I use all standard parts, no interchanges. My aerial is 40 feet high, one wire 100 feet long of 16-strand braided ribbon. I have three grounds, water pipe, gas pipe and a regular 6-foot telephone post.—L. E. Brant, 229 South 17th Street, Mt. Vernon, Ill.

Keeping Up Battery Average

Though the introduction of the dry cell vacuum tube has in many instances eliminated the use of the storage battery, where a number of tubes are employed in a circuit, the storage battery is still worth while. The owning of a rectifier which permits the charging of a storage battery from the house lighting current is a feature which will pay for itself.

Many rectifiers are constructed so that the connecting of the rectifier terminals is not governed by the polarity of the battery markings. In rectifiers where this feature is not incorporated the connecting of the battery with the charger should be carefully done; be sure to make the positive connection of the charger to the positive pole of the battery. Do the same with the negative of course. If this is not done it is likely that the battery will be permanently damaged.

Batteries Rated at Ampere Hours

Batteries are generally rated at their ampere hours. That is, a 60 ampere-hour battery is rated as being able to deliver one ampere an hour during a period of 60 hours. Generally the actual delivery of current falls below this rating, but it is sufficiently accurate to enable you to judge how long a fully charged battery will supply current to any Radio set where

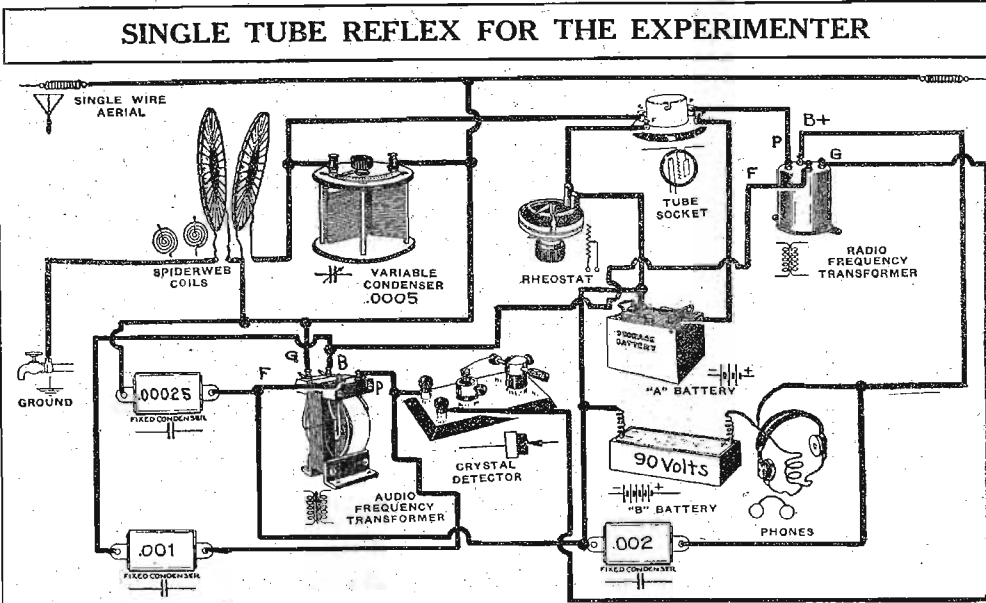

the amperage of the tubes used is known. A hydrometer reading of the electrolyte will show 1.300 when the battery is fully charged; it is a fairly accurate method of knowing the condition of the battery.

As to Removing Sulphation

It is a good idea to let the battery become pretty well exhausted about every third or fourth charge and then to give a slight overcharge. Sulphation is a condition which shortens the life of the cells; bringing the hydrometer readings up to 1.300 and allowing the charging to continue for a short time after this reading is reached, about every third or fourth charge, will remove sulphation which might not have been removed by previous charges not so complete.

Keep the battery terminals clean; when a terminal corrodes scrape it clean and apply a coating of vaseline or cup grease,

which will have a tendency to eliminate this condition.

Whenever a battery is charged be sure to see that the electrolyte just covers the plates. When the solution drops below this level add nothing but pure distilled water; by no means use a metal container to do this. Filling the batteries too full will cause

the cells to spray out of the holes during the charging operation; the corks must be removed at this time. Never add an acid solution to your battery. If, for any reason, you think this should be done, first consult an expert.

Don't touch the lead wires together to see the sparks; fireworks are cheaper and more fun.

Exit Variocoupler Enter Erla Selectoformer

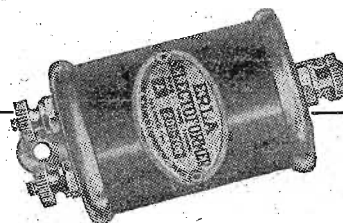

Combines Improved Properties of Coupler and Wavetrap

Again Erla contributes notably to radio advancement. Erla Selectoformer, replacing alike variocoupler and wavetrap, greatly increases volume and selectivity in radio receivers, at the same time reducing cost.

Selectoformer, as the name implies, operates simultaneously as a selector and antenna frequency transformer, picking off of the antenna the one wavelength desired and amplifying it to normal strength.

Thus is avoided the interference common to receivers that depend for selectivity upon tuning the coarse antenna system. Also, because of the amplification brought to bear, there is eliminated the loss of energy encountered in wavetraps of conventional type.

With Selectoformer, distant signals come in loud and clear, even with powerful local broadcasting in progress. Tone quality, likewise, is greatly improved, through reduction of static and other disturbances.

Control of the Selectoformer is effected through the 23-plate condenser already built into most receiving units. Installation is a matter of moments only.

For complete details regarding this and other Erla improvements, including latest reflex circuits, ask your dealer for Erla Bulletin No. 20, distributed gratis; or write, giving your dealer's name.

Electrical Research Laboratories
Dept. A 2515 Michigan Ave., Chicago

ERLA



Superior worth of Erla audio transformers, shown in their exclusive ability to amplify three stages without distortion, improves any set. \$5



Erla condensers alone carry a certificate of accuracy on their labels. Look for the words "Tested Capacitor" when buying. 35c to 75c ea.



Patented telescoping rim of Erla bezels fits any 1/2" to 3/4" panel, neatly screening openings required for tube ventilation. Nickel or enamel, 20c



Reliable and clear reception is assured through the Erla fixed crystal rectifier, requiring no adjustment and lasting indefinitely. List \$1



Pioneers in the development of sound reproducing apparatus.

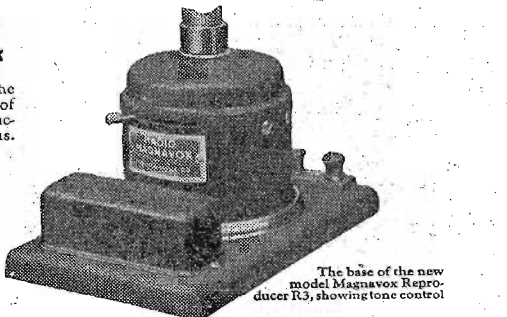

The base of the new model Magnavox Reproducer R3, showing tone control

Important features now offered in Magnavox Radio—the Reproducer Supreme

THE Magnavox electro-dynamic principle obviates the need of any mechanical adjustment to regulate the air-gap or change the position of moving parts. This famous principle of operation permits the use of an electrical volume control.

This control directly affects the character of the electrical circuit which creates the sound, controlling the sensitivity of the instrument and also its volume of reproduction.

Moreover, this electrical control produces a great saving of current (already reduced in the new R3 and R2 to a maximum of .6 ampere) for, by its action, the current value can be reduced

to a minimum of .1 ampere. The new Magnavox electro-dynamic Radio Reproducers R3 and R2, in fact, are equipped with the first true sound controlling device ever designed. See them at your dealers and write us for catalog.

THE MAGNAVOX COMPANY
OAKLAND, CALIF.
New York Office: 370 Seventh Ave.
Perkins Electric Limited, Toronto,
Montreal, Winnipeg, Canadian Distributors

AN EVENING AT HOME WITH THE LISTENER IN (SEE INSTRUCTIONS FOR USE BELOW)

Table with columns: Station and City, Mkt., Monday, Tuesday, Wednesday, Thursday, Friday, Saturday, Sunday. Lists various radio stations and their broadcast times.

Instructions for Use.—All the hours above are given in Central Standard Time. If your city uses Eastern Time, add one hour to each of the periods stated; if your city uses Mountain Time, subtract one hour; if your city uses Pacific Time, subtract two hours. This table includes only the evening broadcasts, and, on Sunday, the late afternoon program.

Measuring Low Resistance WASHINGTON, D. C.—Resistance as small as .001 ohm, for which a special form of Wheatstone bridge is ordinarily thought necessary, can be measured on an ordinary bridge, according to the Bureau of Standards of the Department of Commerce. The method is described in Scientific paper No. 481 entitled "Measure-

ment of Low Resistance by means of the Wheatstone Bridge." Copies can be obtained from the Superintendent of Documents, Washington, D. C.

The rim speed of the Alexanderson alternator is 12 miles per minute. It turns 20,000 revolutions per minute and generates a current of 100,000 cycles frequency.

2-LO, LONDON, ENGLAND ON ONE TUBE Official Record for the ELGIN SUPER-REINARTZ

Tuesday, November 27, during the test period between 9 and 9:30 P. M., Rev. E. A. Cole in the residence of J. A. Melver, of Roodhouse, Ill., while operating a set made of materials and in accordance with the hookup furnished by the ELGIN-RADIO SUPPLY CO., tuned in 2-LO, London, England, using receivers and but one tube. Later another tube was lighted and the loud speaker used, so that four people could hear the program and concluding announcement. The numbers, time, and the order in which they were played were

Officially Confirmed

by the St. Louis Post Dispatch in conjunction with the National Association of Broadcasters, who had charge of the tests. (See page 34, St. Louis Post Dispatch, Dec. 2, 1923.) This same hookup has been advertised extensively as the one which brings in stations 2000 miles overland on a loud speaker and one tube; and this has been demonstrated so often as to need no repetition.

Send a two-cent stamp for circular giving one, two, and three tube hookup, and price list of parts for this remarkable circuit. Address the

ELGIN RADIO SUPPLY CO.

207 Chicago St.

ELGIN, ILL.

SUPER VALUES

WHAT'S NEW IN RADIO? Hazeltines Neutrodyne

The ultimate receiver for local and long distance Radio concert reception

THE MOST TALKED ABOUT SET OF TODAY

- 1. SIMPLICITY (A child can operate it)
2. SELECTIVITY (You can tune out local stations)
3. STABILITY (Always ready to entertain)
4. DISTANCE (Average range about 2000 miles)
5. NOISELESS (No squeals, no howls, no whistles)

Complete Parts for Building This Master Receiver AS LISTED BELOW, ONLY \$49.65

Table listing parts for the receiver: Stock Quantity, Part Name, Price. Includes items like Bakelite panel, Baseboard, Standard sockets, Neutrodyne transformer, etc.

Accessories Necessary to Complete Set for Operation

Table listing accessories: Stock Quantity, Part Name, Price. Includes items like Banded tubes, Loud speaker, Genuine Baldwin type C unit, Columbia or Red Seal A battery.

OUR SPECIAL COMBINATION OFFER

To each purchaser of the parts and accessories for the HAZELTINE NEUTRODYNE RECEIVER at the low price of \$97.00 we will, without cost to you, ship a Genuine HANES-ZENER special hand rubbed solid mahogany cabinet. Value \$10.00. Each of the above parts are of the highest standard grade, and carry the HANES-ZENER guarantee and can be purchased separately at our special prices.

RESISTANCES—Genuine P. L. Original Lavite 48,000 OHMS \$1.00 100,000 OHMS \$1.00 We Are Prepared to Supply Dealers. Write for Our Proposition.

REINARTZ CIRCUIT Complete

Table listing Reinartz circuit components: Part Name, List Price, Our Price. Includes items like Reinartz Coil, One 7x2 1/2 Radion Panel, National Bakelite Socket, etc.

All the necessary screws, nuts and miscellaneous small parts which are necessary to complete the set are included in the above prices. Any part in either of these circuits may be purchased independently at the advertised cut prices.

Cockaday Four-Circuit Receiver 3000 MILES

Parts as specified by Mr. Cockaday

- 1-Cockaday Coil
2-Amasco 26-Plate Condensers
2-Amplex Grid-Densers
1-Bradley Leak, 1/4 to 10 meg.
5-Melco Sockets
1-Amasco 6 ohm Rheostat
1-Amasco 20 ohm Rheostats
1-Pacnet Single Jack
2-Pacnet Double Jacks
2-American Transformers
1-Como Push-Pull Transformer—Input
1-Como Push-Pull Transformer—Output
2-Switch Levers
11-Switch Points
2-Switch Stems
1-Duhiller Condenser—0005
1-Duhiller Condenser—00025 with Mount
1-Durham Variable Grid Leak
3-Lavite Resistances—48,000 ohms
1-Amasco 400 ohm Potentiometer
1-7x24 Panel
1-3"x2 1/2" Sub Panel
1-12"x12" Panel

Our Price \$59.00

We Have Just Received a New Shipment of THE NEW MODEL D. N. K. & K. PHONES \$6.50 MADE IN GERMANY

WE GIVE A 20% DISCOUNT on All Standard Radio Apparatus Not Listed Above

All Mail Orders Shipped Promptly Send Money Order, Including Postage The Radio Mail Order House—Known for Low Prices

WRITE FOR OUR CATALOG "B"

HANES-ZENER

1480 Broadway, Corner 42nd St., New York City

DOUG AND MARY TO TALK FROM WJZ

Tuesday, March 11

KDKA, E. Pittsburgh, Pa. (Eastern, 326), 12:30 p. m. Organ recital, Howard K. Welch; 9:15, Dinner concert, Grand Symphony Orchestra; 8:00, Radio Girl Scout Meeting; 8:30, Harlowe Rosen, pianist; Katharine Jayson, cellist; Nancy East, pianist; 11:30, Concert, Jason City Orchestra.

KFI, Los Angeles, Calif. (Pacific, 469), 8:45-7:30 p. m. Concert by Emma M. Harlett; 10:00-11:00, Entertainment program, presenting Silver-shot Stars.

KFKB, Milford, Kansas (Central, 289), 7:00 p. m. Radio Course, Kansas State Agricultural College, "The Production of Wholemeal Dairy Products," Prof. N. C. Olson; 7:30, "Feeding, Care and Management of Baby Chicks," Prof. L. F. Payne; Eunice Anderson, pianist; Eleanor Varada; vocalist; Girls Club, Edna Ellis, director; "Getting Both Sides of It," Prof. M. B. Summers.

KFKX, Hastings, Neb. (Central, 341), Rebroadcast KDKA program.

KFSG, Los Angeles, Calif. (Pacific, 278), 5:30-4:30 p. m. Special music and read for "Saut-Ins"; 7:00-7:30, Children's Bible story; 8:00-9:30, Musical program and sermon by Anne Harlowe McPherson.

KGO, Oakland, Calif. (Pacific, 312), 8:00 p. m. "Intimate Stanzas," Barbara Pieters, soprano; Noble Burnham in triple role; Ison Trio.

KGW, Portland, Ore. (Pacific, 492), 12:30 p. m. Concert, Civic Club of Portland; 5:30, Talk, Jeanette F. Craver; 7:45, Talk, for University of Oregon Agricultural College extension service.

KHJ, Los Angeles, Calif. (Pacific, 395), 12:30-1:15 p. m. Concert, presenting Major and his Orchestra, of The Hendersons, Ocean Park, Paul Ford, bassist; 2:30-3:30, Matinee Musical, through courtesy of South-

Headliners of the Week

JANE ADDAMS, the founder of Hull House, will talk over WMAQ *Thursday* night on her recent travels in the Orient. Miss Addams has many interesting stories to tell about the people of India, Philippines, China, and Japan. On this same night the unseen composers of the startling black headlines of the New York Times will give a band concert at WJZ. Let us hope they do not shriek as badly as some of those same headlines mentioned above.

Perhaps you did not know that WTAM's studio director is a talented person and once appeared upon the stage. He will give a one-act playlet, entitled "The Littlest Girl," on *Wednesday*. Speaking of the stage, two famous members of the silent drama world, Mary and Doug, will talk over WJZ on this same evening. Before leaving this already famous night do not forget the Spanish lessons beginning at KYW.

Thursday a real Mexican, Jose Arias, will present a Mexican program at KEJ. Mexico is much more of an art center than the rest of the world knows. WJAZ offers "The Medinah Chapters" without comment.

Friday is General Electric night at WGY. Nowadays it seems to be required that all bank employees, railroad conductors, and office help be musicians of the voice or instrument if it is nothing more than a drum. Can you imagine the modern employment office trying out help? It is no wonder the movies are so popular.

WSB proudly announces its second birthday *Saturday*. Many pioneer Radio stars of Dixie will perform, that is if they can hobble to the microphone.

Monday is St. Patrick's day and all the air will be filled with Irish melodies and talks. Perhaps even the other waves will turn green for the occasion.

WOAW, Omaha, Neb. (Central, 326), 6:30 p. m. Dinner program, Carl Leman's Orchestra; 9:00, Program, Omaha Chapter of Isaac Walton League; Harry E. Fitch, director; Concord Club Saxophone Band; Florence Alexander Steinberg, whistler; "Bird Muechery," Hour Music; "Five Minutes in a Duck Habitat," Gene Ogden; Mrs. Perry Ross, pianist; "Necessity of Preservation of Fish and Game and Other Features of Out-Door Life in Our State," The Isaac Walton League, Its Program and Purposes, J. J. Dunn.

WOC, Davenport, Iowa (Central, 484), 12:30 m. Chimes; 3:30 p. m., "Poplin' Dicks," A. G. Hinns; 5:45, Chimes.

WOO, Philadelphia, Pa. (Eastern, 509), 11:00 a. m. Organ recital, Harry E. Vogt; 12:30 p. m., Wagoner Crystal Tea Room Orchestra; 4:45, Organ recital, Harry E. Vogt.

WOR, Newark, N. J. (Eastern, 465), 2:30-2:45 p. m. Recital by Emma de Leon-Leonard, soprano; 2:45-3:00, Readings, Mildred Welch; 3:00-3:30, Recital by Emma de Leon-Leonard; 3:45-4:00, Readings, Mildred Welch; 6:45-7:30, "Mama White You Dine," Halsey Miller and His Orchestra; 8:30-9:00, Mamie Lee Meon Stories for Children; 7:00-7:15, "Mama White You Dine."

WOS, Jefferson City, Mo. (Central, 443), 8:00 p. m. "The First Week of a Young Annual's Life," E. A. Troutbridge; 8:30, Old Time Fiddlers Trio, Louis Barton, lead fiddler; George Schriener, bass fiddler; Bryan Williams, guitarist.

WSB, Atlanta, Ga. (Central, 429), 12:30-1:30 p. m. "Glorious Dixie Concert," descriptive novelty, Atlanta Municipal Band, Chas. Barber, director; 4:00-4:30, Howard Heaster, clarinet and piano; 5:00-5:30, William DeWitt's Home of Home messages; 5:30, Leonard Larchabal's songs and bed time story; 8:00-8:30, Annual ball and celebration, Atlanta Federation of Musicians; 10:45-11:45, Finale of annual ball and celebration.



Ladies first, Catharine Westerveld, left, "The Market Lady," sets the grain price clock regularly at WLAC, Cutting and Washington, Twin Cities. Reports are furnished by the Northwest National Bank and Minneapolis Loan and Trust company. WDAF, Philadelphia, Pa. (Eastern, 395), 11:45 a. m. Daily Almanac; 12:02 p. m., Organ recital, Stanley Theater; 12:30, Arcadia Cafe Concert Orchestra; 2:05-2:30, Arcadia Cafe Concert Orchestra; 7:30, Dream Daddy's bedtime stories; 7:50, Play review by Arnold Albol.

WFAA, Dallas, Texas (Central, 476), 12:30-1:00 p. m. Address, DeWitt McMurtry; 8:30-9:30, Trip Club of Dallas, Mrs. Maymo E. Wynne, director; 11:00-12:00, Circle Theater Orchestra, George W. Caldwell, director.

WFI, Philadelphia, Pa. (Eastern, 395), 1:00 p. m. Meyer Davis Bellows Stratford Concert Orchestra; 3:00, John Owens, tenor; 6:00, "Sunny Jim, the Kiddie's pal"; 8:30, Mervyn Davis Bellows Stratford Orchestra; 10:10, Charlie Kerr and his Symphonic Circle Orchestra.

WFB, Buffalo, N. Y. (Eastern, 319), 12:30-1:00 p. m. George Albert Bouchard, organist; 2:30-3:00, The Radio Deafens' Musical Program; 4:30, Ten line music; 6:30-7:30, Vincent Lopez Hotel Slaters Orchestra; 7:50, Digest of the day's news; 8:00, Lecture, "The Frolic Pressure Method of Respiration," W. G. Schenectady, N. Y. (Eastern, 380), 2:00 p. m. "Lectures of the 19th Century," Mrs. Charles A. Simon; 6:30, Dinner music, Instrumental Trio of Hotel Ten Eyck; 7:45, Georgia Minstrel Boys; WGY, Troy, N. Y. (Eastern, 360), 8:00 p. m. Concert by the faculty of the school of music, University of Iowa.

WHAS, Louisville, Ky. (Central, 400), 4:30-5:00 p. m. Selections, Strand Theater Orchestra, Alamo Theater organ; 7:30-9:00, Alamo Theater organ; 8:00-9:00, Reading, An interesting historical episode.

WHN, New York, N. Y. (Eastern, 360), 2:15-2:45 p. m. Edw. B. Mayer; 3:45-4:30, Bob Schuch and his Entertainers, assisted by the Original Georgia Fines; 5:30-5:15, Victor Weber, baritone; 5:15-5:30, Maria Kimball, dramatic soprano; 9:30-10:00, Fletcher Henderson and his Alabam Club Orchestra; 10:40-10:50, Shapiro Berastin Program; 10:45-11:15, "Inadequate Society Dance Orchestra, Morty Konigsberg, leader; 11:30-12:00, The Three Stars of Carlisle's Seven at the Selwyn.

WIP, Philadelphia, Pa. (Eastern, 509), 1:00 p. m. Organ recital, Karl Bonowitz; 6:55, Dick Regan and his WIP Symphony Orchestra from Rocky's Cafe; 7:30, Uncle Wip's bedtime stories; 10:15, Tod Weems and his Cafe L'Alston Orchestra.

ern California Music Company; 6:45-7:30, Children's Hour, Weekly visit of The Sandman and Queen Phantas; 8:00-10:00, Program presenting Harry James Heardsley, known as "Uncle Jim"; "The Stone that Turns Everything to Gold," Dr. Thomas Lutzman, lecturer; 10:00-12:00, Art Hickman's Orchestra.

KPO, San Francisco, Calif. (Pacific, 423), 1:00-2:00 p. m. Rudy Selzer's Fairmont Hotel Orchestra; 2:30-3:30, Matinee program, Edna Wilson, soprano; Maude McPaul, accompanist; 4:30-5:30, Rudy Selzer's Fairmont Hotel Orchestra; 6:30-8:30, Children's hour, "Big Brother" of KPO, Book of Knowledge, Frances Wiener, columnist; 7:30-8:00, Rudy Selzer's Fairmont Hotel Orchestra; 8:00-10:00, Adolphian Club of Alameda; 10:00-11:00, E. Max Bradfield's Palaco Hotel Danco Orchestra.

KSD, St. Louis, Mo. (Central, 546), 8:00 p. m. Mrs. Evelyn D. Freley, soprano; Mrs. May Parker, Mezzo-soprano; Edw. E. Foy, soprano; Mrs. Lily Cantov, pianist; Edna Noble, pianist; Charles Stocker, Jr., E. Dunnett Reynolds; 11:30, Mrs. Carroll Smith, soprano; Agnes Gray, violonist; Vernon Henning, pianist.

KYW, Chicago, Ill. (Central, 538), 11:25 a. m. Tablo talk, Mrs. Anna J. Peterson; 2:35-3:30 p. m., Studio program; 5:50, Children's bedtime story; 7:00-7:30, Joska DeBary and his orchestra; Clyde Doer and his orchestra; 8:45-9:30, Lecture on the instruments of the orchestra, Morgan L. Zanarano, musical director; Lecture demonstrated by solo on each instrument.

WDR, Fort Worth, Texas (Central, 476), 7:30-8:30 p. m. Concert, Texas Women's College; 8:30-10:45, Concert, Municipal Band of Slaton.

WSAW, Columbus, Ga. (Central, 390), 12:30 m. News bulletin from Columbia Dispatch; Piano music, Ha Lebergh Ombus.

WZZ, Springfield, Mass. (Eastern, 337), 7:30 p. m. "The Art of Investment," Donald McClellan; 7:30, Bedtime story for the Kiddies; 7:30-8:30, Mrs. A. Adams, pianist; Edna Noble, pianist; 8:35, Story for grown-ups, Orson S. Marden.

WAE, Pittsburgh, Pa. (Eastern, 462), 4:30 p. m. The Sunshine City; 6:30, Dinner concert, William Penn Hotel; 7:30, Uncle "Kicker"; 7:45, Lew Kennedy, popular singer; Irene Seider, accompanist; 8:30, Harlowe Rosen, pianist.

WAL, Northfield, Minn. (Central, 360), 9:45 a. m. Church services; 10:30 p. m., Program, Northfield Lions Club; "The Northfield Community," Arthur O. Lee; "The Jesse James Raid," Charles H. Fox; The Lones Quartette; Dr. J. Maser, soloist.

WDAF, Kansas City, Mo. (Central, 411), 3:30-4:30 p. m. Joseph Bick's Sexton City Concert Orchestra; 6:00-7:00, School of the Air Triana dining in number on the Duo-Art; Traveleco, E. O. Moffet; Address, J. Frank Smith; Children's story and information period; Fritz Healer's Triton Ensemble; 11:45-1:00

a. m. Nighthawk Folio, "Merry Old Chief," and the Conn-Sanders Novelty-Singing Orchestra.

WGAJ, Chicago (Central, 380), 7:30-8:30, Diska Concert Ensemble and Blackstone String Quartet; 8:30-8:50, Barton Organ played by Ralph Emerson; 10:00, Program furnished by John Louis Cook, Jack Querman's Orchestra.

WDAF, Philadelphia, Pa. (Eastern, 395), 11:45 a. m. Daily Almanac; 12:02 p. m., Organ recital, Stanley Theater; 12:30, Arcadia Cafe Concert Orchestra; 2:05-2:30, Arcadia Cafe Concert Orchestra; 7:30, Dream Daddy's bedtime stories; 7:50, Play review by Arnold Albol.

WFAA, Dallas, Texas (Central, 476), 12:30-1:00 p. m. Address, DeWitt McMurtry; 8:30-9:30, Trip Club of Dallas, Mrs. Maymo E. Wynne, director; 11:00-12:00, Circle Theater Orchestra, George W. Caldwell, director.

WFI, Philadelphia, Pa. (Eastern, 395), 1:00 p. m. Meyer Davis Bellows Stratford Concert Orchestra; 3:00, John Owens, tenor; 6:00, "Sunny Jim, the Kiddie's pal"; 8:30, Mervyn Davis Bellows Stratford Orchestra; 10:10, Charlie Kerr and his Symphonic Circle Orchestra.

WFB, Buffalo, N. Y. (Eastern, 319), 12:30-1:00 p. m. George Albert Bouchard, organist; 2:30-3:00, The Radio Deafens' Musical Program; 4:30, Ten line music; 6:30-7:30, Vincent Lopez Hotel Slaters Orchestra; 7:50, Digest of the day's news; 8:00, Lecture, "The Frolic Pressure Method of Respiration," W. G. Schenectady, N. Y. (Eastern, 380), 2:00 p. m. "Lectures of the 19th Century," Mrs. Charles A. Simon; 6:30, Dinner music, Instrumental Trio of Hotel Ten Eyck; 7:45, Georgia Minstrel Boys; WGY, Troy, N. Y. (Eastern, 360), 8:00 p. m. Concert by the faculty of the school of music, University of Iowa.

WHAS, Louisville, Ky. (Central, 400), 4:30-5:00 p. m. Selections, Strand Theater Orchestra, Alamo Theater organ; 7:30-9:00, Alamo Theater organ; 8:00-9:00, Reading, An interesting historical episode.

WHN, New York, N. Y. (Eastern, 360), 2:15-2:45 p. m. Edw. B. Mayer; 3:45-4:30, Bob Schuch and his Entertainers, assisted by the Original Georgia Fines; 5:30-5:15, Victor Weber, baritone; 5:15-5:30, Maria Kimball, dramatic soprano; 9:30-10:00, Fletcher Henderson and his Alabam Club Orchestra; 10:40-10:50, Shapiro Berastin Program; 10:45-11:15, "Inadequate Society Dance Orchestra, Morty Konigsberg, leader; 11:30-12:00, The Three Stars of Carlisle's Seven at the Selwyn.

WIP, Philadelphia, Pa. (Eastern, 509), 1:00 p. m. Organ recital, Karl Bonowitz; 6:55, Dick Regan and his WIP Symphony Orchestra from Rocky's Cafe; 7:30, Uncle Wip's bedtime stories; 10:15, Tod Weems and his Cafe L'Alston Orchestra.

WJAX, Cleveland, Ohio (Eastern, 330), Program arranged by the Cleveland NEWS-LEADER, 7:30 p. m. Bedtime story by E. G. Johnson; Selected numbers by the Cleveland Zither Club; direction Prof. Henry Wormschke; Program of selections by the Cleveland Singing Society, direction of Conde Delaney; Partitone solo numbers, Nathan Deitarsack; Quartette selections and solos, Big Brothers Quartette; Dance and popular selections, the Serenades Orchestra.

WJAZ, Chicago, Ill. (Central, 448), 10:00 p. m. 1:00 p. m., Hilarious Lecture, soprano; William Dillon, baritone; Amanda E. Gurney, pianist; Orpheo Orchestra.

WJY, New York, N. Y. (Eastern, 495), 7:45 p. m. Improvisations, E. Maurice Merford; 8:15, Clara Du Val, soprano; Lorna Lee, accompanist; 8:30, A Review of Plays, Martha Braumard; 8:45, Clara Du Val, soprano; 9:00, Concert, New York Blues Band; 10:00, Ellsworth B. Moss, baritone; Herbert E. Retzer, tenor.

WJZ, New York, N. Y. (Eastern, 455), 1:00 p. m. Luncheon concert, Hotel Ambassador; 2:30, New York City Board of Education; 3:00, Afternoon Auditorium Concert; 4:00, Harpers' Jazzier Fashions; 4:15, "Right Habits of Reading," Prof. Howard R. Briggs; 4:30, Grace Farner, soprano; 5:00, "The Home Beautiful," Dorothy Ethel Welch; 5:15, Grace Farner, soprano; 7:00, "The Characteristics of a Super-Exposition," James Marshall; 7:15, Super-pop music, Paul Specht's American Hotel Orchestra; 8:15, American Orchestra; 9:45, Abigail E. Benator, soprano; 10:30, Dance program, Hotel Astor Grill Orchestra.

WLW, Cincinnati, Ohio (Central, 399), 4:00 p. m. Topics of Interest to Women; 10:00, Program, arranged by Mrs. Leonard Virginia Schwab, assisted Mrs. Ralph Reed Taylor; Quartette; Edward Newcomb, pianist; David Douglas, violinist; Margaret Adams, pianist; Reading, "The Face on the Plow," Inaugural; Lockwood's Society Orchestra.

WMAQ, Chicago, Ill. (Central, 447.5), 2:35 p. m. Leon & Healy program; 4:30, Items of interest to women; 4:30, Pupils, Glenn DuHart Gunn School of Music; 6:30, Weekly Child Life hour, Margaret Barrows, assistant editor; 7:00, Travel talk, Clara E. Laughlin; Jane Addams' "Rocked Oldie" poems, Abigail E. Benator; 8:00, Talk, Harry Hanson, literary editor of The Daily News; 8:40, LaSalle Orchestra; 9:00, Leon & Healy program.

WMO, Memphis, Tenn. (Central, 500), 8:30 p. m. Concert, Mrs. Ed Neel and other artists; 11:00, Concert night folio, Hines Tennesseeans; A. G. Hines, director.

WMAW, Omaha, Neb. (Central, 326), 6:30 p. m. Dinner program, Carl Leman's Orchestra; 9:00, Program, Omaha Chapter of Isaac Walton League; Harry E. Fitch, director; Concord Club Saxophone Band; Florence Alexander Steinberg, whistler; "Bird Muechery," Hour Music; "Five Minutes in a Duck Habitat," Gene Ogden; Mrs. Perry Ross, pianist; "Necessity of Preservation of Fish and Game and Other Features of Out-Door Life in Our State," The Isaac Walton League, Its Program and Purposes, J. J. Dunn.

WOC, Davenport, Iowa (Central, 484), 12:30 m. Chimes; 3:30 p. m., "Poplin' Dicks," A. G. Hinns; 5:45, Chimes.

WOO, Philadelphia, Pa. (Eastern, 509), 11:00 a. m. Organ recital, Harry E. Vogt; 12:30 p. m., Wagoner Crystal Tea Room Orchestra; 4:45, Organ recital, Harry E. Vogt.

WOR, Newark, N. J. (Eastern, 465), 2:30-2:45 p. m. Recital by Emma de Leon-Leonard, soprano; 2:45-3:00, Readings, Mildred Welch; 3:00-3:30, Recital by Emma de Leon-Leonard; 3:45-4:00, Readings, Mildred Welch; 6:45-7:30, "Mama White You Dine," Halsey Miller and His Orchestra; 8:30-9:00, Mamie Lee Meon Stories for Children; 7:00-7:15, "Mama White You Dine."

WOS, Jefferson City, Mo. (Central, 443), 8:00 p. m. "The First Week of a Young Annual's Life," E. A. Troutbridge; 8:30, Old Time Fiddlers Trio, Louis Barton, lead fiddler; George Schriener, bass fiddler; Bryan Williams, guitarist.

WSB, Atlanta, Ga. (Central, 429), 12:30-1:30 p. m. "Glorious Dixie Concert," descriptive novelty, Atlanta Municipal Band, Chas. Barber, director; 4:00-4:30, Howard Heaster, clarinet and piano; 5:00-5:30, William DeWitt's Home of Home messages; 5:30, Leonard Larchabal's songs and bed time story; 8:00-8:30, Annual ball and celebration, Atlanta Federation of Musicians; 10:45-11:45, Finale of annual ball and celebration.

WZL, Los Angeles, Calif. (Pacific, 278), 5:30-4:30 p. m. Special music and read for "Saut-Ins"; 7:00-7:30, Children's Bible story; 8:00-9:30, Musical program and sermon by Anne Harlowe McPherson.

KGO, Oakland, Calif. (Pacific, 312), 8:00 p. m. "Intimate Stanzas," Barbara Pieters, soprano; Noble Burnham in triple role; Ison Trio.

KGW, Portland, Ore. (Pacific, 492), 12:30 p. m. Concert, Civic Club of Portland; 5:30, Talk, Jeanette F. Craver; 7:45, Talk, for University of Oregon Agricultural College extension service.

KHJ, Los Angeles, Calif. (Pacific, 395), 12:30-1:15 p. m. Concert, presenting Major and his Orchestra, of The Hendersons, Ocean Park, Paul Ford, bassist; 2:30-3:30, Matinee Musical, through courtesy of South-

Wednesday, March 12

CRAC, Montreal, Can. (Eastern, 423), 12:30 p. m. Rex Bell and His M. Royal Hotel Orchestra; 4:30, M. Royal Hotel Danco Orchestra.

KDKA, E. Pittsburgh, Pa. (Eastern, 326), 12:10 p. m. Danbury's Orchestra; 8:15, Dinner concert, Pittsburgh Athletic Association Orchestra; 8:30, Address, Mrs. S. V. Barton; 8:45, "Riding the Waves Abroad," The Steamship Park, Omaha Lattis; 8:50, Concert, Tri-State Concert Company, Virginia Higgins, soprano; Mrs. Edward Post Bate, contralto; N. E. J. Mucus, tenor; Joseph A. Rogers, baritone; Mrs. M. A. Mucus, pianist; 9:00, Children's program; 9:30, KDKA program.

KFSG, Los Angeles, Calif. (Pacific, 278), 5:30-4:30 p. m. Special music and read for "Saut-Ins"; 7:00-7:30, Children's Bible story; 8:00-9:30, Musical program and sermon by Anne Harlowe McPherson.

KGO, Oakland, Calif. (Pacific, 312), 8:00 p. m. "Intimate Stanzas," Barbara Pieters, soprano; Noble Burnham in triple role; Ison Trio.

KGW, Portland, Ore. (Pacific, 492), 12:30 p. m. Concert, Civic Club of Portland; 5:30, Talk, Jeanette F. Craver; 7:45, Talk, for University of Oregon Agricultural College extension service.

KHJ, Los Angeles, Calif. (Pacific, 395), 12:30-1:15 p. m. Concert, presenting Major and his Orchestra, of The Hendersons, Ocean Park, Paul Ford, bassist; 2:30-3:30, Matinee Musical, through courtesy of South-

Saturday, March 15

(Continued from page 17)

WSB, Atlanta, Ga. (Central, 429), 12:00-1:00 p. m., WSB's second birthday special entertainment; 4:00-4:30, Howard theater feature and program; 5:00-5:30, Special birthday program; 5:30, Bonnie Barnard's songs and bedtime story; 8:00-9:00, WSB's second birthday concert, featuring pioneer radio stars of Dixie, Mrs. James E. Whitten, soprano; Solon Druckenmiller, tenor; Dr. Charles A. Shelton, organist; 10:45-11:05, WSB's second birthday radio concert broadcast, featuring Bonnie Barnard, "The Lady of the Radio"; Ernest Rogers, "Jazzing" singer; Ernest Auld and Shouk Wili Calhoun, "Jazzing" singer-guitar duet; Jess Johnson, "Jazzing" singer.

Sunday, March 16

CKAC, Montreal, Can. (Eastern, 425), 4:30 p. m., Sacred concert.
KFAE, Pullman, Wash. (Pacific, 330), 7:30 p. m., "Zoo Graffiti," Fred M. Morris, "Days of a Summer Day," Prof. W. T. Shaw, Pullman High School Orchestra; "Some New Plant Diseases," Prof. G. L. Zimmler; "The Importance of Correct Diet in Fish-raising," Prof. E. B. Parker; Vocal solos, Agnes B.
KFI, Los Angeles, Calif. (Pacific, 483), 10:00-10:45 a. m., Service by L. A. Church Federation; 4:00-5:00 p. m., Vesper service by Church Federation; 8:45-9:30, Concert and bedtime story; 10:30-11:00, Concert by Theron Bennett's Parkland B.
KFKX, Redding, Neb. (Central, 341), Rehearsal KDKA program.
KFSK, Los Angeles, Calif. (Pacific, 279), Eastern Church services, 10:30-12:30 p. m., 2:30-5:00 p. m., 7:30-9:00 p. m.
KGL, Los Angeles, Calif. (Pacific, 395), 10:00 a. m., Service; 10:30-12:30 p. m., Organ recital and entire service from First M. E. Church, Rev. E. E. Helms, pastor; Arthur Blakely, organist; 2:30-5:00 p. m., Lusa Program.
KPD, San Francisco, Calif. (Pacific, 423), 11:00-12:00 p. m., Radio church services, auspices of the American Bible Society; Mrs. Diner G. Smith, mezzo-soprano; Theodore E. Cummings, organist; 2:30-3:00, Concert, Rudy Seiger and his Fairmont Hotel Orchestra.
KYW, Chicago, Ill. (Central, 336), 11:00 a. m., Central Church services, Dr. F. N. Shaanon, pastor; 2:30 p. m., Studio Church services, Dr. F. N. Shaanon, pastor; 7:00, Chicago Sunday Evening Club, Albert Tracoe, pianist.
WBAP, Fort Worth, Texas (Central, 476), 11:00-12:15 p. m., Church services, First Methodist Church, Rev. J. W. Beaman, pastor; 4:00-5:00, Address, Rev. J. Francis Norris; 8:00-12:00, Night program, featuring Fred Cagon's WPA Southern Serenades Orchestra.
WDAF, Kansas City, Mo. (Central, 411), 4:30-5:00 p. m., Program.
WDAP, Chicago (Central, 360), 5:00-5:30, Boston Organ recital played by Ralph Tomason; 6:15 p. m., Radio Bible Class, Dr. William Anderson; 7:30-8:30, Service, City Temple Presbyterian Church, Dr. L. M. Young, pastor; 8:30-9:30, "Christians in a Social Force," Dr. Thomas E. Harper; 9:30-11:00, Popular music, Jimmy Athley's Serenades.

WFI, Philadelphia, Pa. (Eastern, 395), 7:30 p. m., Services Arch Street Presbyterian Church.
WGI, Bedford Hills, Mass. (Eastern, 360), 4:00 p. m., Twilight program, "Adventure Hour," Youth's Organization; Musical; 8:30, "World Unity," Greater Boston Federation of Churches; Concert, Francis C. V.
WGR, Buffalo, N. Y. (Eastern, 319), 8:00 p. m., Vesper service, the Rev. John Knox Tibbitts, St. Louis's Episcopal Church.
WGY, Schenectady, N. Y. (Eastern, 360), 10:30 a. m., First Dutch Reformed Church of Schenectady, Rev. Clayton J. Peacor; 2:30 p. m., WGY Symphony Orchestra; Edward E. St. Louis, baritone; 7:30, Service, First Reformed Church.
WHAS, Louisville, Ky. (Central, 406), 9:57 a. m., Organ music; 11:00, Church services, auspices of the Beechmont Methodist Church, Rev. Dr. B. C. Horton, pastor; 4:00-5:00 p. m., Concert, auspices of All Saints Wesleyan Church.
WHK, Cleveland, Ohio (Eastern, 283), 4:30 p. m., Vesper service, the Rev. A. B. Limoux, pastor Glenview Presbyterian Church; choral music by the church choir; 8:00, Concert, program by the WHK Orchestra.
WNY, New York, N. Y. (Eastern, 360), 3:00-4:30 p. m., Christian Endeavor Program; 4:55-5:30, W. H. N., Radio Fire; 9:30-9:45, John J. Leavary in vocal concert.
WIP, Philadelphia, Pa. (Eastern, 463), 11:00 a. m., Musical program, "The Story of Tompkins," recital; 4:00 p. m., Organist, W. M. C. A. meeting.
WJAZ, Chicago, Ill. (Central, 448), 9:00-9:50 p. m., Musical program, Dr. Frank Stevenson; 7:45 p. m., Services of the Church of the Covenant, Dr. Frank Stevenson, minister.
WOC, Des Moines, Iowa (Central, 484), 9:00 a. m., Sacred chimes concert; 1:30 p. m., P. S. C. Orchestra; 7:00, Pipe organ recital, First Church service; 9:30, Musical program, Edwin Snodgrass, director.
WOS, Jefferson City, Mo. (Central, 440, 9), 7:30 p. m., Church service, First Christian Church; Robert M. Tabor, cantor; Prof. Solbert Price, organist; Mrs. Fred Reagle, violinist.
WPT, Philadelphia, Pa. (Eastern, 429), 11:00 a. m., First Presbyterian Church service, Rev. J. Sprule Lyons, pastor; 5:00-8:00 p. m., Sabbath twilight studio, Methodist Church, Rev. P. E. Harris, pastor; 7:30-8:00, Wesley Memorial M. E. Church service, Rev. Marvin Williams, pastor; Mr. and Mrs. A. C. Doan, musical directors.

Monday, March 17

CKAC, Montreal, Can. (Eastern, 425), 1:45 p. m., Mt. Royal Hotel Concert Orchestra; 4:30, Mt. Royal Hotel Dance Orchestra.
KFKX, Redding, Neb. (Central, 341), 9:30 p. m., Kearney State Teachers' College program.
KJL, Los Angeles, Calif. (Pacific, 395), 12:30-1:15 KPD, San Francisco, Calif. (Pacific, 423), 1:00-3:00 p. m., Rudy Seiger's Fairmont Hotel Orchestra; 3:30-3:50, Matinee program, Clyde N. White, baritone; Mrs. Clyde N. White, accompanist; 4:30-5:00, Rudy Seiger's Fairmont Hotel Orchestra; 5:30-6:30, Children's hour, stories for children by "Big Brother" of EPO, Book of Numbers; 7:00-8:00, Rudy Seiger's Fairmont Hotel Orchestra; 8:00-9:00, Theodore John Irwin, organist; 9:30-10:00, St. Patrick's Day program, Edwin W. Hutton, tenor; Speaker, Matthew A. McCullough; 10:00-11:00, E. Max Bradfield's Palace Hotel Dance Orchestra.
WAAA, Newark, N. J. (Eastern, 253), 7:30-7:45 p. m., "Star Spangled Banner," James V. Moore and His Chorus Club; 8:00-8:15, "The Current Motion Pictures," by Alton Holton Evans, Sec'y of Natl. Committee for Better Films; 8:15-8:30, "Continuation" program by Alton Holton Evans; 8:30-9:00, Times Square WAAN Dance Orchestra; 9:30-10:00, Times Square Entertainers; 10:00-10:15, "Underground with the

Red," talk by Allen O. Myers, chief investigator for the Burns Detective Agency of conditions in Soviet Russia; 10:15-10:30, Maurice Sneed, tenor; 10:30-10:45, "The Crossings," Cecil Hill, Wm. Atkinson, pianist, assisted by Johnson and Johnson, exclusive Carnegie recital artist; 10:45-11:15, First Eastern Radio appearance of Hume Gibson, saxophonist, and Jabel Johnson Gibson; 11:15-11:30, Vincent Rowell Strutz, concert pianist.
WAAW, Omaha, Neb. (Central, 360), 8:00 p. m., Program, auspices of Latin Saints Church, Council Bluffs, Ia.
WBAP, Fort Worth, Texas (Central, 476), 7:30-8:30 p. m., Organ music, St. Paul's Episcopal Church, Rev. St. Patrick's Day; 9:30-10:45, Orchestra and band, Old Fellows Organists.
WBIV, Columbus, Ohio (Central, 390), 13 m., News bulletins from Columbus Dispatch; Piano music, Ira Lorchach organist; 8:00-10:00 p. m., Concert, WBIV Orchestra, conducted by Miss Frances Mandelbaum.
WCBZ, Zion, Ill. (Central, 345), 8:30 p. m., Concert music, Mrs. Saige Erlene Smith, reader; Vocal duet, Edith Carey, Mrs. Dorothy Cary LeBlanc; Glenn H. Sparrow, tenor; Mrs. J. E. Mayfield, soprano; Concert duet, Newcomer, Mason; J. L. Hilday, baritone.
WDA, Kansas City, Mo. (Central, 411), 2:30-3:50 p. m., Musical matinee; 6:00-7:00, School of the Air, Piano tuning-in number on the Duo-Art; Address: Children's story and information period; Fritz Henlein's Triphon Ensemble; 8:00-9:15, Popular program; 11:30-1:00, "Merry Old Chief" and the Coon-Singers, Novelty Singing Orchestra.
WDAK, Philadelphia, Pa. (Eastern, 395), 11:45 a. m., Daily Almanac; 1:00-1:15, First Eastern Radio Orchestra; Organ recital, Stanton Theater; 2:00-3:00, Features from studio, Arcadia Cafe Concert Orchestra; 3:00-3:30, Viola Peters, pianist; 3:30-4:00, Talk by Robert Sherwood; 9:30-10:15, Walter Board and Charles DeBorja, radio duet.
WDF, Philadelphia, Pa. (Eastern, 395), 1:00 p. m., Meyer Davis Soling Matinee Orchestra; 5:00, "Sunny Jim, the Kidless Pup"; 8:30, Meyer Davis Soling Matinee Orchestra.
WDR, Buffalo, N. Y. (Eastern, 319), 12:30-1:00 p. m., George Albert Beachard, organist; 2:30-4:00, The Radio Digest's musical program; 7:30, Top time music; 8:30-1:30, Vincent Lopez Hotel Statler Orchestra; 7:30, Digest of the day's news; 9:00, Concert, direction J. P. Quinn.
WGY, Schenectady, N. Y. (Eastern, 360), 2:00 p. m., "Satisfactory Curtain and Diphthary Material," Modern Possibilities Harold Himmelfarb, pianist; Except from "Polly of the Circus," Mrs. C. Scott; Francis Jones, violinist; Address: "Time," Commander Joseph S. Evans; "Within the Law," Myra C. Scott; "Comforted," Myra C. Scott.
WHAS, Louisville, Ky. (Central, 406), 4:00-5:00 p. m., Walnut Theater Orchestra; Strand Theater Orchestra; "Mr. Dooley on St. Patrick's Day," Katherine Harmon.
WHAZ, Troy, N. Y. (Eastern, 380), 9:00 p. m., St. Patrick's Night concert, Irish songs and music; "Ireland Today," program, speaker, 9:30, Popular dance music, Blue Bird Ladies' Orchestra.
WHN, New York, N. Y. (Eastern, 360), 3:45-4:30 p. m., Irving Berlin Vocal Trio; 4:30-5:00, Hal Ballet's Island Orchestra; 8:15-8:45, Eugene Atkins and His

Capitol Palace Jazz Syncopators; 9:00-9:15, Harold Talt Wright, tenor; 9:15-10:00, Dan Gregory and His Dancin' Central; 10:15-10:45, The Broadway Musical Artists; John H. Williams, William Morgan Evans, second violinist; Edward Kramer, violist; Walter Greenman, cellist; Solon Druckenmiller, soloist; Lucie; Orchestra, Cincinnati Symphony; "Patriotism," John B. Quinn; Talk on the Irish Free State, T. D. Devry; Address, Joseph O'Doherty; Proclamation, Grace Archibishop Henry Moshler; Rev. William F. O'Connor, will introduce National Commander Quinn; "America's Debt to Ireland," J. P. Cassidy; J. P. Galvin, Cincinnati Attorney, toastmaster.
WIC, Cincinnati, Tenn. (Central, 509), 8:30 p. m., Weekly reunion program, Gayoso Hotel Concert Orchestra, Prof. Gaspar Pappalardo, director.
WIO, Davenport, Iowa (Central, 464), 12:00 m., Chimes; 3:30 p. m., Lecture; 6:30, Chimes; 6:30, Sandman's visit; 7:00, Educational lecture; 8:30, Musical program, Edwin Steinlich, director; 10:00, Program.
WIP, Philadelphia, Pa. (Eastern, 500), 11:00 a. m., Organ recital, Mary B. Vogt; 12:03 p. m., Waaswander Organ Trio, Room Orchestra; 4:45, Organ recital, Mary B. Vogt; 7:30, Recital, Adolphus Concert Orchestra; 9:15, Fox Theater Orchestra, Tom Hance; 10:00, Organ recital, Mary B. Vogt; 10:30, Vincent Rizzo and Havana Orchestra from Hotel Sylvania.
WOP, Newark, N. J. (Eastern, 405), 2:30-2:45 p. m., St. Patrick's Day program; Joint Recital by Irish Arts and David A. Sheehan and Marie J. Kelly; 6:30-7:30, Henry Cox and His Royal Robert Treat Orchestra; 8:00-8:15, Mr. McTeague; "Human Motion Pictures"; 8:15-8:30, Recital by Herman Goldschlager; 8:30-8:45, Jolly Bill Scales of Newark Morning Ledger; 10:00-11:00, Manhattan Serenaders of New York.
WOS, Jefferson City, Mo. (Central, 440), 8:00 p. m., Regular musical program.
WSD, Atlanta, Ga. (Central, 429), 12:00-1:00 p. m., St. Patrick's Day entertainment; 4:30-5:30, Howard Theater feature and program; 5:00-5:30, Bonnie Barnard's songs and bedtime story; 8:00-9:00, St. Patrick's Day concert, Bill Royal Purple Band, Atlanta Lodge, No. 72, E. F. O. E.; 10:15-11:15, St. Patrick's Day concert; George McNulty, Irish tenor.

Broadcasting Station or Parts Wanted
Persons or firms able to supply parts or complete equipment for a high power broadcasting station, from 500 to 2,000 watts antenna input, will be interested in communicating with this box number. State what estimated costs are, and delivery dates, together with possibilities for installation. Box RD-31524, Radio Digest, 123 W. Madison St., Chicago, Ill.

THE De Forest name has been in the forefront of radio research for twenty-three years. De Forest invented the three-electrode vacuum tube which makes present-day radio possible. The sets and parts made today by the De Forest Company are worthy of the De Forest name.

DE FOREST RADIO TEL. & TEL. CO. Dept. R. D. 7 JERSEY CITY, N. J.

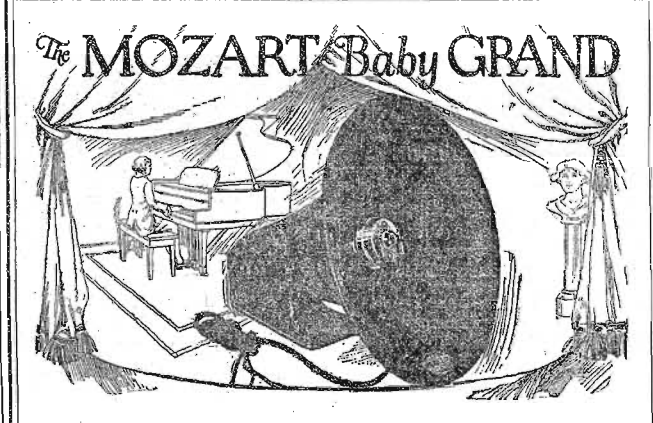

OUR new reproducer has been developed with a technical and practical care probably never previously bestowed on this class of merchandise. Its extraordinary reproducing qualities, its extremely low center of gravity with resultant steadiness and its general beauty of outline guarantee it a worthy place among all that is superlative in radio necessity today. The color scheme is black and gold. The unit and other fittings are heavily gold plated, the combination resulting in a charming effect which will harmonize perfectly with any furnishings from the simplest to the most pretentious.

Dimensions: Diameter of bell, 12"; height over all, 12 1/2"; length over all, 12 1/2". Weight: 4 lbs. (approx.)

Price complete with unit and cord, ready for attaching... \$11.25
West of the Rockies... \$12.00
Price of unit only, with cord, ready for attaching... 4.50

Sent direct, if your dealer has none in stock, upon receipt of purchase price and your dealer's name.

Communications by mail only. Addressed Radio Dept.

MOZART Baby GRAND
Manufacturers of Fine Instruments
NEWARK, N. J. U. S. A.

First Aid and Helpful Hints for Listeners In Chapter III—Operating and Constructional Suggestions

By Peter J. M. Clute

IT would be next to impossible to give definite operating instructions for each of the numerous varieties of receiving sets. However, vacuum tube receivers may be roughly divided into a few general classes, so that broad, comprehensive operating suggestions for each group will cover the field, due allowance being made for the characteristics and peculiarities of each particular set.

comb coils. Receivers containing such tuning devices are known as two-circuit receivers, a typical hook-up being given in Figure 2. In such receivers, the antenna and oscillating circuits are entirely separate, that is, no physical connection exists between them. Energy transfer is effected by the inductive relation between windings, the mutual inductance being variable from a minimum when the

stiveness of the vacuum tube, causing it to produce self-amplification.

Single-circuit and double-circuit vacuum tube receiving sets can be made regenerative by the addition of the so-called "tickler" coil, connected in the plate circuit and arranged to be in inductive relation to the tuning coil or secondary of the coupler, so as to feed back into the grid circuit. The two methods of feedback reception for producing the regenerative effect are the circuit making use of a tickler coil and the so-called "tuned plate" circuit. The diagram Figure 3 shows a feedback circuit using a tickler coil, with dotted connections indicating the alternative tuned plate circuit. In a regenerative circuit employing the tickler coil, the relative polarity between this coil and the secondary coil must be correct in order that the Radio frequency plate current may increase the strength of oscillations.

is quite uncertain, inasmuch as what one person may consider the proper brightness, another considers either too low or

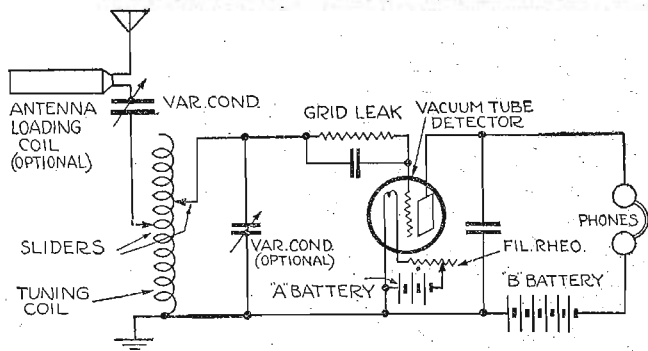

Figure 1.

In the single-circuit variety of non-regenerative receiver, a typical diagram of which is shown in Figure 1, tuning is accomplished by the use of a condenser and a tuning coil to obtain capacity and inductance in conveniently adjustable form; one or the other or both of these tuning devices being adjustable. A variable condenser in series in the antenna circuit permits tuning in shorter wave lengths. Additional antenna series loading inductance may be inserted when it is desired to receive waves greater than the natural wave length of the receiving aerial circuit, and fine adjustments may be made by means of the variable condenser. A condenser shunted across the

fields are "bucking," to a maximum when they are aiding. It is quite essential that the two windings be wound in the same direction, since the effectiveness of coupling is lessened if the fields are opposing.

Honeycomb coils, by reason of their convenient construction, may be used instead of couplers. These coils are wound with a bank winding in one direction, so arranged that one layer crosses the preceding one always at an angle, thus reducing distributed capacity to a minimum. The coupler effect may be had by using a mounting stand which permits moving the coils to and from each other. While each coil is fixed as regards wave length value, they can be used inter-

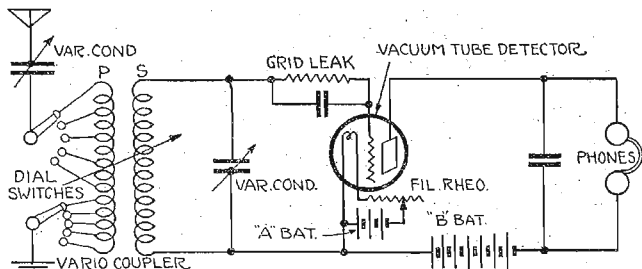

Figure 2.

tuning coil provides a means of increasing the wave length of the system in proportion to the amount of capacity used.

Fixed Step Tuning

The simplest types of receivers employ fixed step tuning, either by means of sliders or by the use of multipoint dial switches having contact points connected

changeably. This permits adjustment of wave lengths by unit steps, the fine tuning being accomplished by means of the variometer or variable condenser connected in the circuit.

Regenerative Action

In the types of receivers above considered the energy of the Radio frequency

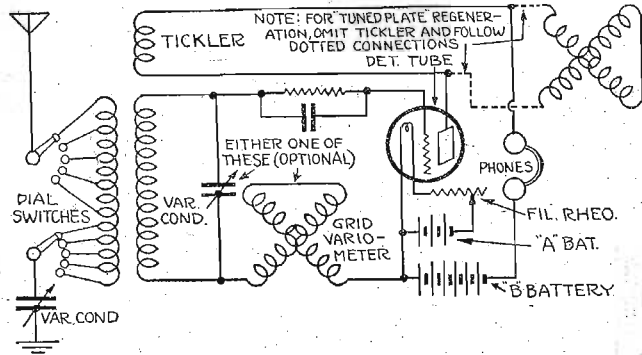

Figure 3.

so as to include fixed steps on the coil. When two such switches are used, one takes in groups of five to ten turns, while the other cuts in one turn at a time. If loud and clear signals are desired, sharper tuning is essential. Continuous variation of tuning is generally accomplished by using devices in which the relative motion of two windings change their mutual inductance, such as loose couplers, variocouplers and arrangements of honey-

oscillations has been brought directly to the detector, rectified and passed on to the telephone receivers. If the latter energy is partly re-impressed upon the grid of the detector tube, it will add quite a little to the incoming potential, in turn imparting a greater charge to the grid and thereby producing a larger variation in the plate current which results in much louder signals. This feedback or regenerative action greatly increases the sen-

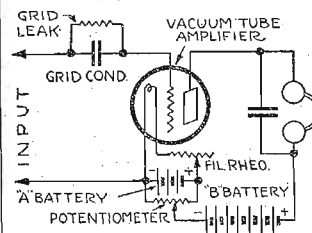

Figure 4.

two high. Although ammeters are sometimes used, the makers of vacuum tubes declare that best results are obtained when the filament current is regulated by using a voltmeter. If the potential at which the tube should be operated is not stamped on the tube itself or on its

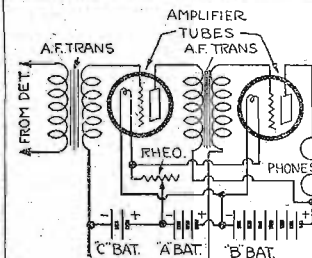

Figure 5.

container, the voltmeter should be connected across the filament circuit at the socket, and the rheostat adjusted so that the voltage reading is as low as practicable at the time the receiver is giving the loudest reproduction.

(Continued on page 22)

PROTECT YOURSELF

Use Instruments Experts Recommend THE ORIGINAL AUTOMATIC

COMSCO  COMSCO

BULL DOG GRIP TELEPHONE PLUG

(Licensed under Pat. Pend. Serial No. D 3010—No. 573540)

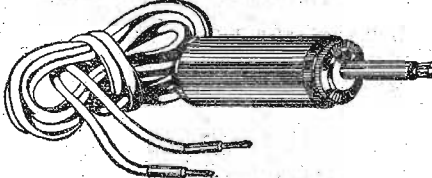

WE GUARANTEE

that this plug will not demagnetize your phones, ruin your transformers, short circuit your batteries, have battery kicks or break your finger nails. The COMSCO PLUG is the last link in perfect reception. At a small cost it is the final refinement for your set.

For One Pair Phones.....\$1.00

For Two Pair Phones..... 1.50

YOU CAN DEPEND ON THE COMSCO PLUG IT'S MADE BY THE MAKERS OF

COMSCO CONDENSERS

THE MOST INGENIOUS VARIABLE AIR CONDENSER EVER CONCEIVED. NO OUTSIDE SPRING CONNECTIONS—TRUE CAPACITIES.

AND BRONZE BUSHINGS FOR

PERMANENT CONTACT

ASK FOR COMSCO AT YOUR DEALER

Otherwise send purchase price direct to us and you will be supplied

GENERAL INSTRUMENT CORP.

123 Liberty Street NEW YORK CITY



Radio Digest

Illustrated

REG. U. S. PAT. OFF. AND DOM. OF CANADA

Published by the Radio Digest Publishing Company, Inc.
123 West Madison Street
Telephone: State 4843, 4844, 4845
Chicago, Illinois

E. C. RAYNER, Publisher

Chas. F. Smisor, Editor Evans E. Plummer, Managing Editor
H. J. Marx, Technical Editor M. W. Thompson, Associate Editor

Eastern Representative, Jacob Miller, Times Bldg., Times Square,
New York; Telephone Bryant 4969

Member of the Audit Bureau of Circulations

58

PUBLISHED WEEKLY

SUBSCRIPTION RATES

Yearly in U. S. and Possessions and Canada, \$5.00.
Foreign postage, \$1.00 additional. Single copies, 10 cents.

Vol. VIII Chicago, Saturday, March 15, 1924 No. 10

Try to Play Music at Your Lawn Fete

But Write Your Congressman Before You're Jailed
IF YOU were to give a lawn fete on the lawn of your home and were to have music played or sung in any fashion, mechanical even, you might soon find yourself in a serious legal battle with the American Society of Composers, Authors and Publishers.

They would probably say, "You are using musical compositions the copyrights for which are controlled by our members, and you are using them at a PUBLIC PERFORMANCE. Therefore, you must either pay us a license fee or stand the consequences. Our society is strong; it employs hundreds of attorneys from coast to coast. If you don't take out a license we will sue you."

Just because you were attempting to raise money to buy a new bell for the church, don't think your lawn fete's music wouldn't be subject to the applications of the copyright law as it now stands. Your lawn fete was a PUBLIC PERFORMANCE wasn't it? All right, you pay!

A misapplied law, misapplied accidentally or intentionally, can do much harm to persons and organizations for whom the law was never intended.

Hotels, motion picture theaters and broadcasting stations are suffering under the PUBLIC PERFORMANCE ruling of the present copyright law. This section of the law, intended originally to protect the song composer, is now protecting an army of A. S. C. A. P. attorneys who seek to collect fees from those they call "infringers."

Senator Dill of Washington and Representative Newton of Minnesota propose to amend the copyright law to forbid the owner of a copyright from exercising his restrictive powers further than the printed sheet. The printed sheet will provide enough royalties.

Senator Dill and Representative Newton would remove the control from use of music at PUBLIC PERFORMANCES, "whether for profit or not for profit, where such performance is made from printed or written sheets or reproducing devices issued under authority of the owner of the copyright, or by the use of radio or telephone or both."

Time is growing short. Congress will adjourn soon. Let's have ACTION.

Action can be secured if EVERY Radiophan writes his representative and senator in Washington. Eight million letters—put it in figures—8,000,000 letters should offset the most elaborate lobby money of the A.S.C.A.P. could buy to influence Congress against changing the law.

Write two letters—one to your senator and one to your representative—supporting the Dill-Newton bill. Write them today.

Artists Need Applause

Fault Is Yours if Programs Become Poor

BROADCASTING is threatened by the Radiophans themselves. Through their failure to send in "letter applause"—the only possible kind—stations are losing many of their best artists. When a singer, a musician, or a speaker appears before an audience there are usually two things which make his appearance and effort worth while.

One is that of pecuniary remuneration and the other is that satisfaction which comes from appreciation of his or her efforts, manifested by the applause of the audience. When one or both are lacking, there is certainly little incentive for the artist to do his or her best, or even to make an appearance.

Then, again, it is not only the artists who feel this dearth of what has been termed "applause letters" from listeners, but the operators of stations have begun to feel that their efforts are not appreciated, and there develops, consequently, a feeling that the fan does not care for the programs.

To make matters worse, some theatrical producers and associations, actors' associations, music publishers and others in control of available talent, have made restrictions governing the appearance of artists under contract and the rendition of copyrighted compositions.

If theatrical producers and music publishers could be convinced that the appearance of their stars and execution of their compositions at broadcasting stations are to their advantage, little difficulty would be experienced by program committees of broadcasting stations in obtaining the best of talent.

RADIO INDIGEST

The Rubiyat of a Radiophan

Now winter nights reviving old desires,
The Radiophan to solitude retires,
Where phonographs are dumb and sits him down
And tinkers with his tubes and tests his wires.

Static indeed is gone with all its woes,
But code comes in from where nobody knows;
Still, there is music in the air tonight,
And many a wave length wears its Sunday clothes.

I sent my Soul through the Invisible,
Some letter of the station calls to spell;
And by and by my Soul came back to me—
And said: "Say, 'bo; they sound like hell."

Each night a hundred jazz bands, more or less,
Mush up the air with weird harmonies—yes;
But still an artist may be heard at times,
And talks on what to read, or eat, or how to dress.

An aerial swinging from the topmost bough
Of sponder trees, a five-tube set, and Thou
Beside me—if Thou won't talk too much—
And we've a Radio paradise right here and now.

"How swell the super-heterodyne!" say some,
And others sigh for a super-supe to come;
Ah! Take a one-tube set and with due care
And careful tuning you'll be going some.

The new hook-up we set our hearts upon
Goes floozy, or it works and yet anon
We tear it down and build another one,
And yet another 'till our bankroll's gone.

And he who has the set that first he bought,
And changed it not, and for no other sought;
Well—he just ain't; that's all that can be said.
And never was—we'll add the afterthought.

And when, at last, the final dope is given,
And supernotebooks reach out to Heaven,
Perhaps we'll tune in on music of the spheres
Or hear the "Angel's Serenade" at seven.*

*Can't say if this is Eastern, Central or Mountain time;
Southern California will probably claim it as Pacific.
P. A. PRICE.

Tiaras, Wound to 3,001 Ohms, \$1.98

Dear Indi: Observed following by the "Lady Book Agent" in recent Chl. Dolly Nooz funny column, so borrowed it:

"My landlady asked me to join her in listening to grand opera over the Radio. She said, 'It is so clear that you can fancy you are sitting in the front row at the Auditorium.' Sez I, 'Then we won't have to wear tiaras?' Sez she, 'What is that?' Sez I 'Something to wear on your head.' Sez she, 'Oh, no, this has a loud speaker.'"

DIR-DIR DIR-DIR DIR-DIR

Wegottem

Two moth-balls, and
an unsigned note
By Parcels-post today,

Sez: Cactus, please
Do chew on these

"Twill keep the lies away."

CACTUS JACK.

E. Sa. P. Please Invent It

Dear Indi: I see in the February 16 issue of Indi-Gest that someone invents a way to catch up in distance records, but you tell that guy his invention won't work on my set cause I use a "book type" condenser which stops at "0" and "100" on my dial. Ask him to invent some way to annoy my neighbor with my set. C. C. S.

We Become a Matrimonial Bureau

Dear Indi: I understand that you desire to have the greatest Radio intellects contribute to your column. Being in that class (noise of clearing throat), I am inclosing a masterpiece which I have written after many years of study and experimentation.

The usual formula is that, had it not been for my loving wife, I never could have finished this great work—but I am a Radio widower, divorced because of Radio and my persuasion to finish this encyclopedia of Radio terms which will enlighten many darkened Radiophans.

Incidentally, being a Radio widower, I invite correspondence from Radio widows; object satisfactory matrimony. Candidates must qualify by sitting up till 3:00 a. m. to hear Honolulu. I. Noa Lorr.

Encyclopedia Indi-Gestiana

(Compiled by I. Noa Lorr.)

Amplifier.—A device necessary to make a loud squawker squawk.

Antenna.—That part of a Radio outfit that sticks up in the air or decorates the roof of a house, barn or what have you?

Battery.—The part that you have to buy every two weeks which usually costs a dollar and four bits.

Battery Charger.—A person who buys a battery and has it charged to his account.

Broadcasters.—Two old maids exchanging gossip across the back fence.

Broadcasting Station.—Any women's club meeting.

Close Coupling.—An action that takes place in an automobile when the man has one hand on the steering wheel.

Conductor.—A person who stands on the south end of a northbound street car and charges you seven or more cents to let other people walk on your feet.

Continuous Wave.—A wave that every flapper aspires to possess.

Dielectric.—Dielectric, meaning to be electrocuted. (See gunman; hanging.)

Dry Cell.—A room in the hoosegow hotel that doesn't leak when it rains.

Electromotive Force.—Using the self starter to run your flivver when the gas tank is empty.

Filament.—That part of a \$9 vacuum tube (See R.C.A.) which runs down your batteries and gives a nice white flash when it connects across the B battery.

Ground.—The place where your aerial lead-in touches the tin gutter on the roof. (Used extensively by beginners.)

Hook-Up.—Two people make a mistake and get a license.

Honeycomb Coil.—A lot of diamond-shaped holes with wire around them.

Hydrometer.—An instrument which shows you what a punk storage battery you bought.

Insulator.—The man who insulates another ditto.

Loud Squawker.—A calabash pipe-shaped device used to keep the neighbors awake with you.

Slider.—He who attempts to walk on the sidewalk when it is ice covered.

To Put His Story on the Air



Condensed

By DIELECTRIC

It would seem too charitable a thing to allow inmates of prisons to enjoy giving baud concerts before a "mike" at too frequent intervals. Missouri is to allow her prison band to broadcast through WOS but twice monthly hereafter. May be the amount of mail has increased beyond what the authorities can easily sort over. Perhaps a few false notes from the trombone would indicate to an accomplice in the "audience" an intention to break away from his evil surroundings. You never can tell.

Once again the voice of the President of the United States is carried far beyond the confines of the hall in which he speaks. While the thousand or more diners in New York listened to Mr. Coolidge's Lincoln Day speech, possibly a thousand times that number heard every word through loud speakers or headsets. A great many American citizens never see their chief executives. Very few, indeed, in this generation need be compelled to say they never heard one. In reading an address one is likely to misplace emphases; in hearing it, there can be no such mistakes. You have in Radio an easy access to jazz or classical entertainment; vaudeville or drama; comedians or presidential addresses.

Not long ago Station WGY broadcast proceedings at a banquet of world war veterans held in Albany, N. Y. On that occasion an address was delivered by John R. Quinn, national commander of the American Legion, which, it is said, was severely censored by the broadcasting station. Parts of the speech dealt with a bonus for the ex-soldiers and attacked Secretary Mellon for opposing the measure. Station KYW exercises a censorship over all addresses intended for broadcasting through that station. A question has arisen as to the propriety of managers of various studios establishing a policy of censorship, some contending against the right to determine what the Radio public shall be permitted to hear. Perhaps your views on this subject might be of interest to the various stations. Write in expressing yourself.

If you failed to tune in the station nearest you, on the night of February 8, broadcasting a wonderful exhibition of what may be done by combining Radiophony and telephony, you missed a startling demonstration. General Carty spoke in Chicago before the Bond Club and his words carried—we know not where! Several broadcasting stations in the East, West and in Cuba gave their audiences the opportunity to hear the managers of the San Francisco and Havana telephone offices talk to each other over a 5,000 mile trunk line; answers to the calls of General Carty to district managers in several states; a violin solo at Havana, and chimes and taps at San Francisco. It was difficult to realize that so soon after we heard Key West speak to Chicago we had actually jumped to Salt Lake City (without moving a dial)! That's what can be done.

Following the experiments to determine how successfully Radio broadcasting might be used to entertain railway passengers while en route, comes the news of applying this medium to bring closer together railway employer and employe. Programs have been received aboard rapidly moving trains so perfectly as to afford much enjoyment to those compelled to spend several days in a Pullman car. Sir Henry Thornton, chairman and president of the Canadian National Railway, conceived a plan whereby officials and employes of this system could understand the company's policies with least effort in reaching each one and the advantage of speech over the written word. Broadcasting stations are to be erected along the 22,000-mile system and receiving sets sold to employes at cost. This will bring the president and brakeman out of that atmosphere of cold aloofness, which helps to promote misunderstanding.

Meditations by the Inventor of King Miloplex

Part XXIII—Operation of Compound Wave Trap

By the Mystery Man

SOME time ago I was inveigled into accepting an invitation to act as valet to several Radio celebrities who were to address the Milwaukee section of the A. R. R. L., accepting after noting in particular that in payment for said valuable services the committee in charge of keeping us separated would see that

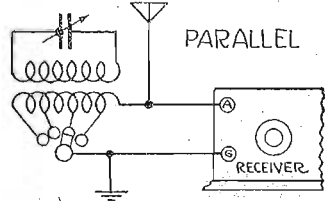

I "et"—or is it "ate"?—and further that said committee expected myself and those I allowed to come with me to spend only the day there.

Well, far be it from me to criticize, but I am sort of up in the air as to just when night falls in Milwaukee, or whether they are not sun dodgers, because when the chauffeur in one of my yellow limousines encooned (whatever "encooned" means) me at my abode for the balance of the day, the night clerk was trying to convince a guest that he was called at eight—I use the word guest advisedly, because you know a hotel always gets the big idea balled up.

How any hotel can call you a guest when you're paying six bucks for trying to sleep next to an elevator is beyond me. Maggie says, "Guest, me eye! We're customers!" and she knows. Besides, why pay a dollar an hour when billiards are only sixty cents? Economize, sleep on the pool table—oh, boy, there's a thousand ways to dodge being a guest! They tell me confidentially, though, that the only reason "Slim" Robinson at Willmette thinks so much of Maggie and so little

of me is because I didn't know any better than to wipe my ten little fingers on her guest towel; not that she cared so much, but the jam came when the laundry man confessed he thought the marks I left on it were a new hook-up and was trying it out on the back porch.

Rawden is maddening—those that make your trick circuits work want to kiss you; those who don't immediately apply for a permit to carry firearms and write me asking what size hole I prefer being buried in.

"As one very facetious undertaker wrote to me recently calling my attention to his advertisements in the street cars, which read, "Why walk around half dead when coffins are so cheap?" Which reminds me, "It isn't the cough that carries you off, it's the coffin they carry you off in," and as you no doubt are getting going on how to use the compound wave trap we finished last week, supposin' we forget the rattle of Radio bones and dig into it.

Using Compound Wave Trap
You who want to use it with a crystal

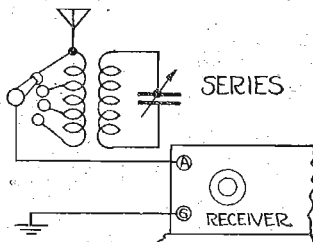

set will find its operation very simple, while its employment with either single or coupled circuits requires some practice in order to obtain maximum selectivity.

The compound or two winding filter is used most often when it is desired to reduce many classes of interference, including spark transmitters, alternating cur-

rent electric hum, static, etc., while at the same time it permits tuning out local interfering broadcast stations in order to receive DX stations.

The correct method of connecting the compound filter to your antenna and receiving set in which a series-parallel switch is used, and a method of connecting it direct to the set without the use of such a switch is clearly indicated in the two first diagrams, but I strongly urge you to use the series parallel method for its ultimate greater flexibility.

Tuning In

Move the contact tap switch to the first or direct to antenna tap, then, by using the tuning controls on your set, tune in the station you desire to eliminate; this accomplished, move filter switch to the opposite or last tap, which automatically inserts the primary inductance in series with your antenna. At this point all or nearly all signals should disappear and will remain absent, until by very slowly turning the condenser filter dial, they will reappear. Your filter trap is now tuned to the frequency of the undesired station, and it only remains to picture your receiver to the station desired. In retuning, particularly with regenerative sets, the tickler adjustment as well as filter condenser may require slight readjustment. The purpose of the tapped primary is but for securing varied inductive coupling.

Remember always, that this device represents not only a very accurate wave meter but also a filter; therefore, when rotating its condenser dial, one will very often find the offending station on one-half of a degree—which is advice sufficient to say, "Be yourself, take your time"; Jonah wasn't in any hurry; why rush? Give the trap a chance.

Another Filter Next Week
This, however, is but the beginning of

compound filters, or should I say, compact compound; so, next week we will rig up both a duolateral and a spider web trick and follow them with a loop filter that not only kisses that terrible station goodby but also does "sumthin else." Don't

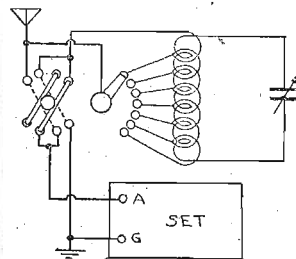

SERIES PARALLEL (SWITCH CONNECTIONS)

get the idea, though, that one wave trap will cut out three or four stations at the same time. No, son, its job is to eliminate one (any one) at a time, and the answer is, if you have two or three bothering you, then slap on a filter for each.

And, as I was saying, seems to me some of my readers either don't want my picture—and Maggie's also—or methinks perhaps you didn't read the offer; hence, I repeat. All you have to do in order to get my picture and my new reflex hook-up that works on a loop and uses no Radio frequency transformer is to send me a stamped, self-addressed envelope and I'll mail it to you "rush."

(TO BE CONTINUED.)

WHOLESALE RADIO SERVICE COMPANY

9 Church Street, New York City

Formerly at 39-41 Cortlandt St., New York City.

5 TUBE NEUTRODYNE SET

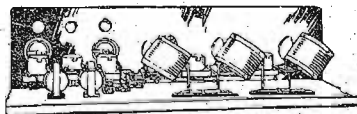

- Consists of:
- | | |
|--------------------|---------------------|
| 1 7x20 Bakelite | 1 30 ohm Bostone |
| 3 Neutroformers | Rheo and Dial |
| 1 Columbia | 1 7x25 Drilled |
| 2 Neutrodons | Panel |
| 5 Nat'l Bakelite | 1 60025 Dubilier |
| 2 Sockets | Condenser |
| 2 Jefferson Trans- | 1 2 Xag. Leak |
| formers | 2 .006 Mica Con- |
| 2 Filament Control | densers |
| Jacks | 5 Intitiated Blind- |
| 1 Cut-Hammer | ing Posts |
| Battery Switch | Southern Wire |
| 1 Bostone Power | Blueprint and |
| Rheo and Dial | Booklet. |

When this set is booked up you will be entertained by broadcasting stations thousands of miles away with selectivity, volume, distance and clarity. With the dial readings of a station recorded, it can always be tuned in again to the same settings, maintaining at the same time loud-speaking intensity and clarity of natural reproduction.

Included in the set is drilled panel, ready for mounting and wiring. A FADA book FREE.
Complete 5-TUBE NEUTRODYNE, built of genuine FADA parts, in a fine mahogany cabinet, ready to operate and pull in the long distance stations on the loud speaker, only **\$32.50**
(This does not include tube or batteries) **\$85.00**

COCKADAY 3 TUBE SET

- | | |
|------------------------|-----------------------|
| 1 Cockaday Coil | 4 Switch Staps |
| 2 Jefferson Audio | 1 .0025 Mic Condenser |
| Transformers | 1 2 Neg. Grid Leak |
| 1 17-Plate Condensers | 16 Ft. Bus Bar |
| 2 Switch Arms | 8 Binding Posts |
| 1 7x18 Panel | 1 21" Res. Cond. |
| 1 Double Circuit Jacks | 2 3" Bakelite Dials |
| 1 Single Circuit Jack | 1 7x18 Base Board |
| 3 National Sockets | Blue Prints and |
| 3 Rheostats with Dials | Instructions |
- \$19.50**

CROSLY XJ 4 Tube Set

Reg. Price \$65; Our Price \$45
FADA NEUTRODYNE MODEL 140
Reg. Price \$120; Our Price \$105
FREED-EISEMANN NEUTRODYNE
Model N. R. 5
Reg. Price \$150; Our Price \$129.50

The Radio Corporation's NEW RADIOLA III 2 TUBE SET

The Radio Corporation unconditionally guarantees this two-tube set to receive from broadcasting stations 2,000 miles distant on the loud speaker. This receiver complete with 2 W.D.11 Tubes, Phones, \$39.75
These sets are difficult to get, but we have a limited number, so act at once!

Freed Eiseman Knockdown 5 Tube Neutrodyne Receiver

Reg. Price \$80; Our Price \$65
Freed Eisemans Neutrodyne Kit-3
Neutroformers and 2 Neutrodons... 22.50
Fada Neutrodyne Kit-3 Neutroformers and 2 Neutrodons... 23.75
Columbia Neutrodyne Kit-3 Neutroformers and 2 Neutrodons... 15.50

Mail orders promptly filled and sent C. O. D. if you wish; we pay postage on all orders over \$5.00. In dealing with the Wholesale Radio Service remember that we are buying.

RETAIL AT WHOLESALE PRICES

91 1/2% of All Radio Tubes Are Needlessly Destroyed



Accurate estimates show that less than 9 out of every 100 tubes give their full normal service and 91 are destroyed—usually burnt out from excess current.

The chances are 10-1 against you unless you use

Radeco Safety Fuses

These tube savers are now saving thousands of tubes. They are endorsed by the leading Radio Publications. They slip on the filament terminals of the tube and in no way interfere with the operation of the set.

Price \$0.50 each
(The cheapest insurance)

Install Radeco Safety Fuses now and whenever you buy a new tube insist on a Radeco Fuse to protect it.
JOBBERs—We want a few live distributors to whom we can offer a very attractive proposition.

RADIO EQUIPMENT COMPANY
New England's Oldest Exclusive Radio House
20 Stuart Street BOSTON, MASS.

Use the **Pfanstiehl** Tuning Unit
UNIVERSAL
Its efficiency improves any circuit

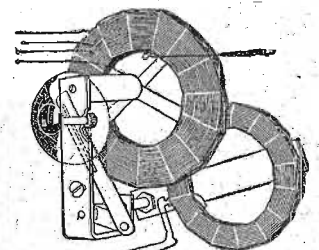

Reasons Why:
1. No absorption capacity.
2. No deterioration of original strength.
\$5.00 POSTPAID

Dealers: Write for our proposition.

PFANSTIEHL RADIO SERVICE CO., Highland Park, Ill.

"I made Voliva whisper, then hushed him entirely!" So writes a man living near the powerful Zion station, regarding the use of the

Pfanstiehl SILENCER



"Through three or four Chicago stations, I pick up Pittsburgh, Washington, D. C., and other stations at will," he continues.

Why not listen to the stations you want to hear by using the Pfanstiehl Silencer?

\$8.00 POSTPAID

HINTS FOR LISTENER IN

(Continued from page 21)

Correct Potential

The correct potential for a B battery to be used on the plate of a detector tube depends upon the type of tube used. With a "soft" detector tube, from 18½ to 22½ volts on the plate will give best results for DX reception. For very loud signals from local stations, it is advisable to use a "hard" tube, with about 90 volts plate potential. For weak distant signals, high plate voltage on a hard tube will cause it to oscillate; in this case, 22½ to 45 volts on the plate will be satisfactory.

Figure 4 shows a method of regulating the detector plate potential by means of a potentiometer shunted across the filament of A battery. It is advisable to use a high resistance potentiometer for this purpose, so as to secure an unlimited voltage range. This is a desirable condition when tuning in distant stations, because vernier voltage regulation of the detector tube plate is thus obtained, bringing the set to its most sensitive state.

For best operation of the detector tube, it is usually preferable to connect the grid return to the positive side of the filament, using as low a plate potential as is satisfactory for best results. When using a vacuum tube as an amplifier, it is important that the filament rheostat be

connected in the negative lead and that the grid return lead be connected to the negative side of the battery and not to the negative side of the filament. This places a negative bias on the grid. If more than 40 volts are used on the plate, the negative grid bias voltage thus provided is not sufficient and an additional grid biasing battery, or C battery, should be used. When a C battery is used it is connected in the common grid return lead of all the tubes, as indicated in the diagram given in Figure 5. Connect the grid return terminals on the amplifying transformers by a common wire, connected to the negative terminal of the C battery. The positive terminal of the C battery is connected to the negative terminal of the filament of A battery. The chief advantage of the C battery lies in the fact that it causes a material reduction in plate current and thereby prolongs the life of the B battery.

Voltage of C Battery

The negative potential which should be applied to the grid of an amplifying tube depends in some degree upon the signal strength and on the B battery voltage used. A 4½-volt C battery will be sufficient with most tubes when plate battery voltage of not over 90 or 90 volts are employed. For plate potentials up to 120 volts from 6 to 9 volts of C or grid biasing battery will produce best results.

When employing audio frequency am- (Continued on page 24)

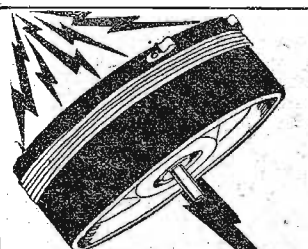

The FERBEND Wave Trap
STOPS INTERFERENCE

THE FERBEND WAVE TRAP MAKES YOUR SET SELECTIVE

READ THE EVIDENCE!

An Easy Way to Cut Out Interference
Add a Ferbend Wave Trap to Your Set

It isn't hard to receive nowadays on most any good set from stations all over a country as big as the United States—if the nearby station doesn't interfere. Even then, if your set is extremely selective, and if you have the right antenna and if you are an expert at tuning—and if you have good luck—you can perhaps tune out the offending transmitter.

Do not be misled by imitations. The FERBEND WAVE TRAP is the first inductive arrestor ever designed. It is not assembled haphazardly from standard parts, but is made up of special parts designed and manufactured by us for the sole purpose for which it is used. The FERBEND WAVE TRAP is mounted on a porcelain base in a heavy duty finished cabinet 6 1/2x4x3 1/2 or unmounted at \$1.00.

It happened that Wm. L. Mann, of 767 N. Forth St., in Philadelphia, didn't have all these things—he just bought a FERBEND WAVE TRAP, and now he says he has no trouble tuning out any of the four big Philadelphia stations. The same thing can be done (probably is being done) in your town. Try it!

ANY NIGHT IS "SILENT NIGHT" with a FERBEND!

Wonderful Selectivity for You
with a FERBEND WAVE TRAP on your set. You will be surprised at the ease and sureness with which you can tune out that troublesome interfering local station that is always breaking in every time you get some favorite station. The FERBEND WAVE TRAP is guaranteed to tune out any interfering local station. Why wait? Order now.

Send No Money
Just your name and address, and pay postman \$5.00 (plus postage) for the unmounted, or \$8.50 (plus postage) for the mounted Wave Trap. If you prefer, send cash in full with order and we will ship postage prepaid. You take no risk, so order today.

"The Original Wave Filter"
Ferbend Electric Company
Dept. 3 19 East South Water St., Chicago

PEERLESS RADIO, 349 Fulton St. BROOKLYN, N. Y.

Parcel Post prepaid on all orders above \$5.00. Express Money Order, Certified Check, Bank Draft accepted; also C. O. D. Guarantee with all merchandise.

LOUD SPEAKERS	HEATH'S RADIAN CONDENSERS	PHONES
Magnavox (new type).....\$27.25	13 Plate.....\$4.76	Narco.....\$2.35
Music Master.....25.30	23 Plate.....4.95	Precent.....3.48
Patté (new type).....19.50	43 Plate.....5.95	Brandt Superior.....4.85
Dietzgrand.....15.25	RADIO COUPLERS	Federal.....4.55
Stromberg Carlson.....17.75	Fisher, large.....\$2.35	Mr. Seib, German.....7.95
Norway with Baldwin Unit.....4.95	Shamrock.....2.65	6000 ohms.....5.85
Natl. Baldwin Type C Unit.....4.85	Snapo, no base.....3.75	Western Electric.....3.50
Manhattan.....22.50	Wardite.....2.95	Ambassador.....3.50
Brandt's Table Talker.....9.95	Gilfillan, small.....5.95	Pottor Precision.....4.25
Acousticon Phonograph Unit 8.46	Gilfillan, large.....7.45	Wagner Phones.....3.95
VARIABLE CONDENSERS	Pathé.....3.25	TRANSFORMERS
17 Pl. Admiral or Signal.....\$1.85	Genovis All Wave.....5.95	Aemo Audio and Radio.....\$ 3.90
17 Pl. Admiral or Signal.....1.60	Cockaday Coil.....1.95	All-American coil ratio.....3.90
25 Pl. Admiral or Signal.....1.85	Unktd, 100, Bakelite.....1.95	Federal No. 95.....3.95
43 Pl. Admiral or Signal.....1.75	VARIOMETERS	Modern.....3.95
17 Pl. Montrose Vernier Cond.....2.95	Fisher, large.....\$2.55	Thordarson.....3.95
17 Pl. Montrose Vernier Cond.....2.35	Shamrock.....2.65	Erle Reflex and Audio.....4.45
28 Pl. Montrose Vernier Cond.....3.95	Snapo.....5.05	Modern Push-Pull.....10.75
11 Pl. U. S. Tool.....4.10	Wardite.....3.25	Comp Push-Pull.....10.75
28 Pl. U. S. Tool.....4.10	Gilfillan, large.....7.45	Alaska Transformers.....3.95
CYCLONE BATTERIES	Pathé.....2.85	MAHOGANY CABINETS
Small 22½ Volt.....\$.75	Genovis All Wave.....5.95	7 x 10.....\$2.45
Large 22½ Volt.....1.25	Cockaday Coil.....1.95	7 x 12.....2.65
Medium 45 Volt.....1.75	Unktd, 100, Bakelite.....1.95	7 x 18.....3.05
Large 45 Volt.....2.25	HARD RUBBER PANELS	7 x 18.....3.05
Large 22½ Volt Eveready Battery.....3.65	7 x 10.....\$.70	7 x 12.....2.65
Small 22½ Volt Eveready Battery.....1.15	7 x 12......90	7 x 18.....3.05
Eveready "O" Battery, 4½ Volt......50	7 x 18.....1.40	7 x 21.....3.35
	7 x 21.....1.85	7 x 21.....3.35
	7 x 24.....2.65	7 x 24.....3.65
MISCELLANEOUS	Pathé Palsifiers\$0.50	Phone Plug for 6 pr. Phones.....1.25
Bell Socket, Bakelite Panel......50	New Improved Cockaday.....1.25	Single Circuit Jacks......35
Mounting Plate......50	Coils, silk wound.....5.50	Double Circuit Jacks......45
Amso 5 ohm Rheostat......15	Cutler-Hammer 30 ohm Rhee.....1.20	3 1/2" Dia. Type......30
Amso 20 ohm Rheostat......15	Cutler-Hammer 400 ohm Potentiometer.....1.20	3 1/2" Dia. Fada Type......30
Amso 30 ohm Rheostat......15	Filament 1.25.....1.20	Triple Sockets, Fada Style.....2.65
Amso 400 ohm Potentiometer.....1.40	Bradleystat or Bradleystat.....1.70	Shelter.....1.40
Cutler-Hammer 6 ohm Rhee......50	Brano 14 Tap Inductance Sw......75	Shelter.....1.40
400 ohm Potentiometer......50	Sta-put Phone Plug......35	Freshman Grid Leak & Cond......75
Cutler-Hammer 6 ohm Rhee......50		
400 ohm Potentiometer......50		
ELECTRAHOT Solder Iron.....1.20		
New Improved Cockaday Coil.....5.50		

The New Genuine Guaranteed "SHEPCO" "ALL WAVE" JR.

Trade-Mark Patents Granted and Pending

NON-RADIATING DX COUPLER

Combination Flat and Bank Wound

"All Wave" Sr.
\$7.00
150 to 3000 Meters
Guaranteed Wave Length

"SHEPCO" "ALL WAVE" JR.
Eliminates use of all variometers, vario-couplers and loading coils. Permits building most efficient, sharp tuning, loud, long distance receiver at lowest cost.

"All Wave" Jr.
\$6.00
150 to 2000 Meters
Guaranteed Wave Length

Use in the "All Wave" triple circuit, the "All Wave" Jr. is guaranteed not to radiate and to bring in distant stations clear and loud on one tube. Log your stations and get them at the same setting every time. Only one dial to tune.

READ THESE RESULTS OBTAINED WITH "ALL WAVE" COUPLERS

F. S. Thompson, De Kalb, Mo.	J. W. Sutcliffe, Providence, R. I.	J. M. Bleuvett, Dallas, Tex.
"Picked up London, England, so it could be heard through two rooms."	"Got KFI, Los Angeles, Cuba, Porto Rico and Nebraska. Convinced of quality of your product."	"For selectivity it is the goods. I can tune out in any station."

On sale at all dealers in standard radio parts or sent direct on receipt of price. **ABSOLUTE MONEY BACK GUARANTEE.**

SHEPARD-POTTER CO. INC.

Plattsburg, N. Y.

RADIO AT N.Y. PRICES

Daily Parcel Post

The Prices Quoted Below Deliver Goods to Your Door

HOW TO ORDER—Write your order plainly; state number, description and price of items wanted. Send Post Office or Express Money Order, personal check or bank draft. REFERENCES: Duns', Brands', or Cash Exchange Bank.

JACKS AND PLUGS

Jacks are polished nickel constructed with pure silver contacts.

- D118 One spring open circuit.....\$.39
- D119 Two spring closed circuit......49
- D120 Round plug as illustrated......49

Audio Frequency Transformers

The following transformers are guaranteed standard makes, and will produce very efficient results.

- D88 Dietzen 3 to 1 Ratio.....\$3.95
- D84 Dietzen 5 to 1 Ratio.....3.95
- D85 Dietzen 10 to 1 Ratio.....3.95
- D86 Acmo Audio.....\$4.25
- D87 Amertran.....3.95
- D88 Modern Audio 4-1.....4.85

HONEYCOMB COIL MOUNTINGS

- D140 2-coil mounting.....\$2.85
- D141 3-coil mounting.....3.79
- D142 Single coil mounting......40
- D143 Receptacle for single coil mounting......50

DIETZEN SUPER HEADSET

D181 2200 Ohms.....\$2.95

Reg. Price, \$5.00 per Pair. Since we are wholesale distributors for this wonderful headset we pass this bargain on to you. The Tone quality is of unusual volume. These phones can be used as a loud speaker unit. Sold with a money back guarantee, if not satisfactory.

VARIABLE AIR CONDENSERS

These condensers are made of heavy aluminum plates, high grade bakelite ends.

- D110-41 Pl., .0005 Mfd.\$1.75
- D111-41 Pl., .00025 Mfd.1.25
- D112-3 Pl., .00005 Mfd..95
- D113-43 Pl., .001 Mfd. 2.25

Vernier Variable Condensers

These condensers are made of heavy aluminum plates, high grade bakelite ends.

- D114-14 Plate Vernier with knob and dial.....\$2.95
- D115-26 Plate Vernier with knob and dial.....3.45
- D116-43 Plate Vernier with knob and dial.....3.95

INDOOR LOOP AERIAL

D76. Can be assembled by anyone in five minutes; all wood parts, wire and binding posts included, complete, while quantity lasts......75c

DOUBLE PHONOGRAPH ATTACHMENT

This attachment fits all phonographs; will take any headset; it converts your phonograph into a loud speaker.

- D132 Double attachment.....\$.85
- D180 Single attachment fits any single phone unit to be used on phonographs......45

RADIO CABINETS

Highest grade Mahogany piano finish Cabinets. Hinged top. These cabinets are being sold at less than one-half regular value.

- 957 Wood Cabinet; panel size 7" x 19".....Each.....\$2.95
- 958 Wood Cabinet; panel size 7" x 19".....3.45
- 959 Wood Cabinet; panel size 7" x 19".....3.95
- 960 Wood Cabinet; panel size 7" x 19".....4.45
- 961 Wood Cabinet; panel size 7" x 19".....4.95
- 962 Wood Cabinet; panel size 7" x 19".....5.75
- Baseboards (Oak, Stained) for above cabinets......75
- 731......80c 732......90c 733......95c 734......95c

Model's

ESTABLISHED 1905

71 Cortland Street

NEW YORK, N. Y.

America's Greatest Radio Order House

ELEVEN NEW YORK STORES

Simple Explanation of Radio for Everybody

Chapter XII, Part III—Radio Frequency Amplification

By M. W. Thompson

IN the previous two issues, eight types of Radio frequency amplifiers were presented. In this installment we present four of the most interesting in the writer's collection of circuits, which, by the way, is probably one of the most complete in Radio circles. In Figure 99 is shown the first successful combination

and passes energy into the variometer here utilized as the secondary. With units of the proper constants, this set functions well on a 20-foot antenna, a greater antenna seemingly making little if any improvement.

The tendency of the first grid circuit to oscillate is checked and controlled by

and selectivity is gained by the loop and the circuit which couples them to the detector.

The circuit shown, including the three inductances A, B and C, is the triple honeycomb coil hook-up, in which A is usually led to antenna and ground. A and B will each be 50 or 75 turn coils; C, the

stages of audio frequency amplification. A six-tube set is acquired that is marvelous in results. True, it has three condenser controls, two couplings and the loop switch, but once the owner learns approximately where various wave lengths are found, tuning is not difficult. It is a set for the man who, looking through

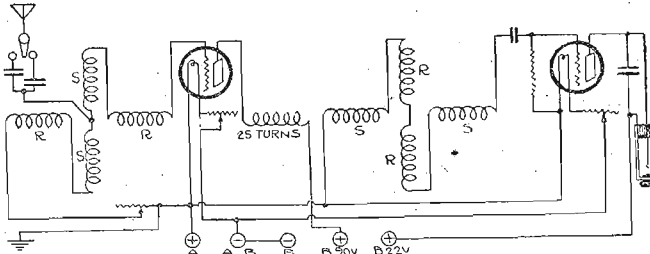

Figure 99—This hook-up was the first practical combination of regeneration and R.F. amplification.

of Radio frequency amplification and regeneration. The experienced reader will recognize at once the presence of two variometers, but the method of connecting the windings will puzzle. Here, not only is the rotor split from the stator, but the two halves of each are separated.

In the variometer which precedes the first tube, a lead is taken from the mid-point of the stator and connected to the antenna; one end of the variometer is led to the grid, while the other passes through a variable resistance to the filament circuit. This gives the effect of a transformer with half the winding in the antenna circuit and all of it in the grid circuit, and a doubling of voltage results at once.

Split Stator and Rotor

The second variometer has no mid-point leads, but stator and rotor are split as shown. Tightly coupled to the stator is a coil of 25 turns which acts as the primary of a Radio frequency transformer

the variable resistance inserted between the variometer and the filament circuit, and this first tube may be brought right up to a point just below the "spill-over." All the amplification of regeneration is thus gained. With the proper units, the fan can construct such a set and add two stages of audio amplification which will give surprising volume on far distance.

Three Stages of Radio Frequency

Figure 100 shows a hook-up which, in the writer's opinion, is surpassed only by the super-heterodyne. For the actual hook-up we are indebted to Mr. Gouden. The loop arrangement is that used by Grimes on the inverse duplex. There are three stages of transformer coupled Radio frequency amplification. Iron cored transformers may be used because, while they are broad, they pass more energy.

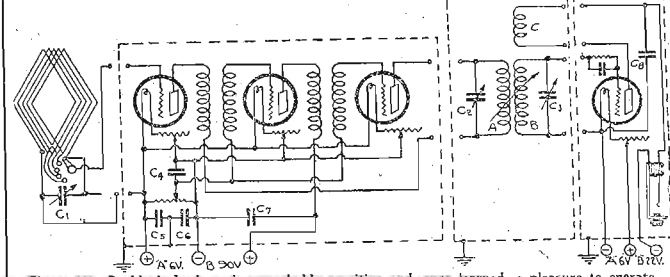

Figure 100—Gouden's hook-up is remarkably sensitive and, once learned, a pleasure to operate. next smaller size. C₂ and C₃ are .001 mfd each, as is C₄. The leads to C₃ may have to be reversed to secure regeneration, but once determined are left alone. With two

(Continued on page 29)

CROSLLEY
for the Radio World

New Two Tube Set at \$18.50
REGEN. PATENT

THE most astounding value ever offered in radio—a new two-tube receiver, Crosley Model 51, consisting of Armstrong regenerative detector and one stage of audio frequency Amplification. Licensed under Armstrong U. S. Patent No. 1,113,149.

This wonderful set gives loud speaker volume on local stations at all times and on distant stations under fair receiving conditions. Otherwise head phones should be used for distant reception.

Be sure to see this receiver.

For Sale by Good Dealers Everywhere. Free Catalog Sent on Request

The Crosley Radio Corporation
Powell Crosley, Jr., President
Formerly
The Precision Equipment Company
and Crosley Manufacturing Company
3493 Alfred Street, CINCINNATI, O.

Sterling

12 Point Rotary Switch

More Than Your Money's Worth

Save Time and Bother with This Handy Device

CONFUSION and bother with variocoupler taps and similar wiring jobs are unnecessary with the handy Sterling 12 Point Rotary Switch available.

It is designed to eliminate unsightly front of board contact points, providing a complete unit for rear of panel mounting to which variocoupler taps may be soldered easily.

This switch may be used with a voltmeter for reading voltage on individual tube filaments.

Price \$1.50

THE STERLING MFG. CO.
2829 Prospect Ave., Cleveland, Ohio

Coto
"Built First to Last"

Coto Special Audio Frequency Transformer \$2.50
Type 4500

A MARVEL of manufacturing economy brings this remarkable audio transformer to you at a popular price.

Turn ratio is 3 to 1. Gives you ample volume and full, rich tone. Finest of materials. Coto quality throughout.

If your Dealer cannot Supply you write us giving his Name

COTO - COIL CO.
57 Willard Ave., Providence, R. I.

BRANCHES
Los Angeles: 329 Union League Building; Minneapolis: Geo. F. Darling, 705 Plymouth Building; Atlanta: C. P. Atkinson, Atlanta Trust Co. Building.
CANADA: Perkins Elec. Co., Ltd., Montreal, Toronto, Winnipeg.

Your Choice FREE Limited Supply

Your prompt action gives you one bound volume with each annual subscription. New or renewal.

65 Copies

Greatest Collection of Radio Information
A. B. C. Lessons for Radio Beginners.
Two, Three, and Four Tube Reflex Circuits.
The Famous Mifflin with Various Hook-ups.
Ritz Long Distance Circuit—Ultra Reinartz.
Flowering Popular "Flower" Circuit.
Single Tube Radio Circuit—Super-Heterodyne.
Five Tube Neutrodyne, Special R. D. Hook-ups.

In addition to these features, the current issues give you all the live news in Radio. The popular Q. and A. Department. How to Operate Your Set, Advance Broadcasting Stations Programs, and a correct list of all Broadcasting Stations.

Serving as a **Radio Reference Library**
You receive 52 issues with your Subscription and 13 issues in each bound volume.
Bound Volumes 3, 4, 5 and 7 now ready.

This offer good only in U. S. and Possessions, and Canada.
This offer not good through dealers or subscription agencies, but must be sent us direct with the full subscription price. Remittance must be by check, money order or draft.

RADIO DIGEST, 123 W. Madison St., Chicago
Check Offer Desired

One year's subscription, and choice of one volume. Send Vol. Enclose \$5.00

Two year's subscription, and choice of two volumes. Send Vols. Enclose 7.00
Additional Bound Volumes at \$2.00 each.

Name
Address
City State

HINTS FOR LISTENER IN

(Continued from page 22)

plication, it is advisable in the first stage to use an amplifying transformer having a high ratio of secondary to primary turns, such as 9 to 1. For the second stage, however, a lower ratio is best adapted for good reception. In this instance, the ratio of secondary to primary should be about 3 or 4 to 1.

The secondary winding of the amplifying transformers should be connected to the negative side of the A battery to prevent the grids of the amplifier tubes from becoming positively charged. If the secondary were connected to the positive terminal of the filament battery, the grid would assume a positive charge and consequently there would be a flow of electrons from the filament to the grid.

Howling and Signal Distortion

A frequent source of trouble in amplifying circuits is the interaction between the transformers that results in howling and in signal distortion. In order to reduce

this effect to a minimum, it is advisable to place the transformers with their cores at right angles to each other. When the transformers are enclosed in steel shells, this precaution need not be taken.

Before removing tubes from their sockets in amplifier circuits turn the respective filament control rheostat to the "off" position. This is advisable because when one of the tubes is removed from such a circuit, which is used to supply several tubes in multiple, there is a sudden increase in current, which may be sufficient in some instances to damage or impair the filaments of the tubes still in circuit.

Regulating the filament control rheostat as close to the off position as practicable will not only conserve the A battery but also prolong the life of the vacuum tube. With new cells of A battery, the rheostat need only be turned a trifle from the off position, but as the service demanded gradually cuts down the current supply of the cells, the rheostat position must be adjusted in proportion. When it is necessary to operate with the rheostat all out, it is a good indication that the A battery

potential has fallen to such an extent that new cells should be provided.

Life of the B Battery

The life of the B battery is determined by a number of factors, namely, its quality, its size, how it is used and the intensity of signal strength desired. The current drawn from the B battery is governed by the kind and number of tubes used, the B battery voltage, and the grid potential. The B battery current for the amplifier tubes can be reduced to one-half or one-third by the proper use of a C or grid biasing battery.

Turning Off B Battery

The most economical results will be ob-

tained from the B battery by turning off the filaments as soon as it stops listening. Plate current is flowing as long as the filaments are lit, whether anything is being received or not, and turning off the filament saves them, as well as the filament battery and plate battery. When the voltage of the B battery drops below 50 per cent of its normal or rated value it is advisable to replace it, because a battery in that condition has an increased resistance, which reduces the strength of signals and causes all kinds of peculiar noises in the receivers. Always test the B battery with a small high resistance voltmeter.

(TO BE CONTINUED.)

Type F The Air-Way Wonder Set of Radio

"Getting Pacific coast stations strong with loud speaker on type F," writes E. S. White, Lovell, Mich. "Heard concerts from Havana, Cuba, Forth Worth, Texas, Atlanta, on a loud speaker," Austin Rhenner writes from Chicago. W. E. Culver, Savannah, Ga., says, "I get stations from all over the country loud and clear." "Picked up 72 stations—ten in Canada, and get them back any time I want them," writes Jas. Berne, Aberdeen, So. Dak. Like this hundreds certify the genuine quality and perfect performance of Air-Way radio sets built to represent the highest permanent quality, and offered at nominal and fair price.

Four Tube—(Loud Speaker Set) Guaranteed Under Seal

This is not a "cheap" or "bargain" set. Only the finest quality instruments are used. Employs the reliable tuned radio frequency circuit with one step radio frequency, detector, and two steps of audio. Capable of coast to coast reception and use of any loud speaker to its full efficiency. Reproduces in loud, clear, melodious tone. Critical-selective. Recording position of controls for any station enables resetting at same position to bring station back. Quiet in operation, simple to tune. Furnished in beautiful mahogany finished cabinet. Responsible dealers can show you this Air-Way. Ask to see it or write to us.

Manufactured and Guaranteed By AIR-WAY ELECTRIC APPLIANCE CORPORATION TOLEDO, OHIO

Only \$50

Air-Way sets are put out under sealed guarantee. Thoroughly tested each set on actual broadcasting by our experts for sums perfection.

STORAD

"B" BATTERY
24 Volt Unit

Radio engineers now unanimously recommend storage "B" Batteries for use with the new Multi-tube sets. Their voltage is constant and steady until discharged. They aid long distance reception and eliminate many noises in the set.

The Ultimate "B" Battery for Radio Reception

Storads have extra heavy 1/4" plates and large acid capacity. Storads will last for years and pay for themselves in less than a year. Your present charger is or can be adapted for "B" battery charging which is done while set is not in use.

No. 225 Unit. 2250 M.A.H. capacity. Size 4 1/4 x 13 1/2 x 6"
No. 450 Unit. 4500 M.A.H. capacity. Size 4 1/4 x 13 1/2 x 7 1/2"
ALL BATTERIES SHIPPED DRY

Write for Bulletin and complete information
THE CLEVELAND ENGINEERING LABORATORIES CO.
2119 Superior Viaduct N. W., Cleveland, Ohio

EMERALD

LOUD TALKING ORIGINAL

SUCCESS BRINGS IMITATIONS

LOOK FOR OUR NAME on the B-Metal box and be certain of getting the kind of B-Metal Crystals you expect to buy i. e., the B-Metal that has become famous for its loud talking qualities, and First, Last, and Always has been sold under this label. **READ B-METAL REFINING COMPANY ON THE BOX OR PASS IT BACK TO THE DEALER** for if our name is not there, our well-known and well-tested guarantee is not behind it. **B-METAL WAS NEVER ON THE MARKET UNTIL WE PUT IT THERE**, and we stand squarely behind every B-Metal product bearing our name printed plainly on the package.

We do not offer premiums to assist the sale of REAL B-Metal.

B-METAL REFINING COMPANY
525 WOODWARD AVENUE DETROIT, MICH.
Formerly at 3134 Trumbull Avenue
Chicago Branch: 53 West Jackson Blvd., Chicago, Ill.
New York Branch: 232 Fulton Street, New York City.

QUALITY MEANS PRICE 50 CENTS

Buy a STAR PINT CRYSTAL DETECTOR

YOU'LL NOT BE DISAPPOINTED WITH A STAR

Built by engineers who know the problems of crystal detection. Sold by all radio-socket jobbers and Dealers.

Used by the Radio owners who have loved and dreamed of such an accomplishment, and gaining a host of friends daily. We are doing our best to meet the demand, so please say STAR PINT CRYSTAL to your Dealer or Jobber early and get your STAR when you want it.

Star Crystal Company
25 Woodward Ave.
Detroit, Mich.
Chicago Branch, 53 W. Jackson Blvd., Chicago, Ill.
New York Branch, 232 Fulton St., New York City.

Price \$1.25

STAR-RITE RADIO BATTERIES SAVE YOU 60%

And Guarantee You in Writing 2 Years of Better Battery Performance

STAR-RITE RADIO BATTERIES are made especially for Radio and the big saving is made possible by coming direct to you instead of thru distributors, dealers, etc. Boxes are made of oak, finished in mahogany and the plates very thick and will give a steady discharge over a long period. No premiums, just good, honest battery value.

TRY TO BEAT THESE PRICES

2 Volt for W. D. 11 and 12	\$4.00	6 Volt 60 Amphr.	\$ 7.50
4 Volt for U. V. 199 Tubes	7.00	6 Volt 80 "	8.50
RADIO B. STORAGE		6 Volt 100 "	10.00
Glass Jars, Heavy Plates—Case of 12 Cells, 24 V.....		6 Volt 120 "	12.10
		6 Volt 150 "	14.00
		6 Volt 200 "	17.00

Get Yours Today—NOW—Send No Money

The batteries are fully guaranteed in writing and shipped subject to examination on the day your order is received. You pay on delivery or deduct 5 per cent if full cash accompanies order. You may deduct 10 per cent if two or more are ordered at one time.

STAR-RITE BATTERY CO.
Department 5 LOUISVILLE, KY.

Steinite Gives Distance On Crystal Sets!

The Marvelous New Crystal

Underwriters Fire Patrol
KANSAS CITY, MO.
Steinite Laboratories
Atchison, Kansas

You certainly have the greatest crystal I have ever used. I made them all. Your STEINITE is the greatest for volume and distance I have ever tried.

Just for example let me tell you what I did with STEINITE last night. I picked up the St. Louis Post Dispatch. Also heard Omaha and Davenport. How that's remarkable.

When F. D. P. The Kansas City Star is in the city. I attach a small tin horn to one receiver, shout the other and throw the entertainment out into two large rooms. STEINITE is a REAL crystal. You can refer any doubters to me.

Secy. K. O. Fire Patrol Bldg., Kansas City, Mo.

RESULTS truly amazing like Mr. Gardner tells in his letter. Everyone astonished by STEINITE. J. A. Zeugin, Lawrence, Kans., writes, "So far have caught Chicago, Dallas, St. Louis, Davenport and several others on my crystal set with your STEINITE crystals, Carl McGraw, Independence, Mo., says, "The first night I heard Fort Worth, Tex., Omaha, Neb., St. Louis, Mo., and WJAZ and KYW at Chicago, Ill."

You can't doubt what you hear with your own ears. Listen in on STEINITE at my risk. Read my guarantee and offer—then act.

Introductory Price NOW 50¢ Each SPECIAL 3 for \$1.00

You are buying no ordinary crystal when you order STEINITE. It's an entirely new discovery. Opens up new possibilities for crystal set receivers. STEINITE CRYSTALS are being imitated. **None Genuine unless stamped My Money-Back GUARANTEE**

I unreservedly guarantee STEINITE to give you better results than you ever thought possible on your crystal set, and if you are not surprised and more than pleased I will send back your money without any question.

These two big Atchison banks will testify to my reliability: Exchange National Bank, Atchison Savings Bank. Don't delay the radio treat in store for you. Order Three STEINITE crystals today—NOW. None genuine without letter S stamped on side.

STEINITE LABORATORIES Dept. 9, Radio Bldg., ATCHISON, KANSAS.

The Latest in Super-Heterodyne Hook-Ups

Part I—Circuit Diagrams

By H. J. Marx

SUPER-HETERODYNE simply indicates a system of short wave reception by means of which the greater efficiency of high wave length tube coupling is taken advantage of. Naturally this means that there are a number of methods of applying this system to circuits which considerably differ from one another. Which of these systems will prove most efficient still remains to be seen. These circuits are not easily assembled and tested, so comparative analysis cannot be made in a short time. In fact, many of these methods still lack a reasonable development to the best operating efficiency. Super-heterodyne is at present claiming the greater part of the time of all experimental and research authorities. Proper construction details cannot be given out until all this preliminary work is done. Information that is rushed through in most cases covers the design of those old circuits that were used for code reception or the set is merely imaginary in the mind of some overenthusiastic Radio author. Yes, the set may work in a fashion, but does it do what it is primarily designed for?

Old Designs
How many of you realize that all of those old designs which were developed for code work will not work for broadcast reception? Do you know that the transformers are so designed as to have a very sharp but high amplification curve, good only at one frequency? This is fine for code work, but in broadcast reception a flat peak is required which will give uniform amplification over a range of 20,000 cycles in frequency.

Long Wave Transformers
Do you know that the average long wave transformer has an amplification curve, which instead of being flat, shows all the undulations of a snake traveling along on its path of life? How under the sun can you expect distortionless reception if you want the stuff rushed through without proper development? The biggest and most reliable Radio apparatus manufacturers are working on this problem and you'll note that they are not committing themselves by rushing headlong into throwing something on the market without thoroughly satisfying themselves

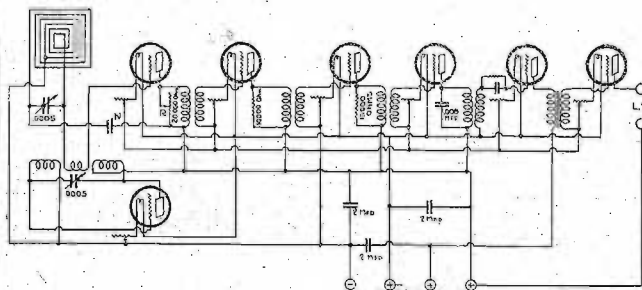

Figure 1.

through exhaustive tests, that it will work.

Filter Couplers
You have probably noticed filter couplers in some circuits. Do you know their purpose? They are put there to compensate for the inefficiency of the long wave transformers. The filter coupler confines the modulated frequency to a single narrow band over which the long wave transformers give best amplification with minimum distortion. Whether that band has a flat curve depends entirely on the transformer design and that of the filter coupler. Obviously designs copied from old super-heterodyne models, will not give satisfactory performance for broadcast reception.

Oscillator Circuit
Now, as to the oscillator circuit, the method using capacity tuning is fine, but you will find that the strength of oscillation is not regular over the entire range. This means unreliable reception, and then again, the set may work fine on strong local signals but on weak long

distance reception, the strength of the local oscillating current in the set overcomes the weak signals and paralyzes the first detector tube. The only remedy, then, is to weaken the coupling of the pick-up coil to the oscillator circuit.

If this coupling is fixed, as called for in most circuits, there is no provision for taking care of this condition.

Furthermore in order to avoid inductance taps, the efficiency of the condenser must be kept at its maximum. This means that the condenser must have the highest possible maximum to minimum capacity ratio. Don't use poor condensers.

No-Radiation
Work your super-heterodyne with a loop. If you feel you have to use an outdoor antenna and want to hear the traction line interference in a city of 2,000 miles away, then have some consideration for your neighbors and put in a stage or two of ordinary Radio frequency amplification

before the first detector. The writer suggests tuned Radio Frequency air core transformer coupled, for simplicity and efficiency.

Two Circuits
For the benefit of fans who are interested in the various forms of super-heterodyne circuits, two are shown in the illustrations. It is advisable to examine these carefully in order to fully understand the particular features of each method of applying this principle of amplification.

Figure 1 shows a circuit in which the peak of the amplification curve is flattened by means of resistance across the primary of the transformer. The resistance across the primary of the first transformer is variable; this gives a condition somewhat similar to that of a filter coupler. The last super-audible transformer has a capacity across the primary which also flattens the curve and at the same time limits the maximum and minimum range, thus compelling a more critical adjustment, which in turn gives greater amplification without undue distortion.

The condenser N is a neutralizing variable capacity which must be adjusted and then locked. It is intended to hold the first tube just below the oscillation or "spill-over" point. The usual oscillator coupler construction is employed.

In the circuit shown in Figure 2, a filter coupler (first super-audible transformer) is employed. Here, likewise, the standard oscillator construction is used. A 400-ohm potentiometer is used to control the grid potential and thus hold down any spill-over of these tubes.

A C or bias battery has been added in the grid circuit of the second stage of audio amplification.

In the next part of this article some French super-heterodyne systems will be shown. The presentation of all these

(Continued on page 26)

EVEREADY
Radio Batteries
~they last longer~

Conspicuous for vitality and endurance—the right batteries by test and proof for every radio use.

NATIONAL CARBON CO., INC.
Headquarters for Radio Battery Information
New York San Francisco

CANADIAN NATIONAL CARBON CO., LIMITED
Factory and Offices: Toronto, Ontario

S. HAMMER RADIO CO., 303 ATKINS AVE. - BROOKLYN, N. Y.

Standard Merchandise Only \$72.50
\$80.00 FREED EISENMAN'S PARTS FOR 5 TUBE NEUTRODYNE SET \$85.00
\$90.00 Genuine Parts for 4 TUBE MELCO SUPREME RECEIVER \$105.00

Anything and Everything in Radio

PHONES
\$ 5.00 Turney 3000 ohms. \$ 2.75
12.00 Western Electric 10.30
6.00 Brander Superior 4.75
12.00 Baldwin Type C. 7.95
7.00 Federal 4.95
6.00 Potter Precision 4.15
5.50 Stromberg Carlson 4.50
3.75 Pucent 3000 ohms. 3.55
12.00 Di. Satic 3000 ohms. 5.75

RHEOSTATS
1.00 Fada 30 ohms. .80
1.00 Federal 1.25
1.00 Amisco 6 ohms. .85
1.25 Amisco 20 ohms. 1.00
1.00 Amisco 30 ohms. 1.10
1.50 Outler Hammer 6 ohms. 1.15
1.50 Outler Hammer 30 ohm Pt. 1.15
.90 Klosser 6 or 30 ohms. .90
1.00 Pucent 6, 20 or 30 ohms .90
2.00 Kilohmit 1.85
1.80 Bradley-Stai 1.70
1.00 Bradylest 1.70
2.00 Ermostat 1.70

DIALS AND SOCKETS
3" Amico Bakelite .45
1" Amico Bakelite .80
Ball Socket .65
Metric Socket .90
Tripo Socket 2.50
Chilton Socket .65

JACKS AND PLUGS
Pucent Double .70
Federal Single .65
Danstron W. W. 1.25
Cico W. W. .55
Weston .80

VARIABLE CONDENSERS
\$2.00 Signal .51-50
2.50 U. S. 4.25
2.50 Conso 1.75
1.80 Amico 1.30

25-PLATE
2.50 Signal 1.60
2.75 U. S. L. 1.85
2.50 Conso 2.52
2.30 J7-PL Amisco 1.65
2.50 Amisco 1.55

43-PLATE
2.75 Signal 1.65
2.50 U. S. L. 1.85
2.50 Conso 2.25
2.50 Amisco 2.75

VEINER CONDENSERS

II-PLATE
6.00 Hammarlund 4.95
4.50 U. S. Tool. 3.50
3.50 Conso 2.65
5.00 Sexton 4.25
4.50 U. S. L. 3.10
4.00 Amico 2.85

23-PLATE
6.00 Hammarlund 5.65
5.00 U. S. Tool. 4.75
4.50 Conso 3.75
5.50 Sexton 4.90
5.00 U. S. L. 3.45
4.50 Amico 3.35

43-PLATE
6.50 Hammarlund 5.20
5.50 U. S. Tool. 4.25
6.50 Conso 4.75
6.50 Sexton 5.45
5.50 Automatic 5.45
5.00 Automatic 5.05
4.00 Amico 17-Pl. 3.35
5.00 Amico 20-Pl. 4.10
5.00 Compositing Con. 4.10
Weston 2.65

4 CIRCUIT TUNER
Complete parts for the improved Cockaday 4 Circuit Tuner, exactly as specified by Mr. Cockaday. \$55.00

LOUD SPEAKERS
\$30.00 Music Master \$24.00
35.00 Mammoth 28.00
30.00 Herald 26.00
10.00 Brantley 9.50
17.50 Radio 16.00
Bakelite Unit 4.65

Inner Radiophones
Units 3.85

TRANSFORMERS
7.00 Federal No. 65. 5.45
5.00 Amisco 3.25
3.00 All-American 3.65
7.00 American 5.75
4.50 Fluoracene 2.75
12.50 Conso Duplex 15.50
12.50 Modern P. P. 15.50
5.00 Erie 4.25
12.00 All American P. P. 10.00
4.00 Radio R. F. 3.75
5.00 Duratron H. F. 4.50
5.00 General Radio 4.35

POTENTIOMETERS
1.25 Pucent 1.10
1.50 Amisco 1.25
1.50 Outler Hammer 1.15
1.50 Cleonor 1.25

MISCELLANEOUS
Ambraser Coils 4.95
Cockaday Coils, Precision 4.50
Cockaday Coils, Tastorm 3.35
Amplex Grid Dancer 1.10
Lafite Resistances, 45,000 ohms 1.10
42.00 Retenard Con. 1.40
Eula Crystals85

ALL MAIL ORDERS SHIPPED PROMPTLY. Orders over \$5.00 will be shipped prepaid. Money orders or C.O.D. Ret insured unless insurance charges included. Write for Price List.

\$3.50

SHAMROCK
Vario-Couplers

SHAMROCK engineers have designed an instrument that has won instant recognition with both radio experts and discriminating amateurs. There is no other variocoupler on the market that embodies both the following features:

(1) Pig Tail connections. This gives the Shamrock Vario-coupler 50 per cent more efficiency than variocouplers with spring connections.

(2) Concentric Centers. This means that both the primary and secondary coils have the same center of rotation. This feature gives a balanced change of inductive field when the variocoupler is rotated.

Mail coupon for information on this efficient instrument.

SHAMROCK MANUFACTURING COMPANY
315 E. Market St., Newark, N. J.
Shamrock for Selective Tuning

SHAMROCK MANUFACTURING CO., 315 E. Market St., Newark, N. J. Gentlemen:

Send me, without obligation, literature on the Shamrock Vario-couplers.

Name

Address

FAHNESTOCK'S
RADIO PRODUCTS

Improved Ground Clamp
Equipped with Fahnestock Patent Wire Connectors Easily Attached.

No Soldering—For Radio Use Only
Our name stamped on all our products. None genuine without it.

FAHNESTOCK ELECTRIC CO.
Long Island City, N. Y.
Dealers can obtain Fahnestock Products from following distributors:

NEW YORK
Sparks Elec. Co. BOSTON
Westmore-Savage Co. F. D. Pitts Co. DETROIT
Detroit Electric Co. CHICAGO
Baravik Co. MILWAUKEE
Julius Anderson Sons Co. PHILADELPHIA
H. C. Roberts Elec. Supply Co. PITTSBURG
Ludwick, Hommel Co. WESTERN DISTRIBUTORS
Marshall & Co., Los Angeles, Cal.

WALNART
New Inductance Switch

One to ten points. Only one hole to drill, smooth, positive contact. Solder terminals. Genuine Bakelite numbered dial. Simply and quickly installed. Fits any panel.

\$1.00 List Variable Grid Resistance

The base of this instrument is Continental Bakelite Dielectric XX, the perfect dielectric insulation (licensed under Bakelite patents).

WRITE FOR ILLUSTRATED FOLDER

WALNART ELECTRIC MFG. CO.
LIST \$1.25 Complete with Dial. 1249 W. Van Buren St. Dept. 426 CHICAGO

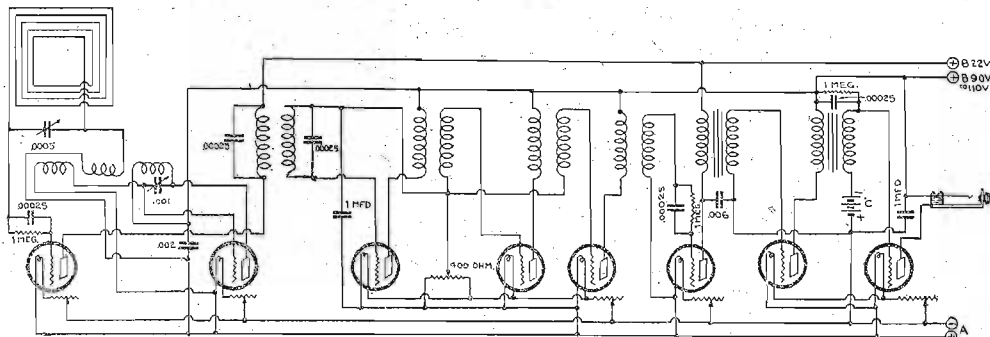

Figure 2.

SUPER-HETERODYNE

(Continued from page 25)

variations will give the fan some idea of the investigation and research that is necessary in order to properly present the final construction article of a super-heterodyne circuit, that has really been developed after analysis, test, research and construction of all the various designs ever known or contemplated.

(TO BE CONTINUED.)

Tube Gauged by Sound

Do not attempt to obtain strong signals by seeing how brightly you can make the vacuum tubes of your set burn.

This advice can hardly be repeated often enough. While it is true that turning on tubes of maximum brilliancy may mean, in some instances maximum signals, the test of the correct amount of voltage to be used in making the tubes light is not the degree of brilliancy of the light, but the quality of the sounds produced in the head phones.

The light given off by the heater filament of the tubes has nothing to do with

the operation of the tubes. It is the amount of heat produced in the filament by the resistance offered by the filament to the flow of the electric current through it that controls the action of the tube.

That is, the more current that flows through the filament the hotter the filament becomes. If too great a current is passed through the filament it will burn out. When the filament becomes hot, electrons, which are negative charges of electricity, fly out of the filament. If they did not, the tube would not operate.

The higher the filament is heated the greater the number of electrons that fly from the filament, up to a certain limit determined by the construction of it and the material of which it is made.

As the filament is heated it becomes incandescent; that is, it gives off light.

The more it is heated the stronger the light it gives. But it isn't the light that causes the electrons to fly from the filament. It is the heat. If the filament became heated but did not give off a single ray of light, the electrons would fly out of it just the same, but the lack of light would not affect the operation of the tube at all.

Function of a Potentiometer

A potentiometer is not a variable resistance. It is a voltage supply device arranged to vary the voltage supplied to some auxiliary circuit.

PANELS

7 x 10.. \$0.95	7 x 18.. \$1.65	7 x 26.. \$2.40
7 x 12.. 1.10	7 x 21.. 1.55	7 x 28.. 2.50
7 x 14.. 1.30	7 x 24.. 2.25	7 x 30.. 2.75
9 x 14.. 1.75	9 x 18.. 2.25	9 x 21.. 2.50
12 x 14.. 2.25	12 x 18.. 3.00	12 x 21.. 3.30

3/8" thick—Black—1/4" add 25%
Send money order or pay Postman
UNION RADIO COMPANY
114 N. Union St. Akron, Ohio

Radio Supplies at Cut Prices

BATTERY CHARGERS	
Donner Type Charger.....	\$ 3.21
Homocouplers.....	13.25
CONDENSERS	
Crosley D.....	1.80
Brooks-Tully No. 45.....	3.68
Bremser-Tully No. 45.....	4.39
17 Plate Standard.....	1.02
23 Plate Standard.....	1.02
23 Plate Verner.....	1.98
VARIOCOUPERS AND VARIOMETERS	
AC Dayton Coupler.....	5.35
AC Dayton Variometer.....	4.88
LOUD SPEAKERS	
Manhattan.....	19.20
Western Electric 521 W.....	17.50
Baldwin Standard.....	19.25
BB Magnavox.....	24.80
MI Magnavox.....	24.80
Western Electric 25-D.....	24.80
Western Electric Vic. Att.....	9.25
Baldwin G Unit.....	5.21
NEUTRODYNE PARTS	
Valley Special complete parts for 5 tube set including sensitive Permian Panel.....	29.10
Alc. Core Transformation.....	1.13
Neutrodyne.....	1.59
TRANSFORMERS	
Amie Audio.....	3.55
No. 42 Jefferson Trans.....	3.15
No. 21 Jefferson Trans.....	3.35
Dayton Fan Trans.....	24.80
Kilbuck Trans.....	2.09
Genaco Trans.....	3.25
General Radio Trans.....	3.95
PHONES	
Western Electric.....	6.50
Baldwin E. H......	4.45
Best.....	2.95
SETS	
Precision Ace.....	\$14.95
Crosley VI.....	21.25
Crosley XJ.....	46.75
5, 7, 9 Neutrodyne 5 tube and specifications.....	57.50
Complete parts Super Heterodyne 5 tubes.....	96.20

Write for Agent's Price List.
Always include Parcel Post and Insurance.
VALLEY RADIO SUPPLY CO.
2206a Locust St. ST. LOUIS, MO.

Variocouplers and variometers are so cheap now that it really does not pay to make them.

Don't Waste Your Time



LOOKING for stations you have had, simply copy the readings of your set according to the stations you receive in a "KASPER'S RADIO RECORD BOOK" then when you want it—IT'S THERE. Daily programs are kept separate, ample space is allotted to record 30 different stations in each daily section that you will want to hear week after week. "KASPER'S" is recognized as the only copyrighted radio book on the market in which one can readily copy a complete reading of his set, not only of the dials and switches but also the location of each rheostat controlling the detector and amplifiers. CAN BE USED WITH ANY SET—NO SET COMPLETE WITHOUT ONE. Contains up-to-date list of BROADCASTING STATIONS—TIME THE WORLD OVER, also illustrations and instructions HOW TO RECORD STATIONS. 50c per copy. Postpaid. For sale at Radio Shops and News Dealers or direct from us. When ordering from us, for your convenience send a one dollar bill for two copies or a money order for one or more. No stamps. Order today.

Kasper Brothers Company
317 Lorain Street Bank Building
Cleveland, Ohio, U. S. A.

Workman Radio Service
"THE ACCENT IS ON SERVICE"
14-16 Vesey St. NEW YORK

VARIOCOUPERS

\$3.50 Wrothello 150° Silk Wound.....	\$2.95
2.50 Fisher, Large, 80°.....	2.75
2.75 Fisher, 150°.....	2.25
4.25 Special Bank Wound Coupler for Hayes Circuit (with diagram).....	3.25
7.00 Ambassador Coupl. (with diagram).....	3.50

VARIOMETERS

\$3.50 Wrothello.....	\$2.95
2.50 Fisher, Standard.....	2.05
2.50 Fisher, Large.....	2.05

CONDENSERS

\$2.00 R. C. 11 plate.....	\$1.05
2.25 R. C. 12 plate.....	1.25
2.75 R. C. 43 plate.....	1.65

VERNIER CONDENSERS

\$1.00 R. C. 23 plate.....	\$2.25
5.00 R. C. 43 plate.....	2.95

PHONES

\$18.00 DR. SEIBT IMPORTED "SUPER HEADSET"
\$12.00 N. & W. Imported.....\$5.90

The above items are just a few of our numerous attractive priced articles, which are contained in our BULLETIN OF RADIO PARTS. Gladly sent to you upon request.

We specialize in the FAMOUS AMBASSADOR LONG DISTANCE CIRCUIT, write for list of parts for this set. Either single or three tube set. Price of parts for one tube set.....\$15.00
Price of parts for THREE TUBE SET.....29.90

We are headquarters for "Radion" and "Bakelite Dilecto" Panels. The best panel material available. Mail orders promptly attended to. All orders amounting to \$5.00 or more will be shipped prepaid. With ship C. O. O. unless remittance accompanies order.

WEIGHS ONLY 8 OZ.

The Scientific

A 200,000.00 COMPANY stands squarely back of the guarantee on every Scientific headset

SEND NO MONEY!

20,000 TURNS
EQUIVALENT TO
3,000 OHMS

Order TODAY by Postcard and Pay Postman on arrival

LOUD SPEAKER UNIT \$2.95

2.95

POST-PAID

We Guarantee The Scientific Headset to be the greatest value on the market. Try it for five days. If not satisfactory send it back and your money will be refunded immediately. Circular on request. Dealers wanted.

THE SCIENTIFIC ELECTRIC WORKS
98 Brookline Ave. DEPT. W. BOSTON, MASS.
Agents for New York and Vicinity—AMBASSADOR SALES CO.,
74 Cortlandt St. Phone Cortlandt 6296

the New KEYSTONE RADIO \$150 LIGHTNING ARRESTERS

The new Keystone Arrestor is made of genuine Bakelite with moulded-in binding posts and provides maximum protection against lightning and static charges. Fully approved by Underwriters—should be in every aerial lead the year 'round. Absolutely weather, dust and damp proof and has no vacuum to lose—it will operate for years. This pioneer arrestor is backed by 21 years' experience in lightning arrestor design. Sold in a red box by Dealers everywhere.

ELECTRIC SERVICE SUPPLIES CO.
17th & Cambria Streets PHILADELPHIA
Mononack Bldg Chicago
50 Church St New York

W. J. TWITCHELL

JUNK YOUR SET

The new TWITCHELL AUXILIARY TUNER connected to your present set will enable you to bring in the local and short wave stations which your present set cannot get. It also cuts out all local stations so you may bring in a distant one without local interference. Copyrighted diagram of this tuner 50c, or with all parts \$9.00. Complete instrument in without outside, ready to use \$15.00. Transportation prepaid.

MY HIGHLY IMPROVED REINARTZ brings in all important stations on this Continent loud, clear and without distortion. We dance to music from Atlanta and Los Angeles.

Build one of these wonderful 8 tube sets from my blueprint and specifications, price 50c, or with a complete and perfect double-sound speaker set \$3.00 by mail. Picture of this set on a glass panel with every order. This copyrighted circuit is the most successful of any Reinartz modification yet produced, and is limited the most. Thousands are in use.

By W. J. Twitchell. Circuit is especially designed for use with the "Pickle" tube and brings out the full value of that little tube as no other circuit can. Stations 1000 miles away come in clearly on one tube. This set is small, complete, portable. For the man who wishes the highest efficiency, this is the set to build. Price of blueprint and specifications, 50c, or with complete and perfect whistles, \$3.00. Photo of set with every order. Sets built from these copyrighted plans will receive all broadcasting stations operating under the new laws. Their wave length range is from 170 to 300 meters.

All goods prepaid. These instruments are easy to build, easy to operate. Everything clearly shown.

S. A. TWITCHELL
1925 Western Avenue Minneapolis, Minn.

FIVE TUBE FADA-NEUTRODYNE

THE FADA Neutrodyne Set is without question the best Radio Set on the market. All distant stations are "local," even on a loud speaker with this set. Very selective tuning. Easy matter to get 20 or 30 stations in one evening.

We will sell you the complete genuine FADA parts for a 5 tube Neutrodyne Set and also a Mahogany Cabinet for \$69.50 and will make this set for you FREE without any charge whatever.

\$69.50

Built for You—FREE

Satisfaction guaranteed. If this set does not work to your entire satisfaction, then return, and purchase price will be refunded to you. Tubes and batteries not included.

PERFECTION RADIO CORPORATION
78 Cortlandt St. 59 Cortlandt Street, in Elliot's Drug Store
368 Livingston, at Flatbush, Brooklyn 119 West 23rd Street

How to Use an Electrolytic Rectifier

Keeping Circulation Going Within the Jar

Very little has been said on the subject of the use and care of an electrolytic rectifier for charging storage battery cells. Quite a number of Radiophans do not own a rectifier on account of the first

WORKSHOP KINKS? EARN A DOLLAR—

THERE are many little kinks worked out at home that would aid your fellow Radio worker if only he knew about them. There are new hook-ups, new ways of making parts and various unique ways of operating sets that are discovered every day. Radio Digest is very much interested in obtaining such material. Send them in with full details, including stamped envelope, so rejected copy may be returned. The work must be entirely original, not copied.

RADIO KINKS DEPARTMENT,
Radio Digest,
123 W. Madison St., Chicago

cost, and most of them do not know that a chemical rectifier will do the work as well if it is kept in proper condition. The following describes the construction and use of a lead-aluminum rectifier.

In making it, pure aluminum plate and lead must be used. Procure an ordinary two-quart glass fruit jar with a screw top. Try to get one with clear glass so that the solution can be seen and its condition determined.

The electrolyte is a solution of borax in water and should be saturated, that is, borax should be added to the water until it will dissolve no more. Do not allow any of the borax to settle to the bottom of the jar. The settleings will make a good conductor between the plates, and the rectifier will not charge. Mix the solution in a clean vessel and allow it time for settling, then pour off the clear solution at the top and use it in the jar for the rectifier.

The aluminum and lead rods can now be purchased and also rubber tops for the rods to pass through and into the solution.

After the rods are placed in the jar, connect as follows: The aluminum rod to the positive terminal of the battery, the lead to one side of a bank of three 60-watt lamps, which are placed in parallel and connected to one side of the current

CONNECTION FOR AN A BATTERY

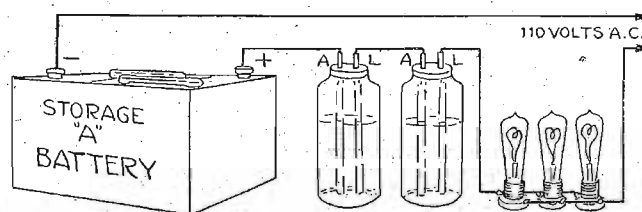

source, while the other side of the current source is connected to the negative side of the battery. When these connections are made and the current turned on,

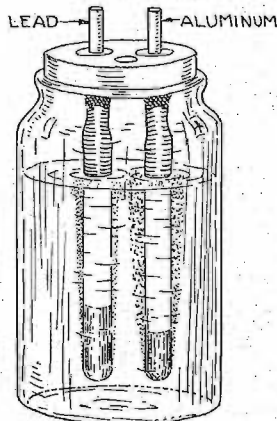

bubbles will begin to rise from the aluminum rod, showing that the rectifier is working properly.

By experimentation I found that the proper flow of current was obtained when the solution was kept in circulation, moving about in the jar. This I learned by using a rubber tube to blow air down to the bottom of the jar, thus causing commotion in the solution. To do this automatically, I wound rubber tape around the rods, starting just under the cover and continuing down on the aluminum rod to within 1 inch of the end and on the lead rod to within 1 1/2 inch of the end. The bubbles rising from the ends of the rods, caused a circulation of the solution. When the electrolyte becomes exhausted, pour it out, wash the jar and lead rod in hot water and scrape the scale from the aluminum rod and wash it also. Fill up the jar with a new saturated solution.

A one-jar rectifier is suitable for charging 24 or 48 volts of B battery, but a two-jar rectifier in series is required to charge an A battery.

In charging an A battery make connections from one side of the alternating current to the negative side of the storage battery; the other side of the source being connected to a bank of three 60-watt carbon filament lamps in parallel. The other side of the bank is connected to the lead rod of the second rectifier jar, and the aluminum rod of the latter to the positive side of the battery. It takes about

24 hours to charge a 120-hour A battery. —Herbert H. Freese, 2180 St. Clair Street, Detroit, Mich.

Crystal and Tube Set

There is a decided tendency on the part of economical fans to arrange an efficient galena detector circuit in such a way that by throwing a single switch the receiving set may be changed from the tube to the crystal detector circuit. For reaching out after distant stations the tube is unexcelled, but for programs broadcast from a nearby station a good crystal brings in the entertainments loud enough to enjoy them. In the meantime, the tubes are not drawing on the battery.

A Vital Improvement in Condenser Construction

It has always been the inevitable that when soldering wires to a fixed condenser the contact established was very poor, and after a while caused so much trouble that the condenser was thrown away. The Freshman Co. has just in-



roduced a new type of condenser with soldering lugs, so that the injurious heat of the soldering iron does not affect the capacity.

An added advantage in this type lies in the fact that the wires can be laid in the lug grooves, for test purposes, and the condenser replaced by the right value, found by experiment, and then soldered.—From March issue of Amateur Radio.

You Can Solder 3 or More Wires Easily

as the lug is equipped with three grooves, permitting the wires to be laid properly and held in place while being soldered. Manufactured in all capacities from .0025 to .015, from 35c up by Chas. Freshman Co., Inc., at 106 Seventh Ave., New York.

Ask your dealer or write to them for complete descriptive matter.

Cures the New Wave Length Troubles

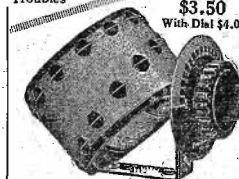

"MICROMETER" VARIOCOUPERS

A highly selective Variocoupler having 180-degree orientation and 20 antenna taps. Wound with No. 24 green single silk wire. Eighty turns on stator—500 ohm on rotor. Wire lengths range from 150 to 800 inches. All metal parts brass, highly insulated—stays "put" at any angle. Bakelite button on one tap wire permitting easy base adjustment. Micrometer is a high quality coupler at a reasonable price.

Send for Free Bulletin No. 92

Premier Electric Company

3810 Ravenswood Ave. CHICAGO

Ask Your Dealer

Little but Mighty: Cut 1/2 Size



AUDIO TRANSFORMER

We back this "little wonder" to the very limit. For all around efficiency and compactness it is unexcelled. Give it a thorough tryout. Install it in Neutrodyne, Autodyne, Superdyne, Mileplex, Autoplex, or any of the latest "hook-ups." Judge it for volume, tone quality and consistent performance. Give it every possible test. Then consider its size and price. If you do not find the "HEGEHOG" unsurpassed in every way, your money will be gladly refunded. We guarantee it unconditionally. Make this test. Ratios 1 to 3, 1 to 4, 1 to 5—\$2.50; 1 to 10—\$4.00.

Insist on Premier

NAZELEY'S PORTENA Folding Loop

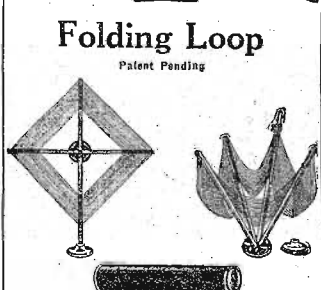

Folds up like an umbrella—Works like a charm.

Spread 28 inches

Genuine Bakelite Facings; 85 ft. green covered wire; rich mahogany finish. In an individual morocco covered tube.

List \$7 each

One Dozen to a Case

J. NAZELEY CO.

571 Hudson St. NEW YORK CITY

F-F The Triple Duty BATTERY CHARGER

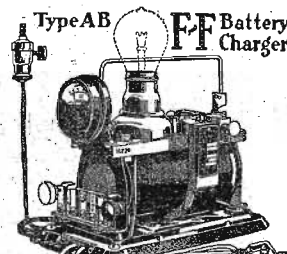

CHARGES UP TO 120 VOLTS OF B BATTERIES AT ONE TIME

THE type A. B.-F-F charger performs three duties economically. Charges radio 2, 4 or 6 volt "A" battery, radio "B" battery up to 120 volts and auto batteries. Average cost per charge about a nickel. Solidly built—will not get out of order. Fool-proof and simple. The first successful charger—introduced over ten years ago. Type A. B., price \$20; West of Rockies, \$22; Type B for 6 volt "A" or auto batteries, price, \$15; West of Rockies, \$16. "B" battery charging attachment, \$2.50 extra.

Write for literature. Including station calls, hints on battery upkeep and wiring diagrams for permanent installation of batteries. We'll furnish you name of dealer who will supply you the genuine F-F charger.

THE FRANCE MFG. CO. 10420 Berea Road, CLEVELAND, OHIO

OFFICIAL REPORT

ELECTRICAL TESTING LABORATORIES East 80th Street and East End Avenue, New York City

proves the high efficiency and remarkably low phase angle loss of less than 1 minute and a voltage breakdown test of 8,000 volts on the

"FRESHMAN SELECTIVE" Variable Condenser

It is the only variable condenser the plates of which vary in area—an engineering feat never accomplished before—making it most efficient for fine adjustment and selective tuning.

For Transmission or Reception No Leakage. No Plate Vibration. Absolutely Quiet. Cannot Short Circuit.

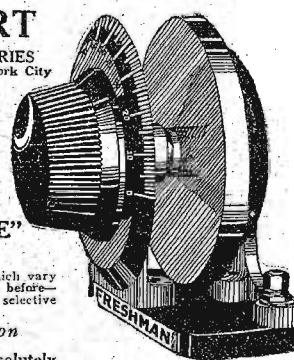

All Molded Parts and Dial of Genuine Bakelite

Chas. Freshman Co. Inc. Radio Condenser Products

106 Seventh Avenue, NEW YORK

.0005 MF (Equiv. to 17 pl.) \$5.00
.0005 MF (Equiv. to 22 pl.)
.001 MF (Equiv. to 42 pl.)

At your dealer's, otherwise send purchase price and you will be supplied postpaid.

SIMPLE ONE-TUBE CIRCUIT, R.D.-116

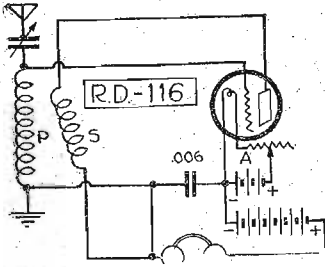

A. Bickerton of 48 Amherst avenue, Toronto, assures us that it gives him the greatest pleasure to supply us with the details of the circuit he uses.

His reception from Toronto includes C.F.A., KDKA, WGY, WOS, WJAZ, WJAX, WGR, WOR and a few others. He has had letters from KHJ, KFI and WBAP confirming the reception of their concerts. He will be pleased to supply any further information if desired, but emphasizes the importance of short leads. Variocoupler primary, 58 turns of number 20 dec. wire, 7 taps single turn, and 7 taps 7 turns; secondary, 60 turns of number 20 dec. wire. A vernier rheostat should be used; a 43-plate (.001) variable condenser with vernier was found to give the best results. The plate battery voltage was 22½. Mr. Bickerton uses a homemade variable grid leak, and suggests its proper adjustment when an outside station is tuned in rather than a local.

How to Make Silvered Dials

Very neat-looking metal dials can be easily made at home by the experimenter who wishes to build as many of his own parts as possible.

Cut a sheet of stiff brass into a circle as large as you want the dial to be, and clean it thoroughly with steel wool until it is bright. Drill a hole in the center. For the shaft, and two small holes beside this hole, for the knob. Now make a solution of sulphuric acid and clean water, using one part of water to three parts of acid. Pour the acid into the water slowly, using a glass or porcelain dish as the container. Melt some tinfoil in a

clean pan and dip the brass into it, allowing it to remain there for about fifteen seconds. Then place it in a pan of water to cool.

The finish is brought out by rubbing the surface of the dial with a cloth until the "silver" shines up brightly. The markings on the edge of the dial are then made with India ink.

The knob may be taken from an old broken dial or it can be made by cutting a piece from a broom handle, drilling a hole in the center for the shaft, painting it black, and fastening it to the dial with two small screws through the holes drilled in the dial for that purpose. A small screw driven through the side of the knob serves to hold the shaft tight. A coat of shellac or good varnish on the dial will prevent tarnishing.—J. L. Rifkin, New York City.

Distance reception depends on location, the set, the operator and, above all, climatic conditions.

RADIO TUBES, Sold, Exchanged, Repaired. Free Catalogue. AMERICAN RADIO TUBE WORKS, IRVINGTON, N. J., U. S. A.—Adv.



Dealers!

A BRAND NEW CATALOG!

Just out-crammed full of everything you want in high quality radio supplies—the most complete display in the Middle West—the biggest stocks, best discounts, quickest shipments.

This book will be sent ONLY to dealers. Ask for A1602. No others need apply.

WARM & McLAUGHLIN 225 E. ILLINOIS ST., CHICAGO

CARTER Vernier Control Rheostat

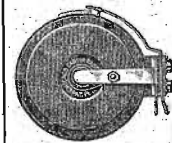

6 ohms \$1.50
20 or 30 ohms.... 1.75

No scraping.
No jerking.
No friction bearing connections.
Phosphor-bronze contact spring.
Digital connection insures positive contact.

Carter Vernier Control Rheostat gives that close adjustment so essential to successful broadcast reception, where stations operate on wave lengths but a few meters apart. A Carter Vernier Control Rheostat makes your set much more selective. Write for catalog of other Carter Products.

Carter Radio Co. CHICAGO

World's Greatest BATTERY BARGAIN

FREE Write 2-Year Guarantee Your Proof of Performance Save 50%

Thousands of Radio Digest Readers will profit by this amazing offer. They will buy the famous 3-year guaranteed World Battery at the lowest price ever quoted. They will get a hydrometer and a "B" Battery FREE. And they get the best battery built.

Compare These Prices
Five Per Cent Discount for Cash with Order
Special 9 Volt Storage Battery \$5.00
For WD-11 and WD-12 Tubes, Will run 200 hours on one charge. Rechargeable. Special 4-T. Storage Battery \$5.00

Send No Money. Just clip this ad and mail with your name and address. The battery you specify will be shipped to you the day your order is received. When the battery arrives, inspect it—read our 2-year guarantee before you pay one penny. Get the "B" Battery and hydrometer FREE. Order today.

WORLD BATTERY CO. Dept. "L" 60 E. Roosevelt Road Chicago, Ill.

Care of Crystals It is a good thing to have a small pair of pliers handy with which to pick up the minerals, because the oil on the hands will cause a coating of insulating material to form, thus destroying part of the sensitivity. Never allow hot solder to come in contact with a mineral of this kind.

Announcing MILLER PLATINE CATWHISKER

FOR the first time you are now able to get a scientifically correct catwhisker for your crystal set. Made of an imported metal especially treated.

With this durable unit which has the correct flexibility you can attain a much better contact with the crystal.

Produced by the manufacturers and originators of the famous Miller-B-Metal loud speaking crystal. This unit was not introduced until careful experiment proved you could get a clear contact without struggling.

The A. H. Miller Radio Co. 122 20th Street DETROIT, MICH.

Genuine Miller-B-Metal Crystal

\$500 IN CASH PRIZES! (NAME) (A CIRCUIT!)

\$250.00 first prize and 102 other prizes \$100.00 to \$1.00 for best names applicable to sensationally successful new Radio-Frequency hook-up using B.T. 3-Circuit Transformer. Features of this circuit: no oscillation, no re-radiation, no complex adjustments. Radio Frequency mastered! Where others end it begins. Name this circuit, win honor and money! In case of a tie duplicate prizes will be awarded. Open to everyone. This contest closes March 29. Write for details today!

BREMER-TULLY 532 S. Canal St. Chicago

Burned Out or Broken RADIO TUBES REPAIRED

All Tubes Guaranteed to Work Like New Mail Orders Given Prompt Attention 24 HOUR SERVICE—All Tubes returned P.P. C.O.D.

RADIOTRONS CUNNINGHAMS
WD-11 or 12 C-11 or 12
UV-200 C-200
UV-201 C-201
UV-202 C-202
UV-201A C-201A
UV-199 C-299
DV-1 or 2 DV-6 or 6A

RADIO TUBE CORP.

70 Halsey St. Newark, N. J.
SEND TO NEAREST REPAIR BRANCHES
"RADIO TUBES" RADIO TUBE SPECIALISTS
38 West Adams St. 137 Market St. Chicago, Ill. Phila., Pa.
GLOBE ELECTRIC CO. 609 Cham. of Com. Bldg. Pittsburgh, Pa.
WELLSTON RADIO CO. 1079 Mediamet Ave. St. Louis, Mo.
RIDENOUR, SEAVAR & KENDIG Caxton Bldg., Cleveland, Ohio

RUSONITE RADIO CRYSTAL

The Recognized Standard Crystal Rectifier Used All Over the World. Hundreds of Thousands of Satisfied Users. Rusonite Has Revolutionized Crystal Radio Reception. THE PERFECT SYNTHETIC CRYSTAL Guaranteed. Price mounted 50c. Rusonite Catwhisker 14K Gold Supersensitive; will not oxidize. Price 25c. Order from your dealer or direct from Rusonite Products Corporation 15 Park Row, New York, N. Y.

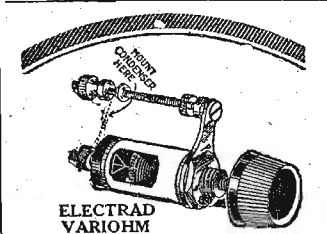

ELECTRAD VARIOHM Doubles Your Distance Eliminates Circuit Noises. The Variohm enables you to get exactly the correct grid resistance for your tubes and set. Any resistance from ¼ to 30 Megohms by simply turning the knob. Once set, stays permanently. Built like a watch, yet never gets out of order. Moisture proof and non-microphonic. Can be used with any standard fixed condenser. Price, 75c; mounted, \$1.00. At your dealers, or direct. Satisfaction guaranteed or money back.

ELECTRAD, Inc. 428 Broadway, New York, N. Y. Dept. L

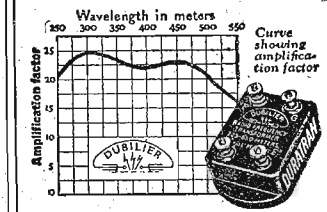

The Dubilier Duratran

The radio frequency transformer that amplifies uniformly over all broadcasting wave lengths. Price \$5.00 at good dealers.

Dubilier Condenser and Radio Corp. 44-50 West Fourth Street, New York

This Book Sells Like Hotcakes! Van's Radio Record Book

BROADCASTING STATIONS AND VACUUM TUBE CHART

A Radio Book That Sells at Sight! LISTED by all Up-to-date Listeners everywhere. USED by Broadcasting Stations. SPACE for DIAL TUNING. Make a record of it so that you can go back to any station you have heard. CALL LETTERS of each Broadcasting Station. Wave Length, Frequency Key, Distance. Power in Watts, etc. ALL AT A GLANCE!

VACUUM TUBE CHART

How to Select and Use Them. The different RADIO TUBES illustrated. Tells you what TUBES to use to get the BEST out of your receiving set. Tells you the power and current required and consumed by the different tubes from Laboratory Tests. What TUBES work best with a DRY CELL or STORAGE batteries, or on both. A storehouse of information. If you SEE this book, you will want one. That's HOW GOOD IT IS!

Price 50 Cents At Your Dealer's, Sent Prepaid on Receipt of Price. Remit by Money Order (No Stamps). VAN PUBLISHING CO. 110 Nassau Street, New York

YOU DON'T NEED TUBES

to hear concerts from out of town. If you want to get new stations ON YOUR CRYSTAL SET, write me today. I get new records every day from people using my plans who hear programs on Crystal from stations 400 TO 1000 MILES AWAY. No tubes, batteries or amplifying apparatus necessary. I hear KDKA (Pittsburgh Pa.) on Galena. You may already have everything you need and just have it connected up. Send self-addressed envelope for picture of my set, and reasons why you need my plans. LEON LAMBERT 501 South Volusia, Wichita, Kan.

Simple Explanation of Radio for Everybody

(Continued from page 28)

Superdyne Hook-Up
Figure 101 is the superdyne, now well-known to eastern amateurs and fans. It is the result of the efforts of Mr. Miner (IRU) to accomplish two things: nullify

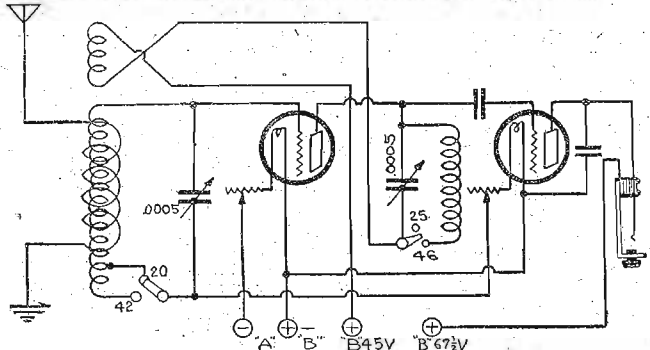

Figure 101—Superdyne nullifies the capacity feedback of the tube and permits the plate circuit to be adjusted to infinite impedance.

the capacity coupling between grid and plate, and produce resonance in the plate circuit of an R.F. amplifier. At first glance the R.F. tube seems to use the conventional feedback circuit. It does, but the energy is fed back to produce positive resistance instead of the usual negative resistance. The grid circuit is given just enough negative feedback to offset the positive capacity feedback within the tube.

With the capacity feedback nullified, it is practical to obtain absolute resonance between the grid and plate circuits, which also enables one to use maximum impedance in the plate circuit. Thus the greatest possible voltage is passed to the grid of the detector tube.

Some specifications on superdyne are as follows: Secondary, 42 turns number 22 dsc. wire, wound on a 4-inch tube for a length of 1 1/4 inches and tapped at the 20th and 42nd turns; antenna coil, 4 turns number 22 dsc. wire wound over the sec-

ondary and spaced 1/4 inch; tickler is a 3 1/2-inch ball rotor with 18 turns number 22 dsc. wire on each half, making a total of 36 turns; the plate coil, 46 turns number 22 dsc. wire wound on a 4-inch tube and tapped at 25th and 46th turns.

Grid and Plate Condensers

The grid and plate condensers are each of the 23-plate type with a maximum capacity of .0005 mfd. The dimensions and constants here given will provide a wave length range of 178 to 660 meters, or sufficient to cover both the amateur and broadcasting wave lengths. Use the style and size wire specified; good tubing of bakelite, formica, micarta or hard rubber.

A most interesting hook-up and one which is entirely logical and desirable, is shown in Figure 102. The push-pull system of amplification has proven highly efficient on audio frequencies, since there is a certain limit to the amount of energy

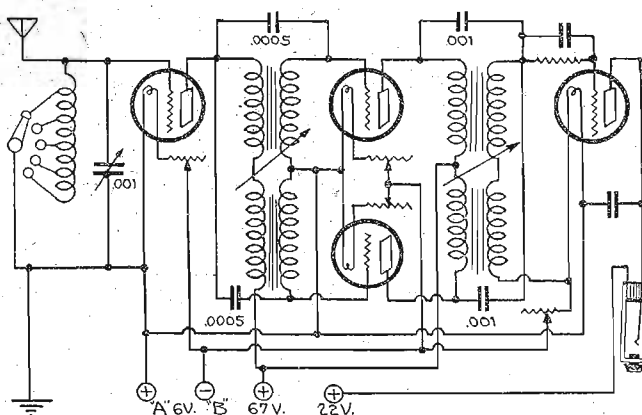

Figure 102—The push-pull adapted to R.F. amplification is easy to control and a real DX getter.

which one tube can carry and this system distributes the energy between two tubes. Why not, then, apply this system to the second stage of a Radio frequency amplifier to obtain both greater distance and increased clearness?

An air core transformer between tubes gives the greater amplification but covers only a narrow band of wave lengths; the iron core type covers the wave length range but gives less amplification per tube. A compromise must be effected; a limited amount of iron must be used and very peculiarly distributed; tuning must be provided for so that maximum amplification is obtained at any wave length. Such a device is called a "transductor" and these units are readily obtainable.

As will be seen from the diagram, the first stage consists of a single tube and

the amplified energy of its plate circuit is passed into the transductor, which to all outward appearances is a variometer. The secondaries of this variable transformer pass the energy into the grids of two tubes, from which it is collected by another transductor and passed to the grid circuit of a detector tube. The selectivity of this outfit is remarkable; the clearness most gratifying. It is well worth experimenting with.

(TO BE CONTINUED.)

Super-Heterodyne

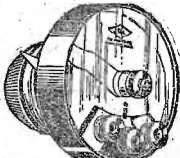

In making your heterodyne receiver use the non-inductive C R L Potentiometer to avoid noise and to get the proper biasing current on the grids of the radio frequency amplifying tubes.

No wire resistor—No Inductance—therefore no noise or choking effects to detract from the extreme sensitiveness.

Ask your radio dealer for a C R L No. 110 (400 ohms)\$1.75 No. 111 (2000 ohms)\$2.00 (By Parcel Post, 10c extra)

Central Radio Laboratories 312 16th Street Milwaukee, Wisconsin



RADIO HANDBOOK



Just off the press! The greatest book on Radio ever written. Price only \$1. Piled with sound, practical, tested information for every radio fan, from beginner to hard-boiled owl. Written, compiled, and edited by men of national reputation. Every page tells you something useful—and there are 514 pages. Mail \$1 to-day and get this I. C. S. Radio Handbook before you spend another cent on parts. Money back if not satisfied

TEAR OUT HERE
INTERNATIONAL CORRESPONDENCE SCHOOLS
Box 275-G, Scranton, Penn.
I enclose One Dollar. Please send me—postpaid—the 514-page I. C. S. Radio Handbook. It is understood that if I am not entirely satisfied I may return this book within five days and you will refund my money.
Name.....
Address.....

DEALERS PROMPT SHIPMENTS LIBERAL DISCOUNTS

"ERLA" New Type Reflex Transformers

All Erla reflex parts in stock including Hilco Variocouplers and Rathbun Condensers. Dealers send for Catalog and discounts.

Note!!
We are the largest exclusive Radio Jobbers in the Middle West.

HUDSON-ROSS

125 W. Madison St. Chicago

Infinite Adjustment

for ALL TUBES!

DESIGNED to permit infinite adjustment of current flow in vacuum tubes. Gives absolute control of electronic flow and finest tuning possible. Fil-Ko-Stat will bring in DX you never heard before and shut out noise.

30 ohms full resistance. No adjustment to puzzle. No dices to break. No Carbon Powder.

2 AT ALL DEALERS!

FIL-KO-STAT

Made and Guaranteed by
DX Instrument Co., Harrisburg, Pa.
Radio Stores Corp., 218 W. 34th St., New York
Sole International Distributors

Instruments of Excellence

Malone—Lemmon Control-o-meters the best wave trap for eliminating interfering stations and for greater selectivity \$12.50

Langbein & Kaufman Variocouplers and Variometers \$ 7.00

Malone-Lemmon Condensers 7.50

Ballantine Tuned Radio Frequency Transformers ... 9.60

Units 15.00

Curcoids—The Supreme Inductance by Means of Precision Coupling Coils... 7.50

PARTS FOR ACMEDYNE NOW IN STOCK

Amperites \$1.10
Meyers Hi-Mu Tubes..... 4.35

Radio and Mechanical Trading Corp.
23 Warren St. New York City

ON ONE TUBE

Broadcasting from Atlantic Coast, Canada, Mexico, Cuba and Hawaii heard in California by users of the CROSS COUNTRY CIRCUIT. Range due to Simplicity. One tuning control. ANY NOVICE can build easily and cheaply. Dry cell tubes used. No soldering. Complete instructions. Blue print panel layout. Assembly Photo, etc., post-paid 25 cents. Stamps accepted.

WHAT USERS SAY

EAST—Am more than pleased with the parts ordered from you. The first night I hooked it up and received Ontario. Since then Minneapolis and Los Angeles. It works better without amplification than most sets with two stages.—Donald, S. C.

WEST—I am sending you a list of some of the stations heard on one tube: WSE, WGY, WDKA, every night. WVCN, WNY, WYAM, WLVY every night. CFAC, CTCB. Not long ago I purchased another set of parts from you and first night got WGR Buffalo, and KDKA, Los Angeles, Calif.

NORTH—Received coils O. K. If I have same results with these that I had with last will be wanting more. I am 1,500 miles from nearest station and have picked 56 to date. Chicago, Havana, Mobile, New Orleans and TWO IN ENGLAND AND Lunenburg, Canada.

Send stamp for further information.
BOX RN-117
Vesco Radio Shop OAKLAND, CALIF.

Bradleyswitch

PERFECT BATTERY SWITCH

Retail Price 60c

At all Radio Dealers and Jobbers

Easily Installed In Any Radio Set

The Bradleyswitch is so easily installed that thousands of radio set users are protecting their A-batteries and tubes accidentally burning by putting a Bradleyswitch on the panel. Avoid discharged batteries due to accidental overnight burning of tubes. Be safe and install a Bradleyswitch, now!

ALLEN-BRADLEY CO.
290 Greenfield Ave., Milwaukee, Wis.

MARVEL RADIO CO

132 NASSAU ST., NEW YORK

\$110.00 Crosley Receiver, Type 3C.....	\$102.00
16.00 Crosley Receiver, Type Y.....	14.55
42.00 Crosley Receiver, Type 3B.....	39.00
12.50 Crosley Push and Pull, per pair.....	10.00
18.00 Westinghouse Rectign Charcot, A. C.....	14.63
15.50 Comtrager, "Gold Seal", A. C.....	14.95
35.00 R-3 Marconi.....	31.50

TRANSFORMERS

5.00 Acme Audio and Radio Free.....	3.95
1.00 Flouderon, Low 5.25; High.....	3.75
12.50 Com. Push and Pull, per pair.....	10.00
Erla Radio and Audio Free.....	4.20
Brands Superior, Coaxial Phones.....	4.75
10.00 Brunet French, Phones, 4000 ohms.....	6.50
5.50 New Improved Coekaday Coll.....	4.75

AMSCO VERNIER VARIABLE CONDENSERS

23 Plate, \$4.00; 43 Plate (4 in. dia).....	4.50
Ameco 5 ohm Rheostat, without dial.....	.65
Ameco 20 and 30 ohm Rheostats, without dial	.80
Radio Soldering Iron, with solder and one box soldering paste free.....	1.60

SUPER-HETERODYNE KIT, consisting of:
2 R. F. Trans. No. 1110, 1 A, P. N., 1 A. T., 3 Audio Trans., 2 By-pass Condensers, 1 Oscillo Coupler, 1 Tuned Filter Coupler, Blue Print and Manual..... 35.00

REMITTANCES MUST INCLUDE POSTAGE
Please do not send stamps

SEND FOR OUR FREE MOUNTING PRICE LIST DEPT. R. 5.

Questions and Answers

Microphonic Tubes
(1519) ATMcM, Detroit, Mich.
Your magazine is, I believe, the best I have seen for all around good Radio dope. Have just hung up after having WJAG, WOAW, WGY, etc., on a new two-tube Reflex (one bedspring upstairs is the aerial). This set is ready for four tubes but tonight I used only two, with a total of 45 volts. The point of this preamble is this: If more than a slight touch is used anywhere around the set—either tuning or a jar—the most loud and uncomfortable rattle and banging is heard in the receivers. I have the panel backed with copper foil .005 inch thick, stuck on with shellac. This same panel worked very nicely last winter with two tubes on a regenerative circuit. But since I constructed it for Radio frequency, the aforesaid racket starts without the slightest provocation. I can find no loose connection anywhere and once a station is tuned in, and no unusual vibration is caused, nor the case touched, the sending station purrs right along without a hitch, until a chair is moved or a dial touched or anything done to cause vibration. Now, is it caused, do you think, by the metal backing on the panel, or is this a peculiar feature of Radio frequency transformers, or can it be due to having all the paraphernalia of a four-tube Reflex in place but only two tubes hooked in? It is not in the receivers themselves, for they can be tapped, the cord twisted, etc., and no rattle results until some part of the case is touched. Would certainly appreciate any suggestions you can offer and as soon as convenient to you.
A.—Noting action encountered in described receiver we are advising that shielding of panel is not responsible in any sense. It may be due to the fact that

when chair is moved over the floor it jars the elements of the tube, thus changing their characteristic functioning, which causes a rattle; or, if all connections, especially those made through rotor shaft of coupler, etc., are not tight, they may be jarred sufficiently to cause a rattle. It is well to plug-tail all such connections. The source of disturbance: If the rattle gradually, rather slowly, dies away, it is in the tubes and may be overcome by mounting on felt pads. If it dies out almost immediately when scraping stops, it is in connections and remedied as advised.

R. F. in Miloplex
(05507) WES, Cleveland, Ohio.
Just a line of appreciation: An old soap box, junk parts and plenty of Plex; result first evening: Cut out WJAX (our best), and heard the following: WFAF, New York City, 492 meters; WOC, Davenport, 484 meters; WFAA, Dallas, Tex., 476 meters; WCAP, Washington, 469 meters; WJAZ, Chicago, 448 meters. Me for Radio Digest and Plex from now on.
Problem: How to add Radio frequency? A.—We thank you for your "line of appreciation." We also congratulate you on your skillful construction and resultant enthusiasm for King Miloplex.
In the matter of adding Radio frequency amplification, we have not arrived at a conclusion as to the virtue of this type

of amplification. However, as it is offered in the spirit of a progressive circuit we will not state this as final. In the meantime, try it out yourself and let us hear from you. That is a fair contribution to the general interest.

Spider Web Coils
(05123) ELG, Hartford, Conn.
Will you please give me the following information in regard to the "Three Spider Web Coil Hook-Up," published in the November 24th issue of Radio Digest? Are the three spider webs rigid or variable? What size wire is used to wind the coils and is it covered or plain? Are coils wound to the right or left?
Would this hook-up, used with dry cells, be practical; what voltage would be required on A and B batteries, and are any other changes required?

Laboratory Tested Tubes
Insure best reception. Each tube individually tested for perfect reception and high electron emission. Standard R. C. A. tubes, laboratory tested, at no increase in price.
UV-200, 201-A, 199, 11, 12 \$5.00 each postpaid
C-300, 301-A, 299, 11, 12 \$5.00 each postpaid
Central Radio Bureau
2140 Storm Street AMES, IOWA

A.—The spider web coils of circuit cited are variable.
Number 24 doc. wire is used for winding these coils. They are all to be wound in the same direction, either to the right or left.
Standard B battery potentials are indicated.
The circuit is an efficient type and will afford favorable results if properly constructed.

Vacuum tubes gradually lose their efficiency by absorbing air. This makes them "soft" and reduces their amplifying qualities. The change is very slow, however, and the tube's filament is usually about burned up before it becomes noticeable.

PATENT ATTORNEYS
PATENTS. Booklet free. Highest references. Best results. WATSON E. COLEMAN, Patent Lawyer, 644 G Street, Washington, D. C.

DEALERS SEND FOR FREE 48-PAGE CATALOG
Dealers who handle quality products should get our unusually attractive discounts.
All high grade standard sets and supplies.
All orders shipped on day received
Write TODAY for catalog
FEDERAL RADIO COMPANY
Distributors of Standard Radio Sets and Supplies
1800 Harney St. OMAHA, NEBRASKA

\$25.00 LOUD SPEAKER
with Unit and Cord for **\$9.50**
10 Inch Bell, Height 24 inches. Colors: Black, Hologray, Olive Green.
On account of the unethical methods pursued by the average Radio dealer, I have decided to sell my product direct to the consumer, thus eliminating the factory sales agent, the distributing jobber and dealer, and saving for the consumer four profits. My speaker would sell in the retail store for \$25.00. Buy direct and save the difference. My price, \$9.50, delivered anywhere in United States or Canada. Orders filled in.
EMIL DECLYNE
15 Park Row, Room 612, NEW YORK CITY
Send M. O. or C. O. D. Dept. R. D., Barclay 6598

RADIO TUBES REPAIRED
Money Back Guarantee Parcel Post C. O. D.

UV-199	\$3.00	C-259	\$3.00
UV-200	2.75	C-300	2.75
UV-201	3.00	C-301	3.00
UV-202	3.00	C-302	3.00
UV-210A	3.50	C-302	3.50
WD-11	3.00	WD-12	3.00

All Other Types \$3.00
ALL STANDARD RADIO PARTS
WESSEY RADIO COMPANY
6412 Page Blvd. St. Louis, Mo.

GENUINE RADIOTRON Tubes \$4.23
All types in original boxes

Magnavox R3	\$29.00
Magnavox R2	46.00
Welsh peanut tubes	1.49
Peanut tube sockets	.24
Dial Knobs, bakelite	.19
Sockets, standard base	.24
Rheostats, 50 ohm	.39

Cash or C. O. D. Write for Complete List
MARTIN HARDWARE COMPANY
Hamilton, Missouri

NEVER BEFORE THE SUPER-HETERODYNE
At a price not exceeding the ordinary two or three circuit sets.
CIRCUIT BLUE PRINT and DESCRIPTIVE BOOKLET
SENT PREPAID FIFTY CENTS
Use Your Extra Parts
Radio Experimenters Bureau
306 Patterson Block OMAHA, NEBR.
Better Service to the Experimenter

MAGNATRON! That's a name that guarantees tube satisfaction and real tube performance!
The MAGNATRON DC 201A and the MAGNATRON DC 199 stand foremost among tubes today. At the low new list of \$5 they are an outstanding value.
Your Dealer Has Them!
CONNWEY ELECTRIC LABORATORIES
309 Fifth Avenue NEW YORK CITY

RADIO REPAIRING BEST REBUILDING
ALL TUBES REPAIRED
Guaranteed Like New Detectors or Amplifiers... **\$2.75**
One Amp., 6 Volt Tubes Changed to 1/2 Amp. Tubes
Write Today for Tube Circular
American Radio Tube Works
Irvington, New Jersey, U. S. A.

Super-Heterodyne!
The perfect loop receiver. Gives tremendous distance, volume, and minimizes static. Get operating before winter weather starts. Complete Super-Heterodyne blue prints with full detailed information... **\$1.50**
Dealers' new list ready. Super-Hetero. & Neutrodyne. Special parts, tuner units, all circuits.
"SILVERTONE"
Remarkable "Hi-Power" coast to coast receiver.
Quality Radio Shop, Richmond, Ind.

Here Are the Names of First Persons in First Ten States and Last Persons in Last Ten States Ordering "Where I Go By Radio"
The Ideal Radio Record Book, with Unique, Complete Record System, Correct List Radio Stations, and other Useful Features; 2 Popular Editions, \$1.00, or 1 Holiday Edition, \$1.00. Between January 16 and February 9 as per Special Adv. in This Paper.
First ten—W. W. Kanoy, Chanute, Kas.; Mrs. Gertrude Gray, Lawton, Okla.; A. C. Love, Beaumont, Tex.; F. E. Reinert, Tokamah, Neb.; W. W. Park, Clatskanie, Ore.; W. R. Fleming, Norton, Va.; Robt. M. Jittus, Baltimore, Md.; L. O. Sherman, New York City; Sam'l S. Bonew, Winder, Pa.; Lev G. Baldwin, Marietta, Ga.
Last ten—John B. Jardine, Muskegon, Mich.; Claudio Argenti, Habana, Cuba; Burton Dyson, Yorkville, Conn.; A. L. Beck, Snyrer, Okla.; John H. Kam, Buffalo, N. Y.; M. C. Moore, Macdonald, W. Va.; John Hoke, New Castle, Pa.; Harry Kamm, Jr., Springfield, Ohio; Dr. F. C. Allen, Bonham, Texas; Dr. E. A. A. Dunn, Plattsville, Wis.
Orders were received from many other "24-States" in the same and other states and provinces, but above are the first and last ten as specified. Orders in that order from all ads. above 35 states, provinces and foreign countries represented.
This plan aroused such widespread interest that we will repeat it and will publish, as herein but with new final date of April 10, 1924, names of first and last persons in first and last ten states ordering 2 popular editions, \$1.00, or one holiday edition, \$1.00, by April 10th. Order today for yourself and friends, then you and others wish to get their name in our ads. Radio Dept. **PROGRESS PRESS**, Drawer D, Union, South Carolina, U. S. A.
Please send us a good kodak picture of yourself showing you using "Where I Go By Radio." May publish later. Sample "applause" cards free with every book.

CATALOG
Latest Reflex Neutrodyne and Super-Heterodyne Circuits. 40 Diagrams. Latest Hook-ups. Largest Complete Stock.
EVERY SPECIAL American Reflex
Crystal, 35c ea. Hot as Hot. Every Spot. Hear stations clearly. **GUARANTEED ONE YEAR.** Jobbers and Dealers write for Quantity Discounts.
AMERICAN RADIO MFG. CO.
WHOLESALE DISTRIBUTORS
Dept. V G West 14th St. Kansas City, Mo.

Guaranteed Head-Sets
RED-HEADS are guaranteed radio phones. You run no risk when you buy them. Money back if, after 7 days' trial, you're not satisfied that they're the best receivers on the market at the price. Why not act right now and get a pair? It'll mean getting the maximum from broadcasting from the day you put them into use.
RED-HEAD RADIO RECEIVERS
NOW READY
The new 1924 Model T "Red-Head" Jr. \$6.50 Per Pair Complete. The new "Red-Head" Jr. Complete. \$5.00 Complete.
"Red-Heads" sent prepaid on receipt of price if you are unable to get them at your dealer's.
THE NEWMAN-STERN COMPANY
Dept. R. D., Newman-Stern Bldg., Cleveland

WE REPAIR THE FOLLOWING RADIO TUBES
Dealers and Agents write for Special Discount Mail Orders Solicited and Promptly Attended to
WD-11, WD-12, Our Specialties

WD-11	\$3.00	DV-6A	\$3.00
WD-12	3.00	UV-199	3.00
UV-200	2.75	C-299	3.00
UV-201	3.00	UV-201A	3.00
C-300	2.75	C-301A	3.00
C-301	3.00	Marconi	3.00
DV-6	3.00	Moorehead	3.00
DV-1	3.00	6 V. Plain Det.	2.75
DV-2	3.00	6 V. Plain Amp.	3.00

H. & H. RADIO COMPANY
P. O. Box 22-A
Clinton Hill Station NEWARK, N. J.

AT LAST Intermediate Radio Frequency Transformers

New you can build a Super Heterodyne receiver with the confidence that you will have "The best there is." You can buy all stations and select them at will, with clear, loud speaker volume and minimum interference.
Brantson Special Transformers have been designed for this work. Rigorous tests prove them far superior to anything heretofore available.
Our publication "Super Heterodyne Construction" makes it possible for the amateur to construct a complete and efficient Super Heterodyne Receiver.
Prompt delivery. At your dealer's or write for all information.
CHAS. A. BRANTSON, Inc.
835 Main St., Buffalo, N. Y.
In Canada—Chas. A. Brantson, Ltd. Toronto, Ont.

CELERUNDUM
The Crystal With a Soul
(Reg. U. S. Patent Office)
Functions with any conductor. No Special Cat-Whisker necessary. Will not burn out... **50c**
Celerundum "DE-TEX-IT"
A perfect fixed detector. Needs no adjustment... **\$1.25**
Celerundum Products carry a MONEY BACK GUARANTEE
Celerundum Radio Products Co.
170 Summer Street, Boston

Radio

Illustrated



William Lesh, Washington, D.C., built this miniature crystal receiver, size 1 3/8 x 1/4 inches. The tuning coil of the set has thirty-five feet of wire on it. Int. Photo

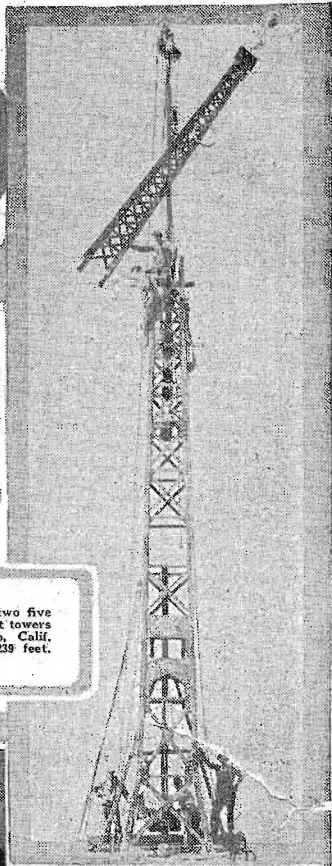

Erecting one of two five ton, sixty-five foot towers for KNJ, Fresno, Calif. Total height is 239 feet.

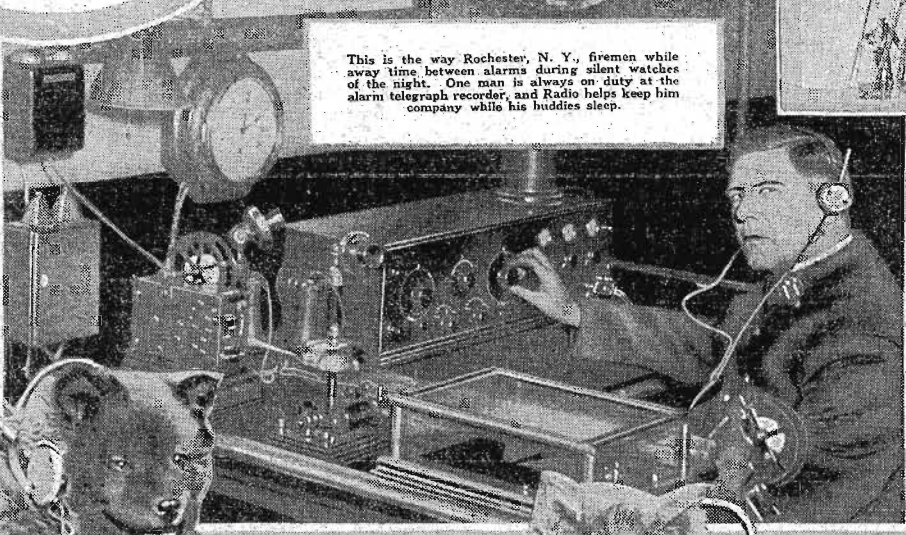

This is the way Rochester, N. Y., firemen while away time between alarms during silent watches of the night. One man is always on duty at the alarm telegraph recorder, and Radio helps keep him company while his buddies sleep.

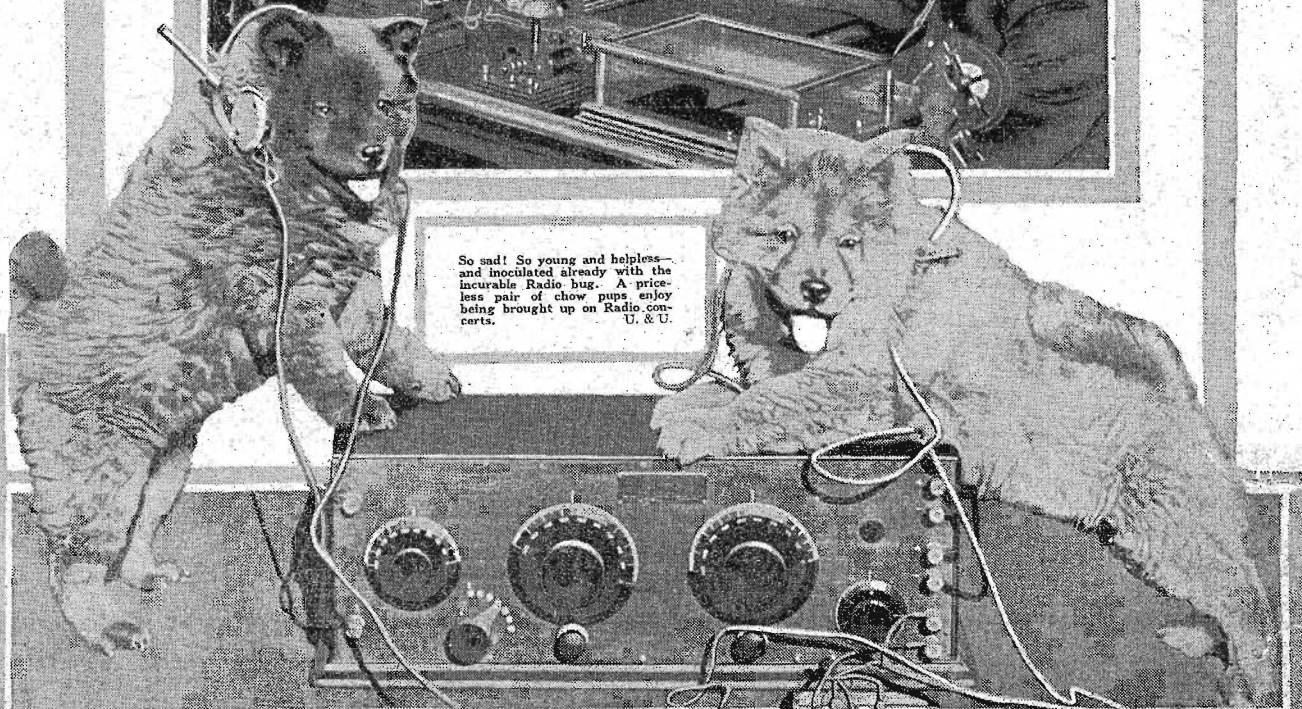

So sad! So young and helpless—and inoculated already with the incurable Radio bug. A priceless pair of chow pups enjoy being brought up on Radio concerts. U. & U.