

Radio Digest

EVERY WEEK **Illustrated** TEN CENTS

REG. U. S. PAT. OFF. & DOM. OF CANADA

Vol. IX

Copyright 1924
By Radio Digest Publishing Co.

SATURDAY, MAY 31, 1924

No. 8

A. T. & T. GETS ARMSTRONG

WGN OWNERS BUY WDAP REPORT SAYS

DRAKE HOTEL CALL MAY BECOME MEMORY

Chicago Tribune and Board of Trade
Station Principals in Rumored
Transaction

CHICAGO.—What is claimed to be a reliable source of information reports that Station WGN, the Chicago Tribune, will hold an opening program at a new location June 1. The story circulated is that the Tribune has purchased the Board of Trade station, WDAP, located on the Drake hotel, this city, and will move its call letters to the new location with the June 1 opening program.

The call WDAP will, it is said despite the shroud of mystery surrounding the transaction, be only a memory after that date.

Wave Lengths Still Unsettled

The call, WJAZ, still held by the Chicago Radio laboratory and formerly used for the station at the Edgewater Beach hotel, will go on the air again following the removal of the Tribune's participation in the operation of that station.

While generally misunderstood, the Tribune never did own the equipment of Station WJAZ. When the call was changed to WGN, representing a slogan

(Continued on page 2)



Mable Norman (above), the petite and dainty blondom star, recently gave a very amusing talk from Station WTAM. Geraldine Snyder (left), soprano solo star at Station WGR, Geneve Schafar (right), recently told WGO listeners her experiences in India and Arabia.



Cardinal Hayes Broadcasts Message from Station WEA

NEW YORK.—His eminence, Patrick Cardinal Hayes, delivered a message on Catholic charities to the radio audience of WEA, New York; WCAP, Washington, D. C., and WJAR, Providence, R. I., on a recent Sunday evening, during a program specially arranged to interest the audience of the three broadcasting stations.

The boy choristers of St. Stephen's church sang for the program. Cardinal Hayes, it is to be noted, as auxiliary bishop of New York was for some years the pastor of St. Stephen's church.

CIRCUITS ARE PROPERTY OF PHONE TRUST

Court Decision for De Forest
Really Gives Telephone
Company Most Rights

Puzzles Manufacturers

Licenses Wonder What Next Move
Will Be — General Electric
Shares Right to Make

NEW YORK.—The recent decision of the Court of Appeals of the District of Columbia which, in effect takes the patent rights to regeneration away from Edwin H. Armstrong and the Westinghouse company and gives them to Dr. Lee De Forest and the De Forest company, has the makers of regenerative sets worried and wondering just where they stand.

If the question of licenses were purely up to the De Forest company, there would be no doubt as to the granting of licenses to responsible manufacturers, and espe-

(Continued on page 3)



No. 2 OFFICIAL BALLOT

Announcers' Contest

RADIO DIGEST FIRST ANNUAL GOLD CUP AWARD

Gold Cup Award Editor, Radio Digest,
510 North Dearborn St., Chicago, Ill.

Please credit this ballot as one vote for:

..... of Station
(Announcer's name) (Call letters)

Signed

Address

5-31-24 City..... State.....

If you desire, tell below in five or less words what you most like about the announcer for whom you have cast this ballot:

FANS RUSH VOTES FOR '24 MIKE KING

GOLD CUP AWARD ROUSES WIDESPREAD INTEREST

Returns Heavy as Listeners Clip-Ballots for Favorite Announcers in Radio Digest Contest

Widespread interest has been created since the announcement last week of the First Annual Radio Digest Gold Cup Award to the most popular broadcast announcer in the world. Returns already in the office of the Radio Digest promise that this will be one of the greatest contests in which the Radiophan has ever had the good fortune to participate.

On page two is the second of the official ballots which will appear for sixteen consecutive weeks. The first appeared last week.

The gold cup to be given to the victor selected by the listeners' ballots in the 1924 competition was shown in last week's issue and is patterned after the microphone, symbolic of the gateway to the listening world, a thing of beauty both in line and symmetry and worthy of a place of honor in any station.

No Limits to Votes Cast

Remember that each ballot counts as a vote for the announcer whom you name. Any Radiophan may send in as many ballots as he desires.

The rules provide bonus votes when consecutive ballots are saved and sent in together.

It is expected that the contest will bring out a new class of announcers, men and women who enunciate clearly and speak with well-modulated voices which will provide inspiration for the listeners in. It will also help to raise standards by which the announcers are judged. From the results will be determined just what is needed to qualify as a good announcer.

The Radio Digest Gold Cup Award is to be an annual trophy to be presented to the most popular announcer in the world. Radiophans will be given the honor of picking the "king" each year to whom the gold cup will be presented.

Open to Announcers World Wide

This contest is open to every country in the world. Canada is the first country outside of the United States to nominate an announcer up to the time this issue goes to press.

Unencumbered by precedent, the announcers' contest is expected to divulge much of interest to listeners, broadcast stations, their artists and the Radio industry in general. As broadcast announcers are a large factor in the success of any station, it is expected that much interest will be aroused, and Radiophans are asked to support their favorite announcers.

Some Radiophans may be undecided as to their favorite announcer. This has been provided for by having sixteen ballots so that a Radiophan may split his vote between two or more announcers.

Nominations Being Received

Any listener in anywhere is eligible to nominate one or more well-liked announcers he may have in mind. All that the Radiophan has to do is to cut out the nominating certificate on page five, fill and send it in. This will enter the announcer in the contest so that anyone may vote for him.

Many announcers have distinguishing characteristics and little witticisms which appeal to the listening Radiophans. These undoubtedly will help some announcers to become more popular as the voting proceeds.

Regardless of the location of a station a person may nominate or vote for the announcer of that station.

Peru Hears All-Spanish Concert Sent by WHAZ

TROY, N. Y.—Broadcasting an all-Spanish concert Station WHAZ was heard in Arequipa, Peru, according to a letter received here recently.

Clear reception of the entire program with a loud speaker plugged in on the detector was reported. This transmission of four thousand miles in a direction at right angles to the aerial of Station WHAZ is regarded as remarkable. This station has been heard in New Zealand and in Norway.

Austria to Twist the Dials

WASHINGTON, D. C.—Regular broadcasting was expected to commence in Austria on July 1, a concession for the purpose having been granted to a group composed of banks and electrical firms.

BERLIN RECEIVER GETS CONCERT FROM WBAH

Sensitive Set Used in New Record for Dayton

MINNEAPOLIS.—WBAH, the Dayton company station, located here, has established a new long distance record by having been heard in Berlin, Germany. A letter received recently reads: "It pleases us immensely to be able to inform you that occasionally with the aid of our very sensitively tuned receiving apparatus in our laboratory, we have heard your sending station, WBAH."

"For instance, we recently received very clearly parts of the concert from Macalester college as well as entertainment by the third regiment band. We congratulate you for this accomplishment, and would appreciate your sending schedule of program and any technical data concerning your station."

The message was signed, S. Crin, Radio Frequenz, Gmb. H., Berlin, Germany.

WGN TAKES OVER WDAP

(Continued from page 1)

used by the Chicago newspaper, the significance was merely that the Tribune was participating in the furnishing of programs for the former WJAZ.

It is believed that the Tribune, desiring to have a station it could call its own, found it impossible to purchase the Chicago Radio Laboratory equipment and therefore negotiated the acquisition of WDAP.

At the time of writing, information regarding wave length changes was not available. It was believed however, that WJAZ would keep 370 meters and WDAP, as it becomes WGN, would still use its 360-meter wave.

Issue Measurement Circular

WASHINGTON, D. C.—The Bureau of Standards has issued a circular giving information concerning the most important instruments and measurements used in Radio work. Special attention has been given to electron tubes because of their extensive use in Radio measurements as current generators, detectors, etc.

CONTENTS

Radio Digest, Illustrated, Volume IX, Number 5, published Chicago, Illinois, May 31, 1924. Published weekly by Radio Digest Publishing Company, 510 North Dearborn Street, Chicago, Illinois. Subscription rates, year, Five Dollars; Foreign Postage One Dollar additional; single copies Ten Cents. Entered as second-class matter at the postoffice at Chicago, Illinois, under the Act of March 3, 1879.

"All the Live News of Radio".....	1 to 6
Before They Thought of "Mikes," an announcer puzzle.....	6
Operating and Trouble Shooting for Owners of a Crosley Number 51 Portable Receiver.....	7
An Evening at Home with the Listener In, a chart to show when to listen in for your favorite stations.....	8
Thirty-Minute A-B-C Lessons for Beginners, Chapter XI—The Shorthand of Radio Diagram Reading, by P. E. Edelman.....	9
Advance Programs for the Week at the Larger Stations.....	11 to 14
How to Make a Talking and Singing Suitcase, Part IX—Constructing Case and Assembling Set.....	15
How to Install a Radio Set in Your Automobile, Part IV—Dodge Installation and Tuning Unit Details, by Harry J. Marx.....	17
Spider Webs on Cam Driven Mount, Good Results Obtained with a Single Hook-up Increasing the Resistance of the Wire Rheostat, Varying the Resistance in the Filament Circuit, by R. H. Langley.....	21
Questions and Answers.....	22
Directory of Radiophone Broadcasting Stations, Part I.....	23
Radio Illustrated, a page of pictures.....	24

Looking Ahead

Installing a Radio Set in An Essex is the next installment of how to install a Radio set in your automobile. This will describe the details of the cabinet as well as the installation of the set. It is written by H. J. Marx.

Catching Your Radio Waves is an article by P. E. Edelman to appear next issue. It will show just how the Radio waves are caught and brought into your set. This is a very interesting A-B-C series and is written so that you can understand it.

A Real Hook-Up for DX Reception by one of our readers is one of the feature articles in the next issue. This is written by a real fan who likes to play with circuits that work.

Don't Forget to Pick Your Favorite Announcer—then send in the ballot, in each issue, to the Gold Cup Award Editor as a vote in favor of the voice you like the best.

Take Radio Digest with You on Your Vacation

WHEN YOU WANT

Radio Digest

YOU WANT IT!

BE SURE OF YOUR WEEKLY COPY BY SUBSCRIBING NOW

SEND IN THE BLANK TODAY

Publisher Radio Digest,
510 N. Dearborn St.,
Chicago, Illinois.

Please find enclosed check M. O. for Five Dollars (Five Dollars) for One Year's Subscription to Radio Digest, Illustrated.

Name

Address

City.....State.....

USE-IS THE TEST

Build Your Radio Set With Kellogg

Guaranteed Parts

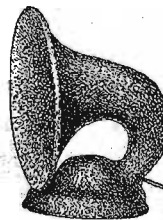

KELLOGG Reproducer fulfills all the requirements for home reproduction. The music or voice is projected clearly and distinctly with ample volume.

The horn is of special acoustical fibre which prevents the "tinny" sound.

A special Kellogg unit of 2500 ohms resistance is used which delivers the speech or music with head set clarity. A type for every use. Hear one today.

Kellogg Reproducers increase the value and pleasure of your set. If your dealer does not handle Kellogg, communicate direct with us.



Kellogg Switchboard & Supply Company
1066 W. Adams - CHICAGO

USE-IS THE TEST

HANSEN BIRD CAGE LINE

'NIGHTINGALE'

4-TUBE RADIO SET

\$32.50

WITHOUT ACCESSORIES

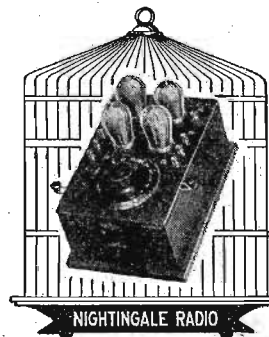

It is simplified Radio at its best and at a price within the reach of all.

It is small but has a 2000 mile range with a loud speaker.

Its small size makes it ideal for vacations or auto trips.

One stage of R. F. helps to reduce static.

Hansen **MOCKINGBIRD**.....\$90.00

6 Tube Long Distance Loop Set.....

Hansen **Meadow Lark**.....\$180.00

6 Tube Set in a Beautiful Cabinet.....

Write for Literature

DEALERS—A wonderfully attractive proposition
JOBBERs—We want one responsible and active distributor in each state.

National Distributor
HANSEN STORAGE CO.
"The Million-Dollar Warehouse Company"
RADIO DEPARTMENT
134 Jefferson Street **MILLWAUKEE**
DISTRICT DISTRIBUTORS
United Auto Supply Co.....Columbus, Ohio
Reins & Meiss Co.....Cincinnati, Ohio
Penn. Nightingale Co.....Bellevue, Pa.
Engler Radio Co.....Milwaukee, Wis.

REGENERATIVE SET BUILDERS UP TREE

NEUTRODYNE AND SUPER-HET ALSO EFFECTED

A. T. & T. and De Forest Get Big Plum Through Courts—Reversal of Patent Decision

(Continued from page 1)

cially those who have built large factories and purchased great quantities of raw materials for sets. Unfortunately however, the decision does not lie with the De Forest company.

De Forest Cannot License

The question was put to S. E. Darby, Jr., counsel for De Forest, whether, if the court sets aside the Armstrong patent, the De Forest company would license such licensees as hold rights at present from Armstrong.

"I believe," Mr. Darby replied, "the courts must set the Armstrong patent aside in the proper procedure brought for that purpose, but the De Forest company cannot grant licenses to the Armstrong licensees by virtue of its contract with the American Telephone and Telegraph company of March 16, 1917. The Telephone company can grant licenses in certain fields under the patent, but whether or not it will do so, I am unable to pass upon. The De Forest company can grant no further licenses, other than that given the Telephone company."

Does this Give R. C. A. Glimp on Others?

To dominate the Radio field has long been the goal of the Radio Corporation of America, the Westinghouse and General Electric companies and the telephone company. Internal friction there has been, but the agreements between these companies have held, because in their united action and cross-licensing lay strength and possible domination.

How strong is the tie between the phone company and its three allies? That is the question. The phone company was left out of the profits possible from manufacture of receiving apparatus and collects only royalties on the patents which it owns or is licensed to use and which it in turn licenses the others to use.

E. E. Kolds License

On this subject Mr. Darby states, "The telephone company has already granted a license to the General Electric company. It is a fundamental principle of law, however, that a licensee may not sue for infringement of a patent without joining the owner of the patent as a party-plaintiff."

"At the request of the telephone company, the De Forest company has joined as a party-plaintiff in litigation based on De Forest's patents, but the De Forest company at no time has recognized the right of the Radio corporation or the General Electric company or anyone other than the Telephone company to file suit on the De Forest patents without the De Forest company voluntarily joining as a party-plaintiff in such suit."

Thus it looks as though neither the Radio corporation nor General Electric can do anything to stop competition in the manufacture of regenerative sets without the Telephone company. And as yet the telephone company has not stated its policy on this matter.

Neutrodyne and Super-Het Affected

Other circuits than those incorporating regeneration as an asset will doubtless be affected by the far-reaching decision. The neutrodyne circuit, patents on which are now held by Professor L. A. Hazeltine, involves the control of regeneration or oscillation in tubes used as Radio frequency amplifiers.

But so broad are the rights granted Dr. De Forest in the fourteen points involved in the recent controversy that action in respect to the neutrodyne may be expected. The super-hetrodyne, "Rolls-Royce of Radio," incorporating as it does an oscillator, either in a separate tube or combined with the "first detector," must in some way come also under the new De Forest rights. Here again, comes the question of who will be licensed.

EAGLE MAKES LUNCH COUNTER OF AERIAL

CLEVELAND.—Considerable excitement was caused at Station WTAM here recently, when a large American eagle picked the station's aerial towers as a feeding place. The eagle had caught or stolen a large fish which was still alive as the eagle fed, and could be plainly seen from the street as it flopped under its captor's talons. The eagle's visit lasted over half an hour.

SNAKES COURSE NOW AT COLLEGE STATION

STATE COLLEGE, PA.—Educating the public so that they can tell a rattlesnake when it gives its warning, is the latest extension university stunt to be broadcast from Station WPAB located here. Rattlesnakes will be taken to the studio in a wire cage and coaxed to give their characteristic signals of warning. Here's your chance to hear snakes without being bitten or drinking moonshine.

URNS DIAL INSTEAD OF CRANK

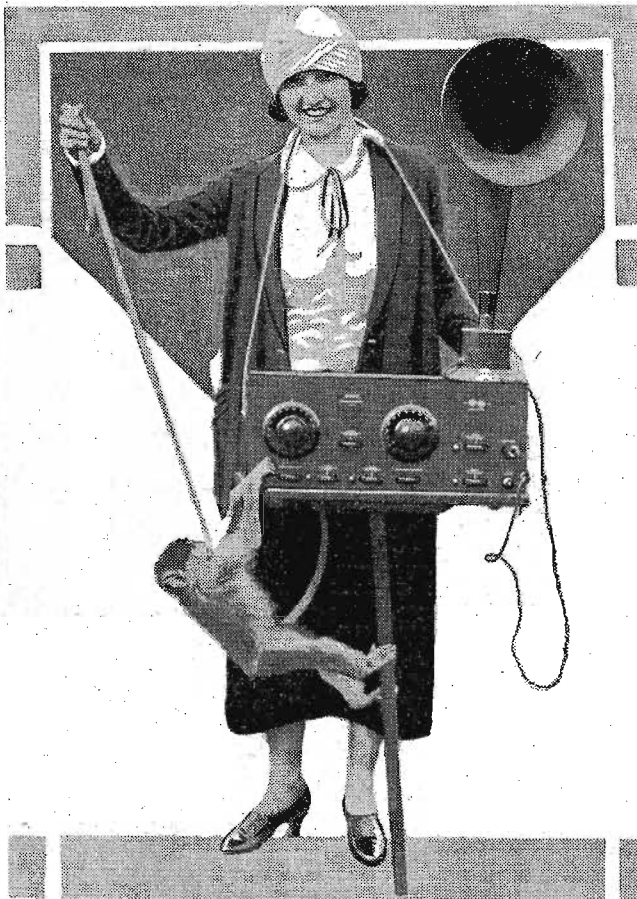

Recent visitors to New York's East Side have been surprised to find the old-fashioned hurdy-gurdy and organ grinders replaced by the more modern arrangement shown herewith. Lura Walters, who posed for this photo, claims the financial returns are well worth the investment in the Radio receiver. Photograms Photo.

First Receiving Sets on Transcontinental Trains

OTTAWA, ONT.—The Canadian National Railways is believed to be the first railroad organization to equip transcontinental trains with Radio receiving sets as a regular part of their equipment. The company has put sets in all its transcontinental trains and has established a Radio department to supervise installations and operation, according to Walter C. Anderson, a Canadian National Radio operator.

Old Fashioned Spark Sets in Navy, Doomed by Tube

WASHINGTON.—Recent Radio communication advances in the Navy include the gradual elimination of spark sets and the substitution of tube transmitting sets. Spark sets have been almost eliminated now. The employment of multiplex Radio operation, and the application of automatic recorders in the reception of Radio press reports are other advances effected recently.

NEW BROADCASTING METHOD TRIED OUT

ELIMINATES CARRIER WAVE IN RADIOPHONY

Three Distinct Advantages Are Claimed for New System; Foreign Sounds Abolished

URBANA, ILL.—Transmitting without the use of carrier waves is the latest step in Radiophony which is being conducted at Station WRM, University of Illinois, located here. Scientists connected with the institution claim that it will revolutionize broadcasting and receiving.

Tests have brought responses from all over the United States that signals, broadcast by the new method, discovered and in course of perfection at the university laboratories, came in "loud and clear."

Eliminates "Strays," Claim

Under the principle of broadcasting now in use, the carrier wave, constantly going out, conveys all manner of sounds, and only the modulation intensity of the sound frequency and the action of the detector tube or crystal in stripping the modulation frequency of its carrier wave to more or less degree, enables the particular voice or music frequency to be heard at the receiving end. More often than not the modulation frequency is not stripped of foreign frequencies borne on the carrier wave, such as static and "strays," and these, too, become audible sounds.

By means of the new device in use at the university station only the modulated frequencies of voice or music are broadcast. These, according to the college scientists, are devoid of the carrier wave tendencies to pick up extraneous frequencies.

Sending Efficiency Increased

Three distinct advantages are claimed for the new system: Tuning is made more selective at the receiving station because of the sharper decrement in tuning out the station at the receiving is easier for the same reason, and sending efficiency is increased. It is asserted that much greater distance may be covered than possible at present, with reception at 3,000 to 5,000 miles of much higher quality than possible now at 1,000 miles.

Station WRM serves the dual purpose of broadcasting the events of the institution and serving as an experimental station.

High Power Broadcast Test at Station WIP

Radiophans from Coast to Coast Listen Till Wee Hours

PHILADELPHIA.—Station WIP, Gimbel Brothers here, recently conducted a high power transcontinental broadcasting test in an effort to reach every state in the union by Radio. The station's engineering staff has been at work to increase its power output and make several tests of broadcasting apparatus.

Radiophans on the Pacific coast sat up until four o'clock in the morning listening to the high power test program, it is believed.

A program featuring many theatrical stars was broadcast. On the program were Harold Leonard and his Red Jackets; Enrico Ansoni, operatic tenor; Earl Lindsay's Cutrix Revue of 1924, from the Club Madrid; Alberta Fowler, Dottie King, Emma Sehner and Agnes Dawson, soloists; principals from "Running Wild," with the original New York cast from the Garrick Theatre, and the Adelphe Male Quartet.

Praise Sunday Concerts

CINCINNATI.—Hundreds of appreciative letters received regarding the Sunday evening symphony concerts broadcast from Station WLW, show there is a nation-wide audience of shut-ins who desire the programs to be continued. Plans have been made for continuing these under the direction of William Koop.

THE ANTENNA BROTHERS

Spir L. and Lew P.

Part IV—And So He Did

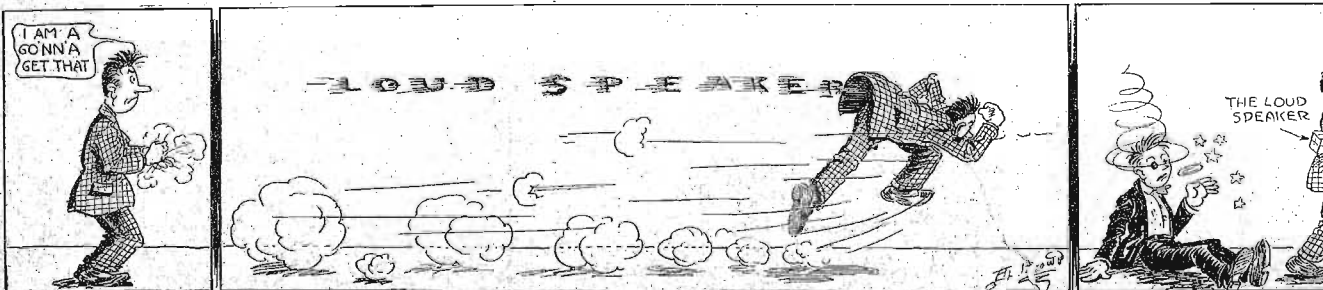

TOPSY AND EVA' GO INTO MAKING SONGS

DUNCAN SISTERS START AS MUSIC PUBLISHERS

Will Not Join American Society—Rosetta Criticizes Jazz Songs Without Sentiment or Purpose

CHICAGO.—"People are getting sick and tired of such songs as 'You've Got to Kiss Mama' and 'Two Time Dan.' They want more solid themes—something to make them think," said Rosetta Duncan when interviewed regarding her recent debut with her sister, Vivian, in the music publishing business as Duncan Sisters Music Publishers.

With their embarking on the song publishing venture came a grand opening that even made Chicago sit up and rub its eyes. Mayor and Mrs. William Dever, Chief of Police Collins, dramatic critics and stage celebrities from far and near were present.

The opening also provides a new source of good music for broadcast stations, for Duncan Sisters Music Publishers will remain independent, and will not join the American Society of Composers, Authors and Publishers or its allied interests.

Witmark Sells Out Offices

M. Witmark and Sons, New York music publishers with offices in Chicago, provided the offices and furniture for the venture of the famous sisters. Witmark, member of the American Society that is opposed to the free broadcast use of music, found business such that he closed the Chicago and all other branch offices outside of New York.

When the American Society publisher closed his Chicago office, the Duncan sisters took over his lease, bought his office equipment, hired his Chicago manager, John Conrad, as their general manager, and had their grand opening party.

Duncan Sisters Like Radio

"We are sold on the value of Radio publicity," said Rosetta Duncan. "We have observed the marvelous stimulus it has given our various shows. 'Topsy and Eva' has thrived on the few times it has gone on the air."

The Duncan Sisters Music Publishers begin their business with a catalogue of thirty-seven numbers. It is not the purpose to publish only the songs of the popular pair, but to take the best from many writers.

OPERA COMPOSER IS RADIOPHAN IN PARIS



Gustave Charpentier, famous French composer of the opera "Louise," is an enthusiastic Radiophan. He considers Radio as the future means for educating people to a greater appreciation of music.

K. & H. Photo

"Big Bill" Edwards Speaks from WEAF to Radiophans

NEW YORK.—William H. Edwards, internationally known as "Big Bill," formerly collector of internal revenue and in his competitive days captain of the 1900 Princeton football team, recently addressed WEAF's listeners for the American Olympic committee. He had as his topic, "The American Boy and the Olympic Idea."

Providence Has First Show
PROVIDENCE, R. I.—Rhode Island's first Radio show was held here recently in the State armory. "Roxie" and his "gang" from the Capitol Theater, New York, helped in the opening of the show.

Boy Scouts Hold Radio Party; Pioneer Talks

Asks Scouts to Lend Help to Enforce Ether Laws

NEW YORK.—Speaking recently before one of the largest Boy Scout audiences gathered together in a New York auditorium, Pierre Boucheron, one of the first Radio amateurs in the United States, whose entry into the ranks of the experimenter dates back to 1906, predicted that broadcasting would lead the way to the formation of an international Boy Scout organization in which the scattered groups of young men in the principal cities of the world would enjoy relationships far more intimate than any other agency has thus far been able to provide.

Mr. Boucheron also pointed out that the limited number of available wave lengths in the ether required the strict observance of laws governing Radio and asked Boy Scouts of America to pledge their support to the work of the Department of Commerce in enforcing these laws.

DETROIT COP "FLYERS" DIRECTED BY AIRWAVE

Radiophans Now Hear Emergency Calls to Their Police

DETROIT.—The Detroit police department, KOP, is now directing its "flyers" and even emergency repair trucks of the Detroit street railway, which is owned by the city, by means of its broadcast station.

It is no unusual thing now for listeners in to hear orders directed to Police truck No. 1 or Police truck No. 2. Sometimes they are ordered in or directed to another part of the city, as the occasion may require. It is quite common now to hear KOP in the air say, "D. S. R. truck No. 2. A trolley break is reported at Woodward avenue and Seven Mile road," or at some other part of the city.

In this way the police "flyers" and the street railway repair trucks, while out on service, may be directed instantly to any place desired. The new arrangement is found exceedingly efficient and a great saving to the city.

Plain type 3-plate \$1.25, 5-plate \$1.50, 13-plate \$2, 17-plate \$2.50, 23-plate \$2.75, 43-plate \$3, at dealers.



Vernier type: 13-plate \$4, 23-plate \$4.50, 43-plate \$5.50, at dealers'.

A Condenser You'll Never "Cuss"

It's built to outlast several sets. Doesn't "cut out" or develop wobbliness after brief use. "There's a Reason:" plates—instead of being spaced by wearable washers, solder, etc.—are accurately pressed and everlastingly aligned and locked in strong grooved support rods which, in turn, are securely fastened in 3/16" Bakelite end plates. Nuff sed. Insist on

WALNART VARIABLE CONDENSERS

Keep your set always at its best. Be able to tune accurately and quickly. The last place to look for trouble is in a Walnart Condenser! Let us mail you a folder of our complete line.

"Makers of good goods only"
WALNART ELECTRIC MFG. CO.
Dept 437 Chicago



The GREBE CLARIFIER

THE first practical, workable solution of the problem of radiation from regenerative receivers. Unlike the "wave-trap" it increases signal intensity.



\$30

- Increases Selectivity
- Increases Signal Intensity
- Improves Quality
- Prevents Radiation

And—
Is Easily Connected

Ask your dealer or write for literature

A. H. GREBE & CO.

Richmond Hill, N. Y.

Western Branch—461 East 3rd St., Los Angeles, Cal.

Bristol Single Control Radio Receiver

Using Grimes Inverse Duplex System
Patents Pending

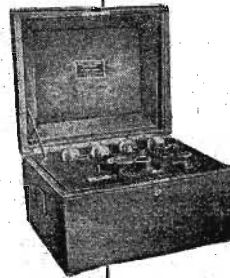

Most Simple to Operate

The set for those who want results with little effort. Anyone in the family can quickly learn to operate. It because technicalities and guesswork are eliminated—One Control Dial does it all.

Does Not Interfere With Your Neighbor

Other close by reception is not disturbed when you tune in with this non-radiating Receiving Set. It gives you a comfortable sensation of freedom to be able to change from one station to another knowing that you will not interfere with your neighbor's receiving.

Choice of Aerial or Loop

Where conditions make it difficult to install an outside aerial, as in congested sections of cities, good results can usually be had by using inside Loop. In fact, the directional feature of the Loop often brings in stations not possible with a stationary aerial.

Mounted in solid mahogany case with walnut finish, the Bristol Single Control Radio Receiver is handsome in appearance. The price is \$190.00. Bulletin AY-3013 describing this set will be mailed on request.

BRISTOL

TRADE MARK
AUDIOPHONE
REG. U. S. PAT. OFFICE



Loud Speaker

This is known everywhere as the Loud Speaker with the quality tone. Not only is the tone natural and without mechanical distortion, but is sufficiently big in volume to be easily heard in a large room or all through the house. Comes to you ready to use—no auxiliary batteries are required.

Made in three models:

- Audiophone Senior.....Price, \$30.00
- Audiophone Junior.....Price, 22.50
- Baby Audiophone.....Price, 12.50

THE BRISTOL COMPANY, Waterbury, Conn.

BEFORE THEY THOUGHT OF "MIKES"



Walter Wilson, more often known as "Uncle Bob" of Westinghouse KYW, Chicago, occupied the same position last week in the row of announcer photos, but of course he had no 285-pound smile when at the skirt wearing age.

Above, an announcer at K—, located in the great Northwest. At right above, Mr. Sch—, an announcer for W— on the Missouri river. Can you guess? Tell you about them next week.

The happy little fellow with the cherub-like smile spread all over his features, shown at the right of announcer's row last issue, is not a soul other than Edwin L. Tyson (above), famous voice of WWJ, the Detroit News, first newspaper station.

CANUCKS TO CLAIM STRONGEST STATION

CKAC IS COMPLETING NEW 7,000-WATT PLANT

French-Canadian Studio Will Be Departure in Broadcasting Rooms, Utilizing Echoes

MONTREAL.—CKAC, owned and operated here by Canada's largest newspaper, La Presse, and the acknowledged French Radio university, it is claimed, will soon boast of the most powerful station in the world. A 7,000-watt "All Canadian Make" Marconi set will send forth a message of goodwill to French Canadians scattered all over Canada and the United States at the beginning of June, when both the new installation and the entirely renovated studio will have been completed.

CKAC at present time is operating on 2,000 watts, and resorts to an all-remote control system of entertainment following the destruction of its \$80,000 studio which burned down April 26, as the consequence of a faulty flashlight apparatus used in photographing a new microphone. The transmitting room and apparatus were spared.

New Studio Revolutionary

Rebuilding of the studio will revolutionize the laws governing the interiors of broadcasting rooms. Instead of resorting to the all-felt padding, with over draperies of silk and velours, the La Presse broadcast studio will be one where echoes will prevail at their height.

The finish will be in carved ivory panelling for walls and ceiling, tiles and cork will be used for flooring. This scheme is intended for the purpose of getting the full tones out of the specially built Casavant electric pipe organ, within the studio walls. When a dulling effect is required, a system of wall curtains will be raised or lowered by electricity.

The object of the new big plant is to inaugurate what will be known as "chats about French Canada for French Canadians," and, to reach them whether in static belts or dead zones. Throughout the provinces of Quebec, Ontario, Nova Scotia and New Brunswick, there are today some two and a half millions of French Canadians, and over two million others are scattered through New England states, Michigan, Louisiana, etc.

Hoover Promises Air Conference in June

Parley Will Be Held Despite Action of Congress

WASHINGTON, D. C.—No definite date has been set by Secretary of Commerce Hoover for the third Radio conference which will be held in June. The secretary has announced that the conference will be held regardless whether or not Congress passes any Radio regulatory legislation at the present session which seems doubtful at this writing.

Details for the forthcoming conference have not yet been completed.

Walter Wilson, KYW

Did you notice the little kid last week with his legs crossed and the decidedly terrified look on his face? Well, that was Walter Wilson, the announcer that all the children like to hear.

He was born in Chicago, in the Ravenswood district about 42 years ago. Then a few years later, of course, the neighborhood was so wild that Bob used to shoot rabbits from his bedroom window. He weighs 285 pounds ringside, and every pound is made up of good nature. The children suggested that he try to reduce, but after some experimentation he surrendered as unable to do so.

The reporter who interviewed Mr. Wilson, or as he is more often called, "Uncle Bob," asked him to give a synopsis of his dark and shady past. Here it is: Eyes: Baby blue; hair: When it's clean it's black-brown, and plenty of it; servitude: Married, very much so; hobby: Pinocle and golf—19-hole golf; experience: Been in the music publishing business for twenty years, used to be a warbler in the five and ten cent stores; ambition: His one and only is to be a pal to the kiddies; aversion: Cucumbers—he agrees with them but they don't agree with him; gifts from fans: oodles 'n' oodles of homemade fudge, lamp shades (he's so bright), etc.

His creed as an announcer and bedtime story teller is simple. He says, "A man must believe in himself, otherwise how can anyone believe in him."

Mr. Wilson is the well-known story teller at Station KYW and also the famous singer of "Dream Daddy." What is more he's going to sing a brand new song soon, written by himself just for the kiddies. It's called "Uncle Bob."

CINCINNATI'S 3RD STATION ON AIR

8XBV Opens in Alms Hotel and Work Begins on New Home for WLW

CINCINNATI, O.—Cincinnati's third large broadcast station was to be on the air this week. Designated by its temporary call letters 8XBV, the new station located in the Hotel Alms, has been broadcasting test programs nightly, after midnight, during the past ten days.

A division of time was partially agreed upon at a recent conference between the representatives of the three stations, the Alms being allotted an early evening period on Wednesday evenings and the hours from 10 to 12 on Saturday and Sunday evenings. Additional time divisions will be arranged.

As the Almsworth-Gates Radio company opens its Hotel Alms station, the Crosley Radio corporation begins the erection of its new station and studio on a site some distance further from Cincinnati's downtown district than its present location. WLW will be equipped with new apparatus throughout. Plans for the studio provide glass partitions separating the reception room from the broadcasting and operating rooms, affording visitors unobstructed view of broadcasting activities.

Book publishers estimate that nearly three hundred books on Radio have been published in the past two years.

Edwin L. Tyson, WWJ

BORN in the town of Tyrone, Pennsylvania, Edwin L. Tyson decided that he would like to be a captain of finance or industry, so he entered the business field.

When war broke out, he was given the job of teaching the rookies the differences between "hay-foot" and "straw-foot." While on this job he exercised his lungs to such an extent that when war was over, he thought that he would cash in on the exercise he gained—so, he became an announcer.

Mr. Tyson is a stickler for correct pronunciation, claiming that the Radiophans pay more attention to an announcer's voice than they do to the grammar in the newspapers.

Station WWJ has two announcers so that Mr. Tyson has a pretty soft time at that. He only does half the work, while his colleague does the other half. Their voices are identical and even Mr. Tyson's wife (oh yes! he's married) is unable to differentiate between her hubby's voice and the voice of his side-kick, which of course has a lot of advantages for Edwin when he isn't where he ought to be.

But after all is said and done, Edward L. Tyson is one regular fellow, and whenever you are listening in to WWJ the chances are that you will hear his voice. Try and identify it. That's all.

WENDELL HALL TO WED BY AIRPHONE

Ceremony for "Ain't Gonna Rain" Man and Bride to Be Re-broadcast

CHICAGO.—Radiophans tune in for one of the big stations June 4. Wendell Hall, the man who sings "It Ain't Gonna Rain No Mo'." is going to be married by Radio to "The Little Girl in Chi." The ceremony is to be performed at Station WBAF and will be re-broadcast through Stations WJAR, WCAP and a Chicago station.

Mr. Hall, in relating his experiences, finds that his Radio publicity helps him in the sale of his thirty-three compositions now in print, and the nine Victor records of same which are now on the market. He is now in Chicago, dividing his two weeks' appearances among seven different stations.

WQJ MAKES DEBUT AS DANCERS WATCH

FEATURES FOR WOMEN TO GO ON CHICAGO PLANT

Rainbo Gardens and Calumet Baking Powder Company Open New Station on 448 Meters

CHICAGO.—With a display of splendor and a maize of flashing colors, Station WQJ, owned jointly by the Calumet Baking Powder company and the Rainbo Gardens here, opened recently with a gala night and an array of excellent talent.

The station is located on the mezzanine floor, on the west wing, of the million dollar Rainbo Gardens. A large plate glass on the ballroom side enables the diners and guests to watch the actual broadcasting without in the least disturbing the artists.

Schedule and Program Plans

All programs will be broadcast on a 448-meter wave length, the same as used by Station WMAQ here. To avoid interference, both broadcasters have made an agreement dividing their hours of operation.

The programs are to include talks to encourage housewives to buy at home and educating them to appreciate the standard of goods sold by local dealers.

There will also be hours, during which it is proposed to have some of the country's best style authorities describe the latest in wearing apparel, home decoration, etc.

Home Management Subjects

Helen Harrington Downing, head of the Home Economics department of the Calumet company, and other nationally known women will broadcast regularly on efficient home management.

Jerry Sullivan, musician, singer and song writer favorably known in Radio and music circles, is director of WQJ, while Phil Schwartz, better known as Uncle Phil, will be his assistant. R. J. Engler, recently of Station WOS, Jefferson City, has been recruited as engineer in charge of the station's equipment. His excellent record at the "Watch Our State" broadcaster caused his selection for the new position.

NOMINATION CERTIFICATE

Announcers' Contest

Radio Digest First Annual GOLD CUP AWARD

GOLD CUP AWARD Editor, Radio Digest, 510 N. Dearborn St., Chicago, Ill.

Dear Sir:

I nominate

Station Broadcasting Station

Signed

Address

Town State

WHITE REPORTS OUT BILL; KNOCKS TRUST

WOULD HAVE ALL ADVERTISING "LABELED"

Representative from Maine Pushes Radio Legislation—Puts Anti-Monopoly Clause in Proposed Law

WASHINGTON, D. C.—Representative White of Maine in reporting out his Radio bill from the House committee on merchant marine and fisheries, does not mince matters when he takes up the question of monopoly. He has also included in his report some interesting views of the whole Radio situation. In discussing the question of interference he says: "There has been much public discussion of the interference caused by receiving sets and many requests that legislation should be framed to prevent the use of receiving sets which radiate energy; but we do not recommend any control of receiving apparatus."

Takes Rap at Radio Trust

It is pointed out in the report, that there have been general complaints throughout the country that certain companies engaged in the manufacture of vacuum tubes and Radio sets and their parts, have been guilty of maintaining prices at unreasonable levels, of improperly restricting the use of instruments and their parts by competitors and the public, and of other practices prejudicial to the free development of the art and to the public interest. In this connection the committee in its report says:

"These evils have been obtained by various and devious means asserted by the companies to be legal, challenged as to their lawfulness by others, but felt by your committee, to be against public policy, whatever the law may now be as to them. Various sections and paragraphs of the bill are efforts to meet these and other conditions which your committee believes should be corrected."

Other Advertising Considered

In connection with advertising by means of broadcast stations, the committee says: "One of the subjects of public discussion at the present time is the extent to which broadcasting stations should be utilized for advertising purposes. Your committee has not felt justified in forbidding or undertaking to limit advertising through this medium but we are unanimous in the opinion that much the

STOPS HOWLS USING "BIRDIE" ELIMINATOR



Above photo shows Paul Edelman, Radio engineer and author of a series of beginners' articles appearing in Radio Digest, who has made a device which he used to mitigate troublesome howls created by neighboring oscillating sets.

same rule should apply to this form of advertising as applies to newspaper advertising.

"It should not be hidden from the knowledge of the hearer. Section 6 of the bill, accordingly requires that all matter broadcast for which any money or other valuable consideration is paid shall be announced as advertising at the time the same is broadcast. The section contains a provision that when the advertising or publicity consists solely of the announcement of the name and business of the person paying for the feature broadcast, it shall be sufficiently to announce 'paid for' or is 'furnished by' such person."

The bill's discussion of Radio advertising is interesting because it is practically the first official recognition of this problem.

THORDARSON

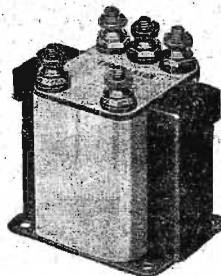

POWER AMPLIFYING TRANSFORMERS

Price per pair, \$13.00

The new Thordarson Power Amplifying Transformers (push pull) are designed for use as third stage audio frequency amplifiers, to provide high power amplification for operating loud speaking devices.

With power amplification, not only is it possible to increase volume, but, since two tubes replace the usual one, the distortion and howling which usually accompany the overloading of a single tube on the third stage is done away with entirely.

The Thordarson Power Amplifying Transformers are well constructed electrically and are capable of indefinitely carrying the additional load without breaking down.

In total purity these transformers equal the Thordarson Super Audio Frequency transformer whose rich quality and even amplification has made it the popular transformer of the day.

THORDARSON

ELECT. MFG. CO. CHICAGO
500 W. Huron St.



New Crosley Engineering Achievement

Four and Five Tube Results with Three Tube Receiver

For over a year, the Crosley Engineering Department has been working on a new circuit. This has now been perfected into an unusual radio receiving set—a triumph in radio engineering.

This remarkable set is equipped with two condenser dials, two rheostats and a slide tilter; it uses three tubes; one stage of non-radiating radio frequency amplification, regenerative detector with perfectly stabilized control of regeneration from which the signal goes back to the first tube, using that tube over again for one stage of audio frequency amplification and then traveling into the third tube, an additional stage of audio frequency.

From this combination of three "Ts"—Radio Frequency Amplification, Regeneration and Retter—we have coined the name Tri-R-Dyn, which will be written Thridyn.

Advantages Never Before Offered

The advantages resulting from this successful circuit have, to our knowledge, never before been offered. Regeneration is reduced to an absolute minimum, the signal is intensified before it goes to the detector, thus giving the detector an unusually strong signal upon which to function, and the dial can positively be calibrated to any wave length between 200 and 600 meters. With only two dials, the most inexperienced person can pick up station after station, without calibration and without difficulty, bringing stations in volume equal to any four or five tube set on the market. See this latest Crosley achievement at your dealers or write for further complete information concerning it.

For Sale by Good Dealers Everywhere

The Crosley Radio Corporation

Powell Crosley, Jr., President
Formerly

THE PRECISION EQUIPMENT CO.
AND CROSLY MANUFACTURING CO.

5495 Alfred St. Cincinnati, Ohio

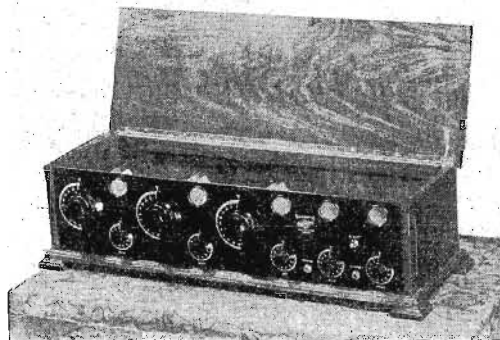

The Howard 5-Tube Neutrodyne Coast to Coast Range

Beautiful black walnut cabinet with special designed Howard Neutroformers, Neutrodones, special sockets and rheostats.

The Howard Neutrodyne brings the wonders of radio into your home and allows you to distinctly receive the famous broadcasting stations of the world.

WRITE TODAY FOR DESCRIPTIVE FOLDER OF THIS REMARKABLE SET

Howard Mfg. Co. is one of the few manufacturers licensed under Hazeltine patents to sell Neutrodyne receivers.

HOWARD MANUFACTURING COMPANY
4246 NORTH WESTERN AVENUE
CHICAGO



PROVED BY LABORATORY TESTS THE LOW LOSS GENERAL INSTRUMENT CORPORATION GROUNDED ROTOR CONDENSER

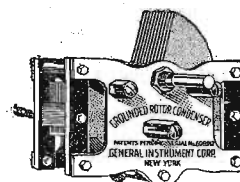

THE LOWEST LOSS CONDENSER

That explains why nationally known manufacturers of radio sets have accepted and contracted for these condensers to be used as their

STANDARD EQUIPMENT

Here are excerpts from two of the many letters received from our manufacturing customers:

"Since using your GROUNDED ROTOR CONDENSERS, we believe we will surprise the public next season not only with the best looking but also with the best operating receiving set on the market."

Another accompanies his order with the following:

"Your readings check up perfectly—your condenser improves the quality of reception to a remarkable degree. We hope the uniformity of your first shipment will always be continued."

Type	Minimum	Maximum	Price
Type 46X 11 Plate	5 MMFD.	.00025 MFD.	\$4.50
Type 46A 13 Plate	8 MMFD.	.0003 MFD.	4.50
Type 46D 21 Plate	9 MMFD.	.0005 MFD.	5.00
Type 46F 43 Plate	15 MMFD.	.001 MFD.	5.50

AT YOUR DEALER

Otherwise send purchase price direct to us and you will be supplied.

GENERAL INSTRUMENT CORP.

423 Broome Street
NEW YORK CITY

OPERATING AND TROUBLE SHOOTING

For the Owner of a Crosley No. 51 Receiver

OPERATING and Trouble Shooting" is a Radio Digest feature whose purpose is to study the late models of various standard receiving sets and to show the newly initiated broadcast listener, who has purchased such a set, how he can operate it to get the best there is in it and how he can overcome minor difficulties which may be causing some trouble. On pages 7 and 8 this week the Crosley No. 51 Receiver is described. Radiophans with other sets will also find these articles worth while reading, particularly the notes on trouble finding.

THE Crosley Model 51 portable is a two-tube regenerative receiver. It comprises a single circuit tuner, with controls for a vacuum tube detector, having a tickler in the plate circuit. This tickler makes the set regenerative. It also contains a one-stage audio frequency amplifier with transformer coupling.

The additional equipment required is: grid leak, if desired; two vacuum tubes; A battery; B battery; C battery, if desired; head phones; antenna and ground.

Grid Leak

Some manufacturers of vacuum tubes recommend the use of a grid leak. In some cases better results are obtained with the grid leak, but its use is not essential and at times is even detrimental. Spring clips on the grid condenser are provided to hold a tubular or cartridge leak. In the following paragraphs describing hook-ups for various tube combinations, you will note statement regarding use of grid leak. It is recommended that you try your set with and without grid leaks.

Vacuum Tubes

This portable set is equipped with a universal rheostat, which makes it possible to use any of the vacuum tubes now available.

The portable model is designed primarily for dry cell tubes, and a battery cabinet is provided of sufficient size to hold three standard 6-inch dry cells and three small size 22½-volt B batteries or the equivalent, thus providing for an ample power plant for continuous use over a reasonably long period of time with the popular dry cell vacuum tubes. These small size 22½-volt B batteries vary in size. Should difficulty be experienced in inserting three B batteries in the battery cabinet, we suggest that you use only two 22½-volt B batteries, or, should you desire 67½ volts, insert a third B battery in the right hand compartment which is designed to hold the headphones.

For convenience in making connections when the batteries are placed in the battery cabinet, flexible wires will be found in the battery cabinet, each wire having

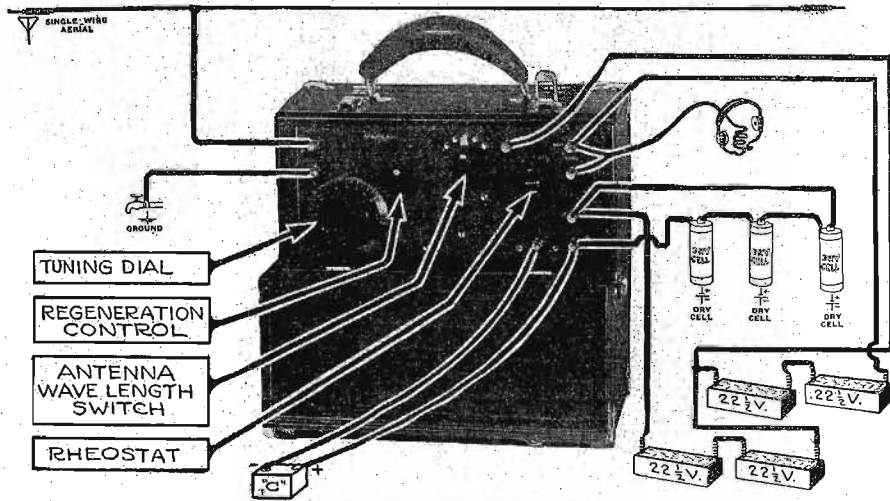

a tag indicating the correct connection. If WD-12 tubes are to be used, connect the wire marked A to the minus or negative terminal of one of the dry cells. The negative terminal of a Number 6 dry cell is the outside binding post. For WD-12 tubes the dry cells should be connected in parallel, that is, all the outside binding posts of the dry cells should be connected together and all the center binding posts should be connected together. Make the other connections as indicated and notice that the wire marked B- and A+ must be connected to both the center post of one of the dry cells and to the minus terminal of the first B battery. The B batteries must be connected in series. If you use the wire marked B 45+ to the positive terminal of the last battery.

For UV-199 tubes make the same connections except that the three dry cells are arranged in series, that is, the positive or center post of one dry cell is connected to the negative or outside post of the next dry cell.

If a C battery is not used the flexible wire marked C must be connected to the A binding post.

The Crosley 51 portable set is not designed to be operated in connection with a loop antenna. An outdoor antenna is necessary. The better the antenna the better the results. However, remarkable work may be done on a small antenna; for example, in a hotel a wire may be run across the room or around the picture molding, or a length of wire may be hung out of the window, provided the wire does not come in contact with other wires. When camping, the antenna may be tied at one end to a tree and the other end may be brought directly to the receiver. The ground connection is very important—a first class ground may be often secured even on a temporary set up—make sure you have a good ground connection.

Head Phones

A pair of sensitive head phones is required. These are connected to the upper right hand binding posts on the front of the panel. On local stations, or on powerful distant stations, a loud speaker may sometimes be used. Loud volume cannot

be expected. Connect the loud speaker to the output binding posts.

ANTENNA CONDENSER—This unit is controlled by the large knob and dial on the left hand side of the panel.

ANTENNA INDUCTANCE—This is varied by the tap switch in the top center of the panel.

VARIOCOUPLER—The plate inductance element of the variocoupler, or the tickler, is controlled by pulling out and pushing in the small knob to the left of the tap switch, and to the right of the large condenser knob and dial.

DETECTOR TUBE—The detector tube is placed in the socket on the left hand side of the set as you face it from the front. The amplifier tube is placed in the right hand socket. Both of these tubes are controlled by the same rheostat, which is operated by the knob on the right hand

side of the panel. Turning this knob toward the right turns on the filament current. Turning it to the extreme left shuts off the current completely. When the set is not in use the knob should be turned to the extreme left so that the battery will not be consumed unnecessarily.

Operation

Check all connections carefully. Turn off rheostat by rotating the knob toward the left until the contact arm is not touching the resistance winding. Place tube in socket according to above directions. Turn on the rheostat, being careful not to turn it too high. Follow the directions given for the various types of tubes. Connect head phones to the two upper right hand binding posts on the front of the panel.

(Continued on page 8)

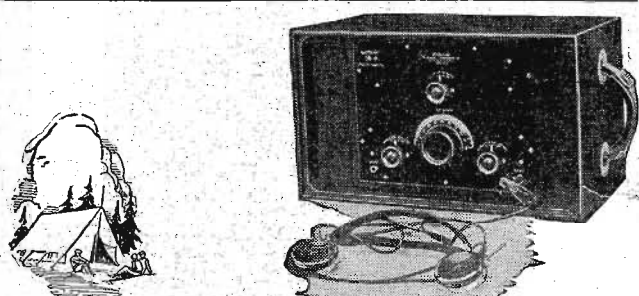

Federal No. 102 Special Set is "CONVERTIBLE"

"CONVERTIBLE" is the only word that even nearly describes the Federal No. 102 Special Receiver. It is a complete "portable" set, with dry batteries, head phones, etc., ready for immediate camp or road use,—PLUS the capacity for quick and easy changing to wet battery for city or country "home" use. True to Federal Standards, the No. 102 Special incorporates exceptional tone beauty, selectivity and distance range. Federal flexibility pervades throughout,—the No. 102 Special will operate perfectly on any tube interchangeably.

Ask any Federal dealer for a demonstration of the Federal No. 102 Special Set

FEDERAL TELEPHONE & TELEGRAPH CO.
Buffalo, N. Y.



Federal

Standard RADIO Products

Boston, New York, Philadelphia, Chicago, Pittsburgh
San Francisco, Bridgeburg, Canada, London, England.

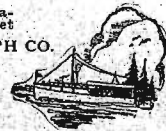

Look for this sign



Use
De Forest
Audions

DE FOREST RADIO TEL. & TEL. CO., Dept. R.D.3, Jersey City, N. J.

AN EVENING AT HOME WITH THE LISTENER IN

(SEE INSTRUCTIONS FOR USE BELOW)

Table with columns: Station and City, Met., Monday, Tuesday, Wednesday, Thursday, Friday, Saturday, Sunday. Lists broadcast schedules for various stations across the country.

Instructions for Use.—All the hours above are given in Central Standard Time. If your city uses Eastern Time, add one hour to each of the periods stated; if your city uses Mountain Time, subtract one hour; if your city uses Pacific Standard Time, subtract two hours. In addition, your city uses daylight saving time, add one hour to this result. This table includes only the evening broadcasts, and, on Sunday, the late afternoon program.

STATIONS IN ORDER OF WAVE LENGTHS USED

Table with columns: Meters Call, Meters Call, Meters Call, Meters Call, Meters Call. Lists station call letters and their corresponding wave lengths.

more carefully and bring in this sound as loud as possible. You should now hear the station.

Check antenna and ground connections carefully. The antenna must be carefully insulated from any grounded object.

Adjust the vario-coupler by pulling out or pushing in the controlling knob until the signal is perfectly clear and loud.

Test head phones by using on a receiver known to be operating properly. If this is not possible, place phone tips across the terminals of the A battery, one on the negative and one on the positive. A decided click should be heard when this is done. Connect only momentarily.

Adjust the filaments of the tubes by turning the rheostat knob on the right of the panel. A very slight adjustment of the filament often aids greatly in clearing up the received signal.

Remember that it requires some skill to tune a set with which you are not acquainted.

Use other taps of the tap switch and re-tune for different wave lengths. The wave length of the set is increased as the tap switch is moved from the left to the right.

"How to Operate and Find Trouble" next issue will be devoted to the Collin H. Kennedy portable receiver. Coming with the outdoor season the article will be appreciated by owners of Kennedy and other makes of portable sets.—Editor's Note.)

In Case of Failure to Operate. Be sure a broadcasting station is operating within the range of the receiver.

Advertisement for Myers Tubes. Features a large image of a tube and text: '30 STATIONS In One Hour! heard with one Myers Tube (name and address furnished on request). Myers Tubes are due, largely, to the elimination of socket with its bunched leads. (practically unbreakable) give you distance with clarity. They add 50% to the efficiency of any set by reducing interference. See that you get the New Improved Myers Tubes. Others are not guaranteed. Insist on Myers at your dealers otherwise send purchase price and be supplied postpaid. Two types—Dry Battery and Universal (for storage battery). Write for free circuit diagrams. \$5 EACH Complete with clips ready to mount on your set, no sockets or other equipment necessary. E. B. Myers Co. Ltd., Radio Vacuum Tubes! 240 CRAIG ST., W. Montreal, Canada.

OPERATION, TROUBLES

(Continued from page 7) Place the tap switch on the fourth tap from the left. Turn the large knob and dial in the left hand with the tickler knob pulled forward about a quarter of an inch; turn the large knob slowly from 0 to 100. The large knob and dial, together with the tap switch, control the wave length of the antenna circuit. It is necessary to tune the antenna circuit to the wave length of the transmitting station whose reception is desired. The signal is indicated by a squealing or whistling sound in the head phones. Tune

2-LO, LONDON, ENGLAND ON ONE TUBE Another Record for the ELGIN SUPER-REINARTZ

Tuesday, November 27, during the test period between 9 and 9:30 P. M., Rev. E. A. Cole in the residence of J. A. McIver, of Roodhouse, Ill., while operating a set made of materials and in accordance with the hookup furnished by the ELGIN RADIO SUPPLY CO., tuned in 2-LO, London, England, using receivers and but one tube. Later another tube was lighted and the loud speaker used, so that four people could hear the program and concluding announcement. The numbers, time, and the order in which they were played were.

Officially Confirmed by the St. Louis Post Dispatch in conjunction with the National Association of Broadcasters, who had charge of the tests. (See page 34, St. Louis Post Dispatch, Dec. 2, 1923.) This same hookup has been advertised extensively as the one which brings in stations 2000 miles overlaid on a loud speaker and one tube; and this has been demonstrated so often as to need no repetition. Send a two-cent stamp for circular giving one, two and three tube hookup, and price list of parts for this remarkable circuit. Address the ELGIN RADIO SUPPLY CO. 207 Chicago St. ELGIN, ILL.

Coto Coil Co. advertisement. Features a large image of a coil and text: 'Coto "Built First to Last" Stop the Leaks! Save all the energy in the antenna for your detector tube. This Coto Compact Air Condenser with Varmer is so perfectly insulated that losses are reduced to a minimum. Plates are of silver plated copper soldered in place for lasting adjustment. Type 3505 .0005 Mfd. \$5 Type 3510 .001 Mfd. \$6 If your dealer fails you, write us, giving his name and address. List of Coto parts you need. COTO-COIL CO. 87 Willard Ave., Providence, R. I. BRANCH OFFICES: Los Angeles, 329 Union League Bldg.; Minneapolis, 605 E. Darling, 705 Plymouth Bldg.; Atlanta, C. P. Atkinson, Atlanta Trust Co. Bldg.; CANADA, Parkin Electric Co., Ltd., Montreal.

30 Minute A-B-C Lessons for Radio Beginners

Chapter XI—The Shorthand of Radio Diagram Reading

By P. E. Edelman

IN THIS series of articles the story of Radio is told in so simple a manner that the uninitiated can follow theory and practice whether he knows anything about electricity or its application to broadcasting and reception or not. The series consists of twenty-five chapters, of which the five next will be: Chapter XII—Catching Radio Waves, Chapter XIII—The Radio Detective, Chapter XIV—Tuning In, Chapter XV—Working Through Interference, Chapter XVI—The Power Voice of Radio.

BY SHORTHAND of Radio, the picture representations of diagrams is meant. There is another Radio shorthand concerned with language, and the usual

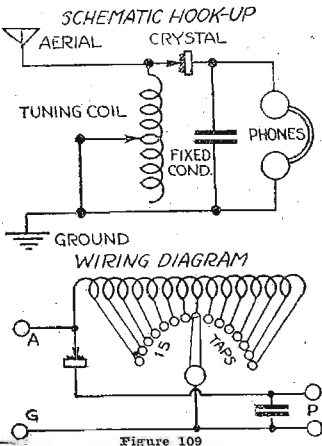
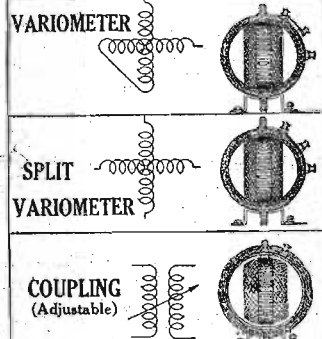

Figure 109

Radio telegraph message will be transmitted as a series of special abbreviations. The diagram represents of apparatus parts and their typical appearance is



shown in the accompanying figures. Sometimes diagrams are shown with pictured parts, but it is then difficult to follow

RADIO HANDBOOK



Only \$1
514 PAGES

Just off the press! The greatest book on Radio ever written. Price only \$1. Filled with sound, practical, tested information for every radio fan, from beginner to hard-boiled owl. Written, compiled, and edited by men of national reputation. Every page tells you something useful—and there are 514 pages. Mail \$1 to-day and get this I. C. S. Radio Handbook before you spend another cent on parts. Money back if not satisfied.

TEAR-OUT HERE
INTERNATIONAL CORRESPONDENCE SCHOOLS
Box 5276-J, Scranton, Penna.
I enclose One Dollar. Please send me—
—sent paid—the 514-page I. C. S. Radio Handbook. It is understood that if I am not entirely satisfied I may return this book within five days and you will refund my money.
Name.....
Address.....

FEED BACK (Specified size)	DYNAMO OR MOTOR (Direct current)	TELEPHONES
200 MH. COIL (Specified size)	GENERATOR OR MOTOR (Alternating current)	MICROPHONE
GROUND (Clamp)	CHOKO COIL (Iron core)	RESISTANCE (Non-inductive)
TRANSFORMER (Iron core)	POTENTIOMETER	COIL (Inductance adjustable)
COUPLER OR TRANSFORMER (Fixed, air core)	RHEOSTAT	COIL (Inductance fixed)
	CRYSTAL DETECTOR	PLUG

the connections, as location of binding posts are not usually related to the function of the part connected. Consider a vacuum tube. The best photographic il-

lustration fails to show the connections to be made as clearly as the diagram symbol.

In Figure 109, a simple receiving set

circuit is shown in two forms, one diagrammatic, and the other schematic. (Continued on page 10)

Thrills from Radio

No. 20 of a Series Featuring Experiences of "ALL-AMERICAN" Users

"I Got Honolulu from St. Paul with All-Americans"

By Meyer Tankenoff, St. Paul, Minn.

"For long distance results you don't want anything better than All-American Transformers. Am using some in my three-tube single-circuit Armstrong design set and they work fine.

"Here is what All-Americans do. Am only going to give you the long distance stations. (Of course I get everything in the U. S. and Canada.)

"On January 17, 1924, 1:30 A.M. Cen-

tral Time, I got Station KGU Honolulu—a distance of about 4,000 miles from St. Paul. It came in very clear.

"So you see what transformers will do when you get good ones. Others may fail, but not ALL-AMERICAN! You are right."

Satisfied users of All-Americans, now numbering over three-quarters of a million, have made them the largest selling and most popular transformers in the world. Buy All-Americans, know you're getting the best—and save money!

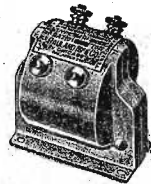

All-American Audio Frequency Transformers come in three models: \$1, \$4.50; 5:1, 10:1, \$1.75. The best—no necessity to pay more.

All the better dealers sell the "ALL-AMERICAN"

RAULAND MFG. CO., 2640 Coyne St., CHICAGO.
PIONEERS IN THE INDUSTRY

Audio and Radio Frequency; Power Amplifying (input and output)



Over three-quarter million in use. Standard on the better sets

ALL-AMERICAN
AMPLIFYING TRANSFORMERS
Largest Selling Transformers in the World



It's Capacity that Counts!

Good condensers are designed according to microfarads, not number of plates alone. U. S. Tool Condensers are designed for correct capacity.

100% GUARANTEED

End Plates of CELERON

For Superheterodyne Inverse Duplex Superdyne New Four Circuit Tuner

Use Vernoier Cap. .00057 Mfd. (24 Pl.)

or Plain Cap. .00055 Mfd. (23 Pl.)

Condensers of recommended capacity for all known circuits are also carried in stock by leading radio retailers.

Write for Booklet

U. S. TOOL COMPANY, Inc.
122 Mechanic Street NEWARK, N. J.

AMMETER 	GRID LEAK (Adjustable) 	JACK (Single circuit) 	"B" BATTERY
VOLTMETER 	VARIABLE CONDENSER (Vernier) (Movable plates) 	JACK (Double circuit) 	"A" BATTERY
GALVANOMETER 	VARIABLE CONDENSER (Movable plates) 	SWITCH (Single pole) 	"C" BATTERY
ANTENNA (Aerial) 	VARIABLE CONDENSER (Movable plates) 	SWITCH (Double pole) (Double throw) 	"BY PASS" CONDENSER (Fixed)
LOOP 	TUBE SOCKET 	VACUUM TUBE 	CONNECTION (Wire)
CONDENSER (Fixed) (Specified size) 	LOUD SPEAKER 	BINDING POST (Wire) 	NON-CONNECTION (Wire)
GRID LEAK AND COND. (Specified size) 			

THIRTY MINUTE A-B-C
(Continued from page 9)

purpose of a diagram is to illustrate the principles of the circuit rather than exact dimensions as in a working drawing. A plan diagram attempts to show the location of the parts.

"Catching Radio Waves" is the interesting title of Mr. Ebelman's next A-B-C lesson. Haven't you often wondered what catches the electric impulses that create the music and sounds you like so well? You'll learn next week.—Editor's Note.)

Homemade Fiddlestick

Fiddlestick is the name applied to a device for turning a knob slowly in vernier fashion. The one in the illustration consists of a knitting needle with a rubber spigot washer, small size, on one end. The point of the needle should be filed off and the needle forced through

the washer. With a small drill make a hole 1/4 inch from the edge of the condenser dial, either entirely through the panel or 3/4 inch deep. Drill a hole in the center of the vernier 1/4 inch deep. Place the washer far enough back on the needle

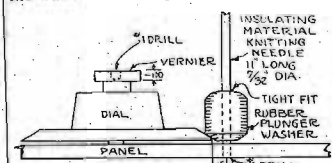

so that the end of the needle is permitted to rest in the hole. The needle can then be held at the extreme end and turned, giving a very fine adjustment.—George L. Froas, Pittsburgh, Pa.

Spacing Wires
The set builder should always remember that space is the best insulator for the high frequency currents used in Radio. Especially in a multitube reflex set the wires must be kept as far apart as possible.

The success of a reflex set depends very largely on well spaced wiring, for the balance between the circuits is very delicate and interference from one part may completely upset another. All wires should cross at right angles to each other.

THE PORTABLE AUTOMOBILE RADIO SET
Requires 2 Special Radio Frequency Transformers and Condensers

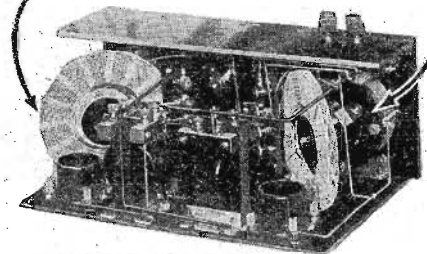

The Transformer Units Used by the Author of the Article on Page 17 are "LINCOLN BUILT" because ordinary transformers would not give the proper results. Each Unit consists of primary and secondary windings, with variable coupling and a .00025 variable condenser. **PER PAIR \$19.85**

See your dealer first. If he cannot supply you order direct. When ordering direct send money order to avoid delay.

Send for catalog of other Lincoln Products

LINCOLN RADIO CORPORATION, 224 North Wells St., CHICAGO, ILL.

S. HAMMER RADIO CO.
303 Atkins Ave. Brooklyn, N. Y. Anything and Everything in Radio

NEW COCKADAY DISTORTIONLESS AMPLIFIER

Standard Merchandise Only	Our Price	List Price	OUR PRICE
41.00 1 No-Aid Socket	\$2.50	\$12.50 Pr. Conn. Dup. P. P.	5.00
2.00 2 Marco Jacks	1.50	1.00 1 Amertran. 5 to 1	5.00
2.50 2 Amso 20 ohm Rheostat	2.00	1.00 1 Dubilier .00025	.40
2.00 1 Amso 5 Ohm Rheostat	1.50	6.00 6 Duallite .005 Cond.	3.00
2.00 1 Bradlyohn No. 25	1.50	2.00 1 Boy Binding Posts	1.50
1.85 1 Bradlyohn	1.70	1.00 1 Panel 7x12	.85

Complete parts exactly as specified by Mr. Cockaday. List Price, \$40.00. The above parts may be bought separately.

Never Before at This Price
IMPROVED COCKADAY 4 CIRCUIT RECEIVER

These Are GENUINE Complete Parts

1 Panel, 7x12	1 Durham Var. Grid Leak	1 0005 Dubilier	OUR PRICE
1 Precision Cockaday Coil	1 Bradlyohn	Pr. Conn. Dup. P. P. Trans-	5.00
2 Amso 20 Pl. Cond.	2 Patent Doub. Jacks	formers	1.25
6 Mexico Tube Sockets	1 Patent Single Jack	Panel, 1x12	5.00
1 Amso 5 Ohm Rheostat	2 American Transformers	1 Sub Panel, 5x3 1/2	1.50
1 Amso 20 Ohm Rheostat	2 Amso Switch Levers	1 7x24 Baseboard	9.75
2 Amplex Grid Drivers	3 15,000 Ohms Levitic Resist-	11 Switch Points	6.75
1 Amso 400 Ohm Potentiometer	ances	2 Switch Stops	1.50
	1 00025 Dubilier	Wire, etc.	

\$70.00

5-Tube Nourdyne
Set. Wired complete in a mahogany cabinet—Genuine Fada Parts
\$49.00

NONE SHIPPED C. O. D.

1.50 Cutler Hammer 8 ohm Vernier	1.15
1.50 Cutler Hammer 30 ohm Pl.	1.15
1.00 Patent 6, 20 or 30 ohm Brailley-Stat	.90
1.85 Patent 1x12	1.05
TRANSFORMERS	
7.00 Federal No. 85	5.25
5.00 Acus	3.75
5.00 All-American	3.50
7.00 American	5.00
12.50 Como Duplex P. P.	9.75
13.50 Modern Push-Pull	9.75
3.00 Erin	4.15
5.00 Erin Seletoformer	4.25
10.00 All-American P. P.	10.00
POTENTIOMETERS	
1.25 Patent	1.10
1.25 Patent	1.25
1.00 Cutler Hammer	1.15
1.50 Klossner	1.25
MISCELLANEOUS	
Pathe Phosphorizer	2.95
Ambrassard Coils	2.25
Cochran Coils, Presun	4.50
Cochran Coils, Barstern	3.95
32.00 Reimartz Coil	1.40
Eric Crystals	.89
Brach Lightning Arrestors	1.75
Genuine Levitic Resistances	1.10
Amplex Grid Driver	.80

ALL MAIL ORDERS SHIPPED PROMPTLY. Orders over \$5.00 will be shipped prepaid. Money orders or C. O. D. Not insured unless insurance charges included. Write for Price List.

A \$200,000.00 COMPANY
STANDS SQUARELY BACK
of EVERY PHONE

Scientific \$2.95

WORLD'S GREATEST HEADSET VALUE

SEND NO MONEY

Order by mail if your dealer cannot supply you and we will ship immediately. Written 5-day money back Guarantee with each set.

Our next year's production schedule of two million phones UN-DOUBTEDLY places us as the

WORLD'S LARGEST HEADSET MAKERS
THE TOWER MFG. CO.
98 BROOKLINE AVE. BOSTON MASS.

Five-Day Money-Back Guarantee If Not Fully Satisfied. We Guarantee the Scientific to be:

1. One of the finest phones on the market regardless of price.
2. The most comfortable—weight only 8 oz.
3. Perfect tone master.
4. Made of standard double pole construction (no single pole nonsense to save expense).
5. Made of the best materials money can buy. Powerful magnets, genuine lined cord, aluminum cases.
6. Manufactured under ideal working conditions.

How to Make a Talking and Singing Suitcase

Part II—Constructing Case and Assembling Set

By S. R. Winters

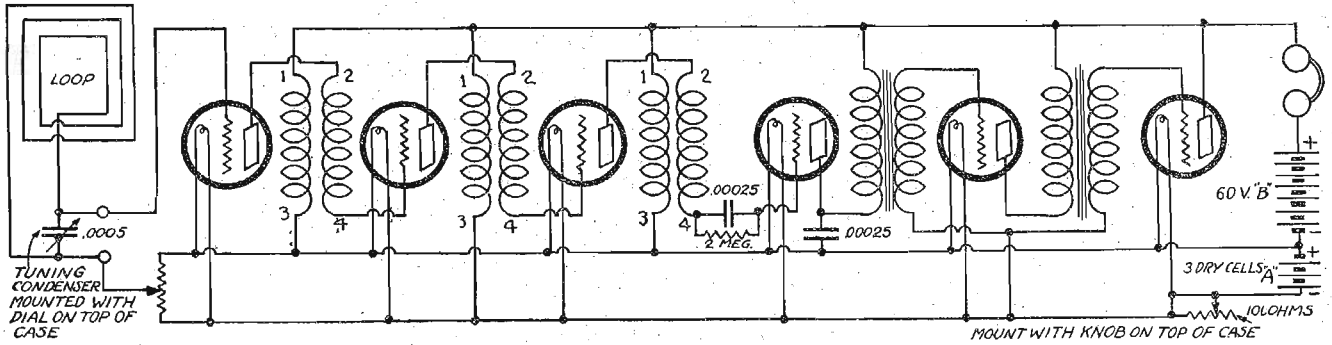

IMPROVEMENTS and refinements in the electron tube, the heart of Radio, have made possible the multitude of compact, portable radio-telephone receiving outfits of today. The self-contained set in a suitcase is no exception to the rule. From the first attempts of the Radio Laboratory of the Bureau of Standards, during the summer of 1921, to develop this type of portable equipment until the talking and singing suitcase was recently perfected and standardized the use of particular types of electron or vacuum tubes, deriving their electric energy from dry cell batteries, have been necessary.

As now constituted, this Radio-telephone receiving set in a suitcase uses six UV-199 tubes—three stages of Radio frequency, two of audio frequency and a detector. The UV-199 tube requires a minimum of energy for lighting the filament—the infinitesimal amount of .18 of a watt. The small size of this electron tube as well as its base and socket, are qualifications which makes it desirable where compact formation is an object. Due to the small size of the UV-199, the capacity between the electrodes is probably lower than that of any other vacuum tube recently developed. Similarly, by reason of the small electrical capacity between the electrodes, it is desirable in Radio circuits employing the same tube recently developed. Moreover the UV-199 does not require critical adjustment of the plate voltage, and

ing in an automobile passing over trolley or railway tracks.

Three Radio frequency transformers are employed in the talking and singing suitcase. The audio frequency transformers should have a low ratio between the windings.

Design of Transformer
An efficient design of Radio frequency transformer is said to be essential to the successful operation of the talking and singing suitcase. The use of a coil or loop antenna in such close proximity to the amplifying circuit is liable to produce trouble by reason of inter-action or play of inductance if the type of transformer is poorly designed. Efficient transformers will insure a stable arrangement and one productive of efficiency.

In the construction of Radio frequency amplifiers, the same circuit as the commonly used audio frequency circuit may be used, with the addition of a stabilizer

rheostat. By adjusting this stabilizer extreme sensitivity is obtained, thus avoiding the necessity for regenerative tuning. The tuning controls are reduced to a minimum, thus contributing to the simplicity of operation. For instance, when using five or six UV-199 tubes in this suitcase Radio receiving set only one 10-ohm rheostat, placed on top of the suitcase, and in series with the A battery, is necessary. The adjustment of the temperatures of the filament element of this type of electron tube is not critical, hence the simplicity of control. It, however, separate rheostats are employed they should be placed in the negative A battery leads.

Loop Antenna Used
The coil or loop antenna, which, together with the other integral instruments essential to a complete wireless receiving unit is enclosed in a common suitcase, consists of 13 turns of wire, which is spaced 1/4-inch apart. The strands

of the wire are threaded around a wooden frame, which is placed in one end of the leather container. Of course, a loop antenna of larger dimensions would increase the effective range in the reception of speech and music but would likewise call for an enlargement of the leather container and thereby contribute to the weight of the portable outfit. Moreover, an external aerial or overhead antenna would increase the receptive range of this (Continued on page 20)

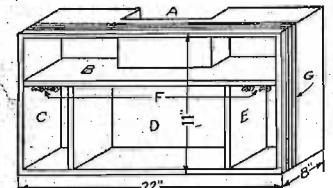

tapped plate batteries are not essential, irrespective of whether this electron tube is employed as a detector or amplifying unit.

Proper Tube to Use

Unless the virtues apparent in UV-199 are sought, the builder of this type of portable Radio telephone receiving unit is liable to encounter difficulties. For instance, the owner of the particular model of talking and singing suitcase described in this article has observed the tendency of a certain amount of interaction or inductance at play due to the close contact of the loop antenna and the amplifying circuit when bound up in a case of leather only 11 by 22 by 8 inches in dimensions. This adverse tendency can only be avoided by the use of a type of electron tube not easily susceptible to howling or given to uncontrollable oscillation. For these reasons, the WD-12 tubes were discarded in favor of the UV-199. The former design of vacuum tube, according to practical tests, appeared to be unstable in position and was otherwise troublesome by reason of the microphonic noises imparted. The use of sponge-rubber mountings as a stabilizing element did not counteract this difficulty.

On the other hand, the use of the UV-199 makes this untoward condition controllable. If microphonic noises are imparted when employing this type of vacuum tube, the trouble seems to center about the detector unit. In this case the annoyance can be surmounted by a switching of the tubes in their positions—from detector to amplifying unit sockets, and vice versa. The use of the UV-199 does not require flexible tube mountings, since the sockets may be placed rigidly without imparting microphonic noises, even when the suitcase outfit sustained severe

STA-RITE RADIO BATTERIES SAVE YOU 60%

And Guarantee You in Writing 2 Years of Better Battery Performance

STA-RITE RADIO BATTERIES are made especially for Radio and the big saving is made possible by coming direct to you instead of through distributors, dealers, etc. Boxes are made of oak, finished in mahogany and the plates very thick and will give a steady discharge over a long period. No premiums, just good, honest battery value.

TRY TO BEAT THESE PRICES

2 Volt for W. D. 11	\$4.00	6 Volt 60 Amphr.	\$ 7.50
and 12		6 Volt 80	8.50
4 Volt for U. V. 199	7.00	6 Volt 100	10.00
Tubes		6 Volt 120	12.10
Glass Jars, Heavy Plates		6 Volt 150	14.00
Case of 12 Coils,	4.90	6 Volt 200	17.00
24 V.			

Get Yours Today—NOW—Send No Money

The batteries are fully guaranteed in writing and shipped subject to examination on the day your order is received. You pay on delivery or deduct 5 per cent if full cash accompanies order. You may deduct 10 per cent if two or more are ordered at one time.

STA-RITE BATTERY CO.
Department 5 LOUISVILLE, KY.

SIMPLEX RADIO SALES CO.

1806 LaFayette Ave., Dept. C. ST. LOUIS, MO. C. O. D.

COCKADAY KIT. Complete parts for improved 5-tube set exactly as specified by Mr. Cockaday. Less Cabinet.....	\$49.75	ULTRADYNE KIT. 4 Ultradyne special transformers, 1 Tuning Coil, 1 Oscillator Coil.....	\$20.58	SUPER-HETERODYNE KIT. 3 No. 1716 Transformers, 1 Oscillo Counter, 1 Filter Chapter and Instructions.....	\$43.95	
COCKADAY PARTS		5-Tube Neutrodyne Set		SUPER-HETERODYNE		
Silk-wound Isokille Coils.....	\$ 3.19	GENUINE "FADA" PARTS		598.00 BRANSTON KIT.....	\$30.66	
Amplex Grid-denser.....	.89	1—"FADA" BAKELITE PANEL (Drilled and Engraved)		Amux 30-KC Transformers.....	4.49	
Lavite Resistance (48,000 ohm).....	.56	1—"20" Wood mounting board		7" x 4" Special Cabinet.....	5.97	
Amuxco 8-ohm Rheostat.....	.79	1—"FADA" Neutrodyne		FORMICA PANELS		
Amuxco 20-ohm Rheostat.....	.93	1—"FADA" Neutrodyne		1/2" cut any size, sq. in.....	\$0.01 1/2	
Amuxco 400-ohm Potentiometer.....	1.39	1—"FADA" Single socket.		3/16" cut any size, sq. in.....	.02	
Amuxco 25-pl. Vent. Condenser.....	5.59	1—"FADA" Triode socket.		1/4" cut any size, sq. in.....	.02 1/2	
American Transformers.....	5.59	1—"FADA" Instruction book		7" Wide—Any Length		
Congo Transformers (Dr.).....	9.19	1—"FADA" Type 4" dial		3/16" Black, sq. in.....	\$0.01 1/2	
7" x 4" Special Cabinet.....	7.42	1—"FADA" Type 6 ohm rheostat		(Moulded End Plates)		
ERLA REFLEX PARTS		1—"FADA" Type power rheostat		11 pt.....	\$9.84 Vernier.....	\$1.89
Erla Reflex Transformer.....	\$ 3.89	2—"Audio Transformers		23 pt.....	1.19 Vernier.....	2.19
Erla Audio Transformer.....	3.39	1—"Closed circuit phone jack		31 pt.....	1.54 Vernier.....	2.49
Erla Selector.....	3.89	1—"Filament control phone jack		BREMERTULLY CONDENSES		
Erla Crystal Detector.....	.79	1—"1-09225 Mica condensers		11 pt.....	\$1.94 Vernier.....	\$3.59
Hiko Variometer.....	2.58	1—"2 Meg. grid leak		23 pt.....	2.39 Vernier.....	4.98
11-pt. Rathburn Condenser.....	2.98	1—"Battery switch.....	\$65.00	43 pt.....	2.79 Vernier.....	4.70
23-pt. Rathburn Condenser.....	2.89	7—"Blind hole		AUDIO TRANSFORMERS		
BATTERY CHARGERS		Bus wire—Spaghetti Value		Hepburn, 3-1, 4-1, and 5-1.....	\$2.79	
2 Amp. Tungar Type.....	\$ 9.19	Our Price \$39.87		All American, 10-1.....	3.82	
5 Amp. Tungar Type.....	17.21			All American, 3-1 and 5-1.....	3.84	
Gold Seal Homecharge.....	13.24	SODIUM PARTS		All American Push-Pull.....	3.67	
Valley A. B. C. (new style).....	14.55	S-13 "SODIUM" Tube.....	\$4.24	Thoradexen Push-Pull.....	3.97	
\$18.00 2 Amp. G. E. Tungar.....	14.37	J-128 "SODIUM" Socket.....	.63	Acute Audio or Radio Trans.....	3.64	
\$28.00 5 Amp. G. E. Tungar.....	22.39	J-129 "SODIUM" Adapter.....	.63	WISCELLANEOUS		
CROSLBY SETS		J-129 "SODIUM" Counter.....	2.52	Brandes Superior Phones.....	\$4.99	
Model V 1-Tube Regenerative.....	\$12.79	J-130 "SODIUM" Filter.....	.84	Brandes Table-Talker.....	7.98	
Model 51 2-Tube Regenerative.....	14.79	J-131 "SODIUM" Rheostat.....	.84	Ultradine Tuning Coil.....	4.99	
Model 3B 3-Tube Regenerative.....	\$3.89			Ultradine Transformers.....	4.99	
Model X1 4-Tube Tuned R-F.....	39.07			Ultradine Oscillator Coils.....	E. 98	
Model X1-Super 4-Tube.....	61.95				E. 26	
B BATTERIES						
(Hurtag or Eveready)						
2 1/2-Volt Large Size Variable.....	\$1.89					
45-Volt Large Size Variable.....	3.88					

PRICES F.O.B. ST. LOUIS, MO.

SOLVED!

FRESHMAN

DOUBLE ADJUSTABLE CRYSTAL DETECTOR

The World's Best for crystal or reflex sets

This crystal detector makes two tubes do the work of four!

FREE! Send for Freshman Building Plan of N. Y. Times Reflex—gives panel layout, circuit and parts required. Operates Loud Speaker on two tubes!

FRESHMAN Double Adjustable Crystal Detector for panel or base use, complete with crystal.

\$1.50

Freshman Super-Crystal 50c With Non-Metallic Housing

No more searching for the sensitive spot, merely turn the knob as you would a dial!

At your dealer's; or send purchase price to be supplied postpaid.

Chas. Freshman Co. Inc.
Radio Condenser Products
106 Seventh Ave., N. Y. C.

How to Install a Radio Set in Your Automobile

Part IV—Dodge Installation and Tuning Unit Details

By Harry J. Marx

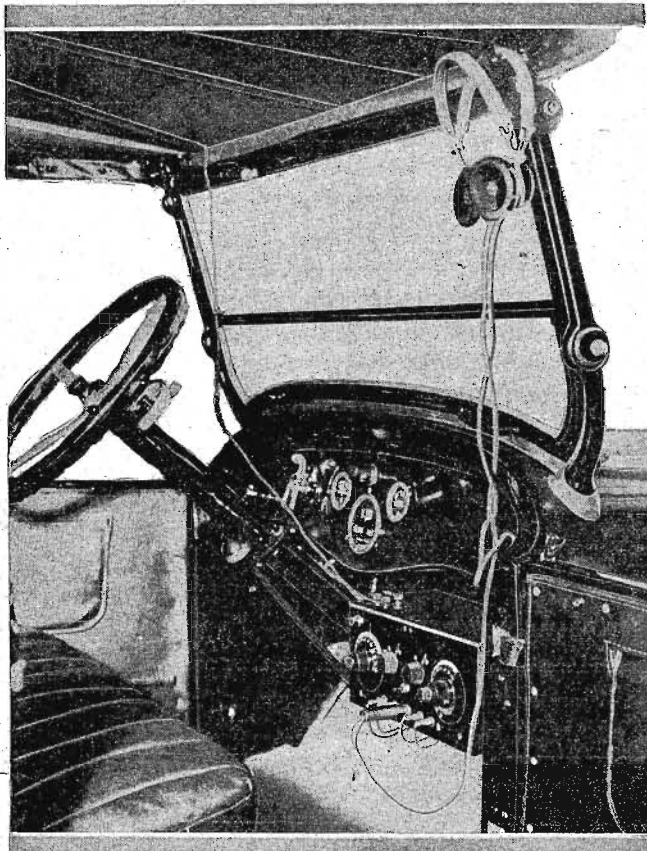

Figure 1

THE Dodge car did not present any big difficulties of installation. All it required was a little forethought and ingenuity. In this case an angle was placed somewhat in the form of a shelf brace and was fastened to the side of the chassis. The set itself is fastened to this angle as shown in Figure 1. Here again the four wire aerial in the top was found to give the best results, although the use of the loop aerial was also satisfactory. In this case the loop was suspended from the cross piece top cover over the rear section of the car. This suspension permitted complete revolving of the loop without being in the way and a discomfort to the passengers.

The ground connection, as before, has

been to the framework of the car or to the rod driven in the ground when at a standstill. Although only a pair of receivers are shown the loud speaker was located in the rear section with a long cord so that it could be plugged in, the

Adjustable Resistors for Radio Circuits



Something New!

The Bradleyohm is just what you need for shunting audio-frequency transformers; for making resistance amplifiers; and for many special circuits. It is made in three sizes: Bradleyohm 10—10,000 to 100,000 ohms
25—25,000 to 250,000 "
50—50,000 to 500,000 "

Go to your dealer today and ask for the Bradleyohm.

ALLEN-BRADLEY CO.
290 Greenfield Ave. Milwaukee, Wis.

Use the **Bradleyohm**

THE PEPPER

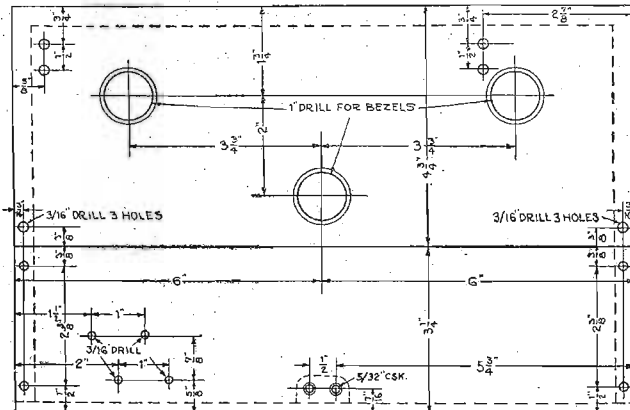

Figure 2

receivers being used merely for tuning the set in.

Here again the installation left sufficient room under the set so as to permit perfect comfort for the passenger of the front seat. The set used is again the one being described as the portable for automobile use, especially to be contained in the suitcase as desired.

Cover Panels

Figure 2 shows the dimensions and layout of the two cover panel. This cover panel was made in two sections. The front section becomes an intricate part and is permanently fastened to the base panel and front panel unit. The rear section of the cover panel just carries three holes for bezels, to observe the illumination of the tube filaments and also for a slight circulation of air. In this

compact arrangement where the set is entirely enclosed the heat of three vacuum tubes becomes excessive and will be found to effect the operation of the set unless some means of escape for the heated air is provided. In addition this rear cover must be made removable in order to permit accessibility for changing tubes when necessary or occasional examination of the internal connections.

The dash line running across the front edge indicates the front panel, as this top piece overlaps it. A dash line around the other three sides indicates either the sides and back of a wooden cabinet and is permanently fastened to the base panel and front panel unit. The rear section of the cover panel just carries three holes for bezels, to observe the illumination of the tube filaments and also for a slight circulation of air. In this

(Continued on page 18)

Guaranteed Head-Sets

RED-HEADS are guaranteed radio phones. You run no risk when you buy them. Money back if, after 7 days' trial, you're not satisfied that they're the best receivers on the market at the price. Why not act right now and get a pair? It'll mean getting the maximum from broadcasting from the day you put them into use.



RED-HEAD RADIO RECEIVERS NOW READY

The new 1924 Model F The new "Red-Head" Jr. \$6.50 Per Pair Complete \$5.00 Per Pair Complete

"Red-Heads" sent prepaid on receipt of price if you are unable to get them at your dealers.

THE NEWMAN-STERN COMPANY
DEPT. R. D., NEWMAN-STERN BUILDING, CLEVELAND, OHIO

KEYSTONE RADIO LIGHTNING ARRESTERS

\$1.50
At All Dealers

Buy your Keystone Arrester today—install it according to instructions supplied, and forget about lightning. Made of Bakelite—weather-proof. No vacuum to lose. Approved by Underwriters. At all Dealers, \$1.50.

Manufacturers of over a million Lightning Arresters

ELECTRIC SERVICE SUPPLIES CO.
17th and Cambria Streets, Philadelphia
53 W. Jackson Blvd., Chicago
50 Church St., New York

BUELL RADIO APPARATUS

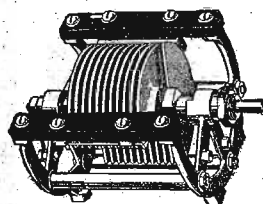

THE MOST STURDY of the New Type **LOW LOSS CONDENSERS**

BUELL MANUFACTURING CO.
2977 Cottage Grove Ave., CHICAGO

PEERLESS RADIO

349 **Fulton St. BROOKLYN N. Y.**

JUST OFF THE PRESS OUR NEW CATALOGUE AND PRICE LIST. SEND 4c IN STAMPS TO COVER POSTAGE FOR SAME

- Complete Parts for **Neurodyne 5-Tube Set**
- 1 7x26 Panel
 - 1 Triple Socket
 - 1 Single Socket
 - 2 Neurodons
 - 2 Neuroformers
 - 3 All American Transformers
 - 1 Battery Switch
 - 1 4" Dials Fada Type
 - 1 Power Rheostat
 - 1 Vernier Rheostat
 - 1 Blinding Paste
 - 1 Closed Circuit Jack
 - 1 Filament Control Jack
 - 27 Ft. Insulated Telling
 - 27 Ft. Tinned Bus Bar
 - 2 Fixed Condensers .005 Mfd.
 - 1 Fixed Condenser .0025 Mfd.
 - 1 Grid Leak

- Complete parts for **Fada 5-Tube Neurodyne Sets**—ALL GENUINE FADA PARTS. LIST PRICE \$55.00. OUR PRICE \$51.00. Assembled in cabinet ready to operate, \$71.50.
- Complete parts for **Fred-Eisemann 5-Tube Neurodyne Sets**—GENUINE PARTS. LIST PRICE \$60.00. OUR PRICE \$62.50.
- Fada 160 Neurodyne**—Factory-made machines. LIST PRICE \$120.00. OUR PRICE \$89.50.
- Fred-Eisemann 5-Tube Neurodyne NR5**—Factory-made machines. LIST PRICE \$150.00. OUR PRICE \$125.50.
- Fada Neurodyne Kit**—3 NEUROFORMERS—2 NEURODONS. LIST PRICE \$25.00. OUR PRICE \$21.00.
- Fred-Eisemann Neurodyne Kit**—NEUROFORMERS—2 NEURODONS. OUR PRICE \$22.50.
- Shanrock Kit**—NEUROFORMERS—2 NEURODONS. OUR PRICE \$15.45. ROYNE COILS \$5.75.

Spider Webs on Cam Driven Mount

Good Results Obtained With Simple Hook-up

Instead of mounting my spider web coils on the front of the panel where they are always in the way I made controlling mounts back of the panel. The shifting

WORKSHOP KINKS EARN A DOLLAR—

There are many little kinks worked out at home that would aid your fellow Radio worker if only he knew about them. There are new hook-ups, new ways of making parts and various unique ways of operating sets that are discovered every day. Radio Digest is very much interested in obtaining such material. Send them in with full details, including stamped envelope, so rejected copy may be returned. The work must be entirely original, not copied.

RADIO KINKS DEPARTMENT,
Radio Digest,
510 North Dearborn St., Chicago

of the coils is accomplished by a dial through a 1/4-inch shaft which has an eccentric attached on the inside end.

The cores for the spider webs were cut out of hard fiber 5 inches in diameter with a solid center 2 inches in diameter. One of the arms is cut 1/2-inch longer than the others in order to fasten the hinge mounting on to an angle of brass.

The base is made of either heavy brass or formica. Brass is preferable because it makes a good bearing. The primary and secondary are bolted to a piece of angle brass and this in turn is bolted to the brass base. These coils should be as close as possible. The tickler is bolted to a small brass hinge and bolted to the base as close as possible to the secondary and primary coils.

There should be a spring to pull the coil tight against the cam. This spring is fastened to the center of the tickler coil and is run to the outer edge of the brass base. The primary and tickler coils each have a winding of 42 turns, counting both sides, with number 24 d.c.c. magnet wire. The secondary has 62 turns, counting on

COILS OF UNUSUAL CONSTRUCTION

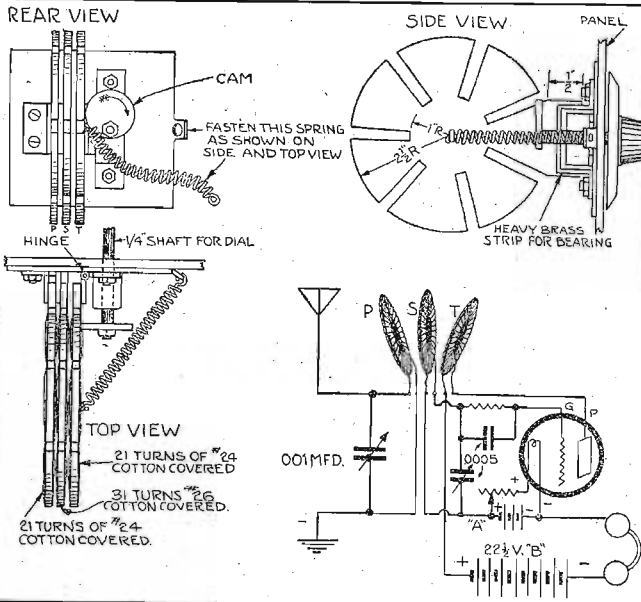

both sides, with number 26 d.c.c.—M. Slis-son, Boulder, Colo.

be equipped with stops to keep the rotor from revolving all the way around, thus breaking the contacts.

Tips About Variometers

When selecting a variometer, be sure that the shaft that holds the rotor ball is of brass or copper, and not of iron or steel. This will increase resistance. The best variometers have the shaft running only part way through the rotor and not all of one shaft. The shaft should also

HETERODYNE Pfanstiehl Oscillator

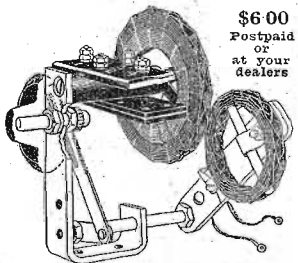

It corrects the usual cause of failure by adjusting the strength of the oscillations to that of the incoming signal.

Pfanstiehl Radio Service Co.
Highland Park, Ill.
Chicago: 1801 W. Washington St. Haymarket 8010

WAVE TRAP

Simplifies tuning. Eliminates interfering stations, thereby improving the selectivity of your set. Selects between conflicting stations. Special elite quality parts. D131 Each...\$4.95

WOOD CABINETS

Highest grade Mahogany Finish Cabinets. Hinged top. These cabinets are being sold at less than one-half regular value.

D57	Wood Cabinet, panel size 7"x10"	Each	\$2.50
D58	Wood Cabinet, panel size 7"x12"	Each	2.75
D59	Wood Cabinet, panel size 7"x14"	Each	3.00
D60	Wood Cabinet, panel size 7"x18"	Each	3.50
D61	Wood Cabinet, panel size 7"x21"	Each	3.75
D62	Wood Cabinet, panel size 7"x27"	Each	4.00

Baseboards (Mahogany Stained) for use with above cabinets

T21025c	T21435c	T22145c
T21230c	T21540c	T22250c

PLATE CIRCUIT "A" BATTERIES

The highest grade of battery made at prices lower than they ever were sold before.

D60	22 1/2 Volt Small	\$1.15
D61	22 1/2 Volt Medium	1.45
D62	22 1/2 Volt Large	1.85
D63	45 Volt Medium	1.95
D64	45 Volt Large	2.50
D65	300 Hour 1 1/2 Volt Twin Double Duty "A" Battery	3.50
D66		.75

Audio Frequency Transformers

The following transformers are guaranteed standard makes, and will produce very efficient results.

D63	Dietzen 2 to 1 Ratio	\$3.95
D64	Dietzen 2 to 1 Ratio	3.95
D65	Dietzen 10 to 1 Ratio	3.95
D66	Acme Audio	4.25
D67	Acertan	5.95
D68	U.V. 713 R.C.A.	5.75
D69	U.V. 714 R.C.A.	5.75

MISCELLANEOUS

D163	Synthetic Tubing, per yd.	\$0.69
D164	Synthetic Circuit	.30
D165	Ground Clamps	.17
D166	Elastic Rubber Binding Posts, 2 for	.65
D167	Nickel Plated Binding Posts, 2 for	.65
D168	No. 18 Annunciator Wire, half pound coil	.39
D169	6 ft. Phone Cord with Taps	.49
D170	20 ft. Extension Cord with Taps	1.95
D171	Wall Insulators, Porcelain	.85
D172	Rotular Potentiometer Lead-to Insulators, 6"	1.10
D173	Rehnartz Coil	1.45
D174	Coakley Coil	2.45
D175	5" Dial and Knob	.25

Modell's

America's Greatest Radio Retailers
719 FULTON ST. CORNER 22ND ST. BROOKLYN
Cor. Church & Washington St. Flatbush, N.Y.
14 CHURCH ST. 15 WHITEHALL ST. Post Radio Elec. Corp. Cor. Canal & Stone St. Corp.
(Open Sat. Evgs) 724 W. 42nd St. ("Open Ev's" Bet. 7th & 8th Aves.)

Charcoal Ground for Country Installations

Here is a kink that is a winner to the Radiophans in rural districts who have no water pipes for grounds. Take a common window screen wire, galvanized preferred, and make a cylinder about 4 inches in diameter and about 3 feet long and fill it with charcoal and set it in the ground 3 or 4 feet deep and drive the ground rod right down through it. The charcoal will draw the moisture and will always be wet and damp and will make the best of a ground connection. The ground rod need not be over 5 or 8 feet long. A 3/4-inch galvanized steel pump rod such as may be bought at an implement store makes one of the best ground rods. The ground wire should be soldered to the rod.—U. G. Tuttle, Denver, Colo.

The Dependable Radio Receiver

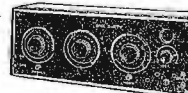

FADA "ONE SIXTY" with the NEUTRODYNE CIRCUIT

The FADA "One Sixty" is the four-tube Neutrodyne radio receiver that in sensitivity, volume, distance and clarity equals the best results of any five-tube set of any type or make. Owners say, "If we don't get 'em on the loud speaker, we don't count 'em." Consistent performance in loud speaker from sections 1200 to 2000 miles away and sometimes much further.

Price \$120 at Dealers
Extra for tubes, batteries and 'phones.
F. A. D. ANDREA, Inc.
1581 Jerome Ave., New York City

FADA RADIO

EVEREADY Radio Batteries

—they last longer

Conspicuous for vitality and endurance —the right batteries by test and proof for every radio use.

NATIONAL CARBON CO., Inc.
Headquarters for Radio Battery Information
New York San Francisco
CANADIAN NATIONAL CARBON CO., LIMITED
Factory and Offices: Toronto, Ontario

BATH NIGHT —and Saturday

Time was when we let the tub lay idle 'till Saturday night — then the tub worked overtime. Some folks have the same idea of radio, only use it in Winter—yet this Summer the Presidential Conventions will be broadcasted. Over five hundred broadcasting stations, we feel, permits of enjoyable summer reception for all those who tune in.

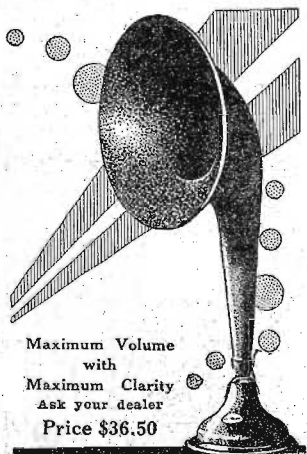

Maximum Volume with Maximum Clarity
Ask your dealer
Price \$36.50

Radiola

Carter Radio Co.
120 N. W. 1st Street
KANSAS CITY, MO.

The "Goode" Two-o-One



Le Ton d'argent



Guaranteed

BY MAIL ONLY

\$2.39

Postpaid

QUARTER AMPERE AMPLIFIER-DETECTOR

RADIO TUBE

GUARANTEED SATISFACTORY

All "GOODE" Tubes Sold Direct to the Consumer—No Dealer Profits

ONE—"Goode" Detector-Amplifier..... \$2.39

THREE—"Goode" Detector-Amplifiers..... 6.42

(All postage prepaid)

The "Goode" Two-o-One A Tube amplifies or detects. It is a quarter ampere, six-volt, standard base silvered tube. Send express or postal money order or New York draft for

The Goode Tube Corporation
Incorporated
EVANSVILLE INDIANA

A SINGING SUITCASE

(Continued from page 15)

Radio receiving unit, and the connections for switching from an enclosed aerial to an external antenna may be readily provided.

The use of cumbersome and heavy storage batteries, originally used in this type of portable equipment, is altogether obviated in the standardized design. Three dry cell batteries are used for lighting the filaments; while the plate voltage is derived from three dry cell batteries, 22½-volt units. Including these batteries, together with the other instruments and suitcase itself, this portable outfit weighs only 23 pounds.

The proverbial hound of the old maid is not more systematically and compactly arranged than is this self-contained talking and singing suitcase. There are four separate compartments reserved in this small space of only 11 by 22 by 8 inches in dimensions, one by each for the head telephone, spare electron tubes and like accessories; another reservation for the three dry-cell batteries used in sup-

plying electric energy to the filaments; a third space for the six-tube amplifier; and a fourth compartment for containing the three dry cell batteries, 22½-volt units. All these units, as well as the loop antenna, are snugly enclosed in a leather container, the condenser and rheostat knobs being the only protrusions which might identify the outfit other than a common suitcase.

The details set forth in the preceding paragraphs describe a self-containing receiving equipment using six stages of amplification, three of Radio frequency, two of audio frequency, and a detector. With slight modifications, a set of five stages of amplification, two of Radio frequency, two of audio frequency, and a detector. Unless the proper design of vacuum tubes, UV-199 preferably, and an efficient type of Radio frequency transformers are employed, difficulties are likely to be encountered by reasons of the close proximity of the loop antenna to the amplifying circuit.

Range of Reception
With the talking and singing suitcase

Worksman Radio Service
"THE ACCENT IS ON SERVICE"
14-16 Vesey St. NEW YORK

VARIOCOUPERS
\$3.50 Workette 180° Silk Wound.....\$2.95
3.50 Fisher, Large, 90.....2.75
2.75 Fisher, 120°.....2.25
4.25 Special Bank Wound Coupler for Haynes Circuit (with diagram).....3.25
7.00 Ambassador Coil (with diagram).....5.50

VARIOMETERS
\$3.50 Workette.....\$2.95
3.00 Pathé Modified.....2.25
3.00 Fisher, Large.....2.95

CONDENSERS
\$2.00 R. C. 11 plate.....\$1.00
2.25 R. C. 23 plate.....1.35
2.75 R. C. 43 plate.....1.65

VERNIER CONDENSERS
\$4.00 R. C. 23 plate.....\$2.25
5.00 R. C. 43 plate.....2.95

PHONES
\$18.00 DR. SEIBT IMPORTED "SUPER" \$6.90
HEADSET.....\$6.90
\$12.00 N. & N. Import.....\$6.90

The above items are just a few of our numerous attractive priced articles, which are contained in our BULLETIN OF RADIO PARTS. Gladly sent to you upon request.

We are headquarters for "Radion" and "Bakelite Diodes" Panels. The best gasket material available. Mail orders promptly attended to. Will ship C. O. D. unless remittance accompanies order.

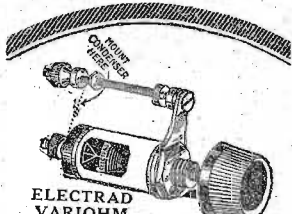

ELECTRAD VARIOHM

Doubles Your Distance Eliminates Circuit Noises
Correct grid resistance for your tubes and set. From 1/2 to 30 Megohms by simply turning the knob. Once set, stays permanently. Moisture proof and non-microphonic. Can be used with any standard fixed condenser.

Price 75¢; mounted, \$1.00
At your dealers, or direct. Absolutely guaranteed.

ELECTRAD, Inc.
428 Broadway, New York, N. Y.
Dept. 2

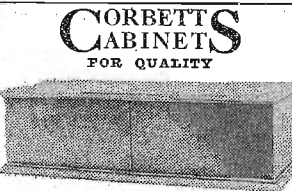

CORBETT'S CABINETS FOR QUALITY

Style "F" Console type, hinged top and two front doors enclosing panel. Above 26 inch size made with front similar to sectional book-cases. A fine piece of furniture.

The following prices are for regular hinged top base or hinged top and arched front or radiated front cabinets. For style "F" as illustrated add 100¢.

Size	Genuine Mahogany or Oak or Walnut	Size	Genuine Mahogany or Oak or Walnut
7x10x8	\$2.95	7x10x8	\$5.85
7x12x8	3.25	7x12x8	6.15
7x14x8	3.42	7x14x8	7.15
7x16x8	3.87	7x16x8	8.25
7x18x8	4.25	7x18x8	11.25
7x20x8	4.59	7x20x8	13.50
7x22x8	4.86	7x22x8	15.25

All cabinets nicely moulded top and base. Varnished finish carefully hand rubbed. Accurately made and well packed.
WRITE FOR FREE BOOKLET Illustrating six styles. Special cabinets to order.
TERMS—CASH WITH ORDER OR C. O. D.
Corbett Cabinet Mfg. Company
1415 East St. PHILADELPHIA, PA.
3523 N. Carlisle St. PITTSBURGH, PA.

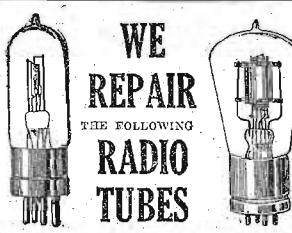

WE REPAIR THE FOLLOWING RADIO TUBES

Dealers and Agents write for Special Discount Mail Orders Solicited and Promptly Attended to

WD-11, WD-12, Our Specialties

WD-11	\$2.50	DV-6A	\$2.50
WD-12	2.50	UV-199	2.50
UV-200	2.50	C-299	2.50
UV-201	2.50	UV-201A	2.50
C-300	2.50	C-301A	2.50
C-301	2.50	Marconi	2.50
DV-6	2.50	Moorhead	2.50
DV-1	2.50	6 V. Plain Det	2.50
DV-2	2.50	6 V. Plain Amp	2.50

H. & H. RADIO COMPANY
P. O. Box 22-A
Clinton Hill Station NEWARK, N. J.

MAGNATRON
MAGNATRON DC-199 knows no superior among dry cell tubes. Whether as detector or as amplifier it will give better results in your set. It and the MAGNATRON DC-201A are unqualifiedly endorsed by experts.

Your dealer has these tubes. They list at \$5.

CONNELLY ELECTRIC LABORATORIES
309 Fifth Avenue NEW YORK CITY

READ YOUR ANSWER IN THE STARS

The detector question is a very important one to every builder of a radio set, and one that he must answer before he can consider his job really finished.

THE STAR FIXT CRYSTAL is the complete answer to this question, and you can get one from almost any five dollar in radio.

Fully Guaranteed. Price \$1.25 every-where. The crystal is "STAR-ITE".

Price \$1.25

Ask Your Dealer for "HEGEGOG"

Electric Company
Buffalo, N. Y. (Eastern Daylight Service)
1-100 N. W. 10th St. Grand Rapids, Mich. Dealer
The Radio Dealers Musical program: 6:30-7:30
at Lakes. Eastern States orchestra: 8:45-9:30
Bible, (tenor: 9:30-10:00, concert, Melody Mu-

built and adjusted for the reception of the ethereal burdens of music, each, one will naturally inquire, "How is its range?" If this portable unit is aboard a moving conveyance, the offerings of a broadcast station located twenty-five miles away may be heard, despite the noise of a moving automobile or other type of vehicle. If however, you are obsessed with the "itch for distance," the suitcase will have to be stationary and the potentiometer carefully adjusted if your log records are to be boasted of. Other than being a compact form of Radio-phone receiving unit, weighing only 32 pounds, the novelty of music and speech issuing from a leather container will certainly draw the crowds.
(THE END)

Great Radio Sensation Coming
SHAMROCK-HARKNESS REFLEX
(Licensed-registered manufacturer)
Two tubes operate loud speaker — with wonderful clarity, selectivity and volume.

Watch for further announcement
SHAMROCK MANUFACTURING CO.
Dept. 30, Market St. Newark, N. J.

SHAMROCK
(FOR SELECTIVE TUNING)

SAMSON TUBES
201 A TYPE 1/4 AMP. 5V
\$3.50

Ideal for DX Reception Volume and Clearness. Tested and approved by the foremost radio authorities. A trial will convince you. With money back guarantee.

Mail Orders Promptly Filled

PHOENIX TUBE CO.
23 E. 26th St. NEW YORK CITY
Dept. D

Dealers' and Agents' trade solicited

LITTLE BUT MIGHTY

A Real Necessity for Portable Sets

HEGEGOG \$3.50

PREMIER Audio Frequency TRANSFORMER

"Hegegog" is the smallest, lightest transformer made and yet it is unsurpassed for efficiency. That is why it is the thing for use in Portable Sets, where space-saving, compactness and light weight are a most important factor. You can depend on "Hegegog" in every particular. Its volume, tone quality and consistent performance have no superiors. Unconditionally guaranteed. Try "Hegegog" in your next "hook-up" portable or regular sets. This "little wonder" will surprise you in performance and in the space it saves. Ratios 1 to 3, 1 to 4, 1 to 6—\$3.50, 1 to 10—\$4.50. Send for FREE Bulletin No. 92.

Ask Your Dealer for "HEGEGOG"

Electric Company
KFAF, Denver, Colo. (Western Daylight Service)
KFAF, Denver, Colo. (Eastern Daylight Service)
KFAF, Denver, Colo. (Central Daylight Service)
KFAF, Denver, Colo. (Mountain Daylight Service)

Aerial Intelligence
An outside aerial should be inspected at least twice a year. Insulators covered with soot and dirt should be cleaned thoroughly with a brush and gasoline. A layer of soot on the aerial, along the insulators to the pulley and thence to the pole or other supports, allows a lot of energy to leak off the aerial. If it can be afforded, it would be a good investment to replace the corroded and blackened aerial wire with bright new wire. Enameled wire will not corrode and is worth while.

HUDSON-ROSS
Sells only Guaranteed Radio Apparatus
Send for literature
123 W. Madison St. Chicago

5000 RADIO DEALERS buy from
HUDSON-ROSS
123 W. Madison St. Chicago
Send for dealers literature

HUDSON-ROSS
Largest exclusive Radio Jobbers in middle West
Write for literature
123 W. Madison St. Chicago

NAZELEY'S PORTENA Folding Loop
Patent Pending

Our imitations have never duplicated our exclusive features. Wired through bakelite channels—a necessity for complete insulation, no other folding loop has this feature.

GENUINE BAKELITE CENTERPIECE
Solid detachable base of heavy metal. Handsome maroon covered carrying tube. Rich mahogany finish. Folds up like an umbrella—works like a charm.

IDEAL FOR YOUR SUPERHERBYDYNE
One dozen to a case. List \$7.00

J. NAZELEY CO.
571 Hudson St. NEW YORK CITY

ARROW BATTERY SLASHES PRICES TO ONLY

Prices Smashed! Quality Not Sacrificed CONSUMERS

Here is real battery quality, guaranteed to you, at prices that will astound the entire battery-buying public. Order direct from factory. Put the Dealer's Profit in your own pocket. You actually save more than half, and so that you can be convinced of true quality and performance, we give a **Written Two-Year Guarantee**.

Here's your protection! Noneed to take chance. Our battery is right—and the price is the lowest ever made. Convince yourself. Read the priced Special 2-Volt Radio Storage Battery, \$3.75 Special 4-Volt Radio Storage Battery, 6.00 6-Volt, 60 Amp. Radio Storage Battery, 7.00 6-Volt, 80 Amp. Radio Storage Battery, 8.00 6-Volt, 100 Amp. Radio Storage Battery, 9.50 6-Volt, 120 Amp. Radio Storage Battery, 11.50 6-Volt, 140 Amp. Radio Storage Battery, 13.00

We ask for no deposit. Simply send name and address and style wanted. Battery will be shipped the day we receive your order. Express C. O. D. subject to your examination on arrival. Our guarantee accompanies each battery. We allow 5% discount for cash in full with order. You cannot lose! Act quick. Send your order today—NOW.

Arrow Battery Co.
1421 South Wabash Ave. Dept. Chicago, Ill.

Increasing the Resistance of the Wire Rheostat

Varying the Resistance in the Filament Circuit

By J. E. Owen

THE purpose of the rheostat is to introduce a varying resistance in the filament circuit in order to control the voltage across the filament terminals of the vacuum tube. The usual wire rheostat has a constant change of resistance throughout the entire scale of its revolution. There is a critical point for some tubes, and in all tubes there is a certain setting of the rheostat that gives greatest volume with the least amount of current. Increasing the resistance a trifle gives less volume, but within a certain range, better quality of reproduction. This range is comparatively small, but the usual rheostat makes no provision for it.

Varying Amperage

There are a few variable resistance units on the market that may be varied from 0 to 30 ohms, for example, that one can use in the filament circuit to adapt it to the range variation spoken of above. This may be done by shunting it across a rheostat which, for most purposes, must also have a high resistance. For example, in the illustration the rheostat is 30 ohms, say, and the resistance unit is also 30 ohms. But move the slider or the adjustment member out so that only 1/2 of it is being used. Then we have 15 ohms resistance in the resistance unit, and if the rheostat is just turned on, we have 30 ohms in the rheostat. From the well-known electrical law:

$$R = \frac{Y \times Z}{Y + Z}$$

Where R is the resistance of the whole unit, and Y, say, is the resistance of the variable resistance unit and Z is the resistance of the rheostat (the resistance for the certain setting, not for the whole rheostat), we can obtain R for any combination of Y and Z. So in this case Y is 15 and Z is 30 at full scale deflection. Consequently, R solves out to be 10 ohms.

This is enough resistance to control two 1/4 ampere tubes, both tubes being controlled by the same rheostat. However, let us see how the resistance varies with the turning of the knob. Suppose we turn

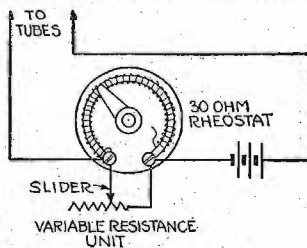

the rheostat half-way on. Then we have from the above equation that R equals 7.21 ohms. But the total resistance is only 10 ohms. Therefore, for the first one-half of the rotation we have changed the resistance less than 2.8 ohms, slightly more than one-fourth the total resistance. This gives a vernier effect over the range of resistance and the place where this effect will be most pronounced can be controlled by varying Y, or the resistance unit. By setting Y at about 6 ohms. It will be 5 ohms at full resistance of the rheostat, and from the equation it will be found that the first half of the scale deflection gives a change in resistance of only 7 ohms. This means a vernier control at a resistance which will be found about right for a detector tube drawing 1 amp.

Vernier Control

This form of resistance has the advantage that it may be varied for any type of tube, drawing any amount of current up to about twice what the manufacturer

says is maximum for the units he produces. The usual amount is 1 1/2 amperes, but this may be safely increased with the two resistances in parallel to about 2 1/2 amperes with a factor of safety allowed. Another valuable feature is that the vernier effect is most pronounced the greater the draw of current. This is a very valuable feature, as may be seen when the problem is analyzed. With a 1-ampere detector tube there is a critical point of control. This requires a vernier. However, with a 1/4-ampere tube used as a detector, say, there is no or little effect of the critical adjustment. However, when a rheostat is used that controls two, three or more of these tubes, there is a critical point in that a slight change in resistance means a greater change in the amount of current that flows through the tubes, since the resistance is less when two, three or more tubes are controlled from one rheostat. But this comes back on itself, since the vernier effect is greater with lower resistance settings of the variable resistance unit.

Another advantage is that there are no extra knobs to push in or pull out or turn in order to get the vernier effect. This form of vernier is often unsatisfactory, since it gives quite a bit of trouble. In other vernier rheostats that use one knob, it is necessary to turn the rheostat through a great many revolutions in order to cover the entire range, since the vernier effect is used over the entire scale. As may be seen, however, this is unnecessary, and in fact undesirable. This form of rheostat unit has none of the above faults. It will be found to give entire satisfaction in any Radio circuit.

Don't take a reading of your B batteries with an ammeter. Use a voltmeter. One test with an ammeter will draw as much current from the battery as you would in a month of regular service.

Connection for Headsets

Headphones, generally speaking, operate the best when the positive side of the phones is connected to the positive side or lead of the B battery. Some phone cords are marked with a red stripe to indicate the positive cord of the phones. But if the phones aren't marked try them connected one way and then reverse these conditions. The positive side will be indicated by the connection that gives the clearest and loudest signals.

Edson
TONE TESTED
Radio Headsets
2000 or 3000 OHMS
\$3.00 POST PAID

The lowest-priced first quality headset on the market today. Compare with headsets costing twice our price. Return ours if not satisfied. Our written guarantee protects you. Send \$3.00 by registered mail or money order. Buy direct of us and save the difference. No ship, postage prepaid, same day order is received. Ask for our

Free Catalog of Radio Parts
EDSON RADIO SALES CO.
6 Elmwood Providence, E. I.

Dealers Need This

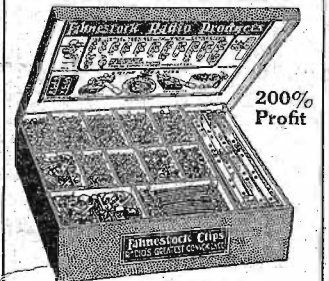

The new FAHNESTOCK Display Case will stimulate your sales of Fahnestock Radio Products. It of the most popular styles and sizes are included. Shows the purchaser instantly the correct price by his card. A constant temptation to buy Fahnestock Products. Dealers are offered 200% profit on each case, an unusual offer on standard merchandising.

Price to Dealer.....\$17.50
West of Mississippi..... 18.50
Transportation prepaid when money order or check accompanies order. Subsequent orders at regular price of \$20.00.
Contents Retail for \$51.50
Refills will be supplied at the regular 100 lot price, shown in catalogue, which comes with ease, less discount shown on enclosed sheet. Send check or money order, today.

FAHNESTOCK ELEC. CO.
LONG ISLAND CITY NEW YORK

Biltmore Reflex

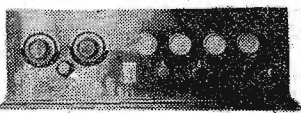

SWAMPED

Upon the announcement of the BILTMORE REFLEX receiver several weeks ago, we were swamped,—flooded with inquiries and orders. Why? Because, for one hundred dollars, a price which anybody can afford, we offer the finest receiver which the Radio Science could devise,—and the most beautiful.

It is made from the finest parts—Radiom Mahogany cabinet, bakelite dial and sockets. National low loss condensers (undoubtedly the most efficient made). Du-biller Micaoson, Acme Radio and Audio Frequency transformers, and Fahnestock rheostats and potentiometers.

It is extremely sensitive,—stations thousands of miles away may be heard on the loud talker, with just a ground and a few feet of hidden wire,—no outdoor antenna, nor even a loop!

The wonderful tone and quality of reception is that which is only possible on a reflex, and the BILTMORE is the finest of reflex receivers.

It is very selective, and yet, it is easy to tune. Truly, the Ideal receiver.

If your dealer hasn't it, write us direct, and send us his name.

Dealers: We desire a representative in each locality. Write us.

Biltmore Radio Company
Dept. D Boston 30, Mass.

Mr. Dealer!!

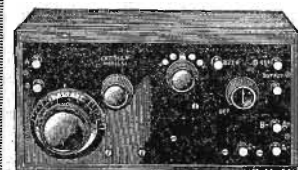

Crosley Model 51

Are you cashing in on this sensational success? It's going high everywhere. Be ready! Let us keep you supplied.

Get our big catalog—sent ONLY to Dealers. Ask for A1002. No others need apply.

WAKEM & McLAUGHLIN
225 E. ILLINOIS ST., CHICAGO

Campbell RADIO CABINETS

"From the Lumber to You"

PRICES—Cash with order, prepaid east of Missouri River; west, add 15 cents to quoted price. Add Post Office or Express Money Order.

Panel Sizes	Initiation Walnut or Mahogany	Genuine Walnut or Mahogany	Price
7x10 1/2	3.81	4.28	7.12
7x11 1/2	4.24	4.71	7.95
7x12 1/2	4.67	5.14	8.81
7x13 1/2	5.10	5.57	9.67
7x14 1/2	5.53	6.00	10.53
7x15 1/2	5.96	6.43	11.39
7x16 1/2	6.39	6.86	12.25
7x17 1/2	6.82	7.29	13.11

Mounting Boards, 50c Each

Will not warp or crack. Made of No. 1 wood finished in either Mahogany or Walnut, bright or rubbed finish.

Manufacturers and Dealers' Inquiries Solicited

THE PERKINS-CAMPBELL CO.
(Established 1875)
410-440 New Street, CINCINNATI, O.
(References: Dun or Bradstreet's)

The Twitchell Auxiliary Tuner

Patents Pending. Name Registered
MORE THAN A WAVE TRAP

A TWITCHELL AUXILIARY TUNER connected to any make of tube receiving set will positively cut out any local broadcasting or code stations so you may tune in all long distance stations any time regardless of local conditions.

Unlike any wave trap, THE TWITCHELL AUXILIARY TUNER does not ever decrease, but in many cases increases the volume from distant stations. These TUNERS are in daily use within 400 feet of large broadcasting stations and enable their owners to easily and completely cut out the local station and bring in distant stations at any time on a loud speaker. This instrument will also enable you to bring in programs sent out on longer waves than you can tune in without thus bringing all the broadcasting stations within the wave length range of the many sets of limited range now in use.

Copyrighted diagram of this tuner, 50c, or with all parts, \$9.00. Complete instrument in walnut cabinet, ready to use, \$15.00.

A New and Wonderfully Efficient Coil for the Relnartz circuit for those who want the best. Price \$3.00, or with blueprint for either one or three tubes, \$3.50.

This circuit brings in both coasts loud and clear and is the most successful Relnartz modification.

All goods prepaid. These instruments are easy to build, easy to operate. Everything clearly shown.

S. A. TWITCHELL
WESTERN AVE.

91 1/2%
of all tubes are
Needlessly Destroyed

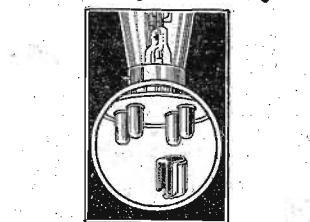

RADECO SAFETY FUSES
GIVE COMPLETE PROTECTION
Price 50¢

World BATTERY
Saves You 50%

Famous Guaranteed Quality and Service—Backed by Years of Successful Manufacture and Thousands of Satisfied Users.

Prices That Save and Satisfy

Auto Batteries	Radio Batteries
6-Volt 11 Plates, \$12.25	6-Volt 60 Amps. 5 8.50
6-Volt 13 Plates, 14.25	6-Volt 100 Amps. 15.00
6-Volt 15 Plates, 16.25	6-Volt 120 Amps. 17.50
12-Volt 7 Plates, 17.00	6-Volt 140 Amps. 18.50

Special 2-Volt Storage Battery for W. D. H. and 12 tubes will run 200 hours on one charge. Rechargeable. \$5.00.

Special 4-Volt Storage Battery for U.V. 155 tubes. Same features as 2 Volt. \$8.00.

Shipment express C.O.D., subject to examination. Discount for cash in full with order.

2-Yr. Guarantee Bond in Writing With Each World Storage Battery

proves satisfactory World performance. Mail this ad with your name and address and we will ship battery day order is received, and give you a 45-Volt "B" Battery and Hydrometer Free with each battery purchased. Write today.

World Battery Company
Dept. L, 60 E. Roosevelt Rd.
CHICAGO

Questions and Answers

D.C. Charging

(02953) ELS, Smithland, Iowa.
I have access to 110 volt direct current. Can I use this profitably for charging 6 volt or 2 1/2 volt storage batteries? The current is furnished me free. Will you explain a diagram for same. Would you recommend carbon filament, or tungsten filament lamps or resistance coil? If lamps what rate of watts per hour. How can I determine the polarity of the wires? Could I measure the amperage and voltage going into batteries with an ammeter and voltmeter used for dry cells?
A.—We are advising in your inquiry that a 110 volt direct current system is available for charging storage batteries. Connect the positive of 110 volt system through a 40 watt lamp to the positive B battery and the negative of system to negative of B battery.
Connect six volt battery through a 200 watt, or its equivalent, in the same manner.
The correct polarity can be determined by placing two wires from the 110 volt

system in a glass of water, spacing them at 1/2 inch, when the negative will produce twice as many bubbles as the positive. The voltmeter used for dry cells is not suitable for storage batteries.

Crystal Set

(07324) RMDeR, Hollywood, Calif.
In Feb. 2nd issue of the Digest, on page 18, a Mr. Amundsen describes a crystal set. Being a beginner I would like to ask a question or two.
First, which is the 23-plate condenser? The diagram is not marked showing that everyone, perhaps, should know, but Mr. Amundsen must not forget, that there are still some who would not know.
Also, how many turns, and of what size wire on the honeycomb coil?
A.—In the circuit of your inquiry, a forty-three plate condenser is connected in series with the antenna and a twenty-three plate condenser is connected across the honeycomb coils. A .001 mfd phone

condenser is indicated connected across the phones.
Honeycomb coils are generally wound with number 24 dec. wire. Fifty turn coil is specified.

Variocoupler Windings

(08102) GM, Nappanee, Ind.
I have a standard 180 degree variocoupler. I want to have the windings so I can receive between 130 and 400 meters. How many turns should the stator have? The rotor? I will use it in the Haynes D. X. set. I will use a 26-plate condenser across the secondary.

WE NEED CASH

Large Radio Stock at a Sacrifice. Subject to Prior Sale. Write for a List with Prices. Address: R. D. 15, Radio Digest, 510 North Dearborn Street, Chicago.

NOISE KILLER

Kills Noise in Radio Sets. Can also be operated to put expression in musical numbers, to imitate tones of human voice and to secure natural tonal quality without distortion.
\$7.00 POSTPAID
Inter-State Signal Co., Dept. 1, Columbus, Ohio

CAUGHT

With some old dry cell "B" batteries? Purchase the economy way. Build yourself a rechargeable Hawley knock-down "B" storage battery, consisting of large size Edison elements, special glass vials, extra heavy and flat bottom (not ordinary thin test tubes, special nickel wire, 200 hole hard rubber perforated separators, rubber stoppers, chemical electrolyte, in fact everything for the actual construction of battery. An 8 page illustrated folder, showing very simple putting together, making of a charger and charging, free with all orders. 45 volt, \$6.25, 50 volt \$8.00, 100 volt \$10.50, 150 volt \$14.25, 200 volt \$17.00. Thirty day trial or money refunded. Pioneer dealer. Complete sample, prepaid, 35c.
B. D. Smith, Danbury, Conn.

RADIO-TACH

A simple device which converts your PHONOGRAPH into an AMPLIFIER. Entertain your family and friends with this double service from your phonograph. RADIO-TACH is easily and quickly put on and taken off and can be used with ANY Radio Set. YOU NEED IT. Pin three dollar bills to the cover and Mail Today.

RADIO-TACH CO., 10th floor, Lutz-Wingate Bldg., Los Angeles, Calif.
Please send me at once a RADIO-TACH, for which I enclose \$2.00.
Name.....
Address.....
Make of Phonograph.....

ULTRADYNE TRANSFORMERS

1 Input Transformer and 3 Intermediate Transformers \$20.00
Tuning, Oscillating Coils, \$ 4.00 per pair.....
Full instructions and Blue Prints furnished with each kit. Absolutely guaranteed. These transformers are suitable for any Super-Heterodyne circuit. Put up in handsome kit display box. Special discount to dealers. Prompt delivery. Write for special circular.

SYMPHER MANUFACTURING COMPANY
1524 Fernwood Ave., Toledo, Ohio

Bankrupt Stock

Cunningham Regenerative one tube long range sets \$10.50 Each
Prepaid while they last. Formerly sold at \$32.50
No Circulars. Order from This Ad.
S. A. TWITCHELL
1925 Western Av., Minneapolis, Minn.

Perfection Coil Antenna

Eliminates the Outside Aerial
PERFECT RECEPTION
NO ROOF ACROBATICS
REDUCES STATIC AND INTERFERENCE
INCREASES SELECTIVITY
Just stretch it Across a Room
from your Dealer's or Direct

A—A variocoupler to meet your requirements should be wound, primary with fifty-six turns, tapped at every seventh turn, and secondary with fifty turns, each with number 26 wire.

Burned Out or Broken Radio Tubes Repaired

Including
WD-11 or C-11.
WD-12 or C-12.
UV-199 or C-299.
UV-201A or C-301A. \$250
UV-200 or C-300.
UV-201 or C-301.
DV-1 or DV-2.
DV-6 or DV-6A.

All Tubes Guaranteed to Work Like New
Radio Tube Exchange
220 S. State Street, Room 204
CHICAGO
Phone WALSH 0118
MAIL ORDERS GIVEN PROMPT ATTENTION

1500 Miles for \$9.75

Ben Franklin Air Key, Single Tube Knockdown Set..... \$9.75
This outfit consists of the following material, packed in an individual carton, necessary to build the famous Ben Franklin Air Key Triple Circuit Set:
1 Ben Franklin Air Key Coupler
1 Pausin 23-Plate Condenser
1 212 Hard Rubber Panel
1 Rheostat, 1 V. T. Socket
2 3-inch Dials, 1 Mica .00225 Condenser
Grid Leat, 4 lengths Bus Bar
8 Marked Binding Posts, 1 Phone Condenser Wiring Diagram
These items will build the famous Ben Franklin Triple Circuit Non-radiating Set; has a receiving range of 1,500 miles.

Ben Franklin Air Key, 3 Tube Knockdown Set..... \$19.75

This outfit consists of the same material as the 1 tube set with the addition of 2 audio transformers, 1 738 Panel, 2 extra sockets, 2 extra rheostats, 3 jacks. Will bring in distance on Loud Speaker.
ATTRACTIVE DISCOUNTS TO DEALERS
MANHATTAN RADIO CO.
112 Trinity Place, Dept. RI New York City

Price 50 cents everywhere



Never sold at such prices

B-METAL
Loud Talking Crystal
Sold only by reliable dealers and at full price. The Premier Crystal of the Radio World today. Ideal for REFLEX or CRYSTAL sets. Order, if possible, from your dealer. If he does not have it, send to us for one. Price 50 cents postpaid.
New Jobbers and Distributors Plan Now Ready
B-METAL REFINING COMPANY
525 Woodward Avenue, Suite 46
DETROIT, MICH.
GENUINE B-METAL
Chicago Branch: 35 West Jackson Blvd
New York Branch: 242 Fulton Street

PATENTS Procured. Send sketch or model today for examination, prompt report and advice. No charge for preliminary advice. Write for free Booklet and blank form on which to disclose your idea. Highest references. Promptness assured. Clarence A. O'Brien, Registered Patent Lawyer, 200-C Security Bank Building, Directly across the street from Patent Office, Washington, D. C.

MARVELOUS RECEPTION

Obtained Using Aragon Silver Neutralizing Condensers. If unable to procure from your dealer, write us.
ARAGON RADIO COMPANY
6 E. Lake St. CHICAGO

Don't You Get Tired

of only hearing LOCAL stations on your Crystal Set? There's a magic on your aerial every night from stations far away. If you want to hear it without buying a tube set, WRITE ME TODAY.
LEON LAMBERT
601 South Volusia, Wichita, Kansas

RECHARGEABLE "B" BATTERIES

You can enjoy Radio Programs during summer months by equipping your set with Alkaline type rechargeable "B" Battery. Battery positively will reduce static and all "B" Battery trouble. Absolutely reliable. Our knock-down battery and save money. Our knock-down sets consist of the best materials. Edison element. Specially modified flat bottom tubes. Special wire. Perforated hard rubber separators. Alkaline and fully illustrated instructions for assembling. 45 volt \$8.50, 100 volt \$10.50, 150 volt \$15.00.
J. A. GILBERT
133 Fayerweather St. Bridgeport, Conn.

WHOLESALE FOR DEALERS AGENTS WANTED

DEALERS—We make a specialty of stocking new dealers and radio departments. Our large price list will be mailed free to you on request. Good discounts and prompt deliveries.
THE RADIO SHOP OF NEWARK, INC.
78 Springfield Ave., Dept. H. Newark, N. J.

1,000 MILES ON A CRYSTAL SET
Send for plans and specifications, simple to build cheap and effective, no variable condensers, batteries, tubes or transformers. One 30 stations in one night from Winnipeg. Full instructions, for
GEO. OXTON
336 Colony St. Winnipeg, Canada

11 FEET LONG
Spiral
Insulator
13 PITCH
DIAL-ETER
Spiral
Insulator



INSIDE AERIAL
Specially for Crystal
150 Feet Stranded Copper Wire
SUSPENDED BY 1000
BUT NOT A LAMP
NO DANGER FROM LIGHTNING
Or \$5. If four feet wire's address us at us.
INTER-STATE SIGNAL CO., DEPT. I, COLUMBUS, OHIO

Nath. Baldwin Phones with
GENUINE LOUD SPEAKERS
Complete Regular Value \$15. \$8
Postpaid. Use your headset for two purposes—economical combination—every pair of phones tested.
Walter Scott & Co.
86 Heller Pky., Newark, N. J.

DEALERS
CROSLEY
"TRIRDYN"
This sensational receiver is the latest and most popular of all. Makes three tubes do the work of five. PRICE \$65.00
We Have Every Brand of High Grade Radio Apparatus
DEALERS: Send for Catalogue and Discounts

Duo-Reflex
Tube for Tube—the Most Powerful Circuits Ever Built. Write for free Bulletin No. 16
Electrical Research Laboratories
CHICAGO.
ERLA

