

Reflex Hook-Up Puts Tone into Reception; Latest Gold Cup Award Standings; Flewelling Set With Radio Frequency; Programs for All Large Stations

# Radio Digest

EVERY WEEK **Illustrated** PROGRAMS **TEN CENTS**

Vol. X Copyright 1924 By Radio Digest Publishing Co. SATURDAY, SEPTEMBER 6, 1924 No. 9

## RADIOCAST SHAM BATTLE

### "NITE CAPS" ON TRIP AROUND THE WORLD

TRAVELING ON CARRIER WAVE FROM WJAX

Will Investigate Musical Offerings of Foreign Countries; Journey Begins September 6 at Midnight

CLEVELAND.—The "Nite Caps on Lake Erie," under the direction of Chief Nite Cap Jim Frew, and accompanied by Adolf, the alligator, are to cruise around the world on the carrier wave of WJAX, the broadcasting station of the Union Trust company here.

The intent of the trip is to investigate the musical offerings of foreign countries and will start at midnight, Eastern time, Saturday, September 6. The program is the joint offering of the Euclid Music company and the Cleveland News-Leader.

Leaving the classic shores of Lake Erie, the intrepid crew will first visit Scotland and hearken to ballads and bagpipes. If they survive the ordeal, Holland will be the next port of call. Spain and Italy will be called upon for entertainment, and Hungary and Russia will contribute.

**Will Be Music Travelogue**  
An orchestra of native Syrians will play melodies of their country and Turkey and Egypt will quite probably offer the provocative strains of "La Danse du Ventre" as reminiscent of the streets of Cairo. "The Song of India" will be heard, voicing the appealing cry of its millions of unhappy and oppressed.

In China, the "Nite Caps" will hear the barbaric melodies of the Far East, offered by a native Chinese orchestra, an innovation in broadcasting. In Hawaii, the tinkle of the guitar and ukulele will blend with an orchestra accompaniment.

The program will last from midnight of Saturday until 5 o'clock Sunday morning.



"To my Radio friends through the courtesy of WJAX and Radio Digest." This is the message that Jackie Googan, "America's Boy," autographed on the above photograph. He has broadcast from Stations WJAX, KYW, WLW, WEAJ and a number of others during his trip to the Holy Land to lend his assistance to the feeding of the starving orphan children there.

### KEEP PUBLIC INFORMED AS TROOPS FIGHT

Station WHAS Microphones Firing Line for First Time in History

Fans Get Graphic Story

Lines Direct to "Front" Take Machine Gun Fire and Shell Explosions to Listeners

LOUISVILLE, KY.—Rattling fire of the machine guns, hissing of the big shells as they coursed overhead and the bombardment of bombs and the field artillery intermingled with the voice of Col. Mark E. Hamer, first Radio war correspondent, as Station WHAS, Louisville Courier-Journal, recently Radio-cast his account of the "Battle" of Louisville.

The occasion was a sham battle engaged in by 18,000 citizen soldiers encamped at Camp Knox, and marked the first time that a station has ever attempted to broadcast the action of war direct from the firing line. And the attempt was successful to such a degree that it may be known some day as the forerunner of the Radio war correspondent and broadcast war.

Crede Harris, well-known director of (Continued on page 4)



Loda Goforth, soprano, entertained listeners in recent through Station WIP of Philadelphia. She is well-known to Radio audiences in the East.



Marie Hughes Macquarret, often called California's most popular harpist. She is solo harpist and director of "Ensemble Aeolienne," an organization featuring nine prominent harpists of the Pacific coast.



# No. 16 OFFICIAL BALLOT

## Announcers' Contest

### RADIO DIGEST FIRST ANNUAL GOLD CUP AWARD

Gold Cup Award Editor, Radio Digest, 510 North Dearborn St., Chicago, Ill.

Please credit this ballot as one vote for:

.....of Station.....  
(Announcer's name) (Call letters)

Signed .....

Address .....

City.....State.....

If you desire, tell below in five or less words what you most like about the announcer for whom you have cast this ballot:

.....

## GEORGE HAY LEADS GOLD CUP STANDING

### SOLEMN OLD JUDGE STILL AHEAD OF COMPETITORS

Fourteenth Ballot Shows Large Field of Announcers; Speculation as to Winner; Race Close

Taking the first fourteen ballots into count, George Hay, WLS, still leads the field. Following very close behind him is Bill Hay, KFKX. The rest of the field are strung out with the possibility of anyone winning the Gold Cup.

Four new additions are listed among the announcers with fifty or more votes to their credit. This brings the total number of contestants up to seventy-five.

The ballot printed in this issue is the last one to be shown. All Radiophans who have been saving their votes and now have sixteen consecutive numbers, will get a bonus of seventy-five votes for their favorite announcer. Those sending in twelve consecutive ballots will get a bonus of fifty votes.

#### Voting Closes September 8

Be sure and get all the votes in the mail not later than September 8, as any votes received which were mailed after this time, will be thrown out.

Many surprises are looked for and the finish will be close regardless of the standings shown this week. Several announcers all claim to have a number of votes on hand that they will spring at the last minute, taking advantage of the extra bonus offered as a reward for consecutive numbers.

Letters are arriving every day in every way possible; registered, special delivery and air mail being among the methods employed to send the votes in to the Gold Cup Editor.

#### Announcer's Standing

The following are a list of the announcers who have fifty or more votes to their credit at the count of the fourteenth ballot:

Name	Station	Votes
George Hay	WLS	19,187
Bill Hay	KFKX	18,891
Leo Fitzpatrick	WDAF	8,219
J. M. Witten	WOS	7,795
The Hired Hand	WBAP	6,476
John Daggett	KHJ	5,984
Graham McNamee	WEAF	5,278
Richard Haller	KGW	3,768
H. W. Arlin	KDKA	3,564
Lambdin Kay	WSB	3,553
Sen Kaney	WGN	3,112
Fred Smith	WLW	3,091
Jack Nelson	WGN	2,939
Kolin Hager	WGY	2,260
Gene Rouse	WOAW	2,232
E. W. Tyson	WWJ	2,176
Elmer Johnson	WJAX	1,763
Miss V. A. L. Jones	KSD	1,645
H. E. Ehrhart	WDAR	1,632
S. W. Barnett	WOC	1,631
Major J. J. Fanning	WNAC	1,486
Otto Becker	WGR	1,122
F. W. Johnson	CHYC	1,030
Major Andrew White	WJZ	861
A. R. Herske	WTAM	859
Jennings Pierce	KGO	803
S. L. Rothafel (Roxie)	WEAF	594
A. O. Coggesil	WGY	552
J. T. Schilling	WHB	543
Milton Cross	WJZ	536
N. D. Cole	WHO	507
John T. Griffin	WHAH	505
N. T. Granlund	WHN	460
C. A. Entekin	WCAH	451
Paul Johnson	WLAG	450
Harold Selyer	WHAS	436
Henry Field	KFNF	423
Joseph Sartory	WCAE	405
Howard Milholland	KGO	403
R. Emery	WEEL	402

Chas. Erbstein	WTAS	338
Paul Reese	KFI	337
F. A. Buhlert	KFJC	334
W. A. Fay	WGY	313
Claire Morrison	KPO	304
Carl E. Hammond	KFOA	294
A. F. Edes	WBZ	286
Paul A. Greene	WSAI	244
Eleanor Poehler	WLAG	227
John Reilly	WJAR	212
Johnnie Mack	WJAS	209
Chas. H. Meester	WCBR	203
Victor Martin	WHAM	192
C. W. Kirby	WWJ	191
Wm. F. Holliday	WWJ	182
Morgan Eastman	KYW	169
Robert Weidaw	WGY	163
R. P. Falcon	PWX	153
Walter Wilson	KYW	153
C. D. Tomy	WCX	152
Wm. Ludgate	KSD	146
C. A. Gaal	KUO	145

## Deep Thought!

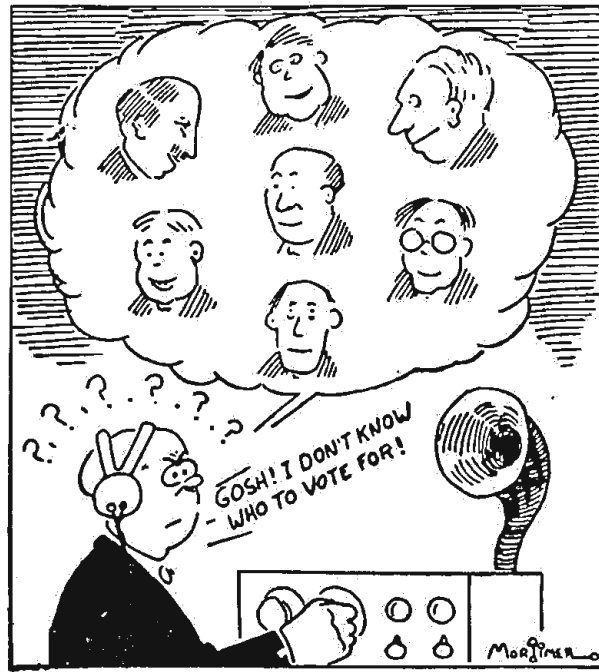

J. Lewis Reed	WJZ	140
Laigh C. Parker, Jr.	KFFY	138
Jerry Sullivan	WQJ	129
Don MacPhee	WAAW	112
Gilson V. Willetts	WOC	112
Eddie Smith	WGY	94
E. J. Bowers	CFCA	87
Art Burroughs	2LO	76
Carl Mentzer	WHAA	74
Joseph Nassau	WOO	62
Eddie Squires	KDKH	60
John F. Patt	WDAF	56
Steve Trumbull	KYW	52

### Entertain with Microphone Open

COLUMBUS, OHIO.—An enthusiasm unprecedented in summer Radio activity in central Ohio marked the first dispatch arranged Radio program given through a microphone left open all evening at Station WBAV of the Erner & Hopkins Co. The novel experiment, was to test the practicability of this form of transmission, and according to reports it was very successful.

# CONTENTS

Radio Digest, Illustrated, Volume X, Number 9, published Chicago, Illinois, September 6, 1924. Published weekly by Radio Digest Publishing Company, 510 North Dearborn Street, Chicago, Illinois. Subscription rates, yearly, Five Dollars; Foreign Postage One Dollar additional; single copies Ten Cents. Entered as second-class matter at the postoffice at Chicago, Illinois, under the Act of March 3, 1879.

"All the Live News of Radio".....	1 to 8
Operating and Trouble Shooting, for the Owner of a Microdyne Receiver.....	9
An Evening at Home with the Listener In, a chart to show when to listen in for your favorite station.....	10
Programs for the Week at the Larger Stations.....	11-14
Thirty-Minute A-B-C Lessons for Radio Beginners, Chapter XXIII—Fixing Up the Radio.....	15
Editorials; Indi-Gest; Condensed by Dielectric.....	16
Neutralizing the Super-Regenerator Circuit, Part III—Complete Instructions for Wiring and Tuning, by C. E. Butterfield.....	17
R. D.-125, Real Honeycomb Hook-Up.....	18
Reflex Hook-Up Puts Tone Into Reception, Aids in Picking Up Long Distance, by W. H. H. Knox.....	19
Flewelling Set with Radio Frequency, Simple Way to Increase Range of Famous Set.....	21
Questions and Answers.....	22
Radiophone Broadcasting Stations, Part V.....	23

## Looking Ahead

**New Type of Selective Receiving Set.** Mr. Kenneth G. Alley will tell about a new set he has developed, very selective and giving good volume. A set that resembles the neutrodyne when built in a cabinet.

**Getting the Best Reception Out of Your Tubes.** Right values throughout is necessary to good reception and Lieut. Harry F. Breckel tells you how to get them. The tube is the heart of the set and it requires plenty of attention with proper current supply.

**Radio Digest First Annual Gold Cup Award** for the world's most popular Radio announcer ends with this issue. By the time next issue reaches your hands the judges will be tabulating the final count and deciding the winner. Watch for the September 20 issue to learn who is the "King of Mikes!"

**Fixed Mica, Condensers and How They Are Made.** Constructional details covering all points on fixed condensers. After reading this article you will know better just how to select a condenser to fit in the place where it is to be used.

**Amplidyne System of Radio Frequency.** The first of a short series on this system of amplification. Written by Thomas W. Benson, who tells all about it in a simple understandable manner. Beginning next week.

Newsstands Don't Always Have One Left

WHEN YOU WANT

# Radio Digest

YOU WANT IT!

BE SURE OF YOUR WEEKLY COPY BY SUBSCRIBING NOW

SEND IN THE BLANK TODAY

Publisher Radio Digest, 510 N. Dearborn St., Chicago, Illinois.

Please find enclosed check M. O. for Five Dollars (Six, Foreign) for One Year's Subscription to Radio Digest, Illustrated.

Name .....

Address .....

City.....State.....

## Why be a Robinson Crusoe?

You may dwell far from the centers of activity or so love your abode that you hate to leave it. No need to. A Crosley Radio Receiver frees you from isolation and enables you to enjoy music, opera, current events, sermons and the latest news right in your home.

Crosley Receivers range from a one tube set at \$14.50 to the three tube Trirdyn with four and five tube efficiency at \$65.

For Sale by Good Dealers Everywhere

Write for Complete Catalog

**The Crosley Radio Corporation**  
POWEL CROSLY, Jr., President  
9491 Alfred St. Cincinnati, O.

Crosley owns and operates broadcasting station WLW



**CROSLY**  
Better-Cost Less  
Radio Products

Two tube Crosley No. 51  
Price, without accessories \$18.50

A Regenerative set licensed under Armstrong U. S. Patent 1,113,149. In just 24 days this little wonder set became the biggest selling radio receiver in the world. It represents wonderful radio value.

# THORDARSON

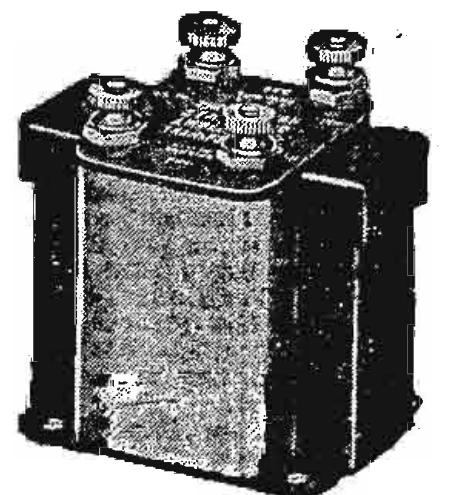

## 2 to 1 Ratio

(audio frequency)

## TRANSFORMER

FOR PERFECT MUSICAL REPRODUCTION

Produces unusual richness of tone quality with extremely small sacrifice in volume.

Especially adapted for use in sets having a large detector out-put such as tuned and untuned radio frequency and reflex sets.

Functions exceptionally well with dry battery tubes as it prevents distortion caused by overloading tubes.

Price \$5.00

You Will Find Thordarson Transformers in More than a Score of the Best Manufactured Sets

# THORDARSON

ELECTRIC MFG. CO.

500 W. Huron St. CHICAGO, ILL.



# VARIED EXPERIENCE IS HELP TO DE PEW

## ANNOUNCER FOR STATION WCBD; LONG AT ZION

One of the First Settlers at City; Has Been with Station Since Beginning

ZION, ILL.—Mr. J. H. DePew, Chief Announcer and Manager of Station WCBD, is one of the pioneer residents of Zion, having affiliated with the church founded by John Alexander Dowie in the early days of its history in Chicago, and was among the very first on the scene at the inception of the City of Zion in Lake County, Illinois.

Mr. DePew was called into the service of Dr. Dowie in 1901, to help establish the first general merchandise store in the community. First as clerk and later as department manager, Mr. DePew remained in the Zion store until the population had grown from half a dozen workmen to a community numbering over two thousand, within slightly more than a year from the time of his arrival. He was elected the first City Clerk and served several years in that capacity and later was chosen by Dr. Dowie as his personal attendant, accompanying him on his travels and acting as office man and factotum when at home.

### Leaves Zion City

When the financial difficulties in the city arose in 1906, Mr. DePew perforce joined the dispersion in common with many other young men, and sought elsewhere for employment, finally drifting to the Isthmus of Panama where he engaged with the government in connection with the work of digging the Panama Canal. The latter part of his five-year stay in the Canal Zone was as private investigator for General Geo. W. Goethals, Chairman of the Isthmian Canal Commission and Chief Engineer of the Panama Canal.

Early in 1912, Mr. DePew removed to Zion and entered the employ of Wilbur Glenn Voliva, Dr. Dowie's successor as General Overseer of the Church, in the same capacity he occupied with Dr. Dowie, that of personal attendant and office man.

### Appointed Announcer-Manager

He continued in this position until Mr. Voliva decided to erect a broadcasting station, when he was made manager and first announcer. Mr. DePew is a man of family, having a wife and four sons, three of whom are grown to manhood. Mr. DePew is a native of the state of Texas, having spent the early years of his life on a cattle ranch in San Saba County.

Station WCBD is located in the geographical center of Zion city. The Radio building stands in the center of the Temple site—a ten-acre tract of ground—which is surrounded by Shiloh Park, a preserve of two hundred acres. This building and the Shiloh Tabernacle being the only buildings within the preserve.

The present installation is a Western Electric 500-watt transmitting set, but a contract has been signed for a 5 kilo-watt set, delivery to be made next January.

## Plan to Tell Public About "Fly-by-Night" Stock Firms

YOUNGSTOWN, OHIO.—A list of stock selling firms which have been found to be unreliable hereafter will be broadcast every two weeks by the Better Business Bureau of New York, which is affiliated with the Associated Advertising clubs of the world, it has been announced by the Youngstown Ad club.

The innovation was suggested by a member of the Youngstown club. Heretofore the list prepared by agents of the Associated clubs has been furnished to banks, and the new plan aims at a wider distribution of the information.

In Manchester, England, a progressive tinker has established a new sort of peddling. He goes about the streets doing odd jobs in repairing broadcast receivers and carries a selection of spare parts for such apparatus.

## SO SHE HAD HIS SET PUT UNDER CURFEW

CINCINNATI.—George Wann must not listen in on his Radio after 10 o'clock at night. So Municipal Judge George F. Eyrich, Jr., recently ruled when Wann was arraigned on a charge of disorderly conduct. Mrs. Sophia Decker, same address, who swore to the charge, testified that Wann's loud speaker kept her awake at nights. She charged that Wann called her vile names when she remonstrated with him.

## HOSPITAL PATIENTS SMILE WITH RADIO

SCHENECTADY, N. Y.—"The Radio stations are making the hospitals smile now," exclaims Rudolf Emman, a patient in Lawrence hospital at Bronxville, N. Y., in a letter to WGY here. He goes on to describe how nine of the patients enjoyed the broadcasting of the play "Pollyanna," and how the following week the entire hospital was invited into the men's ward, which became a miniature theater for the evening.

## POPULAR CHIMES OF ZION CITY

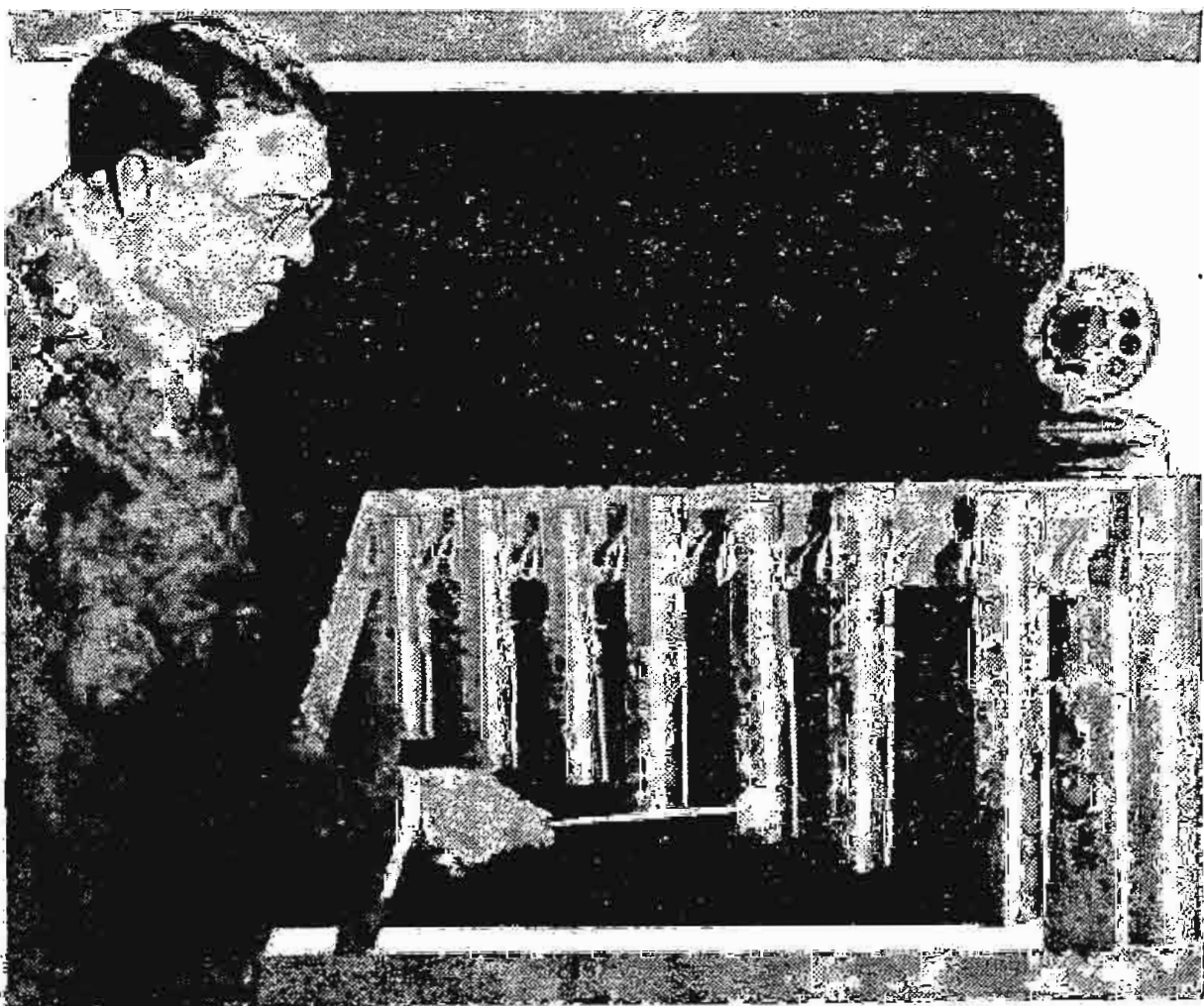

J. DePew, announcer at Station WCBD, playing the chimes used at the end of each program and which are said to be the most musical in the country. P. & A. Photo

## WCX Announcer's Heart with Blind

### Ted Harrington Finds Soul Interest in Helping Sightless to Utilize the Greatest Modern Inventions

DETROIT.—Ted Harrington, who announces so pleasingly every day and evening at Station WCX, the Detroit Free Press, is not a blind man, but his sympathy goes out to these unfortunate folk, and it is his greatest delight if he can do anything that can relieve their handicap.

He has found Radio to have unsurpassed advantages in this respect. There is hardly a week goes by that he doesn't hunt out some one of these persons and aid him in acquiring a set. When it is once established he sees that it is maintained in good order. Then he makes it a point at certain times to broadcast special programs and other information that will be encouraging.

### "Open Up New World to Blind"

"My heart has always gone out to the blind people, and I have found Radio one of the greatest blessings that has ever come to them," he said.

"It is difficult for people afflicted in this way to get about, and when they do, they are usually dependent on others to help them. With Radio it is different. By its use the blind can enjoy all of the best music, church services and a vast amount of other entertainment without depending

on anyone. That is why I am encouraging the blind wherever possible to acquire a Radio set. I believe these afflicted people appreciate Radio more than those who see. It is like opening up a new world to them, and I want to help them all I can.

"We have heard a lot about the pleasures the deaf get out of the Radio. I am glad of that also, but think how much more pleasure and comfort the blind must get from it."

## INVENT IGNITION THAT WORKS IN DEATH RAY

### Swiss Engineers Do Away with Electric Magneto System

GENEVA.—One result of the work of Grindell-Matthews and other inventors of "death rays" is that two young Swiss engineers here have perfected an internal combustion motor which uses a substitute for the magneto ignition system. The two men, Gerber Walter and Melliore, decided that if the magneto of a motor was so sensitive to Radio waves they must find some way to avoid this difficulty.

They devised, therefore, a system of explosion by air-compression on the same general principal as the Diesel motor; save that instead of igniting the cylinder gasses by compression, it is the air in a small chamber above the cylinder which is heated by fast compression to such an extent that when admitted to the cylinder it explodes the gasses therein as effectively as does the present spark-plug.

## KOP'S THREE AUTOS CATCH HOLD-UP MEN

### SPECIAL RADIO-EQUIPPED CARS ACT EFFICIENTLY

#### Broadcast Reports of Crimes Enable Flying Squadrons to Keep in Touch with Headquarters

DETROIT.—Three separate gangs of hold-up men have been caught redhanded by the Radio equipped police automobiles of Detroit. Capable of a speed of eighty miles an hour, these cars are in constant touch with the police broadcaster, KOP, using a wave length of 286 meters.

The automobiles are remarkable in many respects, and were designed specially for police patrol work. In each of the three above instances, a telephone alarm to Police Headquarters was promptly broadcast by Radio to the police cars, and in all three cases they arrived at the scene of the attempted crime in time to apprehend the perpetrators.

The automobiles are equipped with special sets installed in the back of the front seats. The aerial is built in the permanent top, and the body of the car acts as a counterpoise ground.

### Bullet Proof Windshield

From outward appearances there is nothing to indicate that the automobiles are unusual in any manner. This is due to the concealed aerial which consists of four wires stretched back and forth inside the automobile top.

The receiver is fastened permanently in its compartment back of the front seats and the batteries are located close to it.

The windshield is seven-eighths inch thick, and is bullet-proof. Two gun-racks are installed in the cars fitted on the heel-boards of the front and rear seats. Sawed-off shotguns are carried in them.

The receiving sets are sealed in adjustment to Station KOP. Loud speaker reception is used so that the crew can hear an alarm the instant it is broadcast.

## "Hyperprism" Almost Is Musical—Almost!

### But Kind Composer Limits Radio-cast to Five Minutes

LONDON.—Undoubtedly the most interesting event in recent British programs has been the broadcasting of "Hyperprism," the composition of Mr. Varese, a futurist musical composer, who has just arrived from the United States.

When it was put on, the general opinion among listeners in was that something had gone radically wrong with their sets or that Senatore Marconi had finally succeeded in connecting up with the Moon and had relayed a message from there as a surprising climax to the evening's performance.

"Hyperprism" can scarcely be called a composition—it is really an arrangement of sounds in certain gradations, according to the emotional effect they produce. There is absolutely no harmony and only a crude species of rhythm. The sort of noises the studious youth of England makes at Oxford and Cambridge when it runs along the banks of a river during a boat race is a gentle titillation in comparison. Fortunately, however, for the auditory apparatus of those enthusiasts who endured the pandemonium, Mr. Varese was merciful when he concocted "Hyperprism"—it only lasts five minutes.

### Austrian Police Use Sets

VIENNA.—In Austria there has been such a mania of speeding in automobiles that drastic measures to stop it are being taken by the police, who have decided to make use of Radio. Police cars furnished with transmitting and receiving sets are now patrolling the roads ready to give chase to any reckless driver or pass on word to the next police auto so that a trap may be set.

## THE ANTENNA BROTHERS

## Spir L. and Lew P.

## Modernized Redskins

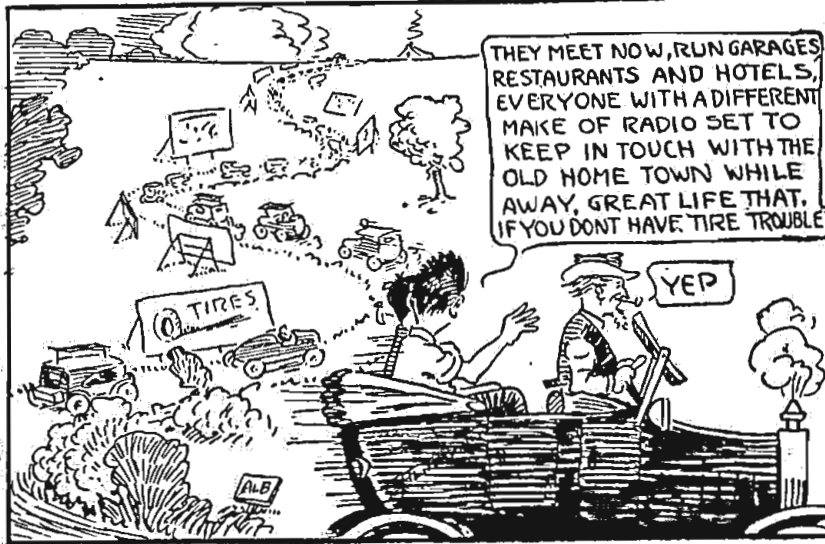
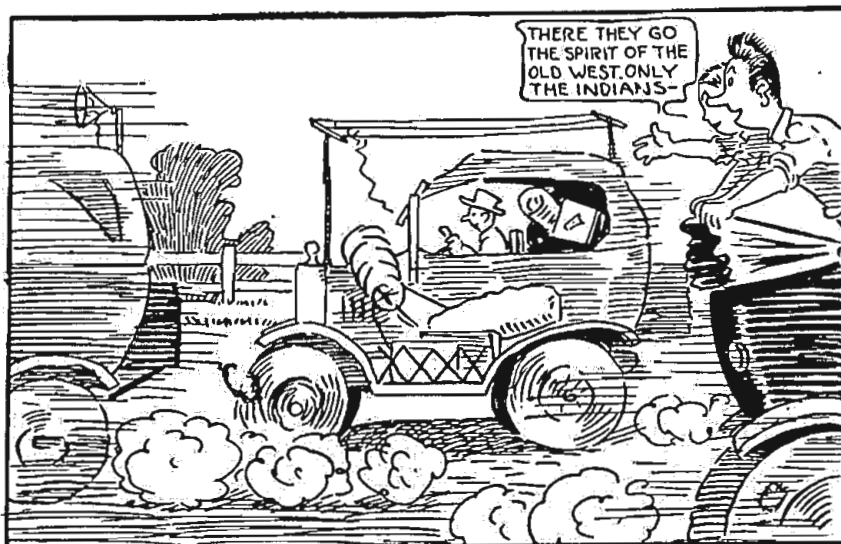
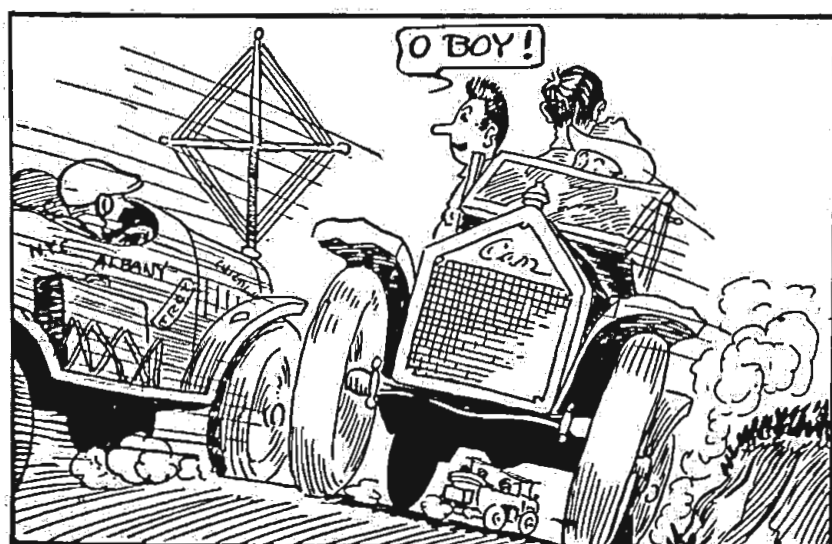



## SANTA CLAUS SENDS MESSAGES TO WLW

INVITES KIDDIES TO OUTING FOR BIG SPECIAL TREAT

Fred Smith, Acting for Old Man, Tells Children to Bring Friends; Record Crowd

CINCINNATI.—Santa Claus never forgets little children. Kiddies may forget all about the jolly, old fellow when summer-time is here but he is ever thinking of how to make the little folks happy. Santa is so busy now with his paints and tools making pretty toys to be given out at Christmas time, he cannot get away from his workshop up there. He did send a message by special courier and Fred Smith, studio director of the Crosley Station WLW where Santa visited last year, acting on his orders told every little child about the wonderful Midsummer Festival Santa provided for last Saturday afternoon in Burnet Woods, Cincinnati.

All the kiddies and their friends in Greater Cincinnati, Covington, Newport, Hamilton, Dayton, Middletown and many other places throughout Ohio, Kentucky and Indiana, were invited by Santa, Fred Smith speaking for the kindly old man.

**Plenty to Eat and Drink**  
Though thousands of kiddies came, there was plenty of ice cream and lemonade, for the French Bros.-Bauer company, sent out as much or more (?) than ten thousand children can eat and drink. Will Reeves, of the Community Service, directed a program filled with wonderful things, including folk dances by pupils of Mlle. Fedorova's School, under her personal direction; community singing, led by Will Reeves; band music through the courtesy of the Cincinnati Musicians' Protective association, and soprano solos by Mary Kaufman Brown.

Santa Claus told the children through Fred Smith that he would be back three weeks before Christmas to tell them through the Crosley WLW station, of the wonderful new toys he invented and that he was happier than ever.

## GOLDMAN'S BAND GIVES FAREWELL

Last of WJZ-WGY Concert Series Till Next Summer Heard by Fans

NEW YORK.—The fifteenth and final concert by the famous Goldman band was broadcast by both stations WJZ, New York, and WGY, Schenectady, on Sunday evening, August 24. The concert closed the seventh successful season of the Goldman concerts and the second season of the broadcasting.

The closing program was arranged by Edwin Franko Goldman, the founder and director of the organization, and featured the two soloists who have gained the greatest distinction during the season, Waino Kauppi, cornetist, and Genia Fonarilova, soprano, being designated for that program.

**Concerts Have Created Favor**  
The Goldman band, long recognized as the only organization of its kind in the country, has during the past three months added a new achievement to its reputation, for the programs which it has presented this summer have, in the majority of cases, been strictly national in character.

In this way the band has rendered the most difficult and most beautiful compositions of every country in turn, necessitating a completeness of repertoire which is seldom found in such an organization. The interpretations as expressed by the band, under the baton of Mr. Goldman, have caused overwhelming applause and appreciation from Radiophans throughout the country, placing the concerts in the forefront of broadcast events.

WJZ and WGY have been able to broadcast the splendid concerts through the co-operation of Mr. and Mrs. Daniel Guggenheim, Mr. and Mrs. Murray Guggenheim, donors of the concerts, and Edwin Franko Goldman.

## German Overshadows French

VIENNA.—The new station here makes the fourteenth broadcasting station using the German tongue on the Continent as compared with only seven stations using French. This situation is attracting unfavorable comment in France, where any superiority of German enterprises is still regarded with suspicion.

## EAST AND MIDDLE WEST MEET



"Roxie" (S. L.) Rothafel, the most popular New York announcer, and Jack Nelson, whose announcing and songs were factors in the success of former WDAF, now WGN, get together for a few moments when Roxie had occasion to come to Chicago. Photo by Drake Studio

## WQJ Entertains Canadians

CHICAGO.—Station WQJ, seems to be the official entertaining station for the Canadian National Railways through Canada. They have received messages

from the operators on board all the Trans-continental trains enroute through Canada, stating that the programs were being received clearly, and were appreciated by all the passengers.

## RADIO SHAM BATTLE

(Continued from page 1)

WHAS, to whom the idea may be credited, was closely in touch with his "correspondent," Colonel Hamer, during the two day battle.

The military announcer, who will be known as the first "war" announcer, is on the staff of Major General Tyndall, who had complete charge of the operations of the sham battle.

The feasibility of Radiocasting war action direct from the battlefield to the citizenry of the interested countries was proven beyond degree of doubt. The only problem that presents itself is the question of censorship. The enemy would know too well just what was going to happen next were the scheme to be carried out without censorship in actual warfare.

## Claim That French Station Ruins English Radiocasts

PARIS.—In the readers column of "L'Antennae," the Paris Radio newspaper, appears a wretched plaint from a French amateur who claims that Radiola, located in this city, is purposely attempting to break up the English concerts.

It is claimed by this listener that while the Paris station does not go on the air officially until 12:30 p. m., he can often be heard "tuning in," with the microphone cut in, long beforehand—thus ruining the English Radiocasts.

France is planning a comprehensive net of regional broadcasting stations in the eastern, southern and central parts of the country.

TESTED AND LISTED AS STANDARD BY UNDERWRITERS' LABORATORIES

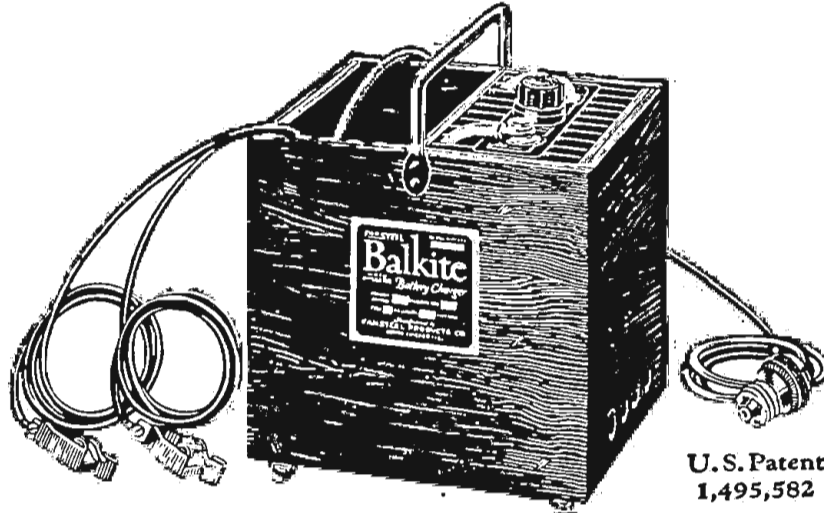

U. S. Patent  
1,495,582

This noiseless, bulbless  
**battery charger**  
has gained universal acceptance in less than a season

The Balkite Battery Charger is today universally known and accepted as one of the most efficient and trouble-free methods of charging radio batteries. It is based on a new principle, the use of Balkite, a rare metal developed for this purpose. This metal changes the AC current commonly used for lighting to the DC current necessary for charging batteries without the use of fragile bulbs or noisy vibrators.

1. The Balkite Battery Charger is entirely noiseless.
2. It cannot deteriorate through use or disuse.
3. It has no contact points, bulbs, vibrators, or moving parts.
4. It has nothing to adjust, break, or get out of order.
5. It cannot discharge or short circuit the battery.
6. It requires no attention other than an occasional filling with distilled water.
7. It delivers a taper charge, and cannot damage the battery by overcharging.
8. It cannot fail to operate when properly connected to the battery and line current.
9. It is unaffected by temperature or fluctuations in line current.
10. It will charge a completely discharged battery.
11. Its operation does not create disturbances in either your set or your neighbor's.
12. It is simple, efficient, and indestructible except through abuse.
13. Designed primarily for charging "A" batteries, it will also charge "B" batteries of the lead type without added attachments.
14. It can be used while the radio set is in use, without affecting the set or its operation, and without disturbing noises.

The Balkite Battery Charger will charge the ordinary 6-volt radio "A" or automobile battery at 3 amperes, from 110-120 AC, 60 cycle current. Special model for 50 cycles. For sale by all leading radio dealers. If your dealer cannot supply you, sent direct, prepaid, on receipt of price.

Manufactured by FANSTEEL PRODUCTS COMPANY, Inc., North Chicago, Illinois

DEALERS: Order through your jobber. JOBBERS: Write to our factory representatives. Where we are not represented, write to us.

Factory Representatives: Ekko Company, 111 W. Monroe St., Chicago. J. P. Rainbault, 50 Church St., New York City. Wood & Lane, 915 Olive St., St. Louis. Chas. F. Saenger & Co., 919 Huron Road, Cleveland. Detroit Electric Co., 113 E. Jefferson St., Detroit. The Hoy Company, 719 McKnight Bldg., Minneapolis. A. S. Lindstrom, 111 New Montgomery St., San Francisco. Burndep of Canada, Ltd., 172 King St. West, Toronto, Ont. Sparling-Markle, Ltd., 276 Smith St., Winnipeg, Man.

FANSTEEL  
**Balkite Battery  
Charger**  
Price \$19<sup>50</sup>  
West of the Rockies \$20 • In Canada \$27<sup>50</sup>



# WCAP, WHERE OUR LAWS ARE MADE

WCAP, the Chesapeake & Potomac Telephone company at Washington, D. C., while now possessing a studio for Radiocasting, still obtains many of its programs via the mobile pick-up truck at the right. The national capital, of course, is rich with material suited to such methods. Many of these programs have not gone on the air alone from WCAP, but from numerous other stations simultaneously. In the latter case programs are sent by telephone wires to WCAP at New York, from whence the broadcast is distributed by long distance telephone lines to stations participating. O. Paul Gascoigne is the announcer.

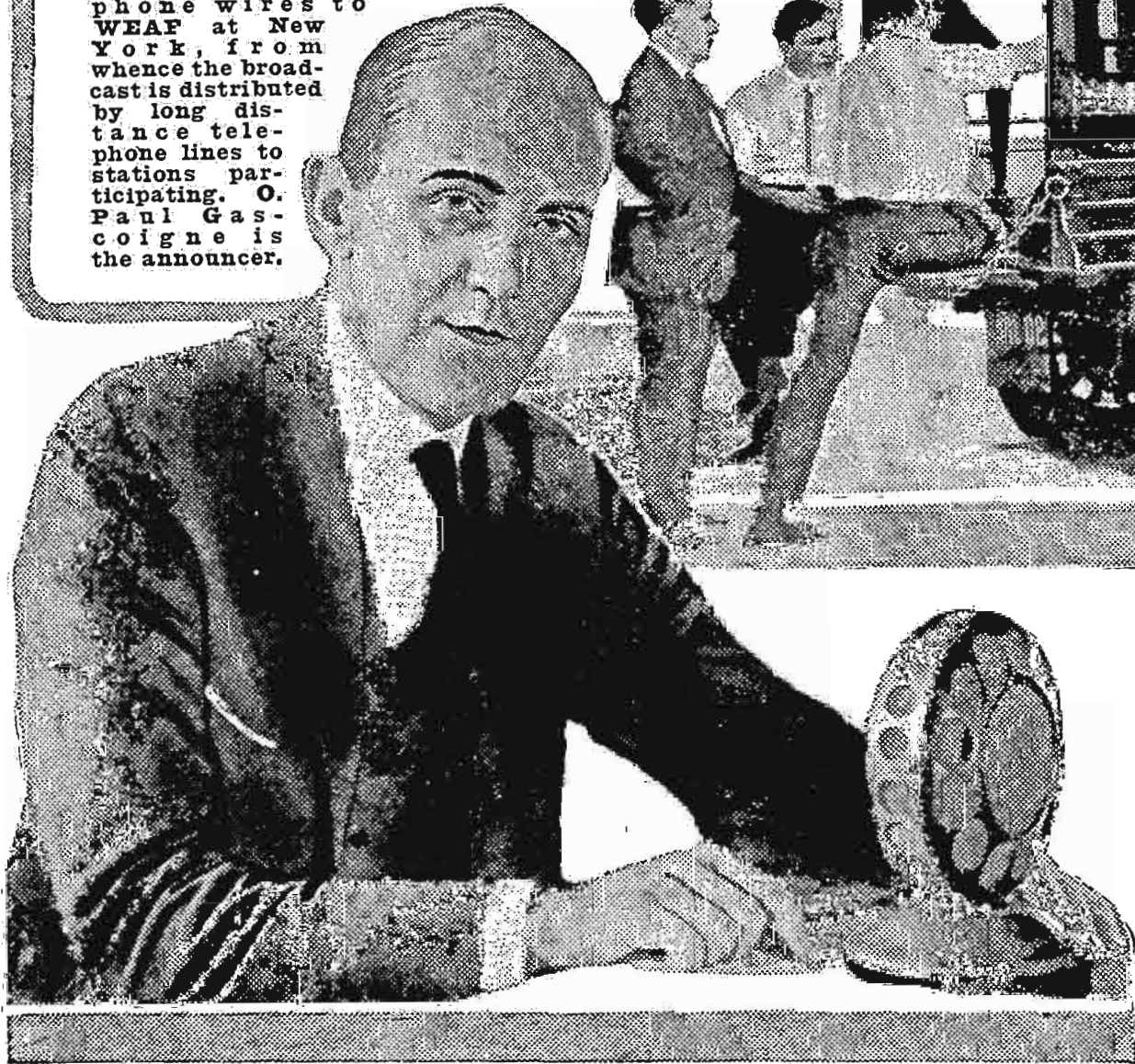

## WGY ANNOUNCES ITS SPORTING CALENDAR

### WJZ TO CO-OPERATE IN BIG TIME FALL EVENTS

Epinaud Races, Polo Matches, World's Series, Football Planned for Radiophans—White to Announce

SCHENECTADY.—Radiophans within tuning distance of WGY, the General Electric company station here, or WJZ of New York, will be able to enjoy some of the leading national sporting events of the next three months.

One of the first of the series of these was the recent race between Epinaud, the famous French four-year-old owned by Pierre Wetherheim, and the best American horses. Another Epinaud race will take place September 27 on the Aqueduct track. Like the first, the second race also will be described by J. Andrew White, the famous announcer whose description of world's series baseball games and prize fights, is well remembered.

#### Polo Matches Scheduled

Another event of international interest will be the polo matches between the pick of Great Britain and the best players of the United States. These matches scheduled for September 6, 10, and 13 at the Meadowbrook Club, Westbury, L. I. The matches will begin about 2:30 o'clock, Eastern standard time, and will last approximately two hours.

Two announcers will be used to carry the complete story to Radiophans. J. Andrew White will give the color story, that is, the crowd, names of the celebrities and possibly a brief description of some of the gowns.

#### World's Series and Football

It is probable that WGY, will, as in the past two years, broadcast the world's series baseball games. Definite plans cannot be made until the final games of the big league schedules, especially in the American league where the fight for first place is very keen.

WGY will also cover the 1924 football season, offering some of the leading eastern games. The schedule as now arranged provides for the following: November 1, West Point vs. Yale, at New Haven; November 8, Yale vs. University of Maryland, at New Haven; November 15, Yale vs. Princeton at Princeton; November 22, Harvard vs. Yale, at New Haven; November 27, Cornell vs. the University of Penn., at Philadelphia; November 29, West Point vs. Annapolis, at Baltimore, Md.

WGY will broadcast all of these events in co-operation with WJZ of New York.

## HANDEL'S "MESSIAH" IS RADIOCAST BY WBZ

### Famous Oratorio Given by 200-Voice Chorus

SPRINGFIELD, MASS.—Handel's "Messiah," by a chorus of 200 voices direct from the municipal auditorium, Springfield, was the rare musical treat which Westinghouse Station WBZ broadcast to its listeners last Sunday night.

The Worcester district of the Luther League society of the Swedish Lutheran church was meeting in Springfield for a three-day convention and Handel's master-oratorio was the fitting climax of the assembly. This made the third performance of the Messiah, last year's oratorio being given in Worcester.

## Radarios Make Fans Turn Off Lights, Enforce Etiquette, Speak Clearly

### Letters from KGO and WGY Listeners Show Peculiar Effects Radio Dramas Are Causing—May Even Cause Revisions to Books on Subject of Etiquette

RADIO listeners are rapidly learning that it is necessary to put themselves in the proper frame of mind to appreciate a drama over the air, is the opinion of Wilda Wilson Church, director of the KGO players, Oakland, Calif.

Many letters received at KGO show that listeners turn down their lights when listening to a Radio play. Commenting on this Mrs. Church said, "In order that persons in the audience may get away from the consciousness of self and other selves about them, the lights in the theater are turned out. We may smile when we recall how Robert Burns lost the sermon in church because of the louse on the lady's hat, but we must remember that what we see so easily distracts us."

The Radio drama has its advantages over any other form. It requires only the scenery that listeners can imagine. "And when we are at home surrounded by old familiar things, which do not strike the eye as unfamiliar things do," said Mrs. Church, "we can more easily concentrate through our sense of hearing upon the idea of the play being broadcast."

#### Etiquette of Radario Listening

Unless invited it soon will be a mark of discourtesy to call upon friends when they are enjoying a Radio play. At least, letters received in appreciation of the

## PARTY NIGHT FOR ALL ANNOUNCERS

### "Solemn Old Judge" at Station WLS Gives Treat for Local Workers

CHICAGO.—As a rule Radio announcers have very little time to themselves outside the studio to devote to social entertainment. The "Solemn Old Judge," realizing the need, recently had a little party during and after the regular nightly program at Station WLS, the Sears Roebuck Agricultural Foundation.

Radiophans who tuned in to WLS that night, had the privilege of hearing not only the announcers from the local stations but many Chicago artists popular with the Radio public.

When a vote was taken as to what kind of a time the guests were having, they went on record as saying that it was the best time they had ever had. The "Judge" then told the listeners all about it, meanwhile munching on a cheese sandwich and drinking a glass of milk.

"Static," the station parrot mascot, was very much in evidence. Since adding him to the staff of the station he has refused to speak, and it wasn't until "Shorty" Fall of KYW appeared on the scene that he would talk. Taking the advantage of the WLS crowd, Shorty proceeded to teach him to say "KYW."

The "Judge" appeared just as Static had mastered "K" and put a stop to the lesson in English.

## COLLEGE COURSE TO BE GIVEN VIA RADIO

### ENROLLMENT BLANKS AND CATALOG ON REQUEST

#### Students Who Pass Examinations Will Be Awarded Certificate of Graduation from Extension School

MANHATTAN, KAN.—A regular eight months' Radio college course will be broadcast this fall and winter from Station KSAC, the Kansas State Agricultural college, here. Courses and a description of the forty subjects are listed in a special forty-eight page catalog now ready for free distribution.

The "College of the Air" program will be radiocast on a wave length of 341 meters from the 500-watt transmitter now under construction on the college campus. School will begin promptly at 7:00 p. m. central time each week night, starting this fall.

The extension Radio curriculum consists of four general courses: Monday and Tuesday, agriculture; Wednesday, engineering; Thursday, home economics; Friday, general science. There is no charge for the work.

#### Everyone Welcome to Enroll

Radiophans over the entire United States are asked to apply for enrollment in one or all of the forty courses on the extension Radio curriculum. A written examination at the completion of the college air program will entitle students to a certificate of graduation from the first regular Radio extension school ever conducted.

This year's course is an outgrowth of a ten weeks' program broadcast by the college last fall through Station KFKB. Some 1,500 students enrolled in the short course last year, and thousands of others listened in. Enrollments were received from every state in the Union as well as from Canada and Mexico. The students highly commended the course and encouraged its expansion this year.

The catalog and enrollment blanks will be supplied by the extension division of the Kansas State Agricultural college, Manhattan, Kans.

## Australia Removes Seal Ban from Sets

### Radiophans Can Use "Open" Receivers Freely Now

WASHINGTON, D. C.—Australia has just removed the prohibition against the use of any but sealed Radio sets and open sets may now be used freely, according to a report to the department of commerce from Melbourne.

The broadcasting stations that have been established will remain in operation and licenses of two classes will be issued as before, namely: "A" license, to be issued to persons who receive revenue from the users of receiving sets, and "B" licenses, issued to such persons or firms who broadcast without remuneration from owners of receiving sets.

The wave lengths to be assigned range from 250 to 2,000 meters.

Advertising may be broadcast provided it is previously announced as such.



# ROBERT BONIEL NEW DIRECTOR AT WEBH

## FORMERLY WITH STATION KYW AS PUBLICITY MAN

### Has Many Surprises and Stunts Which Will Be Given to Radiophans Very Soon

CHICAGO.—Station WEBH, Edgewater Beach hotel, of this city, has acquired the services of one of the most well known and best liked directors in the world. And that man is "Bob" Boniel.



Long connected with various magazines and newspapers throughout the country, and lately as publicity manager for the Westinghouse company and Westinghouse Station KYW, where he has been a "power behind the throne." It is to Bob Boniel that much of the credit should be given for the success of KYW.

Known in dramatic and theatrical circles, he has staged and directed the various reviews and appearances of notables upon their arrival in this city. Because of this everybody who has come in contact with him is glad to call Bob Boniel his friend.

### Has Surprises and Stunts to Come

Bob has had more publicity in the various papers throughout the country for Westinghouse Station KYW than any other publicity man in existence. Station WEBH is fortunate in securing the services of Mr. Boniel and is to be complimented upon its choice as a worthy successor to the preceding directors of that station.

WEBH has in the opinion of many, fallen down in popularity of late. Bob Boniel it is believed, will bring the station back to standard again. With Mr. Boniel's originality and initiative, many surprises may be expected from the station during the coming fall season.

Mr. Boniel has many novel ideas and "stunts" which will be given to Radiophans as fast as he can put them over.

# Checking Waves from Stanford University

## 6XBM to Assist Bureau with Standard Frequencies

PALO ALTO, CALIF.—Arrangements have been made for the transmission of standard frequency signals for the bureau of standards by Station 6XBM, Stanford university here. Beginning in September, these signals will give to the western part of the United States the same standard frequency service that is available in the eastern half of the country through the transmissions from the bureau of standards laboratory in Washington, D. C. In preliminary trials the 6XBM signals have been heard as far east as Minneapolis, Minn.

The signals will duplicate those of the bureau of standards in schedule, character and possible methods of utilization. The schedule of transmission on September 5 and 22 will be similar to eastern schedule, except that the time will be Pacific standard time. The transmissions are from 11:00 p. m., the dates scheduled, to 12:32 a. m. On September 5 the frequencies will be from 300 to 666 kilocycles (1,000 to 450 meters), and on September 22 from 550 to 1,500 kilocycles (545 to 200 meters).

# Zal Jacobs Asks Fans to Be Own Critics of Playing

NEWARK, N. J.—Zal Jacobs, a pupil of Gadowsky and other well-known maestros, broadcast a recital at WOR last Wednesday evening.

Mr. Jacobs has played in several recitals but he is very reticent and asks that the Radio audience form their own opinion of his ability from his work rather than by the gracious phrasing of press critics. He firmly believes that the microphone is more exacting.

# French P. T. T. and F. L. Announce Fall Schedules

PARIS.—The P. T. T. station of Paris announces that during the month of September they will broadcast only on Sundays, Tuesdays, Wednesdays and Saturdays. The Sunday broadcasts will be given simultaneously with that of the Eiffel Tower.

The Eiffel Tower will continue its short wave transmission experiments during September on the same schedules as before.

# STORY TELLER WHO AMUSES CHILDREN



ABOVE is shown the beaming smile of The Kansas City Star station "Tell-Me-a-Story Lady," Mrs. J. Leon Coulter, who probably is known to as many of the juvenile listeners as any voice on the air. Mrs. Coulter has been with several broadcasting stations of the country, her last six months having been spent with WDAF. During July and part of August, The Star's Tell-Me-a-Story Lady was on her vacation, and hundreds of letters from the listeners were forwarded to her in Omaha where she spent most of the time. During her vacation, Mrs. Coulter visited several broadcasting stations, and had special programs from WOAW and WAAW, Omaha, and the Henry Field station, KFNF, at Shenandoah, Ia. Monday night at WDAF is "request story night."

# FOOTBALL GAMES FROM WEAO SOON

## Will Radiocast Direct from Stadium So That Fans Can Hear Results

COLUMBUS, OHIO.—Radiophans who are too far away or are unable to see first hand the football games in the Ohio stadium this fall, will get a greatly improved first-hand account of the games Ohio State will play at home in October and November, even cheering thrown in for good measure. Plans have been approved for the erection of a semi-sound-proof booth in one of the stadium press boxes, from which the accounts of the games will be broadcast direct.

For several years the University Radio station WEAO has broadcast accounts of the games during the football season in addition to its regular programs. The reports of the football games, however, have been relayed by telephone from the stadium to the broadcasting station.

Under the supervision of Prof. Charles A. Wright, acting head of the department of electrical engineering, WEAO will broadcast direct from the stadium. As a result it will be possible to give better and more prompt service and the sending radius will be greatly increased, thereby making the service available to a much larger number of Radio and football fans.

Last year the reports of the games broadcast from WEAO were heard in all parts of the middle west and even from one or two points in Canada. The University Radio station operates on a wave length of 360 meters.

Prior to the actual start of the games, the official starting line-ups will be announced and changes in the line-up will be given as they occur. A complete service, practically simultaneous with each play as it occurs, is in prospect for the thousands of Buckeye followers who can't see the games in person, but who have access to a Radio set.

# Kilocycle Conversion Tables

WASHINGTON.—The bureau of standards has prepared a new and more complete table of kilocycle-meter conversions, copies of which are available to those desiring detailed information for reference. The table gives accurate conversion values from 50 meters or 5,996 Kcs. to 5,996 meters and 50 Kcs. The table is reversible and the range may be extended by shifting the decimal points.

# There Are Going to Be More ALL-AMERICANS This Fall

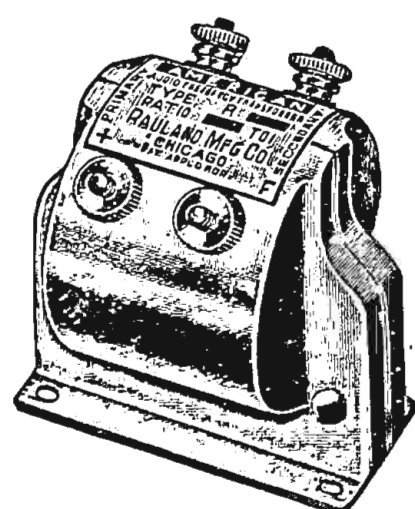

- ALL-AMERICAN AUDIO**
- Three Ratios
  - 3 to 1.....\$4.50
  - 5 to 1..... 4.75
  - 10 to 1..... 4.75
- POWER**
- Input.....\$6.00
  - Output..... 6.00
- LONG-WAVE**
- 4,000-20,000 meters.... 6.00

RAULAND MFG. CO., 2640 Coyne St., Chicago  
PIONEERS IN THE INDUSTRY

About a year ago many fans first began to realize that they wanted serviceability in a radio set, as well as range and volume and beauty of tone. Maybe that's the reason why the demand for All-Americans outstripped the supply before the season was well started.

This year it's different. The big new All-American factory has a capacity of many thousands of transformers daily. And the popularity of All-Americans continues to grow as more and more fans learn this secret of a good receiver: Use a good circuit. But whatever circuit you use, you must use good parts!

The good circuits, too, are to be found, presented in wonderfully clear style, in the new RADIO KEY BOOK. It would be a big fifty cents worth at any book store, but we mail it to you direct for 10 cents, coin or stamps. Send your dime today.

# ALL-AMERICAN

AMPLIFYING TRANSFORMERS  
Largest Selling Transformers in the World

# Consider This—

Radio has opened up the resources of the world for you. All this pleasure and education is at your call if you give the proper treatment to your receiving set. By using this scientifically perfect condenser you guarantee power to your set.

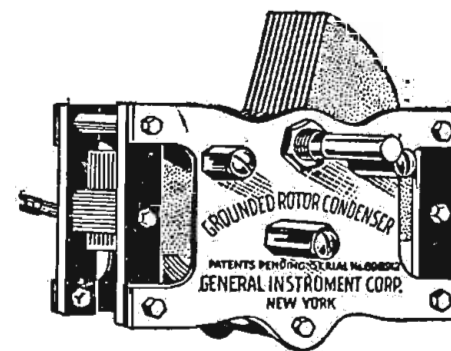

# THE LOW LOSS GENERAL INSTRUMENT CORPORATION GROUNDED ROTOR CONDENSER

Type	Minimum	Maximum	Price
Type 46X 11 Plate	5 MMFD.	.00025 MFD.	\$4.50
Type 46A 13 Plate	6 MMFD.	.0003 MFD.	4.50
Type 46D 21 Plate	9 MMFD.	.0005 MFD.	5.00
Type 46F 43 Plate	15 MMFD.	.001 MFD.	5.50

AT YOUR DEALER

Otherwise send purchase price direct to us and you will be supplied.

# GENERAL INSTRUMENT CORP.

423 Broome Street  
NEW YORK CITY



# WELL-KNOWN TRAVELING ANNOUNCER

## LONG LINES MAKING McNAMEE POPULAR

### WINS PUBLIC FAVOR WHEN COVERING ASSIGNMENTS

Excellent Voice Makes "Hit" Announcing Sports as Well as Music and Political Speeches

NEW YORK.—Through his colorful descriptions of the Republican and Democratic conventions and the two presidential nominees' acceptance ceremonies, Graham McNamee's resonant voice has become familiar to millions of Radio listeners in all parts of the country—not that his laurels have been earned alone during the conventions or acceptance speeches, for Mr. McNamee has figured prominently in many important broadcasts involving the connection of numerous stations by telephone lines. His most recent assignments, however, have sent his voice over so wide an area—no less than eighteen stations, a record number—that he has won many new friends.

Mr. McNamee's abilities, however, are not limited to handling political events. He is a baritone of no little distinction, having won the encomium of such renowned critics as Richard Aldrich, W. J. Henderson, Henry T. Fink, and others. In spite of the demands of Station WEAF's microphone, Mr. McNamee still appears as soloist in some of New York's most famous churches. His vocal training and the clarity of enunciation which it has developed stands him in good stead when speaking to his millions of listeners.

#### Knows Sports as Well as Music

His earnest study of music also accounts for his lucid descriptions of classic music such as his extensive and interesting introductions to the Philharmonic concerts, broadcast by WEAF, WCAP and WJAR.

But Mr. McNamee is far more versatile than most men who have attained such a thorough knowledge of music. He is an active follower of sports. It was he who gave those bright word pictures of the last World's Series and the opening game of the present season. His eye is quick enough to follow a rapid fire prize fight, as he demonstrated when handling the Wilson-Greb go. Many important football games have been vividly described by Mr. McNamee.

#### Summarized Coolidge Speech

On the occasion of the broadcasting this spring of the President's annual message

Standing before the microphone is Graham McNamee, whose voice is familiar to thousands of Radiophans throughout the country. During the Republican and Democratic conventions, as well as the two presidential acceptance ceremonies, he was an outstanding figure. He is one of the regular announcers on the staff of A. T. & T. Station WEAF.



to Congress, Graham McNamee performed a feat which won the praise of hundreds of newspaper men. He listened to the President's long address through a loud speaker and immediately upon its conclusion, delivered a clear, concise and well balanced summary of the address for the benefit of his listeners. No copies of the speech were available in advance. McNamee delivered his summary—a ten-minute speech—without opportunity to edit or revise, or to consult the text of the address, in a manner which would do credit to a trained reporter and an experienced political speaker.

Mr. McNamee was born in Washington, D. C., and began his musical studies in Minneapolis. He was only four years old when he sang for the first time and took up the study of the piano at seven. He is a regular member of WEAF's announcing staff and is frequently assigned to important broadcasting events.

## WESTINGHOUSE KYW EXPLAINS 'PICK-UPS'

### HOW MUSIC AND SPEECH IS BROUGHT IN BY WIRE

Thirty Odd Lines Go from Station to Outside Points—Strengthen High or Low Notes

By Walter C. Evans

CHICAGO.—"And now we'll switch you back to the Congress hotel for a half hour's dinner music." Have you ever wondered just what takes place during the two or three second interval while the program is shifted from one location to another?

It is almost disappointingly simple. The thirty odd lines from the different points from which KYW broadcasts are terminated in a telephone switchboard not unlike the one you see every day in your outer office. Both broadcast and talking circuits come through this board and by means of plugs and cords any line, or combination may be connected to the broadcasting set, or to the station operator's telephone.



W. C. EVANS

#### Operator at Each Wire's End

An outside or "pick-up" operator is stationed at the end of each line over which a program is to be transmitted. For him Radio holds no thrill, no mystery. He passed through that stage long ago aboard some ship watching the sun come out of the ocean in the days when Radio was known as wireless.

He checks his watch to the second with the operator in the station, and as the time approaches for his program to begin he adjusts his amplifiers and microphones and notifies the announcer to stand by. The program ended at some other point, the station operator pulls the plug and inserts it in the next line, and tells the new operator he has the circuit. The outside operator tells his announcer to "shoot" and the switch-over has been completed.

#### Speed Needed in Switch-Over

Every effort has been made to reduce the time element in switching from point to point, for at the receiving end a silence of ten seconds will seem like as many minutes. For this reason all schedules must be run on a split second basis and everything must be in hair-trigger readiness.

Six men are employed at pick-ups to maintain and operate the outside pick-ups. All of the equipment is inspected daily, batteries kept in top notch condition and lines tested for noise or "cross talk." Microphones may, in the language of the operators, "go south" over night due to temperature changes, moisture, or mechanical jar. At practically every point duplicate equipment and batteries are installed to insure against interruption of your program.

One of the tricks of the trade in use at KYW permits talk to the outside operator over one line while broadcasting music or speeches over the same line without interference between the two. Not a trace of cross talk can be distinguished between the two channels over the same line.

#### Can Strengthen High and Low Notes

Another development originated at KYW permits the music at outside pick-ups to be actually tuned to balance at the station. If, for example, the high notes from a dance orchestra are predominating, the operator merely adjusts a rotary switch until the lower toned instruments come through with sufficient volume to give the desired quality. If low notes are too loud it can be similarly adjusted to increase the volume of high notes until they balance.

In picking-up programs from more distant points, such as the recent Radio show at Milwaukee, or the University of Illinois football games at Urbana, Ill., the procedure is essentially the same, although repeaters, or boosters are sometimes inserted in the line to keep the volume above a certain predetermined standard.

The Wolff News agency in Berlin has established a regular Radio news service. It operates from 7:30 a. m. to 8:45 p. m.; transmissions beginning at 7:30 a. m., 1 p. m., 1:30 p. m., 6 p. m. and 6:30 p. m., Berlin time. All recent news, local and international, is covered by brief announcements.

## "Cal" and "Fighting Bob" Film Speeches

### Candidates Are Photographed on De Forest Phonofilm

WASHINGTON, D. C.—President Coolidge can no longer be referred to as "Coolidge the Silent." He has just delivered a remarkable speech to the De Forest phonofilm, the Radio talking motion pictures, and action and words, photographed together, will be preserved for posterity—the first talking motion pictures ever made of a president of the United States, or of the head of any other nation, for that matter. Not only will the pictures be placed in a vault at the Smithsonian institution, but they will soon be seen and heard all over the world.

After the President had been photographed, Dr. Lee De Forest and Mr. T. W. Case went to the capitol grounds where, by previous arrangement, they met Senator Robert M. La Follette, who also delivered a speech to the camera. Quite in contrast with the scene at the white house grounds, where no one was allowed while pictures of the President were being made, a great crowd gathered to hear Senator La Follette deliver his speech.

## Coming Attractions from WQJ Will Prove Popular

CHICAGO.—Beginning Friday September 5, Mr. Fred Mann, owner of Station WQJ, will resume his duty of broadcasting to the ladies the Sunday dinner menu and how to prepare it. From all indications, this winter will be great for eating.

The next real "Koffee Klatsch" for the ladies will be held on Saturday September 6, in the Radio room at Rainbo Gardens. Calumet baking powder doughnuts and Rainbo coffee will be served. A surprise program has been arranged by Jerry Sullivan, director of WQJ, which will start at 3:00 p. m.

Harry Geise and his own "How Do You Do" song is making a big hit. Any Radiophan listening in and hearing it can write a letter to Harry, and another new chorus is added.

## WHAD Appoints Operator; Building Larger Station

MILWAUKEE, WIS.—The Rev. John B. Kremer, S. J., regent of the Marquette University College of Engineering and head of the university's department of physics, has announced the appointment of Herbert F. Wareing of this city as operator of Marquette Station WHAD.

Contrary to reports, Station WHAD has not closed for the summer, but no musical programs have been given since the closing of the school year.

While the Marquette 100-watt station continues to take the air, Mr. Wareing and Father Kremer are busy constructing the new Hilltop 500-watt station which will be located in the tower room of the new Marquette administration building.

## AVIATOR'S VOICE REBROADCAST



Radiophans tuning in WJZ on a recent afternoon were undoubtedly surprised to hear the voice of aviators, talking to them as they flew from Mitchell field and circled over New York city. The stunt was relatively simple. WJZ merely picked up the Radiophone in use aboard the plane.

## FLYERS TALK TO WJZ MILE DOWN

Fans Hear Talk Relayed Through R.C.A. Station—WHN Accomplishes Similar Stunt

NEW YORK.—Soaring a mile or more above Central park in a big De Havilland plane, Lieutenants Brandt and Rasch of Mitchell field spoke into the plane's Radio microphone to the Radiophans of New York and elsewhere in range of Station WJZ. For their voices, combined with the whirr of the big Liberty motors, were picked up by the Radio Corporation station, amplified and rebroadcast on the wave of WJZ.

It was the second time that the feat has been done by WJZ. The first time it was done at night. This time the flight took place in the afternoon so that fans only able to tune in during the day might hear the aviators' voices and the roaring Liberty engines as the propellers beat against the air.

N. T. Granlund, announcer and director of Station WHN, Loew's State theater, has also accomplished a similar stunt twice. "NTG," as he is popularly known, flew aloft once in a De Havilland and again in a glant Martin Bomber, and conversed with "Bill" Boettcher, WHN's engineer, to the edification of the Radiophans of the metropolitan area who heard both sides of the conversation.

There are no fewer than twelve American types and sizes of vacuum tubes suitable for use in receiving.



# SENATOR SCHULTZ IS NO SENATOR AT ALL

## J. E. KLEIN REVEALS HIMSELF AT CROSLLEY WLW

### German Comedian Monologist Is Really Business Man Who Just Likes to Radiocast

CINCINNATI.—"Senator Schultz," whose humorous sketches have been broadcast several times in recent month from Crosley Station WLW, has been content to remain incognito. His name has only recently been revealed to the Radio audience. And as the "Senator" has been persuaded to come out of hiding, he's been posed for the cameraman.



SEN. SCHULTZ

Mr. Klein said he got the idea for his German comedian monologues from parties he attended about ten years ago. He worked up several skits. After he was once called upon to "perform" for friends he has been in great demand. He has also appeared before clubs and societies, but has never been on the stage.

The "Senator" was heard recently again from WLW in a Radario, "Business Man Turned Gentleman," planned by Fred Smith, studio director. Mr. Klein's lines, however, were an interpolation of his own ideas.

### No British Jail Radios

LONDON — Following the publicity given the use of receiving sets in a number of American prisons, an inquiry concerning the extension of this practice to English prisons was made in the house of commons. The home secretary has now reported that all of the penitentiary authorities are absolutely opposed to the innovation here.

## Yacht Race Sketched to Listening Public

### Two Stations Radiocast Results of Famous Yearly Race

DETROIT.—For the first time in history the Gold Cup yacht races were reported by Radio direct from a float anchored off the pier of the Detroit Yacht club by two stations, WWJ and a new one installed for the occasion, known as KFTU. This newcomer, KFTU, operated only for the period of the races by George Harrison Phelps. He converted the 100-watt transmitter on board his yacht, Skylark II, into a Radiophone transmitter just for the races. Two 85-foot antenna tower were erected on the float from which the judges presided.

A special license was obtained by Mr. Phelps which permitted him to broadcast the yacht race results.

## University of Pittsburgh Plans New Radio Courses

PITTSBURGH.—With the opening of the University of Pittsburgh this fall, Radiophans will be entertained from time to time by the broadcasting of various courses of instruction by KDKA from the educational studio which was established last March on the college campus.

Two educational series were broadcast during the spring term. A course on Political Parties was broadcast due to the great interest in politics as evidenced in the recent national party conventions, and whenever possible similar courses relating to national affairs will be put on the air.

Outlines and bibliographies for each of the courses to be broadcast will be printed and distributed to those who are interested.

## Newark Philharmonics to Continue Through Summer

NEWARK, N. J.—Encouraged by the wave of popularity which greeted the initial concerts by the Newark Philharmonic band broadcast through WOR direct from Branch Brook Park here, concerts by this famous band of fifty pieces will continue as a regular Monday evening feature during the summer period. Their last concert was sent over the air on last Monday evening under the direction of Carl D. Bethel. In addition to offering an hour's program of band selections, several members of the organization played solo numbers.

A Manufacturers' International Exposition  
Under the Direction of James F. Kerr  
A MAMMOTH SPECTACLE OF SCIENTIFIC ACHIEVEMENT

The FIRST  
**RADIO WORLD'S FAIR**  
*Madison Square Garden*  
**SEPT. 22 to 28** Monday to Sunday Night  
INCLUSIVE  
1 P.M. UNTIL 11 P.M.

Extraordinary Features Daily!

The year's tremendous strides in radio development displayed in 100,000 square feet of exhibits by the foremost manufacturers.

## FIRST TIME IN AMERICA

Representative Displays by Manufacturers of  
**ENGLAND FRANCE BELGIUM**  
**ITALY SWITZERLAND**

## CASH PRIZES and Silver Cups for AMATEUR BUILDERS!

Enter Your Home-Built Set in the Great Contest

Send your name at once for information and entry blanks

Business Office  
Hotel Prince George  
New York City

Direction of  
U. J. Herrmann and  
James F. Kerr



## The GREBE CLARIFIER

THE first practical, workable solution of the problem of radiation from regenerative receivers. Unlike the "wave-trap" it increases signal intensity.

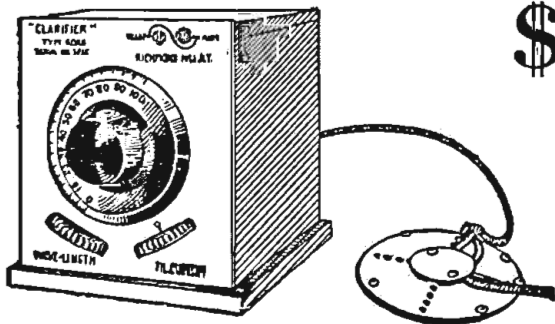

\$30

- Increases Selectivity
- Increases Signal Intensity
- Improves Quality
- Prevents Radiation

And—

Is Easily Connected

Ask your dealer or write for literature

A. H. GREBE & CO., Inc.

Richmond Hill, N. Y.

Western Branch—451 East 3rd St., Los Angeles, Cal.

## NEW MODELS Bristol Radio Receivers

Incorporating the Patented Grimes Inverse Duplex System

— Watch for further announcements in all leading radio publications.

Improved Bristol Audiophone Loud Speakers—gives greater volume, is more sensitive and still maintains its round, full tone and its distinctive freedom from distortion.

Ask for Bulletin No. AY-3017

Manufactured by  
**THE BRISTOL COMPANY**  
Waterbury, Connecticut

GRIMES SYSTEM INSURES NATURAL TONE QUALITY

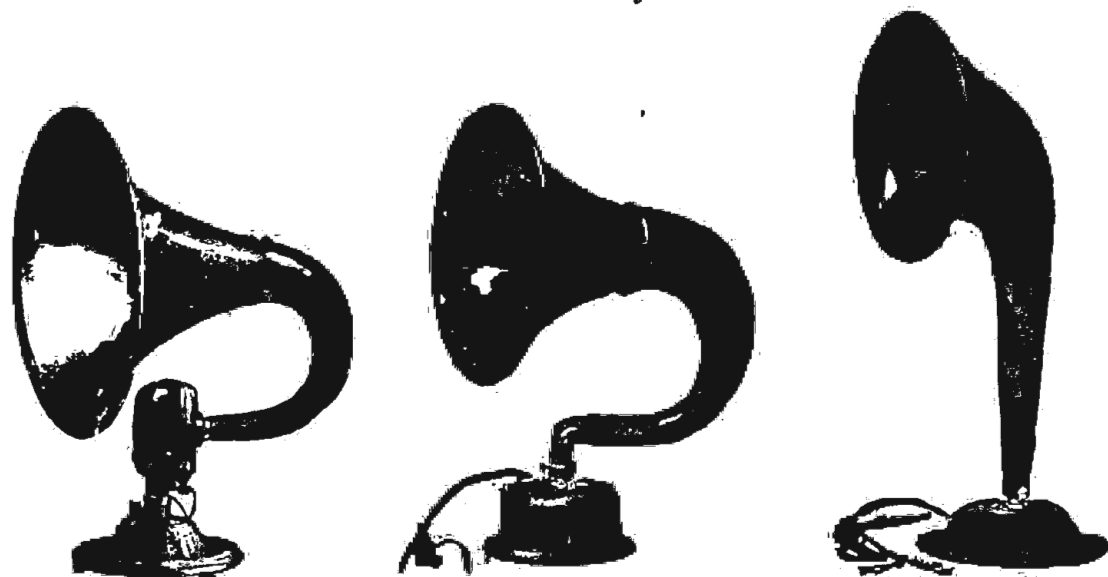

Senior Audiophone  
15-inch Bell

Junior Audiophone  
11-inch Bell

Baby Audiophone  
With Fibre Horn

Price.....\$30.00

Price.....\$22.50

Price.....\$12.50



# OPERATING AND TROUBLE SHOOTING

## For the Owner of a "Microdyne" Receiver

**O**PERATING and Trouble Shooting" is a Radio Digest feature whose purpose is to study the late models of various standard receiving sets and to show the newly initiated Radiocast listener, who has purchased such a set, how he can operate it to get the best there is in it and how he can overcome minor difficulties which may be causing some trouble. On pages 9 and 10 this week the Microdyne Receiver is described. Radiophans with other sets will also find these articles worth while reading, particularly the notes on trouble finding.

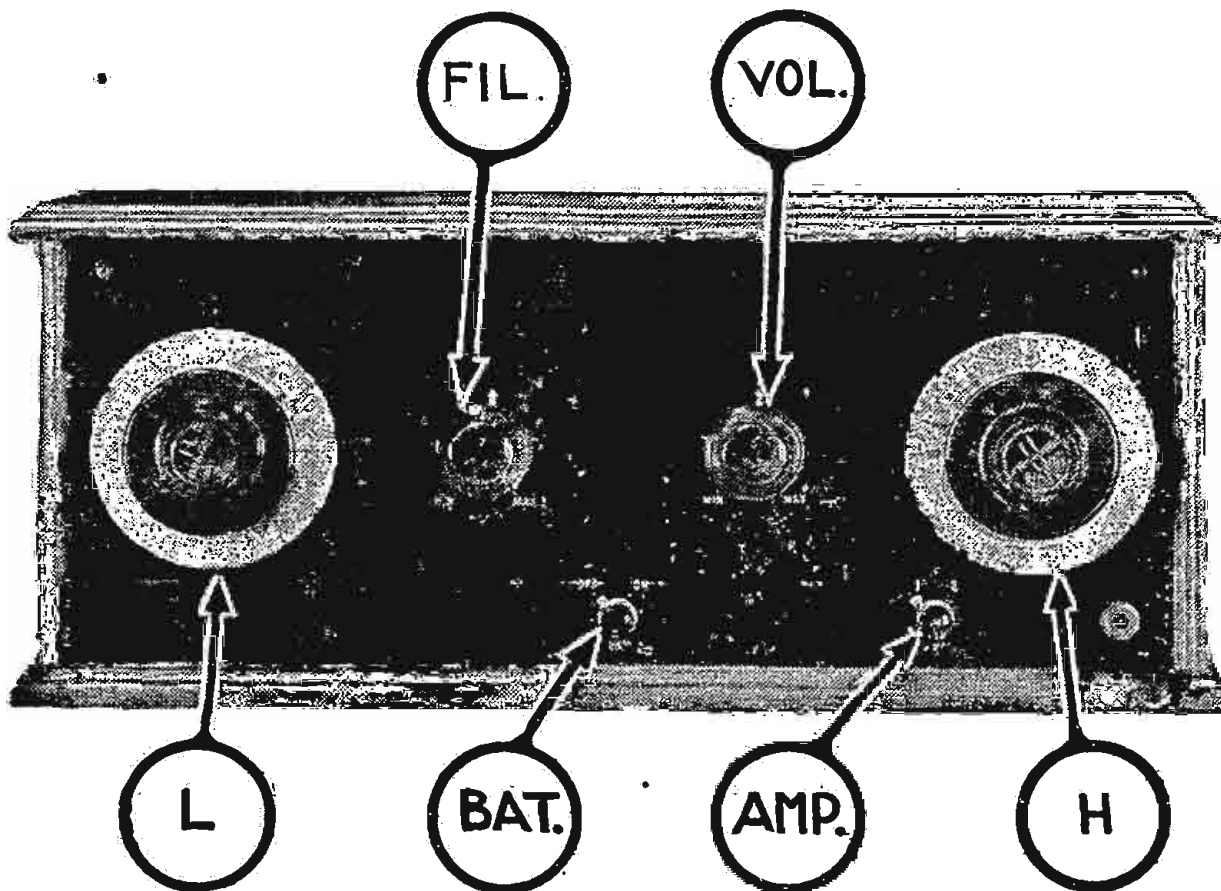

not permit the operation of seven UV-199 tubes on a 3-cell, 6-volt battery.

### Making Battery Connections

Enter plug on end of battery cable thru hole in rear of cabinet, and plug same into receptacle in rear center of base panel. Note that this plug will enter only one way, and key should be lined up to enter freely. If plug does not enter freely, squeeze together the pairs of small brass prongs within the end of plug. This may be done with the fingers or small pliers.

Now turn the rheostat marked "BAT" toward "MAX" and see that the tubes light properly. Note that the filament of the third tube from the left is controlled from the knob marked "VOL" and the brilliancy of this tube's filament is therefore dependent on position of volume control. Latter should be moved up and down to make sure the brilliancy varies accordingly, which will insure the correct operation of the volume control. It will be found that the volume control is

of little value with the 199 type of tubes, but the loss of volume is so great with such tubes that the volume control becomes unnecessary.

Next connect the "B" batteries, which may be either of the dry or storage type, according to the markers on the free end of battery cable. Connect the yellow wire to the negative terminal of battery, the blue wire to the 45-volt tap, and the pink wire to the 90-volt tap.

Do not use more than 90 volts on this receiver. Use of greater voltage will only cause distortion, and will not increase the volume materially.

Plug loud speaker into jack at lower right corner of panel. A loud click should be heard as plug enters or leaves this jack, if the "A" and "B" batteries are properly connected. Have the "BAT" and "VOL" knobs turned to "MAX" and battery switch on "ON" position to make this check test.

When battery connections have been

made and checked, they need never be changed or disturbed during the operation of the receiver, as the battery switch in the panel breaks both battery circuits; if set has to be moved from place to place, remove plug from set without disconnection from batteries. You cannot easily short circuit your batteries, on account of the deep recessing of end of plug.

Connect the two free ends of the loop connecting wires to your loop; if loop is of the helical or "box" type, connect one wire to each terminal, without regard for polarity; if loop is of the spiral or "pancake" type, connect the wire carrying the brown marker on plug to the outside end of the loop winding. A casual inspection of the loop will determine which of its binding posts is connected to its outside turn.

### Testing for Best Tube Position

Due to the extreme variation in present-day tubes of standard manufacture, it is often necessary to change the tubes, from socket to socket, until best signals are obtained. Many tubes which operate perfectly in the detector and audio frequency stages will not function well in the Radio frequency stages. Some little time spent in the finding of the best operating position of your tubes will be well repaid with increased volume on long distance signals.

It will be found that some 201-A tubes have a filament of peculiar characteristic making them unsuitable for operation in the volume control stage. If your third tube (from left) does not turn down quickly with the movement of the "VOL" knob, and signal strength does not diminish properly, exchange this tube with one of the others, until proper regulation is secured.

As a last resort, the blue tap on the battery cable, which is ordinarily on the 45-volt tap of battery, may be moved to supply greater or lower voltage than 45 volts; it is sometimes found that some 201-A tubes operate best as detectors with 25 to 30 volts of "B" battery. Such test should be made on a reasonably long distance signal, as results are extremely deceptive when testing on local signals.

Do not attempt to use tubes of different types in this receiver at one time, as circuits are not arranged to permit same. If any other types than 201-A or 199 are

(Continued on page 10)

**I**N SETTING up receiver for operation, examine receiver to make sure that the "C" battery and grid leak are in place, battery switch turned to the "OFF" position, and battery rheostat turned to "MIN" position. Place seven tubes, either UV-201A or UV-199 with adapters in sockets, turning each tube until securely locked in bayonet joint. Connect free end of battery cable with "A" or filament battery, placing red lead on the positive terminal of battery and green lead on the negative terminal.

**Caution** — For 201A tubes, battery should be 3-cell, 6-volt storage battery of not less than 50 ampere hours capacity. For 199 tubes, battery should be 2-cell, 4 volts, or connection should be made to one of the connecting straps on a 6-volt battery so that only two of the cells are used. The rheostat on the receiver will

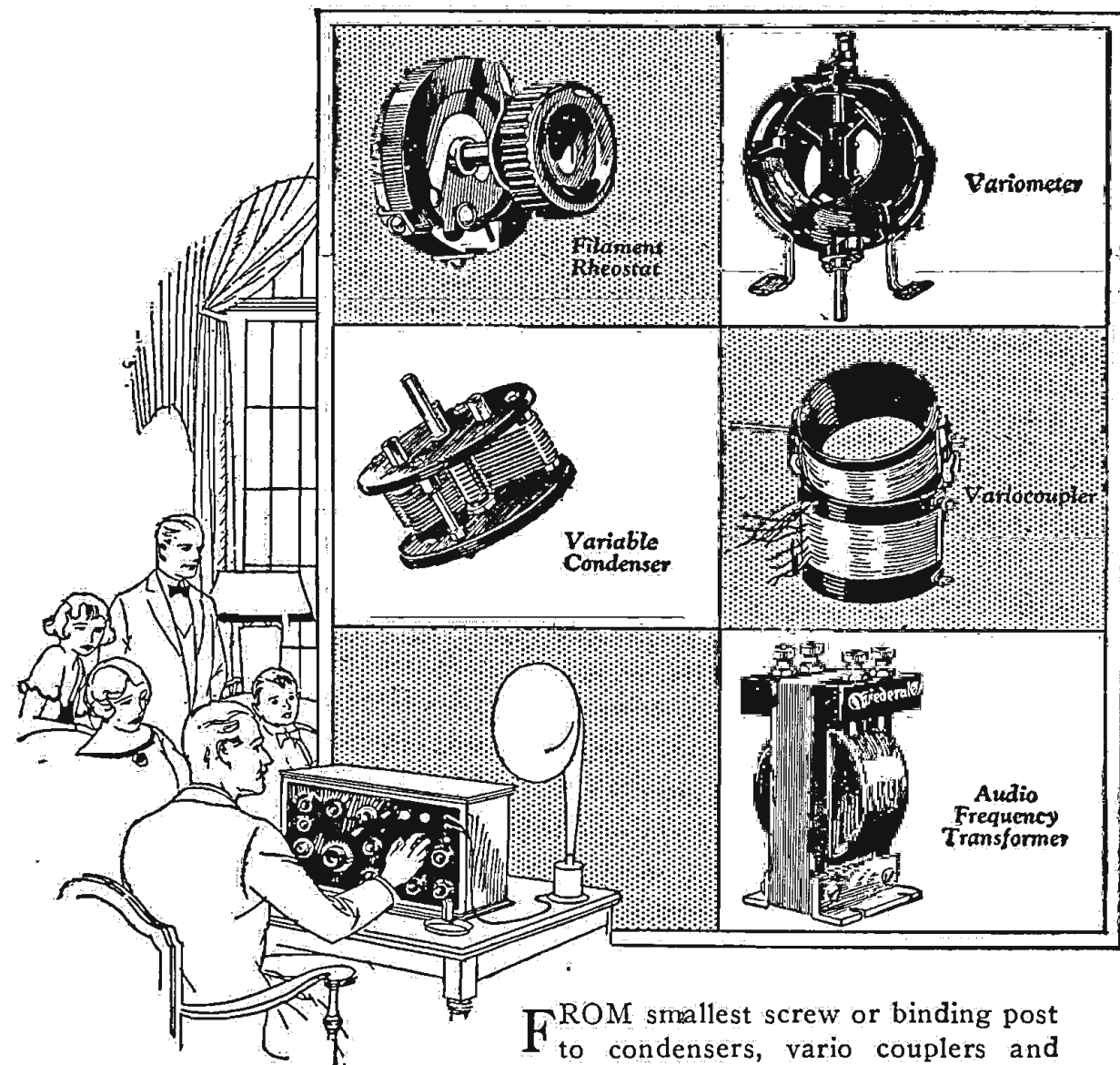

FROM smallest screw or binding post to condensers, vario couplers and transformers, each of the 130 Federal Standard Radio Parts are made to give maximum service and are backed by the iron-clad Federal performance guarantee.

Federal Telephone & Telegraph Co.  
Buffalo, N. Y.

When assembling your set, insist that each part be of Federal manufacture.



# Federal

Standard RADIO Products

Boston New York Philadelphia Pittsburgh Chicago San Francisco Bridgeburg, Can.

# BUWELL

## RADIO APPARATUS

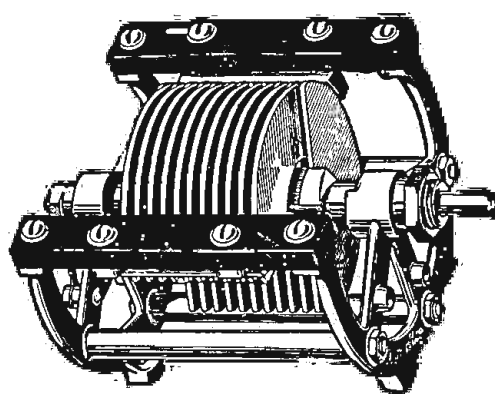

**T**HE Flewelling Condenser brought out a year ago is one of the first deserving of the name "Low Loss!" It has all the desirable electrical characteristics that insure holding the signal brought in by your antenna at its greatest strength. It gives your set selectivity. It is the heart of your set and the one place where it does not pay to economize.

This condenser has features that are being widely copied. Its heavy 1/16-inch aluminum plates will not warp. The quality of the workmanship is above usual standards. It is a piece of Radio apparatus you will be glad to own. Ideal for Super Heterodyne or other circuit.

"Hook up with Flewelling and you will have good Radio."

23 Plate .0005 Mfd., \$7.00, Vernier included  
11 Plate .00025 Mfd., \$6.00, Vernier included  
Flewelling Low Loss Tuner, \$7.25  
Flewelling Sockets, 75c

# BUWELL MANUFACTURING CO.

2977 Cottage Grove Ave., Chicago, Ill.

Write for circular on our entire line



AN EVENING AT HOME WITH THE LISTENER IN (SEE INSTRUCTIONS FOR USE BELOW)

Table with columns: Station and City, Met., Monday, Tuesday, Wednesday, Thursday, Friday, Saturday, Sunday. Lists radio stations and their broadcast times.

Instructions for Use.—All the hours above are given in Central Standard Time. If your city uses Eastern Time, add one hour to each of the periods stated; if your city uses Mountain Time, subtract one hour; if your city uses Pacific Time, subtract two hours. If in addition, your city uses daylight saving time, add one hour to this result. This table includes only the evening Radiocasts, and, on Sunday, the late afternoon program.

OPERATION TROUBLES

(Continued from page 9)

used, be sure that the seven are all of the same type, and that the "A" and "B" and "C" voltages are adjusted to meet the requirements of the tubes, as stated by the manufacturer.

Tuning In and Logging of Stations

In tuning any receiver of this type, the adjustments of the two dials are at all times dependent on one another. At the same time, it is not possible to provide that the settings on the two dials shall be alike for any given station, although they are nearly alike on many stations.

The dial marked "L" controls the loop wave length, and its settings will change with different loops. A slight change will be noted even when the length of the loop connecting wires are changed.

The dial marked "H" controls the wave length oscillator or "local heterodyne," and it is inherent in the principle of operation of the receiver that this dial "H" should have at least two settings for each station. These two settings on any one station will be comparatively far apart on the high wave length and extremely close together on the shortest of wave lengths.

The volume on the two settings may or may not be the same, so that in all logging of stations, both settings should be found, if possible, and logged. Many times the second setting is never found on distant stations, but can always be found on local or otherwise powerful stations.

The logging of both settings is of the greatest value in cutting out local interference, due to the fact that the interfering station's two settings will not correspond with both settings of the desired station, unless they are on the same wave length. In this case, rotation of the loop may cut out the interfering station.

It is necessary to tune a receiver of this type with great care, as the sensitivity and selectivity are exceedingly great. On clear winter nights, with reception possible from almost every one of the hundreds of stations in the country, stations

may be separated entirely and brought up to loud speaker volume by the adjustment of either dial by not more than the width of the black graduation lines. This means that as many as five stations on wave lengths very near together may be completely tuned in or out with a dial movement not exceeding one scale division.

Only by close tuning with the vernier knobs, and by the exercise of patience, can you secure the best which is obtainable from a super-sensitive receiver of this type.

Maintain your adjustment of knob "FIL" as far from the "MAX" end as is consistent with no loss of signal; this operating adjustment depends upon the state of charge of your "A" or storage battery. 201-A tubes become noisy if filaments are turned up beyond the point where signal strength does not increase.

The switch marked "AMP," 1 and 2, changes the loud speaker connection from 1 stage of audio frequency to 2 stages, and should be used when a major change of volume is desired. The "VOL" knob will supply the necessary gradual changes for both positions of switch "AMP."

Care and Maintenance

Your "C" battery, which is mounted underneath the base panel, will require renewal from time to time, usually about once a season, although the shelf life of many makes of this small battery is so short as to require more frequent replacement. This battery may be removed easily by standing set up on one end, loosening the two clamp screws with a screw driver and pulling battery out. Note that the battery will make a contact with the two studs only when replaced in the correct manner. Be sure that you bend out the springs on battery so that good firm contact is secured to the studs.

If the vernier dials on your receiver become noisy or squeaky, remove them from shaft and put one drop of oil on the cork backing. Remember—if you do not put them back as they came off, your log of settings no longer holds true.

The Radio Shack's Great "Let-Go" Sale

This is absolutely and without question the greatest money saving event in the Radio field this year. Never in all our experience have we ever approached such astonishing values as the Radio Shack offers now in this August "Let-Go" Sale. If every one realized the absolute values of this merchandise this sale would last but a few hours. It is only through the extraordinary buying power—and knowledge where to buy—that the Radio Shack makes it possible to obtain such exceptionally fine Radio goods—values that can not be duplicated. Send your orders in at once. Send no money, but be sure to write your name and address plainly and be sure to specify just what article or articles you want. No order for less than one dollar sent C. O. D. Get in on this great "Let-Go" Sale.

MISCELLANEOUS

- Clapp-Eastman Variable Couplers \$ .85
Hydrometers .38
Approved Lightning Arresters, outdoor \$ .75
Magnus Sockets \$ .34
Pacnet Plugs 1.25
Comsco Plugs, sgl. 1.00
Comsco Plugs, dbl. 1.50
Rico Tunable Head Sets, 3,000 ohms 3.15
1 MFD Condensers for Super-Het. 1.35
Federal Dials, 3 and 4 inch, 50% off.
Double Phonograph Attachments 1.00
Ribbon Antenna Wire 1/2c per ft.
Variable grid leak and mica condenser .75
Lead-in wire, No. 14, rubber covered, 50 ft. roll. 1.00
Moulded Insulators .15
Approved Lightning arresters 1.00
Adjustable loud speaker units, large diaphragm 5.00
Adjustable Phonograph attachments makes every phonograph a loud speaker 5.00
Westinghouse-Baldwin Phonograph attachment 18.00
Flat Plugs 1.50
Double Phone plugs 1.50
Vernier Controls .50
Amplex Grids for Cockaday circuit 1.25
Hydrometers 1.00
Remer Rheostats .75
Marvel potentiometers, 400 ohm. 1.00
23 plate R. V. G. Metal end Condensers at 65c ea.
Cockaday Coils 5.00

Standard 3 Circuit Kit

ONLY \$11.19

SEND NO MONEY

The Radio Shack has hit another home run! This time a most fortunate purchase from a big manufacturer who had to have money to weather the storm of poor business during the slack summer months. The Radio Shack took his stock and are passing along the savings to you. You can take these parts and make up a set that is good for distance and wonderful for interference. You can get clear tones within 1,000 miles under average conditions—and look at the price again.

- 1 Drilled Panel \$1.50
2 High grade 43 plate condensers 8.00
1 Triple mounted honeycomb coil mount 4.00
3 Honeycomb coils mounted 3.75
1 Moulded Socket .50
1 6 ohm Rheostat .50
1 Mica grid Condenser and grid Leak .50
10 feet Tin bus-bar .10
8 Binding posts .24
1 Diagram and Instructions .35

Total list price \$19.44
Our Amazing Low Price \$11.19
Only \$11.19
Inside coil mount furnished for \$1.00 extra.

MICA FIXED CONDENSERS

- These mica fixed condensers—
Guaranteed
Capacity List Price Our Price
.01 \$ .75 \$ .45
.02 .35 .24
.0025 .25 .18
.0005 .25 .18
.00015 .25 .18

CONDENSERS

A large quantity of genuine moulded end plate condensers. At these prices they will go fast. If you intend to build a set at any time, get a few of these condensers at less than half price.

- 11 plate \$1.25
11 plate vernier \$1.60
17 plate 2.25
23 plate 2.50
23 plate vernier 4.50
43 plate 3.35
43 plate vernier 5.50

- 11 plate, with dial and knob \$2.50
11 plate vernier, with dial and knob 4.00
43 plate condenser with dial and knob 3.50

- 11 plate \$1.75
18 plate (vernier) 3.50
43 plate plain 2.75
43 plate vernier 5.50

Premier condensers need no introduction to the radio public. Constructed of the best materials by one of the foremost radio manufacturers in the United States, it is an instrument you will be proud to own. Worth every bit of the list price. A marvelous bargain at one-half price.

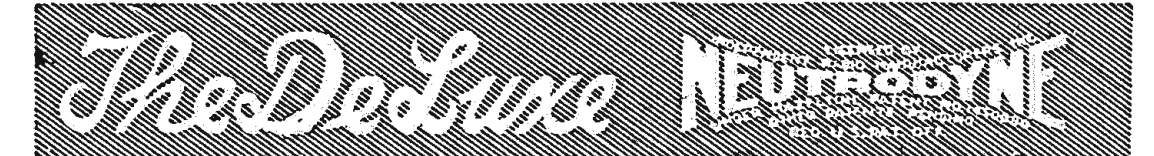

- SET CONSISTS OF Complete Building Kit \$34.49 C. O. D.
1 Drilled Mahogany Panel, polished mahogany effect, engraved in gold.
3 Four-inch Mahogany Dials, gold engraved.
2 Gold Plated Jacks.
3 Genuine Hazeltine Neutrodyne transformers mounted on the famous Comsco-Bakelite End Condensers. Positively the only Neutrodyne Kit including them.
2 Hazeltine Neutrodons.
5 Heavy Bakelite Sockets.
1 6-Ohm Rheostat with gold plated knob to match panel.
1 30-ohm Rheostat with gold plated knob to match panel.
2 Genuine Killark Completely Shielded Audio Transformers.
1 Baseboard.
20 Feet Tinned Bus-bar.
1 .00025 Freshman Grid Condenser.
1 Tubular Glass Grid Leak.
1 Set Engraved Binding Posts.
1 .002 Micon Condenser.
1 .006 Micon Condenser.
Exact size special blue print and instructions.
All packed in attractive box.

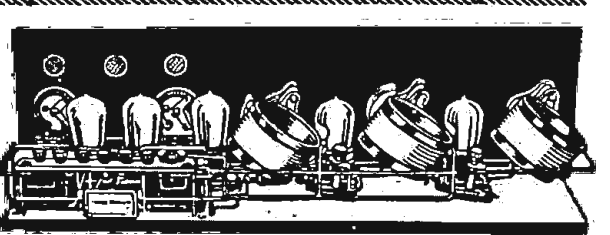

OPERATING OUTFIT

- 5 Tested Tubes (Type 201A) \$19.50
2 45-Volt Extra Large Variable "B" Batteries for Neutrodyne 6.50
1 60-Ampere Hour Storage Battery, guaranteed 2 yrs. 11.25
1 pr. 3000-ohm Head Phones and Cord 3.75
1 Phone Plug, double .90
1 Antenna Equipment 1.50
Complete Accessory Outfit, \$43.40, C.O.D. (Parts Also Sold Separately)

If you order Building Kit and Operating Outfit both together, we will include Fine Mahogany Finish CABINET FREE.

The RADIO-SHACK Send No Money

Executive Offices, Dept. RD96
55 VESEY ST., NEW YORK CITY
Goods shipped C.O.D.
Just pay the postman
EVERY ARTICLE SOLD ON WRITTEN MONEY-BACK GUARANTEE
We ship C. O. D. When shipment arrives pay your postman. Then enjoy your purchase under our WRITTEN MONEY-BACK GUARANTEE. Remember, you buy SAFELY from The Radio Shack, the Largest Radio Dealers in America—built upon Quality, Service, Value and the Universal Respect and Confidence of the radio public.



# ERNIE YOUNG AT KYW WEDNESDAY

## Wednesday, September 3

CHYC, Montreal, Can. (Eastern, 341), 10 p. m., orchestra.

CKAC, Montreal, Can. (Eastern, Daylight, 425), 1:45 p. m., Mount Royal hotel luncheon concert.

KFI, Los Angeles, Calif. (Pacific, 469), 6:45-7:30 p. m., vocal concert; 7:30-8, Wendell Hall; 8-9, Evening Herald—Santa Ana night; 9-10, studio program; 10-11, orchestra; 11-12, Ambassador Hotel Cocoonut Grove orchestra.

KFNF, Shenandoah, Ia. (Central, 266), 7:30 p. m., concert by Benedict Plano end Radio company.

KFOA, Seattle, Wash. (Pacific, 455), 8:30 p. m., musical program.

KFSG, Los Angeles, Calif. (Pacific, 278), 2:30-4:30 p. m., divine healing service, Almee Sempke McPherson; 6:30-7:30, Gray studio program.

KGW, Portland, Ore. (Pacific, 492), 8 p. m., concert by May Dearborn Schwab, soprano; 10, dance music by George Olsen's Metropolitan orchestra, Hotel Portland.

KHJ, Los Angeles, Calif. (Pacific, 395), 12:30-1:15 p. m., concert, Oaks Tavern orchestra; Fred C. McNabb, speaker; 6-6:30, Art Hickman's concert orchestra, Edward Fitzpatrick, director; 6:30-7:30, children's hour, "American History," Prof. Walter Sylvester Hertzog; Baby Muriel McCormac, screen juvenile; 8-9:30, concert, courtesy, Platt Music Co.; 9:30-10, Dr. Mats E. Baumgardt, George Hood, reader; 10-11, Art Hickman's dance orchestra.

KLX, Oakland, Calif. (Pacific, 599), 8-10:30 p. m., studio program, vocal selections, orchestra; instrumental selections; Sunset quartet; Irwin Johnson, baritone.

KPD, San Francisco, Calif. (Pacific, 423), 1-2 p. m., Rudy Seiger's Fairmont hotel orchestra; 2:30-3:30, Cabrera cafe orchestra; 4:30-5:30, Fairmont hotel orchestra; 5:30-6:30, children's hour; 7-7:30, Rudy Seiger's orchestra; 8-11, E. Max Bradfield's Versatile band.

KQV, Pittsburgh, Pa. (Eastern, Daylight, 270), 10-11 a. m., music; 3-3:30 p. m., music; 8-9, popular song revue presented by Ben and Thelma Fields, Pittsburgh entertainers, featuring "Put Away a Little Ray of Golden Sunshine," "Jealous, Louise," "From One Till Two," "I've Got a Feeling for Ophelia," "Please Whisper to the Rose"; 9-10, musical program presented by the Music Box sextette, dance orchestra of Pittsburgh, playing all the late and popular hits. Soloist and special entertainer for this program will be Fred Hughes.

KSD, St. Louis, Mo. (Central, 546), 8 p. m., Silverman's orchestra concert broadcast direct from Lyrle Skydome.

KYW, Chicago, Ill. (Central, Daylight, 536), 6:45 p. m.,

## Headliners of the Week

ARE you interested in Radio plays? If you are, tune in WJZ Wednesday night and you will hear a thriller. It was written by Arthur B. Reeve just for Radio and is to be broadcast in two parts. Next week the final installment will be broadcast. The story is full of adventure and is called "By the Breadth of a Hair." Station WJAR will broadcast a special beauty pageant program from their Atlantic City studio. Why pay for a show when you can listen in on this?

Melody and fun give sorrow a long run, every Thursday night at WLW when the program mixes up the Doherty Melody Boys and a wonderful trio from the Milnor Electric Instrument company. Rural listeners are invited to tune in WEAO and listen to a discussion of "Soy Beans," by Professor G. W. McCuen, of the Ohio State university.

Selections from the opera "The Prince of Mah Jong" will be given by composer, Fraser Allan, and his own company. This should be good—tune in on CNRT to hear it Friday night. The far famed "Hoot Owls," will do their stuff from Station KGW the same night. Both of these stations are putting on a good show.

If there is a beauty in your home town who is entered in the pageant at Atlantic City, tune in WIP at 10:30 p. m. Saturday, and learn if she has

won the coveted honor. At midnight, Eastern time, WJAX will take a trip around the world with a carrier wave as a boat. The "Nite Caps on Lake Erie" claim that this will be the best that they ever produced.

On Sunday if you cannot go to church, tune in KFNF and listen to their sacred song service. This is quite a feature with this station and makes a hit with all the listeners. The same day, but many miles distant, WEBB will give their concert selections by the Edgewater Beach Oriole orchestra.

Here's your chance to learn how to swim and yet not go near the water. Monday night, Frank J. Dalton, noted swimming instructor, will give the land sharks a few lessons in the life of our "hunny" friends. This will be at WOR, so tune in on it. A musical program is scheduled for Station WHO. If you like singing, listen to this as they will have everything from a tenor to a deep bass.

A good seat at a vaudeville show merely by dialing WHN on Tuesday night. The entire overture and show from Lowe's State theater will be broadcast. If you want to hear some wonderful harmony, listen to WQJ, and hear the Cambridge Sisters. These artists always give the Radiophans the best that there is. Time spent listening to them is well invested.

WLS, Chicago, Ill. (Central, Daylight, 345), 6:30 p. m., Ralph Emerson at the Barton organ; 6:50, Ralph Emerson at the Barton organ; 7:05, Isham Jones' Hotel Sherman College Inn orchestra; 7:20, The Harmony Girls; 7:35, Isham Jones; 7:45, lullaby time; 9-10, farm program; 10, orchestra; 10:15, poem period; 10:30, Isham Jones' orchestra; 10:40, Glenn Rowell and Ford Rush time.

WLW, Cincinnati, Ohio (Central, Daylight, 423), 4 p. m., program for the "Shut Ins," by the Dunning Benevolent and Musical service; 8, the Virginia entertainers, popular music; Jack Bauer, violinist and director; Dick Rye, saxophonist; O. V. Speybrook, saxophonist; Fred Brill, trumpet; A. E. Spelner, saxophonist and manager; Perry Betchel, banjo and vocalist; V. A. Johnston, pianist and arranger; A. F. Joseph, drums and effect; 9, special Cincinnati Conservatory of Music, Radio Scholarship Contest; numbers on which contestants will be examined will be complete on this program; 9:30, a "real" old fiddler, Ed. Haley; Mrs. Ed. Haley, accompanist; 9:45, original compositions, H. H. Walker.

WMAQ, Chicago, Ill. (Central, Daylight, 447.5), 4:30 p. m., musical program; 6, Chicago theater organ; 6:30, stories for children; 9, telk; 9:15, to be announced.

WMH, Cincinnati, Ohio (Central, Daylight, 309), 8 p. m., piano solos and duets, Eileen Roskopf, Damon Poppmann; 8:30, violin solos, Louis Ehrigott, Kurt Henkle, accompanist; popular songs, Gussie Bishop, soprano, Ethel Fahnle, accompanist; 9, talk, "Bits of Cincinnati History"; 9:20, southern songs, ukulele accompaniment, Addy Britt, Dick Finch; 9:30, Jimmie Dearing's Rainnow orchestra, Joe Rengzhausen, director.

WOC, Davenport, Ia. (Central, 484), 8 p. m., organ recital; Peter MacArthur, baritone; Erwin Swindell, pianist.

WOO, Philadelphia, Pa. (Eastern, Daylight, 509), 11 a. m., organ recital, Mary E. Vogt; 12:02 p. m., Wannamaker crystal tea room orchestra, Robert E. Golden, director; 4:45, organ recital, Mary E. Vogt; 7:30, A. Candelori and his Hotel Adelphi concert orchestra; 8:30, Harriet G. Ridley, pianist; 9, WOO orchestra, Robert E. Golden, director; 10, A. Candelori and his Roof Garden orchestra from Hotel Adelphi.

WOR, Newark, N. J. (Eastern, Daylight, 405), 6:15 p. m., Sammy Halpern and his orchestra; 6:55, Jolly Bill Steinke in resume of day's sports; 8-8:15, Gene Ingraham and his orchestra; 9:15, bass horn and bass vocal solos by Frank Fowler; 9:30, recital by Marie Langdon Andrews, soprano; 9:45, George Washington orchestra; 10:15, solos; 10:30, recital; 10:45, George Washington orchestra.

WOS, Jefferson City, Mo. (Central, 440.9), 8 p. m., address; 8:20, old time barn dance, program played by Bill Caton and Ola Cathright, negro fiddlers of Tebbetts, Missouri.

WQJ, Chicago, Ill. (Central, Daylight, 448), 3-4 p. m., talks; 7-8, dinner concert; musical readings, songs, pianist; 10-2 a. m., Ralph Williams and his dance



Ernie Young (center) and two of his famous beauties who will appear at Westinghouse Station KYW, Chicago, Wednesday night, September 3. At the left is Marian Carle and at the right, Marian Morgan.

children's bedtime story; 7-7:30, dinner concert; 7:30-8, program; 8-8:58, musical program; 9:05, good roads talk; 9:15, talk; 9:45-12:30 a. m., midnight revue.

PWX, Havana, Cuba (Eastern, 400), 8:30 p. m., band concert.

WBBR, New York City, N. Y. (Eastern, Daylight, 273), 8 p. m., vocal selections; 8:15, bible lecture; 8:45, vocal selections.

WBAV, Columbus, Ohio (Eastern, 423), 12 m., Ila Lorch Owens, pianist.

WBZ, Springfield, Mass. (Eastern, Daylight, 337), 6 p. m., dinner concert; 7:20, talk; 7:30, bedtime story; 7:40, concert by the WBZ trio; 9, concert by the McDowell Concert company; 11:30, Leo Reisman and his Hotel Brunswick orchestra, songs by Bill Coty and Jack Armstrong.

WCAE, Pittsburgh, Pa. (Eastern, Daylight, 462), 3 p. m., piano recital; 6:30, dinner concert; 7:30, The Sunshine Girl; 9:30, musical program.

WCX, Detroit, Mich. (Eastern, 517), 4:15 p. m., musical program; 6, dinner concert; 8:30, musical program.

WDAF, Kansas City, Mo. (Central, 411), 3:30-4:30 p. m., the Star's Radio trio; 6-7, School of the Air, piano tuning in number on the Dno-Art; address, speaker from the West Council of Greater Kansas City; weekly health talk, auspices, Health Conservation association; the Tell-Me-a-Story Lady; music, Carl Nordberg's Plantation players, Hotel Muehlebach; 8-9:30, program arranged and presented by Mrs. Aubre Waller Cooke, pianist; 11:45-1 a. m., Nighthawk frolic, the "Merry Old Chief" and the Plantation players, Hotel Muehlebach.

WDAR, Philadelphia, Pa. (Eastern, Daylight, 395), 11:45 a. m., daily almanac; 12:02 p. m., Stunley theater organ recital; 12:30, Rev. E. B. Shaw; 12:45, Arcadia cafe concert orchestra; 2, Arcadia cafe concert orchestra; talk, "Care of Children," Mrs. Louis Love; Edna Flinstone, pianist; 7:30, Dream Daddy's bedtime stories; 8, talk, Arnold Abbott; 10, Arcadia cafe dance orchestra; Atlantic City beauty pageant.

WEAF, New York City (Eastern, Daylight, 492), 11-12 a. m., pianist; 4-5 p. m., instrumental trio; 6-10, dinner concert.

WEAD, Columbus, Ohio (Eastern, 360), 1:30 p. m., educational lecture, member Ohio State university faculty; 4, farm talk, faculty member; music, university artists.

WEBB, Chicago, Ill. (Central, Daylight, 370), 7:30-8:30 p. m., Bernice Camerer Pollis, soprano; concert selections, Edgewater Beach Oriole orchestra; 9:30-10:30, Marie Kelly, reader; Langdon brothers, Hawaiian steel

guitars; dance selections, Edgewater Beach Oriole orchestra.

WFI, Philadelphia, Pa. (Eastern, Daylight, 395), 1 p. m., Meyer Davis Bellevue Stratford concert orchestra; 3, report closing prices Chicago grain market; 3:30, Loretta Kerk, pianist; 6, Sunny Jim, the kiddies' pal; 6:20, Meyer Davis Bellevue Stratford concert orchestra.

WGAQ, Shreveport, La. (Central, 252), 8-9 p. m., musical programs; 10-12, dance music, Ramblers Hotel Youree orchestra.

WGN, Chicago, Ill. Central, Daylight, 370), 6:30-7:30 p. m., Drake concert ensemble and Blackstone string quintette; 8:30-9:30, James Todd, tenor; Dortha Decker, soprano; 10:30-11:30, Dixie stars, Bert Davis, Jack Chapman's orchestra.

WGR, Buffalo, N. Y. (Eastern, Daylight, 319), 12:30-1 p. m., George Albert Bouchard, organist; 6:30-7:30, dinner music; 9-11, concert, Paramount orchestra and assisting artists; 11:30, supper-dance music, Vincent Lopez' Hotel Statler dance orchestra, Harold Gleser, director.

WGY, Schenectady, N. Y. (Eastern, Standard, 380), 5:30 p. m., adventure story.

WHB, Kansas City, Mo. (Central, 411), 7-8 p. m., pro-

gram, given by the Missouri Parent-Teachers' association, directed by Mrs. Roy Graham.

WHN, New York City (Eastern, Daylight, 360), 2:15 p. m., Al Hart & Co.; 2:30, Harry Hock and entertainers; 2:45, Louisiana five; 3:45, baritone; 4, soprano; 4:15, tenor and pianist; 4:45, readings; 5-5:30, Izzy Meyers' orchestra; 6:30, dinner concert; 7:30, orchestra; 8, soprano; 8:45, tenor; 9-11, dance orchestra.

WHO, Des Moines, Ia. (Central, 526), 7:30-9 p. m., dance program, given by the Bankers Life Radio orchestra, W. L. Marsh and Stewart Dulaney, directors.

WIP, Philadelphia, Pa. (Eastern, Daylight, 509), 10 a. m., seashore gossip; 10:10, Bernarr MacFadden's health talk; 3 p. m., "What the wild waves are saying"; 3:05, Atlantic City pageant talk; 3:30, Comford's philharmonic orchestra; Bessie Crown, soprano; Dell Angelo, trumpeter; 4, Bob Leman's dance orchestra; 6:05, Eddie Ekins dance orchestra; 7, Uncle Wip's bedtime stories.

WJZ, New York City (Eastern, Daylight, 455), 1 p. m., Hotel Astor trio; 7, cafe Boulevard ensemble; 8:15, piano; 10:30, Greenwale Village Inn orchestra.

WKAQ, San Juan, Porto Rico (Central, 360), 8-10 p. m., band.

orchestra; tenor, harmony singers; Themy Georgi, operatic tenor.

WRC, Washington, D. C. (Eastern, Daylight, 469), 3:10 p. m., song recital; 3:45, piano recital; 4, song recital; 6, children stories.

WTAM, Cleveland, Ohio (Eastern, 390), 8 p. m., concert arranged by the Cleveland Plain Dealer; Maurice Spitalny's Hotel Statler orchestra, 2nd series light opera numbers; Cleveland Plain Dealer quartette; soloists.

WTAY, Oak Park, Ill. (Central, Daylight, 283), 6:45-7:45 p. m., musical program; 9-11:15, orchestra.

WWJ, Detroit, Mich. (Eastern, 580), 12 m., the Detroit News orchestra; 7 p. m., the Detroit News orchestra, Helen Vahl, soprano.

## Thursday, September 4

CKAC, Montreal, Can. (Eastern, Daylight, 425), 9 p. m., concert.

KFI, Los Angeles, Calif. (Pacific, 469), 6:45-8 p. m., Y. M. C. A. lecture and Wendell Hall; 8-9, Ambassador Hotel Cocoonut Grove orchestra; 9-10, studio program; 10-11, instrumental program by trio.

KFKX, Hasting, Neb. (Central, 341), 9:30-11 p. m., studio program.

KFNF, Shenandoah, Ia. (Central, 266), 7:30 p. m., concert by Clarinda Jubilee singers, Mrs. Joe Jones, director.

KFSG, Los Angeles, Calif. (Pacific, 278), 3:30-4:30 p. m., organ recital, courtesy, R. Earnest Ballard; 7:30-9:15, auditorium service; water baptism and sermon, Almee Sempke McPherson; 9:15-10, Gray studio concert, the silver band; 10-11, organ recital, courtesy, Esther Fricke Green.

KGW, Portland, Ore. (Pacific, 492), 3:30 p. m., children's program; 8, concert by John Claire Monthleth, baritone; 10, dance music by George Olsen's Metropolitan orchestra, Hotel Portland.

KHJ, Los Angeles, Calif. (Pacific, 395), 12:30-1:15 p. m., Piggly-Wiggly Girls; 2:30-3, Bess Daniels, pianist; 6-6:30, Art Hickman's concert orchestra, Edward Fitzpatrick, director; 6:30-7:30, children's hour, "American History," Prof. Walter Sylvester Hertzog; Dickie Brandon, screen juvenile; 8-10, concert, the Gaylord

(continued on page 12)







# NOTICES FROM WGY-WJZ SATURDAY



Miss Jean Kibbey (left) is the attractive possessor of a most pleasing voice, in addition to being a remarkably pretty girl. Some folks seem to have everything! Here's her picture; now listen to her singing on the "Nite Caps on Lake Erie" program from WJAX. Above is June Ackroyd Farley. The young lady was well named—she always seems happy and sunny as might be expected with such a name as June. Her pleasing soprano is heard frequently from the Cleveland broadcasting stations.

## Where to Hear Talks

TALKS, instructive, serious, humorous and even frivolous, are Radiocast daily and below are listed the stations.

- Wednesday:** CKCH, KDKA, KFOA, KGO, KHJ, KYW, WBBR, WCX, WDAF, WDR, WDAF, WGI, WHA, WIP, WJZ, WLS, WMAQ, WOR, WOS.
- Thursday:** CKAC, KDKA, KFSG, KHJ, KYW, WBBR, WCB, WCAE, WDAF, WDAF, WGI, WGY, WHAS, WHB, WHN, WIP, WJAX, WJZ, WLS, WLW, WMAQ, WOR, WQJ, WRC.
- Friday:** CKY, CNRT, KFSG, KYW, WBAV, WCB, WDAF, WDR, WDAF, WGI, WOS.
- WGI, WGY, WHB, WJZ, WLS, WMAQ, WOAW, WOS, WRC.**
- Saturday:** CNRO, KDKA, KFSG, PWX, WBBR, WDAF, WFI, WGI, WJZ, WRC.
- Monday:** KGO, WBBR, WCB, WDAF, WDR, WFAA, WGR, WGY, WHN, WOR, WOS, WQJ.
- Tuesday:** KFSG, KYW, WCAE, WDAF, WDAF, WFAA, WGI, WGY, WHAA, WHAS, WJY, WJZ, WLAG, WMAQ, WQJ, WRC.

KPO, San Francisco, Calif. (Pacific, 423), 1-2 p. m., Fairmont hotel orchestra; 2:30-3:30, tea dansant; 8-12, Art Weidner and his popular artists.

KSD, St. Louis, Mo. (Central, 546), 8 p. m., Missouri theater orchestra and specialties broadcast direct from Missouri theater.

KYW, Chicago, Ill. (Central, Daylight, 536), 6:45 p. m., bedtime story; 7-7:30, dinner concert; 8-8:58, musical program; 9, talk; 9:05, Youth's Companion; 10:15-1:30 a. m., late show.

PWX, Havana, Cuba (Eastern, 400), 8:30 p. m., studio concert.

WBAV, Columbus, Ohio (Eastern, 423), 12 m., Ila Lorbach Owens, pianist.

WBBR, New York City, N. Y. (Eastern, Daylight, 273), 8 p. m., violin quartet; 8:15, bible questions and answers; 8:40, violin quartet.

WBZ, Springfield, Mass. (Eastern, Daylight, 337), 6 p. m., Leo Reisman's Hotel Lenox ensemble; 6:30, orchestra; 7:30, bedtime story; 7:40, concert by the Hotel Kimball trio; 9, recital by Mrs. F. D. Osborne, soprano; 9:15, violin recital.

WCAE, Pittsburgh, Pa. (Eastern, Daylight, 462), 3 p. m., piano recital; 6:30, dinner concert; 7:30, Uncle Kaybee; 9:30, musical program.

WCX, Detroit, Mich. (Eastern, 517), 4:15 p. m., musical program; 6, dinner concert. Silent evening.

WDAF, Kansas City, Mo. (Central, 411), 3:30-4:30 p. m., the Star's Radio lesson; Dr. Herbert W. Virgin, Edgewater Beach Oratorio orchestra; 9:30-10:30, William H. Hunt—Yellow, Red and Orange tales; Langdon brothers, Hawaiian steel guitars; dance selections; 11:30-12:30 a. m., Paul Locker, tenor; Langdon brothers; dance selections.

WFI, Philadelphia, Pa. (Eastern, Daylight, 395), 1 p. m., Meyer Davis Bellevue Stratford concert orchestra; 3:15, Loretta Kerk, pianist; 6, Sunny Jim, the kiddies' pal; 6:30, Meyer Davis Bellevue Stratford concert orchestra.

WGAO, Shreveport, La. (Central, 252), 8-9 p. m., musical programs; 10-12, dance music. Ramblers Hotel Youre orchestra.

WGN, Chicago, Ill. (Central, Daylight, 370), 6:30-7:30 p. m., Drake concert ensemble and Blackstone string quintette; 8:30-9:30, Helen Wilson, soprano; Blanche Robinson, piano; Klutus Tschumseh, tenor; 10:30-11:30, Bert Davis, Jack Chapman's orchestra; 12:30-2 a. m., Jack Chapman's orchestra, Harmony Girls, Bert Davis.

WGR, Buffalo, N. Y. (Eastern, Daylight, 319), 12:30-1 p. m., George Albert Bouhard, organist.

WGY, Schenectady, N. Y. (Eastern, Standard, 380), 9:30 p. m., dance music. Joseph A. Chlekena.

WHN, New York City (Eastern, Daylight, 360), 2:15 p. m., songs; 3:45, concert; 4:15 violinist; 4:30, concert; 8, tenor; 8:15, soprano; 8:45, male quartet; 9:45, Fitzpatrick Bros.; 10:15, soprano; 10:30, baritone; 11, Jimmy Clark and entertainers; 11:30, orchestra.

WIP, Philadelphia, Pa. (Eastern, Daylight, 509), 10 a. m., seashore gossip; 10:10, Bernard MacFadden's health talk; 1:05 p. m., Karl Bonawitz, organist; 2:30, Comfort's philharmonic orchestra, Bessie Crown, soprano; 6:05, Harry Link's dinner dance program; 7, Uncle Wip's bedtime stories; 8, Final activities Atlantic City pageant; 8:30, Comfort's philharmonic orchestra; Bessie Crown, soprano; 8:45, "What the

wild waves are saying"; 8:50, Vessella's concert band; Olive Marshall, soprano; 10, Bob Leman's dance orchestra; 10:30, announcing name of Miss America; 11:05, Karl Bonawitz, organist.

WJAX, Cleveland, Ohio (Eastern, 390), midnight, "Nite Caps on Lake Erie," program arranged by Euclid Music company; Cleveland News Leader; Austin J. Wylie's Golden Pheasant restaurant orchestra; George Warmack's syncopeators; Wills Zeller's Plectrum orchestra; Rex Heller, soprano; Elvia Kincaid, contralto; Bobble Fitzpatrick, soprano; Ethel Rhody, contralto; Neapolitan quartette, Carrabelle Johnson, soprano; Dorris Stadden Kaser, contralto, Klezinski, tenor; William Taylor, baritone; Eddie Connors, banjo-guitar; Frank Wiesenberger, pianist; Jack Evans, bass; Chas Fletcher, baritone; John Klinger, Byron Bayles, tenors; Carl Myers, baritone; Claude Brent, pianist; Howard Justice, tenor; Doc Whipple, piano; Colby Hubbard, saxophone; 1 a. m., Cruise of "Nite Caps on Lake Erie" around the world; direction Jim Brew, Chief Nite Cap; Scottish songs, Phil Barker, "The Harry Lauder of Cleveland"; Scotch bagpipers, Blackwoods' Pipers; Holland, wooden shoe dancing; Russian music, Leonard Bryan, Jr., pianist; O. A. Bryan, violin; Hungarian, Julius Miko, dulcimer, H. Ginnas, violin; Egyptian-Turkey, E. Whitney, oriental drums, L. Petzinger, Egyptian musette; Syria, native Syrian orchestra; Italy, Neapolitan quartette; Spain, Wills Zeller, Plectrum orchestra; Howard Justice, Jean Kibbey, India, Rex Heller; China, Imperial Chinese orchestra, Kia Yow Wou, director; selection from Mah Jong; Hawaii, Eddie Connors, banjo-guitar; Hawaiian orchestra, Eruptions of Mt. Kilauea; United States—home again, George Warmack's syncopeators. Austin J. Wylie directing all orchestra accompaniments; 5 a. m., signing off.

WJZ, New York City (Eastern, Daylight, 455), 1 p. m., Hotel Vanderbilt orchestra; 7, Waldorf Astoria orchestra; 8, Harry H. Seyde, bass; 8:15, talk; 8:30, Hotel Astor dance orchestra; 9:30, musical program; 10:30, Hotel Astor dance orchestra.

WLS, Chicago, Ill. (Central, Daylight, 345), 7:45 p. m., 1 a. m., weekly summary of grain and hay markets; lullaby time, Glenn Rowell and Ford Rush; Isham Jones' College Inn orchestra; National barn dance.

WMAQ, Chicago, Ill. (Central, Daylight, 447.5), 6:30 p. m., Hotel LaSalle orchestra; 8, poems by Douglas Malloch; 9, weekly Balaban & Katz Chicago theater revue.

WMC, Memphis, Tenn. (Central, 500), 8:30 p. m., program arranged by Mrs. S. J. Latta.

WNH, Cincinnati, Ohio (Central, Daylight, 309), 10 p. m., piano solos, Hazel Motz, Thelma Copelan, accompanist; popular songs, Britt & Finch; 10:30, piano solos, Thelma Copelan; piano duets, Hazel Motz, Thelma Copelan; popular songs, Melvin Bettinger, Bob Surran; 11, Eddie Sides' Middies, orchestra.

WOAW, Omaha, Neb. (Central, 286), 6 p. m., program from piano studio; 9, musical program.

WOC, Davenport, Ia. (Central, 484), 9 p. m., orchestra program; Ralph W. Fuller, baritone soloist.

WOO, Philadelphia, Pa. (Eastern, Daylight, 509), 11 a. m., organ recital, Mary E. Vogt; 12:02 p. m., Wanamaker crystal tea room orchestra, Robert E. Golden, director; 4:45, organ recital, Mary E. Vogt; band concert, Wanamaker band.

WOR, Newark, N. J. (Eastern, Daylight, 405), 2:30 p. m., Tom Banks' Colonial Inn orchestra; 3:30, orchestra; 6:15, Charley Storm and his colleagues; 7:00, resume of the day's sports; 8-8:15, talk; 8:30, recital, soprano; 8:45, recital, baritone; 9:30, talk; 10:10, recital, soprano; 10:30-10:45, program by Breaud and Tobias.

WQJ, Chicago, Ill. (Central, Daylight, 448), 3-4 p. m., "Koffee" Klatsch, music; 7-8, soprano, pianist, contralto; 10-2 a. m. Rainbo orchestra; tenor Jerry Sullivan; Harmony singers; tenor, Harmony singers.

WRC, Washington, D. C. (Eastern, Daylight, 469), 6 p. m., children's hour; 8, musical program, 309, 8 p. m., chimes concert; 8-15, tenor solo, Howard Wofford; soprano solo, Violet Sommer; 9, weekly news review, Rutherford H. Cox; 9:15, Hawaiian music, Collins & Hubbell; piano solos, Olga Speidel; 12, original popular songs, Britt & Finch; 12:30, Freda Sanker's Ragamuffins.

WTAS, Elgin, Ill. (Central, 286), 12:30-1:30 p. m., Morrison Hotel Terrace Garden restaurant; piano selection concert, director, E. E. Sheetz, Jr.; 2-5, baseball scores; 6:30-12, star concert dance program from the Morrison Hotel Terrace Garden restaurant; piano selections by Charley Hughey.

WTAY, Oak Park, Ill. (Central, Daylight, 283), 6:45-7:45 p. m., tenor; dramatic reader; orchestra; 9-11:15, accordion, soprano, whistler.

WWJ, Detroit, Mich. (Eastern, 580), 12 m., The Detroit News orchestra; 7 p. m., The Detroit News orchestra.

## Sunday, September 7

CHYC, Montreal, Can. (Eastern, 341), 9 p. m., studio program.

KFI, Los Angeles, Calif. (Pacific, 469), 10-10:45 a. m., church meditation service; 6:45-8 p. m., Metropolitan

theater program; 9-10, Examiner studio concert; 10-11, Packard's orchestra.

KFN, Shenandoah, Va. (Central, 266), 3 p. m., services by Mens' Gospel Team of Shenandoah; 6:30, regular sacred song service.

KFSG, Los Angeles, Calif. (Pacific, 278), 10:30-12:30, noon, morning service, holy communion; sermon, Allice Semple McPherson; Esther Fricke Green, organist; 2:30-4:30 p. m., afternoon service, Allice Semple McPherson; choir; silver band, direction Gladwyn N. Nichols; Roy Reid Brignall, organist; 7-9:30, musical hour, choir; silver band; Esther Fricke Green, organist; salvation sermon, alter call, Allice Semple McPherson.

KGO, Oakland, Calif. (Pacific, 312), 11 a. m., Sunday service; 3:30 p. m., concert by KGO Little Symphony orchestra, Carl Rhodehamel conducting; 7:45, evening service.

KGW, Portland, Ore. (Pacific, 492), 6 p. m., church services.

KHJ, Los Angeles, California. (Pacific, 395), 10 a. m., sermon from KHL, studio; 10:30-12:30, noon, organ recital and service from First M. E. church; Arthur Blakeley, organist, Rev. E. E. Helms, pastor; 6:30-7 p. m., Art Hickman's concert orchestra; Edward Fitzpatrick; director; 7-7:30, organ recital from First M. E. church, Arthur Blakeley, organist; 8-10, de luxe concert.

KPO, San Francisco, Calif. (Pacific, 423), 11-12 p. m., church services; 8:30-10, concert by Rudy Seiger's Fairmont hotel orchestra.

KYW, Chicago, Ill. (Central, Daylight, 536), 11 a. m., Sunday morning service; 2:30 p. m., studio chapel service.

WCAE, Pittsburgh, Pa. (Eastern, Daylight, 462), 3:30 p. m., People's Radio church services; 7, dinner concert from William Penn hotel.

WCX, Detroit, Mich. (Eastern, 517), 10:30 a. m., services, Central M. E. church, Dr. Lynn Harold Hough, pastor; Hudson quartette.

WDAF, Kansas City, Mo. (Central, 411), 4:30-5:30 p. m., program broadcast from the Newman theater.

WEBB, Chicago, Ill. (Central, Daylight, 370), 7-9 p. m., artist program, Joseph Brinkman, pianist; Elsie Schey, contralto; Marion O'Neil Holland, violinist; Edgewater Beach Oratorio orchestra.

WFAA, Dallas, Texas (Central, Standard, 476), 6-7 p. m., bible class; bible study and gospel song.

WFI, Philadelphia, Pa. (Eastern, Daylight, 395), 7:30 p. m., services, Arch Street Presbyterian church.

WGN, Chicago, Ill. (Central, Daylight, 370), 5-6 p. m., program announced later; 9:15, Drake concert ensemble and other artists to be announced later.

WGR, Buffalo, N. Y. (Eastern, Daylight, 319), 3-4 p. m., vesper service.

WGY, Schenectady, N. Y. (Eastern, Standard, 380), 9:30 a. m., church services; 6:30 p. m., organ prelude and services.

WHAS, Louisville, Ky. (Central, 400), 9:57 a. m., organ music; 10, church service; 4-5 p. m., concert.

WHB, Kansas City, Mo. (Central, 411), 11 a. m.-12:30 p. m., services, Linwood Boulevard Christian church, Dr. Burris Jenkins, pastor; 8-9:15, church services broadcast from Indian Village.

WHK, Cleveland, Ohio (Eastern, 283), 8 p. m., chapel services, auspices, Federated Churches of Cleveland, Detroit, W. W. Whit, director; choral singing by choir of Orthodox church; 9, chamber music; Leonard Bryan, Jr., pianist; O. A. Bryan, violin; soloists; 10, concert program, arranged by Hotel Winton.

WHO, Des Moines, Ia. (Central, 526), 7:30-9 p. m., musical program given by the Bankers Life Radio orchestra, Mr. Wm. Marsh and Stewart Dulaney, directors.

WIP, Philadelphia, Pa. (Eastern, Daylight, 509), 11 a. m., services, Holy Trinity church; 3, talk by Miss America, 24.

WLS, Chicago, Ill. (Central, Daylight 345), 6:30 p. m., Ralph Emerson at the Barton organ; 7-8, musical program arranged by the Irving Walton League.

WLW, Cincinnati, Ohio (Central, Daylight, 423), 9:30 a. m., Sunday school; 11, devotional services, Church of the Covenant, sermon, Dr. Frank Stevenson; 9 p. m., Western and Southern orchestra.

WOAW, Omaha, Neb. (Central, 286), 9 a. m., chapel service; 9 p. m., musicale.

WOO, Philadelphia, Pa. (Eastern, Daylight, 509), 10 a. m., services, Bethany temple; 2:30, Sunday school services, Bethany temple.

WOS, Jefferson City, Mo. (Central, 440.9), 7:30 p. m., complete religious service of the Methodist church of Jefferson City, Rev. J. E. McDonald, pastor.

WQJ, Chicago, Ill. (Central, Daylight, 448), 8-10 p. m., Rainbo orchestra concert; Harmony singers; Grace Nelson, Dorothy Davie Dillow, soprano; Langdon brothers, steel guitar duets.

WSA, Cincinnati, Ohio (Central, Daylight, 309), 3 p. m., sermon; 3:10, sacred chimes concert.

WTAS, Elgin, Ill. (Central, 286), 12:30-1:30 p. m., Morrison Hotel Terrace Garden, noonday orchestra; concert, E. E. Sheetz, Jr., director; 5 Vile Olivia's star Sunday afternoon concert; 6:30-12, star concert dance program.

WWJ, Detroit, Mich. (Eastern, 580), 5 p. m., The Detroit News orchestra; 7:30, services at St. Paul's Episcopal cathedral, broadcast from cathedral.

## Monday, September 8

CKAC, Montreal, Can. (Eastern, Daylight, 425), 1:45 p. m., Mount Royal hotel luncheon concert.

KFKX, Hastings, Neb. (Central, 341), 9:30-11 p. m., dance orchestra.

KGO, Oakland, Calif. (Pacific, 312), 3 p. m., studio musical program; 4-5:30, Henry Halstead's dance orchestra, Hotel St. Francis, San Francisco; 5:30-6, Aunt Betty stories; 8, educational program; 10-1 a. m., dance music program.

KGW, Portland, Ore. (Pacific, 492), 3:30 p. m., literary program; 8, concert by Mme. Frieda Stjerne, soprano.

KHJ, Los Angeles, Calif. (Pacific, 395), 12:30-1:15 p. m., concert, Carl Allen and Rendezvous ballroom orchestra, courtesy Crystal Beach; Rendezvous trio.

KPO, San Francisco, Calif. (Pacific, 423), 1-2 p. m., Fairmont hotel orchestra; 2:30-3:30, organ recital; 4:30-5:30, orchestra; 5:30-6:30, children's hour; 7-7:30, orchestra; 8-9, organ recital, Theodore J. Irwin; 9-10, program; 10-11, Versatile band.

KQV, Pittsburgh, Pa. (Eastern, Daylight, 270), 10:30-11 a. m., music; 3-3:30 p. m., music; 8-9, popular song revue presented by Bert and Thelma Fields; 9-10, musical program presented by the Nevyn trio.

WAAW, Omaha, Neb. (Central, 286), 7:30-9 p. m., program by the South Omaha American Legion Post No. 331, Joe Ubane and his orchestra, assisted by an interesting speaker.

WBAV, Columbus, Ohio (Eastern, 423), 12 m., Ila Lorbach Owens, pianist.

WCAE, Pittsburgh, Pa. (Eastern, Daylight, 462), 4:30 p. m., Sunshine Girls; 6:30, dinner concert transmitted from William Penn hotel; 7:30, Uncle Kaybee; 9:30, musical program; 11, late concert.

WCX, Detroit, Mich. (Eastern, 517), 4:15 p. m., musical program; 6, dinner concert; 7, musical program, under direction of Prof. Alfred Blackman.

WDAF, Kansas City, Mo. (Central, 411), 3:30-4:30 p. m., the Star's Radio talk; 5-5:30, weekly Boy Scout program, auspices Kansas City council; 6-7, School of the Air, piano tuning in number on the Duo-Art; personal message from Roger W. Bahson, statistical expert; address, Clirin Zumwalt, M. A.; the Tell-Me-a-Story Lady; music, Carl Nordberg's Plantation players, Hotel Muehlebach; 8-9:30, program by the Star's string quintet and soloists; 11:45-1 a. m., Nighthawk frolic, the Merry Old Chief" and the Plantation players, Hotel Muehlebach.

WDAF, Philadelphia, Pa. (Eastern, Daylight, 395), 11:45 a. m., daily almanac; 12:02, p. m., Stanley theater organ recital; 12:30, Arcadia cafe concert orchestra; 2, Arcadia cafe concert orchestra; 4:30, Edna Finestone, pianist; 7:00, Dream Daddy's bedtime stories; 8, Arcadia cafe concert orchestra; 10, Arcadia cafe dance orchestra.

WGAO, Columbus, Ohio (Eastern, 360), 1:30 p. m., educational lecture, member Ohio State university faculty.

WFAA, Dallas, Texas (Central, Standard, 476), 12:30-1 p. m., talk; 8:30-9:30, musical recital.

WFI, Philadelphia, Pa. (Eastern, Daylight, 395), 1 p. m., Meyer Davis Bellevue Stratford concert orchestra; 3:15, Loretta Kerk, pianist; talk, "Great Composers," Mabel Swint Ewer; 6, Sunny Jim, the kiddies' pal; 6:30, Meyer Davis Bellevue Stratford concert orchestra.

WGAW, Shreveport, La. (Central, 252), 9-12 p. m., dance music, Ramblers Hotel Youre orchestra.

WGR, Buffalo, N. Y. (Eastern, Daylight, 319), 12:30-1 p. m., George Albert Bouhard, organist; 6:30-7:30, Harriet Arman, soprano; 9-11, concert, Pierce plant, American Radiator company, C. P. Robertson, director; 11:30, super-dance music, Vincent Lopez' Hotel Stalter dance orchestra, Harold Geser, director.

WGY, Schenectady, N. Y. (Eastern, Standard, 380), 7:15 p. m., address; 7:45, movie talk; 7:45-10, orchestra selections.

WHAS, Louisville, Ky. (Central, 400), 4-5 p. m., Alamo theater orchestra; 4:50, grain market reports; 4:55, baseball scores.

WHAZ, Troy, N. Y. (Eastern, 380), 9 p. m., second anniversary of WHAZ with program by the Domino Novelty orchestra.

WHB, Kansas City, Mo. (Central, 411), 7-8 p. m., Sweeney Radio instrumental trio.

WHN, New York City, (Eastern, Daylight, 360), 6:30-7:15 p. m., Oleott Vail's Alamac trio; 7:30-7:45, screen celebrities; 8-8:30, Roseland dance orchestra; 9-9:30, Palisades Park orchestra; 10-11, Jack Shack broadcasting direct from Radio Shack.

WHO, Des Moines, Ia. (Central, 526), 7:30-9 p. m., musical program given by Sclotha Herndon, soprano, H. E. Butterfield, tenor; Pearl Plumber Hinshaw, soprano; Edith Ury, piano; Mrs. Susan Bender Eddy, soprano; Hibbard Cleveland, bass; Mrs. C. A. Cleveland, accompanist.

WIP, Philadelphia, Pa. (Eastern, Daylight, 509), 10 a. m., seashore gossip; 10:10, Bernard MacFadden's health talk; 3 p. m., "What the wild waves are saying"; 3:30, Comfort's philharmonic orchestra; 6:05, Frisco Sereaders dance orchestra; 7, Uncle Wip's bedtime stories.

WLW, Cincinnati, Ohio (Central, Daylight, 423), 8 p. m., Crosley theatrical review; 8:30, Alvin Roehr's music makers.

WMAQ, Chicago, Ill. (Central, Daylight, 447.5), 4 p. m., talk by Mrs. Frances M. Ford; 4:30, musical program; 6, Chicago theater organ recital; 6:30, Hotel LaSalle orchestra.

WMC, Memphis, Tenn. (Central, 500), 8:30 p. m., request program by Hotel Gayoso orchestra.

WOAW, Omaha, Neb. (Central, 286), 6 p. m., popular half hour; 6:30, dinner program by Bob Lee's Imperial jazz band; 9, program.

WOO, Philadelphia, Pa. (Eastern, Daylight, 509), 11 a. m., organ recital, Mary E. Vogt; 12:02 p. m., Wanamaker crystal tea room orchestra; 4:45, organ recital, Mary E. Vogt; 7:30, A. Candelori and his Hotel Adelpia concert orchestra; 8:30, Harriet G. Diddle; 10, organ recital, Mary E. Vogt; 10:30, A. Candelori and his Hotel Adelpia roof garden orchestra.

WOR, Newark, N. J. (Eastern, Daylight, 405), 2:30 p. m., recital, Rutist; 2:45, talk; 3:15, Carl Fischer, Rutist; 3:45, talk; 6:15, Elite orchestra; 7:20, resume of the day's sports; 8, Frank J. Dalton, speaker; 8:15, WOR, Monday nighters; 8:45, Wm. Oscar, violinist; 9:15, Charlotte Hamilton, contralto; 9:30-10:15, Japanese program; 10:30, violinist; 11, contralto.

WOS, Jefferson City, Mo. (Central, 440.9), 8 p. m., address; 8:20, musical program consisting of old time square dance and quadrille tunes played by the Old Time string trio; Louie Barton, George Schrimpf and Bryan Williams.

WQJ, Chicago, Ill. (Central, Daylight, 448), 3-4 p. m., talk; silent night.

WRC, Washington, D. C. (Eastern, Daylight, 469), 3:10 p. m., song recital; 3:35, piano selections; 4, songs; 6, stories for children.

WSA, Cincinnati, Ohio (Central, Daylight, 309), 10 p. m., Royal Garden orchestra; popular songs, Brett & Finch.

WTAM, Cleveland, Ohio (Eastern, 390), 8 p. m., Bernard Metzger, pianist; Virginia Kenter, harpist; Dorothy Bracken, violinist; Maurine Strothers, whistler.

WTAS, Elgin, Ill. (Central, 286), 12:30-1:30 p. m., Morrison Hotel Terrace Garden, noonday orchestra concert; 2-5, baseball scores; 7:15, Charley Hughey playing Kimball organ; 7:20-7:45, WTAS orchestra in concert of symphonic dance numbers; 7:45-8, WTAS artists singing late popular songs; 8-8:30, orchestra; 8:30-8:45, the popular trio; 8:45-9, orchestra; 9-9:30, Hawaiian numbers; 9:30-10, dance numbers; 10-11, Charley Hughey playing request numbers.

WWJ, Detroit, Mich. (Eastern, 517), 8 a. m., setting-up exercises, R. J. Horton; 9:30 a. m., talk, women's editor, Detroit News; 12 m., Detroit News orchestra; 3 p. m., Detroit News orchestra; 8:30, Detroit News orchestra.

## Tuesday, September 9

CKAC, Montreal, Can. (Eastern, Daylight, 425), 7 p. m., kiddies' stories; 7:30, Rex Battle and his Mount Royal hotel concert orchestra; 8:30, orchestra concert; 10:30, Joseph C. Smith and his Mount Royal hotel roof-garden orchestra.

KFN, Shenandoah, Va. (Central, 266), 7:30 p. m., program by Camp 52 Royal Neighbors of Shenandoah.

KGO, Oakland, Calif. (Pacific, 312), 4-5:30 p. m., concert orchestra of the Hotel St. Francis, San Francisco, Yinton LaFerrera, conducting; 8, admission day program; 10-1 a. m., dance music program.

KGW, Portland, Ore. (Pacific, 492), 3:30 p. m., children's program; 8, concert by George Weber and his orchestra.

KHJ, Los Angeles, Calif. (Pacific, 395), 12:30-1:15 p. m., concert; 2:30-3, Bess Daniels, pianist; 6-8:30, Art







# CLIPS FROM WGY-WJZ SATURDAY

D. m., George Albert Boucharde, organist.  
 WGY, Schenectady, N. Y. (Eastern, Standard, 380), 9:30  
 p. m., dance music, Joseph A. Chickene  
 WNN, New York City (Eastern, Daylight, 360), 2:15  
 p. m., songs; 3:45, concert; 4:15 violinist; 4:30, con-  
 tralto; 5, southern harmonists; 6:30-7:30, dinner  
 concert; 8, tenor; 8:15, soprano; 8:45, male quartette;  
 9:45, Fitzpatrick Bros.; 10:15, soprano; 10:30, bar-  
 itone; 11, Jimmy Clark and entertainers; 11:30, or-  
 chestra.  
 WIP, Philadelphia, Pa. (Eastern, Daylight, 509), 10  
 a. m., seashore gossip; 10:10, Bernard MacFadden's  
 health talks; 1:05 p. m., Karl Bonawitz, organist;  
 3:30, Comfort's philharmonic orchestra, Bessie Crown,  
 soprano; 6:05, Harry Link's dinner dance program;  
 7, Uncle Wily's bedtime stories; 8, final activities  
 Atlantic City pageant; 8:30, Comfort's philharmonic  
 orchestra; Bessie Crown, soprano; 8:45, "What the

tions by Lmarley Hugney.  
 WTAY, Oak Park, Ill. (Central, Daylight, 283), 6:45-7:45  
 p. m., tenor; dramatic reader; orchestra; 9-11:15,  
 accordion, soprano, whistler.  
 WWJ, Detroit, Mich. (Eastern, 580), 12 m., The Detroit  
 News orchestra; 7 p. m., The Detroit News orchestra.  
 CHYC, Montreal, Can. (Eastern, 341), 9 p. m., studio  
 program.  
 KFI, Los Angeles, Calif. (Pacific, 469), 10-10:45 a. m.,  
 church meditation service; 6:45-8 p. m., Metropolitan

## Sunday, September 7

7:00-8:00, orchestra, 8:00-9:00, children's hour; 7-  
 7:30, orchestra; 8-9, organ recital, Theodore J. Irwin;  
 9-10, program; 10-11, Versatile band.  
 KQV, Pittsburgh, Pa. (Eastern, Daylight, 270), 10:30-  
 11 a. m., music; 3-3:30 p. m., music; 8-9, popular  
 song revue presented by Ben and Thelma Fields; 9-10,  
 musical program presented by the Nevin trio.  
 WAAW, Omaha, Nebr. (Central, 286), 7:30-9 p. m.,  
 program by the South Omaha American Legion Post  
 No. 331, Joe Ubanec and his orchestra, assisted by an  
 interesting speaker.  
 WBAV, Columbus, Ohio (Eastern, 423), 12 m., Ila  
 Lorbach Owens, pianist.  
 WCAE, Pittsburgh, Pa. (Eastern, Daylight, 462), 4:30  
 p. m., Sunshine Girl; 8:30, dinner concert trans-  
 mitted from William Penn hotel; 7:30, Uncle Kaybee;  
 9:30, musical program; 11, late concert.  
 WCX, Detroit, Mich. (Eastern, 517), 4:15 p. m., mu-

CKAC, Montreal, Can. (Eastern, Daylight, 425), 7  
 p. m., kiddies' stories; 7:30, Rex Battle and his  
 Mount Royal hotel concert orchestra; 8:30, orchestra  
 concert; 10:30, Joseph C. Smith and his Mount Royal  
 hotel roof-garden orchestra.  
 KFNF, Shenandoah, Va. (Central, 266), 7:30 p. m.,  
 program by Camp 52 Royal Neighbors of Shenandoah.  
 KGO, Oakland, Calif. (Pacific, 312), 4-5:30 p. m., con-  
 cert orchestra of the Hotel St. Francis, San Francisco,  
 Vinton LaFerreira, conducting; 8, admission day pro-  
 gram; 10-11 a. m., dance music program.  
 KGW, Portland, Ore. (Pacific, 492), 3:30 p. m., chil-  
 dren's program; 8, concert by George Weber and his  
 orchestra.  
 KHJ, Los Angeles, Calif. (Pacific, 395), 12:30-1:15 p.  
 m., concert; 2:30-3, Bess Daniels, pianist; 6-6:30, Art

## September 9

30  
 oy  
 7,  
 o-  
 s-  
 he  
 a-  
 by  
 1,  
 he  
 ),  
 ey  
 ert  
 dna  
 stor-  
 Arcadia  
 80 p. m., edu-  
 versity faculty.  
 476), 12:30-1  
 , 395), 1 p. m.,  
 orchestra; 3:15,  
 posers, "Mabel  
 es' pal; 6:30,  
 orchestra.  
 9-12 p. m.,  
 hestra.  
 319), 12:30-1  
 st; 6:30-7:30,  
 soprano; 9-11,  
 r company, G.  
 -dance music,  
 hestra, Harold  
 rd, 380), 7:15  
 7-10, orchestra  
 p. m., Alamo  
 reports; 4:55,  
 p. m., second  
 y the Domino  
 . 7-8 p. m.,  
 t, 360), 6:30-  
 30-7:45, screen  
 estra; 9-9:30,  
 Shack broad-  
 7:30-9 p. m.,  
 adon, soprano,  
 ber Hinshaw,  
 Bender Eddy,  
 C. A. Cleve-  
 ght, 509), 10  
 MacFadden's  
 s are saying";  
 6:05, Frisco  
 Wip's bedtime  
 423), 8 p. m.,  
 Roehr's music  
 ht, 447.5), 4  
 4:30, musical  
 ; 6:30, Hotel  
 30 p. m., re-  
 p. m., popular  
 Lee's Imperial  
 ght, 509), 11  
 12:02 p. m.,  
 ; 4:45, organ  
 elori and his  
 ), Harriet G.  
 Vogt; 10:30,  
 t roof garden  
 it, 405), 2:30  
 Carl Fischer,  
 ; 7:20, resume  
 speaker; 8:15,  
 scar, violinist;  
 -10:15, Japan-  
 ralto.  
 . 8 p. m., ad-  
 e of old time  
 d by the Old  
 Schrimpf and  
 8), 3-4 p. m.,  
 ght, 469), 3:10  
 ons; 4, songs;  
 ght, 309), 10  
 r songs, Brett  
 8 p. m., Ber-  
 nter, harpi-  
 thers, whistler.  
 0-1:30 p. m.,  
 day orchestral  
 harley Hughey  
 S orchestra in  
 7:45-8, WTAS  
 :30, orchestra;  
 hestra; 9-9:30,  
 mbers; 10-11,  
 rs.  
 m., setting-up  
 talk, women's  
 News orchestra;  
 Detroit News



Tuesday, September 9

(Continued from page 13)

Hickman's concert orchestra, Edward Fitzpatrick, director; 6:30-7:30, children's hour, "American History," Prof. Walter Sylvester Hertzer; Queen Titania and the Sandman; bedtime story, Uncle John; 8-10, de luxe concert.

KFO, San Francisco, Calif. (Pacific, 423), 1-2 p. m., Fairmont hotel orchestra; 2:30-3:30, organ recital, Theodore J. Irwin; 4:30-5:30, Rudy Selger's orchestra; 5:30-6:30, children's hour; 7-7:30, Fairmont hotel orchestra; 8-10, varied program; 10-11, Versatile band.

WBAV, Columbus, Ohio (Eastern, 423), 12 m., Ila Lorch Owens, pianist; 8 p. m., Charley Moble's dance orchestra.

WCAE, Pittsburgh, Pa. (Eastern, Daylight, 462), 4:30 p. m., Sunshine Girl; 6:30, dinner concert from the William Penn hotel; 7:30, Uncle Kaybee; 11, late concert.

WCX, Detroit, Mich. (Eastern, 517), 4:15 p. m., musical program; 6, dinner concert; 10, Red Apple club.

WDAF, Kansas City, Mo. (Central, 411), 3:30-4:30 p. m., the Star's Radio trio; 5-5:30, weekly child talent program, pupils of Mrs. Jessie Wilson Towner and collaborating teachers; 6-7, School of the Air, piano tuning in number on the Duo-Art; eighteenth of a series of piano lessons by Maudie Littlefield; the Tell-Me-a-Story Lady; music, Carl Nordberg's Plantation players, Hotel Muehlebach; 11:15-1 a. m., Nighthawk frolic, the "Merry Old Chief" and the Plantation players, Hotel Muehlebach.

WDAR, Philadelphia, Pa. (Eastern, Daylight, 395), 11:45 a. m., daily almanac; 12:02 p. m., Stanley theater organ recital; 12:30, Arcadia cafe concert orchestra; 2, Arcadia cafe concert orchestra; Edna Flinstone, pianist; 7:30, Dream Daddy's bedtime stories.

WEAO, Columbus, Ohio (Eastern, 360), 1:30 p. m., educational lecture, member Ohio State university faculty.

WFAA, Dallas, Texas (Central, Standard, 476), 12:30-1 p. m., address; 8:30-9:30, musical program; 11-12, Alda choral club.

WFI, Philadelphia, Pa. (Eastern, Daylight, 395), 1 p. m., Meyer Davis Bellevue Stratford concert orchestra; closing reports Chicago grain market; 3:30, Caroline Hoffman, pianist; Harold A. Simonds, baritone; 6, Sunny Jim, the kiddies' pal; 6:30, Meyer Davis Bellevue Stratford concert orchestra.

WGN, Chicago, Ill. (Central, Daylight, 370), 6:30-7:30 p. m., Drake concert ensemble and Blackstone string quintette; 8:30-9:30, Walter Barnitz, guitar, Rosemary Hughes; 10:30-11:30, Bert Davis, Jack Chapman's orchestra.

WGR, Buffalo, N. Y. (Eastern, Daylight, 319), 12:30-1 p. m., George Albert Bouchard, organist; 6:30-7:30, dinner music.

WGY, Schenectady, N. Y. (Eastern, Standard, 380), 1 p. m., address; 6, dinner music; 7:45, musical program and one act play; 10:15, organ recital.

WHAS, Louisville, Ky. (Central, 400), 4-5 p. m., selections by Dick Quinlan's Gold Derby orchestra; 7:30-9, concert by Carl Zoeller's melodists.

WHB, Kansas City, Mo. (Central, 411), 8-9:30 p. m., semi-classical music, Frank R. Marks' orchestra; 10:30-11:30, dance music, Frank R. Marks' orchestra.

WHN, New York City, N. Y. (Eastern, Daylight, 360), 2:15-3:15 p. m., State theater orchestra and vaudeville; 3-3:30, original St. Louis Rhythm Kings, Louis Malsto, leader; 6:30-7:15, Oleott Vail's Alamarc trio; 9:30-9:45, Palisades Park orchestra; 10-10:30, Bertram J. Goodman orchestra; 11:30-12, Club Alabam revue.

WIP, Philadelphia, Pa. (Eastern, Daylight, 509), 10 a. m., seashore gossip, 10:10, Bernarr MacFadden's health talk; 1:05, Karl Bonawitz, organist; 3, "What the wild waves are saying"; 3:30, Comfort's philharmonic orchestra; 6:05, Ehrenzeller's concert orchestra; 7, Uncle Wip's bedtime stories; 8, Comfort's philharmonic orchestra; 8:45, "What the wild waves are saying"; 8:50, Vesella's concert band.

WJAX, Cleveland, Ohio (Eastern, 399), 7:30 p. m., program arranged by the Cleveland News-Leader; E. G. Johnson, bedtime story; Radio talk cartoon, Don Palmer; 8, concert program, special features.

WLW, Cincinnati, Ohio (Central, Daylight, 423), 10 p. m., Mastro Paolo instrumental trio; 11, Bernie Cummins' orchestra; 11:55, Chubb-Stehberg orchestra.

WMAQ, Chicago, Ill. (Central, Daylight, 447.5), 4 p. m., talk on Red Cross home nursing course; 4:30, musical program; 6, Chicago theater organ recital; 6:30, Hotel LaSalle orchestra.

WMC, Memphis, Tenn. (Central, 500), 8:30 p. m., program by the Bluff City quartette, arranged by George W. Hughes.

WDAW, Omaha, Neb. (Central, 526), 6 p. m., popular half hour; 6:30, program; 9, orchestra.

WDO, Philadelphia, Pa. (Eastern, Daylight, 509), 11 a. m., organ recital, Mary E. Vogt; 12:02 p. m., Wanamaker crystal tea room orchestra, Robert E. Golden, director; 4:45, Mary E. Vogt, organist.

WDR, Newark, N. J. (Eastern, Daylight, 405), 2:30 p. m., recital by Molly Chapin Ely, contralto; 3:45, contralto; 6:15, Halsey Miller and his orchestra; 6:30-7, man in the moon stories; 7-7:15, Halsey Miller's orchestra.

WQJ, Chicago, Ill. (Central, Daylight, 418), 11-12 a. m., lectures, 3-4, talks; 7-8, dinner concert; The Cambridge Sisters; Margaret Garrity, pianist; 10-2, Kainbo orchestra; tenor; Harry Geise.

ERNIE YOUNG BOOKS 30 REVUES FOR KYW

FIRST, WEDNESDAY, SEPTEMBER 3; FULL SHOW

Will Continue Till March, 1925—Each to Last Two-and-a-Half Hours, Beginning at 10:00 P. M.

(Photos on Page 11)

CHICAGO.—What is considered the greatest consecutive booking of a big feature was arranged by KYW, the Westinghouse station here at Chicago, when a complete schedule of Ernie Young's Revues covering thirty weeks was consummated.

Beginning Wednesday evening, September 3, and every Wednesday thereafter, until the last week in March, 1925, Ernie Young will offer an entire revue covering a period of two-and-a-half hours of the finest entertainment to be heard on the air.

This feature is not only exceptional from a booking arrangement, but the type of entertainment will embrace the best to be heard anywhere.

Sans Faces But with Good Music

Ernie Young is a well-known Chicago producer who has made a reputation because of the wonderful revues he has presented from coast to coast during the past four years. His productions have been often referred to as regular Ziegfeld offerings, and whereas the Radio audience will not have an opportunity of gazing upon the lovely faces of his leading feminine stars and the comic countenances of his famous comedians and captivating comedienettes, they will, at least, have the pleasure of listening to an arrangement of good music, songs, and comedy, especially arranged for the occasion.

WRC, Washington, D. C. (Eastern, Daylight, 469), 6 p. m., children's hour; 9:20, concert.

WSAI, Cincinnati, Ohio (Central, Daylight, 309), 7 p. m., Hotel Gibson orchestra; 7:30, chimes concert; 7:45, children's stories, Ethel Knapp Hehrman; 8, Gibson orchestra; 9, original popular songs, Britt & Finch; piano solos, Ann Cockburn.

WTAS, Elgin, Ill. (Central, 286), 12:30-1:30 p. m., Morrison Hotel Terrace Garden noonday orchestra concert; 2-5, baseball scores; 6:30-12, star concert dance program from Morrison Hotel Terrace Garden restaurant.

WTAY, Oak Park, Ill. (Central, Daylight, 283), 6:45-7:45 p. m., bedtime story; tenor; orchestra.

WWJ, Detroit, Mich. (Eastern, 517), 9:30 a. m., talk, women's editor, Detroit News; 9:45, Fred Shaw, pianist and songster; 12 m., Detroit News orchestra; 3 p. m., Detroit News orchestra; 8:30, Detroit News orchestra.

Amateur Operators Form New Division

Entire Second District Secure Their Own Traffic Organization

NEW YORK.—The Second District Radio council has just been advised by the A. R. R. L. that its efforts to have a separate traffic division to comprise the entire second Radio district have been officially approved at a recent Board of Directors meeting of the league. This announcement is the culmination of several months of parleying and work by the council on behalf of the amateurs of the Second District which it represents, to secure their own traffic and league organization.

Heretofore, the second district was a part of the Atlantic division and had no official vote in A. R. R. L. amateurs. With the formation of the new division, however, amateurs of this district will have full sway in their new division. The name "Hudson Division" has been officially designated for this new division, which will go into operation on the 1st of September. This is the first time since the organization of the league that such a change in geographical division formations has been undertaken. Candidates for the new division manager will be announced at a later date.

Rene Mesny Stops Study of Short Waves for Time

PARIS.—Commandant Rene Mesny, French scientist of the military Radio staff who brought fame upon himself last year by the development of Radiophony on waves 1½ to 2 meters long, has announced that he will do no further work on the short waves till fall or winter. Delays in construction of apparatus and the pressure of other experiments have necessitated stopping the work temporarily. He hopes soon to resume his interesting studies of short wave propagation and to extend them to even shorter wave lengths.

Arrest Canadian Fan for Issuing License

Impersonates Government Inspector and Sells Apparatus

OTTAWA.—What probably constitutes the first arrest in connection with the Radio licenses being issued by the Radio branch of the Department of Marine and Fisheries took place a few days ago in Toronto, when R. N. Hederson, giving his address as 492 Euclid avenue, was taken into custody at a residence on Ontario street in Toronto on the charge of issuing fraudulent Radio licenses and collecting fees therefor.

The sentence was six months, which was imposed by Magistrate Watt in Guelph, Ontario. For some time, it is said by officials of the Radio branch, Hederson had been visiting homes in Toronto and adjacent cities, representing himself as a government inspector, and not only selling Radio licenses, but also apparatus, on which he collected a deposit, promising delivery later. His activities soon came to the notice of the Radio branch, and Dominion police were put on his trail.

IHT and IDO, Italian, Working on Short Waves

ROME.—The tests of waves in the neighborhood of 100 meters now being prosecuted so actively in several European countries, have now been begun in Italy. Station IDO, here, and Station IHT, on the coast a short distance from here, will exchange signals nightly from 10:00 p. m. to after midnight, Rome time. IDO will use 117 meters and IHT will work on 106 meters.

In addition to these tests, the well-known Italian amateur, IMT, expects to begin tests again on a wave length of 100 meters. As soon as weather conditions improve for transatlantic transmission, it is expected that some of these short wave Italian stations will be heard by American amateurs.

Every Home Needs this Set

Equipped with the NEW \$1.00 Genuine Miller-B-Metal Semi-Fixed Crystal

Special \$1.79 Complete

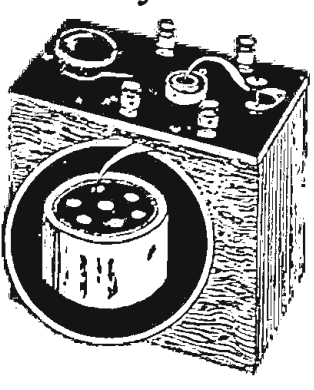

Even if you own a super-heterodyne you need this wonderful little set. It doesn't get out of order and you have a fixed definite contact on the famous, loud-talking, Miller-B-Metal all the time. Save your battery—use this set for local work—it's just as enjoyable. Ample volume up to 600 meters. Money order or C. O. D.—Send today. JOBBERS—DEALERS While these sets last they offer a wonderful opportunity to introduce this new \$1.00 Miller-B-Metal Crystal. It is the finest kind of merchandise.

The A. H. Miller Radio Co. 1222 20th St. DETROIT, MICH.

The "Goode" Two-o-One



Le Ton d'argent

Guaranteed



BY MAIL ONLY \$2.39 Postpaid

QUARTER AMPERE AMPLIFIER-DETECTOR RADIO TUBE

GUARANTEED SATISFACTORY

All "GOODE" Tubes Sold Direct to the Consumer—No Dealer Profits

ONE—"Goode" Detector-Amplifier..... \$2.39 THREE—"Goode" Detector-Amplifiers..... 6.42 (All postage prepaid)

The "Goode" Two-o-One A Tube amplifies or detects. It is a quarter ampere, five volts, standard base silvered tube. Send express or postal money order or New York draft to—

The Goode Tube Corporation Incorporated OWENSBORO - - KENTUCKY

**\$13.90**

**RADIO "A" & "B" STORAGE BATTERIES**

Highest grade Radio Material now offered to the consumer for the first time at factory prices. Buy direct from us. Pocket the dealer's profit. Send your order in today.

"A" Battery, 6 Volt Full 100 amp. hr. capacity. Made for radio work. Has handy carrying handle. **\$13.90**

"B" Batteries, Glass jars—not test tubes. Heavy plates. Large acid circulation. Made in two 24 volt sizes.

"B" Battery Jr. 1750 M. A. H. (1½ amp. hr.) Size 4"x11"x5½". Price **\$3.60**

"B" Battery Sr. 2250 M. A. H. (2¼ amp. hr.) Dimensions 4¼"x13½"x6". Price **\$4.75**

**Special Offer!** 10% discount allowed on orders for \$15.00 or more.

Send 25% of price with order, balance C. O. D. All prices F. O. B. Cleveland. This is your opportunity to make a big saving on all radio batteries. Send your order today.

Send for Our Radio Circular No. 20

**FOREST CITY SALES CO.**  
1400 West 25th St., Cleveland, Ohio

**24 Volt**

**Coto**  
"Built First to Last"

**"VERY MUCH BETTER THAN YOUR ADVERTISING CLAIMED"**

These words from a user's letter are just a sample of nation-wide favor. Wherever your favorite circuit calls for a variometer, Coto Compact Moulded Variometer with the honeycomb wound stator coils is your first choice. Also available for portable sets because of small size.

If your dealer fails you write us, giving his name and address and list of Coto parts you need.

**COTO-COIL CO.**  
87 WILLARD AVE. PROVIDENCE, R. I.

BRANCH OFFICES: Los Angeles, 329 Union League Bldg.; Minneapolis, Geo. F. Darling, 705 Plymouth Bldg.; Atlanta, C. P. Atkinson, Atlanta Tr. Co. Bldg.; Canada, Perkins Elec. Co., Ltd., Montreal, Toronto, Winnipeg.

Range 200 to 600 meters



# 30 Minute A-B-C Lessons for Radio Beginners

## Chapter XXIII—Fixing Up the Radio Set

By P. E. Edelman

**IN THIS** series of articles the story of Radio is told in so simple a manner that the uninitiated can follow theory and practice whether or not he knows anything about electricity or its application to Radiocasting and reception. The series consists of twenty-five chapters, of which the two next will be:

Chapter XXIV—The Radiocast Listener's Brief History.

Chapter XXV—Home Radio.

**REGARDLESS** of the kind of set, a Radio outfit requires upkeep. Even a crystal set requires a crystal replacement or occasional attention to the aerial and ground. Tube sets require replacement of burnt out tubes but the principle thing to watch is the batteries. More complaints about operation are due to run down batteries than most other causes.

Even manufactured sets are sometimes defective, due to wires coming loose during transportation. After checking up connections with the manufacturer's instructions, the first thing to do when the set refuses to work is to see if the filaments of the tubes light when the rheostats are turned on, then to check if there is plate current flowing from the B battery. The presumption is favorable that a manufactured set is O. K., so do not start to "rip the works" open until you are sure there is a defect. Many a set has been found O. K. when the wrongly connected B battery is connected properly with positive terminal feeding toward the plate circuit. When the negative wire is wrongly connected to the plate side of the plate circuit, no current flows.

Another point is that to receive the Radiocast programs even with a perfect set with correct connections, you have to tune the circuits by turning the dials to the proper position so that the station Radiocasting can come in.

If a condenser fails to tune a circuit, it may be short circuited. This can be tested with phones in series with the fixed

and movable plates and a small battery. If your coils are home designed, the size may be incorrect to reach the wave length desired with the condenser used. Too long an aerial prevents hearing short wave stations with some sets. If you hear weak signals but are unable to amplify them further with the two stage amplifier, one of the tubes used may not be making good contact with the plate prong of one socket. Imperfect grid contacts are also likely to occur due to faulty construction of tube bases or use of poor socket contacts. Test this point by trying a new tube in the same socket.

### Best Way to Test Batteries

The best way to test a B battery is to use a voltmeter. If this instrument is not available, a five watt 110 volt lamp can be briefly connected across each B battery unit and it should light up if the battery is O. K. If it does not light, the battery may have a little service left, as this can be determined by connecting a loud speaker across it. A loud click should result. Even the smallest B battery can light a 10 watt 110 volt lamp to a dull red, when fresh. If the filaments of your tubes appear to be lighted O. K., but the loud speaker volume drops way off, it is time to test the B batteries.

Failure of the A battery will usually show by the filaments lighting faintly if at all. If you are using dry cells, it is time for renewals. It may be that the filaments have been left burning over night, or several days, as it is easy to forget to turn the battery current off when through using the set.

It is not good to let a storage battery run down too far as the plates may be damaged. If you use a charger, throwing the switch for an overnight charge once or twice a week, with an occasional addition of distilled water to cells to make up for evaporation, should keep the battery O. K. at all times. Storage batteries are now little used for filament lighting on one tube sets, but are preferable for multi-tube outfits of certain types.

If you are using a voltmeter for testing, each cell of the storage battery should be able to register from 2 to 2.2 volts if your voltmeter is accurate and the

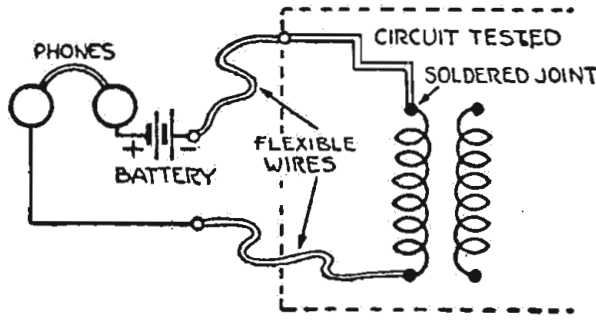

Figure 211

battery is well charged. Any cell on open circuit will usually show voltage so this is not a reliable test.

A dry cell on short circuit test with ameter across its terminals for a brief time will show 20 to 30 amperes when fresh. Dry cells on dealer's shelves sometimes deteriorate whether used or not, and cells which show only 10 to 15 amperes on such test are likely to have short operating life. Don't accept old dry cells.

The fact that a filament of a tube lights is not a true test that it is O. K. A better way is to insert the tube in the socket of an operating set and compare its performance to the tube removed to permit this test. Owing to variations in tube manufacture, one tube may require different rheostat adjustment than another to make this a fair test. Sometimes tubes have bases with contacts which do not make good connection with all the prongs of the socket, but otherwise the tube is O. K. It is not always advisable to pull up a tube socket contact prong to accommodate a faulty tube base.

The main replacement items in a set are thus the batteries and tubes. The other parts of an outfit should have a long operating life as there is little to wear out. Once in a year or so it may be necessary to clean off some of the contacts or wipe away accumulated dust.

### Maintaining Aerial and Ground

It is also advisable to give the aerial and ground the "once over" as contacts may become poor, wires may partially

wear away, or there may be short circuits against a tin gutter, etc. If you use some form of ground clamp, it should be taken off, the contact surfaces cleaned and replaced about twice a year, because such contacts tend to oxidize and take on resistance therefrom.

There is another class of changes which are in the nature of improvements. If you have a single circuit regenerative set, a stage of tuned Radio amplification can be added to cut out reradiation and increase operating range. An audio amplifier can usually be added to any set. A third stage audio amplifier can sometimes be attached to a set where extra loud reproduction is wanted.

### Repairing Phones and Loud Speakers

It is not advisable to attempt any repairs on phones or loud speakers. They seldom get out of order. The connecting cord may break at or near one of the tips, and can be soldered together. If dropped onto the floor, some of the permanent magnetism may be lost. Sensitiveness will also be lost if the diaphragms are bent. Careless handling will once in a year or so cause caps to come loose or break. A safe rule is to leave repairs on headsets and loud speakers to expert repairmen. Do not connect a headset to the output of a power amplifier as this may jar the parts loose. A headset is designed to operate on weak currents, not powerful current changes.

In using phones or loud speakers which do not have the terminal cords marked to show positive and negative leads, it is advisable to try reversing the connections and use the one which gives best response.

### Condensers, Coils and Other Apparatus

Fixed condensers may become short circuited. In some circuits considerable potential is applied to fixed condensers in output circuits. Replacement is the best procedure in case this happens. Without short circuiting, a fixed condenser will sometimes become loose or partially short circuited through a high resistance leakage path, and cause noisy results. If replacement of fresh B battery and clean-

(Continued on page 18)

Hansen "BIRD-CAGE" Radios



4 Tube Radio Set \$32.50  
Without Accessories

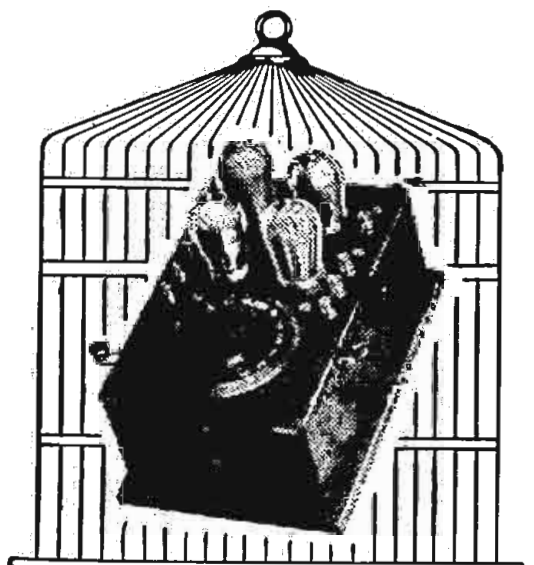

NIGHTINGALE RADIO

A simplified, loud speaking, long range set at a price within the reach of all.

- Hansen BOBOLINK. 2 Tube Reflex..... \$25.00
- Hansen CARDINAL. 3 Tube Reflex..... \$50.00
- Hansen BLUE BIRD. 4 Tube Radio Frequency..... \$57.50
- Hansen MOCKINGBIRD. 6 Tube Long Distance Loop Set..... \$90.00

Write for New Catalogue

Dealers and Jobbers—Our line is interesting and profitable.

**RADIO DEPARTMENT**  
**HANSEN STORAGE CO.**  
"THE MILLION DOLLAR WAREHOUSE CO."  
120-134 JEFFERSON ST., MILWAUKEE  
DISTRICT DISTRIBUTORS

- Badger Radio Co. Milwaukee, Wis.
- Phil Gross Hdw. Co. Milwaukee, Wis.
- Building Mfg. Co. Milwaukee, Wis.
- Maxwell Elec. Co. Toledo, Ohio

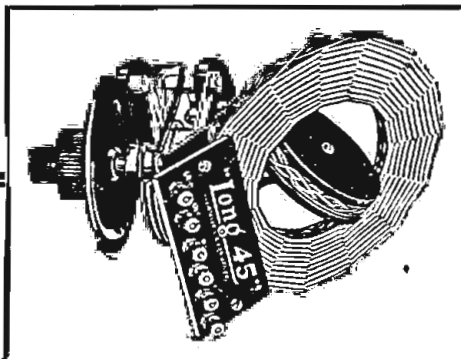

**Lincoln**  
RADIO PRODUCTS

### "Long 45" Tuner Makes a Small Set Equal a Big One

The Lincoln "Long 45" Tuner is a condenser, inductance and tickler coil all in one. Add a socket, rheostat, grid condenser and leak—and you have a wonderfully efficient complete set. No more parts necessary.

Gives your set a coast-to-coast range with a clearness of reception equal to big, expensive sets. Silences interference. Gives greater selectivity and simplifies tuning. Laboratory tested and guaranteed. Sold by your dealer, or if he cannot supply you, order direct giving dealer's name.

Price \$10.00



Write for  
Catalog

Send your name and your dealer's name for free Lincoln Catalog. Shows 6 hook-ups and describes Lincoln Laboratory Tested Products.

Lincoln Radio Corporation  
224 N. Wells St. Chicago, Ill.

The Lincoln Kit—The Lincoln Oscilloscope—Lincoln Collapsible Loops—The Lincoln Low-Loss Condenser

**Lower**  
DIELECTRIC  
**Loss**

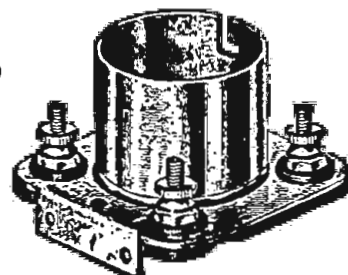

UV 199 or  
Standard base,  
List

**50c**

THAN BAKELITE, FIBRE OR COMPOSITION SOCKETS

**—and Unbreakable!**

If a Walmart Socket ever breaks or fails you in any way, you get a new one free! That's how good they are. No wonder they're standard on leading sets. Over half a million in use. Approved by Radio News Laboratories. Ask your dealer first.

**WALNART**  
SENSIBLE SOCKETS

Bakelite Insulation, Heavy genuine phosphor bronze contact springs; low resistance; high elasticity (to insure perfect contacts). Nickel or dull black enamel finish. For base or panel mounting. Unconditionally guaranteed by world's largest producer of unbreakable sockets. Trial will convince.

"Makers of good goods only"  
**WALNART ELECTRIC MFG. CO.**

Dept. 451 Chicago

*Best Forest  
Parts and Audions  
are as good as  
Forest  
Radio phones*

DE FOREST RADIO TEL. & TEL. CO., Dept. R. D. 12, Jersey City, N. J.



# Radio Digest

PROGRAMS  
Illustrated

Published by the Radio Digest Publishing Company, Inc.  
510 North Dearborn Street  
Telephone: State 4372, 4373, 4374, 4375  
Chicago, Illinois

E. C. RAYNER, Publisher  
Evans E. Plummer.....Managing Editor  
Charles F. Smisor.....Editor  
Harry J. Marx.....Technical Editor

Eastern Office, 611-12 Times Bldg., Times Sq., New York;  
Telephone Bryant 4909, 10462

Member of the Audit Bureau of Circulations

58  
PUBLISHED WEEKLY

#### SUBSCRIPTION RATES

Yearly in U. S. and Possessions and Canada, \$5.00  
Foreign postage, \$1.00 additional. Single copies, 10 cents.

Vol. X Chicago, Saturday, September 6, 1924 No. 9

## Boost Home Talent

**Choosing a Program of Merit Rather Than Distance**  
DISTANCE is beginning to lose its enchantment for the Radio enthusiast. The great American listening public has come to accept Radio as an indispensable service in the home rather than an experimental novelty which depended for its interest on long distance "stunts." The question no longer is "How far can I reach?" but "What program shall I hear?"

Many a Radiophan has discovered for the first time that in his efforts to sweep distant fields he had been missing real joys of Radio reception. The enthusiast now realizes that in many cases the best entertainment, the most interesting news features, were being Radiocast from a nearby station within easy and effective range, while he, with his ears fixed for distance, had been deaf to the true appeal that Radio made.

Radio listeners in many parts of the United States are becoming fervent "rooters" for their home town talent, and many interesting factors are likely to develop from this movement.

The encouragement thus lent to local talent should result in a great improvement of program matter. The general practice of choosing a program upon merit rather than upon distance would solve some of the serious problems of interference now experienced in the air.

## Deaf Persons Hear Again

### Use of Ear Muscles Causes Them to Function

NEARLY everyone knows that the invention of the telephone was more or less of an accident—that it was the result of efforts by Alexander Graham Bell to make an instrument by which his wife, who was deaf, could hear. It was during these experiments that he made the instrument by which revolutionized communication throughout the world.

It is not so generally realized that deaf persons, in many instances, can hear better over the Radio, and that this new art of communication is proving a real boon to the deaf.

This is due largely to recent remarkable advances in the art of Radiocasting music and the voice, and to the fact in receiving sets where there is amplification without distortion, the quality and volume of sound makes it possible for many deaf persons, who do not readily hear ordinary conversation, to hear and understand over the Radio.

## Radio Makes Them Over

### Habits of Man Changes When He Takes Up New Science

RADIO does a lot of different things to different people. A few years ago if you had told the average man that he could build a Radio set he would have looked at you blanklike and said, "Yes! Maybe I can build an automobile or an airship, too." But today they are building them and making sets that give as good and sometimes better results than some of those "ready built" ones.

And another thing that Radio does. Some men who have not been at home evenings for a long time do not go out after dinner any more. Try and get them away from the living room and its easy chair, the old briar pipe and listening to station PDQ—or from the corner of the kitchen where they are working out a new hook-up for their set.

## Advancement of Radio

### Much Development in a Short Time

NO ONE believes that Radio and Radiocasting will remain stationary. The remarkable advances which have been made in the last few years indicate a continued rapid development. The service which Radio now renders to the farmer and to all that portion of the population in outlying districts is invaluable, but it can be made an even greater factor by further improvement.

## RADIO INDI-GEST

### News Bulletins from Milwaukee Furnished in Co-operation with the Milwaukee Daily Beverage

Dear Indi: Ate too much yeast last night before going to bed and had a terrible dream. I dreamt that Overseer Revolver had taken over KYW and with reform in view put on the following program:  
Organ Offertory—Grape Juice—by Brother Welch.  
Vocal Solo—It Ain't Goin' to Rain No More—by Noah and his Arc Syncopators.  
Anthem—Ivory Soap—by the White Robed Quire.  
Ukulele Reverie—Rocked in the Cradle of the Deep—by Bobby and His Underseas Uke.  
Three Hour Sermon on the Text: "And Moses lifted up his eyes and said, 'Yea, verily, we have a paucity of bananas.'" by the Overseer himself.  
Musical Offering—It Ain't Goin' to Rain No More—by the Prophet Elijah and the Children's Chorus.  
Cookery Lecture—How to Feed 10,000 with Two Loaves and Five Fishes—by Mrs. Peterson.  
Hymn by the Congregation—Lead Kindly Light—by Special Permission of the Society of Authors, Composers and Publishers.  
Orchestra Selection—It Ain't Goin' to Rain No More—by the Dead Sea Six.  
News Bulletin by the World Crier—Israelites Cross Red Sea on Way to Chicago.  
Concluding Hymns—  
"A" number—It Ain't Goin' to Rain No More—by Judas Iscariot.  
"B" number—Praise the Westinghouse Electric and Manufacturing company, from which All Blessings Flow.  
Gosh, warn't that an awful dream?  
Officer Widlock will now Radiocast—She wouldn't do what I asked her to, so I socked her in the Jaw. Miss Duncan at the piano.  
THE THIRD TROMBONE PLAYER.

## Mrs. Partington Speaks Out



Dear Indi: Mizz Partington says she listened at Mr. Davis and President Coolidge when they got their Radio receptions of the big conventions verified and learned for certain that their logs of the ballots roll calls was correct like they got it on their sets. One thing neither of them knows yet, she says, is which one gets to string his antenna from the White House roof, early next spring.

Both candidates made a lecture stating they was willing to serve the people by going through a campaign.

Mr. Davis had a big outdoor crowd at his house in Clarksburg, the place he runs from, but it rained and he got his front yard all tromped up into mud, which made him kinda mad at the Republicans; so he threw some of the mud at them, which tickled the crowd and a good time was had by all. Mr. WEAFF McNamee was there and he announced that some of the people was wet, but he didn't mean what Al. Smith does by wet voters. Mr. Coolidge had his surprise party in a dry place, where he had room for the Marine Band, the delegation from A to Z and a lot of other folks.

There was a cheer leader who must have took his degrees from Alma Mater University Stadium and then a posted college course by Radio, besides listening in some to the mob scenes to Madison's Garden, along back in July. Mr. Coolidge only talked for an hour and fifteen minutes so didn't have time to mention any of the opposition parties, nor to throw any bouquets or pop bottles at them. Mr. McNamee was at his party, too, and he told us it was a very pleasant social occasion, he judged, from the cheering. SIGNING OFF.

## "A Small Town's Lament!"

The town we live in ain't like what it used to was at all, Somehow since Radio has come, it don't seem quite as small.

They used to call us "tank town hicks," just laugh out loud and say, "Why, you don't know 'til Christmas what is happening today."

But things have changed a bit, I guess, and everybody knows, We hear the doings of the world, right on our Radios.

He who laughs last is foolish and he shouldn't wait so long, So goes the saying, but today this proverb would be wrong.

Our small town now is just as big as New York, if you choose, Because our little Radios brings us the latest news. BURT B. BARSOOK.

## Storage Bats Are Hard on the Carpet, Too

The boy stood on his burning neck,  
Whence all but he had fled.  
His feet were on the nearby wall  
And he was on his head.

He'd tried to scratch his itching neck  
With acid on his nail,  
So it had turned both red and white  
While he had turned quite pale.

The moral of this tale, dear folks,  
Is plain to any boob:  
The only kind of bulb to use  
Is a peanut dry cell tube.\*

\* Mfg'rs. please note. All advertising rights reserved and in all foreign countries and Hoboken. 5XV.

## Putting It Across

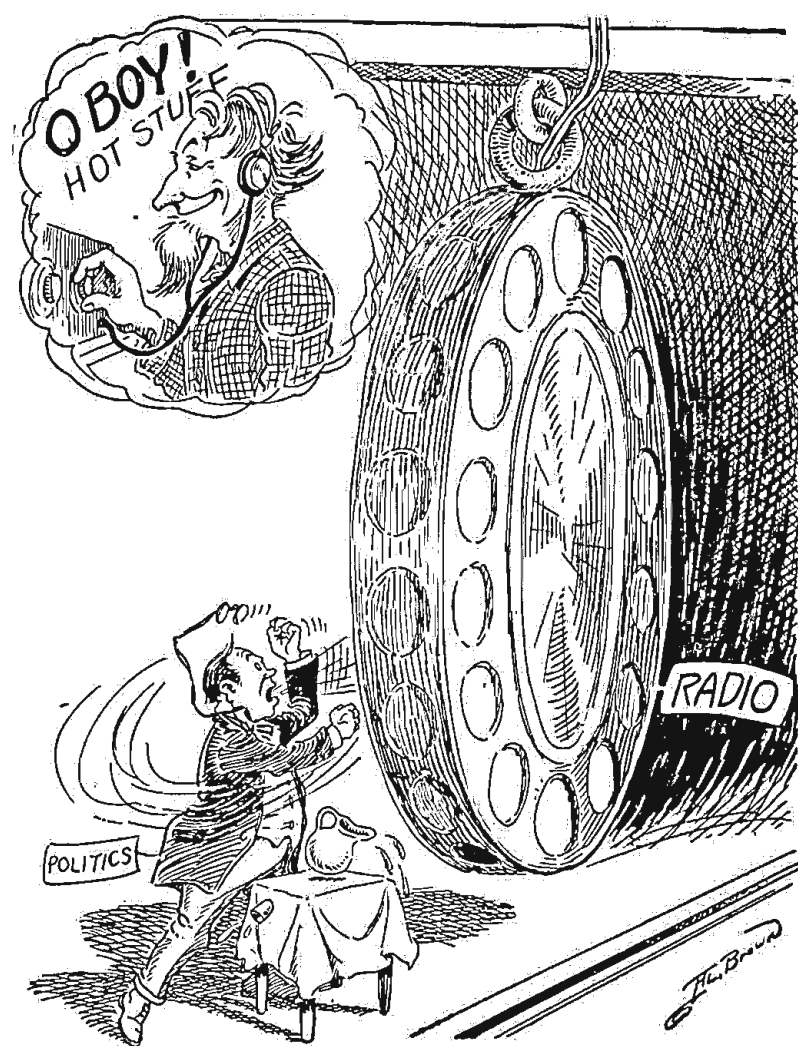

## Condensed

By DIELECTRIC

Politicians, propagandists, aspiring artists and others are only too thankful for Radio's efficacy in reaching thousands of people to whom they feel their's is a distinct message. That the very fact of widespread dissemination might be a detriment, or worse, lead to serious consequences, would hardly enter the mind of the average individual. When jurymen may tune in speeches bearing on the points in a case presented before them, with the reasonable possibility of having their decision influenced to some degree thereby, it is easy to see the direct application of this sinister phase. Senator Walsh is said to have Radiocast expressions regarding the oil case appearing before a grand jury as to prejudice members thereof who might be listening to him. Here is a new angle to the question of censure.

However much of importance may be attached to the various new applications of Radiocasting only the maturer judgment should decide. For instance, recently a test was made of conveying a message from the ground to an aviator flying a mile above New York city, at the same time allowing the entire body of Radiophans capable of tuning in on it a chance to hear the conversation. Operating with a new type Signal Corps transmitter developed by the General Electric company and tried out at Camp Vail, N. J., using about 50 watts, a plane from Mitchel field held a conversation with experimenters on the field, both using a wave length of 330 meters. They were heard perfectly by many listeners tuned to Station WJZ on 455 meters. The roaring of the motor made itself evident when the observer addressed the group below, but did not drown him out.

When John W. Davis spoke through a microphone at Clarksburg, W. Va., you could almost hear the drenching rain which accompanied most of the ceremony, so well was the transmitting controlled. Both then, and later when President Coolidge addressed his countrymen, the effectiveness of Radio as a medium of reaching the mass of American citizens was profoundly evidenced, and the whole procedure indicates the new method of political campaigning in this country. It is devoutly to be hoped that much of old-time verbosity will vanish with the necessity of meeting the requirements of voters at their dials. It may be patently discourteous to leave a meeting, but no one knows when you swing to other stations.

Events of historical interest reach a majority of men and women with more than ordinary appeal, which makes of Radiocasting such a widely popular occurrence. England sensed this when it gave to the whole of Europe the privilege to attend by Radio the ceremonies of consecration attendant upon their bestowal upon the Liverpool cathedral. It was in the thirteenth century that England last consecrated a cathedral, and what a small proportion of interested folks could be present then!

Sporting events of almost every nature have been presented to a countless host whose presence at many of them was out of the question. Just the other day fans who are interested in the speeding equines were given a thrill as they listened to Major White's description of the first of the international races at Belmont Park. You could fairly see the crouching jockeys, as well as follow the brilliant strokes of our foremost women tennis players as their court strategy was described several weeks ago through Station WEAFF. Thus do we sports-lovers benefit.



# Neutralizing the Super-Regenerator Circuit

## Part III—Complete Instructions for Wiring and Tuning

By C. E. Butterfield

OUTSIDE of the mounting kinks just described the assembly of the remainder of the instruments is an easy matter. The two audio transformers should be screwed to the baseboard at the positions indicated in the layout, being at right angles to each other. The sockets are then fastened as indicated, the grid and plate connections being placed farthest from the panel. Two bakelite strips for binding post connections are needed. One should be 1 by 2 inches and the other 1 by 6 inches. The smaller is for the aerial and ground connections, which are to be brought in from the back of the cabinet as are those for the batteries. On the longer strip six holes for binding posts should be bored and on the shorter strip two.

These strips may be screwed to the edge of the baseboard or mounted flat, and as this is left to the choice of the builder no mounting screw holes are indicated. If they are placed flat on the baseboard both strips should be raised about 1/4 inch, so that the binding post heads and the wiring will not touch the base. The raising can be done by placing a small block of wood under each end, using screws long enough to obtain a firm grip on the baseboard. The A negative and the B negative go to the same binding post.

Lastly the two neutralizing condensers are placed in position. These should be of the base mounting type. However, the writer suggests that the neutralizers be left off the baseboard until the wiring is completed on the remainder of the set, as they can easily be set in then and the wiring finished.

**Hints on Soldering**  
With the electric soldering iron "on the fire," and solder, flux, wire and other needed articles at hand, the builder should now be ready to place his assembled neutralized super in a condition for operation. To begin with, solder every connection possible and some that do not seem possible. Use only sufficient flux to make the solder stick, and wipe off any remaining after a connection is completed. If the condensers you buy do not have pigtail connections, put some on. And in addition solder the contact springs on the bottom of the sockets to the bolts used for binding post connectors. Going at the panel connections first, a wire is run from S 1 to each of the rheostats except that for the detector, completing the negative side of the filament circuit. The detector rheostat is placed in the positive side of this circuit. Any other connections that the builder thinks he can make to advantage on the panel instruments should now be completed. The same is true of any connections that can be made separately on the baseboard. With this step completed, the panel and baseboard are screwed together and the wire procedure continued. If the builder thinks he can do a better job, he may remove the Radio frequency

transformers from the condensers, until he completes the positive side of the filament circuit, which should be done next, and make other connections. After finishing the filament circuit, both positive and negative, not forgetting the necessary connections to the other two switches, he can go ahead in the manner he thinks best. Each builder has his own method of wiring, and outside of a few hints, the writer believes that the assembly of words to explain how it can be done a certain way is a useless procedure. So go to it.

**Several Precautions to Follow**  
However, several precautions should be followed. The rotors of the three tuning condensers should be connected to the negative lead and the stator to the grid circuits.

The .006 mfd condenser, if the proper one is purchased, either can be soldered to the wiring at the proper place, or it can be mounted on two switch points, the heads of which should be soldered to the wiring.

Spaghetti, did you say? Don't use it, unless you desire the set to function at a loss. It's unnecessary, and makes an unsightly job. Besides if the proper care is taken in the placing of the wiring, it will only be a waste of time to put it on. While right angle bends may be used, the builder is advised to get between connections in the shortest possible way. A neat job can thus be done without making the current that is to go through the set chase itself tired hurtling around right angle bends, etc., to go to the same distance that a straightway connection would provide. Connections to the feedback coil should be so placed that they can be easily changed when the set is given the preliminary tests. Positive feedback here can easily be recognized, and it's only the reversed connections that hold the detector in balance. Of course, some of the connections must necessarily be made in close quarters, and a few fingers may be scorched in the operation. Don't let a little thing like that worry you. You'll be repaid in the end.

**Locating Grid and Plate Leads**  
Both the grid and the plate leads should be made as short as possible and that between the grid leak and the detector socket shorter than that. As a matter of fact the same holds true throughout the circuit, for the shorter each individual wire, the better the set will function.

Mention was made in the list of parts of mechanical verniers for the tuning condensers. Of course these can be elimi-

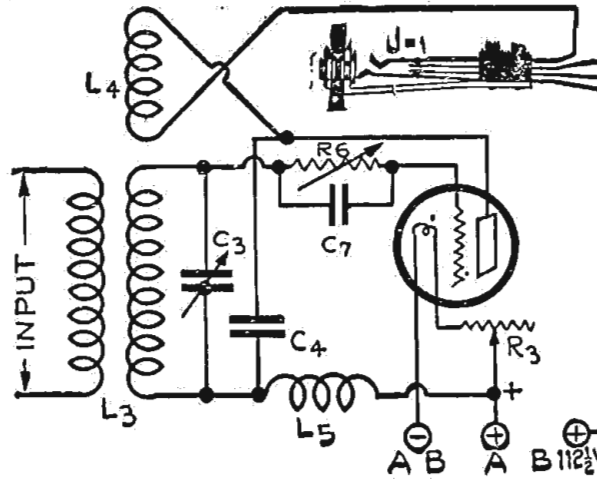

In the illustration L3 is a 4 to 1 air core transformer; L4 is a 50 turn honeycomb; L5 is a 1250 turn honeycomb; C3 is a .000396 mfd. variable condenser; C4 is a .006 mfd. mica condenser; C7 is a .00025 mfd. mica condenser; R3 is the rheostat and R6 is the grid leak.

nated, but they will be a great aid in the operation of the set in bringing in a long distant station. Condensers with an extra vernier plate are not recommended.

Now with the wiring of the set practically completed, the neutralizing condensers should be placed on the baseboard if they were left off, and the neutralizing circuit completed. The first test should be that of the filament circuit. Plug in the phones in the last jack, and insert a tube in each socket. Now connect a six volt battery to the A battery binding posts but leave off the B battery. The tubes should not light after adjusting each rheostat. Leaving the A negative connected and the tubes turned on, disconnect the A positive wire and touch it to the positive B battery binding posts. If the tubes do not light, the B battery circuit is not shorted across the filament leads. Probably here is a good place to hesitate and inquire if you purchased good rheostats. There are several good ones on the market, but those of a precision type will be the best, as they give the vernier adjustment. However, if wire rheostats are used that for the detector must be a

vernier, as this tube requires a close adjustment of its filament current.

Another thing that should be again impressed on the mind of the builder is that while a single rheostat might be used to control both the Radio and audio amplifiers, each tube will be found to vary slightly as to the proper operating temperature of its filament. The five rheostat controls are not unsightly and when once adjusted, may only be touched occasionally to regulate the voltage as the capacity of the battery drops. Now then the set builder after the preliminary test heretofore mentioned, should be ready for next week's Radio Digest which will contain an explanation of the adjustment and tuning. By the way, you didn't leave the dials off the tuning condenser shafts, did you?

### Preliminary Adjustments

Before the neutralized super can be considered to be operating properly a number of preliminary adjustments are necessary. Of course the most important are the neutralization of the Radio frequency circuit and the reversing if necessary of the connections of the negative feedback coil in the detector circuit.

With the aerial and ground connected and with the tubes turned up to the proper brilliancy and the headphones plugged in on the detector jack, an attempt should be made to bring in a station. If on turning the condenser controls, the thud or click of excessive regeneration is heard, connections on the regeneration coil have been made so that positive and not negative feedback is being obtained. Then these connections must be reversed. If they are not it will be impossible to control the regeneration and no satisfactory reception can be obtained. With the proper connections now made to the feedback coil, attention next must be paid to the Radio frequency circuit. Neutralization can best be obtained with a separate oscillator, but as most Radio bugs do not own such an animal, the next best method is that of a powerful local broadcaster. A speech is the best for this purpose for as a rule the speaker's voice does not vary in volume as does music. With the station tuned in to its loudest

(Continued on page 18)

## BEWARE of Imitations!

The UNCLE SAM MASTER TUNING COIL is the original 3-circuit tuner. Demand only the genuine if you want VOLUME, DISTANCE, SELECTIVITY.

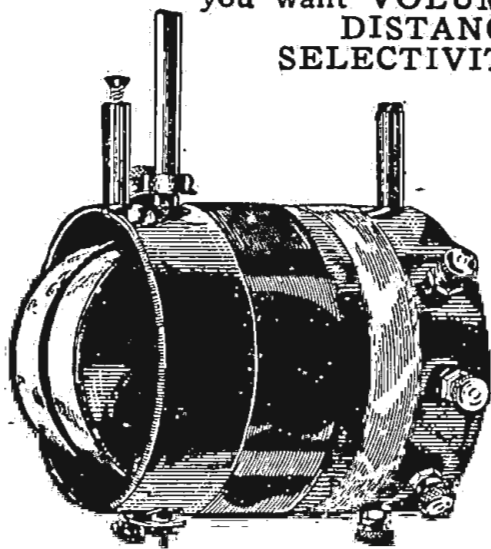

### UNCLE SAM MASTER TUNING COIL

Verifications from satisfied users prove conclusively such DX Reception as Philadelphia to KFAE (Pullman, Wash.), Ardmore, Pa. to WKAQ (Porto Rico), Trenton, N. J. to KHJ (Los Angeles). And as to selectivity, a committee of engineers in Philadelphia clearly heard 49 different stations sign off in 8 1/2 hours on the air.

The only licensed all Litz Tuner  
**Only \$5.50**  
At all good dealers

Ask your dealer or send self-addressed, stamped envelope for FREE wiring diagrams of circuits using this coil.

**UNCLE SAM ELECTRIC CO.**  
217 E. 6th St. Plainfield, N. J.

# Your Choice

## FREE

Limited Supply

# 65 Copies

### SERVING AS A RADIO REFERENCE LIBRARY

You receive 52 issues with your subscription and 13 issues in each bound volume

Bound volumes 5, 8 and 9 are now ready for immediate shipment. The supply of bound volumes 1, 2, 3, 4, 6 and 7 is exhausted. This offer good only in United States and Canada.

To receive a bound volume free with a year's subscription it is necessary for your subscription to come to us direct with full remittance price.

We cannot extend this offer for subscriptions received through dealers or subscription agencies.

Make your remittance by check, money order or draft.

Your prompt action gives you one bound volume with each annual subscription, new or renewal.

Greatest collection Radio information.

A-B-C lessons for Radio beginners, 2, 3 and 4 tube reflex circuits. The famous Milopez with various hook-ups. Reinartz long distance circuits—ultra Reinartz-Flewelling popular "Flivver" circuit. Single tube reflex circuits—super-heterodyne. 5-tube neutrodyne. Special R. D. hook-ups.

Valuable Question and Answer Department.

Department on How to Install and Operate sets.

In addition to these features the current issues give you all the live news in Radio; advance Radiocasting station programs and a correct and authoritative list of all Radiocasting stations licensed. The first and last word in Radio.

Today Is Your Radio Day

RADIO DIGEST, 510 N. Dearborn St., Chicago  
Check Offer Desired

- One year's subscription, and choice of one volume. Send Vol. .... Enclose.....\$5.00
  - One year's subscription, and choice of two volumes. Send Vols. .... Enclose..... 7.00
- Additional Bound Volumes at \$2.00 each.

Name .....

Address .....

City..... State.....

**75c**  
"worth it"

## Poly Plug

Eliminates every inconvenience so annoying in the operation of the unsatisfactory screw type plug.

There is no necessity to take Poly Plug apart, no screws to tighten, and what's even more important, positive contact is always maintained.

A wonderful feature of the Poly Plug is the tension slot, allowing the phone cords to be pulled and jarred without disturbing the contact.

At your dealers or sent postpaid on receipt of purchase price.

**POLYMET MFG. CORP.**  
70-74 Lafayette Street  
New York City



### REAL HONEYCOMB COIL HOOK-UP

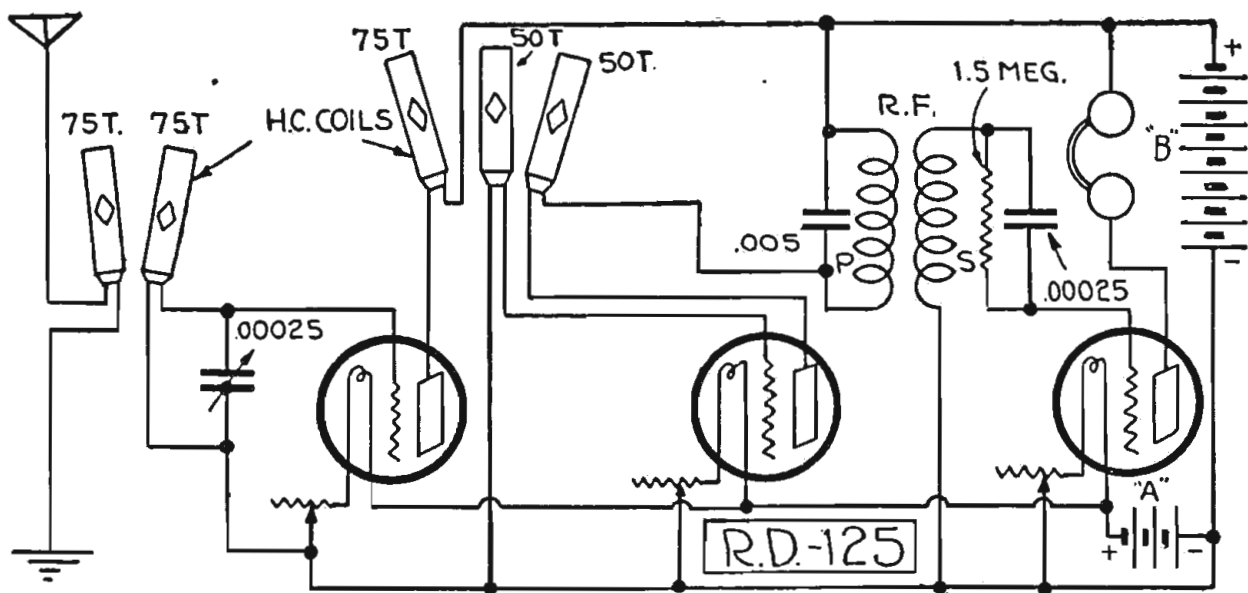

EVERY once in a while we like to give some English hook-ups—just to show you what they are doing "over there."

The circuit shown, R. D.-125, has two stages of Radio frequency amplification with a detector. No audio frequency stages are indicated as their use is optional, and can be added in the usual manner.

The value of the various parts are indicated in the diagram. The B battery voltage should be 45, as A tubes are recommended for all stages.

The coupling on the two sets of honeycomb coils should be variable.

### THIRTY-MINUTE A-B-C

(Continued from page 15)

ing of tube socket contacts does not stop the noise, a fixed condenser may be the trouble. If solder flux is left around a fixed condenser joint, there may be a resistance leak formed thereby. Variable condensers will sometimes accumulate dust enough to provide a leakage between the plates. Care must be used in cleaning the plates, as they must not be bent. There are thin cleaning brushes available for this purpose.

Heat changes will sometimes loosen the windings of coils, variometers and other apparatus. A varnish made by dissolving celluloid strip in acetone can be used to refasten loose windings.

#### Locating Short Circuits

Another trouble found in some sets is caused by one or more bus wires loosely touching others or coming loose during use, to form short or open circuits. Loose wires can be found by carefully moving each bus wire gently with the fingers. A wire just resting on a contact instead of being fast soldered will then come loose, and can be resoldered. Battery connections or the wire to the binding posts of the set may work loose and cause trouble, so it is advisable to look these over when the set does not work up to mark.

In changing over from storage battery operation to dry cell tubes, especially if you use tubes like UV-199, employing adapters, there is a chance that the adapters will make poor contacts in the tube sockets, so this must be checked. Owing to small current consumption such tubes have higher resistance and require more resistance in the controlling rheostat. It is important to use the right value of rheostat resistance. Another point in changing to dry cell tubes is that a C battery may be needed unless you reduce the plate voltage formerly used on the storage battery operated tubes.

#### Crystal and Reflex Sets

In crystal sets or reflex sets using crystal detectors, the crystal may require either cleaning or replacement from time to time. To clean a crystal, wipe it vigorously with cotton gauze dipped in alcohol, carbona, or energine and do not touch with the fingers. Trim off the point of the contact wire. Sometimes scraping with a sharp knife will restore a sensitive crystal surface.

Once in a while a transformer will go bad, usually because the fine wire breaks at or near on the terminals or because a binding post becomes loose. The transformer circuits can be tested with phones in series with the battery. There should be no connection or short between the primary and the secondary windings. In the case of Radio transformers, it is possible that a direct short circuit of the plate battery may be able to burn out the fine wire of one winding.

Do not confuse common faults with unusual breaks, short circuits, etc. Usually it is not necessary to tear apart any well built set, as trouble will be found in battery and tube connections as herein pointed out.

(In the next issue, Mr. Edelman will give a brief history of broadcasting, what is to come in Radio, and everyday problems of the listener.—Editor's note.)

### NEUTRALIZING SUPER

(Continued from page 17)

point, the first tube rheostat should be turned down until the filament is cold. Then a slight readjustment is made of the tuning controls to bring the signal to its maximum point. Now with this accomplished, the first neutralizing condenser is adjusted until the voice either fades out, or is at its lowest point. Relighting the tube the station should resume its maximum volume. The same test is made on the second tube, the neutralizer of which is adjusted in a similar manner. It will be found that this neutralizer will not entirely wipe out the signal, but it should be brought to its lowest point. With this done, the audio stages should be tried out.

In the tuning of the set, the builder should first experiment on local stations, which will be easy to find. He will quickly learn that the second control should be several points ahead of the first in relation to the numbers on the dial, while the third control is not at all critical. This dial can be left at almost any position in the locating of a local station, but when the Radiocaster has been brought in to maximum on the first two controls, this third dial should be adjusted to give the loudest signal. On the final adjustment, the reading of the third dial will be practically that of the first, with the second advanced several degrees over the other two.

In tuning for distance the same procedure is followed except that much closer adjustment must be made and the third control kept within at least ten points of the other two. While no control is necessary for the regeneration, a big factor in its regulation will be found to be the detector rheostat. The filament of this tube although it is a hard valve is critical. If turned too high, the signal will weaken considerably, and if turned too low oscillation will start in the detector circuit and distortion and a weakened signal result. Of course this oscillation does not reach the antenna, because the one way valve action of the Radio frequency amplifiers prevents it from doing so. As a result the set, with the proper neutralizing adjustments have been made to prevent oscillation in the Radio frequency circuit, will not re-radiate.

It will be found that except for the detector rheostat control, tuning of the set is very similar to that of the ordinary neutrodyne, and stations can always be found at the same adjustments. Regulation of the rheostat, as in most regenerative sets, has little effect on locals, but its real necessity is quickly noted when a distant station is located. In fact a DXer can sometimes be knocked out by making the detector filament current too high.

If you followed instructions and bought a proper grid leak, which should be of the same precision type as the rheostats, its adjustments will be a simple matter. If you didn't you'll wish you had. The grid leak resistance should be brought to just below the point where a thud is heard in the phones and the signal at once weakens. This adjustment can best be made on a distant Radiocaster, as local signals are usually so strong that they come through at almost any point of the grid leak, except where the resistance is made too high.

Now a few words in regard to the aerial system. The aerial should be of a single wire not over 100 feet long. One with a length of about 75 feet will be the best, as then the set will tune sharper. While the receiver will function to a certain extent on an aerial alone, a good ground is necessary for maximum service. It should be soldered securely to a water pipe or a radiator, with the water piping given preference. To bring to the builder's mind again the heart of the circuit, the detector diagram is republished. All of the instruments so placed are there for a purpose and if one is left out the set will not "super neut."

That control of the regeneration is brought about through the negative feedback coil, should have been quickly demonstrated to the builder if he made the

(Continued on page 20)

### RADIO By Mail

#### OUR NEW CATALOGUE

Is the most complete list of RADIO SETS and PARTS ever published and contains hundreds of articles which are used daily and are not sold by many firms.

#### BE CONVINCED

Send 4c for your copy today and let us prove it.

#### TELEOYNE KIT

1-Special tuning coil and E-Special R. E. coupler (Wound with green silk wire on BAKELITE tubing; complete with brackets, etc.) \$6.39

#### COCKADAY PARTS

COILS—Green silk wire on BAKELITE.....\$ 3.19  
LAVITE resistances, 48000-ohms..... .96  
AMPLEX "Grid-densers"..... .89  
AMSCO 28-Plate vernier cond..... 3.59  
Bradley-Ohm (No. 10, No. 25 or No. 50)..... 2.00  
COMO duplex audio transformers (per pair)..... 9.29

#### ULTRAOYNE KIT

Consists of 1-type "A" Ultraformer, 3-type "B" Ultraformers, 1 tuning coil, and 1 oscillator coil (coils silk on BAKELITE).....20.58  
Set of 4-Ultraformers separate.....\$16.76

#### ERLA REFLEX PARTS

ERLA reflex or audio transformers.....\$ 3.89  
ERLA "SELECTOFORMER"..... 3.89  
ERLA Crystal Detector..... .79  
RATHBUN condensers, 11-Plt., \$2.39. 23Plt., 2.79

#### HARKNESS REFLEX KIT

Consists of 1-T1 and 1-T2 special wound transformers mounted on condensers (coils green silk on BAKELITE Tubing).....\$6.79  
Transformer coils separate, per pair.....\$ 2.94

BURGESS large 22½-V "B" Batteries.....\$ 1.89  
BURGESS large 45-V "B" Batteries..... 3.68  
"SUPERDYNE" Special coupler..... 4.89  
"Gold Seal" Homechanger, \$13.22. Valley..... 13.95

#### HAMMARLUND CONDENSERS

Plain, 11-Plt., \$3.78 23-Plt., \$4.19 43-Plt., \$5.04  
Vernier, 11-Plt., \$4.62 23-Plt., \$5.04 43-Plt., \$5.88

Prices F.O.B. St. Louis, Mo., Cash or C.O.D.

SIMPLEX RADIO SALES CO.

1809 Lafayette Ave. Dept. D ST. LOUIS, MO.

LITTLE IN SIZE  
Big in Reproduction Volume,  
Tone Quality and  
Consistent Performance

### PREMIER



Cut ½ Size  
\$3.50  
Audio TRANSFORMER

You'll like its size—you'll like its convenience—and you'll like its performance. "HEGEHOG" is the smallest, lightest transformer made and it is the most efficient. That is why it jumped into immediate favor with Radio Fans. It carries more reproduction volume and has less distortion than any other transformer regardless of size, price or design. It's all in its patented construction. 100% shielded—no foreign noises. Mounts anywhere—saves space in assembly. Don't overlook "Hegehog" in any "hook-up"—portable or regular. Ratios 1 to 3, 1 to 4, 1 to 5—\$3.50. 1 to 10—\$4.50. Send for Bulletin No. 94.

GET "HEGEHOG" AT YOUR DEALERS'  
FREE—Diagrams of the most popular "hook-ups," including Harkness Reflex, Neutrodyne, Super-Heterodyne, Tuned Radio Frequency, Regenerative, etc. Send for them.

Premier Electric Company  
3810 Ravenswood Ave. Chicago

### Dealers Need This

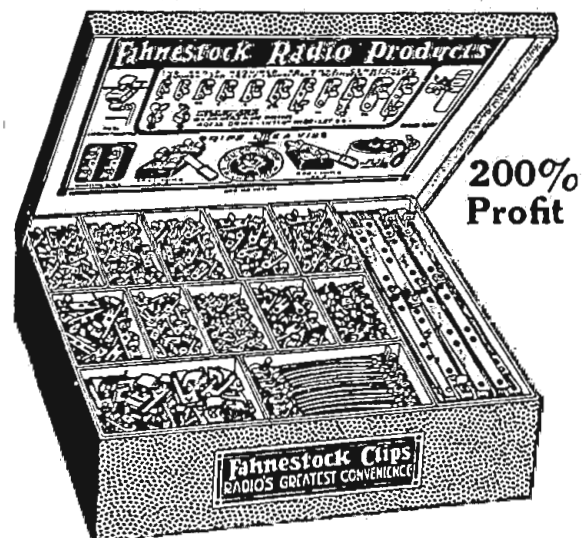

The new FAHNESTOCK Display Case  
Will stimulate your sales of Fahnestock Radio Products. 14 of the most popular styles and sizes are included. Shows the purchaser instantly the correct piece for his set. A constant invitation to buy Fahnestock Products. Dealers are offered 200% profit on each case, an unusual offer on standard merchandise.

Price to Dealer.....\$17.50  
West of Mississippi..... 18.50  
Transportation prepaid when money order or check accompanies order. Subsequent orders at regular price of \$20.00.  
Contents Retail for \$51.50  
Refills will be supplied at the regular 100 lot prices, shown in catalogue, which comes with case, less discount shown on enclosed sheet. Send check or money order, today.  
FAHNESTOCK ELEC. CO.  
LONG ISLAND CITY NEW YORK

### A \$200,000.00 COMPANY STANDS SQUARELY BACK

of EVERY PHONE

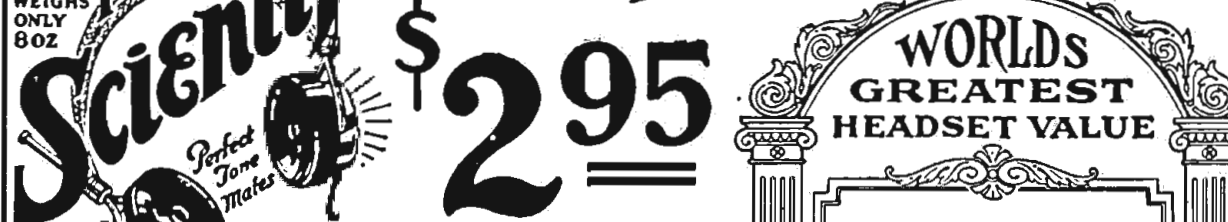

WORLD'S GREATEST HEADSET VALUE  
\$2.95  
Plus a few cents postage  
SEND NO MONEY

Order by mail if your dealer cannot supply you and we will ship immediately. Written 5-day money back Guarantee with each set. Our next year's production schedule of two million phones UNDOUBTEDLY places us as the

WORLD'S LARGEST HEADSET MAKERS  
THE TOWER MFG. CO.  
98 BROOKLINE AVE. BOSTON MASS.



At the Price of an Ordinary Pair of Head Phones

### Complete:

With Specially Built Dietzen Adjustable Loud Speaker Unit and Plug.  
NOT A HEAD SET UNIT

### Special Features:

Absolute non-metallic sound.  
Permanent crystalized finish.  
No batteries necessary.  
Specially constructed adjustable unit with gold plated diaphragm.  
Unconditionally guaranteed for one year from date of purchase against mechanical defects of any kind.

DIETZEN GUARANTEE  
Money back at any time within 10 days of purchase if dissatisfied. Delivered FREE to your door.  
(WE PAY THE POSTAGE)

If your dealer cannot supply you write direct

DIETZEN, INC.  
71 Cortlandt St.  
N. Y. C. New York

Makers of Precision Instruments Since 1889

FREE!  
Dietzen Radio Log Book. Write for yours!

DEALERS! Write for details  
Five-Day Money-Back Guarantee if Not Fully Satisfied. We Guarantee the Scientific to be  
1. One of the finest phones on the market regardless of price.  
2. The most comfortable—weight only 8 oz.  
3. Perfect tone mates.  
4. Made of standard double pole construction (no single pole nonsense to save expense).  
5. Made of the best materials money can buy. Powerful magnets, genuine tinsel cords, aluminum cases.  
6. Manufactured under ideal working conditions.



# Reflex Hook-Up Puts Tone Into Reception

## Aids in Picking Up Long Distance

By W. H. H. Knox

I HAVE been a Radiophan for something over two years, going through the different stages via: single circuit, two circuit, three circuit, four circuit, regenerative, reflex, neutrodyne and heterodyne, and still buy the Digest very religiously every week, with just as much interest as in the beginning.

The advance of Radio, it seems to me, has been almost past believing, until today, the fans at large, seem to have divided themselves into two distinct groups—the DX hounds as they are familiarly known, and the tone bugs, not so well known.

I will have to acknowledge the fact that I belong to the latter class, and this is the reason for this appeal for more attention to this phase of one of the most interesting pastimes introduced into this country.

I have been experimenting for some time with different hook-ups using the crystal detector, and during that time I have been entertained by some of the truest sound reproductions I ever expect to hear. In fact the last hook-up I tried, was so selective and the tones of all instruments were so natural (from the low notes of the oboe to the high pitched notes of the violin) that it positively was uncanny to listen to it.

As mentioned at the start of this article, I began with the single circuit, CR5 hook-up, with which I was able to get Europe, Europe, and Europe, so to speak, but as to tone, well, the only combination that could possibly compete with it, was a good-sized tin-dish-pan and a good husky youngster, with a perfectly good stick, and plenty of good old American "pep" behind said stick. Perhaps you will wonder why I prefer to dig up relics of by-gone days, it is interesting to note that even today sets are being made by amateurs, for their friends (at a good profit) using the old CR5 circuit.

Question of Reflex Circuits  
I have recently read several articles written by well known Radio experts, in

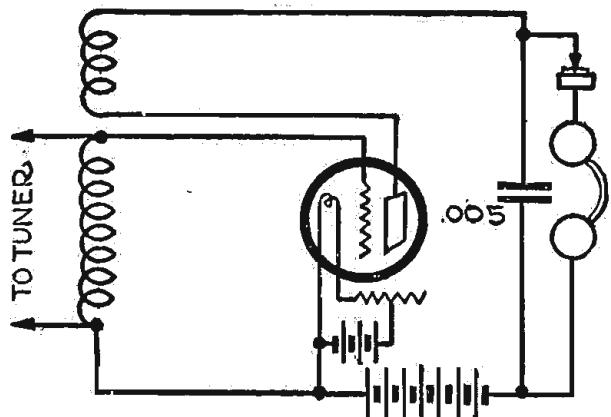

which they declare that in the reflex type of receiver, a soft tube used as a rectifier gave equally as good a tone as when the crystal detector was used, but right here I want to say that I am from Senator Reed's home town, and my middle name is maybe.

Perhaps in the case of the new sodium tube this is true but when the crystal gives equally as good a tone, why go to the expense of buying an extra tube, incurring extra expense for the running of this tube, and getting no better results. In some cases, using a tube rectifier will, I admit, give longer distance, but when you go to this expense why not get a regular tube and add another stage of Radio frequency amplification. This, I am sure, would give you much longer distance reception, and I still believe that the tone would be more pleasing to a real lover of music.

### Regenerative Circuits

Regeneration we all know has done a great deal for Radio, but I have yet to listen to a real regenerative set that could in any way compare, in quality of tone, to a reflex with a crystal detector. Almost every Radio magazine you pick up today contains from one to six or eight diagrams of the un-tuned aerial-regenerative hook-ups. As a DX go-getter, this

little set is indeed the "California-cheese," but when it comes to quality of tone, to me there is very little pleasure in listening to a musical program as reproduced by a set of this kind, when the Radio-casting station is less than 100 miles distance.

I know of a fellow that has made one of these sets, and as he got such wonderful results on DX reception, he proceeded to go around among his friends and as many prospects as he could procure, to demonstrate just what the set would do, and then build a duplicate for them. In this way he has sold quite a number of them, and as a rule the purchaser is satisfied, but, some that have since listened to a reflex set are anything but satisfied, with the result that they seldom use their set, and are "off" Radio for life. This hurts the game.

I have tried this hook-up twice, thinking that perhaps I might do better the second time, but the last one was worse than the first, and after using a reflex for several months, I am of the opinion that I made it seem a lot worse to me. After completing the last one, I listened to the local concerts for about an hour, and became so thoroughly disgusted with the tones, that I tried to think of some way to introduce a crystal into the circuit, and the result follows in the accompanying diagram, that I believe is self-explanatory.

### Two Element Tubes

I have just read an article by the author of a well known reflex circuit, in which he very strongly advocates the use of a two element tube as a rectifier. Perhaps the makers have improved this tube recently, but if not, I cannot see how it can possibly give satisfactory results, as

I tried three different ones some time ago, and found that they were very expensive to use, not lasting well, and not giving the clear round tones that a crystal gives.

One of the outstanding reasons the author of the article gave for using a tube in the place of a crystal was, that in using a crystal a potentiometer could not be used. To me this is one of the best reasons for using a crystal, and I might add that I have a perfectly good potentiometer that I have never been able to use. I have tried faithfully for the past 1½ years to find a place where this would seem to be necessary, but so far have never been able to find a use for it that seemed to be enough improvement to warrant using it. And besides you will find that your A batteries will last very much longer if you do not use one.

### Shielding Dial Backs

Body capacity was my great trouble in experimenting with the various hook-ups, but I eliminated most of it in the following manner: With the hook-ups using a condenser to tune with I found that by shielding the back of the dials with tinfoil and making connections to the rotor shaft my trouble was eliminated. As the rotors are the ground connection the shielding is easily grounded.—Gerald E. Evans, Cuba, Ill.

## Super Crystal

**New Non-Metallic Housing Eliminates Scratches & Squealing**

Wonderful new crystal—has millions of sensitive spots—long life—cannot short circuit.

**FITS ANY STANDARD DETECTOR**  
At your dealer—otherwise send purchase price and you will be supplied postpaid. Ask for reflex circuit 120.

**50** **Chas. Freshman Co. Inc.**  
Radio Condenser Products  
106 Seventh Avenue, New York City

## S. HAMMER RADIO CO.

303 Atkins Ave., Brooklyn, N. Y.

### PHOENIX ULTRADYNE \$24.50

LIST PRICE \$26.00, SPECIAL.....

PHONES	
8.50 N. & K., 4000 ohms.....	\$ 5.85
6.00 Brandes Superior.....	4.70
12.00 Baldwin Type C, Double Original.....	7.85
7.00 Federal.....	4.85
5.50 Stromberg Carlson.....	4.50
12.00 Dr. Seibt 6000 ohms.....	5.75
LOUD SPEAKERS	
30.00 Music Master.....	\$24.00
35.00 Magnavox, New Type.....	28.50
25.00 Baldwin Original.....	21.50
10.00 Brandes Table Talker.....	8.50
Baldwin Unit, Type C, Original.....	4.65
TRANSFORMERS	
7.00 Federal No. 65 or Amertran.....	\$ 5.25
5.00 Acme or All-American.....	3.75
12.50 Como Duplex P. P.....	9.75
12.50 Modern Push-Pull.....	9.75
5.00 Eria, all Types.....	4.15
12.00 All-American P. P.....	9.75
CONDENSERS	
6.00 Hammarlund 23-plate vernier.....	\$ 5.35
5.00 Cardwell 23-plate.....	4.25
5.50 Amco 23-plate vernier, 4-inch dial.....	4.10
4.50 Amco 23-plate vernier.....	3.35
2.50 Amco 23-plate variable.....	1.95
MISCELLANEOUS	
1.00 Amco 6 ohm 0.85.....	Cockaday Coils,
1.25 Amco 20 ohm 1.00.....	Eastern.....\$3.35
1.30 Amco 30 ohm 1.10.....	\$2.00 Reinartz Coil 1.40
Amco Potentiometer.....	Eria Crystals..... .90
400 ohm.....	1.25 Braeh Lightning Ar-
Pathe Phusiformer.....	restors..... 1.75
Ambassador Coils.....	7.95 Genuine Lavite Re-
Cockaday Coils, Pre-	sistance..... 1.10
cision.....	4.50 Amplex Grid Denser .80
	Superdyne Coils..... 4.95

Orders over \$5.00 will be shipped prepaid. Money orders or C. O. D. Not insured unless insurance charges included. Write for Price List.

## Radio Dealers HEADQUARTERS

### EIGHT BIG WAREHOUSES TO SERVE YOU

**DEALERS**  
Write on your letterhead for this big catalog. Ask for A1002

**WAKEM & McLAUGHLIN**  
225 E. ILLINOIS ST. - CHICAGO

## Pfanstiehl

Offers the new low-loss inductances

Carried by the leading jobbers

A low-loss inductance is just as vital as a low-loss condenser.

	Turns	List Price	Wave Length
P-201.....	25	\$.55	100-340
P-202.....	35	.59	125-470
P-203.....	50	.65	170-650
P-204.....	75	.74	220-960
P-205.....	100	.90	300-1300
P-206.....	150	1.10	470-1980
Pfanstiehl Ultra-Audion.....		.95	
Pfanstiehl Reinartz.....		1.75	

Pfanstiehl Tuning Unit, consisting of 2 Spider Web Coils with mechanism for supremely sensitive adjustment..... \$5.00

Pfanstiehl Variometer..... \$4.75

At all good dealers or direct on receipt of purchase price  
**PFANSTIEHL RADIO SERVICE CO.**  
Highland Park, Ill.

# Buy!

The Greatest Value ever offered in a Radio Receiving Set

## FRESHMAN MASTERPIECE

### 5 Tube Tuned Radio Frequency

Ask your Dealer for a demonstration or write for complete literature

\$60

**Chas. Freshman Co. Inc.**  
Radio Condenser Products  
106 Seventh Ave., New York

## MAGNATRON

MAGNATRON DC-199 knows no superior among dry cell tubes. Whether as detector or as amplifier, it will give better results in your set. It and the MAGNATRON DC-201A are unqualifiedly indorsed by experts.

Your dealer has these tubes. They list at \$5.

**CONNWEY ELECTRIC LABORATORIES**  
309 Fifth Avenue NEW YORK CITY

## Bradleyswitch

PERFECT BATTERY SWITCH

Retail Price 60c

At all Radio Dealers and Jobbers

### Protect Your UV-199 Tubes

Think of it. If you let your UV-199 tubes burn accidentally, overnight, the life of the A-battery is shortened more than from a week of ordinary service. The same is true of the tubes. A Bradleyswitch prevents the accidental discharge of batteries and pays for itself in a short time. Get one now!

**ALLEN-BRADLEY CO.**  
290 Greenfield Ave., Milwaukee, Wis.

## CURRENT PRICES

SETS	
Crosley 3R3 Trirdyne.....	\$ 48.75
Crosley Trirdyne Special.....	58.25
Crosley 51 Portable Receiver.....	18.75
Crosley 52 3-tube Receiver.....	22.50
Crosley 51 Regular Receiver.....	14.00
Crosley 51A Amplifier.....	10.50
Crosley 50 Receiver.....	10.50
Crosley 50A Amplifier.....	14.10
Freed Eisemann 5-tube Neutrodyne.....	113.50
Fada 160 Neutrodyne.....	85.75
Acme Reflex 4-tube Loop Set.....	70.25
Melco Supreme Acmedyne.....	112.75
Dayton AC Polydyne.....	91.50
RADIOLA SETS	
Radiola III Receiver with two WD-11 tubes and Brandes Phones.....	\$ 28.00
Radiola Balanced Amplifier with two WD-11 tubes.....	24.00
Radiola III-A Receiver with four WD-11 tubes and Brandes Phones.....	52.00
Radiola III-A Receiver with tubes, Brandes Phones, and UZ-1325 Speaker.....	72.00
Radiola Regenoflex (Four tube Receiver) with four WD-11 tubes and UX-1325 Radiola Loud Speaker.....	152.80
Radiola Regenoflex Receiver without tubes, batteries, or loud speaker.....	120.00
Radiola X Receiver (Console Type) with four WD-11 tubes built in loud speaker and Brandes phones and plug.....	196.00
Radiola Super-heterodyne (6 tube) Receiver with six UV-199 tubes and UZ-1325 loud speaker.....	215.20
Radiola Super-heterodyne without tubes, batteries and speaker.....	176.00
Radiola Super VIII (6 tube Receiver) with six UV-199 tubes and enclosed loud speaker.....	340.00
LOUD SPEAKERS	
M1 or R3 Magnavox.....	\$ 24.50
M4 Magnavox.....	18.75
Western Electric 10D.....	39.50
Western Electric 521W.....	13.80
Atlas.....	18.75
Music Master, \$35 list.....	24.50
Music Master, \$30 list.....	21.50
BATTERIES	
Burgess B Batteries Large 22½ volts.....	\$ 1.45
Burgess B Batteries Large 45 volts.....	2.80
Stewart 100 amp. Radio.....	11.10

**VALLEY RADIO SUPPLY CO.**  
2206a Locust St. ST. LOUIS, MO.

Write for Agent's Confidential Price List. Always include Parcel Post and Insurance.



### Handy File Preserves Broadcasting Schedules

The illustration shows a very handy file I use for my broadcasting schedules. The file consists of 3x7-inch strips of cardboard on which are pasted the columns cut from the broadcasting page in Radio Digest.

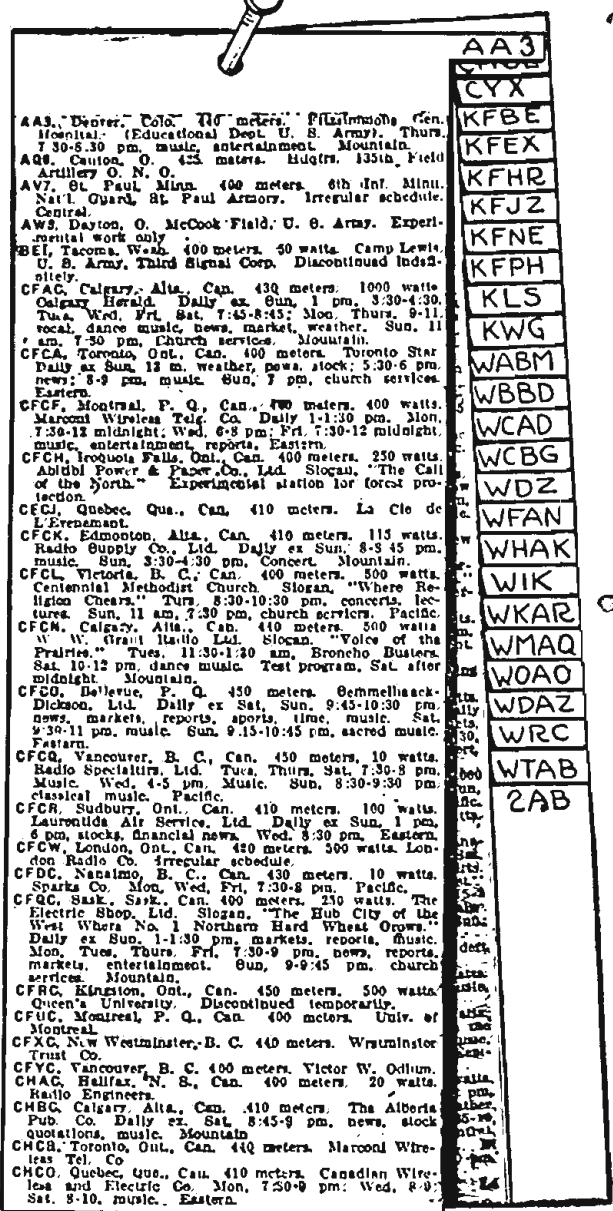

At the right of the file is the index cut on the cardboard strips. These cards are hung on a nail so that they may be turned to the left in succession for showing the next card underneath.—Carroll Harrison, Painesville, Ohio.

### How to Shield Your Set

The average homemade set has a tendency to grunt or squeal when the hands are brought near or taken away from the tuning apparatus. This is due to what is known as body capacity and is caused by the hand affecting the capacity of the instruments.

The best way to overcome this, or rather prevent it, is to shield the panel before mounting the instruments. It is not necessary to shield the entire panel if you have tuner, detector and amplifiers all in one cabinet. Your hand only affects the tuning part of your set.

The easiest shield to put on your set is one consisting of a thin piece of metal such as copper or aluminum. It is easy to handle and holes for the shafts of your set can be bored without any trouble. The shield should be kept an inch or two from aerial binding post and this can be done by cutting the corner off the shield. The only binding post the shield is connected to is that of the ground connection.

If you are shielding your set before mounting, see that all the holes have been bored in the panel and bore a like number and size in the shield. It is not necessary to glue or nail the shield to the panel as the instruments will hold it in place. Just see that the shield is large enough to blanket all parts of the tuner, which in

### RADIO HANDBOOK



Just off the press! The greatest book on Radio ever written. Price only \$1. Filled with sound, practical, tested information for every radio fan, from beginner to hard-boiled owl. Written, compiled, and edited by men of national reputation. Every page tells you something useful—and there are 514 pages. Mail \$1 to-day and get this I. C. S. Radio Handbook before you spend another cent on parts. Money back if not satisfied

TEAR OUT HERE
INTERNATIONAL CORRESPONDENCE SCHOOLS
Box 8275-M, Scranton, Penna.
I enclose One Dollar. Please send me Handbook. It is understood that if I am not entirely satisfied I may return this book within five days and you will refund my money.
Name.....
Address.....

the case of a single circuit set would be the variable condenser, coil and tickler.

Sets employing variometers require shielding more than sets not using them and the variometers should be thoroughly shielded to prevent howling and swinging of signals when the hand is removed from the set.

One prominent manufacturer makes a brass cabinet for their set and it is perfectly shielded. Bushings are made for the shafts of controls and wires leading through the brass cabinet. Everyone cannot make a brass cabinet, but we can all properly shield a set in a wooden cabinet.

If you set is already mounted it will repay you to tear it down and put the shield in place and rewire it. Of course, if you are not bothered by the body capacity effect, shielding your set will not help your receiving conditions. Just leave it alone.

While chasing trouble on a receiving set recently consisting of detector and two steps of audio using 90 volts on the plate, I happened to touch the aerial binding post while wearing the telephones and received quite a shock. Touched it again with the same results. Took off the telephones and touched it carefully but no shock. Looking at the telephones, they had metal earpieces and putting two and two together, decided the plate battery was grounded on the telephones. On opening them it was found that one of the fine windings of the electromagnets was jammed between the laminations of the horseshoe magnet. As soon as this was corrected the set worked like any other good set.

Another time I was called in to look at a four-tube loop set that could only pick up local stations. Upon testing the B batteries which should have read 67 1/2, found them to read 23. After putting in new batteries, stations from all parts of the country came in finely.

At another time was called into the country to look at a set which had developed a strong hum. On inquiry found they had recently installed electricity on the farm and they thought the set was near an electric wire. They had changed their aerial around, to no good. On looking over the set I found a loose connection in the secondary coil and after tightening it the hum disappeared.

### Crystal Best Detector

A crystal detector may be connected to a variocoupler, and when using head phones, very good reception may be obtained. The slight chances of distortion

lie only in the head phones, as the crystal detector is almost a perfect detector; in other words, the Radio energy is changed to audio without distortion. As a rule, head phones have a natural audio period which makes voice frequencies of this period louder than those of other periods. This is known as resonance or the relatively free passage of energy at one frequency and the suppression of energy at other frequencies. On the head phones, however, this resonance phenomena is considerably reduced when worn against the ears, on account of damping or suppression of energy at all frequencies.

The crystal detector set is limited in reception distance and restricted to the use of head phones. Therefore, in order to increase its receiving range or to add a loud speaker, amplifying apparatus must be employed, bringing in a new source of distortion unless care is exercised in the selection and use of this apparatus.

### NEUTRALIZING SUPER

(Continued from page 18)

connections wrong. Now then, the .006 mfd. condenser brings to the proper point the needed regeneration without causing the tube to violently spill over, aided by the 1250 honeycomb coil and the grid leak.

The circuit is not a trick one. It was as developed with the idea of incorporating the best of the modern receivers into one compact set that would bring out the good points of each and drop the bad ones. And with this done, regeneration is brought entirely under control without a control, and the beauty of it is that the regenerative balance maintains itself over the entire tuning range in the meanwhile, giving a super action.

The super action also is placed under control, through the proper capacity of the feedback condenser, and as was previously mentioned, the high pitched whistle is shoved into the stages of inaudibility. This whistle is there all right, but you can't hear it.

No boasts are made by the writer as to the distance the receiver will go, but he will say this: It will get any station any other five tube set will bring in. In some of the first tests, twenty distant stations were brought in on the loud along with five locals, three of which were going at the same time, in one night, and in addition he wishes to note the fact that several 100-watt Radiocasters located more than 300 miles away have functioned on the loud speaker.

The writer believes, as he said in the

beginning, the builder will have everything in this neutralized supergenerator that can be found in any other five-tube receiver. And that's all.

(THE END)

### Keeping Soldering-Iron Clean

Quite often it is necessary to do a quick job of soldering and usually there is no blow-torch at hand. The usual make-shift method of placing the soldering-iron in the stove to heat it produces a heavy brittle scale on the surface. This makes good soldering difficult unless the iron is frequently cleaned by filing and retinned.

This trouble may be eliminated by securing a short piece of brass or iron pipe, closed at one end, and 1 inch longer than the end of the soldering iron and just large enough to slip over it. When this is placed over the iron before insertion in the fire, the oxidation caused by the chemical affinity of copper for elements contained in the burning wood or coal is prevented, and the iron remains in proper condition to do good work.—Floyd A. Meek, Rockbridge, Illinois.

### What About It?

Isn't it about time to stop experimenting with multiple control circuits and build one that, combining ease of assembly and operation, loudness, clarity and selectivity of signals, as well as beautiful appearance, is excelled by none?

### THE ELGIN SUPER-REINARTZ RADIO RECEIVING SETS

Embodies all the advantages of the well known Elgin Reinartz (the set which was largely responsible for the popularity of this wonderful circuit) and many others. It is much louder, more selective, requires no storage battery, and can be used with excellent results on a short or loop aerial.

It has brought in 250 England, and California stations two thousand miles from Elgin, clearly and without interference on a loud speaker with only one tube, and that while our powerful local station was broadcasting three miles away. Could you ask for more.

Send 2-cent stamp for circular giving one, two and three bulb hook-ups of this remarkable circuit.

ELGIN RADIO SUPPLY CO. 207 East Chicago Street ELGIN, ILLINOIS

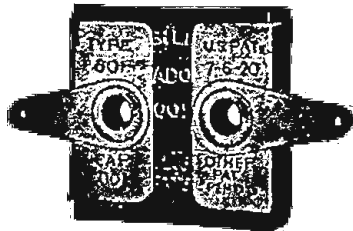

### MICADONS

The standard fixed condensers of radio. In use in more than 90% of all sets made Easily installed. There is a Micadon for every circuit

### Dubilier CONDENSER AND RADIO CORPORATION

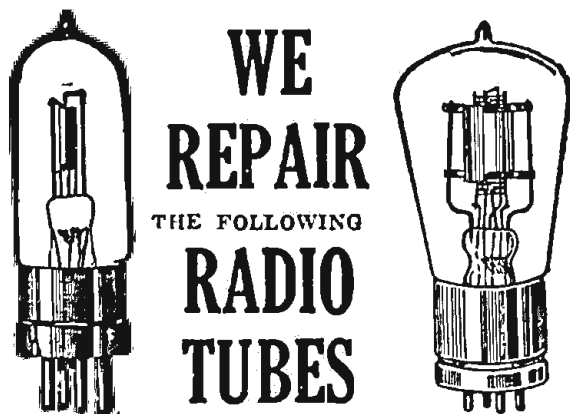

WE REPAIR THE FOLLOWING RADIO TUBES

Dealers and Agents write for Special Discount Mail Orders Solicited and Promptly Attended to

WD-11, WD-12, Our Specialties

Table listing various radio tube models and their prices, such as WD-11 at \$2.50, DV-6A at \$2.50, etc.

H. & H. RADIO COMPANY P. O. Box 22-A Clinton Hill Station NEWARK, N. J.

### Guaranteed Head-Sets

RED-HEADS are guaranteed radio phones. You run no risk when you buy them. Money back if, after 7 days' trial, you're not satisfied that they're the best receivers on the market at the price. Why not act right now and get a pair? It'll mean getting the maximum from broadcasting from the day you put them into use.



### RED-HEAD RADIO RECEIVERS NOW READY

The new 1924 Model F | The new "Red-Head" Jr. \$6.50 Per Pair Complete | \$5.00 Per Pair Complete

"Red-Heads" sent prepaid on receipt of price if you are unable to get them at your dealers.

THE NEWMAN-STERN COMPANY DEPT. R. D., NEWMAN-STERN BUILDING, CLEVELAND, OHIO

Duo-Reflex Tube for Tube-the Most Powerful Circuits Ever Built. Write for free Bulletin No. 16 Electrical Research Laboratories CHICAGO. ERLA

Send 10 cents for Shamrock's "Radio Builder's Guide Book" Also contains 10 sets that you can build from \$15 to \$50. SHAMROCK MANUFACTURING CO. Dept. 24-A, Market St. Newark, N. J. SHAMROCK FOR SELECTIVE TUNING

HUDSON-ROSS 123 W. Madison St. Chicago. Largest exclusive Radio jobbers in middle West. Write for discount.



# Flewelling Set with Radio Frequency

## Simple Way to Increase Range of Famous Set

The Flewelling receiver gives more volume per dollar of cost than any other receiver. In addition it is the most selective single circuit receiver I have

### WORKSHOP KINKS EARN A DOLLAR—

THERE are many little kinks worked out at home that would aid your fellow Radio worker if only he knew about them. There are new hook-ups, new ways of making parts and various unique ways of operating sets that are discovered every day. Radio Digest is very much interested in obtaining such material. Send them in with full details, including stamped envelope, so rejected copy may be returned. The work must be entirely original, not copied.

RADIO KINKS DEPARTMENT,  
Radio Digest,  
510 North Dearborn St., Chicago

tested. All Flewelling fans have wished to add Radio frequency amplifiers so as to increase the range of this remarkable receiver. I tried a dozen or more circuits, all of which resulted in the loss of the Flewelling characteristics, volume and selectivity. Everything that makes a physical metallic contact with the Flewelling receiver oscillates and tunes with it. From this fact I reasoned that two entirely separate sets inductively coupled should do the work. These sets should have separate A and B batteries as connecting to the same batteries, connects the sets and nullifies the whole arrangement. In this day of dry battery tubes, separate batteries are not such a barrier. The performance of this combination was surprising. Four tubes gave the vol-

## TWO SETS OF BATTERIES USED

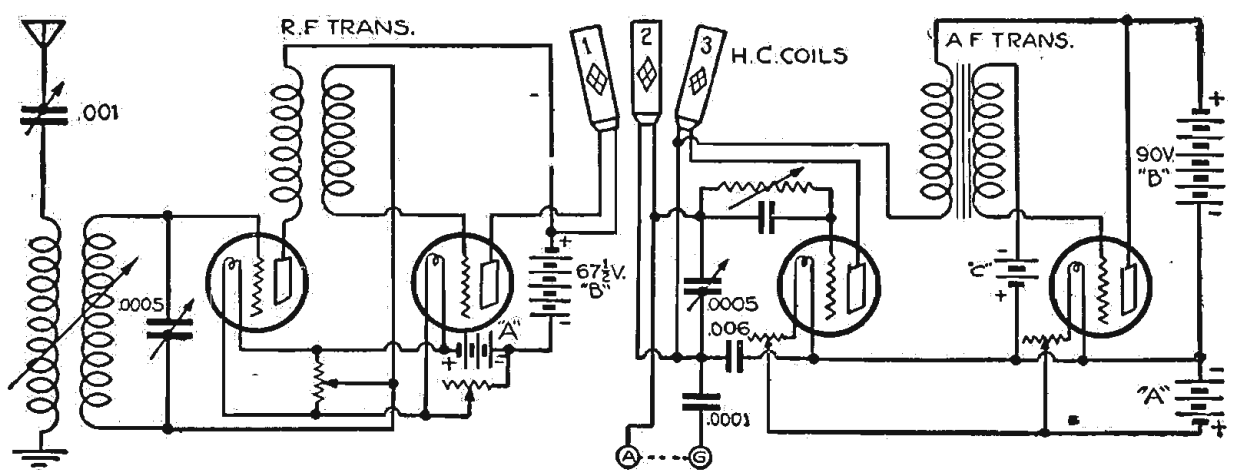

ume that the ordinary five tube Radio transformer coupled set gives, and the selectivity was much improved. For local reception I took out the link between A and G and connected by aerial and ground to the Flewelling and turned off the Radio frequency tubes, thus making an ideal all purpose set, using three or four tubes for distance and one or two tubes on local stations. The addition of Radio frequency practically eliminated reradiation.

The Radio frequency unit should be shielded and the shielding grounded to the —A and not to the ground wire. The honeycomb coils used are number 1, 20 to 30 turn; number 2, 50 turn, and number 3, 85 turn.

When the two sets are used together the Flewelling will not reach above 400 meters with a 50 turn honeycomb coil at 2. For longer wave lengths I use a link connecting A and G. A 75 turn coil can be used in this place without the link. The use of the link seems to stabilize the set.

Note that the Radio frequency rheostat turns off the potentiometer as well as tubes.—H. A. Everest, Los Angeles, Calif.

### Switch Tap Connections

In the illustration is shown a method of making connections to switch taps without a soldered joint. This provides a means of easily making a change when

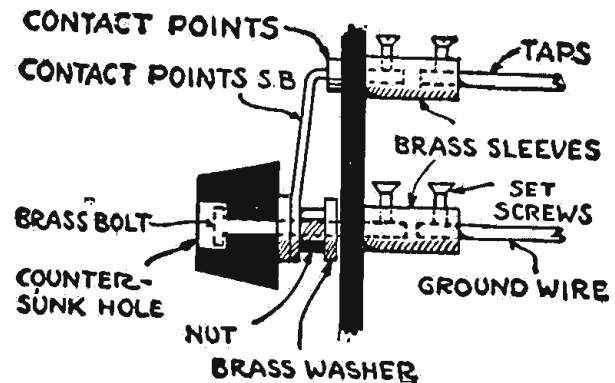

parts are to be used in another set for experimentation. Sleeves are used over the switch point end back of the panel where easy connection may be made with the wire using set screws as a holding means.—Earl Casaw, Massena, N. Y.

## Dustproof Mounting for Crystal Detector

Here is a way to make a dust proof crystal detector. It is made from an old cartridge. The crystal is mounted in one end with tinfoil packed in around it. The catwhisker is mounted to a small bolt or

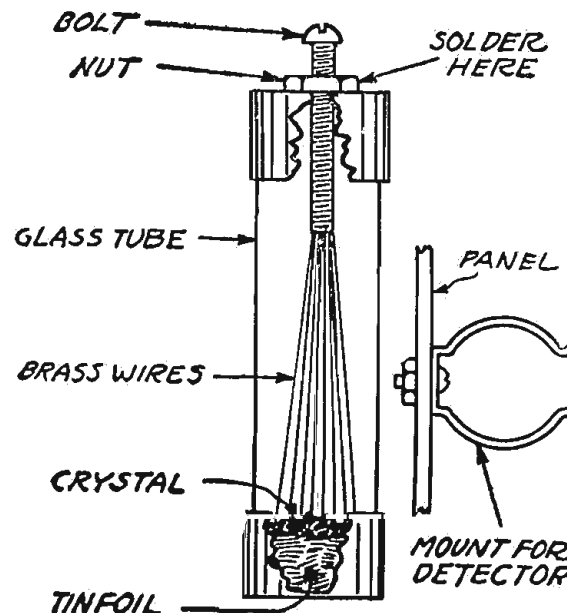

screw run through a nut soldered to the other end. The fiber around the fuse is replaced with a glass tube. The complete unit may be mounted with clips to the panel.—Wesley Cowles, Memphis, Tenn.

Much trouble is caused by poor connections from the storage battery.

## KEYSTONE RADIO LIGHTNING ARRESTERS

\$1.50

At All Dealers

Buy your Keystone Arrester today—install it according to instructions supplied, and forget about lightning. Made of Bakelite—weather-proof. No vacuum to lose. Approved by Underwriters. At all Dealers, \$1.50.

Manufacturers of over a million Lightning Arresters

ELECTRIC SERVICE SUPPLIES CO.  
17th and Cambria Streets, Philadelphia  
53 W. Jackson Blvd., Chicago  
50 Church St., New York

## EVEREADY Radio Batteries —they last longer

Conspicuous for vitality and endurance—the right batteries by test and proof for every radio use.

NATIONAL CARBON CO., INC.  
Headquarters for Radio Battery Information  
New York San Francisco  
CANADIAN NATIONAL CARBON CO., LIMITED  
Factory and Offices: Toronto, Ontario

## Why Not Buy An F-F BATTERY CHARGER In The First Place

Eventually you will recognize its superiority—why not see it now and save money. The type AB F-F charger charges 2, 4-or 6 volt "A" or auto battery and "B" batteries from 20 to 120 volts in series. Charges a battery for about a nickel. No fuss or trouble—operates from the light socket. Prices: Type AB—\$20.00, West of the Rockies slightly higher. Type 6 for "A" or Auto batteries—\$16.00, slightly higher West of the Rockies.

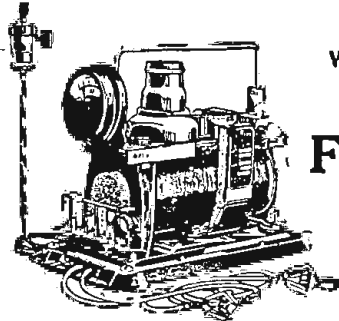

Write for literature  
THE FRANCE MFG. CO.  
10321 BERA RD. Cleveland, O.

## MADISON LOUD SPEAKER



ADJUSTABLE  
Constructed of the finest, durable fiber with heavy metal base. Stands 22" high.

\$4.95

F.O.B. Newark

Buy direct from the manufacturer! Eliminate Jobber and Dealer's Profits.

For volume and clear, rounded, faithful reproduction the MADISON is equal to any \$25.00 loud speaker on the market. We back the MADISON against the field. Compare it yourself and you'll say this is

"TRULY AN AMAZING OFFER"

The New Jersey Radio Supply Co.  
76 Springfield Avenue  
NEWARK, N. J.

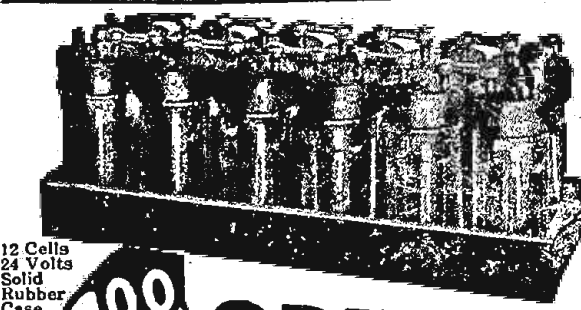

12 Cells 24 Volts Solid Rubber Case  
\$4.00 C.E.D. SPECIAL INTRODUCTORY PRICE  
For a limited time only, and to introduce this new and superior Storage "B" Radio Battery to the Public, we are selling it for \$4.00. Regular Retail Price is \$6.00. You save \$2.00 by ordering NOW. A finer battery cannot be built than the World Storage "B" Battery (12 CELLS—24 VOLTS)

Equip With Superior Battery Solid Rubber Case  
Has heavy duty 2-1/8 in. x 1 in. x 1-4 in. plates and plenty of acid circulation. Extra heavy glass jars allow ready observation of charge and prevent leakage and escape of current. It holds its charge, while idle, at constant voltage. You will find this battery a boon to long distance reception. It does away with a great many noises so often blamed on "static." Mail your order today.

### SEND NO MONEY

Just state number of batteries wanted and we will ship day order is received. EXTRA OFFER: 4 batteries in series (96 volts), \$16.00. Pay Expressman after examining batteries, 5 per cent discount for cash in full with order. Send your order NOW and save \$2.00.

WORLD BATTERY COMPANY  
Makers of the famous World Radio "A" Storage Battery.  
1219 S. Wabash Ave., Dept. 76, Chicago, Ill.  
SAVE \$2.00 BY ORDERING NOW!

## B-METAL Crystals of Quality

Trade Mark Reg. U. S. Patent Office. The B-METAL Loud Talking Crystal was the first really standard crystal offered under a reliable "complete satisfaction guarantee," and it sprang into immediate popularity, remaining at present in its third season, the best seller of any standard priced and quality crystal. B-METAL has kept pace with developments and has constantly been improved by the use of purer base materials, scientific treatment, and more care in inspecting and testing. The quality has gone up 100% and the price is still 50 cents. No premiums are offered to sell B-METAL, nor can Genuine B-METAL Crystals be bought at less than standard price. If your dealer cannot supply you, send to us. We will send one only to anyone writing us and agreeing to pay promptly if satisfied. We want every Radio owner to know what B-METAL Crystals are. Write today. Dealers and Jobbers please get our proposition

B-METAL REFINING CO.  
14 MFL 525 WOODWARD AVENUE  
DETROIT, MICHIGAN

## FREE To Each Purchaser of a World Battery

A 24-Volt "B" Storage Battery positively given FREE with each purchase of a WORLD "A" Storage Battery. The WORLD Battery is famous for its guaranteed quality and service. Backed by years of Successful Manufacture and Thousands of Satisfied Users. You save 50%.

Prices That Save and Satisfy  
Auto Batteries Radio Batteries  
6-Volt, 11 Plate \$12.25 6-Volt, 100 Amps. 12.50  
6-Volt, 13 Plate 14.25 6-Volt, 120 Amps. 14.50  
12-Volt, 7 Plate 17.00 6-Volt, 140 Amps. 16.00  
Shipment Express C. O. D. subject to examination. 6 per cent discount for cash in full with order.

2-Yr. Guarantee Bond in Writing With Each World Storage Battery  
Proves satisfactory World performance. Mail this ad with your name and address—we will ship battery day order is received; and give you your choice of "B" Storage Battery or a handsome nickel finish Auto Sportlite, FREE. Write TODAY.

WORLD BATTERY COMPANY  
60 E. Roosevelt Road Dept. L, CHICAGO, ILL.  
This FREE "B" Storage Battery takes the place of dry cell "B" batteries. Can be recharged and will last indefinitely. To be sold retail for \$6.00. It is the only battery of its kind equipped with solid rubber case—and insurance against acid and leakage. Take advantage of this remarkable introductory offer NOW. (To those who prefer it, we will send FREE a handsome nickel finish Auto Sportlite, instead of the "B" Battery. Be sure to specify which is wanted.)  
GIVEN FREE  
To introduce this new and superior World "B" Storage Battery to the Public

## Build a FADA 5 tube Neutrodyne Receiver

You can assemble one in a few hours. For distance, selectivity and loud speaker volume there's nothing better. The FADA 5-tube Neutrodyne outfit No. 167-A contains everything needed—the finest Neutrodyne parts that can be purchased. The FADA "How to Build It" book makes everything as simple as A, B, C. Buy the original FADA No. 167-A in the sealed package, \$65.60.

F. A. D. ANDREA, INC.  
1581 Jerome Ave. New York

FADA Radio



# Questions and Answers

**Three-Tube Circuit**  
(9567) JLG, Flint, Michigan.

Have no criticism to make, but would owe you my everlasting gratitude if you could give me a hook-up that will fit my parts that will enable me to use a loud speaker. I have two audio frequency transformers, 23-plate variable condenser, 1.5 meg. grid leak and condenser, 1 variometer, three tubes and sockets.

If you could give me a hook-up so I will be able to get something out of this bunch of junk I will feel even better about Radio.

A.—We take pleasure in presenting a diagram of circuit incorporating the apparatus of your specifications. While this is not a particularly selective type it will afford a highly satisfactory reception in a location which is not subjected to local Radiocast interference.

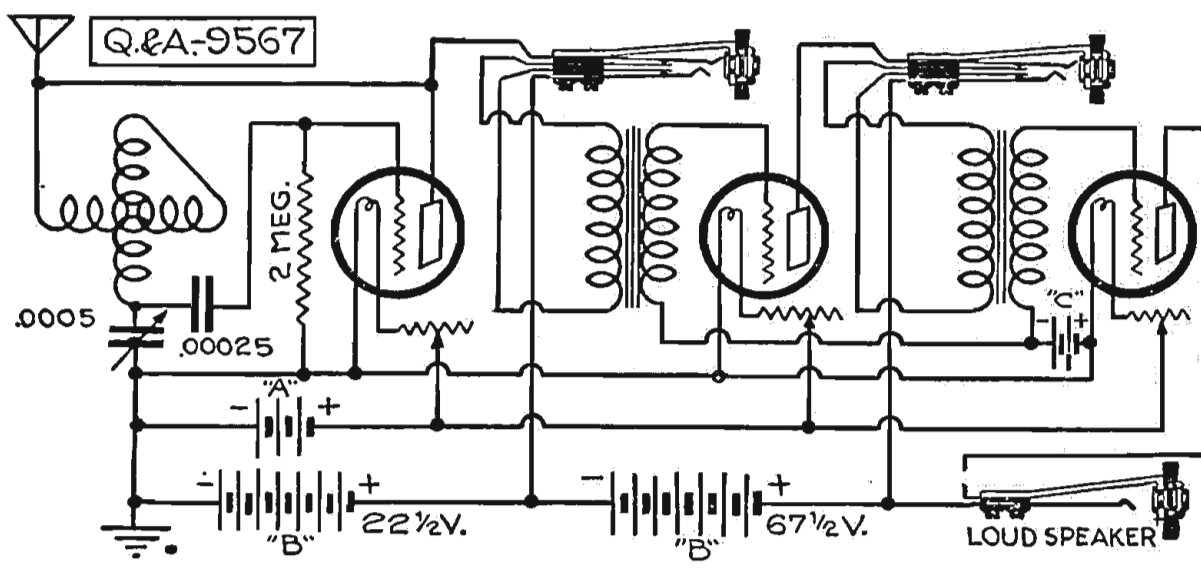

**UV-199 Tubes**  
(8585) GLK, Los Angeles, Calif.

I have decided to build a neutrodyne set but am somewhat puzzled about the type to build and would like to have your advice on the following:

Ever since the appearance of the 199 tube on the market I have used them almost entirely in preference to the larger storage battery types and I have found they give perfect satisfaction in all circuits. I have used them in regenerative circuits, one, two and three tube and also a dozen or so reflex sets. I understand perfectly that one 201-A tube in comparison with a 199 tube will deliver about 30 percent more in volume on account of its greater filament emission. However, with respect to the neutrodyne I have this theory in mind.

The 199 tube is equal to, if not superior to the 201-A in Radio frequency circuits. It is equally as good, if not better as a detector. I say, therefore, that in a three-tube neutrodyne the 199 tubes, with biased grids, would almost equal a three-tube neutrodyne with 201-A tubes on account of the fact that the 199 tubes will act equally as well as Radio amplifiers and as well as a detector.

But in the audio circuit all is changed. The A tubes simply deliver more. Theoretically they should deliver about 60 percent more in the second stage than the 199 tubes. In practice I don't believe there will be that difference. I think it will be nearer 40 percent or even 35 percent.

Now say that I use 199 tubes in the audio amplifier and instead of using two stages like I would with the larger tubes as three with the 199's and biased grids. Would not the three stage amplifier with the 199's equal or exceed that of a two stage with 201-A tubes? Or perhaps instead of the stage amplifier use a push-pull arrangement on the second stage.

To me the advantages of such an arrangement are obvious. It would mean a semi-portable set instead of one tied down to a storage battery and charger.

It would mean a cheaper one to build for the saving from the battery and charger would more than build the additional stage of audio. It would mean a lesser cost to maintain and a whole lot less bother and trouble, to say nothing of improved looks of the outfit.

I recently heard the new RCA super-heterodyne. They use 6 tubes, 199's, and bias the grids and I found the output was all that you could wish for.

Do you think my idea about the neutrodyne correct and practical or do you think I had better stick to the 5 tubes with the battery and charger?

I believe this is of general interest. If so, would you publish a diagram in your Q. and A. column showing just how the various grid biasing batteries should be connected in the circuit and how to connect up the push-pull power amplifier.

A.—We differ somewhat in our estimate of the UV-199 in comparison with the UV-201A tube. We do not consider the former as effective either as detector or amplifier because it is lacking in volume, although admittedly it is in a class by itself for portable sets and will meet your requirements, no doubt, in consideration of that adaptability.

We would recommend a stage of straight audio frequency and a second of push-pull method, in consideration of the possibility of distortion accompanying the operation of three straight stages of UV-199 tubes. It is understood of course

that the UV-201A tube can be operated on dry cell batteries for one or two hour periods daily.

A discussion and diagram of push-pull method of amplification is offered on page 26 of the January 26, 1924, issue of Radio Digest.

**Antenna Supports**  
(8237) ARE, Cleveland, Texas.

Being a reader of the Digest, I wish to ask you a few questions, as I am getting ready to put up an aerial and wish to put up the best that is possible.

First, can I use iron pipes for the masts, or will I have to use wood, we have plenty of pipe here at the main mill and it will be an easy matter to erect it from pipe, beginning with large pipe at the bottom and using small pipe as we go up, using lines to support the masts? Secondly, how far should the masts be apart, and about how high to give good results, does it make any difference as to the direction, as to location of aerial,

north, south, east or west, and what size and kind of wire should we use?

And thirdly, will you suggest what set you think will give us best results?

A.—Iron pipes are excellent supports and should accommodate a single wire of from 75 to 100 feet as antenna. The higher erection can be made, the better, although 40 feet is considered adequate. Antenna system is directional off the lead-in end.

Number 14 drawn copper wire has in the writer's experience preference to other kinds.

The neutrodyne circuit is a superior type of receiver affording quiet and selective operation and excellent receiving range. The five-tube modification, which involves two stages of straight audio frequency amplification for loud speaker operation is commended.

**Circuit Values**  
(9251) ENR, Cambridge, Mass.

I should like very much to get more detailed information of the values of the various condensers and the transformer ratios, etc., of the hook-up on page 19 of the issue of Radio Digest dated June 7, 1924. The hook-up which was submitted by Mr. W. C. Wessler of St. Louis, Mo., is shown under the caption Real Hook-Up for DX Reception.

A.—The values used in circuit you mention is as follows: Condensers; 8, .0005 mfd.; 5, .00025 mfd.; 10, .001 mfd.; 4, is a 400 ohm potentiometer, 6, is a 2 meg-ohm grid leak. 7 is a five to one ratio audio frequency transformer. Standard variometer and variocoupler are indicated.

**"CRYSTAL Sets Tested 600 Miles."** You can now get a genuine Lambert Long Distance Crystal Radio Set for only \$4.98. Particulars free. Leon Lambert, 501 Volutsia, Wichita, Kansas.

**Don't You Get Tired** of only hearing LOCAL stations on your Crystal Set? There's music on your aerial every night from stations far away. If you want to hear it without buying a tube set, WRITE ME TODAY.

LEON LAMBERT  
501 South Volutsia Wichita, Kansas

**PATENTS**

Write for my free Guide Books "How to Obtain a Patent" and "Invention and Industry" and "Record of Invention" blank before disclosing inventions. Send model or sketch of your invention for instructions. Promptness assured. No charge for above information. Clarence A. O'Brien, Registered Patent Lawyer, 2004 Security Bank Building, directly across street from Patent Office, Washington, D. C.

**WHOLESALE ONLY!!**

If you are contemplating going into the **RADIO BUSINESS** SEND FOR OUR NEW ILLUSTRATED CATALOG, WITH BARGAIN PRICES

**MANHATTAN RADIO CO.**  
112 Trinity Pl. New York City

**MAKE MONEY** as a **RADIO Demonstrator**

Big Opportunity now to everyone who knows how to set up and operate a radio set—also to take orders on a price and term basis more favorable than regular dealers can offer. Your chance to get into the Radio business. Own a set or not, as you choose. Give all or part time to this work.

**Write at Once**

Give us this information: Age; Business; Do you own a Radio Set? What kind? How much time do you want to spend in this work?

**Marshall Radio Products, Inc.**  
Marshall Blvd. & 19th St., Dept. 58-46, Chicago, Ill.

**ONE** of the largest radio manufacturers is looking for a superior loud speaker unit. Only a working model will be considered.

Address  
**W. R. DRAY**  
20 E. Lake St. Chicago

**PROGRESSIVE DEALERS** everywhere buy **RADIO SUPPLIES** from **CLARK & TILSON, INC.**

The Nationally Known House  
554 Seventh Ave., N. Y. C.  
Send for price list and discount sheet.  
Wholesale radio supplies of national reputation since 1921.

**RADIO LIBRARY**

**JUST SEND A POSTCARD YOU GET** absolutely free—the A-K Library of Latest Radio Literature, written by foremost radio authorities. Contains HUNDREDS of valuable wiring diagrams, HOOK-UPS, illustrations, articles, data, etc.

**EXPLAINS** in clear, understandable language the popular new circuits: reflex, neutrodyne, phialiform, "nameless" super-heterodyne, etc., and how to build sets. Covers long and short wave amplification, push-pull and audio amplifiers. Latest information on multi-tube and other radio subjects. **LOG BOOK INCLUDED FREE.** Also our latest Radio Catalog featuring **NATIONALLY ADVERTISED** lines at attractive savings. Write today—offer limited. Address: **ATWOOD-KING, Inc.** Dept. L-9 163 W. Washington St., Chicago

**S. & H. "B" BATTERY**  
"Will Keep Your Set Alive"

Is "NOISELESS," increases volume and range with maximum clearness. Made of the finest material to give extra service. Are not two days old when they're sent to you.

22 1/2 V. Variable.	
Large M'd'm Small	\$1.80 \$1.60 \$1.00
45 V. Variable.	
Large Medium Small	\$3.60 \$2.75 .....

Sold With a Money-Back Guarantee—Money Orders or C. O. D. We Pay Postage

**S. & H. BATTERY SUPPLY CO.**  
41 Nevins St., Dept. (D) Brooklyn, N. Y.

**Large Radio Wall Map**  
**FREE** The very latest up-to-date radio wall map 28 by 34 inches. Shows call letters, locations, wave lengths, and kilocycles of all radio broadcasting stations, U. S., Canada, and Mexico, relay divisions and radio districts. Also a scale for measuring distance. This wonderful map postage paid, **ABSOLUTELY FREE.** Merely send us a list of stores in your city which handle radio apparatus. Be sure and give the street address, and if you know the manager's name, give it also. **DO IT TODAY** before this offer is withdrawn.

**OZARKA INCORPORATED**  
808 Washington Blvd. Chicago

**ATWOOD-KING**

**Workman Radio Service**  
"THE ACCENT IS ON SERVICE"

14-16 Vesey St. NEW YORK

VARIOCOUPERS	
\$3.50 Workrite 180° Silk Wound.....	\$2.95
3.50 Fisher, Large, 90°.....	2.75
2.75 Fisher, 180°.....	2.25
4.25 Special Bank Wound Coupler for Haynes Circuit (with diagram).....	3.25
7.00 Ambassador Coil (with diagram).....	5.50
VARIOMETERS	
\$3.50 Workrite.....	\$2.95
5.00 Pathe Moulded.....	2.25
3.50 Fisher, Large.....	2.85
CONDENSERS	
\$2.00 R. C. 11 plate.....	\$1.05
2.25 R. C. 23 plate.....	1.35
2.75 R. C. 43 plate.....	1.65
VERNIER CONDENSERS	
\$4.00 R. C. 23 plate.....	\$2.25
5.00 R. C. 43 plate.....	2.95
PHONES	
\$18.00 DR. SEIBT IMPORTED "SUPER HEADSET".....	\$6.90
\$12.00 N. & K., Imported.....	\$6.90

The above items are just a few of our numerous attractive priced articles which are contained in our **BULLETIN OF RADIO PARTS**. Gladly sent to you upon request.

We are headquarters for "Radion" and "Bakelite Dilcote" Panels. The best panel material available. Mail orders promptly attended to. Will ship C. O. D. unless remittance accompanies order.

**MORE PROFITS**

To Dealers Who Buy Nationally Advertised Radio Goods from Our Bargain Catalog! Write for It Today!

**AMERICAN RADIO CO.**  
Dept. V-12 WEST 145 ST. KANSAS CITY, MO.

**DEALERS SAVE MONEY**

By Ordering from Our Bargain Catalog of Nationally Advertised Radio Goods Write for It Today!

**AMERICAN RADIO CO.**  
Dept. V-12 WEST 145 ST. KANSAS CITY, MO.

**The New STAR Type E. Detector**  
For Crystal or Reflex Sets

**Price \$1.00**

We offer the STAR TYPE E Detector which is covered by our guarantee of complete satisfaction and is sold at the LOWEST PRICE of any RELIABLE DETECTOR on the market. This detector is well made and is set with one of our very best rectifying materials. It is made so that in case of necessity it may be adjusted and while it is not especially designed for reflex sets many excellent reports of performance on these sets have been received.

**THE TYPE E DETECTOR IS THE BEST BUY IN THE CRYSTAL MARKET TODAY** and will be sent subject to exchange for any other item we make.

**DEALERS send to-day for our FALL CATALOGUE NOW READY, and get all self for the big season ahead.**

**Star Crystal Co.**  
1401 N. 525 Woodward Avenue  
**DETROIT - MICHIGAN**

**Tobacco Habit BANISHED**  
Let Us Help You

No craving for tobacco in any form after you begin taking Tobacco Redeemer. Don't try to quit the tobacco habit unaided. It's often a losing fight against heavy odds and may mean a serious shock to the nervous system. Let us help the tobacco habit to quit YOU. It will quit you, if you will just take Tobacco Redeemer according to directions. It is marvelously quick; thoroughly reliable.

**Not a Substitute**

Tobacco Redeemer contains no habit-forming drugs of any kind. It is in no sense a substitute for tobacco. After finishing the treatment you have absolutely no desire to use tobacco again or to continue the use of the remedy. It makes not a particle of difference how long you have been using tobacco, how much you use or in what form you use it—whether you smoke cigars, cigarettes, pipe, chew plug or fine cut or use snuff, Tobacco Redeemer will positively remove all craving for tobacco in any form in a very few days. This we absolutely guarantee in every case or money refunded.

Write today for our free booklet showing the deadly effect of tobacco upon the human system and positive proof that Tobacco Redeemer will quickly free you of the habit.

**Newell Pharmacal Company**  
Dept. 737 St. Louis, Mo.



# Radiophone Broadcasting Stations

## Corrected Every Week—Part V

State, City, Call	State, City, Call	State, City, Call	State, City, Call	State, City, Call	State, City, Call
<b>Alabama:</b> Auburn, WMAV Birmingham, WSY Mobile, WEAP Montgomery, WKAN	<b>Alabama:</b> Decatur, WBAO Elgin, WTAS Eureka, WFBF Galesburg, WRAM Joliet, WVAE Monmouth, WBBU Oak Park, WTAY Peoria, WJAN, WQAX Rockford, KFLV, WIAB Streator, WTAX Tuscola, WJZ Urbana, WBM Zion, WCBF	<b>Alabama:</b> Ann Arbor, WCBC Berrien Springs, KFQZ Dearborn, WWI Detroit, KOP, WCX, WWJ East Lansing, WKAR Flint, WEA Houghton, KFMW, WWAO Kalamazoo, WLAQ Mt. Clemens, WABX Potoskey, WBBP Fort Huron, WBBH Saginaw, WABM	<b>Alabama:</b> Buffalo, WGR Canton, WCAD Cazenovia, WMAC Ithaca, WEAI Kingston, WDBZ Lockport, WMAK New York, WBAV, WBBR, WDBX, WEAF, WEBJ, WFBH, WHN, WJY, WJZ, WLAW, WNYC, WQAO, WSP Rochester, WABO, WHAM Schenectady, WGY, WRL Syracuse, WFAE, WLAH Tarrytown, WRW Troy, WHAZ Utica, WSL	<b>Alabama:</b> Reading, WBBB, WRAW Scranton, WQAN State College, WPAB Washington, WABT Wilkes-Barre, WBAX	<b>Alabama:</b> Ossco, WTAQ Sisht, WAR St. Croix Falls, WRAL Stevens Point, WLBI Superior, WDBP, WBCB
<b>Arizona:</b> Phoenix, KFAD, KFCE Tucson, KFDE	<b>Arizona:</b> Anderson, WEBD Fort Benjamin Harrison, WCBN Fort Wayne, WDBV Greencastle, WLAX Greentown, WJAK Indianapolis, WBBZ Laporte, WRAF Marion, WIAQ Mishawaka, WQAO South Bend, WCAZ Valparaiso, WREB West Lafayette, WBA	<b>Arizona:</b> Minneapolis, WFN Hutchinson, WFB Minneapolis, KFDZ, KFEX, KFMT, KFQP, WLAG, WLB Moorhead, WPAU Northfield, KFMX, WCAL St. Cloud, WFA St. Paul, AV7, KFOY	<b>Arizona:</b> New York, WBAV, WBBR, WDBX, WEAF, WEBJ, WFBH, WHN, WJY, WJZ, WLAW, WNYC, WQAO, WSP Rochester, WABO, WHAM Schenectady, WGY, WRL Syracuse, WFAE, WLAH Tarrytown, WRW Troy, WHAZ Utica, WSL	<b>Arizona:</b> Rhode Island: Cranston, WKBF East Providence, WKAD Providence, WCBR, WEAN, WJAR, WKBF, WSAD, WTAG	<b>Arizona:</b> Wyoing: Casper, KFEV, KFPS Laramie, KFBU
<b>Arkansas:</b> Conway, KFKQ Fayetteville, KFMQ Fort Smith, KFOZ Little Rock, KFQ, KFMB, WCAV Pine Bluff, KFPX	<b>Arkansas:</b> Iowa: Ames, WOI Atlantic, KFLZ Boone, KFGQ Burlington, WLAS Cedar Falls, KFJX Cedar Rapids, WJAM, WKAA Davenport, WOC Des Moines, WHO Fort Dodge, KFBR, KFJY Iowa City, KFQP, WHAA Marengo, KFOL Marshalltown, KFJB Ottumwa, KFJL Shenandoah, KFNF Sioux City, KFMR, WEAU Waterloo, WRAN	<b>Arkansas:</b> Mississippi: Coldwater, KFNG Hattiesburg, WDBT Oxford, WCBH Rulerille, WCBG	<b>Arkansas:</b> New York, WBAV, WBBR, WDBX, WEAF, WEBJ, WFBH, WHN, WJY, WJZ, WLAW, WNYC, WQAO, WSP Rochester, WABO, WHAM Schenectady, WGY, WRL Syracuse, WFAE, WLAH Tarrytown, WRW Troy, WHAZ Utica, WSL	<b>Arkansas:</b> South Carolina: Charleston, WBBY, WOA Clemson College, WSAC	<b>Arkansas:</b> British Isles: Aberdeen, 2BD Birmingham, 5IT Bournemouth, 6BM Cardiff, 5VA Glasgow, 5SC London, 2LO Manchester, 2ZY Newcastle, 5NO Plymouth, 5PY Sheffield, 6FL
<b>California:</b> Bakersfield, KDZB Berkeley, KRE Burlingame, KFNZ Culver, KDBG, KFQI El Monte, KUY Fresno, KMJ Hillsborough, KFQH Hollywood, KPAR Holy City, KFOU Long Beach, KFON Los Angeles, KFCL, KFI, KFPG, KFPR, KFQ, KFSG, KBJ, KJS, KNX Oakland, KGO, KLS, KLV, KZM Paso Robles, KFNL Richmond, KFOU Sacramento, KFBK San Diego, KDPT, KDYM, KFBC San Francisco, KFPV, KPO, KLU San Jose, KQW San Luis Obispo, KFBE Santa Ana, KFAW Santa Barbara, KFJH Santa Rosa, KFNV Stanford Univ., KFGH Stockton, KJQ, KWG Taft, KFQC Whittier, KFQC	<b>California:</b> Kansas: Anthony, WBL Beloit, WPAR Louisburg, KFIL Manhattan, WFG Milford, KFEB Russell, KFQO Topeka, WPAW Wichita, KFOT, WEAH	<b>California:</b> Missouri: Butler, WNAR Cape Girardeau, WSAB Cartersville, KFVW Columbia, WAAW Fayette, KFQK Independence, KFJX Jefferson City, KFPN, WOS Joplin, WHAH Kansas City, WDAF, WBB, WQO Moberly, KFPP, KFOJ St. Joseph, KFHD St. Louis, KFQA, KSD, WCK, WEB, WEW, WJAY, WRAO Warrensburg, KFJN	<b>California:</b> New York, WBAV, WBBR, WDBX, WEAF, WEBJ, WFBH, WHN, WJY, WJZ, WLAW, WNYC, WQAO, WSP Rochester, WABO, WHAM Schenectady, WGY, WRL Syracuse, WFAE, WLAH Tarrytown, WRW Troy, WHAZ Utica, WSL	<b>California:</b> Texas: Abilene, WQAO Amarillo, WDAG, WQAC Austin, KFQM College Station, WTAW Dallas, WFAA, WRR Denison, KFQT Dublin, KFPL El Paso, WDAH Fort Worth, KFJX, KFQB, WBAP Galveston, KFLX, KFOQ, WIAC Greenville, KFPM Houston, KFCV, WCAK, WEAY, WEV, WSAV Orange, KFGX Port Arthur, WFAH San Antonio, WCAR, WOAI San Benito, KFLU Tyler, WQAF Waco, WJAD Wichita Falls, WKAF	<b>California:</b> Canada: Bellevue, CFCO Calgary, CFAC, CFCN, CHBC, CHCM, CHCX Edmonton, CFCK, CJCA Halifax, CHAC Hamilton, CHCS, CKOC Iroquois Falls, CFCH Kingston, CFRC London, CFCW, CJGC Mont-Joli, CJCM Montreal, CFCF, CFUC, CHYC, CKAK Nanaimo, CFDC New Westminster, CFXC Oids, CXCJ Ottawa, CA, CKCO, CNRO Quebec, CFCJ, CHCD, CKCI Regina, CKCK St. John, CJCI Saskatoon, CFQC Sudbury, CFCR Toronto, CFCO, CHCB, CHNC, CJCD, CJCN, CJSC, CKKE Vancouver, CFCQ, CFYC, CHCL, CJCE, CKCD Victoria, CFCL, CHCE Winnipeg, CKY
<b>Colorado:</b> Colorado Springs, KFKZ, KFQE Denver, AA3, KFAF, KFEL, KFLE, KFPO, KLZ Greeley, KFKA Gunnison, KFHA Manitou, KFQS Trinidad, KFBS	<b>Colorado:</b> Kentucky: Louisville, WHAS, WLAP	<b>Colorado:</b> Oregon: Arlington, KFGL Astoria, KFJL Corvallis, KFJH Hood River, KQP Medford, WBAQ Pendleton, KFEE Portland, KDYQ, KFEC, KFIF, KFQ, KGG, KGW	<b>Colorado:</b> New York, WBAV, WBBR, WDBX, WEAF, WEBJ, WFBH, WHN, WJY, WJZ, WLAW, WNYC, WQAO, WSP Rochester, WABO, WHAM Schenectady, WGY, WRL Syracuse, WFAE, WLAH Tarrytown, WRW Troy, WHAZ Utica, WSL	<b>Colorado:</b> Vermont: Springfield, WQAE	<b>Colorado:</b> Cuba: Calbarien, 6EV Cienfuegos, 6AZ, 6BY, 6CX, 6DV Camaguey, 7AZ, 7BY Colon, 6EV Ella, 7SR Havana, PWX, 2AB, 2BX, 2BY, 2CX, 2DW, 2HC, 2HS, 2JK, 2KD, 2KP, 2LC, 2MG, 2OK, 2OL, 2TW, 2WV, 2XD Santiago, 8AZ, 8BY, 8DW, 8EV, 8FU, 8GT Tulnuc, 6KW, 6XJ
<b>Connecticut:</b> Hartford, WDAK New Haven, WPAJ Storrs, WABL	<b>Connecticut:</b> Louisiana: Alexandria, KFFY Baton Rouge, KFCC Franklinton, KFJD Jennings, WCBJ New Orleans, WAAB, WAAC WABZ, WCAQ, WCBF, WCBP, WTA, WWL Shreveport, KFQ, WGAQ	<b>Connecticut:</b> Nebraska: David City, KFOR Fremont, WQAE Hastings, KFQX Lincoln, WFAV, WJAB, WMAH Norfolk, WJAG Oak, KFQZ Omaha, KFQZ, KFQX, KFOX, K F Q V, W A A W, WIAK, WYAL, WQAW Tecumseh, WTAU University Place, WCAJ	<b>Connecticut:</b> New York, WBAV, WBBR, WDBX, WEAF, WEBJ, WFBH, WHN, WJY, WJZ, WLAW, WNYC, WQAO, WSP Rochester, WABO, WHAM Schenectady, WGY, WRL Syracuse, WFAE, WLAH Tarrytown, WRW Troy, WHAZ Utica, WSL	<b>Connecticut:</b> Virginia: Blacksburg, WEA Fortress Monroe, WNAW Norfolk, WBBW, WTAR Radio, NAA Richmond, WBBL Roanoke, WDBJ	<b>Connecticut:</b> Czechoslovakia: Praga, KBELY
<b>Delaware:</b> Wilmington, WHAV, WOAT	<b>Delaware:</b> Maine: Bangor, WABI, WDBN Houlton, WCBJ Portland, WTAJ Skowhegan, WDBU	<b>Delaware:</b> New Jersey: Atlantic City, WHAR Camden, WABU Gloucester City, WRAX Lambertville, WTAZ Newark, WAAW, WBS, WCBX, WOR New Brunswick, WBEA North Plainfield, WEAM Paterson, WBAN Salem, WDBQ Trenton, WMAL, WOAX, WVAB	<b>Delaware:</b> New York, WBAV, WBBR, WDBX, WEAF, WEBJ, WFBH, WHN, WJY, WJZ, WLAW, WNYC, WQAO, WSP Rochester, WABO, WHAM Schenectady, WGY, WRL Syracuse, WFAE, WLAH Tarrytown, WRW Troy, WHAZ Utica, WSL	<b>Delaware:</b> Washington: Bellingham, KDZR Everett, KFBL Lacey, KGY Neah Bay, KFHH North Bend, KFQW Olympia, KFPP Pullman, KFAE Seattle, KDZE, KFHR, KFJC, KFOA, KFPP, KFQX, KHQ, KJR, KTW Spokane, KFIO, KFPY Tacoma, KFBB, KGB, KMO Walla Walla, KFCE Yakima, KFQ	<b>Delaware:</b> Finland: Tammerfors, 3NB
<b>Florida:</b> Miami, WQAM Pensacola, WGAN St. Petersburg, WCBK, WDBI Tampa, WDAE Winter Park, WDBO	<b>Florida:</b> Maryland: Baltimore, WCAO, WCBM, WEAR Salisbury, WEBI	<b>Florida:</b> New Hampshire: Chesham, WSAU Lacoma, WKAV	<b>Florida:</b> New York, WBAV, WBBR, WDBX, WEAF, WEBJ, WFBH, WHN, WJY, WJZ, WLAW, WNYC, WQAO, WSP Rochester, WABO, WHAM Schenectady, WGY, WRL Syracuse, WFAE, WLAH Tarrytown, WRW Troy, WHAZ Utica, WSL	<b>Florida:</b> West Virginia: Charleston, WPAZ Clarksburg, WHAK Martinsburg, WDBD	<b>Florida:</b> France: Lyons, YN Paris, CW, ESP, FL, FPTT
<b>Georgia:</b> Atlanta, WBBF, WDBE, WSB Columbus, WDBA Macon, WCBW, WMAZ	<b>Georgia:</b> Massachusetts: Boston, WDBR, WNAC, WTAT Dartmouth, WMAF Fall River, WSAW, WTAB Lowell, WQAS Mattapoisett, WBBG Medford Hills, WGI New Bedford, WDAU Springfield, WBS Taunton, WDBB Worcester, WCBT, WDA, WDBH	<b>Georgia:</b> New Mexico: Albuquerque, KFLR State College, KOB	<b>Georgia:</b> New York, WBAV, WBBR, WDBX, WEAF, WEBJ, WFBH, WHN, WJY, WJZ, WLAW, WNYC, WQAO, WSP Rochester, WABO, WHAM Schenectady, WGY, WRL Syracuse, WFAE, WLAH Tarrytown, WRW Troy, WHAZ Utica, WSL	<b>Georgia:</b> Wisconsin: Fond du Lac, KFIZ Kenosha, WQAR La Crosse, WABN Madison, WHA Milwaukee, WCAV, WHAD, WIAO	<b>Georgia:</b> Mexico: Mexico City, CYB, CYL, CYX Monterey, CYO
<b>Idaho:</b> Boise, KFAU, KFDD, KFFB Kellogg, KKFY Wallace, KFOD	<b>Idaho:</b> New Jersey: Atlantic City, WHAR Camden, WABU Gloucester City, WRAX Lambertville, WTAZ Newark, WAAW, WBS, WCBX, WOR New Brunswick, WBEA North Plainfield, WEAM Paterson, WBAN Salem, WDBQ Trenton, WMAL, WOAX, WVAB	<b>Idaho:</b> New York, WBAV, WBBR, WDBX, WEAF, WEBJ, WFBH, WHN, WJY, WJZ, WLAW, WNYC, WQAO, WSP Rochester, WABO, WHAM Schenectady, WGY, WRL Syracuse, WFAE, WLAH Tarrytown, WRW Troy, WHAZ Utica, WSL	<b>Idaho:</b> New York, WBAV, WBBR, WDBX, WEAF, WEBJ, WFBH, WHN, WJY, WJZ, WLAW, WNYC, WQAO, WSP Rochester, WABO, WHAM Schenectady, WGY, WRL Syracuse, WFAE, WLAH Tarrytown, WRW Troy, WHAZ Utica, WSL	<b>Idaho:</b> Wisconsin: Fond du Lac, KFIZ Kenosha, WQAR La Crosse, WABN Madison, WHA Milwaukee, WCAV, WHAD, WIAO	<b>Idaho:</b> Switzerland: Geneva, HB1 Lausanne, HB2
<b>Illinois:</b> Belvidere, WOAG Cambridge, WTAP Carthage, WCAZ Chicago, KYW, WAAF, WBBM, WDBY, WBBH, WGN, WJAZ, WLS, WMAQ, WQJ, WTL Chicago Heights, WCBZ	<b>Illinois:</b> New Jersey: Atlantic City, WHAR Camden, WABU Gloucester City, WRAX Lambertville, WTAZ Newark, WAAW, WBS, WCBX, WOR New Brunswick, WBEA North Plainfield, WEAM Paterson, WBAN Salem, WDBQ Trenton, WMAL, WOAX, WVAB	<b>Illinois:</b> New York, WBAV, WBBR, WDBX, WEAF, WEBJ, WFBH, WHN, WJY, WJZ, WLAW, WNYC, WQAO, WSP Rochester, WABO, WHAM Schenectady, WGY, WRL Syracuse, WFAE, WLAH Tarrytown, WRW Troy, WHAZ Utica, WSL	<b>Illinois:</b> New York, WBAV, WBBR, WDBX, WEAF, WEBJ, WFBH, WHN, WJY, WJZ, WLAW, WNYC, WQAO, WSP Rochester, WABO, WHAM Schenectady, WGY, WRL Syracuse, WFAE, WLAH Tarrytown, WRW Troy, WHAZ Utica, WSL	<b>Illinois:</b> Wisconsin: Fond du Lac, KFIZ Kenosha, WQAR La Crosse, WABN Madison, WHA Milwaukee, WCAV, WHAD, WIAO	

### The Reader's View

#### Radio in Hospitals

I beg the privilege to offer my felicitations for your timely fitting and splendid editorial in the Radio Digest captioned "Invalids Need Receivers." "Music," said Plato, "is a moral law. It gives a soul to the Universe, wings to the mind, flight to the imagination, a charm to sadness, gaiety and life to everything. It is the essence of order, and leads to all that is good, just and beautiful, of which it is the invisible, but nevertheless dazzling, passionate and eternal form."

From my experience I know what it is like to spend twenty-four hours a day within the four bare walls of a tuberculosis hospital. I have been sick since December, 1915, approximately six and one half years of this time. I have spent twenty-four hours a day in bed, with the exception of the past two years of which time I spent twenty hours per day in bed, and being unable to walk all this time I am practically a shut-in.

Radio is a godsend to hospitals, and with so much music in the air, the time is not far distant when every hospital in United States will be equipped with receiving sets.

Philanthropy is usually limited to Thanksgiving and Christmas. Still Good Samaritans or benevolent souls to help mankind are sometimes scarce and hard to find. My vocabulary is inadequate. Words cannot express or impress upon the public mind the gloom in hospitals without Radio. Charity, they say, begins at home and sometimes stays there.

In your editorial you state that we shut-ins have to depend on our relatives, I have found that what relatives I have are distant relatives when I'm broke. To be impoverished by sickness is no disgrace. And publicity never hurts a good cause. The doing of a kind act confers a reward that even ingratitude cannot rob you of. Providence gives us our relatives, but thank God we can choose our friends.—John P. Cassidy, Ph. D., Fall River, Mass.

#### Flewelling Super

I want to state my experience with the Flewelling circuit. To begin with, it is all the inventor claims it to be—a super-

With a bunch of junk I put the single condenser variocoupler set together. Results—lots of noise. Replacing the junk with good apparatus, cutting down the panel length and making short leads, the results were greatly improved.

The Flewelling is critical as to the grid leak. After buying a number of leaks and getting no results, I made about a dozen leaks before I could get one to give the range necessary.

With a good leak, DX-ing is nothing. Using a WD-11 tube with 63 volts on the plate and anything (metal) for an aerial, I have heard KDZE at Seattle, Wash., 1,900 miles; KHJ, at Los Angeles, 2,000 miles; and everything in between to the Atlantic coast with plenty of volume.

A few nights ago I listened to a station for one hour. The program was foreign, music, singing and announcements. I do not know where the station is, probably in Mexico. From all points of the compass the stations come in loud and clear.

Now for the funny part. Mr. Flewelling laid special stress on using a wire or metal object in the aerial circuit to get action out of the variable condenser. Throw the variable condenser away; you won't need it unless you are working through interference.

With a piece of bus wire 7 inches long, sticking out from the grid connection of the primary coil, and using the tickler and variable leak for tuning, I have heard stations WGY, WHAZ, WLW, WSAL, KDKA, WJAX, KOP, WCX, WWJ, WEAF, WMC, WTAM, WDAF, WJAZ, WFAA, WSB, WOS, WOC, WDAF and WMAQ.

Get out the old Flewelling and get a good variable grid leak and try it.—E. W. Miller, Ft. Wayne, Ind.

#### How to Tame Producing Managers

Noting a recent news item, it seems to me that the time is about ripe for all Radio listeners to take a hand in the argument between Radiocasters and producers. There is, of course, no doubt that the world about B. C. L.'s having plenty to listen to, and there is no doubt that the efforts of the producers will have about as much effect in hindering the growth of Radio as the efforts of our forebears were effective in stopping the growth of the automobile industry by laws barring the highways to them, etc.

However, this argument cannot be all one-sided. While some people stay away perhaps from concerts and other per-

formances because they can hear them over the Radio, there are surely just as many or perhaps more who are influenced to go and see in person the artists whom they have heard over Radio.

There are quite a few millions of us B. C. L.'s. Why not let us get together and express our disapproval of the action of the producers? If even a fair percentage of B. C. L.'s would take a pledge to stay away for sixty days from the performances of any artist appearing for any organization who had put a ban on Radiocasting, we believe the said producers would speedily conclude that Radio is doing them more good than harm, and that the present "rotten" condition of their business is matched by every other business in the country.

I would like to be the first to sign such a pledge as above mentioned on a nationwide basis and I am sure a good many millions of Radiophans will follow suit mighty promptly.—Spokane, Wash., B.C.L.

#### Two-Way Crystal Set

In a recent issue Mr. Kraft gave a two-crystal circuit, which I tried out, as also the three circuits shown in the sketches herewith. When he says a crystal is not strictly a "one-way street," but has more conductivity one way than the other, but has some both ways, he has probably given the reason why the above circuits using four crystals can hardly be said to have worked at all, although at times a faint sound could be caught. As between the split phones and Mr. Kraft's double crystal, I found the split phones far more satisfactory in volume, because, I suppose, the whole of each usable half-wave goes all to one ear and is not divided between the two at once. A dead location made any distance test impossible. I use two sets with tubes, but still I find the crystal interesting.—Joseph Martin, Rochester, N. Y.

#### Keeping the Air Clean

I am very pleased to see some Radio publication brave enough to take a stand on the question of Radiocasting the Loeb-Leopold murder trial. The very idea of letting one of the world's most terrible trials of murder go through the ether to moron minds and stimulate them to commit such a murder, giving, perhaps, in detail the very thing that they were waiting for.

Again I want to say that I am very

pleased to know of one Radio publication that is taking a stand for clean skies.—R. L. J., Jr., 15 years old, Eau Claire, Wis.

#### Aerial for Portable

On July 26 my family and I decided to go on a picnic, all piled in the "Lizzie" and, being a Radio fan for years, the portable was included. The portable consisted of a Crosley 51 made into a 51 P.

We stopped at a park nine miles from Detroit, put up the aerial, a single wire 150 feet long, 20 feet high at one end and 10 at the receiver end. Grounded on the frame of the motor car. Immediately VEI sixty miles away comes pounding in. Boats thirty miles away came in with equal volume, but WWJ, nine miles away, I couldn't get a peep out of. By throwing it into oscillation I could get the harmonic, but could not clear it up.

After doing a little investigating I found the aerial was shielded on either side by a row of tall trees, but the free end from which all the signals were coming was wide open.

Later I moved the aerial and put it in the open. At once WWJ gave a much appreciated concert to about thirty people.

Let this serve as a warning to all fans with portable outfits. Be sure and place your aerial in the open as much as possible. It pays in the long run. Well, will close, wishing Radio Digest all the luck in the world.—W. J. Fobare, Detroit, Mich.

#### Regarding the Announcers' Contest

I have noted with interest the Radio Digest First Annual Gold Cup Award contest and wish to thank you people for your originality in instituting this competition. Already there is a noticeable improvement in the announcing of programs. The "men behind the mikes" are attempting to improve their technique so as to stand a better show in the voting.

Early in the days of broadcasting, announcers were prone to stint use of their identifying station call letters between numbers. Even when they did give the call it was very often mumbled and not distinct.

But since the contest—voila! Everything is different. The announcers are watching their P's and Q's.—P. W., Los Angeles, Calif.



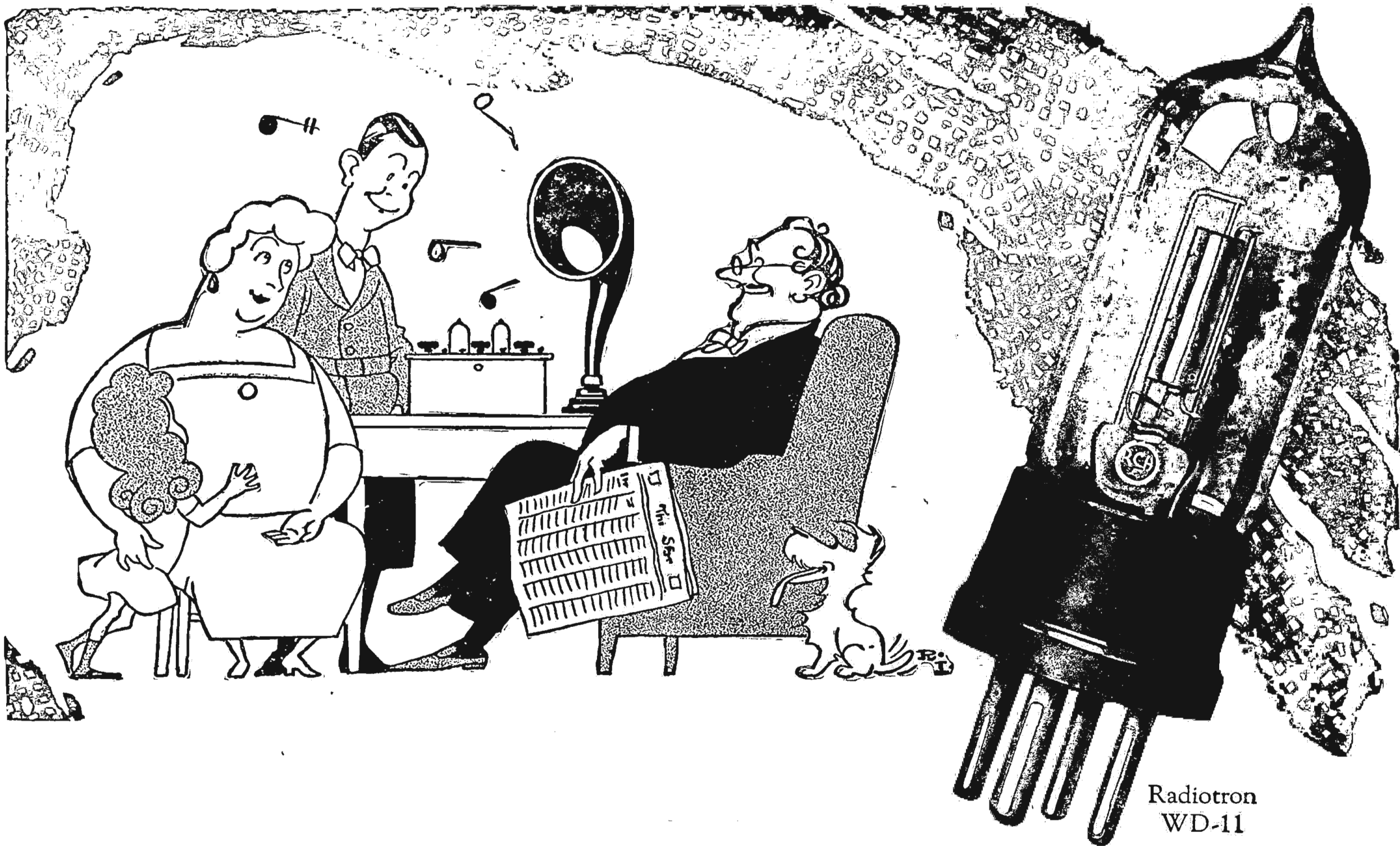

Radiotron  
WD-11

# The Tube *means* Music or Noise

It isn't a genuine WD-11 unless it's a Radiotron.

It isn't a genuine WD-12 unless it's a Radiotron.

It isn't a genuine UV-199 unless it's a Radiotron.

It isn't a genuine UV-200 unless it's a Radiotron.

It isn't a genuine UV-201-a unless it's a Radiotron.

Buying anything but the best in vacuum tubes is like trying to run a car on gas that is half water. In radio, everything, in the end, depends upon the Radiotrons. You can put perfectly good Radiotrons in a poorly made set—that's true. But the point is that the very finest receiver made can be no better than its tubes. This is

no new or startling announcement. Everyone knows it. And that's why, at the radio counter, you see each man pick up a Radiotron, and look at the base for the word "Radiotron" and at the glass for the "RCA" mark. For best reception—real music—nothing short of the best in tubes will do.



This symbol of quality is your protection.

Radio Corporation of America

Sales Offices:

233 Broadway, New York

10 So. La. Salle St., Chicago

433 California St., San Francisco, Cal.

# Radiotron

REG. U. S. PAT. OFF.