

How to Chart Your Dial Settings to Save Time; Pictures of WFAA, Dallas; Directions for Making New Four Filter Eight Tube Super-Heterodyne Set

Radio Digest

EVERY WEEK **Illustrated** PROGRAMS **TEN CENTS**

REG. U. S. PAT. OFF. & DOM. OF CANADA

Vol. XII

Copyright 1925
By Radio Digest Publishing Co.

SATURDAY, MARCH 7, 1925

No. 9

NEW FOUR FILTER SUPER

JAZZ FADES OUT AS CLASSICS WIN FANS

SURVEY SHOWS TASTE OF PUBLIC IS IMPROVING

WEAF Correspondence Also Increases Threefold — "Talk" Listeners Quadruple Strength

NEW YORK.—The public is renouncing its allegiance to King Jazz. The "jazz age" is passing fast. So says John A. Holman, broadcasting manager of the American Telephone and Telegraph company, after a study of the correspondence received by that company as a result of Radio.

For, out of 54,000 letters received in January, 1925, only 5 per cent favored jazz. What a fall! In January, 1924, the jazz figure was 35 per cent, while in January, 1923, it dominated all else, for then it was 75 per cent.

In the meantime the percentage of fans inclined to favor classic and "good" music has risen from 20 per cent in 1923 to 45 per cent in 1925.

Talks Gain in Favor, Too

"Talks" in January, 1923, rated 5 per cent popularity, while it now stands third in public appreciation with 20 per cent. Symphonic music ranks second nowadays with 30 per cent.

"Good music, that is, concert and standard numbers, philharmonic concerts and the like, are steadily growing in favor," says Mr. Holman, "and talks, inspirational, interesting and educational, are also more popular."

Besides providing a method for analyzing programs the correspondence does another thing. It shows the Radio audience has evidently grown greatly in one year's time. While 54,000 letters were received by WEAF in January of this year, the 1924 monthly average number of communications was only 17,000.

Pass Resolution Allowing Press Over Navy Stations

WASHINGTON, D. C.—A resolution providing for the sending of press messages over government-owned Radio stations from the Pacific coast of the United States to the Orient, etc., has been passed by the Senate. The resolution provides for the use of these stations until June 30, 1927, by which time it is expected that commercial Radio stations will be in operation. The House has a similar resolution pending on its calendar.

DIFFERENCE IN TIME CREATES BIG PUZZLE

DAVENPORT, Iowa.—A cablegram was received by WOC here from Samoa. It arrived at 8:49 Davenport time. It was filed at 6:28 the same evening Samoan time. Now, how long did it take for the message to reach its destination? No, you're wrong! It took exactly twenty hours and twenty-one minutes to arrive. This apparent discrepancy is due to the international date line.



Kay Ronayne, better known as the "personality girl" at Station WEBB, Chicago. She appears every Tuesday and Saturday from this station. Right, Miss Imogene Schuster, versatile leader of the Schuster Sisters' California orchestra at WOC, Davenport.



SHARPNESS OF RECEIVER UNEXCELLED

J. Fournier Designs Set

Noted Inventor Surprises Fans with Astonishing Improvement in Super-Heterodyne

Undaunted by the fact that super-heterodyne manufacturers had followed very closely the original design conceived by Major E. H. Armstrong for the super-heterodyne, Jacques Fournier, the well-known Radio engineer, has struck out from the beaten path into hitherto untried methods of utilizing super-heterodyne principles and has evolved a receiver which is not only radically different in many respects but a marked improvement in both selectivity and range over anything in this line yet developed.

There is nothing patentable about this new receiver or any of the parts involved and, due also to patents, this receiver cannot be put on the market. There is nothing revolutionary in any of the circuits of this improved set, but Mr.

Fournier has deviated from the usual procedure in several respects so that his set which he calls the Four Filter Super, will operate anywhere in Chicago or New York, the two most difficult points, without interference from local stations.

"After building a number of super-heterodynes," says Mr. Fournier, "I found that none of them were sufficiently selective. It was in an effort to increase the selectivity, without loss of range, that I developed the set which I am now using."

(Turn to page 2)

IMPROVES SUPER-HET

(Continued from page 1)

"It is not a particularly difficult set to build once the constants have been worked out, and I am quite sure that anyone who will use the same care that I did in constructing the parts which make up this set will get the same satisfaction from it that I do. My location is a very poor one, as previous experiments have shown, yet the set performs exceptionally well and works even better when used in locations that are known to be at least average and will give a receiver an even break."

Radio Digest has given Mr. Fournier's receiver some very thorough tests and is convinced that this set possesses sufficient merit to present it to Radiophans at large.

The log sheet of the Four Filter Super shows all of the high power class B stations from WEAJ in New York to KFI in Los Angeles and including of course such well-known broadcasters as WCAP, WOO, KDKA, WCX, WBZ, WMC, WSB, WBAP, WHAS, WOC, KOA, WFAA and KGO. A receiver which will go through this list practically any night in the week and also pick up many of the smaller and not so well known stations is exceptional, and while there may be a few readers able to do this, due either to excellent location or freak conditions, this is far from being the rule in any large cities. Its performance on a loop aerial was equal to that of the now famous Hetduogen on an outside aerial and it was far simpler to control, with less likelihood of radiation and interference with neighboring sets. This magazine has therefore made arrangements with Mr. Fournier to write a series of articles on the construction of this set beginning in this issue, the first of which will be found on page 17.

De Luca and Mme. Dal Monte Enthral Fans

Hear Famous Artists on Fifth of Victor Programs

NEW YORK.—Guiseppe de Luca, baritone, one of the most distinguished members of the Metropolitan Opera company, and Mme. Toti Dal Monte, coloratura soprano of the same organization, both world-famous Victor artists, made their radio debut before the vast Radio audience of twelve stations during the fifth Victor presentation given before the microphone in the studios of WEAJ here on Thursday evening, February 26.

In addition to De Luca and Mme. Dal Monte, the Victor Concert orchestra, under the direction of Rosario Bourdon, assisted in making the program one that will live long in the hearts of the listeners in on this evening.

March 12 is the date of the sixth Victor recital. Even more stations will be linked in at this time, it is believed. The recitals are given from 9 to 10 p. m. Eastern or 8 to 9 p. m. Central time.

Station Chitchat

Ten of the company of KGO players, under the direction of Wilda Wilson Church, at Oakland, Calif., will speak the parts of Booth Tarkington's comedy, "Clarence," for the pleasure of Radio listeners on Thursday evening, March 12. Between the acts, music by the Arion trio will be heard.

Due to the absence of Dr. Sigmund Spaeth, who is at present on a lecture tour, his weekly studio party broadcast from WOR, will be presented under the direction of John Tasker Howard who has been associated with Dr. Spaeth for some time.

Senator Frank W. Elliott of WOC, has promised his aid to the Bishop of WAHG, in rounding up the Old Time Fiddlers who are really state champions for the Interstate contest on the air.

Marguerite Namara, world-famous operatic soprano, made her only Radio appearance in America through Station WJZ recently.

Godfrey Ludlow, famous concert violinist, has been added to the staff of Station WJZ and WJY. Mr. Ludlow will act as assistant to the manager in the preparation of extraordinary musical broadcasts.

An Arkansas Old Time Fiddlers' contest was staged recently from Station KFMQ, when ten old time fiddlers competed for the honors of the country. Thousands of fans expressed their appreciation of the concert.

Howard Thurston, master magician, recently gave a talk from Station WLW. He requested at the time that anyone who had helped him in his numerous experiments, write him a letter. These letters will be compounded into a book entitled

PLANE BROADCASTS ECLIPSE DATA

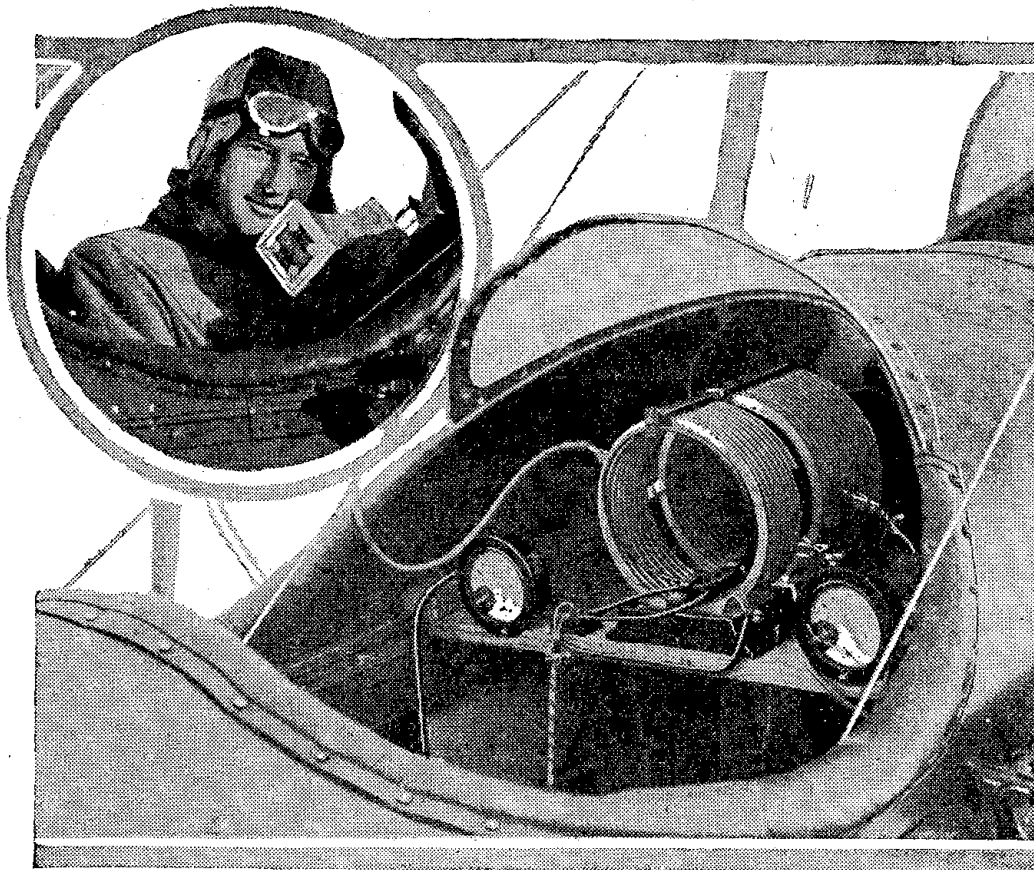

Gold Medal Station WCCO rebroadcast the only successful airplane broadcast of the recent solar eclipse, made from the plane shown here. The set used, a 5-watt transmitter, is seen in the fuselage. Howard Kelley, who assisted in the experiment, is holding the microphone, which is concealed in a hushaphone.

"My Assistants—From Office Boys to Presidents."

Yankee, an educated canary, caused a flutter of jealousy among the feathered members of the force at KHJ. When he came into the studio he made his debut by singing Yankee Doodle. Tune in on this station and hear this unique feature.

Atwater Kent Radio artists are heard alternate Wednesday evenings through WEAJ, New York; WJAR, Providence; WCAP, Washington; WOO, Philadelphia; WCAE, Pittsburgh, and WGR, Buffalo. They broadcast for an hour, during which time they favor their vast Radio audience with a miscellaneous program of songs that are dear to the hearts of all.

CONTENTS

Radio Digest, Illustrated, Volume XII, Number 3, published Chicago, Illinois, March 7, 1925. Published weekly by Radio Digest Publishing Company, 510 N. Dearborn Street, Chicago, Illinois. Subscription rates, yearly, Five Dollars; Foreign Postage One Dollar additional; single copies Ten Cents. Entered as second class matter at the postoffice at Chicago, Illinois, under the Act of March 3, 1879.

All the Live News of Radio.....	1 to 8
WFAA—"Working for All Alike".....	5
An Evening at Home with the Listener In, a chart showing when to listen in for your favorite station.....	8
Advance Programs for the Week at All the Larger Stations.....	9 to 14
Chart the Aerial Highways and Save Time, by James McDonald.....	15
Editorials; Indigest; Condensed by Dielectric.....	16
Four Filter Eight Tube Super-Heterodyne, Part I—Analysis of the Circuit, by Jacques Fournier.....	17
Broadcast Listener's Reference Library, Part V—Radio Frequency Explained, by E. T. Jones.....	19
Adding Radio Frequency to Reflex Set, by E. F. Ziemer.....	21
Questions and Answers.....	22
Radiophone Broadcasting Stations, Part I.....	23

Looking Ahead

The Four Tuned Filters of the Special Super will be taken up by Jacques Fournier next week. They are the secret of this receiver's remarkable selectivity and considerable space will be given this feature so that readers may have every detail and nothing to guess at. Materials necessary are in the list of parts included as part of this week's installment.

Broadcast Listener's Library will be increased by an article on audio frequency amplification. This essential to volume and loud speaker operation is handled by E. T. Jones in a way that all can understand.

Operating and Trouble Shooting Grebe Synchronphase will be a treat to appear in the next issue. The writer of the article found this a most interesting set, surprisingly different from the rest.

Ever Heard "Old Bill" Hay at KFKX, Hastings? He and his splendid station will be described by word and picture in the next issue of Radio Digest. Those interested in the technical equipment of stations will also find KFKX of great interest because of its unusual design.

Newsstands Don't Always Have One Left

WHEN YOU WANT

Radio Digest

YOU WANT IT!

BE SURE OF YOUR WEEKLY COPY BY SUBSCRIBING NOW

SEND IN THE BLANK TODAY

Publisher Radio Digest, 510 N. Dearborn St., Chicago, Illinois.

Please find enclosed check M. O. for Five Dollars (Six, Foreign) for One Year's Subscription to Radio Digest, Illustrated.

Name

Address

City.....State.....

MECO RADIO TUBES



Be Sure to Get the Genuine

M E C O — this name stamped on the tubes you buy is a guarantee of obtaining more enjoyment from your radio. The greater volume obtained without impairing exceeding clarity in receptive tones—due to a radical improvement in construction of MECO tubes.

Metropolitan Electric Co. Des Moines, Iowa

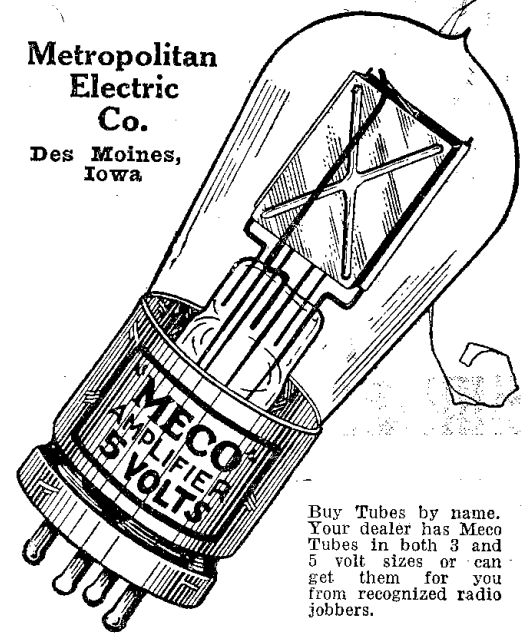

Buy Tubes by name. Your dealer has Mecco Tubes in both 3 and 5 volt sizes or can get them for you from recognized radio jobbers.

London, Madrid Newcastle, Aberdeen--

that's just a few of them

AGAIN Elgin Super-Reinartz leads all others! Every trans-Atlantic report investigated was found to be ABSOLUTELY authentic! Many happy owners of Elgin sets again tuned in the European stations.

ELGIN Super-Reinartz "The Ford of Radio"

will give you the selectivity and distance it has given others. And you can save \$50.00. Let us tell you how—

FREE

Mail the coupon TODAY for the complete working drawings of the famous Elgin Super-Reinartz, the set that gets the distant stations. They are free—no obligations, just a stamp for postage, please!

tear out this coupon—

ELGIN RADIO SUPPLY CO., Dept. A, 207 E. Chicago St., Elgin, Illinois.

Send the FREE drawings of the Elgin Super-Reinartz at once. Also tell me how I save \$50.00 on this set. I enclose a stamp for postage.

Name

Address

(Please PRINT in pencil)

TUNE IN FOR BETTER HEALTH—EXERCISE

Right, P. A. Leonhardt, athletic director of the Central Y. M. C. A. in Chicago, giving his daily Radio exercise from Station KYW.



Below, Bernard Drury, prominent physical culturist, directing thousands of Californians every morning in their exercise. Left, Margie Hipsley, following the instructions closely.



NUMEROUS stations throughout the country are now broadcasting morning exercises for the sleepy commuters. Among them are: WLW, Cincinnati, Ohio, every Monday, Thursday, Friday and Saturday morning at 8 a. m. (Central time); KPO, San Francisco, Calif., every morning at 7 a. m., except Sunday and Monday (Pacific time); KYW, Chicago, Ill., every morning at 6:30 a. m., except Sunday and Monday (Central time); WWJ, Detroit, Mich., every morning except Sunday at 8 a. m.

(Eastern time); WOR, Newark, N. J., every morning except Sunday at 7 a. m. (Eastern time), and KDKA, East Pittsburgh, every morning except Sunday at 7 a. m. (Eastern time).
 "One - two - three - four—repeat," comes from the loud speaker, and the exponents of physical culture and their followers begin their "daily dozen" to a snappy tune. Each morning an invisible gymnasium is transported right to your bedroom, and health exercises and advice are given.



DR. HEAVISIDE DIES PENNILESS; AGE 75

WAS ORIGINATOR OF BASIC THEORY OF RADIO

Englishman Was Great Mathematician and Scientist, but Lived in Penury as Recluse

LONDON, England.—Regarded by many as the world's foremost Radio pioneer, Dr. Oliver Heaviside, known universally in connection with the "Heaviside layer," and as the greatest student of electrical phenomena, has died in Torquay, England, in poverty at the age of 75.

Dr. Heaviside's fame has spread throughout the world, but at his lonely little cottage at Torquay he lived the life of a recluse, seeing no one but those in immediate association with him, and declining firmly to make any appearance in public. It was with extreme difficulty that he could be seen at all. He was a bachelor and devoted himself to his studies to the exclusion of all other interests.

Marconi Used His Theories

For many years Dr. Heaviside lived in extreme penury. Even his gas was cut off, and it was not until Professor J. A. Fleming, the distinguished professor of electrical engineering at the University of London, and some others took the matter up that he was granted a civil list pension and thus ensured a moderate measure of comfort.

Heaviside devoted himself chiefly to the study and interpretation of Clerk Maxwell's theory of electromagnetic radiation and to showing how it can be applied to the solution of problems of practical telegraphy and telephony both with and without wires. The theories he put forward were essential to the invention of

"BROADCAST" COMES FROM BIBLE; CLAIM

NEW YORK.—Broadcast—a word which is well known to devotees of Radio, comes from the parable of the Sower and the Seed as recorded in the eighth chapter of St. Luke's gospel, the Rev. Father John Handy told more than 2,000 parishioners at a recent high mass in the church of St. Paul the Apostle, this city. Father Handy has been placed in charge by the Paulist fathers of the installation of the large Paulist fathers broadcasting station.

Radio and they were consequently acted upon by Marconi in developing his apparatus.

How Heaviside Theory Started

In the early days of Radio, when skeptics were denying the possibilities of electric waves traveling over the mountain of water 150 miles high that lies between England and America, Heaviside maintained, again on the basis of Maxwell's theory, that, as sea water has sufficient conductivity to make it behave as a conductor of the electric waves, they would accommodate themselves to the surface of the sea in the same way as they follow a metallic wire.

He further pointed out the probability that in the higher regions of the air there exists a permanently ionized layer which, being as good a conductor as sea-water, would act as an upper guide to electric waves. Reasons have since been adduced to explain the formation and maintenance of this "Heaviside layer."

Dr. Heaviside was one of the world's greatest mathematicians. His system of simplified mathematics has been adopted in American text-books.

CKY GETS CREDIT FOR FIRST RELAY

Was Pioneer in Canadian Rebroadcasting—Now Performs Feat Regularly

WINNIPEG, Can.—The first rebroadcasting of an American station by one in Canada occurred over a year ago. The original Canadian broadcaster to perform such a relay was CKY, Manitoba Telephone System station here. This announcement is made to correct a previous statement that CKAC, Montreal, had recently performed this feat for the first time in Canada.

CKY is by far the Canadian pioneer as far as rebroadcasting is concerned. The Winnipeg station first rebroadcast KYW, Chicago. Since then the stunt has been repeated many times.

Every week CKY makes it a point to rebroadcast KDKA, WHAS, WOC, WLS, WABN, WBAP, WEAR, CNRR and other well-known stations. D. P. R. Coats, manager of the Winnipeg broadcaster, is a Radio pioneer to whom many innovations, now accepted as studio practice, may be credited.

Football Team for 2LO

LONDON, England.—Dan Godfrey, Jr., conductor of the orchestra at Station 2LO here and an old football player, has been successful in organizing a football team for the London station and the headquarters staff of the British Broadcasting company.

HAZELTINE SUES GREBE COMPANY

Alleges "Synchrophase" Infringes Patents—A. H. Grebe Says Not—Will Test Patent

NEW YORK.—Infringement of the Hazeltine patent is charged by the Hazeltine corporation in a recent suit filed here against A. H. Grebe & Co., Inc., who are alleged in manufacturing the "Synchrophase" receiver to be infringing the neutrodyne patent.

A. H. Grebe, president of the defendant company, says:

"I view this suit as a political gesture intended to create renewed interest in the declining stock issues of the Hazeltine corporation. So far as infringement of the Hazeltine patents by the Grebe company is concerned, the Grebe Synchrophase receiver in no way infringes on the very limited claims advanced by Mr. Hazeltine.

"While in government service Mr. Hazeltine dedicated his invention to the public and then withdrew this dedication. This was not legal. The Grebe company will show that the Hazeltine patent is now in litigation. Its validity is being questioned by the Radio Corporation of America and allied companies because it is alleged to infringe on the Hartley and Rice patents held by the latter companies.

"The Grebe company was offered a Hazeltine patent license prior to the suit, but refused to buy one because of the question of its validity and because it did not cover the circuit now in use by the Hazeltine licensees."

Samoa Hears WHB in WBAP Rebroadcast

J. H. Dixon Says Relay Was as Clear as Original

KANSAS CITY, Mo.—WHB, the station of the Sweeney Automotive and Electrical school here, has recently been conducting some very successful tests in rebroadcasting. Included in the many letters of response is one from Samoa, which is about 6,500 miles from Kansas City. The writer says:

"I heard clearly your rebroadcast of WBAP, Fort Worth, on Sunday, January 3. I listened to the original broadcast of the above piece from WBAP and your rebroadcast equalled the primary rendering in clarity.

"I have to thank your station for very many good Sunday concerts, received regularly during the past year. I am using a 6-tube receiver of my own design."

ABSOLUTE SECRECY IN BRUNSWICK TEST

EVEN ANNOUNCER DOESN'T KNOW ARTISTS' NAMES

Touch of Mystic Added to Broadcasts by Big Phonograph Company's Music Memory Contest

NEW YORK.—Absolute secrecy is the watchword of the Brunswick recording laboratories every Tuesday evening. Heavily veiled ladies dash down deserted corridors and dodge hurriedly through quickly closed doors; puzzled Radio operators sit in a locked ante chamber and modulate the program coming from a microphone to which they have no access; a wondering orchestra plays accompaniments for a singer hidden from them by a heavy screen; and elevator men and electricians stand in little groups with complete bewilderment written large on their faces.

The Radio Music Memory contest inaugurated February 3 by the Brunswick-Balke-Collender company through Stations WJZ, New York, WGY, Schenectady, WRC, Washington, and KDKA, Pittsburgh, has brought into existence the most unique broadcasting methods ever employed. With hundreds of thousands of listeners in every part of the country competing for the \$5,000 cash awards to be given at the end of each month to those guessing the largest number of artists' names and compositions, it is imperative that no whisper of the identities of the singers leak out from the Brunswick studios.

For the first time in Radio history an announcer introduces an artist whom he cannot see. The announcer is seated in a tiny room separated from the broadcasting studio by a heavy locked door.

WHEAT OPERATORS LOSE TO FARMERS

MINNEAPOLIS, Minn.—"Pity the poor farmer," is an expression often heard. Today that is a thing of the past. Out in North Dakota the farmers bring their wheat to market, and wait until they think it is time to sell. They receive their prices via Radio. When prices drop, farmers call the elevator and sell. The elevator manager usually gives them the old price quoted and the elevator has to take the loss. Elevator operators are now planning to get sets.

Prest-O-Lite

RADIO CHART

Voltage of Tubes	No. of Tubes	Type of Tubes (see foot-note)	Total Rated Amperes Drain	Recommended Prest-O-Lite "A" Batteries		Recommended Prest-O-Lite "B" Batteries	
				Order by following Type	Days between Chargeings	Set Manufacturer's Specified Voltage	Order by following Type
5-Volt Tubes <small>C-300 and UV-200 are interchangeable C-301A, DV-2 and UV-201A are interchangeable</small>	1	UV-200	1	69 WHR or 67 WHR	22 16	22½-24	One 24 XRR
	2	UV-201A	½	67 WHR	33		45-48
	2	1 UV-200 1 UV-201A	1½	611 WHR or 69 WHR	22 17	90-96	
	3	UV-201A	¾	69 WHR or 67 WHR	29 22		45-48
	3	1 UV-200 2 UV-201A	1½	611 RHR or 69 WHR	21 14	67-72	
	4	UV-201A	1	69 WHR or 67 WHR	22 16		90-96
	4	1 UV-200 3 UV-201A	1¾	613 RHR or 611 WHR	22 15	45-48	
	5	UV-201A	1¼	611 WHR or 69 WHR	22 17		67-72
	5	1 UV-200 4 UV-201A	2	613 RHR or 611 WHR	19 13	90-96	
	6	UV-201A	1½	69 WHR or 67 WHR	21 15		45-48
	8	UV-201A	2	69 WHR or 67 WHR	21 15	67-72	
				For sets using current at a rate higher than 7 amperes.	69 KRL		22
			67 KPR		13	67-72	
				69 KRL	19		90-96
				69 KPR	16		
3-Volt Tubes	1	UV-199	.06	One 43 MRR	100	22½-24 45-48	Use same XRR and LRR combinations as above for same voltage.
	2		.12		50		
	3		.18		33		
	4	DV-1	.24	Two 43 MRR in Parallel	40	45-48 67-72 90-96	Use same LRR combinations as above for same voltage.
	5	DV-3	.30		40		
	6		.36		33		
1.1-Volt Tubes	1	WD-11	¼	One 23 MRR Twin	48	22½-24 45-48	Use same XRR and LRR combinations as above for same voltage.
	2	WD-12	½	23 MRR Twin	23		
	3	C-11	¾	Two 23 MRR Twins in Parallel	32	45-48 67-72 90-96	Use same LRR combinations as above for same voltage.
	4	C-12	1	23 MRR Twins in Parallel	23		
	5	215A	1¼	Three 23 MRR Twins in Parallel	29	45-48 67-72 90-96	Use same LRR combinations as above for same voltage.
	6	215N	1½	23 MRR Twins in Parallel	23		

Copyright, 1925
The Prest-O-Lite Co., Inc.

69 KPR "A" BATTERY

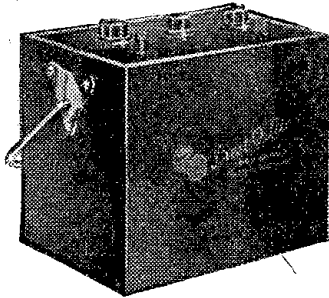

69 WHR "A" BATTERY

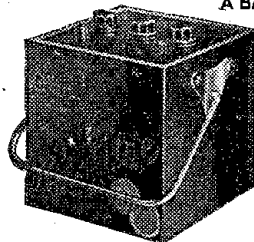

23 MRR TWIN "A" BATTERY

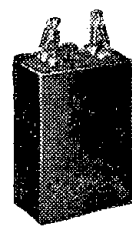

48 LRR "A" BATTERY

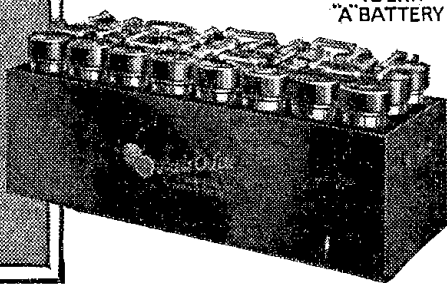

Write today for this free booklet

Whether you have a one-tube set or most advanced multi-tube outfit, you'll find a fund of interesting information in our booklet, "How to fit a storage battery to your set—and how to charge it."

This booklet gives you the complete Prest-O-Lite Radio Chart—technically accurate recommendations covering both "A" and "B" storage batteries for every type of set.

In addition, there is much vitally important data on battery care and upkeep—information that any radio fan will find of real value in keeping his set at its maximum efficiency. Write us at Indianapolis, Ind., for your copy right now.

How to select batteries that run your set for weeks without recharging

Why select storage batteries by guesswork and risk getting one that requires recharging every few days? Buy wisely. Let the Prest-O-Lite Radio Chart guarantee you batteries that fit your set—of ample capacity to bring weeks of fine reception without too frequent recharging.

The above section of the master chart selects Prest-O-Lite "A" Batteries to fit all 5-volt sets. It recommends two sizes for each set, depending upon the days of service you wish between rechargings (based on the average use of your set of three hours a day). The larger capacity battery will be found more desirable unless facilities for frequent and easy recharging are provided. Consult the complete chart at your dealer's for data

on "B" Batteries and also "A" Batteries for low voltage tubes.

In every detail of construction—special structure plates, highly porous separators and superior internal design—these batteries are made to get the best out of your set. To supply the unvarying current essential to fine tuning, efficient tube operation and clear reception.

Prest-O-Lite Batteries offer you truly remarkable savings. Though standard in every respect they are priced as low as \$4.75 and up. They last for years and are all easily rechargeable. See them at your dealer's or write for our booklet, "How to fit a storage battery to your set—and how to charge it."

THE PREST-O-LITE CO., INC., INDIANAPOLIS, IND.
New York San Francisco
In Canada: Prest-O-Lite Company of Canada, Ltd., Toronto, Ont.

Prest-O-Lite



WFAA—"Working For All Alike"

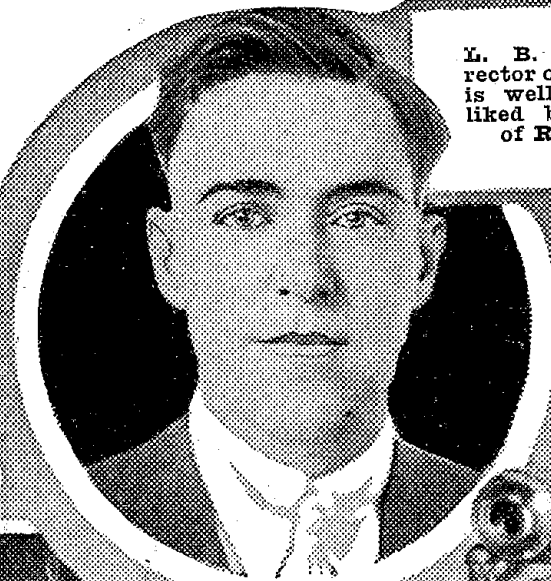
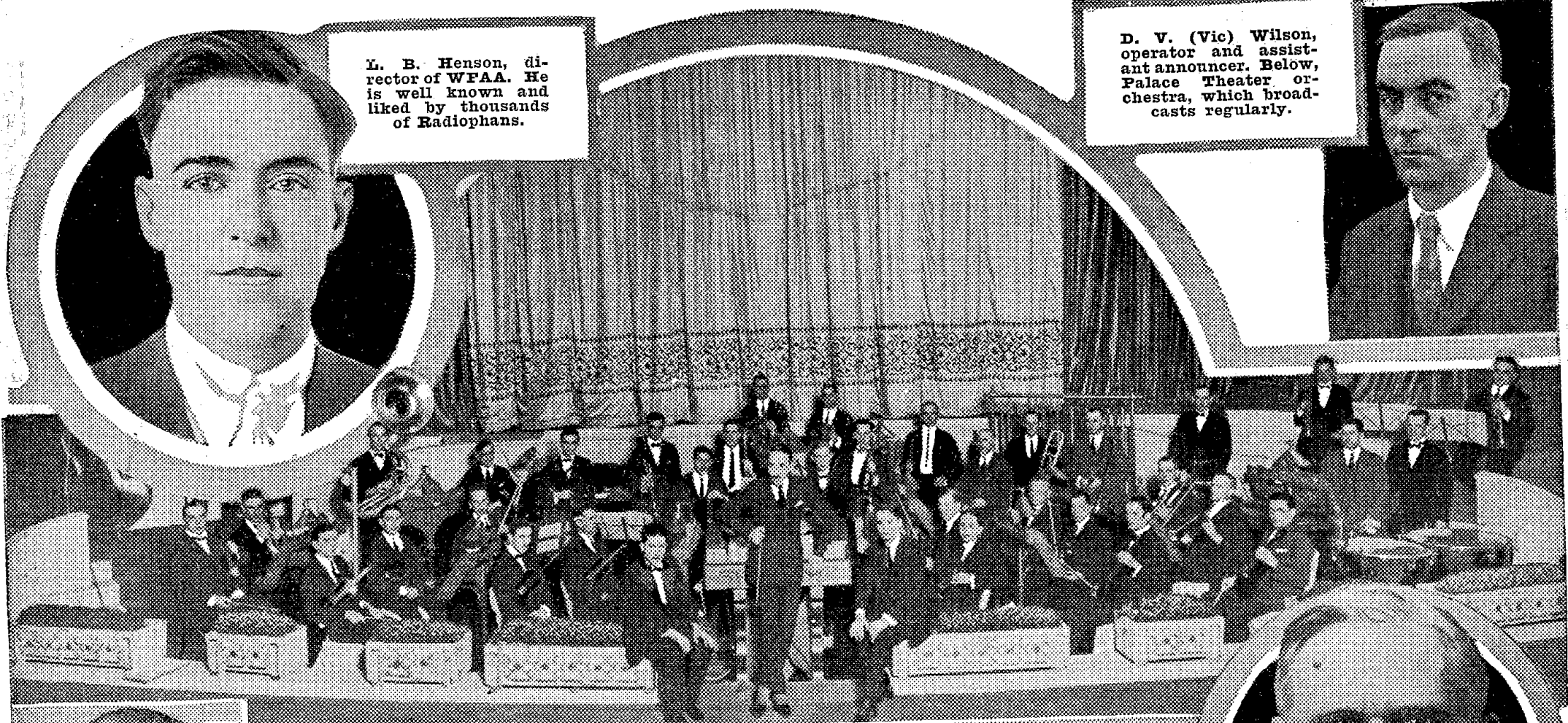

L. B. Henson, director of WFAA. He is well known and liked by thousands of Radiophans.



D. V. (Vic) Wilson, operator and assistant announcer. Below, Palace Theater orchestra, which broadcasts regularly.



Dr. George W. Trnett, pastor of the First Baptist church, who has many admirers.



Ieland Johnson, a finished pianist often heard and greatly appreciated.



Miss Johnye Davis, accompanying pianist at WFAA.

"THEY have lots to brag about, but they don't do it!" Thus tersely spoke a young man bearing the gloom-dispelling name of Joy occupying an office niche near the operating room of WFAA, broadcasting stations of The Dallas News and The Dallas Journal at Dallas, Texas. That's it exactly. They ARE modest down there!

Climbing up the golden stairs may, or may not, be the mode of travel to reach the Heavenly Gates; but one does climb stairs to reach the roof of the greatest newspaper building of the South, on which is located the operating room of WFAA and the office of Supervisor L. B. Henson, adjoining.

And what a splendidly equipped operating room it is! The transmitter and latest improved apparatus are here, telephone, telautograph and signal light system.

The antenna looms 207 feet above the street. The system of wiring was designed by Supervisor Henson and other stations have copied the WFAA antenna system. Due to its remarkable location and efficient operation, amid surroundings peculiar only to the Southwest, this 500-watt station is credited with greater power than stations having much more.

As is usual in Radio offices, there is the inevitable wall map heavily dotted with points of reception; Honolulu, 4,000 miles; England, 6,500 miles, and Australia, 8,500 miles, are most distant points. "But," said Supervisor Henson, "it is the wrong attitude of the public to think only in terms of distance. Clarity, efficiency, selectivity, sensitivity, non-interference and merit are what every listener wants and should strive for."

WFAA is a stickler for quality—quality programs, quality artists and quality broadcasting; it is far better to get good tone quality with moderate volume, than to sacrifice quality to gain intensity.

The studio is located on the third floor of the Dallas News building and is tastefully decorated and lighted and pronounced acoustically perfect. Adjoining is the finest newspaper library in the country; this is used as a reception room for guests and artists; seldom a broadcasting period passes but that guests group around the long table made from a Texas oak tree, and listen to the loud speaker or enjoy the books from the well-filled shelves.

WFAA bears the distinction of being the first in the world to form a Bible class by Radio. Today there are 12,000 members in the WFAA Bible class.

(Continued on page 7.)

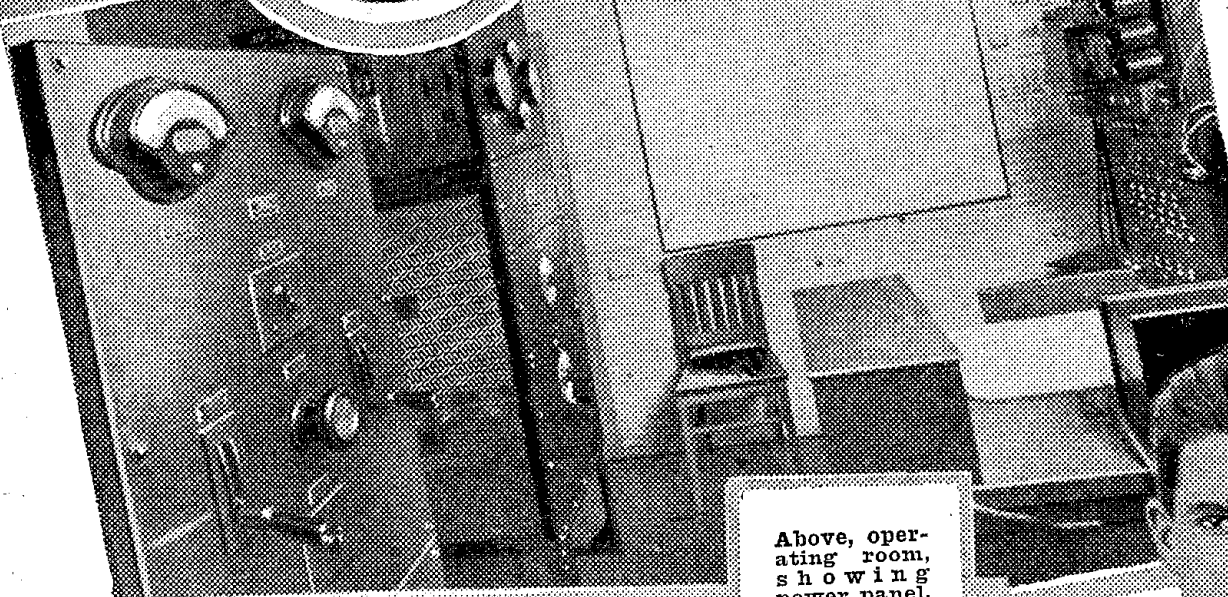

Above, operating room, showing power panel. Below, main studio, showing setting of piano.

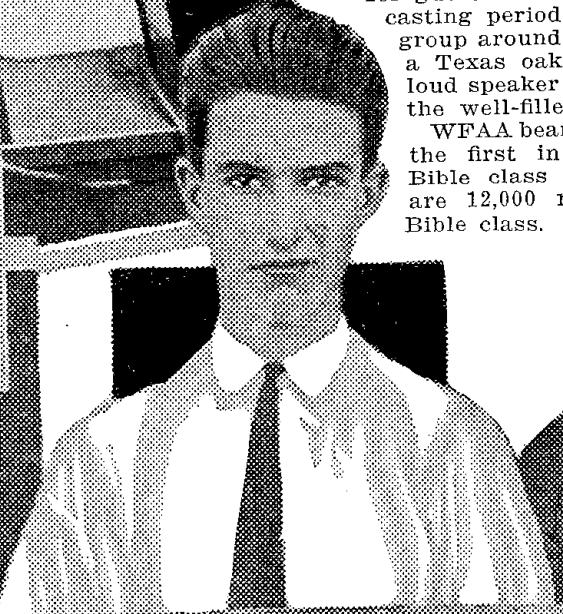
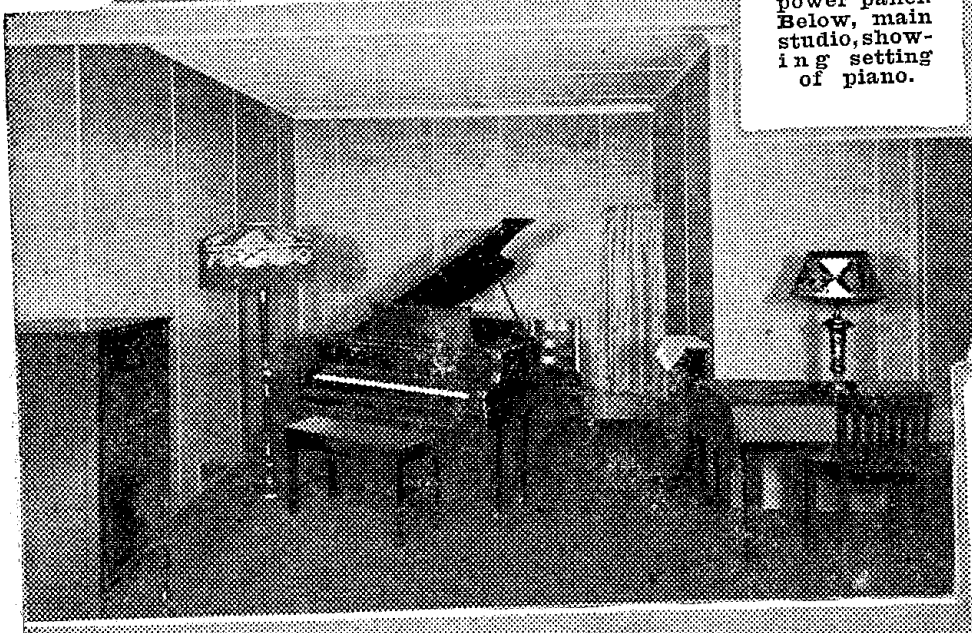

Above, Charles F. Baker, operator at WFAA. Picture shows the look someone got when they said there was a better station than WFAA. Right, Dwight Brown, organist at the Palace theater.



Chas. E. Osborne, physical director at the Y. M. C. A., is a very popular part of the program.

WOULD YOU TRUST THIS MAN'S JUDGMENT ON RADIO?



Commander
DONALD B. MacMILLAN

*The World's Greatest Explorer
Took*

ZENITH

Into the Arctic

MacMillan, when he sailed on his last Polar Expedition in 1923, selected a ZENITH 3-R.

He had to be sure. There are no radio supply stores in the Arctic. He couldn't afford to take a chance. Dependability to him was not alone dependable performance and sturdy construction, but ability to withstand the violent elements ranging from 70° below zero to 50° above. Is there a location in the United States that can offer such drastic conditions for what has been believed to be an ultra delicate instrument?

MacMillan tells us—"Night after night, in that great silent Iceland, we heard the music from your popular cafes—the news day by day—your baseball scores and your great preachers from their pulpits." Think of it!!! Could anything be more convincing evidence in dependable radio construction and performance? Is MacMillan's judgment worthy of your consideration?

Call on your nearest ZENITH dealer and with your own eyes and ears satisfy yourself as to WHY MacMILLAN SELECTED ZENITH. It's worth the test. That's what MacMillan did.

ZENITH
TRADE MARK REG.
LONG DISTANCE
TRADE MARK REG.
RADIO

-Costs More - But Does More

Handled only by selected dealers who give you service. We give the Zenith agency franchise only to dealers who will give you service AFTER THE RADIO IS SOLD. When you buy a ZENITH

we are not through. Our exclusive dealer's serviceman will call once a week or oftener if you want him. This costs you nothing. In other words, Zenith dealers have done your shopping for you.

Write us for the name of your nearest exclusive Zenith dealer

ZENITH RADIO CORPORATION

332 SOUTH MICHIGAN AVENUE

Chicago, Illinois

Zenith Radio Corporation, Dept. M-7,
332 S. Michigan Ave., Chicago, Ill.
Please send me literature and the name of your
nearest Zenith dealer.

Name

Street

City..... State.....

PLAN LINK OF PHONE LINES TO STATIONS

BROADCAST FROM WEAF TO ENTIRE COUNTRY

Overhead Cost Would Remain About Same—Stations to Pay on Pro-Rata Basis

NEW YORK.—Plans involving the eventual linking into a permanent hook-up by means of the telephone lines, stations in eighteen cities for simultaneous broadcasting of programs furnished by Station WEAF, are now nearing completion. The new project provides for the connection to be available every night from 8 to 11 p. m., Eastern time.

An official of the telephone company giving further details of the project explained by saying:

"Using the long lines during their period of slackness, limits us to a network east of the Mississippi. We have fewer lines to the westward, and with differences in time and other features, they have a peak load when the eastern lines are idle.

Boundaries of Network

"Our western boundary for this scheme is set at Minneapolis and Davenport, Iowa, where negotiations have been perfected to give this service. South of that we can go to Fort Worth and Dallas. The southern boundary on the eastern coast will be at Atlanta, Ga., where we are negotiating.

"Another point is that the studio overhead cost of the programs would stay about the same. In the enlarged hook-up broadcast those who pay for the good-will publicity broadcasting will be quoted a rate in proportion to the number of stations they wish to use and the stations broadcasting such a program will be paid a pro-rata share of the receipts. On the other hand, stations taking portions of our sustaining program will be charged pro rata."

Victor Programs Speed Plan

It is also said that the new project had received considerable impetus from the success of the recently inaugurated Victor record programs.

The stations now under contract to participate in the new project, all of which will, for instance, take the Victor program, though there will be different hook-ups on other items of the WEAF programs, include the following: WCAP, Washington; WJAR, Providence; WEEI, Boston; WDBH, Worcester; WFI and WOO, Philadelphia, dividing time; WCAE, Pittsburgh; WGR, Buffalo; WWJ, Detroit; WCCO, Minneapolis; WOC, Davenport; WTIC, Hartford, and WEAR, Cleveland.

WFAA, DALLAS, TEXAS

(Continued from page 5)

WFAA audiences are generous with applause; commendation coming in over telephone and telegraph wires is ever welcome.

In keeping with the great newspaper institution by which it is sponsored, WFAA might well be said to have an editorial policy also. To interpret such a policy requires minds of peculiar capability. L. B. Henson possesses qualities of correct judgment, inspiration, initiative and vision. Interconnectual service of many stations tied together by wire trunks, rather than installation of high-power stations or the rebroadcasting on higher wave of low-wave signals received, are some of the few things we may expect, declared Henson. That newspapers will probably find more profitable and serviceable uses for their stations than they have up to now, is also an assurance, he states.

Correlating the endeavors of Supervisor Henson are the various members of the personnel. A. Calhoun, chief announcer, lovingly known as Adam—and we use the word "lovingly" advisedly—has delighted untold thousands with the clarity of his enunciation. Brilliant, capable, witty, Calhoun is in a class alone. It is a keen disappointment to his many admirers that his photograph does not accompany this sketch, but as aforementioned—they ARE modest down there at WFAA.

C. F. Baker and D. B. Wilson, announcers, do their bits and do them exceedingly well.

Mary Carter Toomey charms hundreds of listeners, big and little, with her bedtime stories, told in her inimitable manner.

"The Red-Headed Girl" delights WFAA audiences each week with her softly modulated solos and quaint little melodies on the piano. "Do you ever hear my music or my songs?" she queried, and when we assured her that we had, with a bird-like turn of her famous head, she smiled: "Do you like 'em?"

That is the spirit of WFAA—they want folks to hear 'em and they want everybody to like 'em. And most of us do both!

KDKA recently attempted to broadcast the noise of Niagara Falls.

FANS HAVE CHANCE TO NAME SONG HIT



"Danny" Engle (Colgrove Studio Photo)

that you think might make a popular song a success. Send in as many suggestions as you wish, including your name and address.

The contest closes on Monday evening, March 16, at 10 o'clock. At that time "Danny" Engle, well-known WGR comedian songster, whose idea this is, will be in the studio at WGR accompanied by Henry Murtaugh, organist for the Lafayette theater, and Fred Dempsey.

The winning title must be selected, a

Station Changes

Opening of the new studio for Station WGI will take place in about sixty days. The studio will be located on the roof of the Houghton and Dutton building, Boston. The power will be increased from 100 to 500 watts. * *

Six new class A and one class B stations were licensed by the department of commerce recently, while one station transferred from class A to B. The new stations are as follows: KFVB, Warner Bros., Hollywood, Calif., 252 meters, 500 watts; KFWC, L. E. Wall and C. S. Myers, Upland, Calif., 211.1 meters, 10 watts; WGBX, University of Maine, Orono, Me., 252 meters, 10 watts; WGBY, Progress Sales Co., New Lebanon, Ohio, 218.8 meters, 30 watts; KFUZ, Y. M. C. A., Virginia, Minn., 248 meters, 10 watts; WGBW, Valley theater, Spring Valley, Ill., 212.6 meters, 20 watts.

The class B station is WMBF, Fleetwood Hotel Corp., Miami Beach, Fla., 384.4 meters, 500 watts.

The transfer from class A to class B is KFMQ, University of Arkansas.

fitting song put to the title and everything must be read by 11:30 o'clock the same evening to announce the name of the person sending in the winning title and at that time the song will be sung by "Danny" Engle. There will be no prizes except the fun of seeing this peculiar contest through.

Lots of Movie Stars Help KFWB Opening

Warner Brothers, Film Makers, Go on Air in West

LOS ANGELES.—The location of the new Hollywood station, which has been kept such a close secret during the past month, is on the lot of Warner Brothers' West Coast studios.

For some time rumor has had it that the new station would be owned and operated by a motion picture concern but it was not until construction of the towers began, and long after the transmitter itself was actually installed, did the news leak out.

With call letters of KFWB, indicative of "Kall—Films of Warner Brothers," wave length of 252 meters, and power 500 watts, the new station was to make its bow at 8 p. m. Pacific time on the night of March 4 with the greatest assemblage of film luminaries that has ever been brought before any microphone in the world.

This is the first station in the country to be owned and operated by a motion picture producing corporation.

20,000 in Nature League

SPRINGFIELD, Mass.—In less than three weeks WBZ, Westinghouse station here, has enrolled 20,000 members in a Radio nature league whose sole aim is to assist in the preservation of all desirable wild life in America. Thornton W. Burgess, sponsors the league.

Balkite Battery Charger. Charges 6 volt "A" storage batteries.

Price \$19.50
West of Rockies \$20
In Canada \$27.50

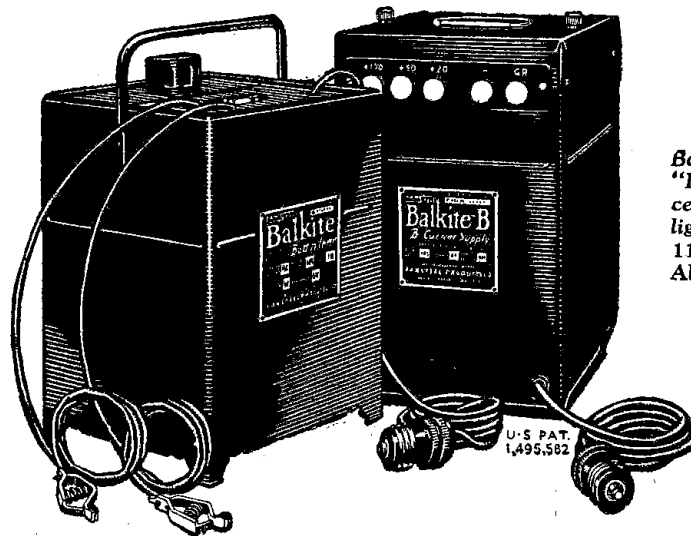

Balkite "B"—replaces "B" batteries and dry cells. Operates from light socket. 60 cycle 110-120 A. C. current. Also 50 cycle model.

Price \$55
In Canada \$75

A uniform, constant power supply for both "A" and "B" circuits

Here at last is a convenient and unflinching power supply for your radio set. Balkite Radio Power Units furnish constant uniform voltage to both circuits, and will give your radio set greater clarity, power and range. The Balkite Battery Charger keeps your "A" storage battery charged. Balkite "B" replaces "B" batteries entirely and supplies plate current from the light socket.

Based on the same principle, both the Balkite Battery Charger and Balkite "B" are entirely noiseless. They have no bulbs or moving parts, and nothing to break, adjust or get out of order. They have a very low current consumption, are simple and efficient in operation, and can be put in use at any time by merely connecting to a light socket. Both are guaranteed to give satisfaction.

Sold by leading radio dealers everywhere

FANSTEEL Radio Power Units

BALKITE BATTERY CHARGER.—BALKITE "B" PLATE CURRENT SUPPLY

Manufactured by FANSTEEL PRODUCTS COMPANY, Inc., North Chicago, Illinois

AN EVENING AT HOME WITH THE LISTENER IN IN CENTRAL TIME (SEE INSTRUCTIONS FOR USE BELOW)

Table with columns for Station and City, Met., Saturday, Sunday, Monday, Tuesday, Wednesday, Thursday, Friday. Lists various radio stations and their broadcast schedules.

Instructions for Use—All the hours above are given in Central Standard Time. If your city uses Eastern Time, add one hour to each of the periods stated; if your city uses Mountain Time, subtract one hour; if your city uses Pacific Time, subtract two hours. This table includes only the evening and, on Sunday, the later afternoon programs.

STATIONS IN ORDER OF WAVE LENGTHS USED

Table with columns for Meters Call, listing stations in order of wave lengths used.

17-17-17 always gets KDKA on every Day-Fan

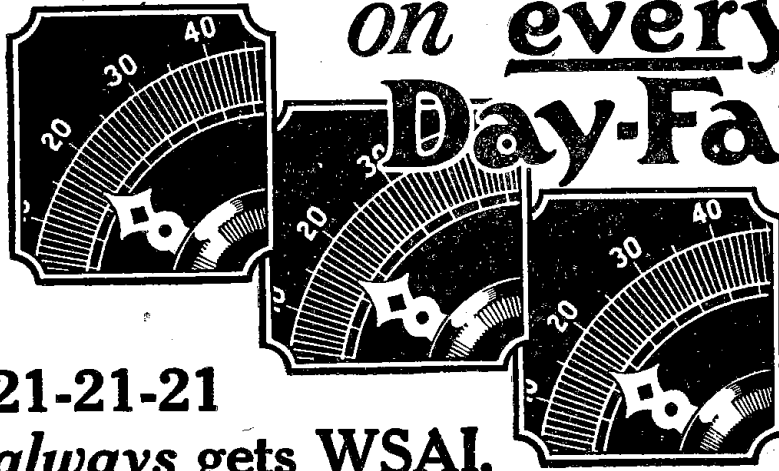

21-21-21 always gets WSAI. 47-47-47 always gets WOS. For any particular station all dial settings are the same on every Day-Fan--anywhere--with any antenna.

All uncertainty is eliminated. You know even before you get your Day-Fan, just where to set the dials to pick up any station you desire. Could any set be more simple?

Tone? Listen in on a Day-Fan and you will have to revise your ideas of tone. Selectivity? The equal of any five-tube set made. Appearance? The popular brown mahogany finish in the finest of cabinet work. Volume? So strong you have to dampen it for many stations. Range? Spans the continent. Models? Five different types. Price? \$90 to \$285.

Where else can you possibly get such values?

The Day-Fan is on display at nearly all leading Radio Dealers. You owe it to yourself to see it and hear it.

The Dayton Fan & Motor Co. Dayton, Ohio For 36 years manufacturers of High-Grade Electrical Apparatus.

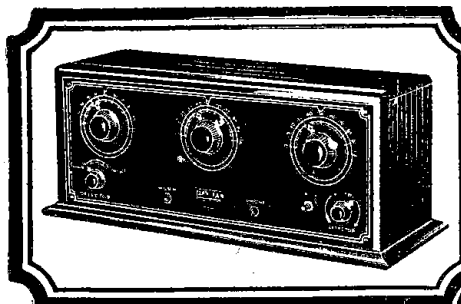

OEM-7-\$98

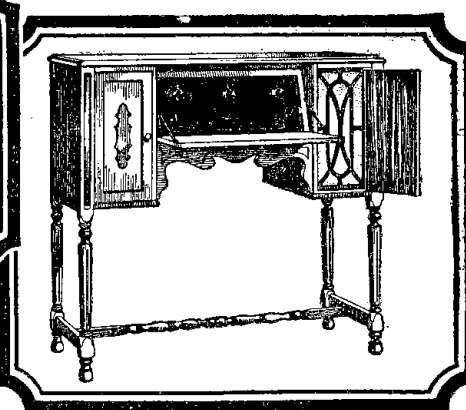

DAYTONIA \$285.00

and other models

Day-Fan RADIO

A YEAR AHEAD

BOYS GIVE MUSICAL PROGRAM AT WIP

Saturday, March 7

Saturday, silent night for: CFAC, CHNC, CKY, KFDM, KFKU, KFKX, KFMQ, KLX, KSAC, WBAP, WBAV, WCAI, WGBD, WCX, WDFW, WEAD, WEAR, WEBW, WEEL, WEMC, WGST, WHA, WHAZ, WHB, WHO, WJY, WKAQ, WMAQ, WQAI, WOI, WOO, WOS, WRBC.

Eastern Time Stations

The following schedules of programs are given in Eastern time. To change to Central time, subtract one hour; Mountain time, subtract two hours; Pacific time, subtract three hours.

- CKAC, Montreal, Can. (425),** 7 p. m., kiddies' stories; 7:30, Windsor hotel concert orchestra; 8:30, concert, Post Office entertainers; 10:30, dance orchestra, Windsor hotel, Harold Leonard's Red Jackets.
- KDKA, E. Pittsburgh, Pa. (399.1),** 6 p. m., dinner concert, Westinghouse band; 7:30, children's period; 7:45, last minute helps to Bible school teacher, Carman Cover Johnson; 8:30, concert.
- WAHG, Richmond Hill, N. Y. (315.6),** 12-2 a. m., special program, Glen C. Smith's Paramount orchestra.
- WBR, New York, N. Y. (272.6),** 8 p. m., Theodore Armstrong, violinist; 8:30, vocal selections; 8:20, Bible questions and answers; 8:45, Theodore Armstrong.
- WBZ, Springfield, Mass. (333.3),** 7:05 p. m., bedtime story for the kiddies; 7:15, sketches, United States naval history, E. S. R. Brandt; 7:30, Hotel Kimball trio; 8, William A. Murphy, baritone; 8:15, John Cassato, violinist; 8:30, Imperial male quartet; 8:45, John Cassato, violinist; 9, Imperial male quartet; 9:15, Anita O'Connell, pianist; 9:30, Hal Wheeler; 9:45, Imperial male quartet; 10, Hotel Brunswick orchestra.
- WCAE, Pittsburgh, Pa. (461.3),** 4:30 p. m., Ed. Lally's Rendezvous Cabaret orchestra; 6:30, dinner concert, William Penn hotel; 7:30, Uncle Kaybee; 7:45, special feature; 8:00, concert, artist-students, studios of Charles Le Sour.
- WCX, Detroit, Mich. (516.9),** 4:15 p. m., musical program; dinner concert, Book-Cadillac hotel.
- WEAF, New York, N. Y. (492),** 4-4:30 p. m., Middlebury college glee club; 6-7, dinner music, Waldorf-



Wayne W. Myers (left) gives the amusing dialect impersonations on the late Saturday night programs of WEBB. August Werner (above), baritone, represents the Rivoli and Bialto theaters Mondays at WNYC, New York. Mary Holliday is the director of the Holliday trio of Ft. Hayes hotel which will be heard again Wednesday, March 11, at WEAQ, Columbus.

- Astoria hotel; 7-7:15, Thuel Burnham, pianist; 7:15-7:30, Agnes Brennan, pianist; 7:30-7:50, Fred J. Turner, stories for boys; 7:50-8:15, Joseph Wilber-shield, violinist; 8:15-11:30, special musical program; 11:30-12:30 a. m., Vincent Lopez and his Hotel Pennsylvania orchestra.
- WFI, Philadelphia, Pa. (394.5),** 3 p. m., "The Robbery," play by Glen Nor high school students; 4, Bob Brown's Northeast high school dance orchestra; 6:30, Meyer Davis' Bellevue Stratford concert orchestra; 7, Sunny Jim; 8, Bankers' association banquet.
- WBS, New York, N. Y. (316),** 9-9:10 p. m., interview with Mrs. William Laimbeer, assistant cashier, National City bank, by Terese Rose Nagel; 3:10-3:20, Howard Kirsch, violinist; 3:20-3:30, interview with "Lady Edison"; 3:30-3:40, Howard Kirsch, violinist; 3:40-3:50, "Appreciation of Caricature, Victor de Pauw; 3:50-4, Howard Kirsch; 6-6:30, Uncle Geebee; 6:30-7:30, Dance orchestras; Alfred Seeger, tenor; 9:30-9:45, Sam Comly, "Inside Movie Chats"; 9:45-10:30, Bayway Refinery band; 10:30-11, Erva Giles, pianist; 11-12, Radio vaudeville, May Singli Breen, Peter de Rose, Avy la Skere.
- WGR, Buffalo, N. Y. (319),** 6-7:30 p. m., Hallpyrd string quartet dinner music.
- WGY, Schenectady, N. Y. (379.5),** 9:30 p. m., dance music, Phil Romano's orchestra.
- WHN, New York, N. Y. (360),** 6:30-7 p. m., violin solos, Olcott Vail; 7:30-7:35, health talk, Dr. Landis; 8:30-9, Strand Roof orchestra; 11:30-12:30 a. m., Roseland dance orchestra.
- WIP, Philadelphia, Pa. (508.2),** 3 p. m., Gerald O'Dell and his entertainers; 6:05, Charles Masters' Hotel St. James dance orchestra; 7, Uncle Wip's bedtime stories; Conshohocken M. E. junior choir, direction Helen E. Koch; 8, Lenten meditations, E. A. E. Palmquist; 8:15, Mayor W. Freeland Kendrick presents "The Boy in Music"; the Civic Junior symphony orchestra; Boy Council harmonica band; Civic Junior band, direction Albert N. Hoxie; 10:05, Howard Lanin's dance orchestra; 11:05, Karl Bonawitz, organist.
- WJZ, New York, N. Y. (454.3),** 4:30-5:30 p. m., Sherry's Tea orchestra; 7-8, Freddie Rich and Hotel Astor orchestra; 8-8:15, "Art for Laymen," Walter M. Grant; 8:15-8:30, Elizabeth Barkley, contralto; 8:30-9, U. S. Marine band; 9:30-10, Darl Bethman, baritone; 10-10:15, Dorothy Miller Duckwitz, pianist; 10:30-11:30, Joseph Knecht's Waldorf-Astoria orchestra.
- WLIT, Philadelphia, Pa. (394.5),** 2:30 p. m., Mrs. Louis Calvert Morris, soprano; Margaret P. Steinruck, contralto; Russell Moore, bass; Herbert Stahl, tenor; Marcella North, pianist; Calvin Trivito, pianist; 7:30, Arcadia cafe concert orchestra.
- WNYC, New York, N. Y. (526),** 6:30-7:30 p. m., Sam Wording and his Club Alabam orchestra; 7:35-8, dance program, Chateau four; 8:15-8:25, talk; 8:30-8:45, song recital; 9-9:30, Police quartet; 10:10-10:20, travel talk.

Central Time Stations

The following schedules of programs are given in Central time. To change to Eastern time, add one hour; Mountain time, subtract one hour; Pacific time, subtract two hours.

- KFNF, Shenandoah, Ia. (266),** 6:30 p. m., concert from Rockport, H. W. Leach, director.
- KFRU, Bristow, Okla. (395),** 7:30-8 p. m., international Sunday school lesson; 9-12, special Saturday program.
- KSD, St. Louis, Mo. (545.1),** 8 p. m., concert, St. Louis Symphony orchestra, Rudolph Ganz, conductor.
- KTHS, Hot Springs National Park, Ark. (374.8),** 8:30-10 p. m., concert orchestra, Charles Elliott; 10-11, dance frolic, Meyer Davis New Arlington hotel orchestra, Jacques Renard, director.
- KYW, Chicago, Ill. (535.4),** 6:35-7 p. m., children's bedtime story, Uncle Bob; 7-7:30, dinner concert, Congress hotel; 8-8:58, Agnes Klein, soprano; Stephenson and Heather; Garfield Park Baptist church quartet; Mrs. Daisy Gissing, soprano; Mrs. Beulah Sandgren, contralto; Thomas W. Benson, tenor; Leslie W. Dollahan, baritone; Dorothy Marquart, director; 9:15, Youth's Companion.
- WBCN, Chicago, Ill. (266),** 6-6:45 p. m., dinner concert, Harold's orchestra; 7-8, George R. Cleveland, "Hobby Club Man"; Mrs. Goldie Cornell, soprano; Jack Heath and Eddie Downs, singers; 8-12, popular program, Marie Wright, soprano; Jack Parker, tenor; Midway Gardens orchestra; George R. Cleveland, author; Les Cameron, tenor; Elizabeth Emmett Malone, soprano; Triangle entertainers; George Forsyth, boy tenor; Murphy sisters, harmony duo; Honolulu serenaders; George Collins, mouth organist; Concord trio; Alvin Fry, tenor; Florence Tenney, blues singer; 12-1, early morning concert, Clifton Newton Moore, harmonica king; Big Boy Yagie, pianist; G. Howard

- Gowen, pianist; Jimmy White, tenor; Wally Johnson, tenor.
- WCAL, Northfield, Minn. (336.9),** 7:30 p. m., St. Olaf vs. Carleton basketball game; 12, midnight musicale.
- WCCO, Minneapolis-St. Paul, Minn. (416.4),** 2:30 p. m., matinee musical; 8, "Fireside Philosophies," Rev. Roy L. Smith; 8:30, music; 10, Minneapolis Athletic

- club orchestra, C. C. Holcomb, one stringed instrument soloist; Lowry male quartet.
- WDAF, Kansas City, Mo. (365.6),** 3:30-4:30 p. m., Star's Radio orchestra; 6-7, piano, tuning-in number; address, Roger W. Babson; the Tell-Me-a-Story Lady; Trianon ensemble; 11:45-1, Nighthawk frolic, Merry Old Chief, Plantation players, Eddie Kuhn's Kansas City Athletic club orchestra.
- WEBB, Chicago, Ill. (370.2),** 7-8 p. m., Oriole orchestra; Radio Sunday school lesson, Dr. Herbert W. Virgin; musical bits, Riviera theater; 9-10, Oriole orchestra; Eleanor Gilmour, soprano; Pat Barnes; Langdon brothers; Marie Kelly, reader; 11-12, Oriole orchestra; Banks Kennedy; Loos brothers; Langdon brothers; Ned and Ches; Wayne Myers, story teller; Kay Ronayne, soloist; Marie Kelly, reader.
- WFAA, Dallas, Tex. (475.9),** 8:30-9:30 p. m., Boy Scout program, H. W. Wester, director; 11-12, band recital, De Molay boys.
- WGN, Chicago, Ill. (370.2),** 6 p. m., organ recital, Lyon & Healy; 6:30-7, dinner concert, Drake concert ensemble, Blackstone string quintet; 8-9, classical concert, Fae G. Searcy; 10-11, Don Bestor Drake dance orchestra; Jerry Conley Blackstone dance orchestra.
- WHAS, Louisville, Ky. (399.8),** 4-5 p. m., selections, Louisville Conservatory of Music; 7:30-9, concert, auspices Arthur Findling.
- WLS, Chicago, Ill. (344.6),** 7 p. m., lullaby time, Ford and Glenn's trip to Panama; 7:20, national barn dance, Glenn's Cornhuskers; Ralph Emerson, organist; Isham Jones and his College Inn orchestra; Harmony Girls; Walter Peterson; Ford and Glenn, Foxy Dave; 11, Senate theater revue.
- WLW, Cincinnati, Ohio (422.3),** 6 p. m., dinner hour concert, Selinsky instrumental quintet; 8:30, Henry Lange's Hotel Sinton orchestra.
- WMAQ, Chicago, Ill. (447.5),** 6 p. m., Lane Technical high school orchestra; 8, Russell Pratt, Fred Daw; 8:30, Radio photologue, "Russia," Frederick A. Mackenzie; 9, Chicago theater revue.
- WMC, Memphis, Tenn. (499.7),** 8:30 p. m., program, Marie Worden, director.
- WOAI, San Antonio, Tex. (394.5),** 11 a. m., services, First Presbyterian church; 7:30 p. m., services, Central Christian church; 9:30, "Robin Hood," WOAI entertainers.
- WOAW, Omaha, Nebr. (526),** 6 p. m., dramatic hour, Davis Studio of expression; 6:30, music; 6:45, dinner program, Brandeis store restaurants; 7:30, weekly address, auspices Omaha Chamber of commerce; 9, program, auspices Omaha Printing company; 11, Frank W. Hodek, Jr., and his Nighthawk orchestra; 11:30, Arthur Hays, organist.
- WOC, Davenport, Ia. (483.6),** 5:45 p. m., chimes; 6:30, sandman's visit, Val McLaughlin; 6:50, Sunday school lesson, Rev. M. A. Getzendaner; 9, Jeannette Brewbaker, soprano; Emil Hass, reader; Robert McGregor, baritone; 11, Louis Connor and his LeClaire hotel orchestra; Peter MacArthur, baritone.
- WQJ, Chicago, Ill. (447.5),** 7-8 p. m., dinner concert, Ralph Williams and his Rainbo Garden orchestra; Laverne Hansen, pianist; Esther Kellogg, violinist; Agatha Karlen, reader; 10-3, Ralph Williams and his Rainbo Skylarks; Melodians, Laurie, Eddie, Bennie; Jerry Sullivan; Harry Geise; Alfred Tweed, harmonica and guitar soloist; Clarence Theaders, tenor; George A. Little, Larry Shay, song writers; Yukona Cameron, soprano; Rick, Whalen and Gardner, harmony singers.
- WSB, Atlanta, Ga. (428.3),** 5-6 p. m., T. P. Appel, baritone; Pauline Landen, pianist; bedtime story, Bonnie Barnhardt; 6, Sunday school lesson, Dr. Marion H. Hull; 8-9, excerpts, "The Crimson Eyebrows," opera, Mrs. Carroll Summer's vocal class; 10:45, Ed and Grace McConnell.
- WSUI, Iowa City, Ia. (483.6),** 7:30 p. m., Iowa-Northwestern basket game.

(Continued on page 10)

Headliners of the Week

OF INTEREST to everybody, particularly boys, will be the program Saturday from WIP given entirely by boys. Mayor W. Freeland Kendrick will present a demonstration of "The Boy in Music." Several hundred boys, all talented musicians, will show what the Philadelphia boy knows about A sharps and B flats. KHJ's "A Night of Comic Opera," will be popular Sunday. The Martin Music company with a reputation for good music is sponsoring the program and J. Howard Johnson, who has an uncanny knack for arranging entertainments, is the director.

Monday, Knute Rockne, the famous football coach of Notre Dame university, known to all sport fans for his wonderful team, will talk at WCCO, Minneapolis. CHNC has a new trio called the CHNC trio which makes its Radio debut under this name tonight.

The South Park Junior college will present the Tuesday program at KFDM, Beaumont. The school band will play for the first time before a microphone. This is also Brunswick

night at Stations WJZ, WRC, WGY, KDKA and KYW.

A unique feature of the WLW program for Wednesday will be the Russian dances and songs by Maxim Kastyluck. Mr. Kastyluck will perform the dances on the WLW studio stage as he explains them.

The folk songs of many nations have been heard over the Radio. Thursday the American folk ballad will come into its own when W. L. Simmons, instructor of English at the Georgia School of Technology, will give a talk on this interesting subject at WGST.

Friday night is another evening when burry accents will confuse the fan and make him think he is hearing Scotland. WHB is dedicating a program to the St. Andrews society of Kansas City. John Smith will give greetings to the Scotch folk and Dr. James W. Fifield will tell about a visit to Scotland. The debate between the Boston University and Dartmouth college is scheduled for this same evening at WEEL, Boston.

ROCKNE TO TALK MONDAY AT WCCO

Saturday, March 7

(Continued from page 9)

Mountain Time Station

The following schedule of program is given in Mountain time. To change to Eastern time, add two hours; Central time, add one hour; Pacific time, subtract one hour.

KOA, Denver, Colo. (322.4), 9-12 midnight, dance music, Joe Mann and his Rainbow-Lane orchestra.

Pacific Time Stations

The following schedules of programs are given in Pacific time. To change to Eastern time, add three hours; Central time, add two hours; Mountain time, add one hour.

KFI, Los Angeles, Calif. (467), 5:30-6 p. m., Examiner's musical half hour; 6:45-7, "Inspirational Psychology," Dr. Clyde Sheldon Shepard; 7-7:45, Lake Arrowhead dance orchestra, Mel Lemon, director; 7:45-8, "The Bookshelf," Miss Nancy; 8-9, Examiner community program; 9-10, classic instrumental trio; 10-11, Packard Radio club; Varsity trio, Merrill La Fontaine, Howard Coy, Harold Allen, Ruth and Lillah Carlson, Ray West and Barney Weber.

KFOA, Seattle, Wash. (455), 4-5:15 p. m., Olympic hotel orchestra; 6:45-8:15, Rhodes Dept. Store program; 8:30-10, Seattle Times dance music; 10:05-11, Eddie Harkness and his orchestra.

KFSG, Los Angeles, Calif. (278), 10:30-11:30 a. m., sunshine hour; 3:30-4:30 p. m., Hampton Gray Studio program, G. Nichols; Roy Reid Brignall and others; 7:30-9:30, auditorium service, special music and sermon on Divine Healing, Aimee Semple McPherson, pastor.



Adelaide De Loca, concert contralto, is a regular feature of the WAHG, Richmond Hill, programs. Miss DeLoca is a well-known concert artist who has a rich contralto voice that broadcasts perfectly.

KGO, Oakland, Calif. (361), 4-5:30 p. m., concert orchestra, Hotel St. Francis; 8, program, Magnavox company; Melody Makers; Elsa Fehlow Trautner, soprano; Carey male quartet; Antone Tomcic, concertina soloist; Eva Gruninger Atkinson, contralto; Ray Nealan, tenor; "The Sunny Side of the Street," Thomas A. Boyer; 10-11, Henry Halstead's orchestra.

KGW, Portland, Ore. (492), 10 p. m., Colburn's Melody men.

KHL, Los Angeles, Calif. (404.1), 6-8:30 p. m., Art Hickman's Biltmore hotel concert orchestra, Edward Fitzpatrick, director; 6:30-7:30, Prof. Walter Sylvester Hertzog, stories of American history; David Durand, screen juvenile; Katherine McGuire, Jane Adele Riley, readers; Davis Jean Enger; Uncle John bedtime story; 8-10, program, Los Angeles Flue club; 10-11, Earl Burnett's Biltmore hotel dance orchestra; 11-2 a. m., The Lost Angels of KHL, Majestic Six orchestra.

KNX, Hollywood, Calif. (337.6), 5:45-6:15 p. m., Wuritzer pipe organ studio; sports talk, Sid Ziff; 6:15-7:30, dinner hour music; 8-10, KNX feature program; 10-11, Abe Lyman's Coconut Grove dance orchestra; 11-1 a. m., Hollywood night, Hollywood celebrities; 1-2, Nighthawk club.

KPO, San Francisco, Calif. (429.5), 2:30-3:30 p. m., Mount Tamalpais Military academy band; 3:30-5:30, Gene James' Rose Room Bowl orchestra; 6:20, garden hints; 8-12, Art Weidner's dance orchestra.

Sunday, March 8

Sunday, silent night for: CFAC, CHNC, CKAC, KFKU, KFKX, KFMQ, KKLX, KOA, KSAC, WAHG, WBAV, WCAE, WCX, WDAF, WEAD, WEBW, WFI, WGBS, WGST, WHA, WHAS, WHAZ, WJY, WKAQ, WLBL, WLIT, WMAQ, WMC, WOI, WRC, WTAM, WTAY, WWJ.

Eastern Time Stations

CFCA, Toronto, Can. (356), 7 p. m., service, Walmer Road Baptist church.

CKAC, Montreal, Can. (425), 4:30 p. m., band, Hull city talk, Mayor Cousineau.

KDKA, East Pittsburgh, Pa. (309.1), 11 a. m., church service; 2:30 p. m., Westinghouse Symphony orchestra; 4, Dr. Charles Heinrich, organist; 4:45, vesper service, Shady Side Presbyterian church; 6:30, dinner concert, Pittsburgh Athletic association; 7:30, services, Point Breeze Presbyterian church, Rev. Percival H. Barker, pastor.

WBBR, New York, N. Y. (272.6), 10 a. m., Staten Island School of music, Clifford Chapin, Edward Petri, Lelah Koval; 10:15, Clifford Chapin, violinist; 10:30, Bible lecture; 11, Staten Island School of music; 11:15, Lelah Koval, pianist; 9 p. m., Watchtower orchestra; 9:30, Watchtower string quartet; 9:40, Bible lecture, Judge Rutherford; 10:10, violin duets, George Twasrosch, Carl Park; 10:20, Watchtower orchestra.

WCAE, Pittsburgh, Pa. (461.3), 10:45 a. m., services, Rodef Shalom temple; 3 p. m., People's Radio church services; 4, Prof. Otto Kalfets, pianist; 6:30, dinner concert, William Penn hotel.

WCAU, Philadelphia, Pa. (278), 5:15 p. m., recital; 5:30, Bible talk, Rev. Dr. John B. Stockwell; 6, dinner concert, Meyer Davis' Hotel Pennsylvania concert orchestra, direction Lon Chassey; 8:30, Paul Sneed's orchestra.

WCX, Detroit, Mich. (516.9), 10:30 a. m., church services.

WDWF, Providence, R. I. (440.9), 10 a. m., chimes; 5-6:45 p. m., Venetian serenaders; Philharmonic pipe organ.

WEAF, New York, N. Y. (492), 8:15-9:20 p. m., Roxy and his gang, Capitol theater; 9:20-10:15, organ recital.

WEAR, Cleveland, Ohio (389.4), 1-2 p. m., symphony concert, Allen theater orchestra; 3:30-5, twilight concert, Ivan Francis and his Hotel Cleveland orchestra.

WEEI, Boston, Mass. (475.9), 3:45-5:30 p. m., men's conference, Bedford Branch, Y. M. C. A.; 7:20-9:15, Roxy and his gang, Capitol theater; 9:15-10:15, organ recital, Columbia university.

WFI, Philadelphia, Pa. (394.5), 10:20 a. m., services, Arch Street Methodist Episcopal church; 4:30, chapel services, Central Y. M. C. A.

WGBS, New York, N. Y. (316), 3:30-4:30 p. m., program, Piccadilly theater.

WGY, Schenectady, N. Y. (379.5), 10:30 a. m., service,

First Reformed church, Rev. Clayton J. Potter; 3:25 p. m., WGY symphony orchestra; 5, organ recital, Dr. Frank Sill Rogers; 7, Roy Keefer, violinist; 7:30, First Church of Christ Scientist; 8:45, symphony concert, Waldorf-Astoria orchestra.

WNN, New York, N. Y. (369), 3-4 p. m., program, Queens County Christian Endeavor; 4:30-5, Coleridge dance club; 5-5:30, Roseland dance orchestra; 5:30-6, Olcott Vail and his string trio; 10-10:45, Gem Razor entertainers; 10:45-11:15, Janssen's Hofbrau Commanders orchestra; 11:15-11:45, Vanity club revue; 11:45-12:15 a. m., Connie's Inn revue; 12:15-12:45, Harry Richman and his entertainers.

WIP, Philadelphia, Pa. (508.2), 3:15 p. m., Civic Junior symphony orchestra; 4, services, auspices German town Y. M. C. A.; "Interracial Co-operation," lecture by George E. Haynes; 7:15, services, Holy Trinity church; 8:30, Germantown theater orchestra; Karl Bonawitz, organist.

WJZ, New York, N. Y. (454.3), 11-12 m., church services; 2:30-3:30 p. m., Radio Bible class, Federation of churches; 4-5, vesper services, St. Georges church; 7-8, Nathan Abas' Hotel Pennsylvania orchestra; 8-8:15, Julitta Cumis, soprano; 8:15-8:30, Anna Pinto, harpist.

WLIT, Philadelphia, Pa. (394.5), 2 p. m., Lenten services; 2:30, Arcadia cafe concert orchestra, Feri Sarkoz, director.

WMAK, Lockport, N. Y. (265.5), 10 a. m., service, First M. E. church, service, Rev. Paul Burt, minister.

WNYC, New York, N. Y. (526), 9-11 p. m., Brooklyn Mark Strand theater program, Edward L. Hyman, director.

WOO, Philadelphia, Pa. (508.2), 10:30 a. m., services, Bethany temple; 2:30 p. m., Sunday school services, Bethany temple; 6:05, organ recital, Clarence K. Bawden; 7:30, services, Bethany temple; organ recital, Clarence Kalfets.

WWJ, Detroit, Mich. (352.7), 2 p. m., Detroit News orchestra; 7:30, services, St. Paul's Episcopal cathedral.

Central Time Stations

CKY, Winnipeg, Can. (450), 7 p. m., service, St. Stephen's church.

KFDM, Beaumont, Tex. (315.6), 9 p. m., sacred program, Young People's Service League, St. Mark's Episcopal church.

KFNH, Shenandoah, Ia. (266), 10:45 a. m., church service, M. E. church; 3 p. m., services, Men's Gospel team; 6:30, services, Golden Rule Circle; 8, church service, Christian church.

KTHS, Hot Springs National Park, Ark. (374.8), 11 a. m., church service; 8:30-10 p. m., Meyer Davis New Arlington hotel orchestra; 10-11:15, dance concert, Phil Baxter's Singing orchestra.

KYW, Chicago, Ill. (535.4), 11 a. m., Central church service, Dr. Frederick F. Shannon, pastor; 4-5 p. m., artists' program; 7, Chicago Sunday Evening club, speaker, Dr. Hugh Black.

WBAP, Fort Worth, Texas (475.9), 11 a. m., services, St. Paul's M. E. church, Rev. C. D. Meade, pastor; 4 p. m., concert, Rialto theater; 11-12, midnight frolic, Ted Miller's Crazy hotel orchestra.

WBCN, Chicago, Ill. (266), 10:30-12 m., sermon, Rev. R. A. White; 4-5 p. m., Lain & Son classical concert; 5:15-6:15, talk, Rev. Richard D. Hughes; 7-8, classical hour, Ballou music and dramatic bureau artists; 8-10, Eddie Shepard, concertist; Midway Garden orchestra; Borden brothers; Clifton Newton Moore, harmonica soloist; Florence Eastman, mezzo-soprano; "Big Boy" Yagle, pianist.

WCAL, Northfield, Minn. (336.9), 8:30 p. m., sacred program, sermon, Rev. C. E. Nordberg; Leonard Olesgaard, tenor; Ellen Froegner, pianist; Donald Rice, cornetist; Evelyn Johnson, mezzo-soprano.

WCBZ, Zion, Ill. (344.6), 8 p. m., mixed quartet; Misses Wiedman, double duo; Mary Sweeney, soprano; Mrs. Katherine Crow, contralto; celestial bells; William C. Dunn, euphonium soloist; Paul Stewart, cornetist; Mrs. Hester Robinson, reader; Bessie Wiedman, pianist.

WCCO, Minneapolis-St. Paul, Minn. (416.4), 11 a. m., Trinity Baptist church; 4:10 p. m., House of Hope Presbyterian church; 7:30, First Baptist church; 9:15, classical concert.

WDAF, Kansas City, Mo. (365.6), 4-5 p. m., classical music, Star's studio; 5-5:30, Sunday school lesson, Dr. Walter L. Wilson.

WEBH, Chicago, Ill. (370.2), 5-6 p. m., twilight musicale; 7-9, artists' program.

Book concern; 11, services, Church of Covenant, Dr. Frank Stevenson; 7:30 p. m., services, Emmaus Evangelical Lutheran church; Dr. E. P. Dannenfeldt, pastor; 8:30, concert, Western and Southern orchestra, William Koop, director; mixed quartet.

WAW, Omaha, Nebr. (526), 9 a. m., Radio chapel service, Rev. R. H. Brown; 2:15 p. m., matinee program; 6, Bible study period, Mrs. Carl R. Gray; 9, musical chapel service, Emanuel Baptist church, Rev. John L. Barton.

WCC, Davenport, Ia. (483.6), 1 p. m., Palmer Little Symphony, Erwin Swindell, conductor; song numbers, Charles R. Hall; 2, "The Common Denominator of Christianity," Rev. Palfrey Perkins; 8, church service, First Unitarian church, Rev. Clara Cook Helvie; vocal numbers, Mrs. Edna Crenzy Bradley.

WOI, Ames, Ia. (270), 10:45 a. m., college chimes; 11, chapel services, Fred M. Hansen.

WORD, Batavia, Ill. (275), 7-8 p. m., I. B. S. A. choral singers; Adelaide Jones, pianist; Bible lecture, W. H. Woodley.

WOS, Jefferson City, Mo. (440.9), 7:30 p. m., services, First Presbyterian church.

WQJ, Chicago, Ill. (447.5), 10:30 a. m., services, People's church, Dr. Preston Bradley; 8-10 p. m., Ralph Williams and his Rainbo Garden orchestra; Grace Nelson, 14-year-old pianist; Alvin Becker, soprano; Lancaster Smith, bass; Mrs. Lancaster Smith, accompanist; Maxine Moody, violinist; Kenneth Sterling, baritone.

WRBC, Valparaiso, Ind. (276), 7:30 p. m., church service, Emmanuel Lutheran church.

WSA, Atlanta, Ga. (428.3), 11 a. m., First Presbyterian church service; 5-6 p. m., services, Capitol View Baptist church; 7:30, Wesley Memorial church service.

WSUL, Iowa City, Ia. (483.6), 7 p. m., children's hour, Mrs. Alice McLeod Mills; 9-9:30, familiar hymns, Ruth Rowland, soprano.

Mountain Time Stations

CFAC, Calgary, Can. (430), 7 p. m., Knox Presbyterian church, George Dickson.

KOA, Denver, Colo. (322.4), 11 a. m., First Congregational church, Rev. Robert Hopkin; 7:50, First Church of Christ Scientist.

Pacific Time Stations

KFI, Los Angeles, Calif. (467), 10-10:45 a. m., Los Angeles Church Federation service; 4-5 p. m., vesper services directed by Dr. Davis of Davis Musical college; 6:45-7, Raditorial; 7-8, stage acts, specialties and orchestra from Metropolitan theater; 8-9, instrumental and vocal recital of classical nature; 9-10, Examiner, Cinderella Ballroom orchestra from Long Beach; 10-11, Packard Eight orchestra, Bill Hennessey, director.

KFSG, Los Angeles, Calif. (278), 10:30-12:30 p. m., complete morning service of Angelus temple with sermon, Aimee Semple McPherson, pastor-evangelist; noon auditorium service and sermon, Temple choir and Silver band; 7-9:45, regular evening services of the temple opening with special musical hour; 10-11, organ recital, Esther Pricke Green.

KGO, Oakland, Calif. (361), 11 a. m., service, First Unitarian church; 3:30, concert, KGO Little Symphony orchestra; Arthur S. Garbett; 8, services, First Unitarian church.

KGW, Portland, Ore. (492), 10:30 a. m., service, First Presbyterian church, Dr. Harold Leonard Bowman, pastor; 3 p. m., municipal concert; 6, church services, Portland Council of churches; 7, Colburn concert orchestra; Fay Wentz Welch, soprano.

KHJ, Los Angeles, Calif. (404.1), 10:30-12:30 a. m., complete morning service and organ recital of First Methodist Episcopal church, Arthur Blakely, organist, and E. E. Helms, pastor; 6:30-7, Art Hickman's Biltmore hotel concert orchestra, Edward Fitzpatrick, director; 7-7:30, Arthur Blakely, organist; 8-10, program, Martin Music company, arranged by J. Howard Johnson, presenting "A Night of Comic Opera."

KIS, Los Angeles, Calif. (293), 10:45-12:30 p. m., services, Church of Open Door, Dr. French E. Oliver, pastor; 6-6:45, vesper musical hour with short scriptural talk; Rev. Pike; 7-9:30, complete evening services of the Church of Open Door, musical program and sermon, Dr. French E. Oliver, pastor.

KNX, Hollywood, Calif. (337.6), 5-6:15 p. m., Radio sunset service, Rev. Chas. F. Aked and Rev. Frank Dyer from Ambassador hotel theater; 7-7:45, International Bible Students' association musical hour;

WCAE, Pittsburgh, Pa. (461.3), 6:30 p. m., dinner concert, William Penn hotel; 7:30, Uncle Kaybee; 7:45, special feature; 8:30, concert, studios of Mme. Lelia Wilson-Smith; 9, concert, A. & P. Gypsy, string ensemble; 10, program; 11, light, the Press-Kaybee; Blackstone theater orchestra.

WCX, Detroit, Mich. (516.9), 4:15 p. m., musical program; 6, dinner concert, Book-Cadillac hotel; 8:30, musical program.

WEAF, New York, N. Y. (492), 4-4:15 p. m., Dorothy Wilder, pianist; 4:15-4:25, Beatrice Mink, reader; 4:45-5, children's stories, John Barrar; 6-7, dinner music from Waldorf-Astoria; 7-7:30, Gustave Langens, clarinetist; 8:30-9, Cushman's Sons, Inc.; 9-10, A. & P. Gypsies; 10-10:30, Michael Markel's society orchestra; 10:30-11:30, Ben Bernie's Hotel Roosevelt orchestra.

WEAR, Cleveland, Ohio (389.4), 7-8 p. m., musical program, Loeu's State theater.

WEEI, Boston, Mass. (475.9), 8:30 p. m., Big Brother club; 7:15, Dok-Bienbour and his Stefanians; 7:55, Pathe News flashes; 8, program, C. Leroy Lyon, director; 9, A. & P. Gypsies.

WFI, Philadelphia, Pa. (394.5), 3 p. m., Comb's Conservatory Girl's glee club; 3:30, "The Home and Its Relation to the School," H. A. Marsh; 6:30, Meyer Davis' Bellevue Stratford concert orchestra; 7, Sunny Jim and the Kiddies.

WGBS, New York, N. Y. (316), 3-3:10 p. m., interview with Ruth Shepley and James Remmie of Cape Smoke company; 3:10-3:20, Olive Williams, soprano; 3:20-3:30, talk, "Song Sharks," C. L. Dennis; 3:30-3:40, Olive Williams; 3:40-3:50, Spanish lessons, Professor Perez de Vegas; 3:50-4, Olive Williams; 6-6:30, Uncle Gebebe.

WGY, Schenectady, N. Y. (379.5), 2 p. m., "Home Making a Challenge to the Intellect," Florence E. Winchell; 6:20, talk, Harold Anson Bruce; 6:40, dinner music, Hotel Ten Eyck trio; 7:15, "Design in Home Furnishings," Prof. Annette J. Warner; 7:30, Grace Klugman Swartz, soprano; Harold Tracy Cooper, bass; Alice H. McEneny, pianist.

WHAZ, Troy, N. Y. (379.5), 9 p. m., John J. Fogarty, baritone; Era of Super Power," W. S. Murray; 10, Besseler Polytechnic students glee club.

WNN, New York, N. Y. (360), 6:30-7 p. m., violin solos, Olcott Vail; 7-7:15, fashion chats, Mme. Belle; 7:30-7:35, health talk, Dr. Landis; 7:35-8, Hotel Carlton

Walter Dunham, pianist, is one of the WOAI entertainers heard every Sunday and Thursday at WOAI, San Antonio, Tex. Mr. Dunham is a popular artist in southern Texas.



Terrace orchestra; 8-8:05, "Storage Batteries," H. B. Shontz; 8:05-8:30, Roseland dance orchestra; 8:30-8:35, "The Rise of Joseph B. Schusser," H. W. Carluog; 8:30-9:30, Littmann's Employees orchestra; 9:30-10, Dan Gregory and his Crystal Palace orchestra; 10-11, Jack Shack; 12-12:30 a. m., Wigwam club revue; 12:30-1, Harry Rose and his Silver Slipper revue.

WIP, Philadelphia, Pa. (394.5), 3 p. m., recital, students Clarence Fuhrman studio; 4, Eleanor Merimo Swayne, soprano; Flora Ripka, pianist; 6:05, Charles Masters' Hotel St. James dance orchestra; 7, Uncle Wip's bedtime stories.

WJZ, New York, N. Y. (454.3), 4-4:15 p. m., Helen Shapiro, soprano; 4:15-4:30, Joseph P. Anderson, tenor; 4:30-5:30, Fred Hall's Royal Terrace orchestra; 7-8, Bernard Levittow's Hotel Commodore dinner concert; 8-8:10, Wall Street Journal review; 8:10-8:20, NYU Air college; 8:45-9:30, Academy of Political Science conference; 9:30-10, "Only for T. B. M.'s."

WLIT, Philadelphia, Pa. (394.5), 4:30 p. m., Marcella North, pianist; 7:30, Dream Daddy's bedtime stories; 8:30, Elsie Miller, soprano; Stephen Badger, tenor; 9:20, movie review, James Nassar; 9:30, Stanley theater symphony orchestra; features from Stanley theater; 10:03, Arcadia cafe dance orchestra; 10:45, features from Pay's Knickerbocker theater.

WMAK, Lockport, N. Y. (265.5), 8 p. m., musicale, Tonawanda American Legion.

WNYC, New York, N. Y. (526), 7-7:30 p. m., Harry Ash and his Royal orchestra; 7:35-7:40, health talk; 7:45-8:45, studio program; 10:15-10:25, "Trend of the Times," Dr. Sydney N. Usher.

WOO, Philadelphia, Pa. (508.2), 4:45 p. m., organ recital, Mary E. Vogt; 7:30, A. Candelori's ensemble from Hotel Adelphia; 8, concert from WEAF; 10:03, organ recital, Mary E. Vogt; 10:30, Vincent Rizzo's Hotel Sylvania dance orchestra.

WOR, Newark, N. J. (405), 2:45-3 p. m., Y. M. C. A. talk; 3:45-4, fashion talk, Charm magazine; 6:15-7:30, Dave Hindman's Cinderella orchestra; 8-8:15, Perry and Russell; 8:30-9:15, program, Branford theater; 9:30-9:45, "The Romance of the Finger Ring," Dr. Vizeletly; 9:45-10:45, Dr. Spaeth and his studio party; 10:45-11:15, concert, Carolinians.

WTAM, Cleveland, Ohio (389.4), 6-7 p. m., dinner music, Guy Lombardo and his Royal Canadians; 8-9, program from WEAF; 9-11, band concert, Tall Cedar's band; 11-12, organ recital.

WWJ, Detroit, Mich. (352.7), 3 p. m., Detroit News orchestra; dinner concert; 8, Detroit News orchestra; Steller quartet.

Central Time Stations

KFKX, Hastings, Nebr. (288.3), 9:30-11:30 p. m., program, auspices, Rexall Drug store of Oxford.

KFKU, Lawrence, Kan. (275), 6:30 p. m., piano tuning-in number; 7, music; 7:15, "Training for Track Athletics, Training for the Sprints," Karl Schlade-man; 7:30, basketball game, K. U. vs. Washington university; 8:30, "Choosing the Play," Prof. Allen Crafton; 4:45, elementary Spanish lesson X.

KFNH, Shenandoah, Ia. (266), 6:30 p. m., Seedhouse concert.

KFRU, Bristow, Okla. (395), 7-8 p. m., Oklahoma educational hour; 8-10:30, musicale.

KSAC, Manhattan, Kan. (340.7), 7:20 p. m., college band; 7:30, "The Nature and Habits of Sheep," C. E. Reed; 7:40, college band; 7:50, "Composition and Properties of Milk," N. E. Olson; 8, special program, Livestock Improvement association.

KSD, St. Louis, Mo. (545.1), 8 p. m., "Appreciation of Music," Dr. A. G. Pohlman; concert, St. Paul's band.

KTHS, Hot Springs National Park, Ark. (374.8), 8:30-10 p. m., program; 10-11, dance frolic; 12:15-1:15, dance frolic, Meyer Davis orchestra.

WBAP, Fort Worth, Tex. (475.9), 7:30-8:30 p. m., Andrew Hennbill and double quartet; 9:30-10:45, popular music, Ward's "Trail Blazers"; 12-1, dance music, Swayne's Southern serenaders.

WCAL, Northfield, Minn. (336.9), 11 p. m., Elnor Overland, organist; Mark Harkins, tenor.

WCBZ, Zion, Ill. (344.6), 8 p. m., McElroy Saxophone quintet; P. B. Newcomer, cornetist; George Beem, marimba soloist; John D. Thomas, baritone; Mrs. J. D. Thomas, soprano; Edith Carey, contralto; Wesley Carey, reader; Edwin Sach, pianist.

WCCO, Minneapolis-St. Paul, Minn. (416.4), 6, sport talk, Knut Rockne; 8, "Baby Chick," N. E. Chapman; 8:15, "The Romance of Butter," John Brandt; 8:30, hockey game, Minneapolis-Duluth; 10, Original George Osborn's Nicollet hotel orchestra.

(Continued on page 11)

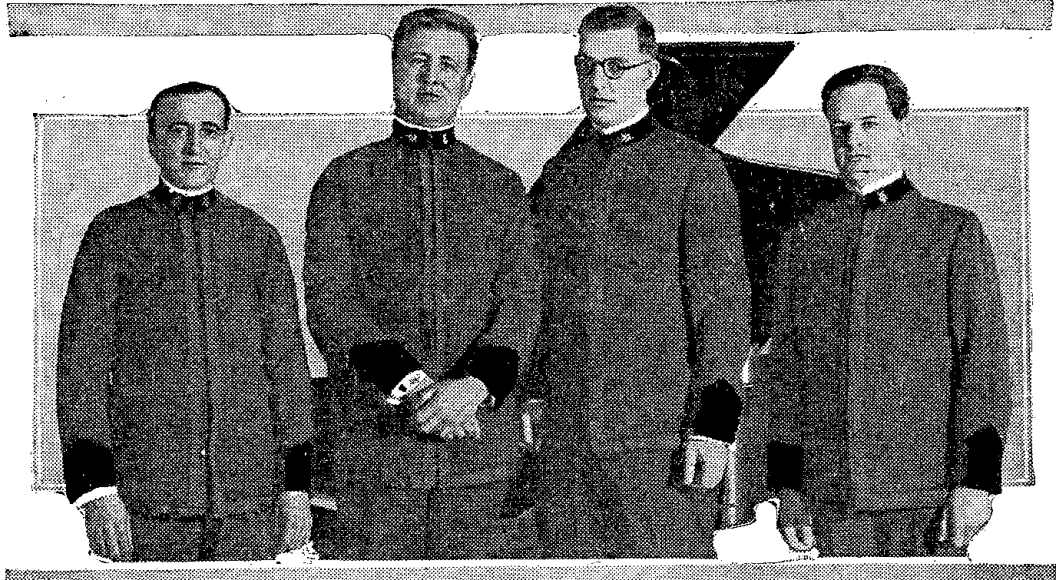

Here is the Reo quartet, left to right, Raymond Hamilton, James Lyon, Kenneth Buckingham, and Raymond Lyon Bowers, popular artists who sing Thursday at WREO, Lansing.

WEBW, Beloit, Wis. (268), 4:30-5:30 p. m., Sunday vesper services.

WEMC, Berrien Springs, Mich. (286), 11 a. m., sacred music, Radio Lighthouse choir; Cecil Woods, bass; Martha Hutchinson, soprano; Mrs. Lela Beuchell, contralto; 11:40, sermon, Pastor W. R. French; 8:15 p. m., sacred music, Radio Lighthouse choir; music, S. D. church.

WFAA, Dallas, Tex. (475.9), 6-7 p. m., Radio Bible class, Dr. William M. Anderson; 7:30, City Temple service, Dr. L. D. Young; 8:45-9:30, solos, Miss Porter; Southern Methodist university quartet; 9:30-11, Grace Methodist church orchestra, Earle D. Behrends.

WGN, Chicago, Ill. (370.2), 11:45 a. m., program, Chicago theater; 2 p. m., organ recital, Lyon & Healy; 3, Tribune master artist concert, Apollo quartet; 3:30, Chicago Musical college; 9-10, "An Evening with the Composers," Charles H. Gabriel, Jr.

WHAS, Louisville, Ky. (399.8), 9:57 a. m., organ music; 10, church service, Broadway Baptist church, Rev. Dr. Russell Johnson Pirkey; 4-5 p. m., vesper service, Fourth Avenue Seventh Day Adventist church, Rev. Robert J. Bryant, pastor.

WH

SCOTCH PROGRAM FEATURE OF WHB

Monday, March 9

(Continued from page 10)

WDAF, Kansas City, Mo. (365.6), 3:30-4:30 p. m., program, Newman and Royal theaters; 6-7, piano tuning-in number on the Duo-Art; Cecile Burton, reader; weekly request story night, the Tell-Me-a-Story Lady; Trio ensemble; 8-9, around the town with WDAF; 11:45-1, Nighthawk frolic, Merry Old Chief, Plantation players.

WEBB, Chicago, Ill. (370.2), 7-8 p. m., Oriole orchestra; Dan Russo, violinist; Ted Florito, celeste soloist; Riviera theater; 9-10, Oriole orchestra; Demis sisters; Dean Remick, pianist; Kay Bonayne, songs; 11-12, Oriole orchestra; Loos brothers; Jack Penewell, guitarist; Frank Magini, soloist; Banks Kennedy, soloist.

WEBW, Beloit, Wis. (268), 8-9 p. m., songs, fraternity groups.

WEMC, Berrien Springs, Mich. (286), 8:15 p. m., Colerian string trio.

WGST, Atlanta, Ga. (270), 9-10 p. m., "Talk Back Home" hour, students.

WHAS, Louisville, Ky. (399.8), 4-5 p. m., Louisville Conservatory of Music; selections, Alamo theater organ.

WHB, Kansas City, Mo. (365.6), 7-8 p. m., "A Talk on Salesmanship," L. L. Adams.

WHO, Des Moines, Ia. (526), 7:40-9 p. m., Bernice Courtright Hines, soprano; Wallart Donaldson, Scotch soloist; Guy Wilcox, accompanist; Irwin Miller, violinist; Great Western Silverstring serenaders; Edward Adams, popular song soloist; 11:15-12, Carlos Meier, organist.

WLW, Cincinnati, Ohio (423), 6 p. m., dinner hour concert, Selinsky instrumental quintet; 8, Times-Star orchestra, William Kopp, director; Marjory Garrigus Smith, pianist; Howard Halford, tenor; Joseph Vito, harpist.

WMAQ, Chicago, Ill. (447.5), 6 p. m., Chicago theater organ recital; 6:30, Hotel LaSalle orchestra.

WMC, Memphis, Tenn. (499.7), 8:30 p. m., Hotel Gayoso concert orchestra.

WOAW, Omaha, Nebr. (526), 5:45 p. m., public news period, Eugene M. Konecky; 6, Arthur Hays, organist; 6:30, West sisters' string quartet; 9, father and son program; 9:30, program, auspices, Auto and Electric Radio corporation.

music; 7-8, program, West Coast theaters, Inc.; 8-10, RNK feature program; 10-11, Goodrich Silvertown orchestra; Lillian May Challenger, soprano; 11-12, Abe Lyman's Coconut Grove dance orchestra.

KPO, San Francisco, Calif. (429.5), 4:30-5:30 p. m., Rudy Seiger's Fairmont hotel orchestra; 5:30-6:30, children's hour stories, Big Brother; "Amateur Five" orchestra; 7-7:30, Rudy Seiger's Fairmont hotel orchestra; 8-9, Theodore J. Irwin, organist; 9-10, program, Pearl Hassock Whitcomb, contralto; 10-11, Gene James' Rose Room Bowl orchestra.

Tuesday, March 10

Tuesday, silent night for: CHNC, KFKU, KFKX, KFNH, KLX, KOA, WAHG, WC.V, WBBR, WCBDB, WEAQ, WEMC, WGST, WHA, WHAZ, WHO, WMAQ, WOI, WOO, WOS, WRBC, WSUI.

Eastern Time Stations

CKAC, Montreal, Can. (425), 7 p. m., kiddies' stories; 7:30, Windsor hotel concert orchestra; 8:30, Frontenac Breweries; 10:30, Windsor hotel concert orchestra.

KDKA, East Pittsburgh, Pa. (309.1), 6:15 p. m., dinner

two-piano concerto, Minna Rutenberg and Simon Cohn; 9-9:10, astrology talk, Belle Bart; 9:10-10, duets and solos, Marie Nicholson and Elizabeth Gibbs.

WGY, Schenectady, N. Y. (379.5), 2 p. m., address, member, Woman's club of Schenectady; 2:30, Stephen E. Boisclair, organist; 6:30, dinner music, New Kenmore hotel orchestra; 7:30, "Physics of Tuning in," Dr. Frederick W. Grover; 7:40, Paula Smith, pianist; Beatrice Zellinger, soprano; Mary C. Nally, contralto; Raymond Becker, baritone; Raymond Zwack, violinist; Morton J. Hall, tenor; 9, Brunswick hour of music; 10:30, Meyer Davis orchestra; 11:30, Stephen E. Boisclair, organist.

WHN, New York, N. Y. (360), 12:30-1 p. m., Charles Strickland's Palais D'Or orchestra; 2:15-3:15, program, Loew's State theater; 6:30-7, Strand Roof orchestra; 7-7:05, cross word puzzle contest; 7:30-7:35, health talk, Dr. Landis; 7:35-8:05, Lou Menin's Mah Jong Inn orchestra; 8:30-9, Dave Harman and his Cinderella orchestra; 10:15-10:30, Loew's vaudeville headliners; 10:30-11, the New Rockwell Terrace revue; 11-11:30, Everglades revue; 11:30-12, Club Abnam orchestra; 12-12:30 a. m., Ted Lewis and his Parody club orchestra.

WIP, Philadelphia, Pa. (508.2), 4 p. m., W. G. Boyd, baritone; Wayne Brannan trio; 4:15, Henrietta Knowles, contralto; 6:15, Harvey Marburger's dance orchestra; 7, Uncle Wip's bedtime stories; 8, "Timely

quartet; 7:30, "Control of Grasshoppers in Alfalfa," J. W. McColloch; 7:40, college quartet; 7:50, "Essential Features of a Poetry House," J. H. McAdams.

KSD, St. Louis, Mo. (545.1), 6 p. m., concert, Benjamin Rader's orchestra; 9, concert, Shurtleff college glee club.

KTHS, Hot Springs National Park, Ark. (374.8), 8:30-10 p. m., variety concert.

WBAP, Fort Worth, Tex. (475.9), 7:30-8:30 p. m., artists, Baptist seminary, Frank Cheek, director; 9:30-10:45, program, Travis Avenue Baptist church.

WBCN, Chicago, Ill. (266), 7-8 p. m., Lulu Raben, violinist; Irene Irma Zinter, pianist; Mrs. Edna Tribnitz, vocalist; Anne Shaw, pianist; 8-12, Marie Wright, soprano; Midway Gardens orchestra; Axel Christensen, pianist; F. H. McDonald, talk; Limerick girls; Pinner Briggs, humorist; Edith McCune, reader; Fred Rose, tenor; Melody girls; Famous four; Alvin Fry; Al Phillips, tenor; Larry Loser, tenor; 12-1:30, Pirate ship.

WCCO, Minneapolis-St. Paul, Minn. (416.4), 6:30 p. m., Minneapolis Athletic club orchestra; Edward C. Peery, tenor; 7:30, lecture; 7:45, booklogue, Leonard Wells; 8-10, national program from WEAF.

WDAF, Kansas City, Mo. (365.6), 3:30-4:30 p. m., Star's Radio trio; 5-5:30, weekly child talent program, Mrs. A. E. Robinson, director; 6-7, piano tuning-in number on the Duo-Art; the Tell-Me-a-Story Lady; Radio piano lesson, Maudellen Littlefield; Trio ensemble; 11:45-1, Newman Nighthawk night.

WEBW, Beloit, Wis. (268), 7:30-8:30 p. m., concert, Fairbanks, Morse company.

WGN, Chicago, Ill. (370.2), 6 p. m., organ recital, Lyon & Healy; 6:30-7, dinner concert, Drake Concert ensemble, Blackstone string quintet; 8-9, Simco band; 10-11, Don Bestor Drake dance orchestra.

WHAS, Louisville, Ky. (399.8), 4-5 p. m., selections, Louisville Conservatory of Music; 7:30-9, concert, Eddie Rosson and his orchestra; "Billy and Jane" stories.

WHB, Kansas City, Mo. (365.6), 7-8 p. m., "Shall We Scrap the Ten Commandment?" Dr. Andreas Bard; choir, First English Lutheran church; 8-10:30, program, Anna Brennan Burns, director; Gerald Burke, pianist; Pauline Webb, reader; Miles Reiger, violinist; Geraldine O'Brien, pianist; "Things Worth While," Dr. Fifield; Crawford-Rutan band.

WLS, Chicago, Ill. (344.6), 6:30 p. m., Ralph Emerson, organist; 6:30, Senate studio; 7, lullaby time; 7:15, Florence K. White; 7:30, Grace Wilson; 7:45, Anthony Wons; 8, R. F. D. program, Ford and Glenn;

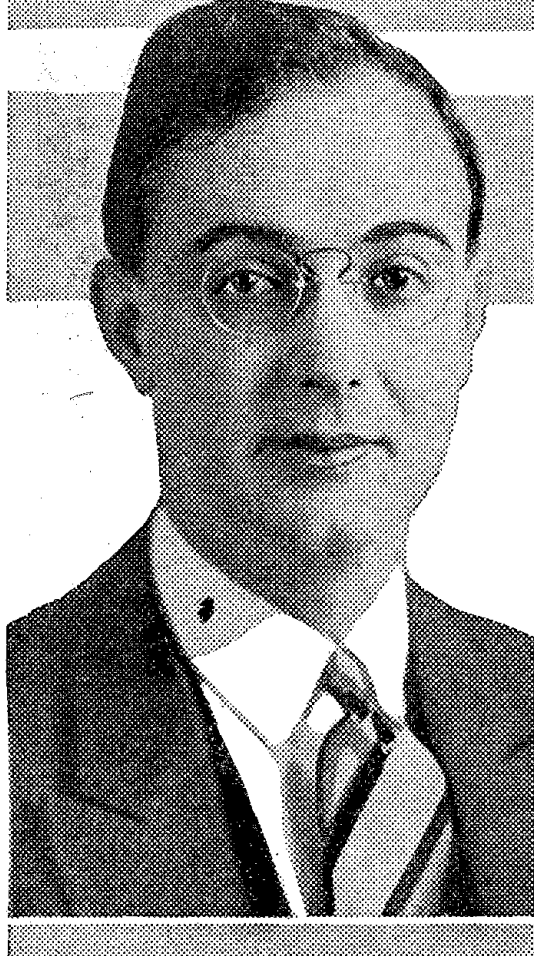

Nicholas Garagusi, violinist, needs no introduction to music lovers. He has played with many of the leading orchestras in the country and is at the present time with the Detroit News orchestra heard every day at WWJ.



Violet Deutsch is a talented, young pianist of Omaha, Nebraska. Her effective tone production on the Baldwin Concert Grand has won for her many admirers among the listeners in of WOAW. You may hear her Monday, March 9.

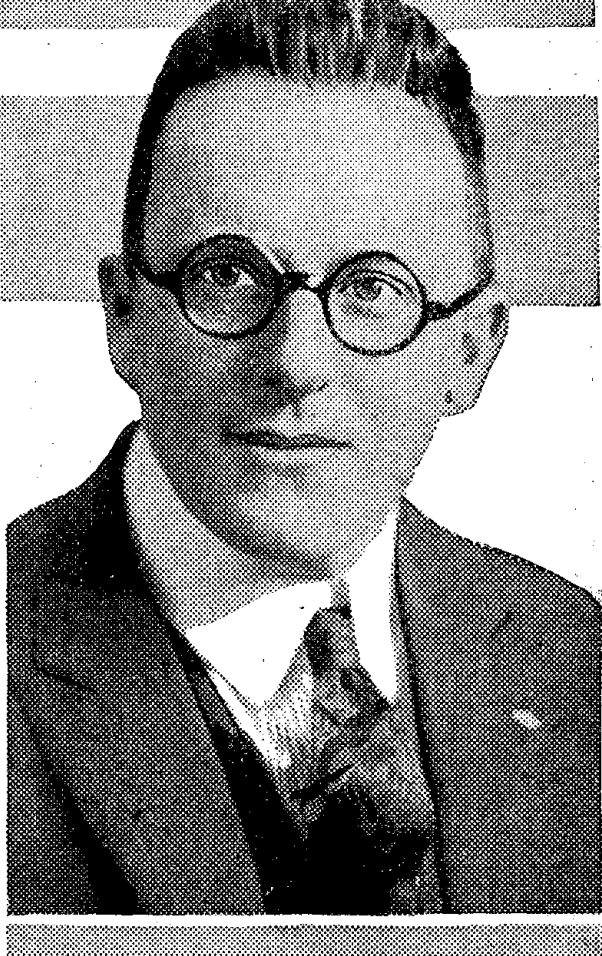

Henry Spies, first horn player of the KGO Little Symphony orchestra, was one of the soloists on the Tuesday evening program, March 3. The Little Symphony orchestra may be heard again Sunday at 3:30 p. m.

WOC, Davenport, Ia. (483.6), 5:45 p. m., chimes concert.

WOL, Ames, Ia. (270), 10 p. m., program popular music.

WORD, Batavia, Ill. (275), 8-9 p. m., Mildred Morlock, soloist; Marvel Morlock, soloist; Edward Fitzgerald, pianist; Bible lecture.

WOS, Jefferson City, Mo. (449.9), 8 p. m., addresses, J. N. Williams, R. O. Marlin, Charles C. Jackson, Charles T. McLaughlin; musical program, Broadway Methodist church.

WRBC, Valparaiso, Ind. (278), 7:30 p. m., music.

WSB, Atlanta, Ga. (428.3), 5-6 p. m., Bonnie Barnhardt's songs and bedtime story; 8-9, vocal and instrumental recital; 10:45, Warner's Seven Aces.

WSUI, Iowa City, Ia. (483.6), 7:30 p. m., "Modern English," Prof. Thomas A. Knott; 7:45, "Current Social and Economic Problems," T. D. Yoder; 8, readings.

Mountain Time Station

KOA, Denver, Colo. (322.4), 8 p. m., Fred Schmitt and his Rialto theater orchestra; 8:10, "Safety First," Otis players.

Pacific Time Stations

KFAE, Pullman, Wash. (348.6), 7:30-9 p. m., Frances Lockwood, soprano; Reba Robertson, reader; "Have Morals a Biological Basis," Dr. F. F. Potter; "A Pure Bred Sire Brings the Buyer," Don G. Magruder; "What Is Worth Seeing in Rome," Prof. C. M. Brewster; "More Electricity for Farm and Home," Dean E. C. Johnson.

KFI, Los Angeles, Calif. (467), 5:30-6 p. m., Examiner's musical half hour, Floryane Thomson, soprano; 6:45-7, Rectorial talk; 7-8, Evening Herald Radio-ians dance orchestra; Charlie Melson, tenor; 8-9, program, Owl Drug company; 9-10, program, Walter M. Murphy Motors company, Hudson Six orchestra; 10-11, Examiner, Ray West and his Alexandria hotel dance orchestra.

KFOA, Seattle, Wash. (455), 4-5:15 p. m., studio music; 6:45-8:15, Sherman Clay and company program; 8:30-10, Seattle Times studio program.

KGO, Oakland, Calif. (361), 5:30-6 p. m., Aunt Betty stories; 8, Arlon trio; "Insects," E. O. Essig; "A Lesson in English," Wilda Wilson Church; "Rules of the Road which Every Motorist Should Know," George E. Sandford; "Being a Good Hostess," Edith Steven Giles; "Chats about New Books," Joseph H. Jackson; 10-1, Henry Halstead's orchestra.

KLX, Oakland, Calif. (309.9), 6-7 p. m., organ; 8-9:30, educational program; 9:30-10, American theater orchestra; 10, meeting, Lake Merritt Ducks.

KNX, Hollywood, Calif. (337.6), 5:45-6:15 p. m., organ recital from Wurliitzer studio; 6:15-7, dinner hour

concert, Pittsburgh association orchestra; 7:30, children's period; 7:45, "Overcoming Economic Prejudice," Dr. John Ray Ewers; 8, concert; 9, Brunswick hour of music; 11, concert, Pittsburgh Post studio.

WCAE, Pittsburgh, Pa. (461.3), 6:30 p. m., dinner concert, William Penn hotel; 7:30, Uncle Kaybee; 7:45, special feature; 8, program, WEAF; 8:30, "The Gold Dust Twins"; 9, Eveready hour; 10, Goodrich Silvertown Cord orchestra.

WCAU, Philadelphia, Pa. (278), 7 p. m., Paul Specht and his Original Columbia recording dance orchestra; 7:30, N. Snellenburg and company recital; 8, selections by Cleve-Chandlers Hawaiians; 8:15, talk, auspices Philadelphia Electric company; 8:20, concert, Media Melodians; 8:40, Symphonic surety orchestra; 9:10, recital.

WCX, Detroit, Mich. (516.9), 4:15 p. m., musical program; 6, dinner concert, Book-Cadillac hotel; 8:30, musical program; 10, Red Apple club.

WDWF, Providence, R. I. (440.9), 8:30-9:30 p. m., Vincent Lopez, Arcadia dance orchestra.

WEAF, New York, N. Y. (482), 11-11:10 a. m., Board of Education lecture; 11:10-11:20, motion picture forecast; 3-3:15 p. m., Jimmy Cohen, violinist; 3:15-3:30, Mary Marlatt, soprano; 4:30-5, women's program; 6-7, dinner music, Waldorf-Astoria hotel; 7-7:10, Genevieve Williams, soprano; 7:10-7:20, Scott Blakeley, Scotch comedian; 7:20-7:30, Oscar Nicastro, cellist; Rita de Simone, soprano; 7:30-8, Royal Eastern Electric Supply company; 8-8:15, talk, Bank of America; 8:30-9, Gold Dust Twins; 9-10, Eveready hour.

WEAR, Cleveland, Ohio (389.4), 7-8 p. m., Metcalf Memorial organ recital, Vincent H. Percy; 8-10, concert from WEAF.

WEEL, Boston, Mass. (475.9), 4 p. m., Shawmut Juvenile Syncopators; 6:30, Big Brother club, Uke band; 7:15, Dok-Eisenburg and his Sinfonians; 8, music from WEAF; 8:30, Gold Dust Twins; 9, Eveready hour; 10, Goodrich Silvertown Cord orchestra.

WFI, Philadelphia, Pa. (394.5), 3 p. m., Philadelphia Music Club spring choral concert; 6:30, Meyer Davis Bellevue Stratford concert orchestra; 7, Sunny Jim; 8, concert from WEAF; 8:30, Gold Dust Twins; 9, Eveready hour; 10, Goodrich Silvertown Cord orchestra.

WGSS, New York, N. Y. (316), 3-3:15 p. m., interview with Arshay Mahdiesian on "Armenia," Terese Rose Nagel; 3:10-3:20, Hazel Dorey, pianist; 3:20-3:30, "The New Bachelor Girl," Lillian Echler; 3:30-3:40, Hazel Dorey; 3:40-3:50, piano lessons, Dr. Alfred G. Robyn; 3:50-4, Hazel Dorey; 6-6:30, Uncle Geebee; 6:30-7:30, Leo Kreuger's Alladin orchestra; 8:30-9,

concert, Pittsburgh association orchestra; 7:30, children's period; 7:45, "Emo's Weekly Broadcast," 10:30, Harvey Marburger's dance orchestra; 11, Radio contest.

WJY, New York, N. Y. (405.2), 8:15-8:45 p. m., Orphans Masonic quartet; 10-11, Montclair orchestra.

WJZ, New York, N. Y. (454.3), 4-4:15 p. m., Myrtle Van Veen, soprano; 4:15-4:30, L. E. Schoenbarr, basso; 4:30-5:30, Bernhard Levitow's Hotel Commodore tea orchestra; 7-7:15, dog talk, Frank Dole; 7:15-8, Joseph Strissoff's Hotel Vanderbilt orchestra; 8-8:10, Wall Street Journal; 8:10-8:20, NYU Air college; 9-10, Brunswick hour; 10-10:20, "Pyrenee," Wirt W. Barnitz.

WKAQ, San Juan, P. R. (340.7), 8-9:30 p. m., Euterpe jazz band.

WLIT, Philadelphia, Pa. (394.5), 2 p. m., Arcadia cafe concert orchestra; 7:30, Dream Daddy's bedtime stories; 7:30, "Behind the Footlights," Arnold Abbott.

WNYC, New York, N. Y. (526), 7:20-7:30 p. m., sports talk, Thornton Fisher; 7:35-8:45, Risenfeld's Rialto program; 8:45-9:45, studio program; 10-10:20, lecture service, Board of Education.

WOO, Philadelphia, Pa. (508.2), 4:45 p. m., organ recital, Mary E. Vogt.

WOR, Newark, N. J. (405), 6:30-6:45 p. m., Man in Moon stories.

WRC, Washington, D. C. (468.5), 6:45 p. m., children's hour, Peggy Albion; 7, Meyer Davis New Willard hotel orchestra; 8, "Show Shopping," Leonard Hall; 8:10, to be announced; 8:30, "The Political Situation in Washington Tonight," Frederic William Wile; 9, Brunswick hour of music; 10:30, dance music, Meyer Davis Le Paradis band.

WREO, Lansing, Mich. (285.5), 8:15-9:45 p. m., Reo band, Carl Hall Dewey, director; Reo male glee club.

WTAM, Cleveland, Ohio (389.4), 6-7 p. m., dinner music, Hotel Statler concert orchestra, Maurice Spitznagel, director.

WWJ, Detroit, Mich. (352.7), 3 p. m., Detroit News orchestra; 6, dinner concert; 8, concert from WEAF.

Central Time Stations

CKY, Winnipeg, Can. (450), 7:30 p. m., lecture, Prof. W. T. Allison; 8, concert, J. J. H. McLean company; 9, Earle Hill's orchestra.

KFDM, Beaumont, Tex. (315.6), 7-7:30 p. m., children's half hour; 8-10:30, South Park Junior college.

KFMQ, Fayetteville, Ark. (299.8), 9 p. m., pupils, Mr. Shultz.

KFRU, Bristow, Okla. (395), 10:30-12, special concert.

KSAC, Manhattan, Kan. (340.7), 7:20 p. m., college

9, Glenn's Threshers; 9:10, Shakespeare, Anthony Wons; 9:30, Nubs Allan; Art Kahn's Columbia Senate orchestra; 10, James Church banjo duo; 10:30, Glenn's Threshers; 10:40, Ford and Glenn time; 11, Carrell Vaudeville nite program; 12, midnight review, Ralph Emerson, Dave Nadelman, Ford and Glenn.

WLW, Cincinnati, Ohio (423), 4 p. m., Mah Jongg lecture, Lucie Blackburn, pupils of William K. Kyle; 8, dinner hour concert, Selinsky instrumental quintet; 8, concert program, Boathouse Coffee company; quartet of brass; instrumental trio; 8:30, R. G. (Gregg) Henkel in "O'Gooferty and Goofus"; Adelaide Apfel, pianist; Earl Derbis, violinist; Edith MacDonald Taube, trio; 9, Higginbottom's orchestra de luxe, Wilson Higginbottom, director and manager; Missouri Kenney, pianist, Old Time fiddlin', Jake Rutz and his Pumpkin Vine orchestra.

WMAQ, Chicago, Ill. (447.5), 4 p. m., American Red Cross talk, Dr. H. W. Gentles; 4:30, pupils, Gunn School of music; 6, Chicago theater organ; 6:25, Hotel LaSalle orchestra; 6:50, Daddy; 8, Harry Hansen, literary editor; 8:20, travel talk, Clara E. Laughlin; 8:40, weekly talk, Association of commerce; 8:50, lecture, University of Chicago; 9:15, program, Bethany Reform church.

WMC, Memphis, Tenn. (499.7), 8 p. m., lecture, Col. Harry B. Anderson; 11, frolic, Reinhardt's Music Shop symphony.

WOAI, San Antonio, Tex. (394.5), 8:30 p. m., Grieg compositions, WOAI entertainers; 9:30, Jimmie Joy's Hotel St. Anthony orchestra.

WOAW, Omaha, Nebr. (526), 5:45 p. m., public news period; 6, "Advice to Lovelorn," Cynthia Grey; 6:25, dinner program, May Seed and Nursery company; 9, program, Thelma Skeen Swager, harpist; 10, music; 10:30, Frank W. Hodek, Jr., and his Nightingale orchestra.

WOC, Davenport, Ia. (483.6), 5:45 p. m., chimes; 6:30, sandman's visit; 8, musical program.

WORD, Batavia, Ill. (275), 8-9 p. m., Columbia Conservatory of Music; world news items, G. L. Pyle.

WQJ, Chicago, Ill. (447.5), 7-8 p. m., dinner concert, Ralph Williams and his Rainbo Garden orchestra; Isabelle Freeman, soprano; Ellen Doolittle, accompanist; Sheppard Levine, tenor; Effie Overson, accompanist; 10-1, Ralph Williams and his Rainbo Skylarks; Ned and Ches; Will Rosstter; Mack Sisters; 1-2, Hotsy Totsy hour, Ralph Williams, the Gingerman, Little Skylarks.

WSB, Atlanta, Ga. (428.3), 5-6 p. m., juvenile program, Bonnie Barnhardt's bedtime story; 8-9, Violette Myers' melody artists; 10:45, musical entertainment, Stewart Hale players.

BOSTON U.-DARTMOUTH COLLEGE D

Index to Talks, Lectures and Addresses

TABULATED below is a time table of the stations giving talks, lectures and addresses this week. These range from the instructive and serious to the humorous and frivolous. The stations listed are divided into the four different kinds of time in use. The hours are given in the kind of time in use at each listed station. By using this table as an index and referring to the complete programs below, full information will be obtained.

Eastern Time Stations
Saturday, March 7: 7:15, WBZ; 7:45, KDKA; 8, WIP, WJY, WRC; 8:15, WNYC; 8:20, WBBR; 9:30, WGBS.

Monday, March 9: 7:15, WGY; 7:35, WNYC; 8, WJZ, 8:10, WJZ; 8:15, KDKA; 8:45, WJZ; 9:20, WLIT; 9:30, WJZ; 10:15, WNYC.

Tuesday, March 10: 7, WJZ; 7:30, WGY; 7:45, KDKA; 8, WFAF, WJZ, WIP, WRC; 8:15, WCAU; 8:30, WRC; 9, WGBS; 10, WJZ; 10:10, WNYC; 11:05, WIP.

Wednesday, March 11: 6:45, WGY; 8, WCAU, WJZ; 8:15, KDKA; 8:30, WFAF, WNYC; 8:40, WCAU; 10, WJY; 10:15, WCAU.

Thursday, March 12: 7:30, WFAF, WGY; 7:55, WJZ; 8, CNRT, WGY, WNYC; 8:15, WJY; 8:30, WGBS; 9:40, WCAU; 10:05, WIP.

Friday, March 13: 7, WDFW, WJZ, WLIT; 7:30, WGY; 8:10, WLIT; 8:15, KDKA; 8:30, WFAF, WEEI; 9, WAHG, WJZ; 10:10, WFAF, WNYC.

Central Time Stations

Saturday, March 7: 6, WDAF; 6:50, WOC; 7:30, WOA; 8, WCCO; 8:30, WBCN, WMAQ; 9:05, KYW; 9:15, KYW.

Sunday, March 8: 6, WOA; 7, WDAF; 7:30, WOA; 8, WDAF; 8, KSD, WCCO, WOS, WSUI; 8:30, KFKU; 8:45, KFKU; 9, WGST.

Tuesday, March 10: 6, WDAF, WOA; 7, WHB; 7:30, CKY, KSAC, WCCO; 7:45, WCCO; 8, WLS, WMAQ, WMC; 8:50, WMAQ.

Wednesday, March 11: 6:50, WOC; 7, WHB; 7:30, KSAC, WSUI; 7:45, WSUI; 8, WLS, WMAQ, WOS, WSUI; 8:55, WEMC.

Thursday, March 12: 6, WDAF; 7, WHB; 7:15, KFKU; 7:30, CKY, KFKU, KFMQ, KSAC; 7:45, KFKU; 8, WMAQ; 8:45, WMAQ; 8:50, WMAQ.

Friday, March 13: 6, WDAF; 6:50, WOC; 7:30, CKY, KSAC; 8, WLS, WOS; 8:30, WCAL.

Mountain Time Stations

Monday, March 9: 8:30, KOB; **Wednesday, March 11:** 8:30, KOB; **10, CNRC.**

Friday, March 13: 6:40, KOA; 8:30, KOB.

Pacific Time Stations

Saturday, March 7: 6:20, KPO; 6:30, KHJ, KPO; 7:45, KFI.

Sunday, March 8: 6:30, KPO; **Monday, March 9:** 6:45, KFI; 8, KGO, KLX.

Tuesday, March 10: 6:30, KHJ, KPO; 6:45, KFI; 7:30, KNX; 8, KGW; **Wednesday, March 11:** 6:30, KHJ, KPO; 6:45, KFI; 7, KFI.

Thursday, March 12: 6:30, KHJ; 6:45, KFI. **Friday, March 13:** 6:30, KHJ, KPO; 6:45, KFI.

Tuesday, March 10

(Continued from page 11)

Pacific Time Stations

KFI, Los Angeles, Calif. (467), 5:30-6 p. m., Examiner's musical half hour; 6:45-7, Radiorial; 7-8, pipe organ recital; Dan McFarland; 8-9, Examiner, classical program; 9-10, Ruth Florence, dramatic soprano, Isabella Boyd quartet; 10-11, Don Meany's movie night, Monte Blue, master of ceremonies.

KFOA, Seattle, Wash. (455), 4:55-5 p. m., Olympic hotel orchestra; 6:45-8:15, Rhodes Dept. Stone program; 8:30-10, Seattle Times dance music; 10:05-11, Eddie Harkness and his orchestra.

KFSS, Los Angeles, Calif. (278), 10:30-11:30 a. m., sunshine hour; 3:30-4:30 p. m., afternoon organ recital, Esther Fricke Green, organist; 6:30-7:30, children's hour arranged and presented by Harry James Beardsley (Cousin Jim).

KGO, Oakland, Calif. (361), 4:55-5:30 p. m., concert orchestra, Hotel St. Francis; 8, program, Chevrolet Motor company, Girvin-Duval's California Collegians; Scotch songs, Grace Hall; Pet Homer, saxophonist; Junior de Avilla, comedian; Era Garcia, pianist; George Anderson, baritone; duets for steel guitars, Joseph Lario, Jack Andrade; musical novelty skit, "Fun in the Schoolroom"; "When Knighthood Bloomed," Harry A. James; Gyula Ormay trio; 10-11, Henry Halstead's orchestra.

KGW, Portland, Ore. (492), 8 p. m., Oregon Agricultural college extension service lecture; 8:30, concert; 10, Multnomah Hotel Strollers.

KHJ, Los Angeles, Calif. (404.1), 6-6:30 p. m., Art Hickman's Biltmore hotel concert orchestra, Edward Fitzpatrick, director; 6:30-7:30, little stories American history, Prof. Walter Sylvester Hertzog, weekly visit of Queen Titania and Sandman, Louis F. Klein, auto-harpist and harmonica soloist; Chas. Leslie Hill, reader; 8-9:30, program, Pomona, Lions club, Pomona college; 9:30-10, Claire Forbes Crane, famous concert pianist; Calmon Luboviski, violinist; 10-11, Earl Burnett's Biltmore hotel dance orchestra.

KIS, Los Angeles, Calif. (293), 8-9:30 p. m., musical program of classical nature, direction Musical Department of Bible Institute.

KNX, Hollywood, Calif. (337.6), 5:45-6:15 p. m., Wurlitzer pipe organ studio; sports talk, Sid Ziff; 6:30-7:30, dinner hour music presented by R. C. "Cliff" Durant; 7:30-8, style talk, Constance Service of Siegel-Myers; 8-9, program, Elite Catering company; 9-10, program, Davis Standard Bread company; 10-12, movie night, Ambassador hotel, Abe Lyman's Cooanet Grove dance orchestra.

KPO, San Francisco, Calif. (429.5), 4:30-5:30 p. m., Rudy Seiger's Fairmont hotel orchestra; 5:30-6:30, children's hour stories; 7-7:30, Rudy Seiger's Fairmont hotel orchestra; 8-10, program, Mrs. Frederick Stow; 10-11, Gene James' Rose Room Bowl orchestra.

Wednesday, March 11

Wednesday, silent night for: CHNC, CKAC, CKY, KFDN, KFKU, KFKX, KFMQ, KGO, KSD, WBAV, WCB, WDFW, WEBW, WFAA, WFI, WIP, WJY, WLBL, WMAQ, WMC, WOA, WOI, WORD, WRBC, WRC.

Eastern Time Stations

KDKA, East Pittsburgh, Pa. (309.1), 6:15 p. m., dinner concert, Pittsburgh Athletic association; 7:30, children's period; 8:15, address, University of Pittsburgh; 8:30, concert.

WAHG, Richmond Hill, N. Y. (315.6), 8-11:30 p. m., program, Brooklyn Daily Eagle.

WCAE, Pittsburgh, Pa. (461.3), 6:30 p. m., dinner concert, William Penn hotel; 7:30, Sunshine girl; 7:45, special feature; 8:30, Marie-Bettler, contralto; William E. Staiger, pianist; 9, concert, Atwater Kent orchestra; 10:30, concert, Nixon restaurant orchestra.

WCAU, Philadelphia, Pa. (278), 6 p. m., Meyer Davis' Hotel Pennsylvania concert orchestra, direction Lon Chassey; 8, financial talk; 8:10, recital; 8:45, songs, Anthony McNichol; 9:40, recital; 10:15, Voice of Paris; 10:15, Radio talk.

WCX, Detroit, Mich. (516.9), 4:15 p. m., musical program; 6, dinner concert, Book-Cadillac hotel; 8:30, musical program.

WEAF, New York, N. Y. (492), 11:35-11:45 a. m., talk, "Surroundings and Character," Dr. Bess V. Cunningham; 12-12:30 p. m., chapel services, Columbia university; 3:45-4, Kay Macrae, soprano; 4-5, children's stories; 6-7, dinner music, Waldorf-Astoria hotel; 7-7:30, services, United Synagogue of America; 7:30-8, U. S. Army band; 8-8:15, Charles P. Wellner, tenor; 8:15-8:30, Margaret Koller, soprano; 8:30-8:40, talk, American Bond and Mortgage company; 9-10, Atwater

Kent Manufacturing company; 11-12, Meyer Davis' Lido Venice orchestra.

WEAO, Columbus, Ohio (293.9), 8-10 p. m., concert, Ohio State university orchestra.

WEAR, Cleveland, Ohio (389.4), 7-8 p. m., dinner concert, Ivan Francis and his Hotel Cleveland orchestra.

WEEL, Boston, Mass. (475.9), 6:30 p. m., Big Brother club; 7:25, Jack Griffin, Eddie McGinley; 7:50, Harry Einstein, Bad Boy from the Good Home; 8, Traveler Shoe orchestra; 8:30, M. B. Cohan's half hour musical; 9, Gillette Safety Razor band.

WFI, Philadelphia, Pa. (394.5), 3 p. m., Loretta Kerk, pianist; 6:30, Meyer Davis' Bellevue Stratford concert orchestra; 7, Sunny Jim, the kiddies' pal.

WGBS, New York, N. Y. (316), 3-3:30 p. m., interview with Marguerite LaNamara, operatic star; 3:30-3:20, Berlin trio; 3:20-3:30, book review, John Cutting; 3:30-3:40, Berlin trio; 3:40-3:50, "Swedish Memoirs," Countess Eckenstam; 3:50-4, Berlin trio.

WGY, Schenectady, N. Y. (379.5), 7 p. m., program, Strand theater orchestra.

WHN, New York, N. Y. (360), 6:30-7 p. m., Oleott Vail; 7-7:30, Harry Richman and his entertainers; 7:30-7:35, health talk, Dr. Landis; 11:30-12, Harry Rose and his Silver Slipper revue; 12-12:30 a. m., Strand Roof orchestra.

WIP, Philadelphia, Pa. (508.2), 3 p. m., recital, students Kurtz studio, Helen M. Dpear, soprano; Katrina Ziegler, contralto; Elizabeth McLean, soprano; M. Daniels, bass; 4:15, mental hygiene talk; 6:05, Benjamin Franklin concert orchestra; 7, Uncle Wip's bedtime stories.

WJZ, New York, N. Y. (454.3), 4-4:15 p. m., Mrs. Ralph E. Tower, pianist; 4:15-4:30, John V. Aspe, tenor; 4:30-5, Hotel Belmont tea; 5-5:30, concert; 7-8, Cafe Boulevard orchestra; 8-8:10, Wall Street Journal review; 8:10-8:20, NYU Air college; 8:25-8:40, Frank Anderson, baritone; 10-10:15, "Work of the Juilliard Foundation," Dr. Eugene Noble; 10:15-10:30, Mary Carr, soprano.

WKAQ, San Juan, P. R. (340.7), 7-9 p. m., Municipal band.

WLF, Philadelphia, Pa. (394.5), 2 p. m., Arcadia cafe concert orchestra; 4:30, Alon Levy, violinist; 7:30, Dream Daddy's bedtime stories; 9:30, Cotton Pickers' dance orchestra; 10:03, Arcadia cafe dance orchestra.

WNYC, New York, N. Y. (526), 7:35-8:30 p. m., dance program; 8:30-9, course in appreciation of music, Dr. Henry T. Fleck; 9:45-10:30, studio program.

WOO, Philadelphia, Pa. (508.2), 4:45 p. m., organ recital, Mary E. Vogt; 7-7:30, Candelori's orchestra from Hotel Adelphi; 8:30, concert from WFAF; 10:03, concert from WFAF; 10:30, Vincent Rizzo's Hotel Sylvania dance orchestra.

WOR, Newark, N. J. (405), 2:30-2:45 p. m., Constance C. Carr, soprano; 2:45-3, piano recital, Adelaide Purcell and Dorothy Wilder; 3:15-3:30, Constance C. Carr; 3:30-3:45, piano recital, Adelaide Purcell and Dorothy Wilder; 3:45-4, Jean Eckert, dramatist; 6:15-6:45, Harry Cox hotel Robert Treat orchestra; 9-9:45, Chickering artist series.

WTAM, Cleveland, Ohio (389.4), 6-7 p. m., dinner dance music, Philip Spitalny and his Music Box restaurant orchestra; 8-11, program from WFAF; 11:1, music box studio, dance music, Philip Spitalny and his music box restaurant orchestra.

WJL, Detroit, Mich. (352.7), 3 p. m., Detroit News orchestra; 6, dinner concert; 8, Detroit News orchestra; Three Knights of Harmony; 10, Jean Goldkette's Victor Recording orchestra.

Central Time Stations

KFNH, Shenandoah, Ia. (266), 6:30 p. m., program, Shenandoah Lodge, B. P. O. E.

KFRU, Bristow, Okla. (395), 8-10:30 p. m., music, entertainment.

KSAC, Manhattan, Kan. (340.7), 7:20 p. m., instrumental trio; 7:30, "Financing of Local Roads," C. H. Scholer; 7:40, instrumental trio; 7:50, "Regular Care for Profitable Tractor Work," W. H. Sanders; 8-9, classical musical program.

KTHS, Hot Springs National Park, Ark. (374.8), 8:30-10 p. m., Meyer Davis New Arlington hotel orchestra; 10-11, dance frolic, Eastman hotel orchestra.

WEAF, Fort Worth, Tex. (475.9), 7:30-8:30 p. m., concert, Mrs. Earl Rogers and pupils of Burleson; 9:30-10:45, Jim Riley's Texas hotel orchestra.

WBCN, Chicago, Ill. (266), 7-8 p. m., classical hour, Irving Shuster operatic program; 8-10:15, Berger Weber, tenor; Jack Parker, tenor; Midway Gardens orchestra; George Dell, baritone; Florence Tenney, blues singer; Southern harmonizers; Walter C. Steacy, accordionist; Evadine Gibson, soprano; Harry J. Mapp, auto talk; Les Cameron, tenor.

WCCO, Minneapolis-St. Paul, Minn. (416.4), 7 p. m., midweek church service, 38th Street Congregational church; 8-9, program from WFAF; 9, South Dakota night; 10, Original George Osborn's Nicollet hotel orchestra; 11:30, Eddie Dunstetter, organist.

WDAF, Kansas City, Mo. (365.6), 3:30-4:30 p. m., Star's Radio trio; 6-7, address, speaker, auspices Health Conservation association; address, speaker, Meat council; Tell-Me-a-Story Lady; Tristar's orchestra; 8-9-15, program, classical music, Tristar's Radio orchestra.

WEAH, Chicago, Ill. (370.2), 7-8 p. m., Oriole orchestra; books of the day, Lewellyn Jones; musical bits, Riviera theater; 9-10, Oriole orchestra; M. S. Szymczak; Langdon brothers, guitarists; Edgewater glee club;



Maxim Kastyluck (left) will interpret Russian dances and sing Russian songs March 11 at Cincinnati. Macy and Scott, the two card players above, are called the "Radio Aces" and have been so popular with the fans that WGBS has arranged to have them appear every Thursday evening. Lena Milam, violinist, will be heard on the March 11 and 17 programs of KFDM, Beaumont. The man in the upper right hand corner is the leaf Fairbanks, Morse and company band. Mr. Lhotka direct this organization Tuesday at WEBW, I

Frederick Agard, tenor; Marie Kelly, reader; 11-12, Oriole orchestra; Edna Solomon; Marie Kelly, reader; Langdon brothers, guitarists; Frank Sylvano, soloist.

WEMC, Berrien Springs, Mich. (286), 8:15 p. m., Ardice Bentley, pianist; 8:30, Marguerite Bordeaux, reader; De You Enley; Lyndon L. Skinner.

WGN, Chicago, Ill. (370.2), 6 p. m., organ recital, Lyon & Healy; 6:30-7, dinner concert, Drake Boehm ensemble, Blackstone string quintet; 8-9, Rose Boehm, soprano; Helen Madison, pianist; 10-11, Don Bestor Drake dance orchestra; Milton college glee club.

WHAS, Louisville, Ky. (399.8), 4-5 p. m., selections, Louisville Conservatory of Music; 7:30-8, concert, K. & I. Terminal railroad orchestra, J. Clark Martin, director; selections, String Division; chapter, "Billy Joe" Jans.

WHB, Kansas City, Kan. (365.6), 7-8 p. m., "Holding Boys for Manhood," H. Harry Harlan; Northeast "Y" community worker; students, Northeast high school.

WHO, Des Moines, Ia. (526), 6:30-7:30 p. m., Reese-Hughes orchestra; 7:30-8:30, program, Dean Holmes Cowper, director; 8:30-9:30, Des Moines theater symphony orchestra; Prof. Leon A. Dashoff, director; 9:45-11, Bankers Life Radio orchestra, William L. Marsh, director.

WLS, Chicago, Ill. (344.6), 6:30 p. m., Ralph Emerson, organist; 6:50, Senate theater studio; 7, lullaby time, Ford and Glenn; 7:15, WLS Tribe Lone Scouts; 7:40, Robert Lyle Malone, tenor; 8, R. E. D. program, Ford and Glenn; Ralph Emerson, organist; 9, John MacFarlane, bass; 9:10, Wallace Bruce Amshary; 9:30, George D. Howe, tenor; 9:45, Glenn's Threshers; 10, Senate Symphony orchestra; 10:10, Nubs Allan; 10:20, Grace Wallace; 10:20, Glenn's Threshers; 10:40, Ford and Glenn time.

WLW, Cincinnati, Ohio (423), 2:30 p. m., special program at Music Hall with Radio show; 4, "Shut In" program; 8, 9 and 10, half hour programs at the Radio show; Minor instrumental trio; Russian dances, Maxim Kastyluck; Clifford Lang, pianist; Formica entertainment; Walter Esberger's instrumental quartet; the Famous Lyric male quartet.

WMAQ, Chicago, Ill. (447.5), 4 p. m., beauty talk, Mme. Grace Earl; 4:30, pupils, Cosmopolitan school of music; 6, Chicago theater organ; 6:30, stories for the children, Georgene Faulkner; 8, piano concerto; 9, WMAQ players; Carl Craven, tenor.

WOC, Davenport, Ia. (483.6), 5:45 p. m., chimes; 6:30, bedtime stories, Val McLaughlin; 6:50, "Conflict of Youth and Age," Harry E. Vedder; 9, Mrs. Frank W. Elliott, organist; Niles Peterson, tenor.

WOS, Jefferson City, Mo. (440.9), 8 p. m., address, George A. Pickens; music, Missouri association.

WQJ, Chicago, Ill. (447.5), 7-8 p. m., dinner concert, Ralph Williams and his Rainbo Garden orchestra; Merrile Boyd Mitchell, soprano; James Mitchell, baritone; Rev. Earl Gaborowski, accompanist; 10-11, Ralph Williams and his Rainbo Skylarks; Rogers Boys, Larry, Billy; Clarence Theaders, tenor; Alfred Tweed, harmonica soloist; Melodians, Laurie, Eddie, Bennie; Fred A. Jacobsen, monologist; George A. Little, Harry Shay, harmony singers; Zeigler sisters; 1-2, Holsy Totsy hour, Ralph Williams, Gingerman, Little Skylarks.

WSB, Atlanta, Ga. (428.3), 5-6 p. m., Bonnie Barnhardt's songs and bedtime stories; 10:45, Roy Sullivan trio, features.

WSUI, Iowa City, Ia. (483.6), 7:30 p. m., "The American Constitutional System," Prof. Frank E. Horack; 8:30, "The Psychology of Learning," Prof. F. B. Knight; 8, "The Appreciation of Literature," Prof. Frank L. Mott.

Mountain Time Stations

KOA, Denver, Colo. (322.4), 8 p. m., Fred Schmitt and his Rialto theater orchestra; 8:10, men's glee club; University of Denver; Lyric quartet; Tuesday Musical club; "The Florist Shop," KOA studio players; KOA orchestra; 10-12, Joe Mann and his Rainbow-Lane orchestra.

Pacific Time Stations

KFAE, Pullman, Wash. (348.6), 7:30-9 p. m., Gladys Fraser, Raymond Howell, violinists; Lillian Pettibone, pianist; "The Vacuum Tube," Dean H. V. Carpenter; "Oats and Barley for the Palouse," Leonard Hegnauer; "Pointers on Dairy Farming," Prof. E. V. Ellington.

KFI, Los Angeles, Calif. (467), 5:30-6 p. m., Examiner's musical half hour; 6:45-7, Radiorial; 7-7:30, Nick Harris, detective stories; 7:30-8, program, Goodwin-Kilinger-MacKay company; 8-9, Evening Herald dance hour; 9-10, Examiner, popular song night; 10-11, Patrick-Marsh dance orchestra, Betty Patrick, blues singer.

KFOA, Seattle, Wash. (455), 4:55-5:15 p. m., Olympic hotel orchestra; 6:45-8:15, Hopper-Kelly company studio program; 8:30-10, Seattle Times studio program.

KFSB, Los Angeles, Calif. (278), 10:30-11:30 a. m., sunshine hour program; 2:30-4:30 p. m., auditorium service and sermon on Divine Healing, Aimee Semple McPherson, pastor; 6:30-7:30, children's hour, presenting Helen Edwino and Mary Elizabeth Hughes, Mrs. Rose, pianist.

KGO, Oakland, Calif. (361), 3 p. m., musical program, Cora L. Williams institute; 4-5:30, concert orchestra, Hotel St. Francis.

KGW, Portland, Ore. (492), 8 p. m., concert, Mrs. L. W. Waldorf, director; 10, Colburn's Melody men; Sheffer's Novelty String quartet.

KHJ, Los Angeles, Calif. (404.1), 6-6:30 p. m., Art

Hickman's Biltmore hotel concert orchestra; 6:30-7:30, little stories American history, Prof. Walter Sylvester Hertzog; Dick Winslow, juvenile reporter; Mickey McBan and Baby Muriel McCormac, screen juveniles; 8-9, program, Pacific Mutual Life Insurance company; 9-10, program, Lincoln Heights Commercial and Industrial association; 10-11, Earl Burnett's Biltmore hotel dance orchestra.

KLX, Oakland, Calif. (509.9), 6-7 p. m., organ; 8-10, studio program, American theater orchestra; 10-11:30, Sweet, ballroom.

KNX, Hollywood, Calif. (337.6), 5:45-6:15 p. m., Wurlitzer pipe organ studio program, sports talk, Sid Ziff; 6:15-7, dinner hour music; 7-8, Ambassador hotel concert orchestra, Josef Rosenfeld, director; 8-9, program, Security Trust and Savings bank; 9-10, KNX feature program; 10-12, Hollywoodland dance orchestra.

KPO, San Francisco, Calif. (429.5), 4:30-5:30 p. m., Rudy Seiger's Fairmont hotel orchestra; 5:30-6:30, children's hour stories, Big Brother; 7-7:30, Rudy Seiger's Fairmont hotel orchestra; 7:30-8, program, Conn Band Instrument company; 8-10, xylophone solos, "Doc" Willits; Ida Palmer Walker, soprano; Gene James' Rose Room Bowl orchestra.

Thursday, March 12

Thursday, silent night for: CHNC, KFDM, KFOA, KLX, KOA, WAHG, WBAV, WDFW, WEAO, WEBW, WEMC, WHA, WHAZ, WJY, WLBL, WOO, WOS, WRBC, WSUI.

Eastern Time Stations

CKAC, Montreal, Can. (425), 4:45 p. m., Windsor hotel dance orchestra; 8:30, Canadian National railways using CNRM.

DKA, East Pittsburgh, Pa. (309.1), 6:15 p. m., dinner concert, Broudy's orchestra; 7:30, children's period; 8, program, National Stockman & Farmer studio; 8:30, concert; 11, concert, Pittsburgh Post studio.

WBBR, New York, N. Y. (272.6), 8 p. m., Frank Wood, tenor; 8:10, L. M. Brown, soprano; 8:20, International Sunday school lesson, March 15, S. M. Van Sigma; 8:40, soprano solos, Mrs. L. M. Brown; 8:50, flute solos, Frank Wood.

WCAE, Pittsburgh, Pa. (461.3), 6:30 p. m., dinner concert, William Penn hotel; 7:30, Uncle Kaybee; 7:45, special feature; 8, program from WFAF; 9, Victor artists; 10, concert, Goodrich Silvertown Cord orchestra.

WCAU, Philadelphia, Pa. (278), 7:30 p. m., concert, N. Snellenburg and company's symphony orchestra; 8:15, recital and talks; 8:40, "What We See and Hear in Music," Maude Hansen Pettit; 8:50, recital; 9, Paul Specht and his dance orchestra; 10:20, Paul Specht and his dance orchestra.

WCX, Detroit, Mich. (516.9), 4:15 p. m., musical program; 6, dinner concert, Book-Cadillac hotel.

WEAF, New York, N. Y. (492), 4-4:15 p. m., "Indian Folk Tales," Marie Collins Rooney; 4:15-4:30, Edward Bromberg, basso cantate; 4:40-5, children's story, Miss Mary Raugh; 5-5:10, Louis Borsellino, boy violinist; 6-7, dinner music, Waldorf-Astoria hotel; 7-7:30, services, Federation of churches; 7:30-7:45, art talk; 7:45-7:55, Margaret Hamilton, pianist; 7:55-8:10, Van Sigma; 8:40, soprano solos, Mrs.

EBATE BROADCAST FRIDAY BY WEEI



Missian
WLV,
ayers
come
anged
Mrs.
rch 6
entle-
ier of
k will
eloit.

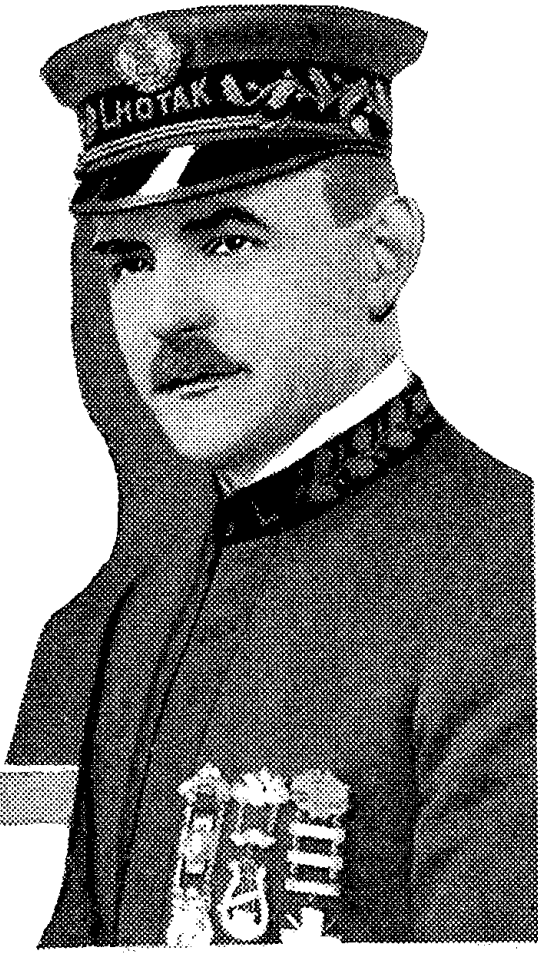

portunity, the Source that Produces Great Men." Pres. J. C. Futrell; "Relation of Electricity to Agriculture," W. J. Miller; "The Project as a Method of Training," G. N. Wade. KFMF, Shenandoah, Ia. (266), 6:30 p. m., Seedhouse concert.

KFRU, Bristow, Okla. (395), 10:30-11:30 p. m., pipe organ.
KSAC, Manhattan, Kan. (340.7), 7:20 p. m., music. L. R. Putnam, director; 7:30, "Treatment of Wail Surface," Araminta Holman; 7:30, music. L. R. Putnam, director; 7:50, "What to Eat when Overweight," Martha Kramer; 8, southern melodies. Prof. P. P. Brainard, director.

KSD, St. Louis, Mo. (545.1), 8 p. m., concert. Mrs. Emil Bansbach; 10:30, Margaret Nolan, soprano; Lois Gage, pianist.

KTHS, Hot Springs National Park, Ark. (374.8), 8:30-10 p. m., concert; 12:15-1:15, Phil Baxter's Singing orchestra.

WBAP, Fort Worth, Tex. (475.9), 7:30-8:30 p. m., Grapevine Municipal band, C. E. Stewart, director; 9:30-10:45, Panther City Hawaiian trio.

WBCN, Chicago, Ill. (266), 7-8 p. m., Chicago mixed quartet; Myria Foss, soprano; Ed. Merle Yagle, pianist; Midway Gardens orchestra; Alvina Becker, soprano; Larry Loser, tenor; Gene Ballard, contralto; Limerick girls; Elmer Jordan, business talk; Al Phillips, tenor; Louis Clark, tenor; Lindsay McPhail, composer; Art Schurr, harmonica soloist; Honolulu serenaders; Lew Butler, tenor.

WCAL, Northfield, Minn. (335.9), 9 p. m., Margaret Hoigard, pianist; Bernice O'Hara, violinist; Florence Haged, soprano; Railway association bass.

WCBD, Zion, Ill. (344.6), 8 p. m., celestial bells; G. R. Sparrow, tenor; Mrs. G. R. Sparrow, contralto; Arthur Rendall, clarinetist; Lillian Detienne, reader; Richard F. Hre, pianist.

WCCO, Minneapolis-St. Paul, Minn. (416.4), 7-10 p. m., national program from WPAF.

WDAF, Kansas City, Mo. (365.6), 3:30-4:30 p. m., Star's Radio trio; 6-7, address, book talk, Louis Mecker; Tell-Me-a-Story lady; Trianon ensemble; 11:45-1, Nighthawk frolic, Merry Old Chief, Plantation players.

WEBB, Chicago, Ill. (370.2), 7-8 p. m., Oriole orchestra; Dan Russo, violinist; Ted Flinto, celeste soloist; musical bits; Dionico theater; 9-10, Oriole orchestra; Belle Forbes Cutter, soprano; Howard Neumiller, accompanist; John Stamford, tenor; 11-12, Oriole orchestra; Banks Kennedy, soloist; Dean Remick, pianist; Loos brothers.

WGN, Chicago, Ill. (370.2), 6 p. m., organ recital. Lyon & Healy; 6:30-7, dinner concert. Drake concert ensemble, Blackstone string quintet; 8-9, Signal Section, American Railway association banquet; 10-11, Don Bester Drake dance orchestra.

WGST, Atlanta, Ga. (270), 7-8 p. m., Edith Moore, soprano; Mrs. J. O. Sanders, violinist; "The American Folk Ballad," W. L. Simmons.

WHAS, Louisville, Ky. (399.8), 4-5 p. m., selections, Louisville Conservatory of Music; 7:30-9, concert, auspices Mrs. J. E. Harman, Jr.

WHS, Kansas City, Mo. (365.6), 7-8 p. m., "The Biggest Single Business in the World," William E. Morton; 8-10, Mrs. B. I. Brooks, pianist; Bernard McCarty, reader; vocal selections, Virginia Kline, Leona Averille, Mrs. E. Turner, Edna Nicholson; Lillian Faust, pianist; Turner Gibson, violinist; Bernard McCarty, pianist; vocal selections, Mrs. R. A. Pennington.

WHO, Des Moines, Ia. (526), 11-12 midnight, dance program, Cotillon ball room orchestra, Gale Fitch, director.

WLS, Chicago, Ill. (344.6), 6:30 p. m., Ralph Emerson, organist; 6:50, Senate studio; 7, Woodshed theater; 7:20, Dorothy Bell, harpist; Phyllis Campbell, contralto.

WLW, Cincinnati, Ohio (423), 4 p. m., French lesson. Madame Ida Teampidis; Adelaide Apfel, pianist; 6, dinner hour concert, Selinsky instrumental quintet; three minute message, Civil Service Dept., United States government; 10:03, Cooper corporation concert program; Cooper concert orchestra and male quartet; Larry Grueter, piano-acordion solos; Doherty melody boys.

WMAQ, Chicago, Ill. (447.5), 6 p. m., Chicago theater organ recital; 6:25, Hotel LaSalle orchestra; 6:50, Daddy, S. garden talk, James H. Burdett; 8:15, Western Railway commission; 8:30, Jane P. Fritch, soprano; 8:45, talk on income tax; 8:50, University of Chicago lecture; 9:15, program, Edgewater gee club.

WMC, Memphis, Tenn. (499.7), 8:30 p. m., program, Methodist orphanage.

WOAI, San Antonio Tex. (394.5), 9:30 p. m., Jimmie Joy's Hotel St. Anthony orchestra.

WOAW, Omaha, Nebr. (526), 5:45 p. m., public news period, Eugene M. Konecky; 6, every child's story hour, Grace Sorenson; 6:20, to be announced; 6:45, dinner program, Randall's Royal Fontanelle orchestra; 9, Omaha Technical high school band, H. W. Wendland, director; 10:30, Frank W. Hodek, Jr., and his Nightingale orchestra.

WOC, Davenport, Ia. (483.6), 5:45 p. m., chimes; 6:30, sandman's visit; 7, musical program, WEA; 11, Lonis Connor and his LeClaire hotel orchestra; Peter MacArthur, baritone.

WOI, Ames, Ia. (270), 8:15 p. m., musical program.

WORD, Batavia, Ill. (275), 8-9 p. m., Presbyterian church choir; International Sunday school lesson, G. L. Pyle.

(Continued on page 14)

Index to Popular and Classical Concerts

TABULATED below is a time table of the stations giving popular and classical concerts this week. The concerts are divided into two classes, popular and classical. Stations are likewise divided into the four different standard times in use. The hours are given in the kind of time in use at each listed station. By using this table as an index and referring to the complete programs below, full information will be obtained.

Popular

Eastern Time Stations

Saturday, March 7: 6:30, WGBS; 8:30, WNYC; 11, WGBS; 12, WAHG; 8:15, WFAF; 9, WNYC; 10, WNYC.

Sunday, March 8: 7:20, WEEI; 8:15, WNYC; 9, WNYC; 10, WNYC.

Monday, March 9: 6:40, WGY; 8, WAHG; WEEI; 8:30, WCX; 8:45, WAHG; 9, WFAF; 9:45, WAHG; 10, WAHG.

Tuesday, March 10: 7:10, WFAF; 7:30, WCX; 7:35, WNYC; 8, WCAU; WCX; 8:30, WCAE, WFAF, WEEI, WFI; 9, WFAF, WEEI, WFI; 11, WIP.

Wednesday, March 11: 7, WGY; 8:30, WCX; 8:45, WCAU; 9, WAHG, WFAF; 10, WAHG.

Thursday, March 12: 7, WCAE; 8:30, WCX, WFAF; 11:45, WJZ.

Friday, March 13: 6:05, WIP; 8, WFAF; 8:15, WGY; 8:30, WAHG, WCX, WJY; 9:20, WCAU; 10:15, WAHG; 10:30, WJZ.

Central Time Stations

Saturday, March 7: 7:20, WLS; 8, WBCN, WLS, WMAQ; 8:30, WFAA; 9, WBCN, WEBB, WLS, WOAW; 10, WBCN, WEBB, WLS, WQJ; 11, WBCN, WEBB, WQJ; 11:45, WDAF; 12, WBCN, WEBB, WQJ; 1, WQJ; 2, WQJ.

Sunday, March 8: 8, WBCN; 9, WBCN; 11, WBAP; 12, WEBB.

Monday, March 9: 6:30, WOAW; 9:30, WBAP, WOAW; 11:45, WDAF.

Tuesday, March 10: 8, WEBB, WCCO; 8:30, WLW; 9, CKY, WEBB, WLW; 9:40, WLS; 10, WEBB, WLS, WOAW, WQJ; 10:40, WLS; 11, WEBB, WLS, WMC, WQJ; 11:45, WDAF; 12, WEBB, WLS, WQJ; 1, WQJ.

Wednesday, March 11: 7, WGY; 8:30, WCX; 8:45, WCAU; 9, WAHG, WFAF; 10, WAHG.

Thursday, March 12: 7, WCAE; 8:30, WCX, WFAF; 11:45, WJZ.

Friday, March 13: 6:05, WIP; 8, WFAF; 8:15, WGY; 8:30, WAHG, WCX, WJY; 9:20, WCAU; 10:15, WAHG; 10:30, WJZ.

Mountain Time Stations

Monday, March 9: 8:10, KOA; 10, CFAC.

Tuesday, March 10: 7:45, CFAC; 10, CFAC.

Thursday, March 12: 9, CFAC.

Friday, March 13: 8:10, KOA.

Pacific Time Stations

Saturday, March 7: 8, KFI, KGO, KHJ; 9, KNX; 10, KFI; 11, KHJ, KNX; 1, KNX.

Sunday, March 8: 7, KFI.

Monday, March 9: 8, KFI; 8:30, KFOA; 9, KFI, KNX.

Tuesday, March 10: 7, KNX; 8, KGO, KHJ, KNX; 9, KNX; 10, KFI, KNX.

Wednesday, March 11: 7:30, KFI; 8, KFI, KPO; 9, KFI, KHJ, KNX.

Thursday, March 12: 7, KFI; 8, KGO, KHJ; 9, KNX; 9:30, KHJ.

Friday, March 13: 8, KGO, KNX, KPO; 8:30, KFOA; 10:30, KGW.

Classical

Eastern Time Stations

Saturday, March 7: 6, WCX, WFAF, WGR; 6:30, WCAE, WFI; 7, WFAF, WRC; 7:30, CKAC, WBZ, WLIT; 7:45, WCAE; 7:50, WFAF; 8, CNRO, WBZ; 8:15, WFAF, WIP, WJZ; 8:30, CKAC, KDKA, WCAE, WJZ, WRC, WJZ; 8:45, WBBR; 9, WBZ, WJZ, WNYC; 9:15, WBBR; 9:30, WJZ; 9:45, WBZ, WGBS; 10, WJZ; 10:30, WGBS; 11:05, WIP; 11:15, WRC.

Sunday, March 8: 6, WCAU; 6:30, KDKA, WCAE; 7:30, WGY; 8, WJZ; 8:15, WJZ; 8:45, WGY; 9:15, WEEI; 9:20, WFAF; 9:30, WBBR; 10:10, WBBR.

Monday, March 9: 6, WFAF; 6:30, WCAE, WFI; 7, WFAF, WBAR; 7:30, KDKA, WGY, WOO; 7:45, WCAE, WNYC; 8, WBBR, WMAK, WOO, WTAM; 8:15, WAHG; 8:30, CHNC, WAHG, WCAE, WFAF, WLIT; 9, WCAE, WTAM; 9:30, WLIT; 10, WCAE; 10:03, WOO; 11, WCAE, WTAM; 11:30, WAHG.

Tuesday, March 10: 6, WCX, WFAF, WTAM, WJZ; 6:30, WCAE, WFI, WGY; 7, WFAF, WEAR, WRC; 7:20, WFAF; 7:30, CKAC, WCAU, WFAF; 7:40, WGY; 7:45, WCAE; 8, KDKA, WCAE, WEAR, WEEI, WFI, WKAQ, WJZ; 8:15, WJZ; 8:20, WCAU; 8:30, CKAC, WGBS; 8:40, WCAU; 8:45, WNYC; 9, KDKA, WCAE, WCAU, WGBS, WJZ, WRC; 9:15, WIP; 10, KDKA, WCAE.

Wednesday, March 11: 6, WCAU, WCX, WKAQ, WFAF, WJZ; 6:05, WIP; 6:15, KDKA; 6:30, WCAE, WFI; 7, CNRO, WEAR; 7:30, WFAF, WOO; 7:45, WCAE; 8, WAHG, WFAF, WEAO, WEEI, WTAM; 8:10, WCAU; 8:25, WJZ; 8:30, KDKA, WCAE, WOO; 9, WCAE, WEAO, WEEI; 9:40, WCAU; 9:45, WNYC; 10:03, WOO; 10:05, WCAU; 10:15, WJZ; 10:30, WCAE.

Thursday, March 12: 6, WCX, WFAF, WTAM, WJZ; 6:05, WIP; 6:30, WCAE, WEAR, WGY, WKAQ; 7, KDKA, WEAR, WEEI, WRC; 7:30, KDKA, WCAU; 7:45, WCAE, WFAF, WGY; 8, WBBR, WCAE, WEAR, WEEI, WFI, WRC; 8:15, WCAU, WIP; 8:30, CKAC, CNRW, WEEI; WNYC; 8:40, WBBR; 8:50, WCAU; 9, WCAE, WEAR, WFAF, WEEI, WFI, WGBS; 9:45, WJZ; 10, KDKA, WCAE; 10:15, CNRC; 10:30, WJZ; 11:30, WGY.

Friday, March 13: 6, WCX, WFAF, WJZ; 6:30, WCAE, WFI; 7, WCAU, WFAF, WEAR, WGY, WJY, WJZ; 7:25, WEEI; 7:30, WOO; 7:45, WFAF, WGY; 8, WEAR, WEEI, WNYC, WOO; 8:10, WCAU; 8:30, CNRT, KDKA, WCAE; 8:40, WFAF, WJZ; 9, WAHG, WNYC; 10:03, WOO; 10:15, WFAF; 10:30, WGY; 10:45, WFAF.

Central Time Stations

Saturday, March 7: 6, WGN, WLW; 6:30, KFNF, WGN, WOAW; 6:45, WOAW; 7, KYW, WBCN, WEBB, WQJ; 7:30, WHAS, WMC; 8, KSD, KYW, WGN; 8:30, KTHS, WCCO; 9,

CING

al Time)

March 7:

8:30, Wgy;

Webb; 9:05,

Wjz, Wrc;

Kpo, Kths,

Wqj; 10:30,

11, Wahg,

W, Woc; 12,

Khj, Knx,

Hj.

March 9:

8,

Kpo,

Wlit; 9:15,

WFAF, WOO;

1, Kfi; 11:30,

8, Kgo, Kpo,

15, Kths; 1,

nx.

March 10:

9,

Wex, Weel,

Wlv; 9:30,

Wip, Wrc;

Wqj; 10:30,

w; 12, Kgo,

Kpo; 12:05,

nx.

March 11:

y, March 11:

9:03, Wlit;

9:45, Wro;

Weaf, Wgn,

n; 11, Koa;

rw, Khj, Klx,

March 12:

8,

WGBS; 9,

Koa, Kpo,

; 9:20, Weau;

; 9:45, Wrc;

Wgn, Wip,

Wwoaw; 11,

12, Khj, Kgo,

Knx, Kpo;

March 13:

8:30,

Wex; 9:03,

Chrt, Wahg,

; 9:45, Wjz;

Wgn, Wqj;

aw; 11, Kfi;

t; 12, Khj,

5, Kfoa; 1,

WGBS, New York, N. Y. (316), 3-3:10 p. m., interview with Kathleen MacDonnell and Betty Ross, Terese Rose Nagel; 3:10-3:20, Genevieve Williams, soprano; 3:20-3:30, "Home Architecture," F. D. Armony; 3:30-3:40, Genevieve Williams, soprano; 3:40-3:50, graphology talk, Louise Rice; 3:50-4, Genevieve Williams, soprano; 6-6:30, Dr. Goebel; 7:30-8:30, Armand Vecsey's orchestra; 8:30-9, "Footlights and Lamplights," Oliver Saylor; 9-9:30, Harry J. Caffrey, tenor; 9:30-11, Russian Eagle orchestra.

WGY, Schenectady, N. Y. (379.5), 2 p. m., music and one-act play; 2:30, organ recital, Stephen E. Bolsclair; 6:30, dinner music, Hotel Ten Eyck orchestra; 7:30, review of new books, L. L. Hopkins; 7:45, program, Brill; 11:30, Stephen E. Bolsclair, organist.

WHN, New York, N. Y. (360), 12:30-1 p. m., Charles Strickland's Palais D'Or orchestra; 6:30-7, violin solos, Olcott Vail; 7-7:30, Harry Rose and Silver Slipper revue; 7:30-7:45, health talk, Dr. Landis; 8-8:30, Everglades revue; 9:30-10, O'Meara Gardens' orchestra; 11-11:30, Connie's Inn revue; 11:30-12, Wig-wam club revue; 12-12:30 a. m., Parody club revue and orchestra.

WIP, Philadelphia, Pa. (508.2), 3 p. m., recital, students Philadelphia Musical academy; 4, Harmonica band; 6:05, Benjamin Franklin concert orchestra; 7, Uncle Wip's bedtime stories; 8:15, Philadelphia Police band; 10:05, "The Concentration of Human Vision," Dr. J. F. Neill, Jr.; 11, Harvey Marburger's dance orchestra.

WJZ, New York, N. Y. (405.2), 7:30-8 p. m., Ralph Detefani and his Penatiquit Point inn orchestra; 8:15-8:30, "American Fishes," Barton A. Bean of Smithsonian institute; 9:45-10, American Pen Women program.

WJZ, New York, N. Y. (454.3), 4-4:15 p. m., Edith Marion, soprano; 4:15-4:30, Ralph Thomas, tenor; 4:30-5:30, Bernhard Levitow's Hotel Commodore tea orchestra; 7-7:55, Bernhard Levitow's Hotel Commodore orchestra; 7:55-8:25, "New Brains for Old," John B. Kennedy of Colliers; 10:30-10:45, Josephine Evans, contralto; 11:45-12, songs, Olga Steck.

WKAQ, San Juan, P. R. (340.7), 7:30-9 p. m., concert, La Cafetera.

WLIT, Philadelphia, Pa. (394.5), 2 p. m., Arcadia cafe concert orchestra; 2:30, Irena Sharer, soprano; 7:30, Dream Daddy's bedtime stories.

WMA, Lockport, N. Y. (265.3), 12 midnight, Murray Whiteman's Midnight serenaders.

WNYC, New York, N. Y. (526), 7:20-7:30 p. m., sports talk, Thornton Fisher; 8-8:15, "Timely Topics," Frands P. Bent; 8:30-9:30, concert program.

WOO, Philadelphia, Pa. (508.2), 4:45 p. m., organ recital, Mary E. Vogt.

WOR, Newark, N. J. (405), 6:15-7:15 p. m., Tom Cooper's Country club orchestra.

WRC, Washington, D. C. (463.5), 6:45 p. m., children's hour, Peggy Albion; 7, Lee House trio; 8, "Mexican Night," Pan-American union; United States army band; Mexican ambassador, speaker; 10:45, dance music, Jacques Green and his Club Deauville orchestra; Clark's Hawaiians.

WREO, Lansing, Mich. (285.5), 8:15-9:45 p. m., Reo Broadcasting orchestra; Reo male quartet.

WTAM, Cleveland, Ohio (389.4), 6-7 p. m., Hotel Statler studio dinner music, Maurlee Spitalny, director.

WWJ, Detroit, Mich. (352.7), 3 p. m., Detroit News orchestra; 6, dinner concert; 8, concert from WFAF.

Central Time Stations

CKY, Winnipeg, Can. (450), 7:30 p. m., French lecture, Prof. A. C. de la Lande; 8, Canadian National Railways program (CNRY).

KFKU, Lawrence, Kans. (275), 6:50 p. m., piano tuning-in number; 7, music; 7:15, "Hardy Herbaceous Perennials for the Flower Garden," Prof. W. C. Stevens; 7:30, "Early History of Chemical Anaesthetics," Dr. F. B. Dains; 7:45, educational psychology, lesson X, Dean R. A. Schwieger.

KFKX, Hastings, Nebr. (283.3), 9:30-11:30 p. m., talent from Holdrege.

KFMQ, Fayetteville, Ark. (299.8), 7:30 p. m., Phi Mu society; "How Much Training Should a Primary Teacher Have?" Lela Armstrong; "Educational Op-

Thursday, March 12

(Continued from page 13)

WQJ, Chicago, Ill. (447.5), 7-8 p. m., dinner concert. Ralph Williams and his Rainbo Garden orchestra; Mrs. Lydia Lochner, contralto; Edith Buckmaster, accompanist; Blanche E. Robinson, pianist; Mildred Perlin, reader; 10-2, Ralph Williams and his Rainbo Skylarks; Lew Butler, Giant of Radio; Ned and Ches; Marie Wright, soprano; James J. Whalen, tenor; 1-2, Hotsy Totsy hour, Ralph Williams, Gingserman, Little Skylarks.

Pacific Time Stations

KFI, Los Angeles, Calif. (476), 5:30-6 p. m., Examiner's musical half hour; 6:45-7, Raditorial and Y. M. C. A. speaker; 7:45, dance orchestra; 7:45-8, classical songs, Paul Reese; 8-9, program, Standard Oil company of California in charge of Aerio, Microphone and Statics; 9-10, program of old time ballads; 10-11, Examiner, dance orchestra.

Friday, March 13

Friday, silent night for: CFAC, CHNC, CKAC, KFKU, KFKX, KFMQ, KGO, KSD, WBBR, WBZ, WCBZ, WEAO, WEBW, WGST, WHAZ, WIP, WKAQ, WLBL, WLW, WRBC, WSUI.

Eastern Time Stations

CNRT, Toronto, Can. (356), 6:30-8 p. m., Luigi Romanelli and his King Edward hotel concert orchestra; 8:30-10, Nellie Gill, soprano; George Aldcroft, baritone; Blithon trio; L. Gelan, violinist; Lionel Bilton, cellist; Simon Joyce, pianist; 9, address; 10:30-12, Luigi Romanelli and his King Edward hotel dance orchestra.

WLIT, Philadelphia, Pa. (394.5), 2 p. m., Arcadia cafe concert orchestra; 7:30, Dream Daddy's bedtime stories; 8, book review, Arnold Abbott; 8:10, "Fifteen Minutes of Humor," Sam Wingfield; 9:30, Cotton Pickers' dance orchestra; 10:03, Arcadia cafe dance orchestra; Morning Glory club concert.

Central Time Stations

WKY, Winnipeg, Can. (450), 7:30 p. m., university lecture; 8, concert, Mason & Risch Piano company.

Mountain Time Station

KOA, Denver, Colo. (322.4), 8 p. m., Fred Schmit and his Balto theater orchestra; 8:10, Poster Auto Supply company, Columbia trio; F. A. Franklin, reader; Mrs. A. A. Doney, contralto; G. Ralph Crowder, pianist; KOA orchestra.

Pacific Time Stations

KFAE, Pullman, Wash. (348.6), 7:30-9 p. m., Prof. Heber Nasmyth, baritone; Mrs. Louise Nasmyth, pianist; "Highway Safety," Prof. H. E. Phelps; "Private Roadways for the Farm," A. B. Crane; health talk; new books, Alice L. Webb.

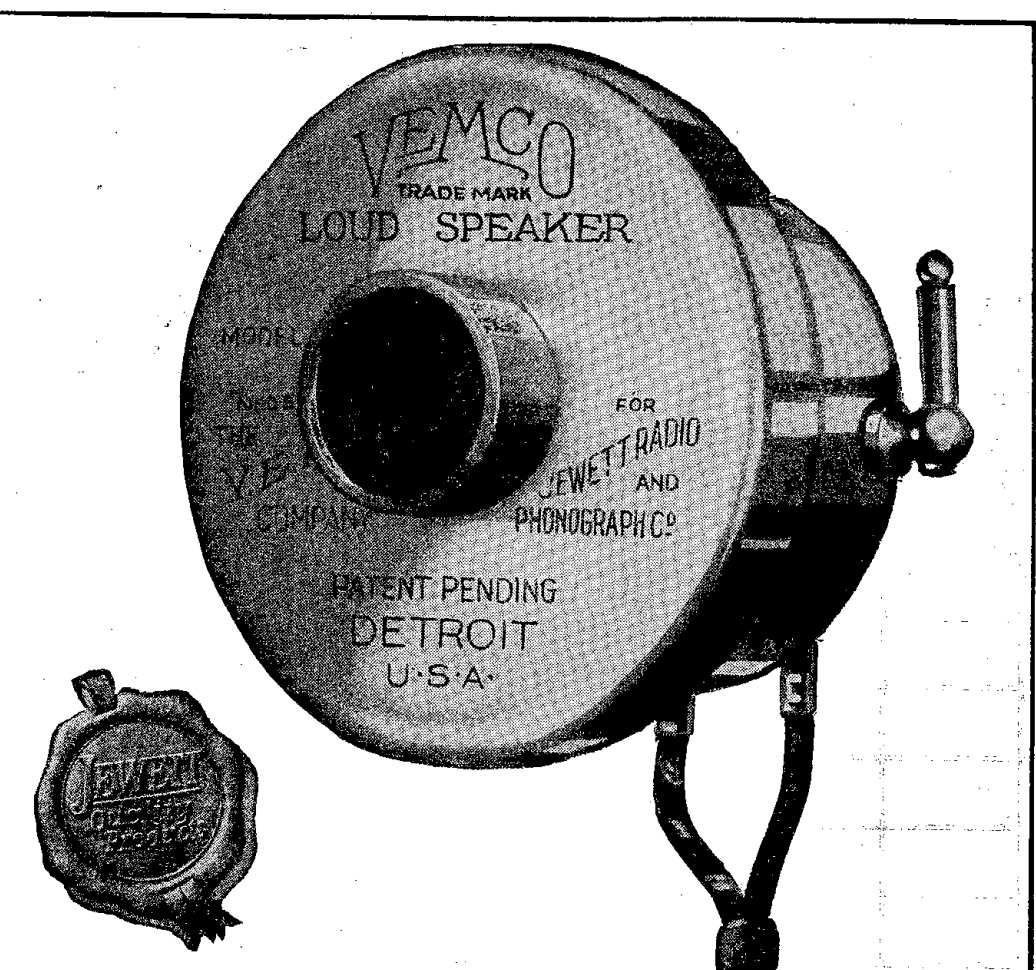

Good Radio Reproduction is assured when you connect your Set and your Phonograph with the Jewett Vemco Unit.

Just slip off the diaphragm, slip on the Vemco and listen to Radio that equals the finest phonograph record you have ever heard!

No changes, no tools—Standard fits Victrola; adapters for other makes—Adjustable to increase volume from distant stations—The same reproducer used in the world-famous Superspeaker. Avoid imitations—There is only one Vemco, and Jewett builds it.

JEWETT RADIO & PHONOGRAPH COMPANY 5670 TWELFTH STREET DETROIT, MICHIGAN

The Jewett Vemco Unit

"There is no substitute for the best"

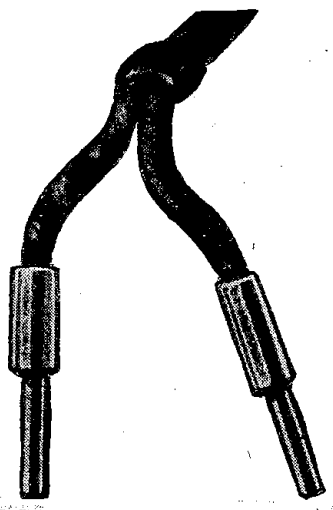

Chart The Aerial Highways and Save Time

Condenser Curves Easy To Make

By James McDonald

PRACTICALLY every owner of a receiving set makes up a log book in which he puts the dial settings of the stations he is able to find by careful listening and accurate tuning, but, while these settings enable him to return quickly to the stations he has already tuned in, they do not help him very much when looking for new ones.

More advanced Radio men have a system which is called "plotting the condenser curves" that enables them to quickly determine dial settings for any station they may wish to hear and, if the dials are set at the points indicated, the receiver is sufficiently sensitive and the station desired is on the air, the program will be heard. Any owner of a Radio set can easily make up the necessary charts and the only material necessary is a sheet of "graph" paper divided into squares so that there are 10 small squares divided by light lines inside of large squares divided by heavier lines. This paper can be had at any store carrying supplies for engineers, draftsmen or architects.

Tuned R. F. and Neutrodyne

Figure 1 shows one of these curves made up for a tuned Radio frequency or neutrodyne receiver and, for the sake of

station were 75½ for the first dial and 69 for each of the other two dials. The two small crosses at point A are therefore marked on the chart and another station tuned in. The second station in this case was WSAI with a wave length of 325.9 and the dial settings were 21 for the second and third dials and 24 for the first dial. The two crosses at point B were put in and, as the third station, was

The owner of this set wishes to tune in Station WMAQ and finds by the program that the wave length is 447.5. On the bottom line he therefore finds the point 447.5 and follows that point vertically to the two points at which it crosses the curves drawn. In this case it strikes the curve for the first dial at 64 and the curve for the other two dials at 60. Station WMAQ will therefore be found at

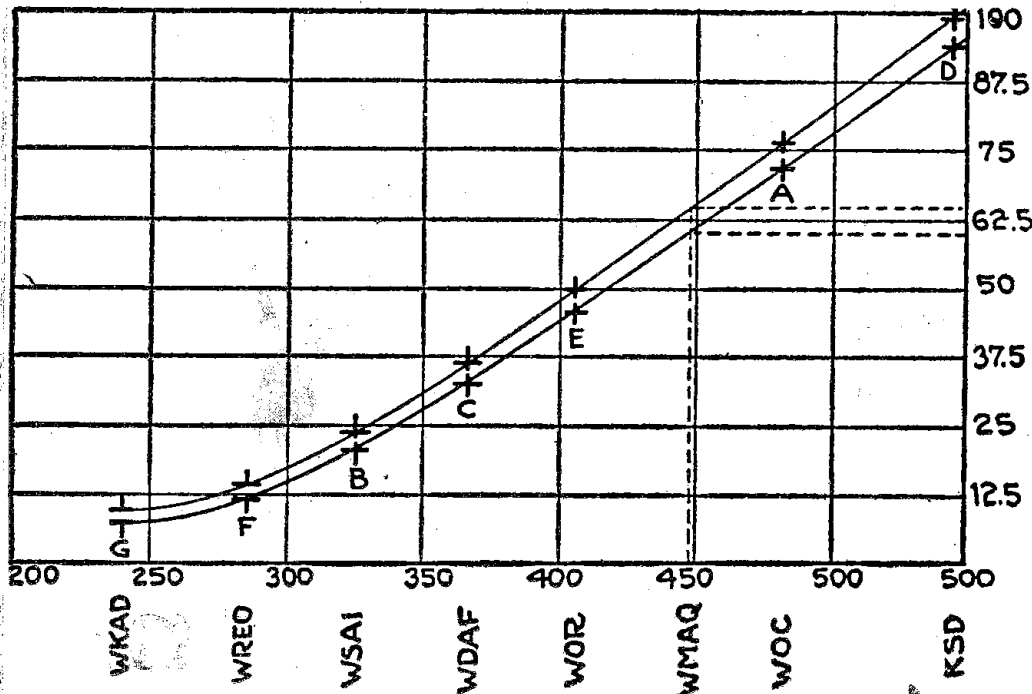

Figure 1

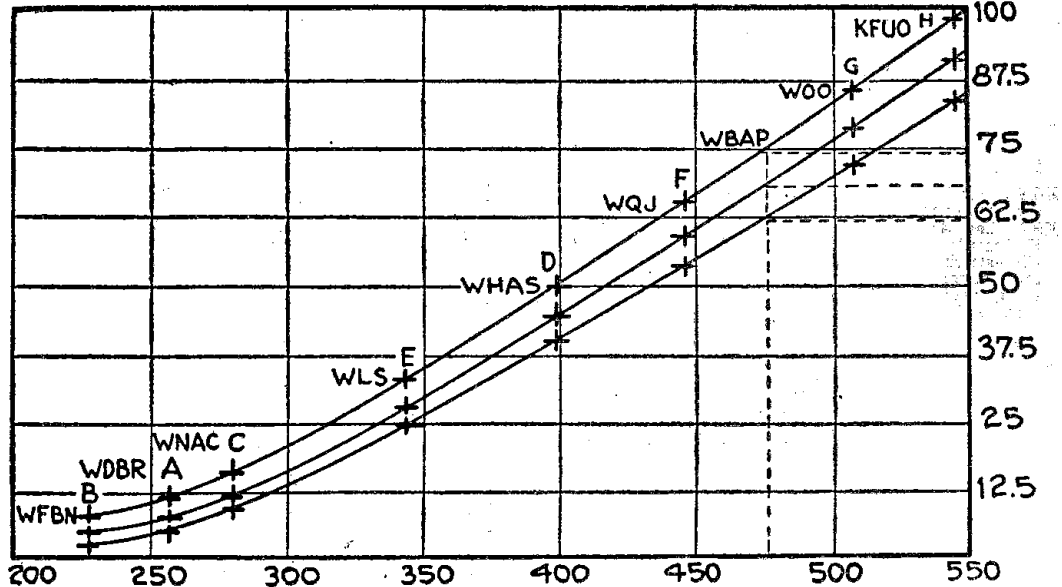

Figure 2

clearness, the smaller lines have been omitted. The owner of the set for which this chart is made first tuned in Station WOC broadcasting on 483.6 meters. Wave lengths between 200 and 550 meters are indicated across the bottom line, so 483.6 is found on the bottom line and followed vertically to the point where it crosses the correct dial setting line, which is horizontal. Dial settings are shown vertically to the right. The dial settings for this

those dial settings if it is on the air and within the range of this receiver. **Super-Heterodyne**
In figure 2 we have the curves drawn for a super-heterodyne. When tuning this type of set it is found that stations come in at one point on the loop tuning dial and two points on the heterodyne dial. On the chart shown in figure 2 the middle curve is for the loop condenser while the upper and lower curves are for the upper and lower settings of the oscillator condenser. In this case the owner first tuned in Sta-

tion WDAF on 365.6, the two crosses at point C were put in. The fourth station was KSD with a wave length of 545.1 and the dial settings were 99 for the first dial and 93½ for the other two. Crosses were accordingly placed on the chart at the point D. Three other stations were then tuned in and crosses marked at the points E, F and G which provided, altogether, seven points on which to make a curve. The points were then connected as shown by the two long slanting lines.

Now, to use this chart for the finding of new stations, the procedure is as follows:

tion WMAQ will therefore be found at

Super-Heterodyne

those dial settings if it is on the air and within the range of this receiver.

(Continued on page 20)

Why it is Better

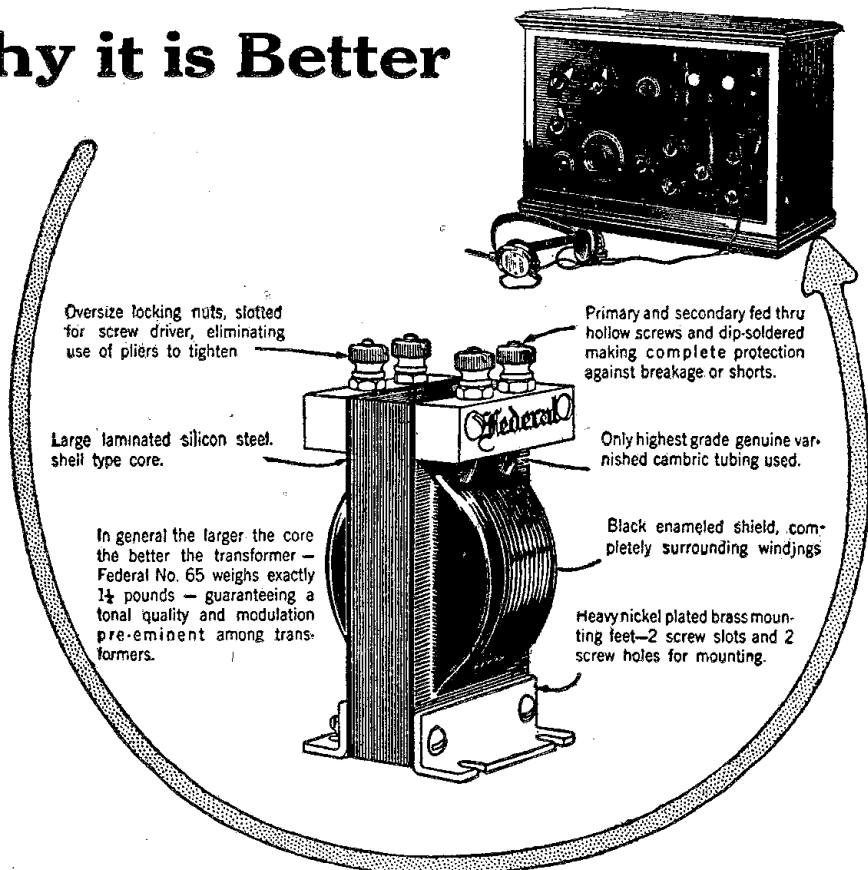

"MASTER of Every Note in the Orchestral Range" is the proven claim of the Federal No. 65 Audio Frequency Transformer! Volume without distortion is the basis for the beauty of Federal Tone.

From its oversize locking nuts to its heavy brass mounting feet the Federal No. 65 Transformer incorporates the

same engineering skill that has made Federal the recognized leader in electrical communication apparatus since 1890.

Insist upon Federal parts for your "pet" hook-up. There are over 130 standard parts bearing the Federal iron-clad performance guarantee.

FEDERAL TELEPHONE MANUFACTURING CORP.
Buffalo, N. Y.

Boston
New York
Philadelphia
Pittsburgh



Federal

Standard RADIO Products

Chicago
San Francisco
Bridgeburg
Canada

New Model Tungar charges all batteries

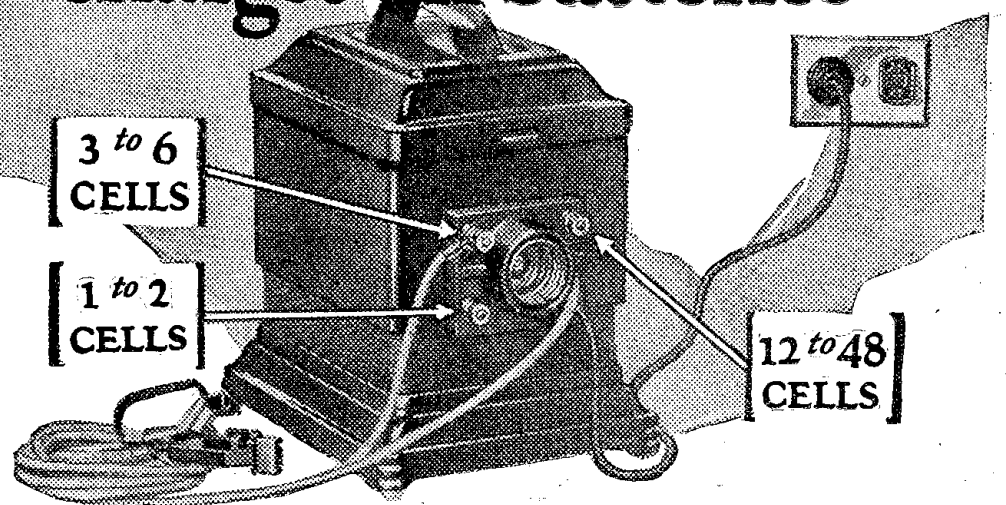

On the back of the Tungar, there are three terminals. Slip the wire into one and charge your radio "A" battery, 2 or 4 volt size. Use the second to charge your radio "B" battery, 24 to 96 volt size. Or the third will charge a 6 volt "A" battery or 6 to 12 volt auto battery.

Just clip on the Tungar, and plug it into any electric outlet in the house or garage. Then leave it overnight to charge while you sleep. Very simple.



The Tungar is a G-E product, developed in the great Research Laboratories of General Electric.

The New Model Tungar charges Radio A and B storage batteries, and auto batteries. Two ampere size (East of the Rockies) . . . \$18.00

The Tungar is also available in five ampere size (East of the Rockies) . . . \$28.00

60 cycles - 110 volts

Tungar

REG. U.S. PAT. OFF.

BATTERY CHARGER

Tungar—a registered trade mark—is found only on the genuine. Look for it on the name plate.

Merchandise Department
General Electric Company
Bridgeport, Conn.

GENERAL ELECTRIC

Radio Digest

PROGRAMS
Illustrated

Published by the Radio Digest Publishing Company, Inc.
510 North Dearborn Street
Chicago, Illinois
Telephones: State 4372, 4373, 4374, 4375

E. C. RAYNER, Publisher

Eastern Office, Park Lexington Building, 247 Park Ave.,
New York. Telephones: Murray Hill 0106, 0107, 0108.

Member of the Audit Bureau of Circulations



241
PUBLISHED WEEKLY

SUBSCRIPTION RATES
Yearly in U. S. and Possessions and Canada, \$5.00
Foreign postage, \$1.00 additional. Single copies, 10 cents.

Vol. XII Saturday, March 7, 1925 No. 9

Official Washington Sleeps On

PROGRESS—a word in eight letters meaning growth or development—is evidently not present in the vocabularies of many of our federal officials. Witness our Army and Navy. The secretaries of these two departments, Weeks and Wilbur, would stick their heads into holes in the sand like the well-known ostrich and use auto-suggestion on themselves to make believe they have efficient fighting weapons. We are for Brigadier General Mitchell, assistant chief of the Army air forces. As we go to press the country is in a turmoil and rumors are current that his official head will be chopped off. Why? Because he is progressive. He dared to show that Mr. Weeks and Mr. Wilbur had suppressed test reports showing how superior fighting aircraft were to battleships and land forces.

Hasn't Radio shown official Washington that modern inventions developed with great speed? The department of commerce certainly knows this. But even with Radio, Congress and our Washington sages hold tight the purse strings and delay necessary laws. Again we have an example to prove that many—entirely too many—of our federal officials need to learn the meaning of the word progress.

Radio and her sister ally of the air, the aircraft, will win the next war. It is poppcockish to sit by idly and twiddle our thumbs. Time waits for no man. The airplane and Radio are here to stay. Both demand more recognition from our Congress, Senate, chief executive and his cabinet, than has been given heretofore.

As concluding thoughts, dare we suggest that Weeks and Wilbur either dust off the accumulated cobwebs or better resign; that Brigadier General Mitchell be given a portfolio in President Coolidge's cabinet as Secretary of the Combined Army, Navy and Marine Air Forces; and that someone in Washington get busy and secure needed funds and legislation for the proper administration of Radio?

Progress of Radio

THOSE good old days in Radio were not so good after all. Every fan who was in the art in its infancy will always remember with a vividness and joy akin to affection his experiments and struggles in those early days, and his delight when he overcame the difficulties under which he worked and got results in his primitive set.

But if you were one of those early fans you remember how your home was strewn with huge coils, switchboards and other apparatus, and how crude your set looked. You will never forget the thrill when you brought in something, even if it was only the time signals at Arlington on the earphone.

Now the general public is beginning to realize how rapidly and how potently Radio is effecting education, music, entertainment, sports, politics and other spheres of modern life. But way back in the beginning, who dreamed of the ramifications of Radio? Honestly, did you ever expect to hear the world's series over the Radio?

And yet a few short years ago Radio was in its beginning stages everywhere. Its rush into everyday life is one of the miracles of the age.

Frequent Announcing of Call Letters

ACCORDING to reports received by the Radio Bureau the announcers of some of the broadcasting stations continue programs for long periods without announcing the call letters of the stations and as some of the call letters are not readily understood, suggestion has been made that some other method be adopted which will make identification more positive.

It will probably be helpful if when making an announcement the call letters of a station are followed by the name of the city in which the broadcasting station is situated and would no doubt be appreciated by the audience if the announcers would announce distinctly the call letters and name of the city at somewhat regular intervals.

RADIO INDI-GEST

Extra! Indi's Expedition Found

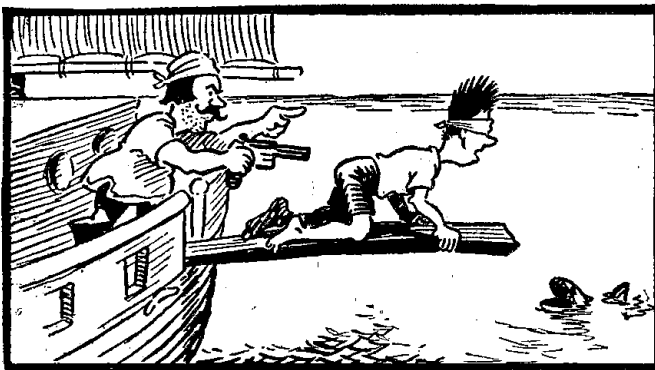

A Radiogram has been received from the Walla Walla expedition, telling of a thrilling battle between a number of pirates and the crew of the S. S. Kanooofs. The story is given below, and is aptly described by Capt. Oneoar, the brave commander of the "Kanooofs." It is told by the captain as follows:

"While cruising off the isle of Oofy Goofty, the Kanooofs ran into a smooth sea and was becalmed for ten days. During this time, the crew went swimming and fishing, entertaining themselves with the Radio set, and listening to the programs broadcast for their benefit from various stations.

"Early one morning, a boat came alongside and with a fierce yell, the pirates sprang upon the various members of the crew and overpowered them. This was the beginning of the end. The Radio operator was blindfolded and made to walk the plank. Just as he was about to drop off the plank into the water, he thought of a good joke, and whispered it to the leader of the pirates.

"It was so good, that the leader decided to postpone the plank-walking stunt until the following day. 'Sparks,' heaving a sigh of relief, sneaked away to his shack and started to send out a distress call. The pirates became aware of what he was doing, and told him to sign off. That ended all hope of being saved. That night the crew got together and formulated plans to escape from the clutches of the buccaneers, and we went to bed."

(Don't fail to read the finish of this thrilling installment in next week's Indi-Gest column.)

Station WOS

Jeff-pher-sawn Sit-ee—Miz-zu-ree

(With apologies to Breton Braley)

In the life of the nation, each broadcasting station
Is quickly displacing some movie or play;
In this age of invention, each reel you may mention
Becomes very quickly passe.
The harsh rasping screeches, the queer ranting speeches
Which once filled the ether are gone;
While smart airs and graces of charming sopranos
and bassos
Beguile us as time passes on.

But still there's one splendid old friend that I miss
When music is crushed by static's wild fury;
One joy now is ended—and that is just this—
The voice of Don Witten at

Jeff-pher-sawn
Sit-ee, Miz-zu-ree.

When worn with searching through static's crash
lurching,
How good to arrive at the Capitol Dome;
Where Louis and Bryan, with fiddle bow flyin',
Were bringing back memories of home.
Each tune served some "function" at Jerkwater Junction,
In camp, or "Van Winkle" town;
G. Shrimp might be boring, his heel through the flooring,
Still your griefs you could drown.

And so I am singing the gladness it threw,
(I am acting as judge and as jury)
The joy it was flinging when winter winds blew,
The voice of Don Witten at

Jeff-pher-sawn
Sit-ee, Miz-zu-ree.

A Sure Cure for the Squealers

Our set is selective, no part is defective;
'Tis built from the most recent circuit;
But every adjective of biting invective
We utter whenever we work it.

None mind a few snatches of static and scratches
Which issue sometimes from the speaker;
The unsolvable catch is to find what pest matches
The ubiquitous one-circuit squeaker.

His whole-souled adherence to this interference
Shows his patience is simply amazing;
But from outward appearance he knows perserverance
Will very soon bring him a hazing.

What would be so nice, should he come for advice,
I might give him in manner mendacious;
'Twould be done in a trice, for I have on the ice
A solution that's most efficacious.

Should he ask, with a flip little quirk of his lip,
How to stop making other fans boil,—
With a dexterous snip I will take off the tip
Of his one tube, and pour in some oil!
HOLLIS DE NEEFFE.

Better Than a Wife!

He: The wife I shall choose will charm me with music when I feel like it, and have the sense to shut up when I don't.
She: You don't want a wife, you want a tube set!
A. B. C.

The Newcomer



Condensed

By DIELECTRIC

Most every time that WTAM has been tuned in a program of attractive features holds my attention. This was not so on a recent occasion, for while the orchestral numbers were pleasing and varied a violinist of very mediocre attainment rendered selections in a way to encourage dial twisting. The good offset the poor artists.

Probably few among the millions of Radio listeners dislike singing of old darcy melodies, hence it is likely that WHAZ had a good "turn out" to their concert presenting the Radio Quartet in a group of southern songs with typical negro dialect. Look for them.

In listening to WHO one evening a soprano held the limelight through several selections. It is somewhat the fashion to make a joke of the soprano where Radiocasting is concerned, but most studios do not favor them to the near exclusion of singers with other registers (as previously), so we feel more kindly toward them. However, there was but one song, Honest and Truly, which this lady sang effectively.

Out in Nebraska you will find a Radio station with the call letters of KFKX where a male quartet entertains frequently, and there you will spend an enjoyable evening with these four singers. I shall not review the numbers given as I listened, but only assure you that all of them were of cheerful mood and worth tuning for.

These Victor concerts emanating from WEA and spread through a network of additional stations are cream to the pudding of ordinary programs. You may lack interest in some of the selections, though never fail to appreciate the superiority of the artists. When the Victor Salon orchestra poured forth the exquisite strain of "A Japanese Sunset," you could almost picture the rare coloring of such a scene.

It is now possible to step into movie houses all over the land with merely a Radio ticket purchasable at Radio stores. WGY took its listeners from Schenectady to Albany, N. Y., providing them with excellent seats in the Mark Strand theater to listen to the orchestra play through their program. William Brady would debar us, but not even the ticket scalpers may do that—there are no extortionate prices here.

Reading so much about Cave City, Ky., led a great many fans to tune in WHAS during the last days of the search to see what news the station had for them regarding Floyd Collins. The Kentucky Nite Owls were there to entertain all comers with the late lamentable jazz songs, the most so being "Too Tired," that Romance in A Flat.

A little applause for the Drake Ensemble now and then must be expected from this end of the column because they deserve it. One of the best things they have done recently was the playing of excerpts from the opera, "Jewels of the Madonna." Thanks, WGN, and come again.

The complaint is often made that fans tune in and out station after station to find them listing the same character of program; in many instances, the same numbers. Well, this is usually confined to a single night in a week, anyway, how would you remedy it? I had the extreme pleasure of listening to five orchestras in as many studios all "Waiting for the Sunrise" one night. I didn't wait after that.

Four Filter Eight Tube Super-Heterodyne

Part I—Analysis of Circuit

By Jacques Fournier

WHEN Major Armstrong first conceived the super-heterodyne he built the first model with one filter transformer and three untuned iron core intermediate stages and for some reason all of the super-heterodynes which have followed do not vary from this original design. This is similar in many respects

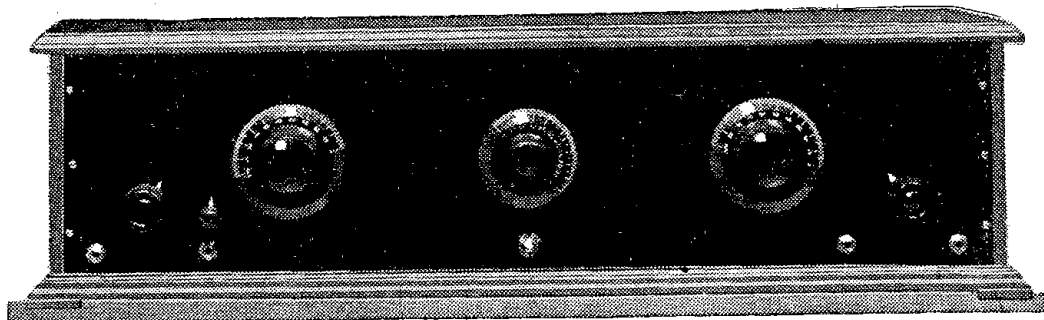

Figure 1

LIST OF PARTS

1 Panel 7 x 30.....	\$ 5.00
1 Panel 7 x 29.....	5.00
8 Sockets, 201-A or 199.....	8.00
2 Variable condensers, .0005 vernier.....	14.00
1 Midget condenser, 13 plate.....	1.50
4 Midget condensers, 9 plate.....	7.00
1 Rheostat, 2 ohm, 3 amp.....	2.50
1 Closed circuit jack, 2 springs.....	.55
2 Double circuit jacks.....	2.00
1 Open circuit jack.....	.70
1 Filament switch.....	1.00
2 Grid leaks with .00025 cond.....	1.50
1 Potentiometer, 400 ohm.....	2.50
1 Pair push pull transformers.....	12.00
3 Bypass condensers, .5 mfd.....	2.70
1 Fixed mica condenser, .006 mfd.....	.75
1 Fixed mica condenser, .002 mfd.....	.40
7 Binding posts.....	.70
2 Angle brackets.....	.30
1 Sheet 1/32" brass or copper 14" x 24".....	.50
2 Lbs. No. 18 dcc. wire.....	2.00
1 Lb. No. 32 dcc.....	2.00
Miscellaneous.....	5.00
150 sq. in. of 1/8" cardboard, 16 lengths of bus bar, 14 lengths of spaghetti, machine screws, solder, lugs, etc.	
1 Cabinet 7" x 30" x 10" depth.....	15.00
Total.....	\$82.60

of sets, they were not all that had been expected.

Putting in Filters

A filter circuit is nothing more than a stage of tuned Radio frequency designed for a long wave length and permanently tuned for that one wave length. Since tuned Radio frequency is much more efficient in the usual five tube set than is untuned Radio frequency, and selectivity is gained by being able to tune each circuit to the frequency of the desired signal, it occurred to the writer that the intermediate stages of a super-heterodyne might just as well be designed as tuned Radio frequency amplifiers operating in the neighborhood of 5,000 meters. A set was built up, using one filter and three of the usual intermediate transformers, then another filter was substituted for the first intermediate transformer and tuned to the same frequency as the filter. The second iron core unit was then removed and the third filter put in and finally this change was made between the third stage of Radio frequency and the detector. The result was a very pleasant surprise, as the selectivity was found to be greatly improved and it was possible to operate the set on a loop aerial within seven blocks of a high power station in Chicago and within six blocks of another and tune out either one on 1 1/2 degrees of the heterodyne dial. Minor changes were made in the filters which showed more improvement and the oscil-

later coupler was next considered with a view to improving its efficiency. A low loss coupler of the basket weave type was built up, adjusted by removing turns, and finally substituted for the coupler previously used. It was felt that since selectivity was aided by using low loss windings in tuned circuits that the heterodyne frequency should also be sharply tuned so that it would heterodyne only the single desired incoming frequency.

Sharpening the Loop

At this stage of the experiments we were satisfied that a much superior super had been developed, but the lack of selectivity in the loop tuning condenser did not seem right, so various methods of increasing the sharpness of that control were considered. Regeneration, if properly handled, will lower the effective resistance of a tuned circuit, so regeneration was introduced into the loop circuit by use of a center tap and a small condenser of about .000045 mfd. capacity connected to the plate of the first detector. This was at first placed inside the cabinet on the baseboard and adjusted to a point at which the loop circuit was just below oscillation on a short wave length. This helped the selectivity and volume remarkably on the lower wave lengths, but its effectiveness was lost on stations above 400 meters. This small condenser was then placed on the panel so that it could be increased when tuning for higher wave lengths, and the benefits of regeneration

were then secured over the entire wave length range. Previous experiments had shown that the writer's location is a very poor one for loop reception as it is effectively shielded either by steel buildings or other large bodies of metal in three directions, and all signals seem to come in when the loop is pointed southwest and northeast. No matter what the direction of a station may be from the writer's home the loop must be in this one position at all times.

Antenna Coupling

It was plain that maximum efficiency was not being had on all stations so it was decided to use a short outdoor aerial as a collector of Radio waves which would not be so seriously affected by nearby metal objects; this brought up the problem of coupling the antenna circuit to the super-heterodyne in such a way that the selectivity would not be seriously impaired. Readers of this magazine will remember the low loss coupler described by the writer in the November 22 issue and, since one of these was available, it was put to use with one of the rotors removed. It is of the basket weave type and the primary can be rotated in relation to the secondary. This coupler worked perfectly with a 50-foot outside aerial, and even though very close to WEBB and WQJ, the two stations mentioned above, the set was able to get out of town stations as though these two powerful locals were not on the air.

The Push Pull Audio

The final part to be tackled was the audio frequency amplification. Those who have built super-heterodynes utilizing two stages of audio frequency amplification have probably had the same difficulties as the writer. When the second stage is plugged in, the potentiometer controlling the intermediate stages must be turned back to such an extent that the volume is but little if any greater than the volume previously had on one stage. Those using very low ratio transformers, such as two to one or three to one, may not have had this difficulty to a marked degree, but

(Continued on page 18)

to the history of the loud speaker, as the speakers and head phones now on the market are practically the same as that first designed by Dr. Alexander Bell many years ago. Like thousands of other Radio enthusiasts, the writer has built super-heterodynes and found that, while they were more selective than other types

It Has the Full Sweet Resonance of Our Upright Horn

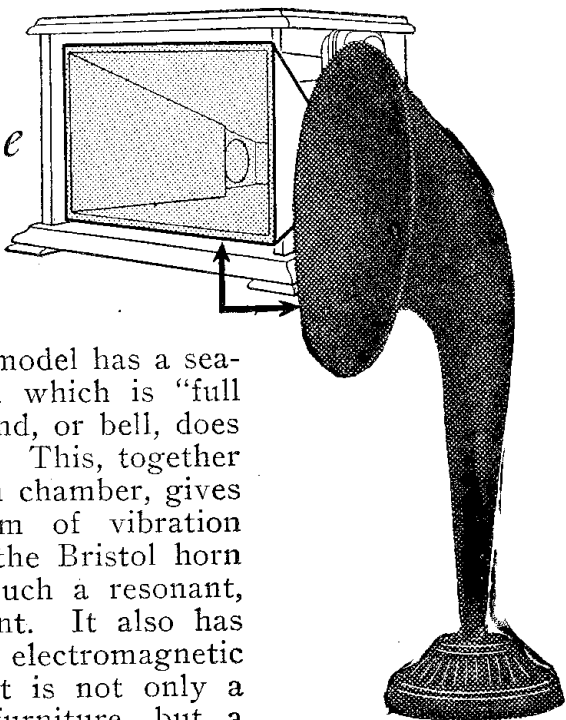

Model S, \$25.00

THE new cabinet model has a seasoned wood horn which is "full floating"—the outer end, or bell, does not touch the cabinet. This, together with a long expansion chamber, gives it that same freedom of vibration which goes to make the Bristol horn type Loud Speaker such a resonant, sweet-toned instrument. It also has the same high-grade electromagnetic sound mechanism. It is not only a handsome piece of furniture, but a speaker worthy of the best radio set that money can buy.

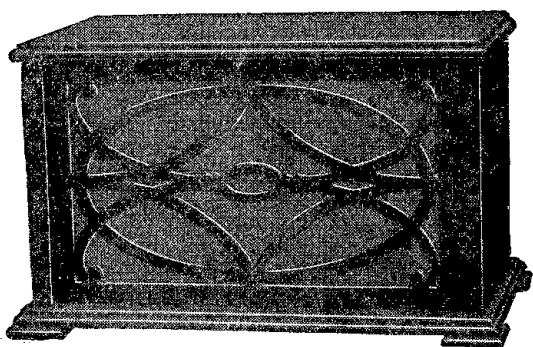

Model "C" Cabinet Type \$30.00
Real Mahogany. Size 17x10x10 1/4

There are five Bristol Loud Speakers, priced from \$12.50 to \$30.00. If not at your dealer's, write for Bulletin No. AY-3020.

THE BRISTOL COMPANY
Waterbury, Conn.

BRISTOL MADE IN U.S.A. **AUDIOPHONE** **Loud Speaker**

For 36 Years Makers of BRISTOL'S RECORDING INSTRUMENTS. Ask Any Technical Engineer

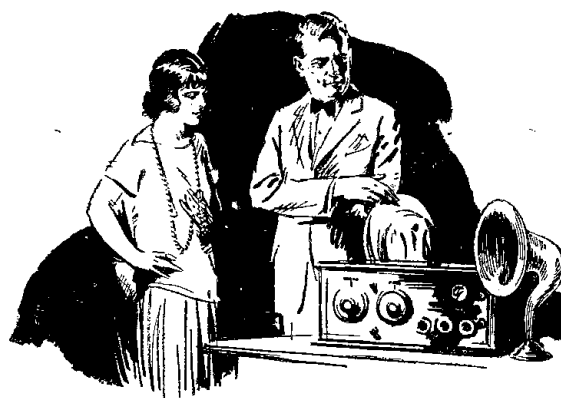

**100%
Tone**

Magic Radio Clearness

with this new principle horn--this Kellogg Symphony Reproducer

This offers a new conception of radio clearness—a recent scientific advance in radio reproduction. It "brings in" the marvels of the air exactly as they were broadcast. With an absolute fidelity of tone that will delight you.

This new way is the Kellogg Symphony Reproducer—now made in quantity production to sell at prices within the reach of every radio owner. It is made by the 28-year-old Kellogg Switchboard & Supply Co., leading specialists in reproduction of sound. The acoustical engineers of

this company worked for years on the problem of clarifying radio reproduction before they finally perfected the **Symphony**.

The shape and contour—the composition of the horn itself, is one of the principal features. But the theory and design of this "unit" is the secret of its wonderful success. This "unit" is unlike anything ever offered before for radio. The magnetic feature gives it watchlike precision. The improved results are noticeable instantly to any who hear it.

HEAR IT TODAY

Today, hear the Kellogg Symphony. Do not buy any lesser horn until you have heard it. It will increase the value of your set 100% in musical quality—in pleasure to your family and yourself. Any dealer will gladly demonstrate the Symphony for you. Hear it—today!

KELLOGG SWITCHBOARD & SUPPLY CO.
Chicago, Illinois

KELLOGG Symphony REPRODUCER

CIRCUIT OF FOURNIER 8-TUBE SUPER-HETERODYNE

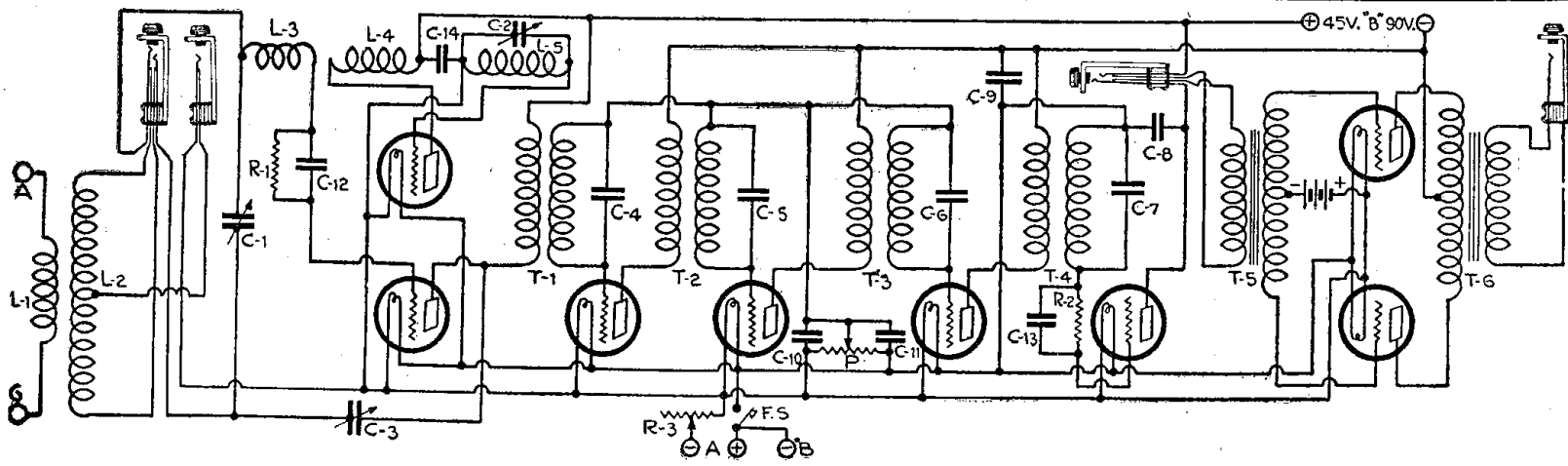

Figure 2

FOUR FILTER SUPER

(Continued from page 17)

those who had used powerful well built transformers with ratios such as four to one or five to one have undoubtedly had this same trouble. However, a single stage of audio frequency amplification will not bring 2,000-mile stations up to desirable volume and it will not handle powerful locals at full volume; the only logical step seemed, therefore, to put in a stage of push pull amplification immediately after the second detector; this to take the place of the two stages previously used. This line of reasoning proved to be correct and the result was excellent tone on powerful locals and greatly increased volume on far away stations. The final set seemed to the writer to be about as perfect as any could be at the present stage of the Radio art and it is this set which the writer is going to tell readers how to build. The circuit is shown in figure 2, and while it may not seem to differ greatly from many of the other super-heterodyne circuits already well known, the improvements lie not in the circuit itself but in the design of the various units making up the set.

While all of the super-heterodynes which the writer has seen, specified that both condensers are to be at the left end

of the panel, there seemed to be no good reason why the front panel could not be made more attractive by a symmetrical layout, so various arrangements were tried until the arrangement shown in figure 1 was found to be both practical and rather attractive. The jack in the lower left hand corner is for the center tap of the loop aerial and the next jack to the right is for the end terminals of the loop. The knob above and between these jacks controls the antenna coupling when the loop is not in use and the outside aerial and ground are connected. Incidentally it should be noted that the antenna and ground can be left permanently attached and that withdrawing the phone plugs connected to the three loop connections automatically puts the split secondary of the antenna coupler on the grid of the first tube. The large dial to the left controls the loop or secondary tuning, whichever is in use, while the large dial to the right controls the heterodyne. The small dial in the center is on the potentiometer; the knob to the right is on the rheostat which controls all eight tubes. The jack in the lower right hand corner is in the plate circuit of the push pull amplifier, while the jack to the left of it is in the plate circuit of the second detector.

The writer wishes to frankly advise Radio Digest readers that this set is not

going to be easy to build nor adjust, as it is super-sensitive and exceptionally selective and one cannot get these features without some difficulties. The receiver is very stable and there is nothing critical in its operation, but care must be taken to build well and to use only parts of the highest quality.

(In the next article Mr. Fournier will describe the construction of the four filters and will also give the baseboard layout so that those who have ready access to Radio stores can proceed at once with the assembly of the apparatus on the baseboard.—Editor's Note.)

Sal Ammoniac in Soldering

Radio set builders and experimenters can solder much easier by using sal ammoniac with their soldering irons. If your iron gets refractory about holding solder, file it bright; heat it just a bit above the soldering temperature; plunge it into the sal ammoniac and apply solder and rosin. Coat the point half way up the iron and let the iron cool.

Broadcast Listener's Reference Library

Part V—Radio Frequency Explained

By Edward Thomas Jones, A. I. R. E.

IN ORDER that a detector of either the crystal or tube type may function, a certain amount of energy must be present in the tuned circuit, and the minimum value which will actuate the detector is called the "threshold" value. The amount of energy which reaches the antenna and the tuned circuit from a small station two or three hundred miles away,

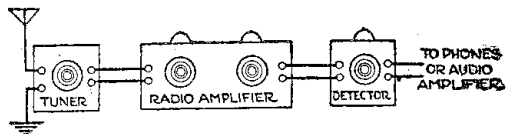

Figure 10

or from a large station about a thousand miles away, is of course very small and is apt to be so minute that the detector cannot rectify the impressed voice or music contained on the incoming wave. Many a signal which reaches the antenna and ground circuit gets no farther and is never heard because of this fact, so the Radio field has resorted to Radio frequency amplification, i. e., strengthening the energy while it is still changing its direction of flow from 500,000 to 1,000,000 times a second.

Referring to figure 10 the reader will note that the receiving set shown contains a tuner and detector which are usually placed right together so that the tuned circuit is across the grid and filament of the detector tube. The tubes that amplify at Radio frequencies are contained in the middle cabinet, which must be inserted between the first tuning apparatus and the detector unit itself. In amplifiers of this type, more than in any other piece of apparatus used, high grade parts should be employed, for, if they are not, nothing is gained by the use of this additional apparatus, and usually there will be a loss.

All types of Radio frequency amplifiers use vacuum tubes and the chief difference between them lies in the methods of coupling the tubes. Since we are all familiar with the transformer method of

coupling audio frequency amplifiers, the first idea which naturally occurs is that of using transformers in Radio frequency stages (see figure 11). This was the method used in 1922 and 1923 and there were many transformers on the market so designed that they would handle wave lengths between 200 and 600 meters. There is one serious disadvantage to this type of transformer, however, as the transformer always has a certain peak frequency or wave length at which it functions best and the efficiency drops off considerably on each side of this peak point. Such transformers are usually used in a system comprising three Radio frequency amplifier tubes with these untuned transformers between the first and second and second and third tubes, and another one coupling the third Radio frequency stage to the detector. The grid circuit of the first tube is usually shunted by a loop tuned by a variable condenser.

Another method of coupling the tubes is by the use of fixed resistances, much as we do in audio frequency amplifiers.

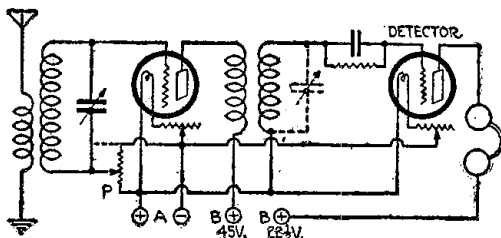

Figure 11

At first glance this seems to be the ideal method as resistance cannot distort and has no peak efficiency. It has been found after much experimentation that resistance coupling of Radio frequency amplifiers is not efficient on broadcast wave lengths and it should not be attempted.

A third method is known as the tuned impedance system and there are two excellent ways of applying this. The first

of these is shown in figure 12 and it will be noted that, while the grid and filament of the first tube are connected as usual across the secondary of the variocoupler, the plate circuit is tuned by a variometer. In grid circuits when we tune the circuit to the incoming frequency we secure maximum response and absorption of energy from the antenna circuit when our

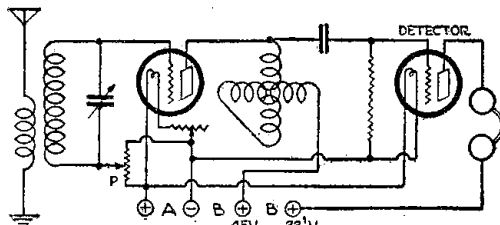

Figure 12

grid circuit is tuned exactly to the frequency of the incoming signal. In this case, however, when we tune the variometer and plate circuit exactly to the frequency of the signal going through, the circuit offers infinite impedance or opposition to the signals and, instead of going through the variometer, the energy prefers to go through the small fixed condenser to the grid of the following tube.

It should be noted in figure 12 that the grid leak is not connected across the grid condenser but is connected from the grid to negative filament and the small condenser is merely a blocking condenser to keep the plate voltage of the first tube from the grid of the detector. It should also be noted that the potentiometer P has been shunted across the A battery circuit and that the grid return of the first tube connects to the center tap of this potentiometer. When the plate circuit is tuned by the variometer to the frequency of the desired signal there is a tendency toward feedback through the tube and a form of uncontrolled regenera-

tion known as "oscillation." By varying the grid bias of the first tube with the potentiometer oscillation can be prevented and signals received without distortion. The use of the potentiometer, however, is to be discouraged as it broadens tuning and introduces losses into the circuit which materially cut the efficiency. The latest type of sets, with the exception of the super-heterodyne, do not use a potentiometer.

The second way of using tuned impedance R. F. amplification is shown in figure 13 and in this case a parallel circuit consisting of a coil and condenser have been substituted for the variometer. The coil and condenser must be in parallel so that the positive B circuit will be complete to the plate of the first tube. The circuit would not function if the coil and condenser were in series, as direct current cannot pass a condenser and the direct current from the B battery which keeps the plate 45-volts positive in relation to the filament could not reach the plate. Tuned impedance R. F. amplification is theoretically the most efficient system known but it is very un-

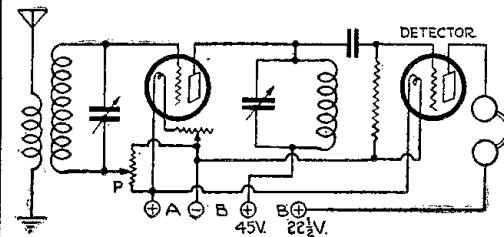

Figure 13

stable and hard to control and more than one stage is not recommended for the average broadcast listener.

The best system of all and that which is now in favor is known as tuned Radio frequency. Referring back to figure 11 it will be noted that a variable condenser (Continued on page 20)

The "Goode" Two-o-One

A

Le Ton d'argent

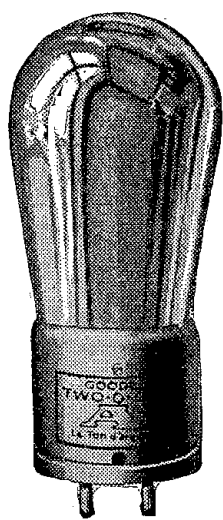

QUARTER AMPERE AMPLIFIER-DETECTOR RADIO TUBE

GUARANTEED SATISFACTORY

All "GOODE" Tubes Sold Direct to the Consumer—No Dealer Profits

- ONE—"Goode" Detector-Amplifier..... \$2.00
- THREE—"Goode" Detector-Amplifiers..... 5.50 (All postage prepaid)

The "Goode" Two-o-One A Tube amplifies or detects. It is a quarter ampere, five volts, standard base silvered tube. Send express or postal money order—New York draft—or personal check to—

The Goode Tube Corporation
Incorporated
Owensboro (Dept. A) Kentucky

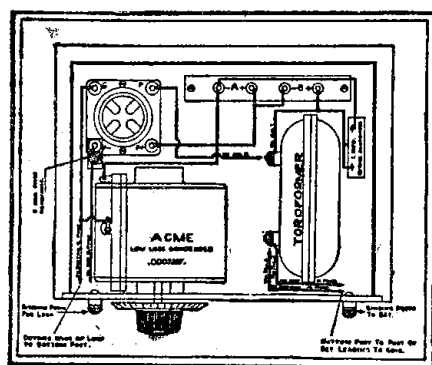

Increase the Efficiency of Your Reflex

by adding the Toroformer Attachment ahead of the Circuit.

The diagram above illustrates the Toroformer in use as a stage of tuned Radio frequency amplification.

- Attachment furnished complete on Panel for.....\$22.00
- Or in Kit form for.....\$18.00

A full size drawing of the separate Toroformer Attachment Unit is available for 25c postpaid.

The Toroformer

(A transformer for Tuned Radio Frequency Amplification)

Overcomes Local Interference Gives Greater Distance Increased Selectivity

Vastly improves any Reflex or Radio Frequency set, such as Acme, Murad, De Forest Reflex, Powr, Eria Loop Aerial Sets.

Does not pick up stray or unwanted signals, is unaffected by other parts of the circuit, and has no effect on other instruments.

Toroformer with printed diagrams and hook-ups.

Price \$5.00

At any First Class Radio Dealer or direct from us postpaid.

DEALERS wanted everywhere

THE SEARS MANUFACTURING CO.
1455 Leader-News Bldg., Cleveland, O.

Mail this coupon for free folder

Please send me your free folder on the TOROFORMER.

NAME.....
ADDRESS.....

ZENITH
KENNEDY
Radio-dyne
THERMODYNE
ULTRADYNE
MURDOCK
QZARKA
Pfanstiehl
MICHIGAN
Deresnadyne
MALONE LEMON
MASTER RADIO
ROYAL
Howard
Pathe
HARTMAN
AUDIOLA
EAGLE
GLOBE AND MANY OTHERS

34 fine set builders

THORDARSON
TRANSFORMERS
Super
Proof they're Best!

Chosen—after stiffest tests—by the majority of quality set builders. Not surprising, however, when you remember they're made and unconditionally guaranteed by the world's oldest and largest exclusive transformer manufacturer. Follow the lead of the leaders—build or replace with Thordarsons. Recommended by best dealers. Audio frequency: 2-1.5; 3 1/2-1.5; 6-1, \$4.50. Power Amplifying Transformer, \$8. Write for latest bulletins. THORDARSON ELECTRIC MFG. CO., CHICAGO

Hear What YOU Like

Stations are glad to put on numbers at your request. We print special postal "Thank You" cards that get ATTENTION. See the name CHESTER A. WHEELER on illustration. That is where YOUR OWN name will be. Your INDIVIDUAL cards show more than ordinary interest and stations appreciate them and consider your request.

Send NO Money

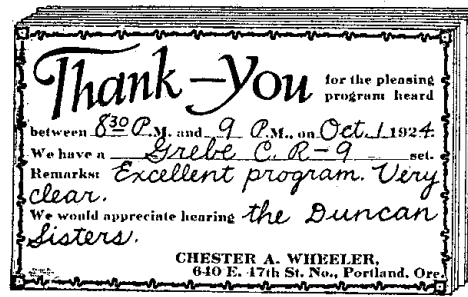

Applaud YOUR Favorites

Speakers and musicians deserve and appreciate applause for radio programs just the same as from the stage. Their entertainment makes your radio possible. Encourage them. Help bring the best talent to radio. Send YOUR "Thank You" card of appreciation. Let the children write Uncle Bob. It makes them happy. They cost so little. A joy to use.

FREE LOG

With 1st Order Contains stations, cities, wave lengths, 4 dial settings, remarks, etc. List by wave lengths of principal stations. Distance map. Other valuable information. Beautiful, durable rippled cover.

Save Time, Stationery, Telegrams and Postage

Cards have post card backs and require only 1c stamp. Can fill out in 1 minute. Less time and less postage than a letter. So convenient. A pleasure to use. ALL THE RAGE. Be up-to-date. Get this additional pleasure from your radio. Order Today.

Money Returned If Not DELIGHTED

Good quality cards. High grade printing. New attractive special radio design. The kind that gets results. 100 only \$1.35; 200—\$1.95; 300—\$2.45; 500—\$3.45; 1000—\$5.45 (about 1/2c each). Prepaid if you prefer to pay with order. Don't send one cent. Just pay postman after cards arrive. We GUARANTEE Satisfaction. Order Now.

Mail Coupon Today-NOW Or Send Postcard
RADIO PRINTERS, Dept. 9413 | MENDOTA, ILL.
Send..... applause cards with my name and address printed FREE. Enclose Log absolutely FREE. I will pay postman for cards. You are to return my money if I am not DELIGHTED. I am to be the sole judge.
Name (Print Clearly).....
Address.....
City..... State.....
Postage prepaid if you prefer to pay with order.

REFERENCE LIBRARY

(Continued from page 19)

has been shunted across the secondary of the coupling transformer in dotted lines and that potentiometer P can be eliminated by the use of the connection shown by dotted line. The untuned type of transformer makes use of iron in the core, either as thin sheets or wire, or as iron powder mixed with some compound to form a paste. The presence of iron in the field of the untuned transformer broadens the range it will cover efficiently although the efficiency at any point in that range is not as good as it would be if there were no iron and the transformer had only to work at a single peak efficiency.

Tuned Radio frequency makes use of single layer coils on tubes from 2 1/2 to 3 1/2 inches in diameter with no iron in the field and a variable condenser across the secondary of the transformer. By tuning the secondary the circuit can be adjusted to be in resonance and therefore at maximum efficiency for any wave length in the broadcast range. In the untuned type the primary has approximately as many turns as the secondary but in the tuned R. F. system the primary turns are cut down until the ratio is about one to eight or one to six. As the plate circuits are far from being in resonance with the grid circuits there is no tendency toward regeneration and oscillation because of feedback through the tubes.

The neutrodyne is similar to the system just described, the only difference being that one or two more turns can be put on the primaries and the tendency to oscillate at low wave lengths offset by the use of small condensers connected from grid to grid, these condensers having approximately the same capacity as the capacity effect within the tube.

(Amplification can be accomplished at audio frequencies as well as at the Radio frequencies, so next week Mr. Jones will take up tube operation for this purpose and show circuits used.—Editor's Note.)

CHART THE AERIAL

(Continued from page 15)

tion WDBR with a wave length of 256, and the loop tuning dial was at 7 1/2 while the oscillator dial was at 11. 256 was found on the bottom line and 7 1/2 and 11 were found on the vertical line, and crosses were marked on the chart where these points intersected. The loop dial was left at 7 1/2 and the oscillator dial was turned toward the lower end until this station was again picked up. It was found

again at point 5 and this cross was also put on the chart. Station WFBN with a wave length of 226 meters was the second station found and the crosses shown at B were put in.

The other six stations indicated by the crosses at C, D, E, F, G and H were tuned in and the intersection marks placed on the chart. The little crosses were then connected and the three curves shown resulted. To use this chart the owner proceeds in the following manner: presuming he wishes to find Station WBAP and knows the wave length to be 475.9, he first finds this number on the lower line and follows this point vertically to the point where it intersects the loop condenser curve which is 67 1/2 and the upper oscillator curve which is 74.

Eliminating Interference

He may find that his reception of WBAP is interfered with by some other station so he turns the oscillator dial to 62 which will be the other setting for

WBAP on the oscillator dial and is indicated by the fact that the vertical line crossed the lower heterodyne curve at that number. The station call letters can either be marked on the chart along the bottom line as shown in figure 1 or marked close to the curves as was done in figure 2. In order to follow this latter method, however, the chart will have to be very large and measure at least 20 inches wide, as there will not be room for all of the stations. The larger the chart the more accurately the points can be plotted but a small chart 10 inches wide will be found almost as useful.

Charts similar to these can also be made for reflex and regenerative receivers, but there will be only one curve as there is only the loop tuning condenser on a reflex and only the secondary condenser can be plotted on the regenerative set; the tickler dial cannot be plotted as its setting will vary with the condition of the B battery.

Bending Bus Wire

Bus wire can be easily bent with the aid of two ten-penny nails and a small piece of wood 1/2-inch thick. Drive the nails into the wood, leaving about 1/4-inch protruding. The nails should be placed close enough together to just allow a piece of bus wire to slip between them. To bend the wire at right angles or into a loop at the ends, simply insert the bus wire between the nails and bend it in the desired direction.

Takes the Mystery out of RADIO

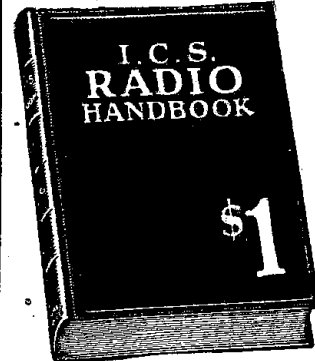

JUST OUT 514 PAGES

Compiled by **HARRY F. DART, E.E.**

Formerly with the Western Electric Co., and U. S. Army Instructor of Radio; Technically edited by F. H. Doane

NO MORE need you turn from book to book, hoping to find what you want. It is all here, in 514 pages crammed full of every possible radio detail. Written in plain language, by engineers for laymen. More than 100,000 sold.

IT EXPLAINS: Electrical terms and circuits, antennas, batteries, generators and motors, electron (vacuum) tubes, many receiving hook-ups, radio and audio frequency amplification, broadcast and commercial transmitters and receivers, super-regeneration, codes, etc.

Send \$1 to-day and get this 514-page I. C. S. Radio Handbook—the biggest value in radio to-day.

International Correspondence Schools
Box 8275-R, Scranton, Penna.

I enclose One Dollar. Please send me—post-paid—the 514-page I. C. S. Radio Handbook. It is understood that if I am not entirely satisfied I may return this book within five days and you will refund my money.

Name.....
Address.....
Check here and enclose \$1.50 if you wish the de luxe edition, bound in Leatheroid.



ATLAS MATCHED TUBES INSTRUMENT TESTED

Made in all standard types. Guaranteed to function efficiently in the most exacting circuits. Every Atlas Tube is individually instrument tested. Try them 30 days. Money refunded if you are not delighted.

At best dealers or direct from us. Our guarantee includes safe delivery. **\$3.00**

Special Offer

At no extra charge, we will furnish selected Atlas Instrument Tested Tubes in matched sets for Reflex, Neutrodyne, Radio Frequency, Superheterodyne or other sets. They will improve the performance of any set.

DEALERS: Atlas Matched Sets are in great demand. Write or wire for proposition

THE R-S-K CO.

311 Caxton Building CLEVELAND, O.
771 Elliott Square BUFFALO, N. Y.
609 Chamber of Commerce PITTSBURGH, PA.

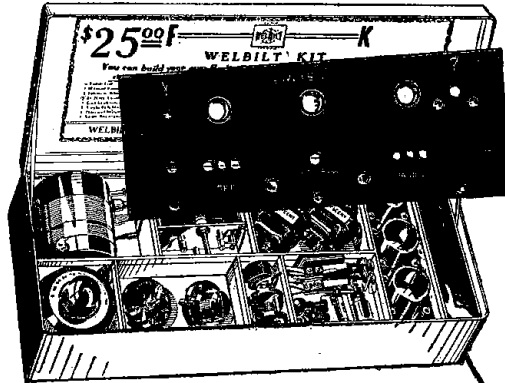

The Lowest-Priced High-Quality Kit

WEL-BILT TRIPLE KIT Has Only the Best Parts

Consisting of: Straight Line Low Loss Condenser

Check or Money Order

- High-Grade Transformers
- Litz Wire Tuner
- Bakelite Sockets
- Engraved and Drilled Panel
- Midget Condensers
- Rheostats, Dials, Jacks, etc.

\$25

Satisfaction or Money Refunded

WEL-BILT MFG. COMPANY
102 Chambers St., New York, N. Y.

CROSLEY I TUBE-50

\$14.50

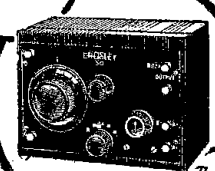

The Little Giant of Radio Coast to Coast Reception with phones frequently reported.

THIS Little Giant of Radio, the Crosley one tube 50, has everywhere astounded people with the distant stations that it brings in, on ear phones of course. All parts of the United States report European stations were heard with it during international test week. It is the radio with which Leonard Weeks of Minot, N. D., kept in constant touch with the Mac Millan expedition at the North Pole. All other makes of receivers failed. For true radio value, it is excelled only by the other larger Crosley Radios. Stations may be easily logged and always located at the same place. For the beginner in radio, the Crosley 50 is ideal. For sale by good dealers everywhere. Other models priced from the two tube 51, at \$18.50, to the Trirdyn Special with sloping panel, at \$65. All Crosley Radios are licensed under Armstrong Regenerative U. S. Patent 1,113,149. Prices quoted are without accessories.

Prices West of Rockies—Add 10%
Write for Complete Catalog

The Crosley Radio Corporation
Powel Crosley, Jr., President
3491 Sassafras St. Cincinnati, Ohio
Crosley owns and operates Broadcasting Station WLW

Lincoln Collapsible Loop Aerials
Standard of the Radio Industry

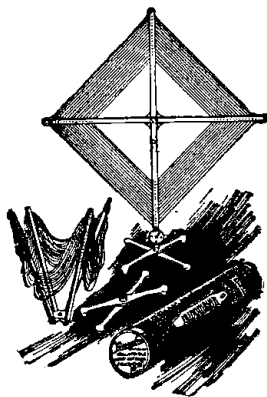

The only loops of their kind sold at popular prices.

Built by radio engineers—electrically and mechanically correct—beautifully finished and sturdy. A touch and a new station comes in—or one is cut out. Their selectivity is remarkable.

And remember that Lincoln Loops sell at moderate prices. No other loops of their kind or efficiency sell at these low prices.

Lincoln 4-point Tapped Loop \$8.00

Built for any circuit where it is desired to vary the inductance of the loop: Exceptionally fine for super-heterodynes.

Lincoln Center-Tapped Loop \$6.50

For any set employing radio frequency amplification. For certain Super-heterodynes requiring a center tap.

Write to Lincoln

If your dealer cannot supply you, order direct giving your dealer's name. Lincoln Loops are fully guaranteed. Send for literature. We welcome correspondence with legitimate dealers and jobbers.

Lincoln Radio Corporation
224 North Wells Street CHICAGO

FREE

The New Radio Book

How to understand radio, assemble circuits, operate sets, improve reception

A BIGGER, better, more complete book than has yet been brought out for the Radio set owner. Whether you built your own or bought it complete, there are pages and pages of material valuable to YOU. 28 pages on explanation of Radio, 18 pages of circuits, complete detailed constructional data on building six different sets, 14 pages on constructing parts, operating schedules of dozens of stations, a two-color map showing their locations, how to operate some of the popular complete sets now on the market.

There has never been another book like it, yet it is FREE with a year's subscription to Radio Digest. Readers say it is worth the subscription price of \$5.00. Have this volume of information at your elbow and receive Radio Digest every week—"First to Announce the Latest."

Circulation Department

Radio Digest

510 N. Dearborn Street

Chicago, Illinois

Adding Radio Frequency to Reflex Set

Receiver Attachment to Make it More Efficient

For those who are using the reflex set and to whom additional cost of a tube is of no consequence the hook-up shown in the illustration should be tried. By

WORKSHOP KINKS EARN A DOLLAR—

THERE are many little kinks worked out at home that would aid your fellow Radio worker if only he knew about them. There are new hook-ups, new ways of making parts and various unique ways of operating sets that are discovered every day. Radio Digest is very much interested in obtaining such material. Send them in with full details, including stamped envelope, so rejected copy may be returned. The work must be entirely original, not copied.

RADIO KINKS DEPARTMENT
Radio Digest,
510 North Dearborn St., Chicago

adding a tap switch to the variocoupler oscillation can be controlled in the tube on all wave lengths. The rotor of the variocoupler is set in position for best signals and then allowed to remain in that position.

With the addition of this extra tube to a three tube set the range will be increased and the set will be more selective. —E. F. Ziemer, Minneapolis, Minn.

Homemade Midget Condenser

A panel mounted midget vernier condenser can be easily made as shown in the illustration. The mounting is similar to any instrument. A threaded bushing is

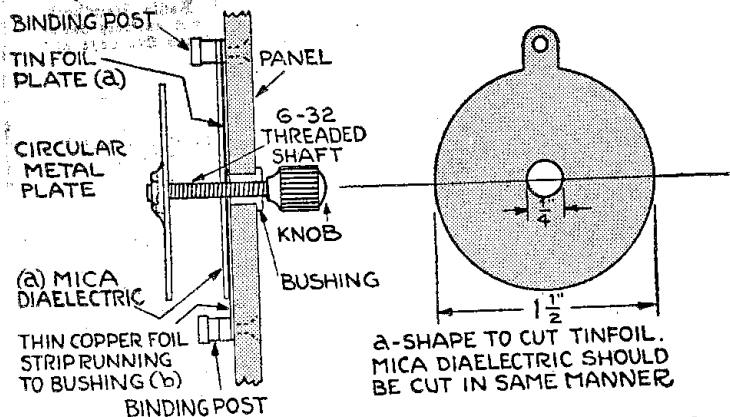

used for the shaft. On the inside of the panel and around the bushing hole is a sheet of tinfoil glued to the panel surface. The foil should be cut away from the bushing so that there is no electrical connection. A mica sheet is glued to the

AIDS TUNING, HELPS DISTANCE

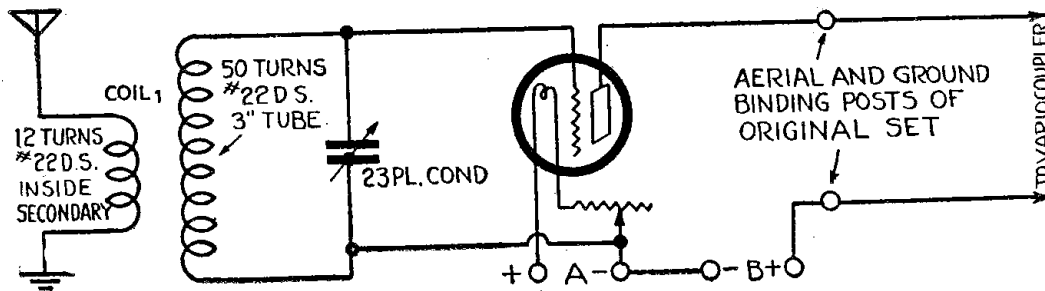

inner surface of the tinfoil. A circular metal plate, copper or aluminum, is attached to the inner end of the threaded shaft. Two binding posts make the connection to the circuit. —M. Daugard, Syracuse, N. Y.

Transformer Ratios

If transformers of different ratios are to be used, the high ratio instrument should be placed in the first stage and the low in the second.

Condenser Sharp Tuning

It is the belief of some that a 43-plate variable condenser tunes sharper than a 23-plate or smaller. This is not true, but is due to these fans having substituted a larger condenser for a smaller one and having found it difficult to set the dial accurately enough to properly tune the set. In the case of the 43-plate condenser a movement of the dial moves all of the plates, let us say, one degree. It will be seen that a change in capacity takes place that is almost twice as great as when the 11 plates of a 23-plate condenser are moved one degree. Reversing the comparison, an 11-plate condenser can be

tuned four degrees for the same variation in capacity as obtained with a movement of one degree on the 43-plate. Thus, it is much easier to tune an 11-plate than a 43-plate, but the range in wave length will not be so great.

Wiring the Charger

Care should be taken to see that the polarity of the wires from a charger are connected properly to the battery. In this case the negative wire goes to the negative side of the battery, and not the usual positive to negative connection. For direct current, place the two wires from the charger in a glass of water so that they do not touch each other. The wire which bubbles is the negative.

Index Points for Dials

File the head of an escutcheon nail so that it forms a point as shown and drive

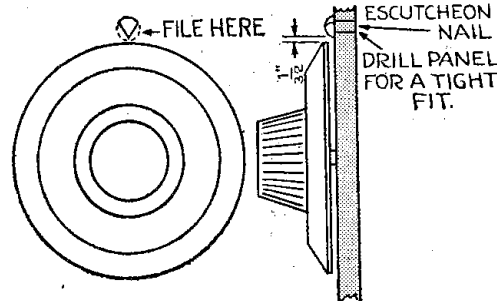

it through a hole drilled in the panel directly above the dial. This forms a pointer that can be readily seen. —Edward Cook, N. Troy, N. Y.

Homemade Battery for Lighting Peanut Tubes

Illustrated herewith is a battery that should be of real value to the owner of peanut tubes. It is not only simple to construct but it will give real service when used right. The elements are aluminum and copper, the container is an ordinary fruit jar and the solution is a

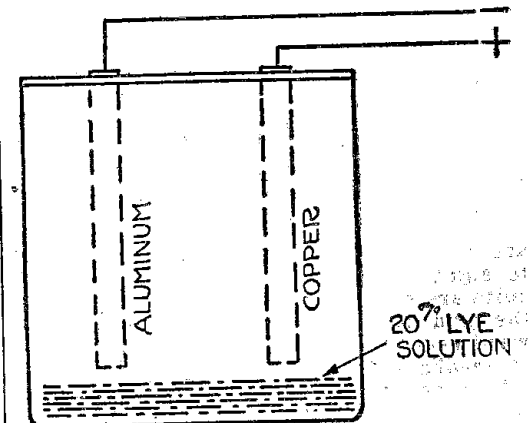

20 per cent mixture of water and ordinary lye.

Both the copper and aluminum plates should be cut 2 inches wide and 4 inches long. These are fastened to a wood support which rests on the top of the jar.

When the battery is not in use the plates should be removed from the solution as the lye will slowly decompose the aluminum. Only one battery is used on a tube. —Chas. Bloedorn, Jr., Franklin, Nebr.

Foliage Absorbs Radio Energy

Radiophans who have erected aerials during the winter had best make sure that if there are trees in the vicinity, no part of the aerial is less than 6 feet from the nearest green leaves. Foliage "soaks up" Radio energy like a sponge.

Complete Low Loss Receiver Kit \$48⁵⁰

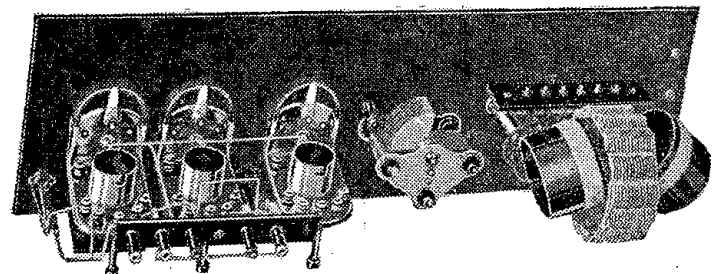

Including Cabinet and Wired Tube Units

Panel is drilled, tube units are wired. All you need do is connect tuner, condenser and tubes. Low loss parts give greater selectivity and range than has heretofore been possible in a set of this type. New York Lab. low loss tuner, Heath "Radiant" low loss condenser, Superadio detector and audio amplifier units, Jones color cap connectors — everything of highest quality.

Since you do the assembling and wiring, the result is a three tube set which is the equal in appearance and results to completely finished manufactured outfits costing more than twice as much. Goes through locals better than most five tube sets—volume is exceptional—tone quality satisfies the most discriminating.

All Parts Fully Guaranteed

MAIL ORDERS ONLY

WRITE FOR CATALOGUE

American Radio Sales Company, Not Inc.
3982 BARRY AVENUE
CHICAGO, ILLINOIS

FREE Bulletin

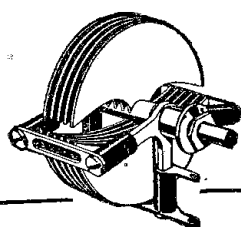

"Good Condenser Design"

What makes a good condenser? Send for this free folder and post yourself on today's requirements. This article is full of meat. It makes plain all the electrical as well as the mechanical qualities of a good condenser.

If you are planning to build a receiving set or to bring your present one up to date, go to your dealer and ask to see the new

Premier "CROFOOT" Variable Condenser

"CROFOOT" has all the necessary electrical and mechanical features. It is a real low loss instrument. It has the lowest minimum capacity yet attained—.000005 M. F. and the greatest tuning ratio—1 to 74. Made entirely of brass and hard rubber giving remarkably low skin resistance and low insulation leakage. Semi-straight line plate construction. All plates soldered; a feature identified by the "red stripe." A sturdy, smooth acting, compact and graceful instrument. Mounts with one hole. Ratios 1 to 19, 1 to 42, 1 to 53 and 1 to 74. Price from \$2.75 to \$3.75. Complete with Etzoon vernier dial, 75 cents additional.

FREE Hook-Up Diagrams

Ask your dealer for a complete set of Premier diagrams covering all types of hook-ups. If he cannot supply them send his name and receive a set with bulletin.

Premier Electric Company
3810 Ravenswood Ave. CHICAGO

PREMIER
Quality Radio Parts

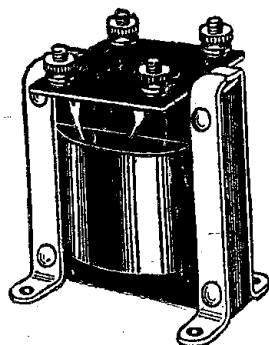

DONGAN

Audio Transformers

Choice of

35 Set Manufacturers

RECEIVER performance reaches its ultimate through Dongan Audio Transformers, designed and built in the big Dongan plant devoted exclusively to the manufacture of electrical devices for 15 years. Set manufacturers find Dongan the most practical of all Audio Transformers for their purpose.

Fits all Hook-ups
Ratio 3½ to 1, 6 to 1

Ask our engineering department for facts. Individual Set builders see your dealer or write us direct for information.

Dongan Electric Manufacturing Co.
2979 Franklin St. Detroit, Mich.
Transformers of Merit for 15 years

Index your radio

720 BROADCASTING STATIONS of NORTH AMERICA listed in order of wave lengths. Just entering your dial numbers calibrates your set and gives you dial positions for any station. Instant reference five ways. Identifies those annoying stations whose call letters are indistinct.

MARCH 1ST
ISSUE
NOW READY

**RADIO
INDEX**

POSTPAID
50 CENTS
STAMPS TAKEN

DEALERS: 3 Dozen in Self-Sale Carton, \$11.40 F. O. B. Cleveland
THE RADEX PRESS
217 EUCLID ARCADE ANNEX CLEVELAND, OHIO

Questions and Answers

B Battery Eliminator

(11709) ROR, Johnstown, Pa.
I made a battery charger from your plans by Jacques Fournier and it is a good charger. That is why I am writing to you thanking you for the plan that I have been wanting for some time. I have one more article I wish you would put in Radio Digest so that an amateur could build for himself. That is a transformer to take the place of the B battery to operate on a 60 cycle alternating current of 105 to 120 volts. Please advise me if you can do this?

A.—We are very glad to note from your letter of January 6 that the charger which you built is working satisfactorily. We intend to run an article on a B battery eliminator just as soon as we can get in touch with someone who has developed such a device to the point where it is practical. It is perfectly feasible to design such a unit for a particular set and to adjust that unit so that it will function with that receiver without hum or trouble. At this time it would be impossible to outline a B eliminator which could be used with any type of set under any conditions with assurance of success.

Honeycomb Coil Circuit

(11164) JAG, Piqua, Ohio.
Will you furnish me with a diagram of a one stage Radio frequency and detector circuit using three honeycomb coils, regenerative hook-up with shunted con-

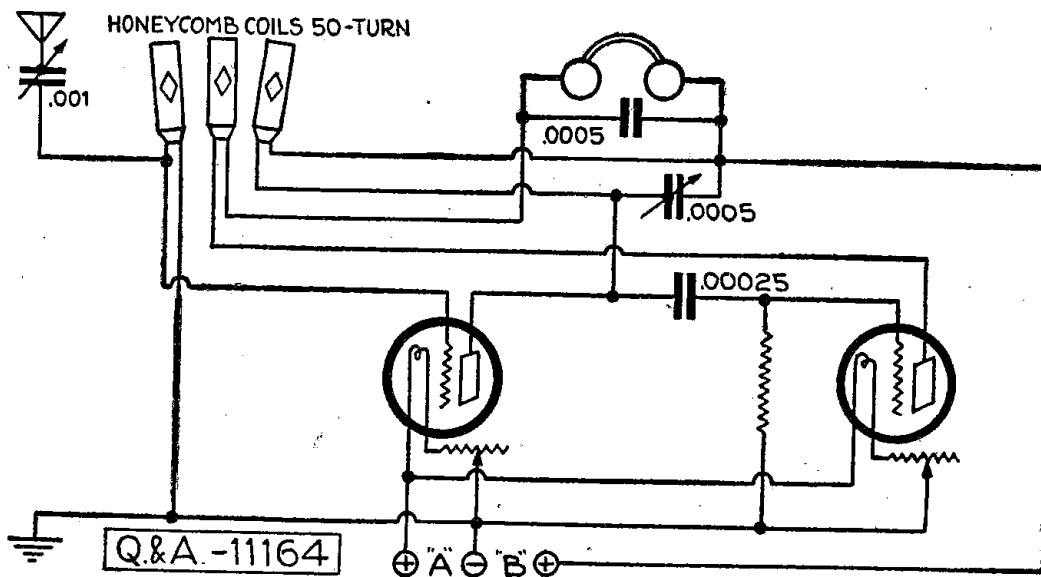

densers, primary and secondary, using 1714 Radio frequency transformers?

A.—Herewith we present a diagram such as you desire. This circuit is a combination of tuned Radio frequency coupling and a regenerator or feedback effect. Actually there are only two condenser controls and the adjustment of the honeycomb coil coupling on the set.

PATENTS

Write for my free Guide Books "How to Obtain a Patent" and "Invention and Industry" and "Record of Invention" blank before disclosing inventions. Send model or sketch of your invention for instructions. Promptness assured. No charge for above information. Clarence A. O'Brien, Registered Patent Lawyer, 2008 Security Bank Building, directly across street from Patent Office, Washington, D. C.

Men to build radio sets in spare time.
Leon Lambert, 501-H Kaufman Bldg., Wichita, Kansas.

Roosevelt Musical Association. Music for all occasions. Fitzroy Brown, 158 Lefferts Place, Brooklyn, N. Y.

Cabinets—5,000 cabinets, 7 x 18 x 7, \$1.50 each. Enclose 20c postage with order. Haft & Co., 1364 Sterling Pl., Bklyn, N. Y.

Radio Reception Stamp Album and Log. 240 stamp size, fancy brochure cover. 50c each. Henry Jorgensen, Minden, Nebr.

Raulf Radio Consoles. The ideal radio cabinet, built in genuine mahogany or walnut. Send for descriptive circular. Raulf Manufacturing Company, 564 Vedder St., Chicago, Ill.

Write for Our Free Book on Patents—Munn & Co., 643 Woolworth Building, New York City; 518 Scientific American Bldg., Washington, D. C.; 407 Tower Bldg., Chicago, Ill.; 360 Hobart Bldg., San Francisco, Calif.; 215 Van Nuys Bldg., Los Angeles, Calif.

It's your money and you can spend it for tubes or batteries if you want to; but I can show you how to bring distant stations in on a simple crystal set. Same plans increase range of tube sets also. Copyrighted plans \$1.00. Complete parts for long distant crystal sets \$5.00. Leon Lambert, 501 Kaufman Bldg., Wichita, Kansas.

\$10.00 IS ENOUGH
You can get programs 400 to 1,000 miles away on Lambert Crystal Sets, and you don't need tubes or batteries. Tell your dealer "nothing else will do" Picture of Set and Particulars Free.
LEON LAMBERT
501 Kaufman Bldg. Wichita, Kan.

100 RADIO CARDS

Thank the broadcasters with attractive Radio Appreciation Cards. Printed in two colors on high grade white Post Card. \$1.00 brings 100 cards postpaid. Order today
\$1.00
Post Paid
Radio Card Co., 220 Franklin Buffalo, N. Y., Dept. D

PATENTS SECURED
Radio Inventions a Specialty
Trade Marks Registered
WRITE US
Mason, Fenwick & Lawrence
Patent and Trade Mark Lawyers
Washington, D. C. New York Chicago
ESTABLISHED OVER 60 YEARS

The Traffic Cop of the Air
Add a Ferbend Wave Trap to your Radio Set and "Police" your reception. Regulate traffic. Guaranteed to tune out any interfering station. Widely imitated but never equalled. The original and only successful WAVE TRAP. Now in its third year. Sent Postpaid upon receipt of \$3.50 or C. O. D. plus postage. Send for Free Booklet
FERBEND ELECTRIC CO.
17 E. 50. Water St. Chicago

Tuned Radio Frequency

(11712) FTG, Vimta, Okla.
Is there any difference between two stages of tuned Radio frequency and a neutrodyne?

Which is the best for DX, an ultradyne or a super-het?

New 64 Page LOG

Send NO Money
Holds 400 Stations
Beautiful GENUINE leather cover. Gives call, city, wave lengths, etc. Spaces for 4 dial settings, remarks, etc. List by wave lengths of principal stations. List of stations alphabetical by states and cities. Valuable tuning suggestions. List of station owners. Distance map. So convenient. Trouble aids. Other valuable information. Worth many times small cost. With beautiful ripped cover \$1.00; genuine De Luxe leather cover, only \$1.35. Order NOW; MONEY REFUNDED if Not Delighted
Don't send a cent. Pay postman after log arrives. If pay with order we pay postage. You will enjoy this log. Just what you need. Order today—NOW. Postal will do.
RADIO PRINTERS, Dept. 4413 MENDOTA, ILL.

MUTER
FIXED CONDENSERS
used by
Leading Set Builders

FREE The very latest up-to-date radio wall map 28 by 34 inches. Shows call letters, locations, wave lengths, and kilocycles of all radio broadcasting stations, U. S., Canada, and Mexico, relay divisions and radio districts. Also a scale for measuring distance. This wonderful map postage paid, ABSOLUTELY FREE. Merely send us a list of stores in your city which handle radio apparatus. Be sure and give the street address, and if you know the manager's name, give it also. DO IT TODAY before this offer is withdrawn.
OZARKA, Inc. 808 Washington Blvd., Chicago, Ill.

TONE--Like a Violin
from the All-Wood Speaker
This Madera Clearspeaker has the amazing qualities of the larger models. Its Compressed Wood horn and tone chamber respond to a wider band of sound frequencies than horns of metal or any other composition, and, hence, give the perfect, natural reproduction of voice or music.
No. 804—Height 12" Diameter of bell, 10". Complete with Unit. \$15
Crystal Black..... \$15
The ideal speaker for those who wish to make only a moderate investment. At your dealer's, who will gladly demonstrate.
COMPRESSED WOOD CORPORATION
Formerly American Art Mache Company, 347 W. Austin Ave., Chicago

Low-Loss
"Supercoids"
Fully Adjustable
For All Circuits
At All Dealers or Direct
\$7.00 plus P.F.
Panel Mounted
The coil above is a three circuit tuner—but there are Supercoids for all other circuits, including Neutrodyne, Robert's Reflex, Superdyne and Harkness. Write for price and particulars. Send 3-2¢ stamps for Low-Loss Bulletin and Easy to Read Hook-Ups.
Perfection Radio Mfg. Co.
Office: 317-1520 Chestnut Street Philadelphia, Pa.

Look for the name
WD-11 Radiotron

It isn't a genuine WD-11 unless it's a Radiotron
WD-11 Radiotron

The Crystalstat
PRICE \$2.50
The Ideal Reflex Detector but equally suitable for crystal sets
The Crystalstat embodies the following features:
A super-sensitive crystal in an air tight enclosure. A brush cut whisker of gold tinsel strands. A micrometer adjustment by means of which the most delicate adjustment may be had. The multiple contacts of fine gold filaments prevent howling and give light but sure contact. The crystal is our wonderful Star-It, the pick of the Earth's best crystal.
The Crystalstat attaches through one 5/16" hole in the panel so that only the control knob shows on the face of the panel.
Packed in one dozen lots for dealers
Ask your dealer to supply you or you may send for one C. O. D. with your money back if not completely satisfied.
DEALERS and JOBBERS please get our catalog of crystals and detectors and our liberal distributing proposition.
Star Crystal Co
1498 525 Woodward Avenue
DETROIT - MICHIGAN

Is the quality of reception as good from a super-het as from a neutrodyne?
A.—The difference between the neutrodyne and a tuned Radio frequency receiver is that in a neutrodyne two small condensers are used called neutrodons so connected that they will offset the inherent capacity of a vacuum tube and prevent oscillation. The tuned Radio frequency set is prevented from oscillating by reducing the number of turns in the primaries of the air core transformers between the Radio frequency stages.
Ultradyne and super-heterodyne are equal as regards range, but our readers have found that the ultradyne is not as selective as a well made super-heterodyne.

Mailing Lists
Will help you increase sales
Send for FREE catalog giving counts and prices on thousands of classified names of your best prospective customers—National, State and Local—Individuals, Professions, Business Concerns.
99% by refund of 5¢ each
315 N. 10th St. Minneapolis

MIRACO RADIO
GETS 'EM COAST TO COAST
only \$14.35
FOR THIS GUARANTEED LONG DISTANCE RADIO
Users everywhere report Miraco Tuned Radio Frequency receivers pick up programs coast to coast; outperform sets three times as costly. Send for proof they are radio's most amazing values in powerful long distance sets. One tube guaranteed, completely assembled outfit, as illustrated, list \$14.35. 100% guaranteed loud speaker outfit, list \$29.50.
SEND POSTAL TODAY for latest bulletins and special offer. It will interest you.
MIDWEST RADIO CORP'N
Pioneer Builders of Sets
437-U, E. 8th St., Cincinnati, O.

NOW \$3.50
Direct from factory to you
THE RABAT SENIOR
1200 MHZ. CAPACITY
FOR A LIMITED TIME ONLY
You can purchase for \$3.50 a 12 cell 24 volt RABAT SENIOR battery. Saving \$6.10 through direct buying. The Jobber and Dealers profit now is yours. 24 cell 48 volt size \$7.00.
Rabat Senior Batteries
are neat, powerful, noiseless and will harmonize with any Rabat Set. Separate cells and patented rubber cork prevent current leakage and clear glass tubes give vision of the condition of battery. Heavy duty plates 3-16 x 1 x 2 1/2" with staggered ribbed grid form the backbone of this sturdy battery. Shipped completely charged ready for instant use. And you can save \$6.10 by ordering direct.
RABAT JUNIOR BATTERY \$2.15 c. o. d.
(12 CELLS 24 VOLTS 1200 M.H.Z. CAPACITY)
Incomparable in price and performance. Designed to satisfactorily operate sets equipped with 3 tubes or less. Constructed of the same high grade materials as used in our Senior battery. Shipped dry, uncharged. Order today and save \$1.81.
Rabat batteries can be recharged at home at a very low cost.
Rabat Super-Charger \$3.00 c. o. d.
Is specially designed to satisfactorily recharge any make of storage "B" battery. Shipped complete ready to use including lamp socket, attachment plug and cord. You save \$1.80 by ordering direct.
SEND NO MONEY
But write us today, advising quantity and type wanted. After examining and approving these wonderful batteries then pay the Expressman the small C.O.D. charges.
The Rabat guarantee is back of all our products. DON'T WAIT ORDER TODAY and save the middleman's profit.
THE RADIO RABAT COMPANY
1767 St. Clair Avenue, Cleveland, Ohio

Radiophone Broadcasting Stations

Corrected Every Week—Part I

United States

AQ6, Canton, O. 425 meters. Hdqts. 135th Field Artillery O. N. G.

AT9, Fort Bragg, N. C. 435 meters. 750 watts. U. S. Government. Announcer, Lieut. James Y. LeGette. Slogan, "The Pioneer Broadcasting Station of the Field Artillery." Tues, Thurs, Sat, 8-9:55 pm, dance music, talks, bands, fights. Sun, 8-9 pm, service. Eastern.

AV7, St. Paul, Minn. 406 meters. 6th Inf. Minn. Nat'l Guard, St. Paul Armory. Irregular schedule. Central.

AW5, Dayton, O. McCook Field, U. S. Army. Experimental work only.

KDKA, E. Pittsburgh, Pa. 309.1 meters. 1,000 watts. Westinghouse Elec. & Mfg. Co. Announcer, H. W. Arlin. Slogan, "The Pioneer Broadcasting Station of the World." Daily ex Sun, 9:45-10 am, 11:55, time; 12-1 pm, market reports, music; 6:15, music; 7:15-10, markets, news, features; concert; 9:55-10, time. Mon, Wed, Fri, 7 am, 8, exercises. Tues, Thurs, 11-12:30 am, late concert. Sun, 10:45 am, church services; 2:30 pm, concert; 4, organ; 4:45-6:15, dinner concert; 7:30, church service. Eastern.

KDLR, Devils Lake, N. Dak. 231 meters. 5 watts. Radio Elec. Co.

KDPM, Cleveland, O. 250-1817 meters. 750 watts. Westinghouse Elec. & Mfg. Co. Announcer, H. W. Irving. Experimental station.

KDPT, San Diego, Calif. 244 meters. 50 watts. Southern Elec. Co. Announcer, William O. Heathcote. Slogan, "At the End of the Trail." Daily ex Sun, 1:30-2:30 pm. Tues, 8-9 pm. Thurs, Fri, Sat, 6:00-6:45 pm. Wed, 8:00-10:00 pm. Pacific.

KDYL, Salt Lake City, Utah. 305.9 meters. 50 watts. Newhouse Hotel, Announcer, Geney Rack. Slogan, "Better Radio." Daily ex Sun, 3-4 pm, 6:30-8, news, music, entertainment. Sun, 11-1 am. Mountain.

KDYM, San Diego, Calif. 289 meters. 100 watts. Savoy Theater.

KDZB, Bakersfield, Calif. 240 meters. 100 watts. Frank Sievert. Daily ex Sun, 8-9 pm, reports, music. Pacific.

KDZE, Seattle, Wash. 270 meters. 100 watts. Rhodes Dept. Store.

KFAB, Lincoln, Neb. 240 meters. 200 watts. Nebraska Buick Auto Co. Announcer, Gayle Grubb. Mon, Wed, Fri, 7:30-9:30 pm. Sun, 4 pm, church services. Central.

KFAD, Phoenix, Ariz. 272.6 meters. 100 watts. McArthur Brothers Mercantile Co. Announcer, Arthur C. Anderson. Slogan, "Where Summer Winters." Daily ex Sun, 7:30-8:30 pm, news, weather, stock reports, music. Mountain.

KFAE, Pullman, Wash. 333.1 meters. 500 watts. State College of Washington. Announcer, George Bayles. Slogan, "Your Service Station." Wed, Fri, Mon, 7:30 pm, talks, music. Pacific.

KFAF, Denver, Colo. 278 meters. 500 watts. Western Radio Corp.

KFAJ, Boulder, Colo. 261 meters. 100 watts. Univ. of Colo. Announcer, F. M. Orsborn. Tues, Thurs, Sat, 9 pm, time, music, addresses by faculty. Sat, 2:30-5 pm, sports. Mountain.

KFAN, Moscow, Idaho. 230 meters. 50 watts. University of Idaho.

KFAU, Boise, Ida. 275 meters. 500 watts. Boise H. S. Announcer, David Taylor. Slogan, "Intermountain Station." Daily ex Sat, Sun, 3:30-4:15 pm, markets, weather, news. Mon, Fri, 8-9 pm, concert. Mountain.

KFAW, Santa Anna, Calif. 214.2 meters. 50 watts. Radio Den. Slogan, "Where There is Always a Friend from Your Old Home Town." Daily ex Sun, 4:30-5 pm, news, reports, music. Mon, Thurs, concert. Pacific.

KFBH, Havre, Mont. 275 meters. 50 watts. F. A. Buttery Co. Announcer, C. O. Boettger. Daily ex Sun, 12:45 pm, markets, weather, reports. Mountain.

KFCB, San Diego, Calif. 278 meters. 15 watts. W. K. Azbill. Thurs, Sun, 8-9 pm, Bible lesson, sermon. Pacific.

KFBG, Tacoma, Wash. 250 meters. 50 watts. First Presbyterian Church. Announcer, Frank Tovey. Sun, 11-12 pm, 7:30-9 pm. Pacific.

KFBK, Sacramento, Calif. 283 meters. 100 watts. Kimball-Union Co.

KFBL, Everett, Wash. 224 meters. 15 watts. Lesse Bros. Announcer, R. H. Lesse.

KFBU, Laramie, Wyo. 270 meters. 50 watts. The Cathedral. Wed, 5-6 pm, chimes. Sun, 5 pm, 7:30, church services. Mountain.

KFCB, Phoenix, Ariz. 238 meters. 10 watts. Nielson Radio Supply Co. Announcer, E. A. Nielsen. Slogan, "When It's Wintertime in Michigan, It's Summer Time Down Here." Daily. 7-7:30 pm, bedtime stories. Mountain.

KFCC, Helena, Mont. 247.8 meters. 10 watts. The First Congregational Church. Announcer, George C. Stocking. Sun, 11-12:15 pm, church service; 6:30, bedtime story; 7:30-9, service. Mountain.

KFCF, Walla Walla, Wash. 256 meters. 100 watts. Frank A. Moore. Slogan, "The Valley They Liked So Well They Named It Twice." Leslie E. Rice.

KFCL, Los Angeles, Calif. 236 meters. 500 watts. Leslie E. Rice.

KFCP, Ogden, Utah. 360 meters. 10 watts. Ralph W. Flygare.

KFCV, Le Mars, Ia. 252 meters. 50 watts. Western Union College.

KFCZ, Omaha, Neb. 258 meters. 50 watts. Central H. S. Announcer, Arnold Clesler. Daily ex Sat, 3-5 pm, orchestra, organ. Mon, Tues, Thurs, 7:30-9 pm, Sat, midnight program. Central.

KFDD, Boise, Idaho. 275 meters. 10 watts. St. Michael's Episcopal Cathedral. Announcer, Paul Roberts. Sun, 11:15-12:30 pm, 7:30-9:15. Mountain.

KFDH, Tucson, Ariz. 258 meters. 50 watts. Univ. of Ariz. Announcer, Max Voss Kuehler. Irregular schedule.

KFDJ, Corvallis, Ore. 254 meters. 50 watts. Oregon Agri. College. Announcer, Jacob Jordan. Mon, Wed, Fri, 7 pm, college news.

KFDL, Denver, Colo. 226 meters. 5 watts. Knight-Campbell Music Co.

KFDM, Beaumont, Tex. 315.6 meters. 500 watts. Magnolia Petroleum Co. Announcer, Magdolene. Tues, Slogan, "Call for Dependable Magnolene." Every other Sun, 9 pm. Central.

KFDN, Birmingham, Ala. 250 meters. 100 watts. First Baptist Church. Announcer, Dr. M. E. Dodd. Wed, 9-10 pm, music, talks. Sun, 11 am, 7:45 pm. Central.

KFDY, Brookings, S. D. 273 meters. 100 watts. S. D. State College. Announcer, G. A. Rietz. Daily ex Sun, 12:15 pm, livestock markets. Tues, 11 am, 8-9 pm, Thurs, 10-12 pm. Fri, 8-9 pm. Sun, 9-10 am. Mountain.

KFEQ, Oak, Neb. 268 meters. 100 watts. J. L. Scroggin. Announcer, Clarence Koch. Fri, 9-10 pm. Central.

KFER, Fort Dodge, Ia. 231 meters. 10 watts. Auto Electric Service Co. Announcer, H. E. Gillner. Boice. Slogan, "The Gospel Messenger of the Air." Sun, 9:45 am, 11, 7:30 pm. Central.

KFR, Sparks, Nev. 226 meters. 10 watts. Nevada State Journal.

KFFV, Lamoni, Ia. 250 meters. 100 watts. Grace-land College. Announcer, R. A. Cherille. Mon, 7:30 pm, musicale. Thursday, 7:30-8:30 pm, educational program. Sun, 11 am 2nd 3rd, 4th Sundays; 7:45 pm, 1st Sun, each month.

KFFY, Alexandria, La. 275 meters. 50 watts. Louisiana College. Mon, Thurs, 7-8:30 pm. Central.

KFGC, Baton Rouge, La. 268 meters. 100 watts. Louisiana State University. Thursday, 8-9 pm. Central.

KFGD, Chickasha, Okla. 252 meters. 100 watts. Okla. College for Women. Announcer, J. A. Teeters. Tues, Thurs, Sat, 8 pm, music, lectures. Wed, 10 am, chapel service; 11 pm, special jazz program. Central.

KFGH, Stanford Univ., Calif. 273 meters. 500 watts. Leland Stanford Junior University. No regular schedule.

KFGQ, Boone, Ia. 226 meters. 10 watts. Cray Hardware Co. Announcer, Harold E. Wilcox. Slogan, "Daniel Boone Station." Wed, 8-9 pm. Sun, 3-4 pm. Central.

KFGX, Orange, Tex. 250 meters. 500 watts. First Presbyterian Church. Announcer, C. A. Doane. Sun, 11 am, 7:30 pm, church services. Central.

KFHA, Gunnison, Colo. 252 meters. 50 watts. Western State College of Colorado. Announcer, E. Russell Wightman. "Where the Sun Shines Every Day." Tues, Fri, 6:30 pm, bedtime story; 8 pm, musicale; 10:30, orchestra. Mountain.

KFHJ, Santa Barbara, Calif. 360 meters. 100 watts. Fallon & Co.

KFHL, Oskaloosa, Iowa. 240 meters. 10 watts. Penn College.

KFHR, Seattle, Wash. 263 meters. 100 watts. Star Elec. & Radio Co. Announcer, R. Matmueller. Slogan, "The Voice of the Charmed Land." Daily ex Sun, 4:30-5:30 pm. Mon, Wed, Fri, 6:30-7:30 pm. Tues, Thurs, Sat, 7:30-10:30 pm. Sun, 1-3 pm; 4:30-7:15. Pacific.

KFI, Los Angeles, Calif. 467 meters. 1,500 watts. Earle C. Anthony, Inc. Announcer, Paul W. Reese. Slogan, "The Radio Central Super-Station." Daily ex Sun, 5-6 pm, 6:45-8 pm, 8-11 pm. Daily ex Sun, 10-10:45 am, 4-5 pm, 6:45-8, 8-11, 11-12 pm, first Sun of month, 11-12:30 pm, third Sun of month.

KFIF, Portland, Ore. 248 meters. 100 watts. Benson Tech. School.

KFIO, Spokane, Wash. 266 meters. 100 watts. Radio Club of North Central H. S.

KFIQ, Yakima, Wash. 256.3 meters. 100 watts. First Methodist Church. Announcer, Dr. I. M. Miller. Wed, 7:30 pm, organ. Sat, 7 pm. Sun, 11 am, 7:30 pm. Pacific.

KFIU, Juneau, Alaska. 226 meters. 10 watts. Alaska Elec. Light & Power Co. Announcer, O. E. Shoem-belt. Mon, Wed, Fri, 7-8 pm. Alaskan.

KFIZ, Fond du Lac, Wis. 273 meters. 100 watts. Daily Commonwealth and Seyfert Radio Corp. An-

"The Sunshine Center of America." Sat, 8 pm, music. Mountain.

KFLU, San Benito, Texas. 236 meters. 15 watts. San Benito Radio Club. Announcer, R. W. Thacker. Slogan, "Heart of the Magic Valley." Mon, Thurs, Sat, 8:30-10 pm, concert. Sat, 8:30 pm, Sunday school lesson. Central.

KFLV, Rockford, Ill. 229 meters. 100 watts. Swedish Evangelical Mission Church. Announcer, A. T. Frykman. Fri, 8:30 pm. Sun, 12:30 pm, service for shut-ins (Swedish); 9:30, service (English). Central.

KFLX, Galveston, Texas. 240 meters. 10 watts. George R. Clough.

KFLZ, Atlantic, Iowa. 273 meters. 100 watts. Atlantic Automobile Co. Slogan, "The Garden Spot of Iowa." Wed, 6-7:15 pm, dinner program; 9-11, music. Sat, 9-11:30 pm, dance music. Sun, 4 pm, church service. Central.

KFMB, Little Rock, Ark. 254 meters. Christian churches of Little Rock.

KFMQ, Fayetteville, Ark. 299.8 meters. 500 watts. U. of Arkansas. Announcer, C. V. Bullen. Tues, 9 pm. Thurs, 7:30 pm. Central.

KFMR, Sioux City, Ia. 261 meters. 10 watts. Morris College. Announcer, Jesse C. Ducommun. Tues, Thurs, Fri, Sat, 8:55 am. Tues, Thurs, Sat, 12 m. Central.

KFMT, Minneapolis, Minn. 263 meters. 100 watts. Dr. George W. Young. Announcer, Dr. George W. Young. Slogan, "Always Young." Mon, 7 pm; Wed, Thurs, 8-9 pm; Fri, 10-11 pm. Sun, 12:30-3:30 pm. Central.

KFMW, Houghton, Mich. 266 meters. 50 watts. M. G. Sateren (announcer). Sun, 3-4:30 pm. Central.

KFMX, Northfield, Minn. 356.9 meters. 750 watts. Carleton College. Announcer, Merrill O. Bolen. Wed, 9 pm. Sun, 7 pm. Central.

KFNF, Shenandoah, Ia. 266 meters. 500 watts. Henry Field Seed Co. Announcer, Henry Field. Slogan, "Friendly Station in a Friendly Town." Daily ex Sun, 12:25-1:25 pm. Daily ex Sun, Tues, 6:30-9:30 pm, concert. Sun, 10:45 am, 3 pm, services; 6:30-8, Golden Rule. Central.

KFNG, Coldwater, Miss. 254 meters. 100 watts. Wooten's Radio Shop. Announcer, S. D. Wooten. Slogan, "The Most Powerful 10 Watt Station in the World." Sat, 9:30-10:30 pm. Sun, 4-5 pm. Central.

KFNJ, Warrensburg, Mo. 234 meters. 50 watts. Central Missouri State Teachers College. Announcer, John May.

KFNL, Paso Robles, Calif. 240 meters. 10 watts. Radio Broadcast Assn. Announcer, Early W. Moore. Slogan, "The Home of the Nut." Mon, 8-10 pm, music. Pacific.

KFNV, Santa Rosa, Calif. 227 meters. 5 watts. L. A.

John M. E. Church, S. Slogan, "Keeping Pace with Christ Means Progress." Wed, Fri, 8-10 pm, popular program. Sun, 1-3 pm, chapel service. Central.

KFPX, Pine Bluff, Ark. 242 meters. 100 watts. First Presbyterian Church. Announcer, Howell L. Westbrook. Sun, 11 am, 12 m, 7:30-8:30 pm, church services. Central.

KFPY, Spokane, Wash. 286 meters. 100 watts. Symons Investment Co. Announcer, E. B. Craney. Tues, Wed, Thurs, Fri, 6:45-7:20 pm. Tues, 9-11 pm. Fri, 9:30-11:30 pm. Pacific.

KFQA, St. Louis, Mo. 261 meters. 50 watts. The Principia.

KFQB, Fort Worth, Tex. 254 meters. 100 watts. The Searchlight Pub. Co. Announcer, Y. M. Cornelius. Sun, 11 am, 7:15 pm, church services. Tues, Wed, Thurs, Fri, 8 pm, music. Sat, 8 pm, concert, Bible lecture. Central.

KFQC, Taft, Calif. 231 meters. 100 watts. Kidd Bros. Radio Shop.

KFQD, Anchorage, Alaska. 280 meters. 100 watts. Chovin Supply Co.

KFQE, Colorado Springs, Colo. 224 meters. 10 watts. Dickinson-Henry Radio Laboratories.

KFQG, Los Angeles, Calif. 223 meters. 50 watts. Southern Calif. Radio Assn.

KFQH, Burlingame, Calif. 231 meters. 50 watts. Albert Sherman.

KFQM, Austin, Tex. 268 meters. 100 watts. Texas Highway Bulletin. Announcer, George M. Baker. Daily ex Sun, 7 pm. Central.

KFQN, Portland, Ore. 283 meters. 5 watts. Third Baptist Church. Wed, Fri, 8-9 pm. Sun, 9:45-10:30 am; 9-10 pm. Pacific.

KFQP, Iowa City, Iowa. 224 meters. 10 watts. George S. Carson, Jr., Wed, 8-9 pm. Sat, special programs. Central.

KFQR, Oklahoma City, Okla. 209.7 meters. 50 watts. Walter La Fayette Ellis.

KFQT, Denison, Tex. 252 meters. 10 watts. Texas National Guard. Announcer, Robert Cox.

KFQU, Holy City, Calif. 234 meters. 100 watts. W. Riker. Announcer, Arthur J. Landstrom. Daily ex Mon, 9-10 pm. Sun, 11-12 m, 9-10 pm. Pacific.

KFQW, North Bend, Wash. 215.7 meters. 50 watts. The Photo Radio and Elec. Shop. Announcer, Carl P. Kriener. Slogan, "At the Western Entrance of Snoqualmie Pass." Mon, Wed, Fri, 9-11 pm. Pacific.

KFQX, Seattle, Wash. 233 meters. 500 watts. Alfred H. Hubbard.

KFQY, Belden, Neb. 273 meters. 10 watts. Farmers State Bank. Announcer, A. H. Abts. Slogan, "Where Corn is King."

KFQZ, Hollywood, Calif. 240 meters. 250 watts. Taft Radio company.

KFRB, Beville, Tex. 248 meters. 250 watts. Hall Brothers. Fri, 10 pm. Central.

KFRD, San Francisco, Calif. 278 meters. 50 watts. Radioart Corp.

KFRF, Alexandria, La. 242 meters. 10 watts. W. R. Brown.

KFRH, Grafton, N. D. 268 meters. 10 watts. The Radio Shop.

KFRJ, Conway, Ark. 250 meters. 10 watts. Guy Simmons, Jr.

KFRL, Grand Forks, N. Dak. 240 meters. 10 watts. Men's club, First Presbyterian church.

KFRM, Fort Sill, Okla. 263 meters. 50 watts. James P. Boland.

KFRN, Hanford, Calif. 224 meters. 5 watts. M. Laurence Short.

KFRP, Fort Worth, Tex. 246 meters. 50 watts. Curtis Printing Co. Announcer, James R. Curtis. Slogan, "Who Does Your Printing?" Sat, 8-10 pm. Central.

KFRQ, Redlands, Calif. 211 meters. 10 watts. Trinity Episcopal church. Sat, 7:30-8 pm, organ. Sun, 11-12:30 pm; 7:30-8:30, church service. Pacific.

KFRR, Portland, Ore. 213 meters. 5 watts. Radio Market Service Co.

KFRU, Bristow, Okla. 296.9 meters. 500 watts. Ethereal Radio Co. Mon, 8 pm. Wed, 7:30 pm; Fri, 7 pm. Sat, 7:30-8 pm, 11-1 am. Sun, 9:30-11 am, 5 pm, 7:30. Central.

KFRV, Olympia, Wash. 220 meters. 100 watts. United Churches of Olympia. Daily ex Sun, 7-7:30 pm, reports. Sun, 11-12 m, 7:30-8:30 pm. Pacific.

KFRX, Pullman, Wash. 217 meters. 10 watts. J. Gordon Klemgard. Announcer, Gordon Klemgard. Slogan, "The Only Farmers Radio Station in the World." Daily ex Sun, 9-10 pm, news, music. Pacific.

KFHY, State College, N. M. 266 meters. 50 watts. New Mexico College of Agriculture and Mechanic Arts.

KFHZ, Hartington, Neb. 222 meters. 15 watts. The Electric Shop. Announcer, P. M. Thies. Daily ex Sun, 11:55 am, news, markets; 4:15-5:15 pm, entertainment. Sun, 12-1:30 pm, entertainment. Central.

KFSG, Los Angeles, Calif. 277.6 meters. 500 watts. Angelus Temple. Tues, Thurs, Fri, Sat, 3:30-4:30 pm. Tues, 6:30-7:30 pm. Wed, 2:30-4:30 pm; 6:30-7:30. Thurs, Fri, Sat, 7:30-11 pm. Sun, 10:30-12:30 pm, 2:30-4:30, 7-8:30. Mon silent. Pacific.

KFSY, Helena, Mont. 248 meters. 10 watts. The Van Blaricom company. Announcer, George C. Stocking. Wed, 7:30 pm, music, talks. Mountain.

KFUJ, Breckenridge, Minn. 242 meters. 50 watts. Hoppert Plumbing & Heating Co. Daily ex Sun, 10:30 am, 5:40 pm, weather. Daily ex Sun, 10:40 am, 1:30 pm, 5:45 markets. Mon, Wed, 8-9 pm. Central.

KFUL, Galveston, Tex. 258 meters. 10 watts. Thomas Goggan & Bros.

KFUM, Colorado Springs, Colo. 242 meters. 100 watts. W. D. Corley. Tues, Sat, 8:30-10:30 pm. Mountain.

KFUO, St. Louis, Mo. 345.1 meters. 500 watts. Concordia Theological Seminary. Announcer, Prof. Walter A. Maier. Sun, Wed, 9-15 pm. Central.

KFUP, Denver, Colo. 234 meters. 50 watts. Fitzsimons General Hospital.

KFUQ, San Francisco, Calif. 234 meters. 5 watts. Julius Branton & Sons Co.

KFUR, Ogden, Utah. 224 meters. 50 watts. R. W. Peery's Egyptian theater.

KFUS, Oakland, Calif. 233 meters. 50 watts. Louis J. Sherman.

KFUT, Salt Lake City, Utah. 261 meters. 100 watts. University of Utah. Tues, Thurs, 12 m. Mountain.

KFUV, San Leandro, Calif. 224 meters. 100 watts. Colburn Radio Laboratories.

KFVU, Springfield, Mo. 252 meters. 10 watts. G. Pearson Ward.

KFW, Moberly, Mo. 233 meters. 10 watts. Earl Wm. Lewis.

KFUW, Butte, Mont. 254 meters. 5 watts. Irvine H. Bouchard.

KFUZ, Virginia, Minn. 248 meters. 10 watts. Y. M. C. A.

KFWB, Hollywood, Calif. 252 meters. 500 watts. Warner Brothers. Announcer, 211.1 meters. 10 watts. L. E. Wall & C. S. Myers.

KGB, Tacoma, Wash. 249.7 meters. 50 watts. Tacoma Daily Ledger. Announcer, Alvin Stenro. Slogan, "This is KGB in Tacoma, Washington, the Lumber Capital of America and the Gateway to Mount Tacoma." Mon, Wed, Fri, 7-9 pm. Pacific.

KGO, Oakland, Calif. 301 meters. 1,500 watts. Gen. Elec. Co. Announcer, Howard I. Mitholland. Daily ex Sun, 8-11:30 am, luncheon concert. Daily ex Sat, Sun, 1:30 pm; Sat, 12:30, markets, weather; Mon, Wed, Fri, 3 pm, music. Mon, 4-5:30 pm, dance orchestra. Daily ex Sun, Mon, 4-5:30 pm, concert orchestra. Daily ex Sat, Sun, 6:45 pm, reports, news. Mon, Tues, Thurs, Sat, 8 pm, lectures, music. Mon, Tues, Thurs, Sat, 10-11 am, dance music. Mon, 9 am, lectures, California State Dept. of Education; 5:30-6 pm, children's half hour. Fri, 5-5:30 pm, girls' half hour. Mon, Thurs, 10:45 am, class room instruction. Sun, 11-12 m, 7:45-9 pm, church services; 3:30-5 pm, concert. Pacific.

KGU, Honolulu, Hawaii. 360 meters. 100 watts. Marion A. Mulrony. Daily, 7:30-9 pm. Tues, Thurs, Sat, special program. 150 meridian. 2 1/2 hours later than Pacific.

(Note—The second part of the station data list will appear next week.)

CHALLENGE!

ONE DOLLAR will be paid to the Radiophan submitting the most errors in any one station's listing. Letters must reach Radio Digest office not later than one week from date of issue corrected. Readers are not limited to correcting one station, but such corrections must be certified by the stations themselves, and NOT by comparison to other so-called accurate Radiocast directories and lists. That's just how sure Radio Digest is that this Radiophone station directory is correct! To make the challenge fair for everyone, Radiocast stations and their employes are barred from this offer. Why? Because the Radiocasters are the source of all the data given herein. They are (or should be) interested enough to answer the inquiry sent them every time data on their station appears. This inquiry contains a proof of their last listing and must either be corrected or O'K'd as correct and returned to the Digest. Nevertheless, sometimes the stations are careless and mistakes are made. But Radio

Digest is so sure of the exactness of this directory that this challenge is made unconditionally.

With reference to the directory: It appears in five parts, serially continuously; the first four parts are station data listings, arranged alphabetically; the fifth part is a state, city index of stations. The information contained in each station data listing is given in the following order: Call letters, city, state, wave length used, watts antenna input, owner's name, announcer's name, slogan used if any, name of listener in "club," schedule of operating hours, and kind of time used, as "Central," "Mountain," etc.

Five successive issues of Radio Digest will give one the most complete and accurate list of Radiocast stations obtainable. This service is original with this publication, and has been maintained from the start. Right of reproduction without permission of any or all of the data contained herein is denied.

nouncer, Albert Mayer. Daily ex Sun, 5 pm, music, news, markets, weather. Central.

KFBI, Marshalltown, Iowa. 248 meters. 100 watts. Marshall Elec. Co. Announcer, E. N. Peak. Slogan, "Marshalltown, the Heart of Iowa." Daily ex Sun, 10 am, markets. Tues, Fri, 8:30 pm. Central.

KFBJ, Oklahoma City, Okla. 261 meters. 225 watts. National Radio Mfg. Co. Announcer, Tired Hand. Slogan, "Radio Headquarters." Daily ex Sun, 9:30 am, 12:15 pm, markets; 7 pm. Daily ex Sat, Sun, 3:15 pm, markets. Sat, 1:15 pm, markets. Tues, Fri, 8:30 pm, special concerts. Sun, First Baptist church. Central.

KFBJ, Astoria, Ore. 252 meters. 10 watts. E. E. Marsh and Liberty Theater. Announcer, E. E. Marsh. Wed, Fri, 10-11 pm, organ. Sun, 10:30-11 pm. Pacific.

KFBJ, Grand Forks, N. D. 278 meters. 100 watts. University of North Dakota. Slogan, "Grand Forks, the Educational Center of the State."

KFJR, Portland, Ore. 263 meters. 5 watts. Ashley C. Dixon & Son.

KFJX, Cedar Falls, Iowa. 258 meters. 50 watts. Iowa State Teachers' College. Educational programs.

KFJY, Fort Dodge, Iowa. 246 meters. 50 watts. Twin Wall Radio Co. Announcer, Carl Tunwall. Daily, 12 m, 5:45 pm, markets, news, weather. Wed, 9 pm, orchestra. Thurs, 6 pm, astrograms, weather bulletins, news. Sun, 11 am. Sun, 3:30 pm, music. Central.

KFJZ, Fort Worth, Texas. 240 meters. 20 watts. Texas National Guard, 112th Cavalry. Wed, 8:30-9:30 pm. Sat, 8:30-10 pm, program. Central.

KFKA, Greeley, Colo. 273 meters. 50 watts. Colorado State Teachers College. Announcer, Brewer Boardman.

KFKB, Milford, Kans. 273 meters. 500 watts. Brinkley-Jones Hospital Assn. Announcer, J. R. Brinkley. Slogan, "The Home of Gland Transplantation." Daily ex Sun, 6-7 pm, lecture, music; 10-11. Sun, 8-10:30 pm, church services. Central.

KFKQ, Conway, Ark. 250 meters. 100 watts. Conway Radio Lab.

KFKU, Lawrence, Kan. 275 meters. 500 watts. University of Kansas. Announcer, John F. Patt. Mon, Thurs, 6:50-8 pm. Central.

KFKV, Butte, Mont. 283 meters. 50 watts. F. F. Gray. Sun, Wed, Fri, 8:30-9:30 pm. Mountain.

KFKX, Hastings, Neb. 288.3 meters. 1500 watts. Westinghouse Elec. & Mfg. Co. Announcer, Wm. G. Hay. Slogans, "The Empress of the Air," "The Pioneer Re-Broadcasting Station of the World." Mon, Thurs, 9:30-11 pm, broadcasts own program. Re-broadcasts KDKA's programs. Central.

KFLA, Butte, Mont. 253 meters. 5 watts. Abner R. Willson.

KFLB, Menominee, Mich. 248 meters. 50 watts. Signal Elec. Mfg. Co.

KFLE, Denver, Colo. 268 meters. 25 watts. National Educational Service. Daily ex Wed, 6-6:30 pm. Broadcasts for schools on request. Mountain.

KFLP, Cedar Rapids, Ia. 256 meters. 20 watts. Everett M. Foster.

KFLI, Albuquerque, N. M. 254 meters. 100 watts. L. & N. M.—Announcer, Philip S. Donnell. Slogan,

Drake. Daily 2-3 pm; 6-6:30, news, music. Pacific.

KFNY, Helena, Mont. 248 meters. 50 watts. V. Kemp Roberts. Experimental station.

KFOA, Seattle, Wash. 454.2 meters. 500 watts. Rhodes Dept. Store. Announcer, Carl E. Raymond. Daily ex Sun, 4-5:15 pm. Tues, Wed, Thurs, Fri, 12:30-1:30 pm. Daily ex Thurs, Sun, 6:45-8:15 pm; 8:30-10, Times program. Tues, Fri, Sat, orchestra. Pacific.

KFOC, Whittier, Calif. 236 meters. 100 watts. First Christian Church.

KFOD, Wallace, Idaho. 224 meters. 10 watts. The Radio Shop.

KFOJ, Moberly, Mo. 246 meters. 5 watts. Moberly High School. Announcer, Herbert Settle.

KFOL, Mangro, Ia. 234 meters. 10 watts. Leslie M. Schuch.

KFON, Long Beach, Calif. 234 meters. 100 watts. Echophone Radio Shop. Slogan, "Where Your Ship Comes In." Tues, Wed, Fri, 2:30-4 pm; 7:30-10. Mon, 8-10 pm. Sat, 2:30-5 pm; 7:30-10. Sun, 11-12 m, 8-9 pm. Pacific.

KFOO, Salt Lake City, Utah. 261 meters. 5 watts. Latter Day Saints University. Announcer, Don C. McTae.

KFOR, David City, Neb. 226 meters. 20 watts. David City Tire & Elec. Co. Slogan, "The Voice of David City." Announcer, Howard A. Shuman.

KFOT, Wichita, Kansas. 231 meters. 50 watts. College Hill Radio Club. Announcer, Leon Garnett. Slogan, "Radio-casting Church." Sun, 11-12:30 pm; 7:30-9, church services. Mon, 9-10:30 pm, music. Central.

KFOU, Richmond, Calif. 254 meters. 100 watts. Hommel Mfg. Co.

KFOX, Omaha, Neb. 248 meters. 100 watts. Board of Education, Technical High. Announcer, H. E. Bennett.

KFOY, St. Paul, Minn. 252 meters. 50 watts. Beacon Radio Service. Sun, 3:30-4:30 pm. Central.

KFPG, Los Angeles, Calif. 238 meters. 10 watts. Garretson and Dennis.

KFPH, Salt Lake City, Utah. 242 meters. 50 watts. Harold Charles Mailander.

KFPL, Dublin, Tex. 252 meters. 15 watts. C. C. Baxter, announcer. Mon, Thurs, 8 pm; Sat, 10-11 pm; Sun, 7-8 am. Central.

KFPM, Greenville, Tex. 242 meters. 100 watts. The New Furniture Co. Announcer, Dave Ablowich, Jr. Slogan, "The New Furniture Co., the Home of Good Furniture," located at Greenville, Texas, where you find "The Blackest Land, the Whitest People." Daily ex Sun, 2 pm, music. Tues, Wed, Thurs, Fri, 8 pm. Sun, 11 am, services; 7:15 pm, irregularly. Central.

KFPR, Los Angeles, Calif. 231 meters. 500 watts. Los Angeles Co. Forestry Dept. Slogan, "Forestry." KFFT, Salt Lake City, Utah. 261 meters. 500 watts. Radio Service Corp. of Utah. Announcer Charles H. Hays. Mon, Wed, Thurs, Sat, 8 pm. Tues, Fri, Sun, 9 pm. Mountain.

KFPV, San Francisco, Calif. 236 meters. 50 watts. Heinz & Kohlmoos, Inc. Announcer, Ralph H. Heinz. Slogan, "Ain't We Got Fun." Sun, 7-8:30 pm. Pacific.

KFPW, Carterville, Mo. 268 meters. 20 watts. St.

Music Master Supreme!



Model VI, \$30
14" wood bell
Model VII, \$35
21" wood bell

Connect Music Master in place of headphones. No batteries. No Adjustments.
(Prices of all models slightly higher in Canada.)

Music Master Resonant Wood Insures Natural Tone Quality

SUPREME QUALITY of Broadcast Programs is the 1925 radio demand—quality of entertainment, quality of information, quality of instruction.

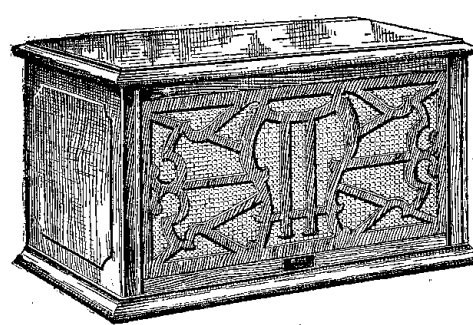

Model VIII, Mahogany Cabinet with "full-floating" wood bell \$35

Broadcasting of programs by grand opera stars and noted musical artists, now makes it possible for all music lovers to enjoy the supreme in quality of musical entertainment. Perfect enjoyment of Super Program Broadcasting requires faithful re-creation, such as is found only in Music Master. Wood alone for vibrant, resonant amplification—heavy cast aluminum for tone development without distortion—finest watch-making

accuracy in the reproducing instrument—all these elements combine to make Music Master the musical instrument of radio. There IS no substitute. Test these statements. Ask any radio dealer to demonstrate Music Master—on your own set, if you like. Music Master is guaranteed both by dealer and manufacturer—unconditionally and without reservation.

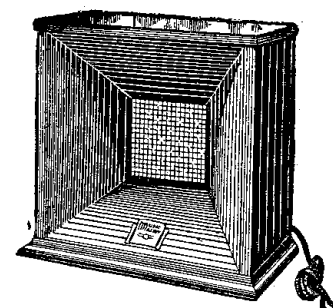

Model V, Metal Cabinet, Mahogany finish, wood bell \$18

Music Master Corporation
Makers and Distributors of High-Grade Radio Apparatus
10th and Cherry Streets
Chicago PHILADELPHIA Pittsburgh
Canadian Factory: Kitchener, Ontario

Music Master RADIO REPRODUCER