

"Fireside"—New 6-Tube Perfect Reproduction Set ; WHT in Pictures, 2 Pages ;
 New Operating and Trouble Shooting ; An Interesting Radio Explanation

Radio Digest

EVERY
WEEK

PROGRAMS
Illustrated

TEN
CENTS

REG. U. S. PAT. OFF. & DOM. OF CANADA

Vol. XV

Copyright 1925
By Radio Digest Publishing Co.

SATURDAY, OCTOBER 31, 1925

No. 4

HOME RADIO MOVIES SOON

THIS IS ONE WAY TO KILL GOLDEN GOOSE

"POOR STARVING AUTHORS"
TIGHTEN GRIP ON RADIO

Music Trust Demands Driving Pickup
Programs from the Air—They For-
get Free Advertising

SEATTLE.—Seattle broadcasters are facing a problem for the future, when their present contracts with the American Society of Composers, Authors and Publishers expire. They were recently served notice that an increase would be made on their fees in the use of musical selections that would total \$300 a day, if enforced.

The fees would total \$100,000 per year for the three Seattle stations, and as none of the stations are wealthy, it amounts to much more than pin money. The fee is exacted for the "right" to broadcast popular and classical numbers.

When it is taken into consideration that many a number would have gone down into oblivion if it had not been for the continual pounding of the Radio program, and these increased sales total many thousands of dollars for members

(Continued on page 15)

Busy starring in "The Fall of Eve,"
Ruth Gordon finds time to face the
microphone now and then. She re-
cently appeared at WOL.



PICTURES ON OWN SET FOR SMALL COST

Air Vision Not a Dream

Just Plug in Like Speaker and
Witness Events That Are
Miles Away

BOSTON.—Radio vision at home with your present set for \$75, was the recent prediction here of C. Francis Jenkins, Washington, D. C., inventor of the most satisfactory method yet known for transmitting still and motion pictures by Radio, in speaking before the national business conference held at Babson park.

The dream of ages, instantaneous television or motion pictures—without the aid of wire lines—seems close to public usage.

Mr. Jenkins said: "Audible Radio has already changed our social order. Those who may now listen to a great man or woman are numbered in the millions. Our president frequently talks to practically the whole citizenship of the United States simultaneously. When to this audible Radio we add visible Radio, we may both hear and see great events.

How Visible Radio Operates

"To get music by Radio, a microphone converts sound into electricity, which, carried by Radio to distant places, is there changed back into sound and we hear the music. To get motion pictures by Radio our light-sensitive cell converts light into electricity and at Radio distances changes this electricity back into light again, and we see the distant scene, for orderly distributed light is the thing of which pictures are made.

"It isn't easy at first to understand that our Radio motion picture is made up

(Continued on page 15)

Down in the corner is Margaret McDevitt, often heard from WGES, the Coyne Electric School station of Chicago and Oak Park, Illinois.



Above is In-cille Vail Marsh, pianist from the Seidel School of Music in Columbus, Ohio, who entertains thousands every Monday afternoon with her concerts from Station WEAO in the same city. Her music is just as beautiful to the ear as is her picture to the eye.

R. C. A. OUT \$6,600 FOR NEGLIGENCE

Fails to Deliver Radiogram and
Losses Suit to Sender
for Damages

NEW YORK.—A verdict for \$6,600 for the non-delivery of a Radiogram was directed against the Radio corporation of America recently by Supreme Court Justice Churchill, in favor of the Kerr Steamship company.

The suit was based on the loss of freight charges on a cargo of sugar from Manila, which would have been taken by the plaintiff's vessel if the message to take the cargo had been delivered. Justice Churchill ruled that the verdict should be based on the damage sustained.



How Can We Improve Radio Broadcasting?

THE Westinghouse Electric and Manufacturing company operates four of the country's best known and popular broadcasting stations. Three were in the business from the start, KDKA, their Pittsburgh plant and "the daddy of them all," being the first station. This company besides being the first in the field has been ever progressive. It has not hesitated to revamp its whole system to keep up with the many improvements introduced from time to time. In all this activity, H. P. Davis, vice-president of the company in charge of broadcasting, has taken the lead.

In the following discussion, prepared in response to questions suggested by Radio Digest, Mr. Davis gives his views on the questions of the day in Radioland, "What's Wrong with Broadcasting?" and "How Can We Improve Radio?"

Other articles prepared by leaders in the broadcasting field will follow this one. The suggested questions are enumerated in the box at the right of this page.

By H. P. Davis, Vice President, Westinghouse Electric & Manufacturing Company

1. I BELIEVE that the future of the small station is secure, provided it meets the requirements of the district in which it is located.

The term "superpower" seems to me to be most unfortunately used in connection with a higher power station, since "superpower" is a relative term and not definite. The so-called "superpower station" of today may be a low power station of tomorrow. It is believed that on account of economical conditions, the competition between stations to see which station can talk the loudest will, in the end, defeat itself.

I believe that a broadcasting station's power in a definite locality should be sufficient, and only sufficient, to get dependable coverage for its definite area 365 days in the year. Day and night broadcasting by relaying is wholly possible by using a method which I have repeatedly proposed. This method depends on boosting the Radio signal to keep it of sufficient strength to permit relaying. With such a plan in successful operation, I believe there will be little or no necessity of superpower stations, and that low-power stations, with cheaper maintenance and operating requirements, would be quite sufficient. I believe that the small station could easily "hold its own" and not be forced off the air by competition if this plan, which is outlined in the following, can be developed.

The plan I have in mind proposes the transmission of programs by short wave broadcasting, with boosting by suitably spaced auxiliary amplifying stations. These short-wave broadcasting stations will be located at central points where the best material is available, and be connected by telephone wires to adjacent points of pick-up. The regular wave broadcasting stations will depend on, and will pick up and relay these short wave transmissions, to fill out their program service, and will undoubtedly, in some way, help support the service.

In other words, at selected points on this continent, and possibly on other continents, short-wave high power transmitting stations will be erected, each station having a transmission channel of its own, and long distances will be covered by means of the boosting and amplifying stations located to maintain and continue the signal strength.

This system will correct fading difficulties, and will in a large measure overcome static and other interference, and establish a service to the regular wave broadcasting stations equal to or better than that supplied by wire, but much cheaper, more flexible and suitable for greater distances.

The broadest possible opportunity will be provided these short-wave transmitting stations to pick up any suitable program material, either national or international, and to distribute it in a way analogous to the news service of the Associated Press for newspapers, the regular wave broadcasting stations taking this service being formed into an association in a manner similar to that of the newspapers.

There may be as many channels of program transmission as there are short wave transmitting stations. Each having different programs, considerable choice will be available to the pick-up regular broadcasting stations, and programs of great interest can be built up by them.

2. REGARDING entertainment programs, I believe an answer to this is hardly possible since it is so much a matter of individual taste and will be



H. P. Davis

guided so thoroughly by the demand of the public.

State and federal censorship would be a distinct step backwards, as it seems to me this would stifle initiative and be cumbersome in operation. It might be possible, however, to have general guidance formulated by a set of federally prepared rules of procedure. Nevertheless, it is our experience that in the long run the public fills this position admirably and does it better than any board or law-making body.

3. AS TO "who is to pay," in our opinion this question will not be answered by toll stations. Radio broadcasting is the greatest medium for advertising that has ever appeared to date, and undoubtedly it is going to be used in some way for that purpose—at least as a means of good will advertising, and as such will be paid for and paid for well. It is too early now to say how this is to be worked out, but a great many are thinking about it and trying out various schemes, and we are satisfied that something will be developed which will be profitable and still not be obnoxious to the listening public.

Taxing Radio manufacturers or imposing a receiving set fee is, in my opinion, quite impractical.

4. UNQUESTIONABLY there should be some method of limiting the number of stations if the broadcasting service is to be developed as it should be and

SUGGESTED QUESTIONS

1. What is the future of the small station? Day-light broadcasting? Relay night broadcasting? Or will that be unnecessary on account of the superpower stations? Will the small station be forced off the air by program competition?
2. What type of programs (include various classes) are destined for the future? Of entertainment programs, what kind would you consider the best? What of the "continuity" or "presentation" program? Are you opposed to state and federal censorship of Radio programs? Why?
3. Will toll stations be the answer to "Who's to pay?" We must consider that large business enterprises, who operate their own stations, are really doing toll advertising on an exclusive scale, unless these big firms allow a certain part of their time on the air to be leased by other firms or individuals. Will superpower growth cause the toll station to be the sole survivor of the American system? What about taxing Radio manufacturers, or by a public receiving license fee as in England?
4. Shall broadcasting stations be limited in number by some licensing plan based on priority and ability to serve, or some similar device? The Kintner plan has been proposed as a means of limitation. What is your opinion of this plan?
5. Do you favor appointment of an unbiased, non-partisan broadcasting control board, in which the public, the broadcasters, the Radio industry and the government shall be represented, which board shall have the power vested to settle all differences pertaining to broadcasting and the interpretation of present or future Radio legislation? How should such a board be appointed? Define the board's power.
6. Do we need new or amended Radio legislation? What should this include?
7. The Radio section of the department of commerce last year was given \$125,000 with which to work. The department, according to an estimate, employs 70 persons. Trips of supervisors and their assistants all over the country must come out of this appropriation as well as the 70 salaries. No money is left for instruments—the most necessary equipment for the supervisor. Does the department need more money? If the government wishes to reduce taxes, why not apportion the inspection costs wholly or partly, to the various stations?
8. The piezo-electric crystal is an unswerving guide which holds a station on its assigned frequency. Why not adopt it as requisite of every broadcasting licensee? The bureau of standards could test each one to see that it was ground to the exact licensed frequency, and the cost—not large, being well under one hundred dollars—could be borne by each station. If not each station, why not make it a requisite of every station having a power exceeding 250 watts?
9. What do you think of allocating certain wave bands to international superpower broadcasting and reception?

public interest maintained, and a station once established, because of the investment required, should have a protected right that is good so long as that station gives a satisfactory service. The Kintner plan is probably as good as any that has so far been proposed.

5. A BOARD of control, such as indicated, is, in our estimation, of doubtful value. It would be better to have a federal commission functioning in a similar manner to the interstate commerce commission or the public service commission in the various states, the constitution of the commission being wholly non-political.

6. IT WOULD be a mistake, in the present condition of broadcasting, to have any new legislation enacted and until this situation is clarified and better understood, and some plan or method similar to that indicated herein is sufficiently worked out to show its practicability, it would be a misfortune to have new limitations introduced over those already existing.

7. IT IS believed that the appropriations for the operation of the Radio section of the department of commerce are wholly inadequate when the importance of the service is considered, and that the amount should be very greatly increased. The various broadcasting stations have all the expense they can support at the present time, and it would be asking too much to have any taxation imposed on them to support this inspection activity. As it is, the public is the great beneficiary from broadcasting and pays nothing for it, and therefore it seems to me that the appropriations should come out of the general funds of the government, which of course come from the people at large.

8. WE are thoroughly in accord with the proposal relative to the use of piezo electric crystals for controlling the broadcasting stations' waves. KDKA, of the Westinghouse Electric and Manufacturing company, has had these crystals in use for some time now, particularly in its short wave transmissions, and is, I believe, the first station to so employ them.

9. THE plan herein proposed contemplates the location of certain short wave bands or channels to definite transmitting stations, and as this would extend to other continents, it would obviously require allocation of channels for such a purpose. This allocation will have to be made and restrictions of some sort must be established which will prevent the use of apparatus or devices which will cause interference with, or in any way disturb these channels.

CONTENTS

Radio Digest, Illustrated, Volume XV, Number 4, published Chicago, Illinois, October 31, 1925. Published weekly by Radio Digest Publishing Company, 510 N. Dearborn Street, Chicago, Illinois. Subscription rates, yearly, Five Dollars; Foreign Postage One Dollar additional; single copies Ten Cents. Entered as second class matter at the post office at Chicago, Illinois, under the Act of March 3, 1879.

All the Live News of Radio.....	1 to 15
Wendell Hall, the Eveready Entertainer.....	5
Station WHT, Chicago Link of the Mid Continent Chain.....	6 and 7
Advance Programs for the Week.....	24 to 29
An Evening at Home with the Listener In, a chart in central time, showing when to listen in for your favorite stations.....	29
Following Sports Through Mike.....	31
Editorials, Indi-Gest and Condensed by Dielectric.....	32
Interesting and Simple Explanation of Radio, Chapter I—An Understandable Analysis of Electricity, by H. G. Tanner.....	33
Operating and Trouble Shooting.....	35
Fireside: 6-Tube Set of Perfect Reproduction, Part I—Explanation of Set and Circuit, by Jacques Fournier.....	37
The Grand Prix Eight Tube Super-Heterodyne, Part II—Drilling and Assembly, by James McDonald.....	39
"Traveler" Doughnut Coil Tuned R.F. Receiver, Part IV—Connecting and Operating, by John G. Ryan.....	41
Questions and Answers.....	45
Directory of Radiophone Broadcasting Stations, Part V.....	47

Looking Ahead

Seldom Has a New Station come on the air with such an ovation as was received by WSM, of the National Life and Accident Insurance company at Nashville, Tennessee. Bonnie Barnhardt, long associated with WSB, is now with this new plant. We will tell and show you all about it next week.

Football Is Getting More Interesting every week and thousands who cannot get within the gridiron gates are following the college warriors via Radio. Watch the sport page for up-to-the-minute schedules.

The Biggest Swimming Pool in the World is the one in which swim the electricity that makes the Radio go. Next week Prof. Tanner will tell you something about this in his simple Radio explanation series.

Get the Old Drills Sharpened because next week Jacques Fournier is going to explain how to drill and assemble the Fireside Six Tuber.

You will Be Surprised How Easy it is to wire a super-het after you read James McDonald's instructions regarding this important step in the construction of the Grand Prix.

Operating and Trouble Shooting given anew this week will be a study of a standard receiver next issue.

Newsstands Don't Always Have One Left

WHEN YOU WANT

Radio Digest

YOU WANT IT!

BE SURE OF YOUR WEEKLY COPY BY SUBSCRIBING NOW

SEND IN THE BLANK TODAY

Publisher Radio Digest, 510 N. Dearborn St., Chicago, Illinois.

Please find enclosed check M. O. for Five Dollars (Six, Foreign) for One Year's Subscription to Radio Digest, Illustrated.

Name

Address

City..... State.....

FOOTLIGHT FAVORITES HELP KYW OPEN NEW STUDIOS

Claiborne Foster, center, has always been popular with KYW fans. When the new studio opened, this charming little lady, star of "The Patsy," did her bit in making the program worth remembering.



Georgia Kober, left insert, was one of the pianists on the opening bill. Many opera stars, including Katherine Sutherland, soprano of the Chicago Civic Opera company, left insert, also assisted in the Congress hotel studio opening program.

PIONEER OF WEST IN GALA STUDIO EVENT

KYW, CHICAGO, OPENS NEW CONGRESS HOTEL PLANT

Original Station Started in 1921; Mayor and Stage Stars Aid in Dedication

CHICAGO.—A gala Radio event for the Middle West was the recent formal opening of the new studio of Westinghouse Station KYW, and its newest power equipment. This newest studio in Chicago is located in the Congress hotel on the lake front, and the station is located on the roof of the hotel.

The opening of KYW's latest studio and station, brings to mind to old timers of Radio, when KYW, the pioneer station of the West, went on the air on Armistice Day, November 11, 1921, with its first transmitter. At that time Radio was in

THREE MORE CITIES PLANNING STATIONS

WANT FANS TO SUBSCRIBE CASH FOR STATE RADIO

St. Louis, Miami, and Oklahoma Announce Forthcoming Broadcasters for Air Entertainment This Winter

CHICAGO.—Over a half million dollars will soon be invested in equipment to give three widely separated cities new super-broadcasting plants, according to advices received here. St. Louis will have a station costing \$240,000 to be built by a combination of sixteen local firms. Miami, Fla., will be represented by WIOD, erected by the Carl Fisher hotel interests at a cost of approximately \$100,000. A plant in Oklahoma to cost \$200,000 will be started as soon as the money is subscribed by Radio fans of that state.

St. Louis Project Different

The St. Louis project will be unique in that sixteen different firms of the city and county will share alike in the cost and upkeep. Thus, no one business house will monopolize the station and it will truly be "The Voice of St. Louis." The organization is complete and Thomas P. Convey, general manager of the St. Louis Radio Trades association, will fill the same position with the broadcasting organization. Radio engineers are now investigating the surrounding country with a view to locating the plant some eighteen or twenty miles from the city. It is expected that the new broadcaster will be St. Louis' Christmas gift to the nation, opening on or about December 20.

"Wonderful Isle of Dreams"

The Miami station will go on the air January 1, according to Jesse Jay, director and announcer. Five different orchestras will furnish music direct from five different hotels during the course of one evening's program. The call letters, WIOD, stand for "Wonderful Isle of Dreams," the studio being on that part of Miami entirely surrounded by the waters of the bay.

It is up to the fans of Oklahoma to provide the money for the initial cost of the proposed station there. The chamber

of commerce of Oklahoma City is organizing a drive to obtain the required \$200,000 by state-wide subscription. The Radio dealers of the state have agreed to provide for the upkeep of the new plant. In order to make this project a whole state affair it is proposed to have remote control stations in six cities. Those tentatively selected are Oklahoma City, Tulsa, Norman, Stillwater, Okmulgee, and some other city in the circle.

New Stations

Two stations have changed ownership and call this last week. WTAS, Elgin, Ill., now has the call WLIB. The Liberty magazine has taken over the equipment. Charlie Erbstein will still continue to announce from time to time. The Worcester, Mass., broadcaster WCTS, has become the property of the Worcester Telegram Publishing company. The call used is WTAG. Both WLIB and WTAG retain the old wave lengths.

Other stations licensed last week are: KFXV, Flagstaff, Ariz., 50 watts, 205.4 meters; WJBK, Ypsilanti, Mich., 10 watts, 233 meters; WJBN, Sycamore, Ill.; KFJZ, Fort Worth, Texas, 50 watts, 254 meters. Southwestern Baptist Theological seminary.

KOB, State College, N. M., is now using 1,000 watts. WEAN, Providence, R. I., has recently gone up to 500 watts.

Shut-Ins Benefit by WJAG Sets; Crowds Cheer Stefan

NORFOLK, Nebr.—Through the efforts of Karl Stefan's Radio Station WJAG and the Norfolk Daily News, more than fifty invalids were presented with good receiving sets during the past year and it is planned to give as many more away this year to deserving people. Stefan and his "World's Greatest Country Newspaper" are well liked out on the Nebraska prairies. At the recent Boone county fair, 10,000 people cheered him and WJAG.

GREAT BARITONE IN WEAFF CONCERT

New York Symphony Orchestra With Walter Damrosch Leading to Give Interesting Program

NEW YORK.—On Sunday afternoon, November 1, WEAFF will broadcast a concert by the New York Symphony orchestra under the direction of Walter Damrosch, direct from the new Mecca auditorium in New York city. Lawrence Tibbett, the baritone who made such a sensation at the Metropolitan opera last season in the role of Mephistopheles, will be the distinguished soloist in the concert which opens the 1925-26 season series of twenty Sunday afternoon concerts by the New York Symphony orchestra.

The selections to be broadcast starting at 3 p. m., eastern time, and continuing until 3:45, are as follows: 1. Academic Festival overture (Brahms); 2. Monologue: "Wahn, Wahn," from "The Mastersingers" (Wagner), Lawrence Tibbett; 3. Suite Anglaise (Rabaud), arranged from music written by composers at the court of Queen Elizabeth and to be played for the first time in America; 4. Songs (Moussorgsky), "After Years," "My Little Room," "After the Battle," "Song of the Flea," Lawrence Tibbett with Frank La Forge, composer-pianist, at the piano.

The New York symphony has for forty years been under the capable direction of Walter Damrosch. He assumed the responsibility of this organization as a youth of 23 upon the death of his father.

WAPI to Increase Output

BIRMINGHAM, Ala.—Victor H. Hanson broadcasting station, WAPI, at the Alabama Polytechnic institute at Auburn, will be improved with additional equipment which has been authorized purchased by the trustees of the institute. The power will be increased from 500 to 1,000 watts. Daily broadcasting from this station will commence early in December.

its embryo state; studios were only an experiment and the technique of broadcasting was unknown.

The opening program was started by Hon. William E. Dever, mayor of Chicago, who was introduced by Alderman Jacob M. Arvey, chairman of the mayor's Radio commission.

Albert Borroff, basso, who has appeared before all the leading choral organizations and orchestras in the country, was heard during the evening, as well as Francesco Daddi, formerly the leading comedian of the Chicago Opera company, under the direction of Campanini, which preceded the Chicago Civic Opera company as the original opera of Chicago, who was featured in Italian folk songs.

Joska DeBarbary, as well as his Continental orchestra, and Coon and Sanders Original Nighthawks, were heard.

Popular Stars Help Dedicate

Following the classical part of the dedication program, high-class popular stars kept the later hours of the evening agog with entertainment.

Included in the latter were Lee Sims, nimble fingered staff pianist; Clairborne Foster, leading lady of "Patsy," now playing in Chicago; Earnest Truex, playing in "The Fallguy" at the Adelphi, Chicago, and many other KYW and visiting artists.

COURT DECISIONS NO SECRET IN GERMANY

FRANKFURT, Germany.—Decisions of the higher German courts, located here, will be broadcast daily by the local Radio station in order that the German people may have a better knowledge of the law. If this plan proves successful, brief resumes of all trials and possible full proceedings of the more important cases will be put on the air. Instead of a jury of twelve men listening to a trial, the whole Radio audience will have an opportunity of making their own decisions (in their minds) as to the guilt or innocence of persons up before the judge.

500 WANT 2LO JOB; ONLY 3 CAN QUALIFY

LONDON.—Out of the 500 applicants for the position as announcer of Station 2LO here, only three were found to possess the necessary qualifications. One will be selected and it will be his duty to explain and interpret both incoming foreign pick-ups from the Bromley plant and English plays and talks put on the overseas broadcast. This requires that he speak five languages fluently, these being Spanish, German, Swedish, French and Dutch. The new announcer will be highly paid but the British Broadcasting company refuses to divulge the figure of his salary.

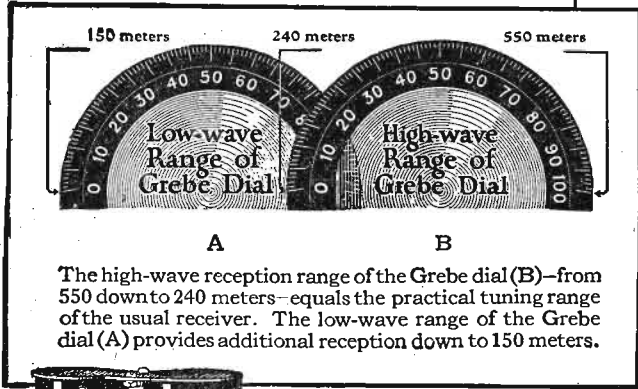

The high-wave reception range of the Grebe dial (B)—from 550 down to 240 meters—equals the practical tuning range of the usual receiver. The low-wave range of the Grebe dial (A) provides additional reception down to 150 meters.

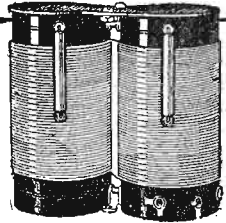

Grebe Binocular Coils
Reg. U. S. Pat. Off.
and
Low-Wave Extension
Circuits

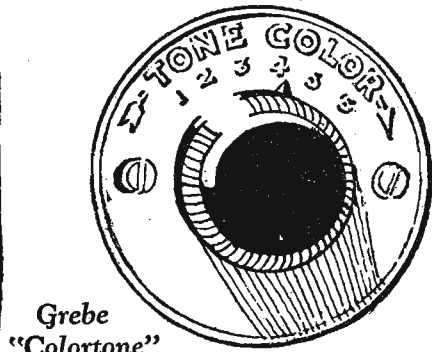

Grebe
"Colortone"

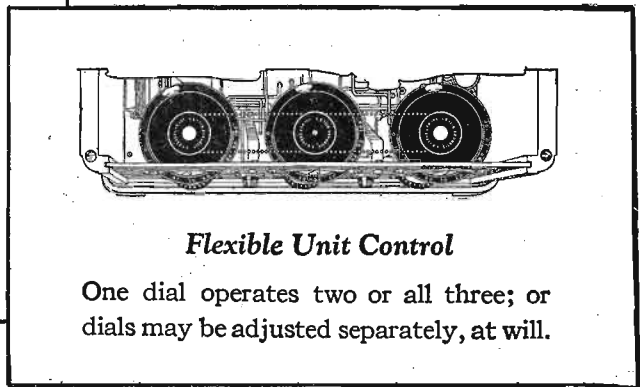

Flexible Unit Control

One dial operates two or all three; or dials may be adjusted separately, at will.

The Three Outstanding Radio Advances of 1925

YOU could not give or receive a finer Christmas gift than the Grebe Synchronphase.

Last year Grebe developed the fieldless *Binocular Coils* and *S-L-F Condenser*. This year even greater strides have been made in radio reception.

With the Grebe "Colortone" the quality of sound can be kept absolutely true and clear and is always under the listener's control, independent of the loud speaker's influence. This tone control also makes it possible to reduce, to a great degree, disturbances due to static and to suppress considerably the high-pitch frequencies caused by heterodyne interference of one station with another.

The *Low-Wave Extension Circuits* have widened the reception range so that over 100 low-wave stations, not reached by other receivers, can be tuned.

Flexible Unit Control gives one, two or three-dial control.

Both in range and quality of reception, the Grebe Synchronphase is far in advance.

Ask your dealer to demonstrate, then compare Grebe reception with that of other receivers

A. H. Grebe & Co., Inc., 109 West 57th Street, New York
Factory: Richmond Hill, N. Y.
Western Branch: 443 So. San Pedro Street, Los Angeles, Cal.

THE GREBE

This company owns and operates stations WAHG and WBOQ; also low-wave re-broadcasting stations, mobile WGMU and marine WRMU

SYNCHROPHASE

TRADE MARK
REG. U. S. PAT. OFF.



"Take the lead and set an example of diligent toil"
—Confucius

Much toil and great diligence have made the Synchronphase worthy of first rank in radio receivers.

Doctor Mhu

The Synchronphase is also supplied with base for batteries and in a de luxe Console model

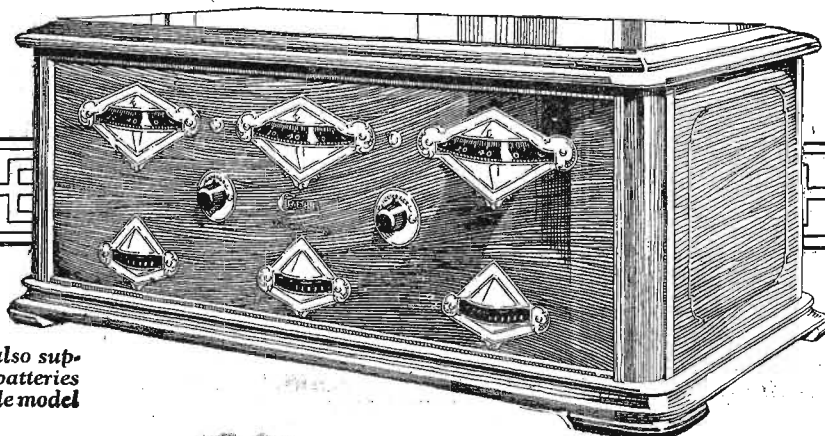

All Grebe apparatus is covered by patents granted and pending.

Wendell Hall—"Eveready Entertainer"

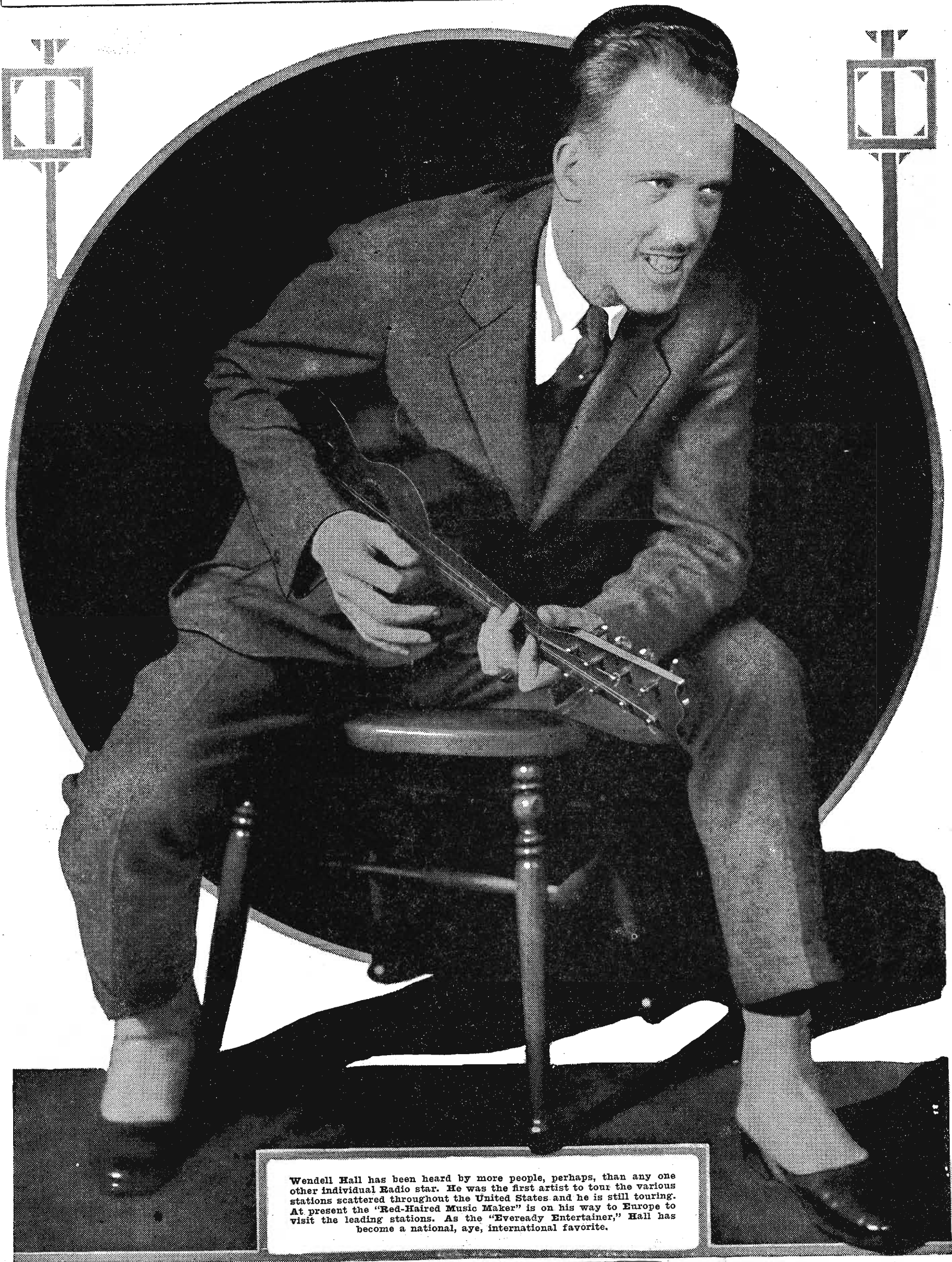

Wendell Hall has been heard by more people, perhaps, than any one other individual Radio star. He was the first artist to tour the various stations scattered throughout the United States and he is still touring. At present the "Red-Haired Music Maker" is on his way to Europe to visit the leading stations. As the "Eveready Entertainer," Hall has become a national, aye, international favorite.

WHT, Show Place of the Wrigley Building

A view of the WHT studio, to be seen any noontime, showing a crowded gallery watching and hearing Al Carney playing his all-complimentary organ recital. Chief Announcer Pat Barnes is at the announcer's desk.

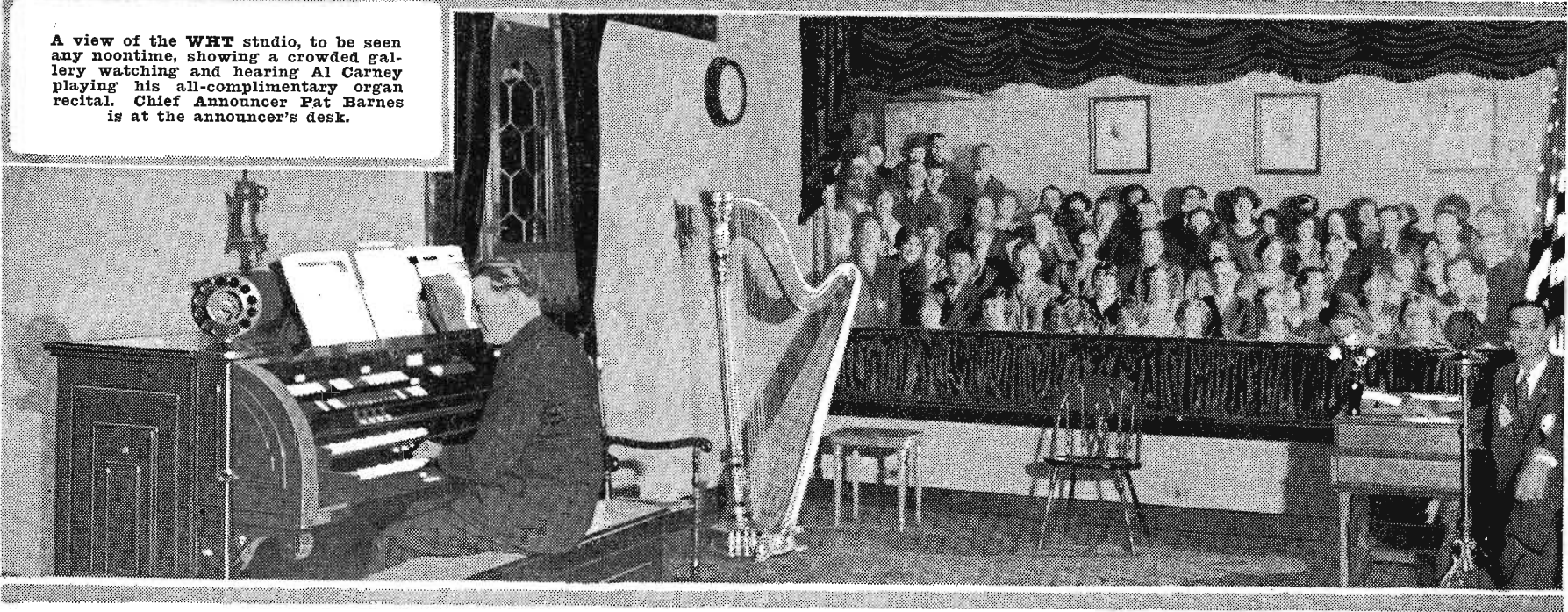

"WESTMINSTER ABBEY," envious broadcasters have jeeringly termed the palatial home of WHT, Chicago link of the Mid Continent Broadcasting chain, and Westminster Abbey WHT is, both in its perfect studio appointments and quality of programs broadcast to an ever-increasing audience of enthusiastic listeners. Take the word of one who has seen many, many

stations—in the East, South and West—and believe that WHT is one of the half dozen really beautifully furnished and completely equipped broadcasters in the world, England, France and Germany included.

Yet, the 5,000-watt transmitter at Deerfield, Ill., remotely controlled from the Wrigley building in Chicago, is a straight business proposition—a commercial toll station.

"What is a commercial toll station?" is a question often asked by Radio listeners. Basically all Radio stations with the exception of those operated by the government and amateurs are in a sense commercial stations. Although all stations do not accept compensation for broadcasting entertainment, those that do not, charge the tremendous overhead to general advertising and promotion. Stations operated by department stores and newspapers are the best examples.

A commercial toll station operated for profit sells a service to advertisers in the form of an entertainment program and pays good talent for broadcasting; the purpose thereof is to create good will and name publicity for the advertiser and his product. This is the policy and work of Station WHT. By reason of the fact that this station is enabled to pay its performers, better and improved programs are the result.

The operation of a broadcasting station as a going business required the application of improved business methods. A broadcasting station like a daily newspaper has many things in common. The business was accordingly departmentized as follows: executive, commercial, musical, program, publicity and operating. The executive department is headed by G. E. Carlson as general manager. Franklin C. E. Lundquist is in charge of the musical department. The program and publicity departments are headed by Charles Burke as director, a man to whom more than the usual credit should be

given. Reeve O. Strock, former engineer in charge at WGY, is the engineer in charge at WHT.

H. J. Bligh, nationally known in the advertising field, was obtained to direct the activities of the commercial department and the success of his efforts in pioneering an experimental advertising venture is reflected in the organization of the Mid Continent Broadcasting Associates who operate six of the country's largest stations, five of which are owned or controlled by leading newspapers. Much of the credit for the success of Station WHT and the good will built for national advertisers in thousands of American homes is due to the rigid restrictions imposed by Mr. Bligh in the presentation of commercial programs.

Among the many firms using the services of WHT for toll programs are Bordens, the milk firm; John F. Jelke company, of Chicago; Fitzpatrick Brothers, of Chicago; United States Light and Heat corporation, of Niagara Falls, N. Y.; Consolidated Cigar corporation, of New York; Washburn-Crosby company, of Minneapolis; Hawthorne Roofing company, of Chicago. These firms have purchased time on the air similar to space in newspapers and magazines. The time on the air is comparable with the running of advertisements in various editions of publications. While air advertising is still in an experimental state, exhaustive analysis by national advertisers is resulting in an ever increasing percentage of advertising appropriations devoted to commercial Radio publicity. This is made more apparent by the fact that many of the leading advertising agencies are operating Radio publicity departments.

You have heard what WHT is. A word about how the business venture was inaugurated, is timely. George Carlson, electrical contractor, several years ago was germinated with the idea of founding a first-class, commercial toll station. He was aided by three associates,

More poets have gone into ecstasy over the spectacular beauty of the Wrigley building (left) than over any of the architectural specimens of Europe. It houses the studios and remote control rooms of the station. These are in the lower level and not in the tower as might be supposed. Below is a general view of the studio taken from the spectators' gallery through a large plate glass window. Is it any wonder artists are always at their best before the WHT microphone? Such beautiful surroundings are bound to bring forth good programs. Note the always present American Flag!

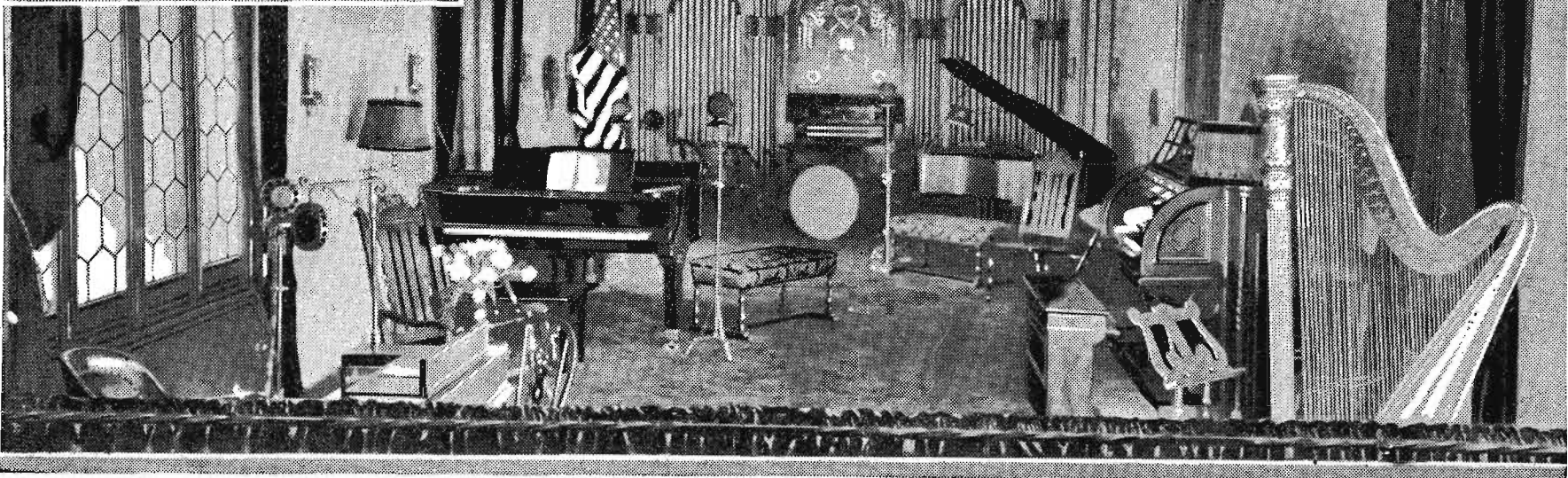
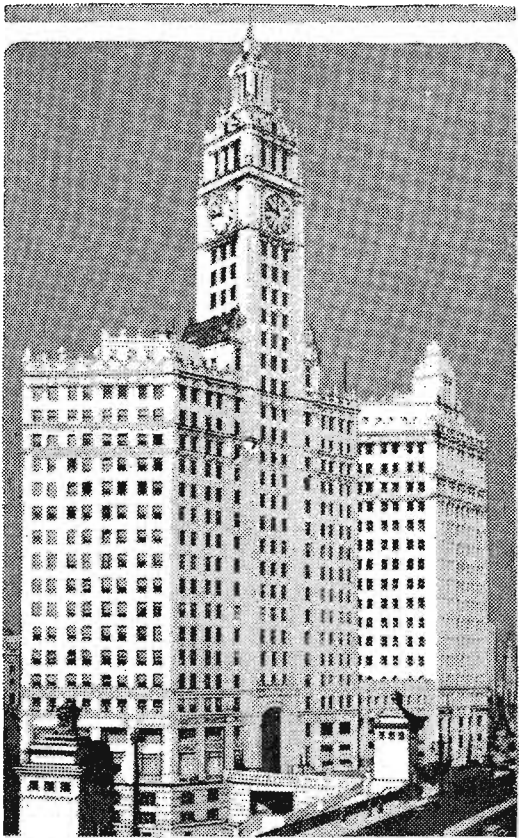

Chicago Link of the Mid Continent Chain

William H. Thompson, former mayor of Chicago; "Sport" U. J. Herrmann, theatrical magnate and proprietor of the Chicago Radio Show and New York Radio World's Fair, and William Wrigley, Jr., whose confection needs no introduction.

The Radiophone Broadcasting corporation was organized. The company bought eight acres of land at Deerfield, Ill., for the site of the transmitter. A brick structure was built to house the Western Electric 5-kilowatt "voice" and provide living quarters for the chief engineer and operators.

The palatial remote control studios and headquarters were located in the lower level of the north section of the Wrigley building, America's most spectacular skyscraper. A little theater was built to accommodate 100 fans who can view the broadcasting through plate glass as well as hear it reproduced by loud speakers. An organ especially designed and built for broadcasting at a cost of \$40,000 was installed. Studio facilities were made ample enough to accommodate a symphony orchestra or a full quota band.

As a result, when Chief Announcer Pat Barnes released his microphone control switch for the first time Saturday evening, April 28, this year, he introduced WHT to the world as one of the most complete and elaborate broadcasting units ever known.

housewives, mothers and business women. The lady announcer of WNAC became the woman's voice of WHT, and the West is glad while the East is sad. The Jean Sargent programs at WHT are all arranged by herself and cover every angle of service of interest to women. Thousands of women in the Middle West have joined the WHT Women's club, a Jean Sargent origination at WHT. Children know her as their Radio mother and when father is home in the daytime, he too, enjoys the pleasant and clear enunciating voice of Jean Sargent telling him how he can improve his usefulness around the house.

Paul Rader, noted evangelist, and his Radio chapel, fill the Sunday hours of WHT's time on the air with messages of good cheer and righteousness to one of the station's largest audiences. Heart-appealing letters, telling what good Paul Rader's sermons have done, fill

It takes a real showman to put programs such as WHT's on the air and his name is Charles Burke, right, head of the program department. His long service in entertainment and theatrical circles makes itself felt in talent quality.



Pat Barnes, left, chief announcer, made himself known all over the country, long before he took up Radio, with his wartime production "A Buck on Leave."



Jean Sargent is the "nom de Radio" of this pleasant lady to the right who has charge of all the women's programs and club work. Formerly at WNAC, Boston.

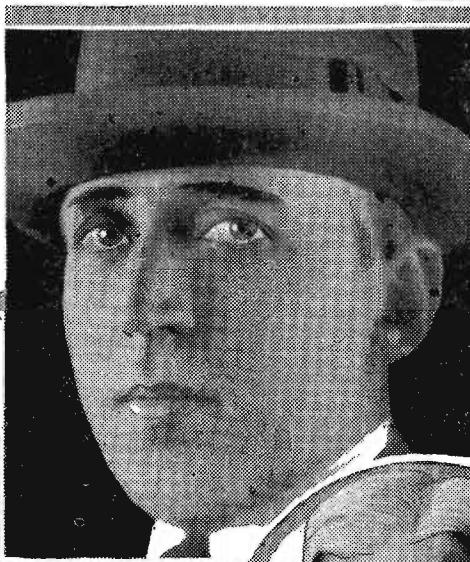

Right, Franklin C. E. Lundquist, WHT musical director.



Left, the "Smiling Tenor of Radio," Oscar Heather studio director and assistant announcer. Oscar is sure living up to his name in this picture. Below is John Clark, the assistant program director, who has built up a large rural following for the Wrigley building station, through his daily farm and market reports. Both gentlemen are able assistants to Mr. Burke.

The man at the right receives record mail.

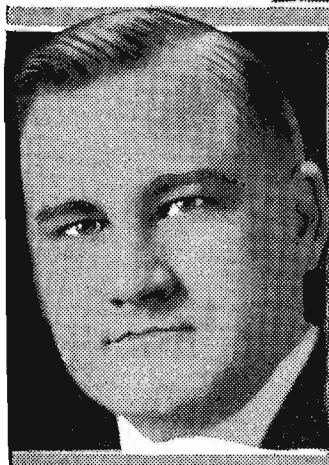

George E. Carlson, above, general manager of Station WHT.



Above, Al Carney, who delights at the wonder Kilgen studio organ.



Now to sketch the personnel behind the microphones:

The program department of a big Radio station is the open sesame to the people's hearts. Charles Burke, director and impresario, has been associated with theatrical and amusement enterprises all his life. His training is reflected in original and un-hackneyed programs with the presentation idea uppermost in the direction of all WHT arrangements. John Clark, assistant program director and in charge of commercial programs, has had a wide and diversified experience in the amusement field. A competent staff of assistants have been trained in the exacting requirements of the detail work of a large commercial toll station.

Supporting the program department in the presentation of its ideas and work is the announcer; the voice of the station. Officials of WHT travelled to the Pacific coast to sign up the chief announcer, Patrick Henry Barnes, native of Sharon, Pa., who at the time was scintillating in the glamour of the motion picture studios at Hollywood. When Mr. Barnes' signature was affixed to a WHT contract, the motion picture world lost a likely prospect for star honors, but millions of Radio listeners who have been entertained by the melodious sympathetic voice of the Pennsylvania Irishman, are thankful that the movies turned a trump card for Radio. All patriotic Americans remember Pat's A. E. F. delightful, original, wartime musical comedy, "A Buck on Leave." Assisting Mr. Barnes at the microphone is Oscar Heather, who carries the sobriquet of "Radio's Smiling Tenor." The appellation is as true as it is pleasing.

Women's activities claim a large share of modern Radio program arrangements and WHT went to Boston to sign "Jean Sargent," known from coast to coast as "The Mother of Broadcasting," because of continuous association with the microphone since the inception of broadcasting. WNAC at Boston was host to Miss Sargent for several years. Millions of New England women have profited by her counsel and suggestion on the multitude of problems affecting them as

ceivable kind of a shut-in—have told by telegraph and mail what inestimable value the Radio chapel holds for them.

The farmer receives from WHT all the complete information that a large station can furnish him. Under the direction of John Clark, farm editor, complete market and weather reports are broadcast which include several farm features exclusive to this station. The cattle men receive from WHT one of the most complete live stock reports broadcast. A special wire to the Bowles Commission company at the Union Stockyards carries the latest quotations to all in the dominant broadcasting zone of WHT, as well as the condition of the market and analytical forecasts. This service has saved cattle shippers many thousands of dollars—another tribute to the service of Radio.

A feature of the station that is known in thousands of homes is the daily noon complimentary organ recital played by Al Carney on the wonder Kilgen studio organ. Mr. Carney and Sears-Roebuck are both on unfriendly terms with the mail man because of the popularity of both institutions.

A recount of the activities of Station WHT would not be complete without mention of A. C. Nordberg, service manager. Here is a gentleman in the background, but as a contact man between the advertiser and the program department, his influence is concealed in everything that goes on the air.

Station WHT is ever alive to its obligations as an agency of public service and the support given public movements of merit has received the commendation of all of Chicago's civic leaders. By reason of a number of political personages being represented on the directorate, an idea has become prevalent that the station was founded to be used for certain political purposes. The directors have entirely dissipated this notion by publicly stating that WHT is non-partisan and non-sectarian, and that it will be ever the aim and purpose of the officials in charge to make the station one of the greatest on the American continent and in the world.

Station WHT might well be called the Radio monument to American patriotism. By choice their Chicago telephone number is State 1776. An American flag is always on prominent display in the studio. The first song sung over the microphone was "The Star Spangled Banner," the singer being Helen Freund, a born in Chicago opera star. When Al Carney plays (and he often does) Sousa's "Stars and Stripes Forever" many a veteran listening in gets up and passes in review. Every program is started with a stirring assembly call blown by an army bugler and when the station signs off at night, "Taps" the call that lulls our heroes to rest is heard. It is a fitting ceremony for use in signing off at a real American station such as is WHT, Chicago!

the mail bags delivered Mondays and Tuesdays to the station. This is truly a great and good work being done by Station WHT. Men on their death beds, cripples in their wheel chairs, paralytics unable to move a limb—every con-

THE · PERFECT · UNION · OF · ART · AND · SCIENCE

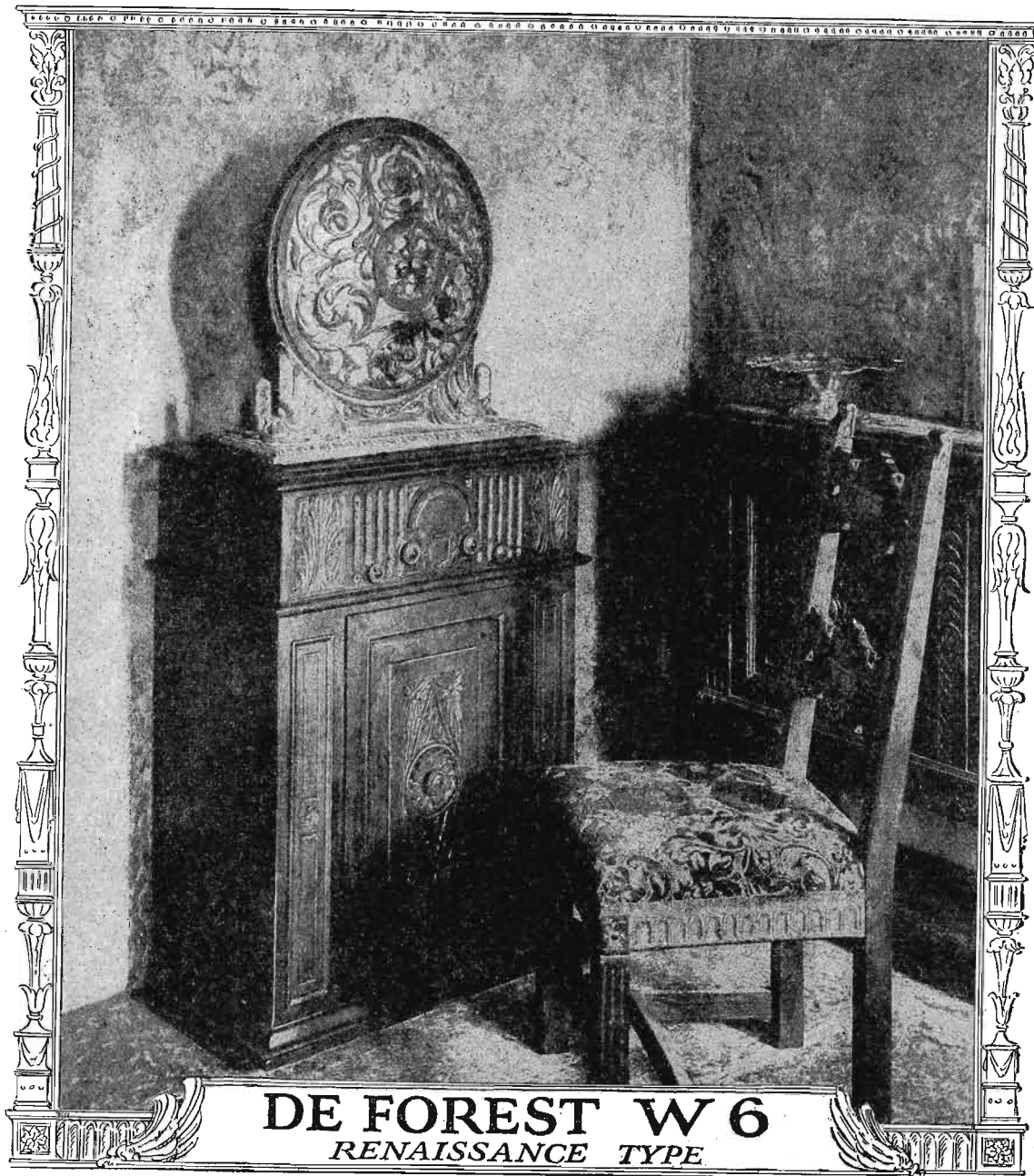

DE FOREST W 6
RENAISSANCE TYPE



DE FOREST AUDION

is the world standard in tubes. De Forest created the first successful radio tube, and his invention made broadcasting possible. The De Forest policy of a specific type tube for each socket insures finer reception and greater distance. Price, \$3.

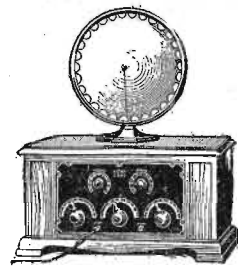

DE FOREST F-5 AW

A compact, powerful set in polished walnut that will bring joy to many a household. Gives rich volume, and has the capacity to separate stations positively so that you can pick the broadcast gems without interference. Extremely easy to operate. Price (minus tubes, loud speaker and batteries) \$90.

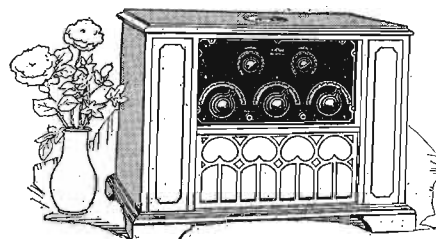

DE FOREST F-5 M

A superb 5-tube set in two color mahogany cabinet with built-in loud speaker and concealed compartments for "A" and "B" batteries. A great distance-getter, with uncanny power to tune in and out stations at will, and gifted with splendid tonal qualities. Extremely simple to operate. No howling or hissing in tuning in. An unsurpassed value at \$110.

De Forest Radio Sets can be bought at prices ranging from \$85 to \$450

De Forest Genius now Humanizes Radio!

MARVELOUS new circuit, just perfected, reproduces flawlessly the mellow, soft modulations of the human voice and captures the hitherto elusive overtones of the musical register . . . tuning simplified . . . a new ease in operation . . . all embodied in the new and beautiful De Forest W5 or W6 Radiophones.

The voice of radio is no longer flinty and metallic, but mellow, human and musical—thanks to the development by Roy A. Weagant, Vice-President and Chief Engineer of the De Forest Radio Company, of a new and marvelous circuit.

This ingenious circuit, and all the joy it means to radio lovers, makes its first public appearance in the De Forest W5 and W6 Radiophones, masterpieces of cabinet art worthy only of a scientific development so outstanding.

So wonderful is the reproduction of tone in the De Forest W5 or W6 that only the presence of the lovely instrument dispels the illusion that the living artist is in the rooms.

Piano chords come to you with their full rich resonance—true piano tone. High notes dance, ripple and sparkle . . . clearly, dis-

tinctly . . . musically! Those brooding low notes, never caught in average reception, are heard distinctly—as though from the next room.

In the reproduction of orchestral music the full importance of the De Forest achievement stands out. For the first time you get the overtones as well as the middle tones . . . the majestic roll of the kettle drums, the crooning of the bass viols, the strident crash of the brasses and the piping heraldry of the cornets and trombones. A symphony orchestra heard over the De Forest W5 or W6 stirs the soul. No incoherence, no oscillating jumble of noise—every instrument, every octave, in its true value. *A magic achievement!*

To the lover of dance music the De Forest W5 or W6 brings more sprightliness, more beauties of syncopation . . . you should hear Vincent Lopez, Joseph Knecht, The Night Hawks, or any others over either of these instruments!

All the tenderness of song, every shading of the soprano's voice, all the pathos of the folk song—exquisite but elusive elements so much desired but lost in practically all present-day reception, are captured by these De Forest masterpieces.

To everything that is broadcast, the De Forest Radiophone gives animation, life and humanness.

But Tonal Supremacy is Not All—

Elbert McGran Jackson, renowned sculptor, architect and painter, put into this hand-wrought, hand-carved cabinet the spirit of radio, in design, in motif—it is not an adaptation of a phonograph. An image of charming individuality, it harmonizes with the setting of any home.

One unit, everything self-contained—not a wire in sight, nothing to connect . . . and portable; move it any place! Only charm and beauty for the eye.

The artistic conical reproducer is an inseparable part of the cabinet and its tonal mechanism peerlessly attuned to that of the Weagant circuit. There are just two controls for tuning, and these operate on one dial, which makes the normally perplexing task of "tuning in" extremely simple. There are special power tubes in the fifth and sixth sockets which can give you volume to flood an auditorium, if you desire it. And, at your fingers' tips, the means to tune in a far-distant station you want no matter how powerful nearby stations may be.

See the incomparable De Forest W5 and W6 at your De Forest dealer's or write for an interesting booklet describing these masterpieces in detail.

DE FOREST RADIO COMPANY, Jersey City, N.J.

DE FOREST *The Greatest Name in Radio*

DEALERS IN ALL CITIES AND RADIO COMMUNITIES

THE EPOCH-MAKING ACHIEVEMENT WHICH MAKES ORDINARY RADIO RECEPTION A THING OF YESTERDAY

THIS LINE OF BEAUTY HELPED WAHG CELEBRATE ITS FIRST BIRTHDAY



There were great doings around Richmond Hill on Long Island when WAHG, the Grebe station there, celebrated its first anniversary and the entire staff had a great time as did those listening in on the program. Although the music that came over the air was real pretty, Mr. Jenkin's recent Radio vision invention would have added more beauty to the receiving end as is evidenced by the group above. They are, from left to right, Madelyn Marshall Simon, pianist; Willa Webb, banjoist; Martha Brauniger, soprano; Milly Munz, saxophonist; Bess Bowman, pianist; Fern Follis, contralto, and Genevieve Williams, soprano.

The arrival of the cross-channel boat at Folkestone, Eng., from France is soon to be relayed from 2LO. The usual noises accompanying the arrival of the boat will be transmitted, and a specially written sketch will be included in addition.

MENCKEN IS SUCKER AND WEASEL—WLS

SAGE OF BALTIMORE IS HIT HARD BY FARM LEADER

Samuel S. Guard Asserts "Ignorant Critic Trips Countrymen and Maidens Into Inferiority Complex"

CHICAGO.—A terrific indictment of what he termed "work of the weasel-writers" in sapping the faith of country people in the dignity and charm of farm life, was voiced on a recent Sunday night from the Radio forum of the Little Brown church, by Samuel S. Guard, director of the Sears-Roebuck Agricultural foundation, in his talk from WLS, here.

Referring particularly to H. L. Mencken, and his comments on "The Decay of Idealism," Mr. Guard said:

"It is not what Mencken says about the jazz age in the open country that hurts, so much as the subtle attack upon rural character that is veiled under his quips and gibes. And that, I claim, is the most dastardly work of all—the assassination of character, the assault upon one's faith in himself and appreciation of his own life.

Mencken Is Weasel and Sucker

"The truth never hurt anybody. It is not because he speaks the truth that H. L. Mencken is to be feared. It is because his indictment is false; it is because he draws innuendo against all that is good and sweet and lovely in country life that he is to be shamed.

"Such minds as his seem utterly incapable of grasping the real significance of the country character, of plumbing the depths of a silent farmer's soul, of visualizing the strength of the ties of partnership between the landman and God. I could diatribe against Mencken as an evil influence because he slips up behind and trips our countrymen and maidens into an inferiority complex on their own sunlit and wind-kissed lives. I could rail at him and make him ridiculous.

"But I will content myself with the bald statement that he is a weasel in the outdoors or a sucker in the pond. He saps a good farmer's respect for himself and his people; he makes him ashamed and afeared, until he remembers the life and struggles of a real man in the out-of-doors."

Jump All Over Town to Observe KNX Birthday

KNX Transmits from Ten Different Points on Anniversary

LOS ANGELES.—Probably one of the most unique programs ever broadcast was that recently put on by KNX, Hollywood, on its first birthday.

Starting at 7:30 in the morning in the wilds of mountainous city park, the KNX staff of announcers, entertainers and a host of friends put on a traveling program lasting until 2 a. m. the next morning. The itinerary was as follows: 7:30 a. m., setting up exercises in Griffith park; 9, program from Echo park; 10, Town Crier's morning message from Sycamore Grove; 11, Kate Brew Vaughn at Lincoln park; 12 noon, downtown in the Wurlitzer studio; 1 p. m., program from Hollenbeck park; 2, program from South park; 3, program from Exposition park; 4, program from Westlake park; 5 to 2 a. m., in the studio, where open house was held and a dance attended by a number of motion picture stars.

This unusual feat, unusual at this time although it will probably be a very common occurrence a year from today, was possible only through the means of KNX's new portable input equipment, by which it is possible for two men to pick up and carry all the paraphernalia necessary to broadcast and which can be used in conjunction with any telephone line, and a new short wave mobile transmitter broadcasting on 108 meters under the call of 6XA.

ATWATER KENT RADIO

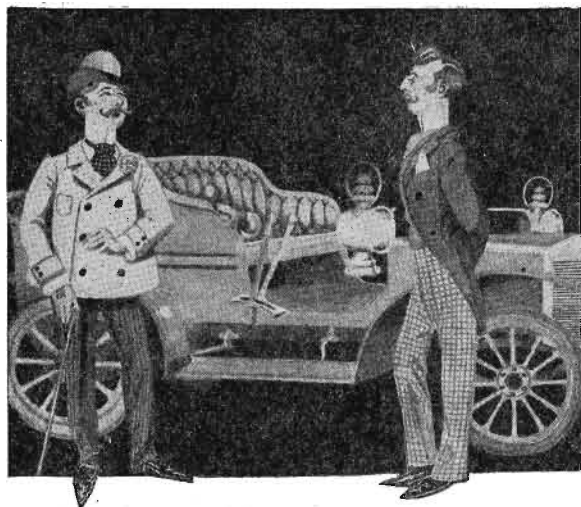

"How fast will it go?"

The early automobile manufacturer had just one question to answer: "How fast will it go?"

Today the prospective purchaser looks for an all-round car, a car that runs swiftly and smoothly and silently and economically.

Many people today ask of radio simply: "How much distance will it get?" That is unwise.

It is time to assume that a good radio will get good distance. It is time to demand an all-round set—a set that will get tone and volume and distance and selectivity and clear reception.

Every Atwater Kent Radio Receiving Set is that kind. No one feature has been sacrificed to over emphasize another.

The Atwater Kent is the radio of today—and tomorrow. It is the all-round radio.

Hear the Atwater Kent Radio Artists every Sunday evening at 9.15 o'clock (Eastern Standard Time) through stations—

- WEAF . . . New York
WJAR . . . Providence
WEEL . . . Boston
WFI } . . . Philadelphia
WOO } . . . alternating
WCAE . . . Pittsburgh
WGR . . . Buffalo
WWJ . . . Detroit
WOC . . . Davenport
WSAI . . . Cincinnati
WCAP . . . Washington
WTAG . . . Worcester
KSD . . . St. Louis
WCCO . . . Minn.-St. Paul

Write for illustrated booklet telling the story of Atwater Kent Radio

ATWATER KENT MANUFACTURING CO.
A. Atwater Kent, President
4708 WISSAHICKON AVENUE PHILADELPHIA, PA.



Model R, \$12



Model H, \$22



Model 12 (without tubes), \$100

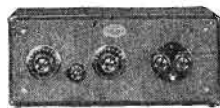

Model 19, \$60

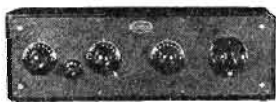

Model 20, \$80

Prices slightly higher from the Rockies west, and in Canada



Model L, \$17



Model M, \$28



Model 10 (without tubes), \$80



Model 20 Compact, \$80

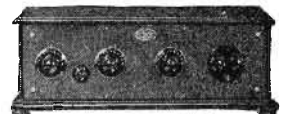

Model 24, \$100

Prices slightly higher from the Rockies west, and in Canada

MUSIC MASTER SUPREME!

—as in Reproduction, so in Reception ●

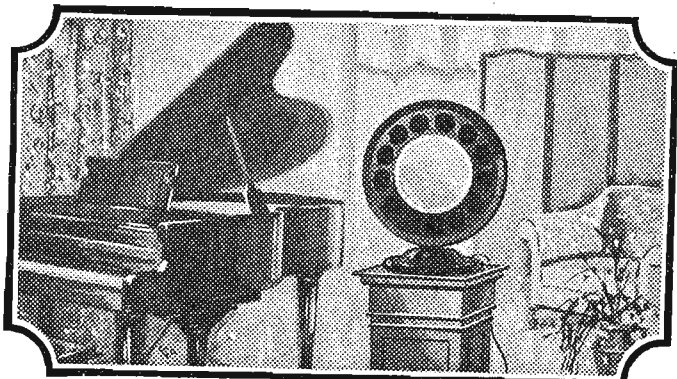

Played, Sung or Spoken before the Microphone—

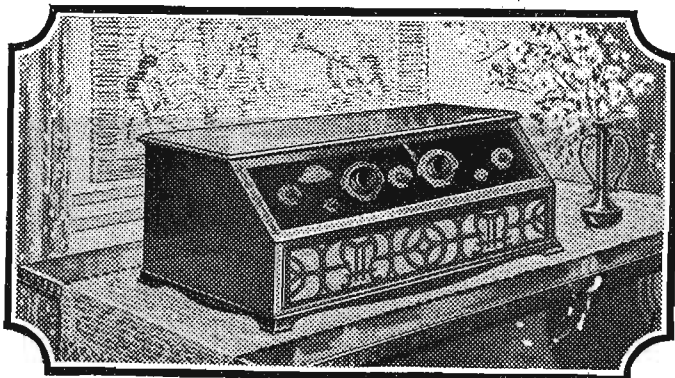

Music Master's Sensitive Mechanism Receives



Endues with Power, Clarity and Volume

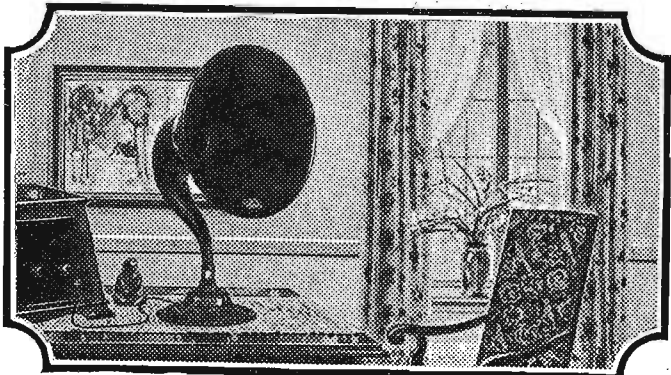

Music Master Resonant Wood Insures Natural Tone Quality

WITH a really effective receiving mechanism between broadcasting studio and Music Master Reproducer, today's wonderful New Era super-program is brought in and delivered with splendid fidelity of effect and naturalness of original tone.

Music Master Radio Receivers, each the supreme of its type, incorporate every demonstrated principle of standard radio reception and reproduction.

Music Master Receivers are the successful result of the effort to develop radio reception equal in efficiency to the world-standard quality of radio reproduction achieved in Music Master Reproducer.

Today, the Music Master Radio ensemble makes perfectly balanced radio reception and reproduction available to discriminating radio lovers.

Ask any authorized MUSIC MASTER dealer to demonstrate for you what clarity in reception may really be—what distance range is really available—what selectivity really means. See MUSIC MASTER—hear—compare—before you buy any radio set.

TYPE 60

Five tubes. Special Music Master design. Full, round, natural tone. Three selectors for precise tuning. Without equipment.

Price, \$60

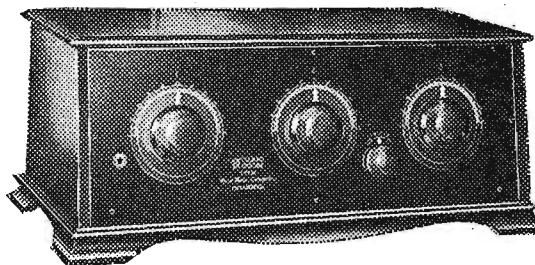

Ten Models—\$50 to \$460—Unconditionally Guaranteed

TYPE 100

Five tubes. Resonant reproduction. Exceptional range. Massive mahogany console cabinet. "B" battery compartments in cabinet. Without equipment.

Price, \$100

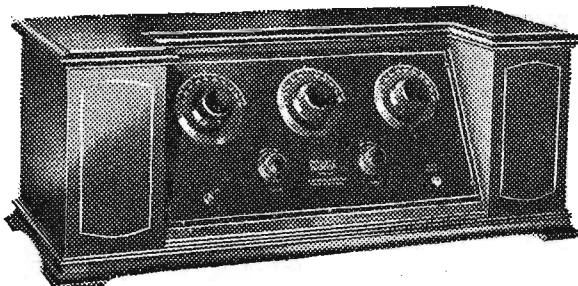

Music Master Corporation

Makers and Distributors of High-Grade Radio Apparatus

128-130 N. Tenth Street

PHILADELPHIA

CHICAGO

PITTSBURGH

NEW YORK

MUSIC  **MASTER**
RADIO PRODUCTS

NEWS BRIEFS FROM THE BROADCASTERS

WASHINGTON GIVES CUP TO WRC ANNOUNCER ROSS

WLS Woodshed Theater Reopens With "Punch and Judy"—Donald MacMillan Speaks from Chain

George F. Ross, announcer at WRC for the past year and a half, has been voted the most popular announcer in the United States capital in a ballot taken during the Washington Radio show. Mr. Ross received a total of 112,000 votes, and was presented with a silver loving cup as a token of his success.

The 1925-26 season of the Woodshed theater of WLS, Chicago, reopens Thursday, November 5, with a "Punch and Judy" show. The dramatic personnel is composed of old-time Radio players, the same group of kiddies who acted last season in the plays of Ford and Glenn. Season tickets for "air seats" may be obtained as before for five plain pins or one safety pin.

Donald MacMillan, Arctic explorer, will speak Sunday night, November 1, from WEAF and chain. His address was announced for October 18, but he did not arrive in this country in time.

The music of four of Chicago's best-known dance orchestras is now being broadcast nightly by WBBM, Chicago. The orchestras are: Henri Gendrom's Montmartre cafe syncopation orchestra, James Wade's Moulin Rouge syncopators, Bill Tucker's Merry Garden All-Stars and Gibson's Valentino inn syncopators.

Although the new KPO "Daily Dozen" health exercises, under the direction of Willy Winsor, executive secretary of the local Y. M. C. A., have been on the air but three weeks more than 5,000 illustrative charts have already been mailed to Radio fans.

Nate Caldwell, the "minstrel of Radio" and chief announcer of WBBM, Chicago, was the voice of the Southwest Radio exposition which was held recently at St. Louis. Mr. Caldwell was sent to St. Louis through the courtesy of the Stewart-Warner corporation.

Lambdin Kay, who has been the "Voice of the South" for four years at WSB, Atlanta, was the guest announcer at WLS, Chicago, last week, while George Hay was visiting WFAA, Dallas. Mr. Kay, one of the pioneer announcers, is known to the Radio world as "The Little Colonel."

Education by Radio, synchronized with the clock, is the new form of the KGO educational broadcast, Monday evening, November 2. At 8:10, Pacific time, there will be a talk on "Physical Culture"; fifteen minutes later, "Government—the Declaration of Independence and the Formation of the Confederation," will be the subject; 8:45 will usher in a talk on constructive selling, "The Human Element in Industry"; at 9:05, the best "Books of the Week" will be reviewed; at 9:30 it will be shown that "It Pays to Analyze Character"; and at 9:45, a speaker with a message from the "National Farm Radio Council" will be heard.

Davis saxophone octette, which is broadcasting through WEAF, WCAE and WOO on Tuesdays, at 7:30 p. m., eastern time, is presenting each week an unusual program of saxophone ensemble and solo numbers. Clyde Doerr, the leader of the octette, will play many of his own compositions.

Since October 8 WFAA has had its studios on the eighteenth floor of the New Baker hotel. The headquarters are delightfully equipped and arranged, and are one of the show places of the city.

Max Eisenberg, Victor recording artist, will be the soloist with the Arcadia Cafe concert orchestra, Sunday afternoon, at WLIT. Mr. Eisenberg will sing arias from several well-known operas.

Judge Florence E. Allen of the Ohio Supreme court will broadcast from Westinghouse Station KDKA Saturday evening, November 7, a talk on the subject of world peace. Judge Allen will speak at the banquet of the Business and Professional Women's club of Pittsburgh, and her address will be broadcast by the station.

After a long summer vacation, Bill Benning's Milwaukee Athletic club orchestra is on the air again with the Marquette University-Milwaukee Journal station, WHAD. The orchestra plays regularly from 6 to 7 p. m., central time, on Mondays, Tuesdays and Thursdays.

Old Time Fiddlers to Reach for New Zealand

Hundred-Watt Will Put on Special Program

AMARILLO, Tex.—An unusual program has been arranged at Station WDAG here, to be broadcast from 4:30 a. m. to 6 a. m., central time, the morning of October 31.

Tom Jameson and his old time fiddlers, one of the favorite groups of musicians entertaining frequently from Station WDAG, will come on the air at 4:30 a. m. furnishing music for a program that J. L. Martin, owner of the station, hopes will reach far into the Pacific ocean with New Zealand as his goal.

He says that by the use of a special designed transmitter tuning element, he has been able to reach the New England states on but ten watts of oscillating energy. That was two years ago and since that time Station WDAG has raised to 100 watts with very encouraging response from the entire United States.

JAZZ VOTE AROUSES KOA MUSIC CRITICS

SOME FAVOR, OTHERS CONDEMN SYNCOPATION ERA

"Jazz Appeals to Baser Tastes"—One View; "It Promotes Self Expression"—Says Another

DENVER.—Jazz is jungle music, releasing savage emotions—

Jazz promotes self expression and awakens higher ideals—

Such conflicting opinions as these, now pouring into KOA at Denver, disclose, it is said, the extent of a widening breach between jazz and the classical, following the announcement that the Rocky Mountain station of the General Electric company is arranging a musical battle between exponents of the two schools on Friday, November 6.

"Jazz stimulates unwholesome reac-

tions, is subject to sinful interpretations and should be ruled out," declares Dr. David H. Fouse, prominent western cleric, as spokesman for the anti-jazz camp. "It appeals to the baser tastes."

While admitting that a "tin-can" tempo with its wash-boiler effects has a demoralizing influence and appeals to animal instincts, Dr. Rolland M. Shreves, vice-president of the Central Vocational college, of Denver, asserts that well-modulated jazz is desirable.

"It arouses a sense of harmony and balance, enables men to gain a new appreciation of their individual capacities and awakens higher ideals," he emphasizes. "Music of this type causes listeners to feel complete adjustment to life."

Broadcast listeners from coast to coast are to judge KOA's novel musical struggle and are to be given opportunity to vote their choice. These votes will be compiled by states and sexes.

It is estimated that a voice speaking into a microphone of the average broadcasting station is amplified 50,000,000 times by the time it reaches the ear of the listener.



You and Reichmann

Sales demand or mere popular enthusiasm for something new has never swerved Reichmann Company from building only the kind of radio that *should* be owned by anybody.

You cannot go to a radio show or talk to radio experts without hearing of what Reichmann has done in the Thorola Isodyne. There are very exact reasons why it is the positively selective, precise-toned, uniformly produced set with correspondingly superior volume and distance. This is due not merely to the much-acclaimed theories of toroid coils, but to the unique low-loss structural properties exclusive to Thorola Low-Loss Doughnut Coils.

Consider also the indirect effects! By eliminating coil vexations and variables it was possible to attack

factors which had been overshadowed by the coils. New control was gained over the elements of reception and of production!

New standards of radio entertainment have become possible. Everywhere, this is massing preference behind Thorola Isodyne receivers. They are the advance of the year in broadcast reception, with mathematically exact reasons for every claim. The proof is equally convincing from the scientific standpoint, or "by ear." The very proportions of Thorola cabinets bespeak new internal arrangement. Go and see Thorola at the show. Go and hear Thorola Isodyne at the nearest good radio store.

It is the one way to make sure of owning radio that will stay far in advance. REICHMANN COMPANY, 1725-39 West 74th St., CHICAGO

THOROLA SPEAKERS

With vital technical refinements including the self-harmonizing feature, Thorola Loud Speakers increase their margin of leadership. The new Bakelite bell is the largest Bakelite form ever produced. The ingenious throat construction, and identifying gold throat-band lend inspiring grace and rugged strength.

- Thorola No. 4, \$25
- Thorola Junior, \$15



Thorola Low-Loss Doughnut Coils Set of 3, \$12 Per Coil, \$4

Thorola Low-Loss Straight Line Frequency Condensers, \$5.50 & \$6

Thorola Isodyne (5-tube) Walnut Cabinet, \$100 Model 55

In Thorocco, \$85 Model 50

In Mahogany, \$85 Model 51

Thorola Isodyne Console, \$225 Model 52

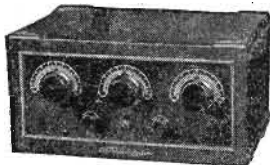



Thorola Golden Audio Reproducing Transformers, \$4.50

Stewart-Warner

Matched-Unit Radio

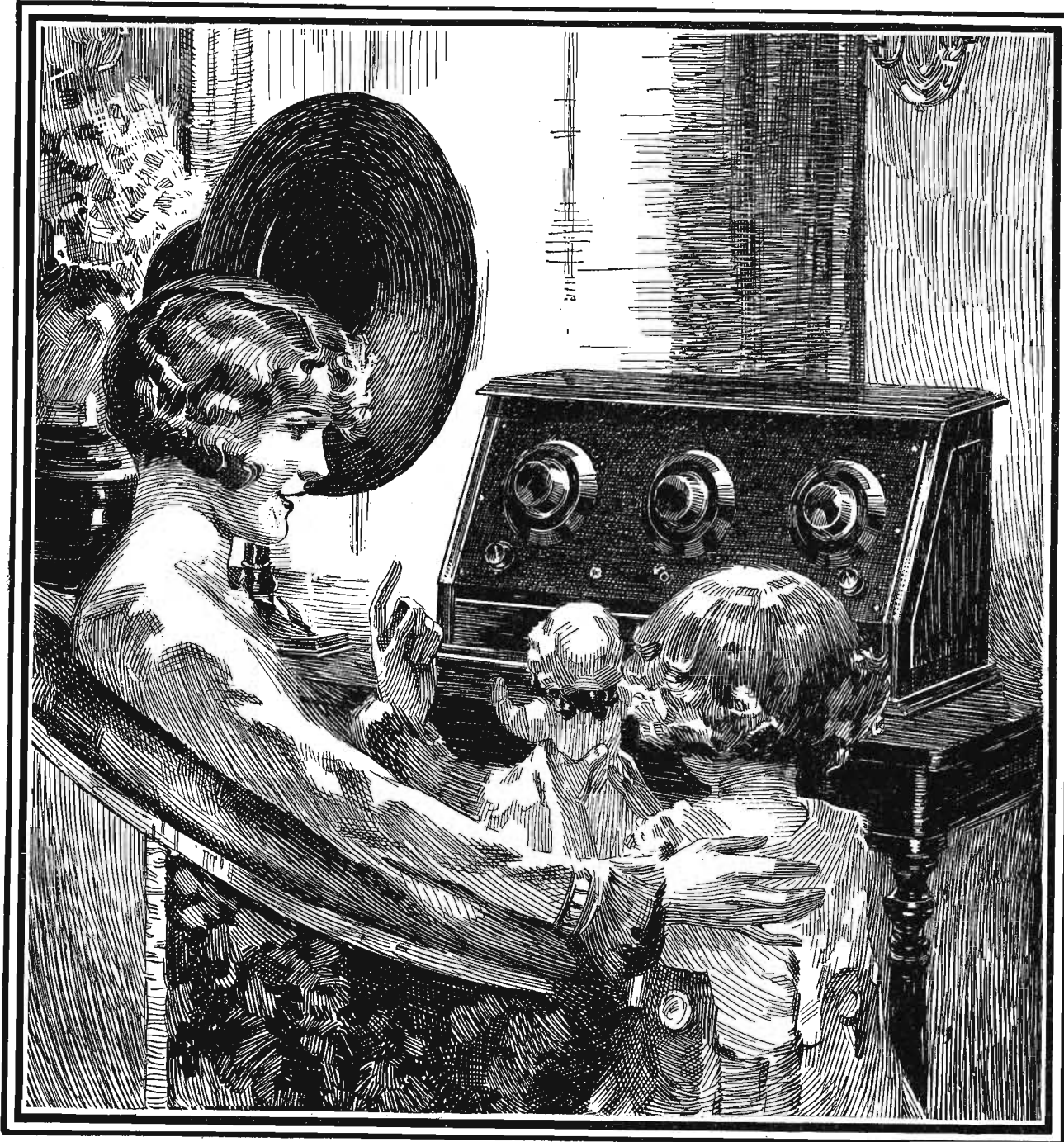
INSTRUMENTS TUBES REPRODUCERS ACCESSORIES





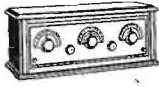

Model 300—\$65.00

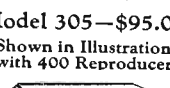

Model 325—\$80.00



Model 305—\$95.00
Shown in Illustration with 400 Reproducer



Model 505—\$22.50
Radio Table with storage space for batteries



Model 410
\$65.00
Console Table including Built-in Speaker and Battery Compartment, without Radio



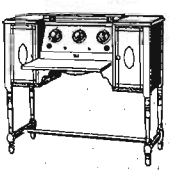

Model 310—\$175.00

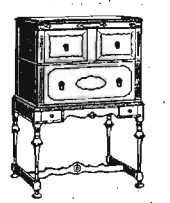

Model 315—\$285.00



Model 320—\$450.00

Model 400 Reproducer \$25.00 Model S.W. 501-A \$2.50
Model 405 \$19.50

OVER ten million people are already familiar with the high quality of Stewart-Warner products, through actual usage. They know that the Stewart-Warner name placed on an article means that it is the best that can be produced.

By purchasing a Stewart-Warner Matched-Unit Radio you receive the benefit of our manufacturing experience of over twenty years and the unlimited resources necessary to build a product that is backed by the broadest guarantee known. You are absolutely protected. You take no chance.

The reception that you have always hoped for is made possible by the Matched-Unit Idea.

What We Mean By Matched-Unit

By the matched-unit idea we simply mean that we have not only designed and perfected each individual unit, the Instrument, the Tube, the Reproducer, and the Accessories—but in addition we have matched

these units to function together in perfect unison. Complete radio satisfaction every hour of the day—every day of the year, is the result.

Simplified Tuning

You do not need to know anything about radio to get so-called "unusual" results.

The master wave length dial shows the exact settings for the desired program. Select your entertainment direct from the radio programs. No log necessary. Nothing could be easier.

See Your Dealer

Your authorized Stewart-Warner dealer is a qualified radio expert. His job is to keep you satisfied. He assumes the responsibility for the constant operation of your set. You simply enjoy it.

Make your selection now from our complete line. See your dealer today.

STEWART-WARNER SPEEDOMETER CORPORATION - CHICAGO, U. S. A.

Tune-in Stewart-Warner programs, Station WBBM 226 meters

Mon. 6-7 p.m. Thu. 9-10 p.m.
Tue. 10-12 p.m. Fri. 8-10 p.m.
Wed. 12-2 a.m. Sat. 11-1 a.m.
Sun. 4-6 p.m.
Chicago Time

FAMOUS ARTISTS TO GIVE RADIO NEW ERA

STEINWAY STARS PRESENT BROADCASTS OF QUALITY

Contribute Programs to the Cause of Greater Music Appreciation Among American People

NEW YORK.—A new era in broadcasting, of the utmost significance to millions of music lovers in the United States, is forecast by the recent announcement of Steinway and Sons that a series of concerts and recitals by such world-famous artists and conductors as Josef Hofmann, Walter Damrosch, Mme. Schumann-Heink, Mengelberg, and others would be broadcast by Radio, beginning Tuesday, October 27.

The programs will be contributed by Steinway and Sons to the cause of greater music appreciation in the United States.

Although famous pianists and other great concert artists have been heard over the air on a number of occasions during the past two years, the Steinway series marks the inauguration of the first complete programs to be contributed by the conservative musical interests of the country, in which the greatest masters of the piano, the violin, and concert hall will participate. For the first time, also, concerts of this character will be broadcast in full recital form, just as those rendered by the great artists to select audiences of music lovers throughout the country.

Three Stations to Broadcast

The concerts will be broadcast by stations of the Radio corporation of America and its associates from WJZ, New York; WRC, Washington, and WGY, Schenectady.

In an address broadcast to thousands

of Radio listeners, Ernest Urchs of Steinway and Sons told how his company had arrived at the decision to contribute to the broadcasting service of the country.

"We believe," he said, "in making available to the public through the agency of Radio the series of concerts announced, that we will create and develop an appreciation of the highest type of musical entertainment. While the concert hall has a very definite function in the scheme of things musical, Radio should supplement the concert hall in a way which could prove of benefit to us by benefiting the public.

Saw Possibilities Only Recently

"I must confess that Radio's significance—its influence as an instrument of public service—had not stirred me with its possibilities until a few months ago. It is said that upon this occasion thousands of people, scattered over several states, living in palatial homes and humble dwellings, are listening to my remarks. This experience brings me face to face with the practical significance of modern-day broadcasting and its vast potentialities."

Mr. Urchs then proceeded to describe the first six concerts of the Steinway series already scheduled. These will be as follows:

TUESDAY, OCTOBER 27

William Mengelberg, the noted guest conductor of the Philharmonic orchestra, will direct the first concert program to be broadcast from Steinway hall.

Josef Hofmann, the world-famous pianist, will give a piano recital.

A special festival hymn, composed by Mr. Mengelberg for orchestra and baritone solo, will be rendered for the first

time in America. Fraser Gange, well known for his renditions of oratoric music, will be the soloist.

SUNDAY, NOVEMBER 8

Walter Damrosch, the great American composer and conductor, will be the pianist-conductor in a notable performance of the Kreutzer Sonata for piano and violin, to be broadcast from Steinway hall. Paul Kochanski will play the violin part as arranged by Mr. Damrosch, accompanied by the Steinway string orchestra.

The second part of the program will be a short violin recital by Paul Kochanski, who has risen to stardom during the past two seasons.

FRIDAY, DECEMBER 4

Mme. Schumann-Heink, recognized as the world's greatest contralto, will be featured in a song recital.

Other Concerts and Recitals

In addition, there will be interspersed during this period the following other concerts and recitals to be broadcast by stations of the Radio Corporation of America and the General Electric company:

MONDAY, NOVEMBER 2

The Mengelberg Festival hymn will be repeated at Steinway hall with Fraser Gange as soloist.

The second part of the program will be given up to a piano recital by Ernest Hutcheson, the internationally-known English pianist.

WEDNESDAY, NOVEMBER 4

The Elshuco trio, Willem Willecke, cellist; William Kroil, violinist, and Aurelio Giorni, pianist will give a program of chamber music.

FRIDAY, NOVEMBER 6

Joint recital by Messrs. Guy Maier and Lee Pattison for two pianos. Messrs. Maier and Pattison are the world's most

RADIO FIRE CALL AIDS FIGHT TO SAVE TOWN

WGBU Sends Out Call After Telephone Fails

MIAMI, Fla.—Radio saved lives and property Tuesday night at Fulford, Fla., when the Alabama hotel was destroyed by fire of unknown origin with an estimated loss of one hundred thousand dollars. The only telephone in the old town site of Fulford was enveloped in flames when the fire was discovered and a messenger rushed the news of the fire to Radio Station WGBU, broadcasting on 278 meters and located at Fulford-by-the-Sea, a half mile away from the disaster.

Four calls a minute apart were sent out over the air asking Radio fans to notify and Miami fire department twelve miles away.

In less than seventeen minutes engines from Miami and also from Fort Lauderdale were on the scene as the result of this Radio fire call and prevented the spreading of the blaze.

Harold McCray was in charge of the mike at the time the call for help was broadcast over WGBU.

eminent exponents of two-piano recitals.

Indicative of the complete form in which the concerts and recitals are to be broadcast is the allotment from 8:30 to 10:00 p. m. eastern time for each performance.

The Wilson "B" Radiopower Unit

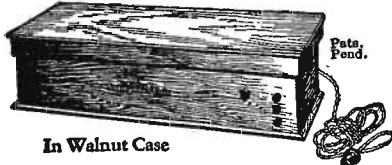

Operates from light socket. Supplies the uniform voltage necessary for perfect reception. Absolutely noiseless. Guaranteed not to set up the slightest hum. No acid to spill. No moving parts to get out of order. Requires no attention. As easy to operate as switching on a light. Convenient and dependable. The least expensive plate current supply because of its long life. In handsome walnut case. Price complete, \$35. Your dealer can supply you.

The Andrews Paddlewheel Coil



Improves tone quality. Increases selectivity, range and volume. Losses are negligible. Has exceptionally high ratio of inductance to resistance with minimum distributed capacity.

Used in well-known receivers such as the Deresnadyne and Buckingham. Can be used in any standard hook-up. Ask your dealer for blue-prints of circuits employing this coil. Our Technical Dept. will answer inquiries.

Duo-Spiral Folding Loop

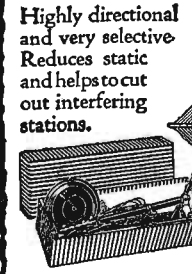

Highly directional and very selective. Reduces static and helps to cut out interfering stations. Price \$8.50

Handsomely finished in silver and mahogany. Easily portable. Has long handle and graduated dial. A special model for every circuit. See these standard units at your dealer's or write for complete information.

Radio Units Inc. Maywood, Illinois 1306 First Avenue Perkins Elect. Ltd., Montreal, Toronto, Winnipeg

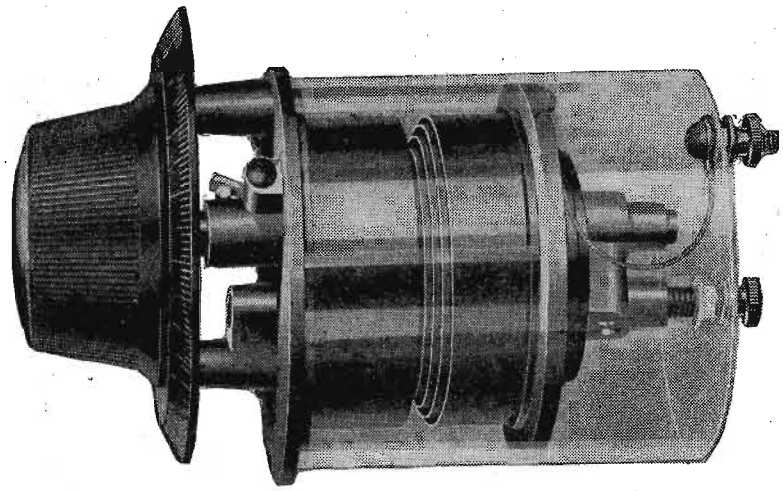

PATENTS PENDING

The Most Talked-Of Condenser In Radio Today

At the recent Radio Shows in New York—wherever it has been shown or demonstrated—the Furnell Taper Coil Condenser aroused a veritable furore of interest.

Mechanically and electrically, professionals claim that the Furnell Condenser offers in the simplest, most practical form, the correct solution of the straightline frequency problem.

By the use of the Furnell Condenser, the crowding of low-wave stations is entirely done away with. Regardless of wavelength, all stations are tuned in with remarkable ease and clarity, over a complete revolution of the 360° dial.

Only two plates are used in the Furnell Condenser. Each plate is in the form of an evolute coil, like an unwound clock spring. The rotor coil is tapered and made to mesh and align perfectly with the stator

coil, through a sliding motion, on a spiral worm rotor shaft.

The unique method of meshing the rotor and stator coils, affords a wonderful smoothness of operation and a precision in tuning, impossible with the old type of condenser, while it eliminates all necessity for a vernier.

And to insure its permanent accuracy and precision, under all working conditions, the Furnell Condenser is entirely enclosed in an attractive, strong, transparent Pyralin case. This shield insures absolute protection against dust, moisture and damage.

No matter what type or model you build, buy, or sell, you can't know its best performance until you use this wonderfully improved type of condenser. In three capacities, single and multiple.

WRITE FOR LITERATURE

Furnell Condensers will not be ready for sales distribution until December. We invite your interest in awaiting this new and radical condenser achievement.

A nation-wide organization of exclusive Sales Distributors is now being established. Write or wire for plans and particulars.

THE FURNELL MANUFACTURING CORP., 889M Broad St., Newark, N. J.

FURNELL 360° TAPER COIL CONDENSERS

Again They said
it couldn't be done!

Here it is

New and Improved
**FRESHMAN
MASTERPIECE**

But now . . .

Complete with built-in loud speaker of great volume and superb tone quality.

Encased in . . .

As fine a heavy genuine solid mahogany cabinet as ever graced any radio set.

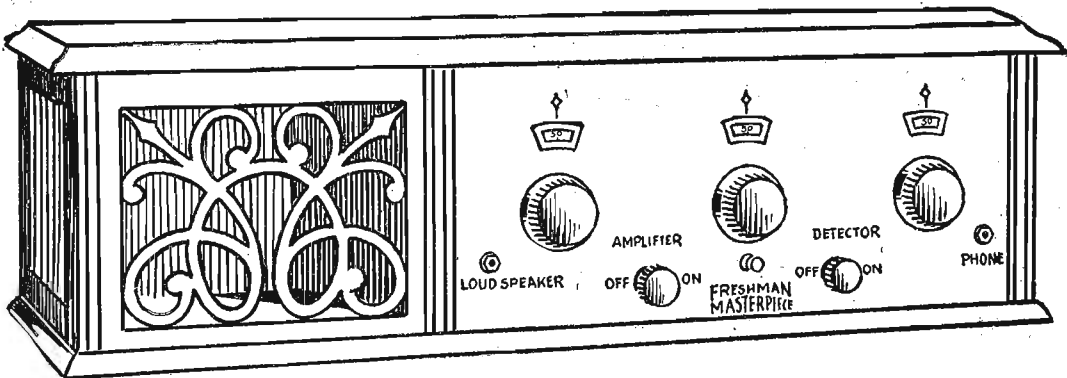

Model
5-F-5

\$60

*Slightly higher
Denver and West*

At sixty dollars . . .

Not only complete with built-in loud speaker and massive mahogany cabinet, but this wonder circuit has been scientifically perfected and each and every single part strengthened and co-ordinated.

For example . . .

The new Freshman Masterpiece straightline wave length condenser with vernier attachment which assures hair-line selectivity—permitting you to tune in the station you want without interference over the entire wave length range. This is merely one exclusive feature of the

World's Greatest Radio Receiver

For Sale at AUTHORIZED FRESHMAN dealers only

Sold on convenient terms by Authorized Freshman Dealers, who also install and service them. Write for illustrated booklet, containing lots of useful information for all radio fans.

CHAS. FRESHMAN CO., INC.
240 W. 40th St. New York
2626 W. Washington Blvd., Chicago

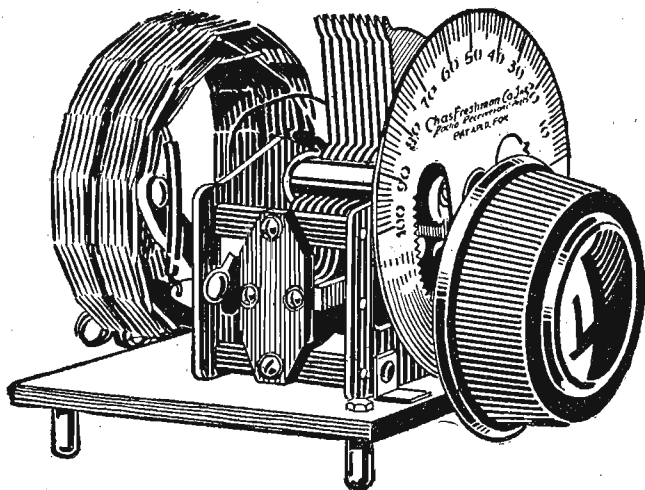

Radio Nature League Membership Is Large

Unusual Interest Displayed in Burgess WBZ Talk

SPRINGFIELD, Mass.—Few movements of national importance have created the unusual interest which is being evidenced in the Burgess Radio Nature league, one of the weekly features of Westinghouse Station WBZ.

Since the start of the league last January, as the outgrowth and development of the first nature talks broadcast by Mr. Burgess, the organization has grown in leaps and bounds and the total membership now exceeds 25,000. Entire schools, societies and organizations have enrolled in this nature league.

Under the direction of Thornton W. Burgess, nationally prominent naturalist and nature story author, it has proved one of the most efficient factors, through the medium of Radio with its far-reaching scope, in the determined effort to counteract the widespread destruction of wild life.

RADIO VISION IN HOME

(Continued from page 1)
by the rapid movement and the flickering of a single, tiny spot of light, but it is.

Cost of Vision Device
"The apparatus for Radio vision is very simple; a little box, plugged into your Radio set like a loud speaker, containing a small motor and flickering light is all. This motion picture attachment will probably cost from \$65 to \$85. We will also make Radio sets with the picture unit built in, like a loud speaker is often built into the set. This Radio picture set will cost, say \$150 to \$200. Where both the music and the action is desired on the same Radio receiver an additional hundred dollars will probably be charged.

"Just what returns may be expected when Radio vision and Radio movies are combined is problematical, of course, but when the intriguing mystery of Radio is joined to the fascinating pantomime picture in home entertainment, with a popular-priced article, the profits of such a service are assured.

"On June 13, last, this new thing was publicly demonstrated when Secretary Curtis D. Wilbur and others saw in my Washington laboratory what was actually happening at the time in the Anacostia naval air station several miles away.

"So it is an accomplished fact, and obviously, therefore, refinement is all that remains to be done before you will be able to see reproduced on a small white screen in your home what is then actually happening at a great distance."

MUSIC TRUST TIGHTENS

(Continued from page 1)
of the society, it brings out another side to the question.

C. R. Belknap, attorney for the society, issued notices on broadcasters that they would be allowed to finish out present contracts, before the new fees would be exacted.

WTAM Forced to Quit Pickups
CLEVELAND.—All remote control or pickup broadcasting over WTAM, Cleveland, has been discontinued until further

notice due to the large increase in fee demanded by the American Society of Composers, Authors and Publishers.

Many orchestras, playing at hotels, cafes and theaters, will be lost to the WTAM Radio audience through the latest and increased demand of the organized music publishers.

Old WLW Transmitter to Be Used in Short Wave Tests

CINCINNATI.—Engineers are at work upon removing the old 500-watt transmitting equipment of WLW to the building in which the Crosley studios are located. This station will be used as an auxiliary to the 5,000-watt superpower broadcasting plant near Harrison, Ohio.

It will be possible to conduct short-wave experiments with the low power set. WLW has an experimental license which permits this type of test. There is also a possibility of using both stations at the same time and thus ascertain the effect of the double broadcasting.



Patented Nov. 18, 1924

Windsor Loudspeaker Console

For EVERY Radio Set

A stunning piece of furniture that restores order in the room where you have your Radio! No more cluttered table-tops, nor litter of equipment under-foot.

No unsightly horn in evidence, either! This console has its own loudspeaker, in-built. It's out of sight, but with very apparent tonal superiorities. For it has the highest-developed type of unit. With horn built of special non-vibrating, extra-hard, ceramic material. Produces clear non-vibrant tone.



Non-Vibrant Ceramic Horn

The clearest tone producer on the market. Made of special composition which defeats vibration.

There's ample room for everything; space for largest A and B wet batteries—or battery eliminator—required for any home set; and for a big charging outfit, too.

Finished in mahogany, or walnut color. Dainty design of parqueterie on two front panels. Top, 38 in. x 18 in. Substantially built; the product of a 40-year-old furniture maker.

The price, forty dollars, is for the complete console and includes the loudspeaker horn and unit. Thousands of dealers are showing this artistic addition to home radio equipment.

Rear View—Set Hooked Up



Price, \$40
West of Rocky Mts., \$42.50

Windsor Furniture Co.
1434 Carroll Ave.
Chicago, Ill.

Single Dial Tuning

Yet Greater Selectivity



The Wave Master Console

A beautiful genuine mahogany model with inbuilt horn.

\$235.00

Also made in a handsome Console Model. Price \$275.00

"NOW I Get What I Want When I Want It"



Standard Model 5-Tube Wave Master

in beautifully finished cabinet of solid genuine mahogany. Price,

\$125.00

KELLOGG

Found the Way!

HERE, at last, is a radio set that is REALLY easy to tune. Just one tuning dial—but what a magic dial it is! For it actually has a range of 540 degrees—over three times more station finding range than the ordinary dial.

A dial that gives lots of room for a wide separation of stations. Makes it easy to tune in the one you want and to completely blot out the others.

In fact, this remarkable new Kellogg receiver is exactly the set busy men and women everywhere have been asking for. A set that brings in what you want when you want it—without fusing, without "hushing" the rest of the family, without any need of knowing what is going on inside the handsome cabinet. Simply superb is the musical quality of WAVE MASTER reception.

This masterpiece of receiving sets is the product of a manufacturing company that would naturally be expected to design a great set. For 28 years, the Kellogg Switchboard & Supply Company has been making precision electrical instruments—telephones, switchboards, and apparatus. Ever since the beginning of radio we have been making radio parts of highest

quality. But not until now have we been able to perfect a radio receiver that we felt was worthy to carry the Kellogg name.

The Kellogg WAVE MASTER has little in common with other five-tube sets. It operates on a new, better and more efficient principle. By using a new system of amplification and detection, we have solved the difficult problem of single dial tuning.

We have done it without any sacrifice of selectivity; instead, we have INCREASED selectivity as greatly as we have increased simplicity.

Would you know more about the WAVE MASTER? It is our aim to make it easy for folks to test the WAVE MASTER wherever they may be located—the country over. If you do not know the Kellogg dealer in your vicinity, write us at once for his name and a full description of the WAVE MASTER circuit. Ask for Folder No.4J-2



Kellogg Symphony Reproducer \$25.00

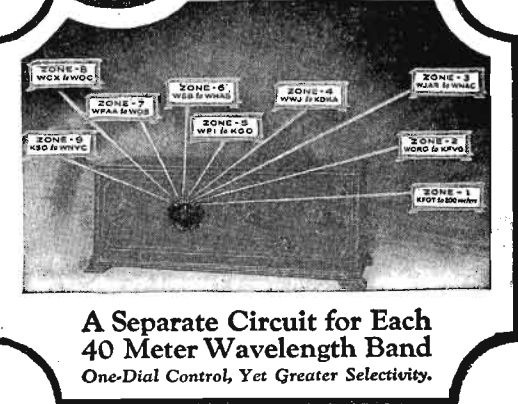

A Separate Circuit for Each 40 Meter Wavelength Band
One-Dial Control, Yet Greater Selectivity.

Radio Dealers and Jobbers!

We are now closing sales franchises in open territory, which is fast being taken up. The WAVE MASTER franchise, backed by Kellogg resources and our powerful advertising campaign is most valuable. Wire us if interested—or get into Chicago quickly and see us regarding this money-making proposition.

Kellogg Switchboard & Supply Company
1066 West Adams Street, Chicago, Ill.

KELLOGG WAVE MASTER SWITCHBOARD & SUPPLY CO.



RADIO 'RITHMETIC

"A" batteries + "B" batteries + RECTIGON = clear radio reception

HARK back to your old arithmetic and those busy boys "A" and "B". They were forever doing "a certain piece of work". They're still inseparable. Nowadays "A" and "B" storage batteries are busy with clear radio reception.

"A" still depends upon "B" and vice versa. Both need to be kept fully alive to do their best work. Both *can* be kept alive easily and dependably through the use of one [*did you know that?*] compact, little device—



The Westinghouse Rectigon Battery Charger

© 1925. W. E. & M. Co.

To recharge 1- or 2-cell radio "A" Batteries merely adjust "snap" terminals as shown here. Takes but a moment.

To recharge 3- or 6-cell radio "A" or automobile batteries merely adjust "snap" terminals as shown here. Simple as can be.

To recharge 11- to 48-cell "B" batteries merely adjust "snap" terminals as shown here. (An instruction sheet packed with every Rectigon).

Superiorities
THERE'S no muss or fuss when you use the Rectigon. No acids or chemicals. No moving parts and no noise!
It has high quality insulation throughout. Even the case is protected with Rectigon-maroon, acid-resisting enamel. Guaranteed to completely satisfy.

No storage battery radio is complete without a RECTIGON



Powel Crosley, Jr.
Master of Mass Production

PERFECTION is the guiding star of the Crosley Radio Corporation. Each Crosley set is direct evidence that a keen spirit of preciseness reigns throughout all Crosley factory units. It was only after attaining the highest degree of perfection that *Mass Production* was begun. When Crosley prices were announced publicly the world wondered; little knowing that the first few thousand sets manufactured were sold at a LOSS. Profits were not realized until hundreds of thousands of Crosley sets were sold. Today Crosley production is computed in gigantic figures. It is this multitude of sets in American homes that point to Powel Crosley as the Master of Mass Production. It is the satisfaction given by these sets that prove conclusively that the guiding star of the Crosley organization is—PERFECTION.

Powel Crosley, Jr., has made good radio possible for millions

"Better—Costs Less" wrote Powel Crosley, Jr., some five years ago when his first experiments in the radio field showed him that radio apparatus could be manufactured which not only could be sold for less money but actually give better results.

A one tube radio receiver sold then for \$85. Today Crosley gives the world a better working set for \$9.75.

Good radio reception is not a matter of dollars. Europe is heard by thousands on Crosley radios selling for less than \$15.

The Ford idea in production has been responsible for the unbelievable low price of Crosley apparatus. Here the compari-

son stops. A Ford cannot deliver Pierce Arrow ease yet Crosley radio covers any distance and brings broadcasting into your home, true, sweet and sonorously in first-row Metropolitan Opera house style.

Radio circuits are the base of radio reception. They are not costly to construct. The circuits Crosley uses can not be improved upon for out and out reception. Trimmings won't improve performance. Good radio is not a matter of extravagant production and Crosley had discovered that when he wrote his famous line, just a few short years ago—"Crosley Radio, BETTER—COSTS LESS."

"WLW

Crosley, Cincinnati!"

This world known call is heard daily from the luxurious studios of the Crosley broadcasting station located in the No. 1 Crosley plant in Cincinnati. Remote control microphones are also located in all prominent Cincinnati musical and amusement centers.



"WLW Studios"

Powel Crosley, Jr., has given generously to the radio world a great share of the music, information and entertainment broadcast daily throughout the country. This powerful 5,000 superpower station is by a popular vote recently conducted by a national magazine, one of the country's four most popular stations.

Beautifully decorated ensemble studio at Station WLW. Everything possible has been done to obtain perfect acoustical quality of reproduction.

Antique furniture and gorgeous tapestries give beauty to the WLW auditorium. Temperamental artists find surroundings to their liking.

Solo studio and office of broadcasting director. An ancient tapestry from France adorns the wall while the furniture is of antique design.

THE CROSLEY RADIO

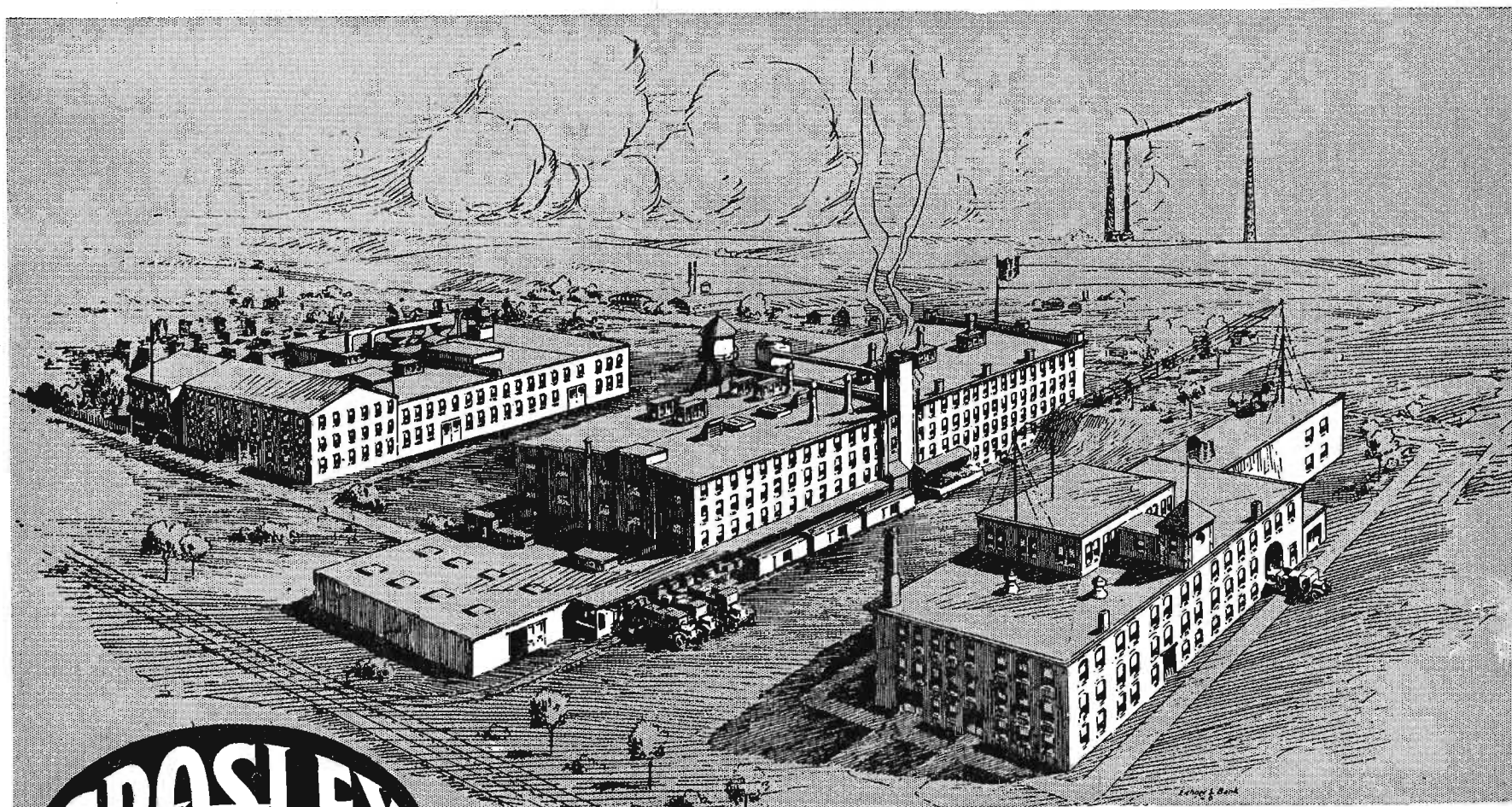

The Crosley Factories

The above composite drawing is of the three huge factories in Cincinnati where production of radio has developed to an extraordinary high degree of efficiency.

At the present time this plant is turning out thousands of radio sets per day; twice as many as last year.

WLW broadcasting studios are located in the middle building and all broadcasts are sent out through ground wires to the transmission station 25 miles away on top of one of southern Ohio's highest hills.

At the right is an ingenious machine devised by the Crosley Radio engineers for winding rheostats. This, like countless other apparatus in the Crosley plant, has been developed in a constant search for better and less expensive methods of manufacture. This machine does in one day what it formerly took 8 girls to do in the same length of time.

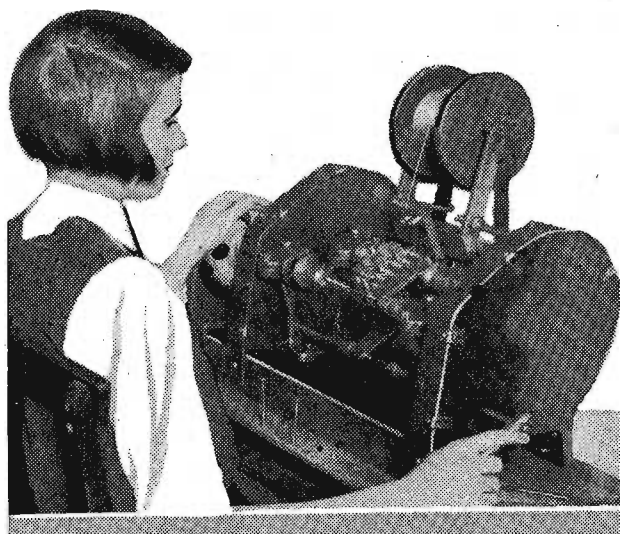

Below is a machine for the automatic manufacture of tube sockets.

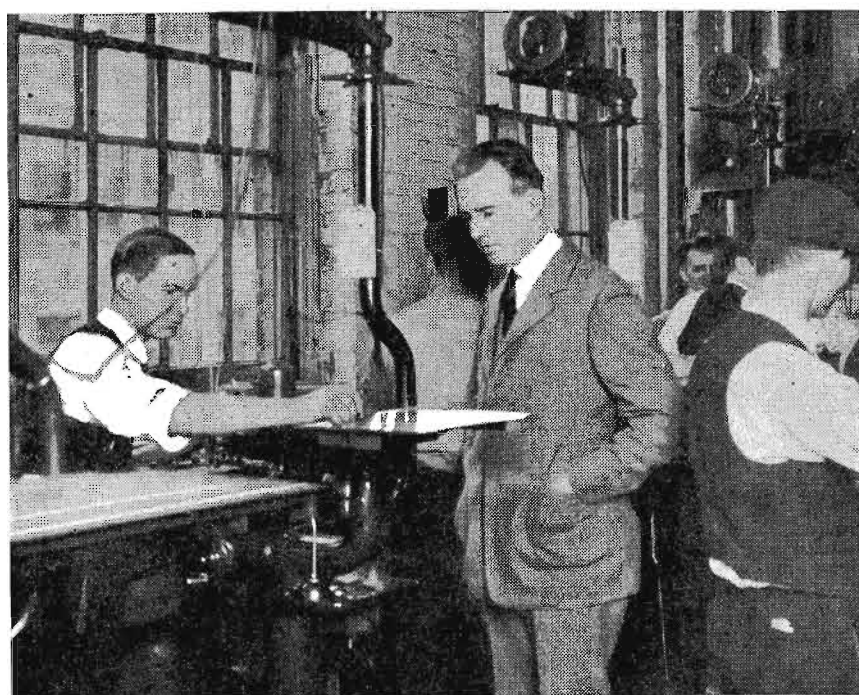
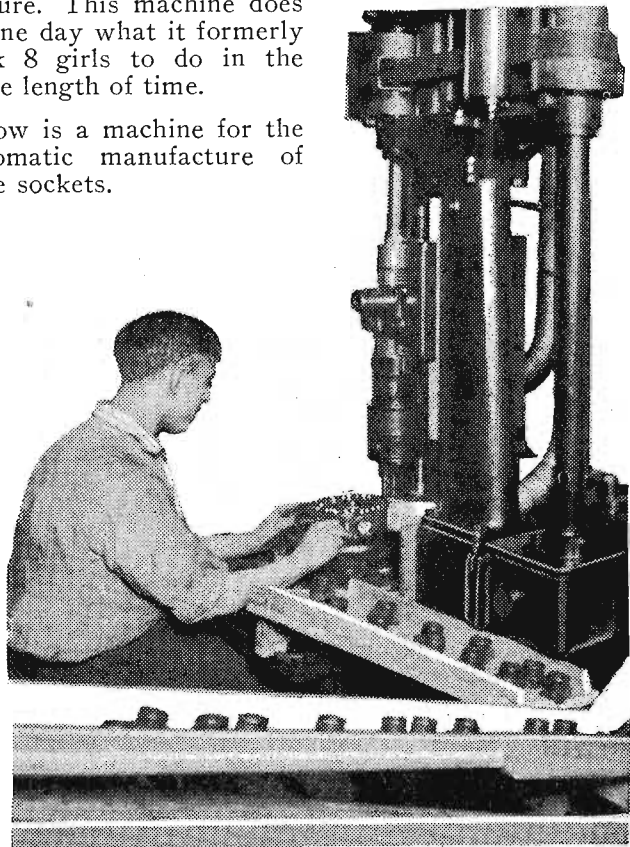

Powel Crosley, Jr., exercises a careful supervision over every detail of Crosley Radio production. His frequent inspections are events in which every employee is on his toes to win his approbation. Many of the ingenious devices found in the factory are Mr. Crosley's own designs.

CORPORATION *Cincinnati, Ohio*

THE CROSLEY "PUP"



*A Genuine Armstrong Double
Circuit Receiver*

HERE, without question, is the biggest value ever offered in radio history—a one tube set with a radius of 1500 miles or more on head phones under average conditions! The PUP is a genuine Armstrong receiving set, employing the double circuit to reduce radiation to a minimum and to provide a degree of selectivity that enables you to tune through local stations without difficulty.

Everyone—you, your mother, father, family and the cook should have one. Half as big as a shoe box and conveniently portable. A permanent, substantial, quality product throughout, phenomenally priced only because of its simplicity and Crosley's tremendous manufacturing facilities. The price, \$9.75, does not include accessories.

\$9⁷⁵
Without
Accessories

WIN \$1000 and Fine Pedigreed Puppies

Who will send Crosley the best verified report of reception with a one tube set between September 1st, 1925 and March 1st, 1926?

Who will send in the best report each month?

1,000 prize for the best report for the entire period. A real, live, pedigreed puppy valued at \$100, each month as first monthly prize and larger Crosley sets as other prizes. Duplicate prizes, identical to those tied for, will be given to all who, in the opinion of the judges, may tie for prize awards.

Contest open to all, except Crosley employees, no matter where you are, or what set you own and use, factory or home built. Reports of reception must be verified. Judges may ask for affidavits.

Full details of contest and entry cards are packed with each Crosley "PUP," or may be obtained from any Crosley dealer, or upon application to the Crosley Radio Corporation. Try for the prizes as many times and as often as you like.

Ask Crosley dealers for illustrated circular giving full details of contest.



Champion Kora Von Warnotal of Greenfair Kennels, Catrock Road, Greenwich, Conn. A puppy from this kennel is offered as first prize for February, Crosley Radio Reception Contest. Mr. and Mrs. J. C. Quirk, owners.



Cairn Terriers from Robinscroft Kennels, Mrs. H. F. Price, Riverside, Conn. A puppy from this kennel is offered as first prize for February, Crosley Radio Reception Contest.



Champion Aroostook Hopeful of Oldtown Kennels, Owned by Wilmot J. Evans, Jr., Boston, Mass. Puppy from this kennel is the first prize for November.



"Deeka" This famous police dog is sire to the puppy to be given as first prize for January. This marvelous dog is owned by Nelson J. Peabody of Boston, Mass. Big Mountain Kennels, Weston, Vt.



Jefferson Collie Puppy from Jefferson Collie Kennels, Wauseon, Ohio. F. W. Avery, Prop. First October Award, Radio Reception Contest.



Strongheart Police Dogs from Sunbeam Farm, Strongheart Kennels, New Brunswick, N. J. December first prize in Crosley Radio Reception Contest.

THE CROSLEY RADIO

The NEW Crosley Super-Trirdyns

3 tubes do the work of 5

During the past three years Crosley engineers have developed a new circuit, first called the Trirdyn, and with further refinements the Super-Trirdyn. This circuit combines and utilizes for the first time successfully, tuned radio frequency amplification, regeneration and reflexed audio amplification, making three tubes do the work of five. There is a marked saving both in first cost and upkeep cost. Batteries last longer. There are less tubes to replace.

Repeated competitive tests reveal that no present day set, regardless of price, is capable of out-performing the Super-Trirdyns. They give all the volume possible with the best of existing vacuum tubes. Instead of adding to volume and increasing selectivity, additional tubes only result in distortion and tube noises.

By its superlative performance, the original Trirdyn model quickly built up a world-wide reputation. Yet these newest models incorporate vital improvements which are immediately apparent in the notably finer results they give.

Coupled with their improved performance, the Super-Trirdyns present a new appearance that recognizes no peer in the quality radio field. Here Crosley has again demonstrated the value-producing economies of gigantic production.



Dealers: Write for details of Authorized Sales and Service Station franchise.

Combination De Luxe

The Super-Trirdyn Special arranged with the Musicone De Luxe and a specially designed table form an attractive radio unit of superlative beauty. Musicone De Luxe \$27.50. The table sells separately for \$25.00. The three pieces together total

\$112.50

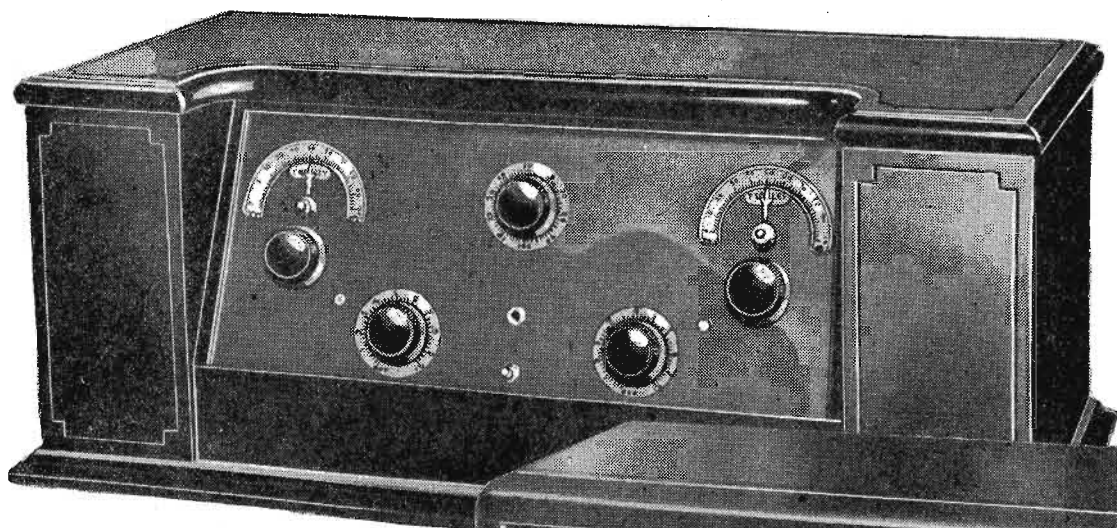

SUPER-TRIRDYN

Special

The improved Super-Trirdyn panel is assembled in a new solid mahogany cabinet finished in duotone. This cabinet is of ample size to house all dry batteries required for dry cell tube operation. Price, without accessories,

\$60

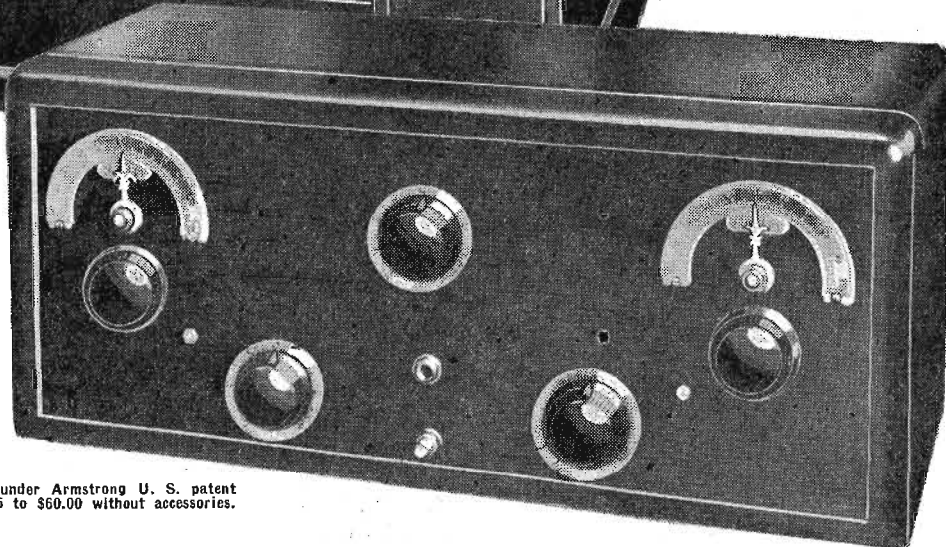

SUPER-TRIRDYN

Regular

This model has the same panel as the Super-Trirdyn Special. The cabinet of beautifully finished solid mahogany is less elaborate in detail and more compact. In performance both sets are identical. Price, without accessories,

\$45

Crosley receiving sets are licensed under Armstrong U. S. patent No. 1,113,149 and priced from \$9.75 to \$60.00 without accessories.

CORPORATION *Cincinnati, Ohio*

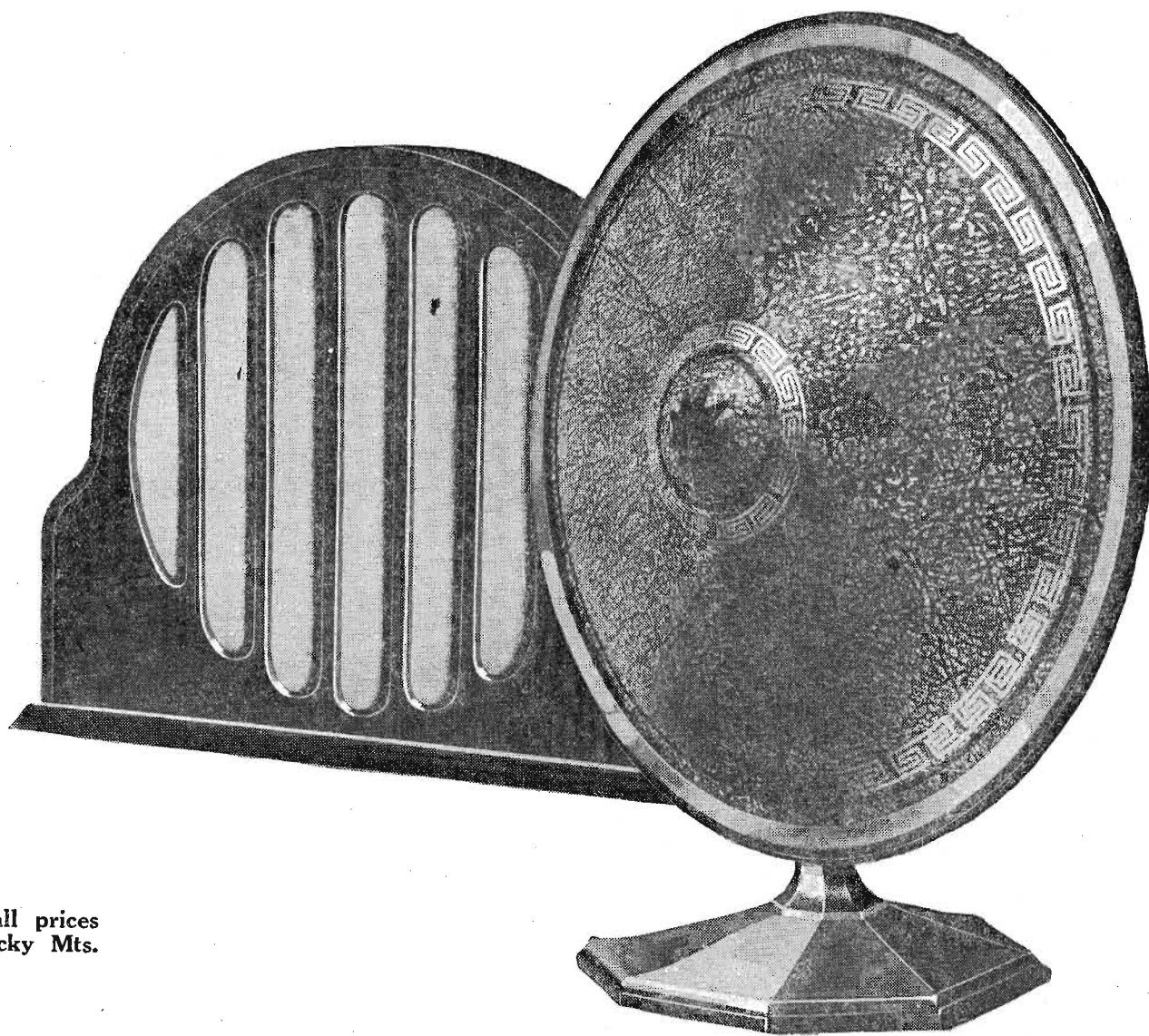

Add 10% to all prices
west of the Rocky Mts.

The Crosley Musicones

Rapidly Replacing Horn Types of Loud Speakers

From present indications, it appears that at least 500,000 present day "loud speakers" are being replaced by the Musicone in this, its first year.

Its full, rich, mellow tones — its extraordinary reproduction of the human voice and all musical instruments without distortion of pitch or tinny overtones, constitutes one of the outstanding achievements in all radio history.

This is based not on the cone, but on the patented actuating unit which Crosley engineers have developed and which is exclusive to the Musicone.

You are urged to beware of imitation cone speakers, for only the Musicone represents the full perfection of sound reproduction. Requires no adjustments nor additional batteries.

Now \$14.75

Musicone De Luxe

The Musicone is also offered encased in an artistic clock-type mahogany cabinet with a gridded screen. Its superior beauty makes it ideal for use with the Super-Trirdyn or any other set. Price **\$27.50**

Dealers: Authorized Sales and Service Station franchises still available for some communities

THE CROSLEY RADIO

Four Extraordinary Crosley Values

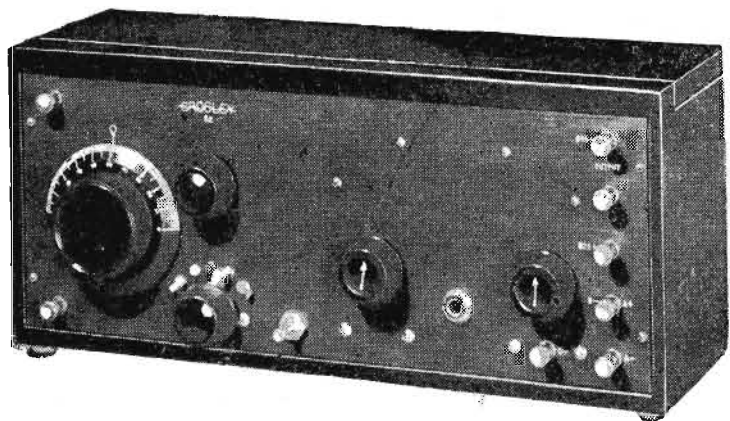

THE CROSLY 3 TUBE 52
Regular

Under average conditions locations in the Central States will get all prominent American stations on the loud speaker with this little giant of the air. Its performance is a source of pleasure to thousands. Its demonstrated ability over a long period of time has proven it a highly desirable value and worthy of a place in the Crosley Radio line for 1926.

NOW \$25 PRICE WITHOUT ACCESSORIES

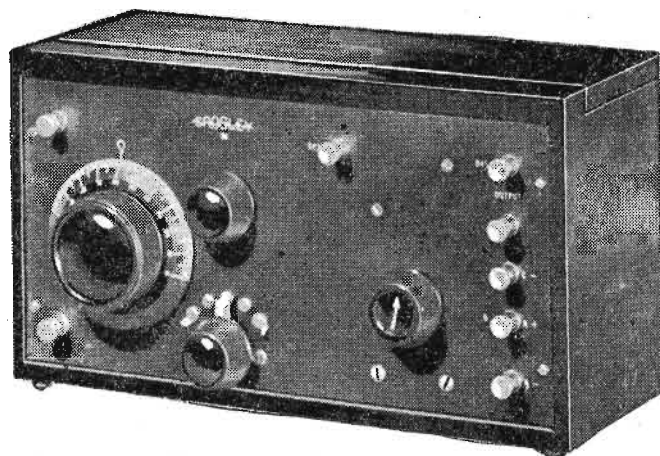

THE CROSLY 2 TUBE 51
Regular

This remarkable Crosley Radio receiver uses the genuine Armstrong regenerative circuits. Reports pouring in from every state show almost unbelievable distances covered by this little set's wide range. Under average conditions loud speaker reception is possible within a radius of 500 miles and more.

NOW \$14⁷⁵ PRICE WITHOUT ACCESSORIES

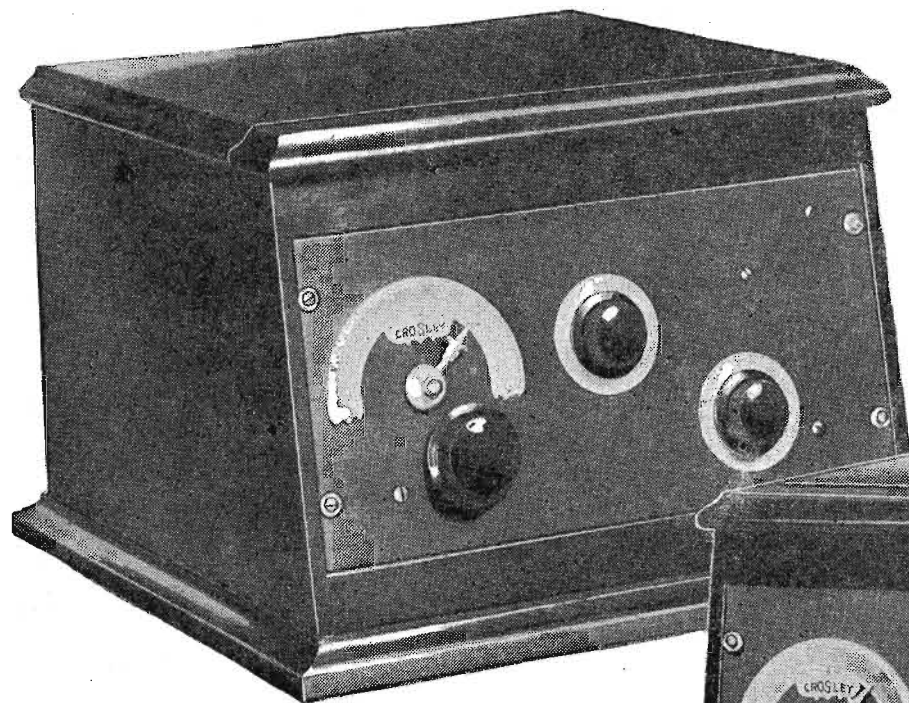

The Crosley 3 Tube 52
Special De Luxe

This popular long range receiver offers even greater selectivity and general improved reception ability. It, too, contains radical Crosley improvements and is without question one of the outstanding radio values on the market today. Beautifully finished and trimmed. Price without accessories,

\$32⁵⁰

THE CROSLY 2 TUBE 51
Special De Luxe

Beautifully designed, this popular model gives an excellent account of itself in appearance and performance. Crosley's vernier plate condenser, rotary type tickler and double circuit hook-up are features of this remarkable receiver. The cabinet is of oil rubbed mahogany. Finely finished in every detail. Price without accessories

\$23⁵⁰

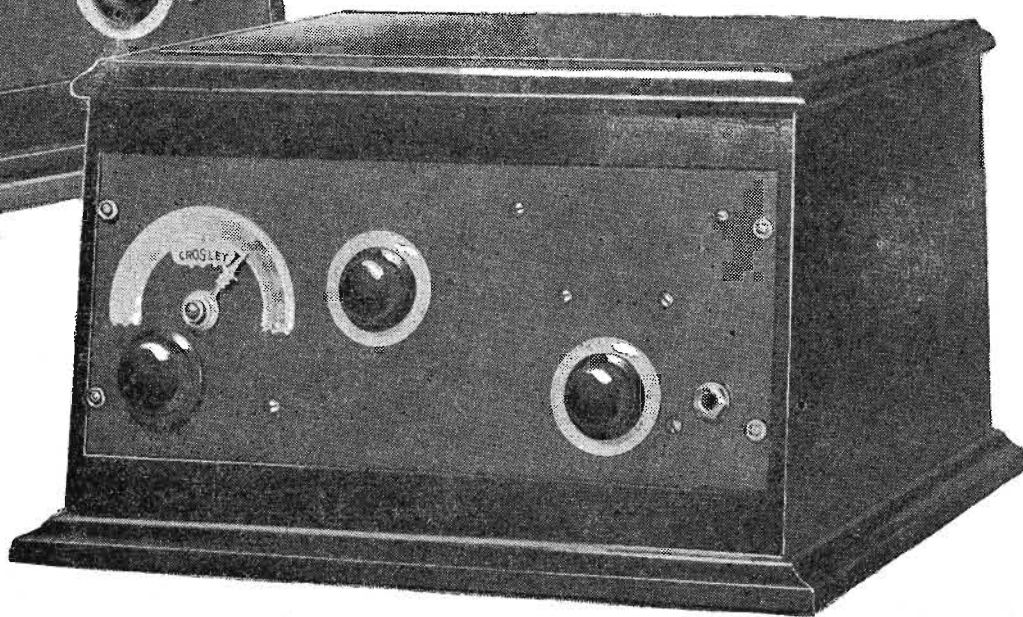

CORPORATION *Cincinnati, Ohio*

TURDAY; KHJ GIVES KIDDIES PARTY



Princess King, right, is a versatile artist recently discovered by KTHS. She is pleasing everybody by playing both the organ and piano at this station.

Episcopal church; William Stansfield, organist, choir director; 9, Hotel Ambassador concert orchestra; Harry Loventhal, director; 10, organ recital, Arthur Scott Brook; Olivet quartet.

WREB, Lansing, Mich. (285.5), 10 a. m., Boltry Plymouth Congregational church; 10:30, Plymouth Congregational church; 7 p. m., Central M. E. church.

WTAG, Worcester, Mass. (268), 3:45-5:30 p. m., Men's conference, Halsey Hammond; address, Dr. S. Parkes Cadman; Gloria Trumpeters; Howard Wade Kimsey, song leader; George Belts, chime soloist; 7:20-9:15, WEAF program, Major Edward Bowes and the Capitol gang; 9:15-10:15, WEAF Atwater Kent hour.

WWJ, Detroit, Mich. (352.7), 11 a. m., St. Paul's Episcopal cathedral; 2 p. m., Detroit News orchestra; 7:20, Capitol theater gang.

Central Time Stations
KFAB, Lincoln, Nebr. (340.7), 4-5 p. m., vesper service. **KFDM**, Beaumont, Texas (315.6), 8-9 p. m., sacred program.

KNFN, Shenandoah, Iowa (266), 10:45 a. m., First M. E. church; 2:30, Golden Rule song service; 3, United Presbyterian church; 6:30, Golden Rule circle; 7:30, Christian church services.

KFRU, Columbia, Mo. (499.7), 7:30 p. m., evening student service, Stephens college night, Mary Byrd Boulware, violinist; scripture reading, Betty Stanley; prayer, Nona Joyce; ladies' trio.

KFVE, University City, Mo. (240), 10 p. m., sermon, "Fundamentalists vs. Modernists," Rev. C. W. Davis, Bethlehem Congregational church; "What Would I Do Tomorrow If a Million Were Mine Today," poem; sacred selections.

KLDS, Independence, Mo. (440.9), 11 a. m., studio service; 6:30, vesper service, Lilly Belle Allen, soprano; Edna Daniels, contralto; 9, Stone church choir.

KOIL, Council Bluffs, Iowa (278), 2 a. m., special Pacific time program; Owl orchestra; 11, services, First Congregational church, Rev. J. R. Perkins, "An Investment in Jewels"; 7:30 p. m., Monarchs, Jerry McMillan, director.

KSD, St. Louis, Mo. (545.1), 6:15 p. m., WEAF chain, "Good Willing."

KTHS, Hot Springs National Park, Ark. (374.8), 11 a. m., Central Methodist church; 9-10 p. m., New Arlington hotel, Meyer-Davis orchestra; 10-11:15, Phil Baxter and his singing orchestra.

KYW, Chicago, Ill. (526), 11 a. m., Central church service, Rev. Frederick Shannon, pastor; 2:30 p. m., studio chapel service; 4, studio concert hour, Edwin Harper; 7, Chicago Sunday Evening club; choir of 100 voices, Edgar Nelson, director; speaker.

WBAP, Fort Worth, Texas (475.9), 11 a. m., First

Episcopal church; William Stansfield, organist, choir director; 9, Hotel Ambassador concert orchestra; Harry Loventhal, director; 10, organ recital, Arthur Scott Brook; Olivet quartet.

WREB, Lansing, Mich. (285.5), 10 a. m., Boltry Plymouth Congregational church; 10:30, Plymouth Congregational church; 7 p. m., Central M. E. church.

WTAG, Worcester, Mass. (268), 3:45-5:30 p. m., Men's conference, Halsey Hammond; address, Dr. S. Parkes Cadman; Gloria Trumpeters; Howard Wade Kimsey, song leader; George Belts, chime soloist; 7:20-9:15, WEAF program, Major Edward Bowes and the Capitol gang; 9:15-10:15, WEAF Atwater Kent hour.

WWJ, Detroit, Mich. (352.7), 11 a. m., St. Paul's Episcopal cathedral; 2 p. m., Detroit News orchestra; 7:20, Capitol theater gang.

Central Time Stations
KFAB, Lincoln, Nebr. (340.7), 4-5 p. m., vesper service. **KFDM**, Beaumont, Texas (315.6), 8-9 p. m., sacred program.

KNFN, Shenandoah, Iowa (266), 10:45 a. m., First M. E. church; 2:30, Golden Rule song service; 3, United Presbyterian church; 6:30, Golden Rule circle; 7:30, Christian church services.

KFRU, Columbia, Mo. (499.7), 7:30 p. m., evening student service, Stephens college night, Mary Byrd Boulware, violinist; scripture reading, Betty Stanley; prayer, Nona Joyce; ladies' trio.

KFVE, University City, Mo. (240), 10 p. m., sermon, "Fundamentalists vs. Modernists," Rev. C. W. Davis, Bethlehem Congregational church; "What Would I Do Tomorrow If a Million Were Mine Today," poem; sacred selections.

KLDS, Independence, Mo. (440.9), 11 a. m., studio service; 6:30, vesper service, Lilly Belle Allen, soprano; Edna Daniels, contralto; 9, Stone church choir.

KOIL, Council Bluffs, Iowa (278), 2 a. m., special Pacific time program; Owl orchestra; 11, services, First Congregational church, Rev. J. R. Perkins, "An Investment in Jewels"; 7:30 p. m., Monarchs, Jerry McMillan, director.

KSD, St. Louis, Mo. (545.1), 6:15 p. m., WEAF chain, "Good Willing."

KTHS, Hot Springs National Park, Ark. (374.8), 11 a. m., Central Methodist church; 9-10 p. m., New Arlington hotel, Meyer-Davis orchestra; 10-11:15, Phil Baxter and his singing orchestra.

KYW, Chicago, Ill. (526), 11 a. m., Central church service, Rev. Frederick Shannon, pastor; 2:30 p. m., studio chapel service; 4, studio concert hour, Edwin Harper; 7, Chicago Sunday Evening club; choir of 100 voices, Edgar Nelson, director; speaker.

WBAP, Fort Worth, Texas (475.9), 11 a. m., First



Methodist church; 5-6, School of Gospel music; 11, popular music, Sibelius, Lee Atley's orchestra.

ger, director, soloist; George Muhlhauser, tenor; special feature, Pogue trio, Arthur Dondero, violinist; Arthur Bowen, cellist; Walter Esberger, pianist.

WMBB, Chicago, Ill. (250), 3-5 p. m., Trianon orchestra; Walter Duffy, Geraldine Doyle, Woodlawn theater orchestra; Billie Allen Hoff; 7-8, Trianon duo, Beatrice Teller, Joel Lay, Florence White Rush, Hazel O'Neil; 9-11, Trianon orchestra; Morey Alsward, Woodlawn theater orchestra; Harold Stokes, Charles Agne, Woodlawn theater orchestra.

WMA, Omaha, Neb. (526), 9 a. m., chapel service, Rev. R. Brown; 2:30 p. m., matinee program; 9, Our Saviour's Lutheran church.

WOC, Davenport, Iowa (483.6), 6:30 p. m., South Park Presbyterian church; 8-15, Atwater Kent; 9:45-11:45, Palmer Little symphony.

WOK, Chicago, Ill. (217.3), 6:30-8:30 p. m., WOK string trio; WOK mixed quartet; orchestra.

WOR, Batavia, Ill. (275), 10 a. m., hymns and sacred songs; 10:15, address, A. L. Seelye; 9 p. m., hymns and sacred songs; 9:15, address, G. A. Hail; 9:45, I. B. S. A. choral singers.

WQJ, Chicago, Ill. (447.5), 9:30 a. m., People's church; 3-4 p. m., Sunday afternoon concert, Hishaw conservatory; 8-10, Ralph Williams and his Rainbo Gardens orchestra; Lutheran Memorial church choir; Maria Dneprova, Russian soprano; Dr. C. B. Roe, haritone; Gertrude Hardyman, contralto; Helen Holman, soprano.

WSAI, Cincinnati, Ohio (326), 2:45 p. m., Dr. S. Parkes Cadman, WEAF; 8, sermonette; 8:15, Atwater Kent Radio hour; 9:15, Union Central Life Insurance concert orchestra; 9:15, L. Seelye, soprano.

WSM, Nashville, Tenn. (282.8), 11 a. m., service, First Presbyterian church.

WSUI, Iowa City, Iowa (483.6), 9:15 p. m., familiar hymns, Mrs. L. G. Lavyer, soprano.

Mountain Time Stations
CFAC, Calgary, Can. (435.8), 11 a. m., Christian Science church services.

CKNC, Toronto, Can. (356.9), 10 p. m., CKNC Little symphony orchestra; Aeolian vocal quartet; Hazel Hall-Vandervoort, soprano.

KOA, Denver, Colo. (322.4), 11 a. m., Trinity Methodist Episcopal church; 4 p. m., Trinity Methodist Episcopal church; 7:45, service, Trinity Methodist Episcopal church.

Pacific Time Stations
KFWB, Hollywood, Calif. (252), 9-11 p. m., late news and Warner Brothers' movie trailer, Al Meyer's Anellians; Howard "Gin" Flynn, banjo; Peggy Mathews, blues singer; Frank Stever, baritone.

KGO, Oakland, Calif. (361), 11 a. m., First Presbyterian church; 3:30 p. m., KGO Little Symphony orchestra; 7:30, service, First Presbyterian church.

KGW, Portland, Ore. (491.5), 10:55-12 noon, services, Church of Our Father, Unitarian; 7:25-9, service, First Presbyterian church.

KHJ, Los Angeles, Calif. (405.2), 4-5 p. m., Sunday afternoon musicale, Western Auto Supply company; 6:30-7, Leighton's Arcade cafeteria orchestra; 7-7:30, organ recital, Arthur Blakely; 8-10, de Luxe program arranged and presented by J. Howard Johnson.

KNX, Hollywood, Calif. (336.9), 2-4 p. m., park board program with community sing, directed by Huxo Kirkhofer; 7-8, First Presbyterian church, Rev. Stewart P. MacLennan, pastor; 8-9, Ambassador hotel concert orchestra, Josef Rosenfeld, leader; 9-10:30, program, Beverly Hills Nurseries, Calmon Lubovicki, violinist; Misha Gagma, cellist; Raquet Nieto, coloratura soprano.

KPO, San Francisco, Calif. (428.3), 5-6 p. m., Marshall W. Giselman, organist; 6-6:30, Waldenham Lind and the States restaurant orchestra; 6:35-7:30, Palace hotel concert orchestra; 8-8:30, Palace hotel concert orchestra; 8:30-10, Rudy Seiger's Fairmont hotel orchestra.

KTAB, Oakland, Calif. (240), 9:45 a. m., Bible lecture, Prof. Linsky; 11, church service; 7:45 p. m., church service; 9:30-11, concert.

Methodist church; 5-6, School of Gospel music; 11, popular music, Sibelius, Lee Atley's orchestra.

WBBM, Chicago, Ill. (226), 4-8 p. m., Harold Anderson, Merry Garden orchestra; Charlie Garland, Maurice Silverman, Burdette Cleveland; Blue Deuces, Zeigler sisters; 8-10, Frances Ingram, contralto; Mary Garden orchestra; Wendell Weigert, violinist; Jean St. Anne, baritone; Christian Grig, accompanist; Ted Coleman, cellist; Joseph Raetz, concert pianist; 12-2, Nutty club request feature.

WCBD, Zion, Ill. (344.6), 8 p. m., Hire string quartet; Mrs. Thomas, Mr. Barton; Mr. Thomas; Mr. and Mrs. G. R. Sparrow, tenor and contralto; Arthur and Edwin Rendall, clarinetist and flutist; Fred Fassen, organist; Richard F. Hirt, violinist; Herbert Hendricks, conductor; Richard H. Hirt, pianist.

WCCO, Minneapolis-St. Paul, Minn. (416.4), 11 a. m., Westminster Presbyterian church, Rev. John Bushnell, pastor; 4-10, House of Hope Presbyterian church, Rev. H. C. Swearingen; 8:15, WEAF Atwater Kent program.

WCBH, Chicago, Ill. (370.2), 7-9 p. m., artist program.

WENR, Chicago, Ill. (266), 2-4 p. m., Rauland lyric trio; Frank Vestphal, soprano; 9:30-11:30, All-American Pioneers; vocalist, Hal Laige.

WFAA, Dallas, Texas (475.9), 3-4 p. m., hour for farmers; 6:30-7:30, Radio Bible class, Dr. William M. Anderson, gospel song; 7:30-8:30, services, First Baptist church, Dr. George W. Truett, pastor; 9:30-11, Ligon Smith and his orchestra.

WGN, Chicago, Ill. (370.2), 1 p. m., Chicago theater program; 3:30-5, Chicago Musical college concert; 9-10, Drake concert ensemble.

WHAS, Louisville, Ky. (399.8), 9:57 a. m., organ prelude; 10, Fourth Avenue Presbyterian church; 4:30-5:30, Christ church even song choral service.

WHB, Kansas City, Mo. (365.8), 8-9:30 p. m., Bailey's concert; 11:15, Morrill Moore, organist; Gales' school of dancing.

WHO, Des Moines, Iowa (526), 11 a. m., church service; 7:30-8:30, Reese-Hughes orchestra.

WHT, Chicago, Ill. (399.8), 2:15 p. m., Fellowship program; 2:50, services, Chicago Gospel tabernacle; 5:30, Young Women's council; 6:30, concert, Tabernacle band; choir, sermon, Paul Rader; 9:30, request program; 9:30, Paul Rader and chapel staff.

WIBO, Chicago, Ill. (226), 2-4 p. m., classical concert; 6-8, studio program; 10-12, popular program; Ted Florito and Dan Russo orchestra.

WLIB, Elgin, Ill. (302.8), 7-8 p. m., dinner concert, Drake concert ensemble; Blackstone string quintet; 9-10, Fred Hamm's orchestra; organ recital; 10-11, Jack Chapman's and the Blackstone hotel dance orchestras; jazz artist; 1-2 a. m., Jack Chapman's and the Blackstone hotel dance orchestras; jazz.

WLS, Chicago, Ill. (344.6), 6:30 p. m., Ralph Emerson, organist; 7-7:55, WLS Little Brown church in the Vale.

WLW, Cincinnati, Ohio (422.3), 7 p. m., services, First Presbyterian church, Dr. Frederick McMillan, minister; 8, concert, H. & S. Pogue Co., Walter Weber-

DANCING
 Central Standard Time
 Saturday, October 31:
 8:30, Wira, Wnye, Wog;
 9:30, Wfaa, 8:35, Wgy;
 9, Webb, Weel, Wmbb,
 Wnye, Wreo; 9:10, Kths,
 Wip; 9:30, Kths, Wgbs,
 Wor, Wre; 10, Kfve,
 Kfwa, Kpa, Kpo, Weaf,
 Wgn, Wjr, Wtra, Wwca,
 Wye, Wz, Wqj, Wzo,
 Wtam; 10:05, Wcco;
 10:30, Wamd; 10:45,
 Wls; 11, Kfkg, Kfwa,
 Kfwb, Kpo, Webb, Wfaa,
 Wgbu, Wwh, Woc; 11:30,
 Kfoa; 11:45, Wdaf; 12,
 Kwa, Kga, Kgw, Knx,
 Wgbu, Wld.

Monday, November 2:
 8, Wgpe; 9, Weel, Wgbu,
 Wjar, Wor; 9:15, Wwag;
 10, Kths, Wgbu, Wgcp,
 Wkr, Wnye, Wpe; 10:15,
 Wwr; 10:30, Kfoa, Wgop,
 Kfve, Wbbm, Wbeat,
 Wgbu, Wgcp, Wgr, Wwh,
 Who; 11:45, Wdaf; 12,
 Knx, Kpo.

Tuesday, November 3:
 9, Webb, Wgca, Wmbb;
 9:30, Weau, Wgs, Wgy,
 Wip; 9:35, Wnye, 10,
 Kfve, Wbbm, Wbeat,
 Webb, Wgbu, Wgcp, Wwh,
 Wwca, Wye, Wz; 10:15,
 Kths; 10:30, Kths, Wwh;
 10:45, Wsb; 11, Kgw,
 Koi, Wgbu, Ww; 11:30,
 Kfoa; 11:45, Wdaf; 12,
 Kgw, Khj, Knx, Kpo,
 Wdaf; 1, Wqj.

Wednesday, November 4:
 1, Wcau, Wcp, Webb,
 Wghu, Wgcp, Wwh, Who,
 Wubb, Wwca, Wtcc;
 1:15, Wabg; 9:30, Wbap,
 Who, Wor; 10, Kfve,
 Wbap, Weaf, Wgcp,
 Wqj; 10:05, Wcco;
 10:30, Wbap, Wwh; 11,
 Koi, Kpo, Webb, Wgbu,
 Wgcp, Wgr, Wwh; 11:45,
 Wdaf; 12, Kfwa, Knx,
 Kpo, Wjld.

Thursday, November 5:
 1, Wjr; 9, Webb, Weel,
 Wgbu, Wwh, Wwr,
 Wmbb, Wsd, Wtag; 9:05,
 Wz, Wip; 9:30, Wnye;
 Wgy, Wwh; 9:35, Wgca,
 9, Kths, Wbbm, Weaf,
 Wgbu, Wwh, Wwca, Wz,
 Wqj; 10:30, Kths, Wwh,
 Weaf, Wgcp, Wgcp,
 Wmbb; 9:15, Wabg; 9:30,
 Weau, Wwh; 10, Kfve,
 Kpo, Kths, Weaf, Wgbu,
 Wgcp, Wgr, Wwh;
 Wz; 10:05, Wcco;
 10:30, Wgcp, Wwh; 11,
 Kfwb, Knx, Kpo, Webb,
 Wgbu, Wgcp, Wgr, Wwh,
 Who; 11:45, Wdaf; 12,
 Kfoa, Khj; 12:30, Wdaf.

WEAO, WEBJ, WFI, WGBS, WGPC, WHAD, WHAS, WHAZ, WJR, WKQA, WLIT, WMC, WOK, WWO, WOR, WORD, WRC, WSAI, WSMB, WTAM, WTC.

Eastern Time Stations
KDKA, Pittsburgh, Pa. (309.1), 4 p. m., Dr. Charles Holbrook, organist; 4:45, vesper services, Shady Side Presbyterian church; 6:30, Pittsburgh Athletic association; 7:45, church service.

WAFD, Port Huron, Mich. (275), 10-11:30 a. m., church services; 7:30-8:30 p. m., musical program, Addison hotel.

WBZ, Springfield, Mass. (333.1), 10:55 a. m., church services; 8 p. m., "Is Life Worth Living," James J. Walsh.

WCAP, Washington, D. C. (468.5), 11 a. m., services, All Souls church, Unitarian; "How Evolution Helps Religion," Rev. Ulysses B. Pierce; 4 p. m., services, Bethlehem chapel; 7:20-9:15, WEAF program; 9:15, WEAF Atwater Kent artist.

WCAU, Philadelphia, Pa. (277.6), 5 p. m., Robert Fraser, gospel singer; Emma Becker, pianist; 5:15, Radio church service, Rev. John W. Stockwell; 5:25, "The Fourth Gospel Book," Rev. John W. Stockwell; 5:45, "By the Way," Rev. John W. Stockwell; 6, Hotel Pennsylvania concert orchestra.

WCC, Detroit, Mich. (517), 10:30 a. m., services, Central Methodist Episcopal church.

WEAF, New York, N. Y. (491.5), 3-5:45 p. m., concert, New York Symphony society; 3:45-5:30, men's conference, Bedford branch, Y. M. C. A.; 7-7:20, address, Donald B. MacMillan; 7:20-9:15, "Capitol Gang," Capitol theater; 9:15-10:15, Atwater Kent Radio hour.

WEEI, Boston, Mass. (348.6), 3:45 p. m., Men's conference, Dr. S. Parkes Cadman; 7:20, Major Bowes and his Capitol theater family; 9:15, Atwater Kent hour.

WGBS, New York, N. Y. (315.6), 3:30-4:30 p. m., program, Warner's theater; 9:30-10:30, opera in conjunction with Cortiere D'America.

WGBU, Fulford-by-the-Sea, Fla. (278), 9-11 p. m., sacred program.

WGCP, New York, N. Y. (315.6), 8-8:15 p. m., Charlotte Trystmann, pianist; 8:15-8:30, Mme. De Leon, operatic and classical selections; 8:30-8:45, Dick's ukulele club; 8:45-9, Milton Yokeman, tenor; 9-9:10, Sylvia Schatz, pianist; 9:10-9:15, health talk; 9:15-9:25, Isabelle Henderson, soprano; 9:25-9:30, Bernstein trio; 9:30-10, Frank Kallman, violinist; 10-11, Strickland's orchestra.

WGR, Buffalo, N. Y. (319), 3 p. m., vesper service, Buffalo Council of churches, Rev. John P. Sala, University Church of Christ; 7:45, Central Presbyterian church service; 9:15-10:15, jointly with WEAF, Atwater Kent Radio artists.

WGY, Schenectady, N. Y. (379.5), 10:30 a. m., services, First Reformed church, Rev. Robert W. Searle, pastor; 12:30 p. m., program, Rivoli theater; 7:45, service, First Reformed church; 9, violin recital, Godfrey Ludlow; studio program.

WHAR, Atlantic City, N. J. (275), 2:15 p. m., Seaside hotel trio; 7:50, Chelsea Baptist church; 9, Seaside hotel trio; 7:15, Strand theater organ recital.

WHN, New York, N. Y. (361.2), 1-1:30 p. m., March McCurdy, organist; 2:30-3:30, Christian Endeavor program; 5-5:30, Roseland dance orchestra; 7:30-10, services, Calvary Baptist church; 10:45-11:15, Janssens' Hofbrau orchestra.

WIP, Philadelphia, Pa. (508.2), 10:45 a. m., service, Holy Trinity church, Rev. Floyd W. Tumkins, rector.

WJBR, Providence, R. I. (305.9), 7:20 p. m., Capitol theater gang; 9:15, WEAF Atwater Kent hour.

WJR, Detroit, Mich. (517), 8:30 p. m., Merry Old Chief and his Jewett Jesters.

WJZ, New York, N. Y. (455), 4 p. m., St. George's vesper services; 5:45, "The Radio of Spirits," Edgar White Burrill; 8, John Amous, flutist.

WLWL, New York, N. Y. (283.3), 8 p. m., talks on literature; special talks.

WMCA, New York, N. Y. (340.7), 6-7 p. m., Roemer's Homers; 7-7:30, Ernie Golden and his Hotel McAlpin orchestra; 7:30-8, Oleott Vail and his Hotel McAlpin string ensemble.

WPG, Atlantic City, N. J. (299.8), 3:15 p. m., organ recital, Arthur Brook; Isabelle Akimoff, soprano; 4:15, community vocal and instrumental recital, St. James

Monday, November 2

Eastern	Central	Mountain	Pacific
8	7	6	5
WGR (319) Fidelity Council program.			
8:30	7:30	6:30	5:30
WBAP (475.9) Holy Rollers.			
9:45	8:45	7:45	6:45
WJZ (454.3) Steinway Hall program.			
10	9	8	7
WHAZ (379.5) Green Is. Car entertainers.			
10	9	8	7
WAOA (526) Grand opera program.			
12	11	10	9
WCCO (416.4) Gordon Cooke ensemble.			
12	11	10	9
KFWB (252) Eskimo revue.			

Headliners Today

Monday, silent night for: CNRA, CNRC, CNRE, CNRM, CNRO, CNRR, CNRW, CNRT, CFDM, KFMO, KFMY, KFRU, KHJ, KLDS, KTCL, KYW, WBBM, WCBW, WEAO, WEBB, WEBJ, WENR, WFI, WGBS, WGBL, WGN, WHAS, WHT, WIP, WJLD, WKQA, WLBS, WLWL, WMAQ, WMBB, WOC, WORD, WQJ, WRC, WREO.

GOLDTHWAITE PLAYS ORGAN AT WAHG



Harriet Murton, soprano, looked like this recently when she sang some Chinese love songs at KPO, San Francisco. She is one of the veteran radio artists of the Pacific coast and a frequent visitor of KPO.

Monday, November 2

(Continued from page 25)

WFSB, Atlanta, Ga. (428.3), 8 p. m., Rich's glee and mandolin club; 10:45, Art Gilham.
WSM, Nashville, Tenn. (282.8), 6:30 p. m., Beasley Smith's orchestra; 7, Bonnie Barnhardt's bedtime story; 7:30-9, community program, First Presbyterian church; 10-11, studio program.
WSOE, Milwaukee, Wis. (246), 2 p. m., cooking chats, Prudence Penny; 5:30, twilight hour, Aunt Happy; Laurine Ledwig, soprano; Elmer Ihrie, pianist; 6:30, "Dog Raisins," E. B. Hanson; 9, "Send a Candygram," frolic, Elmer Clemens and his Red Oak Country club orchestra; Erving R. Erving, baritone; Iran Rae, child soprano; Van Buren's Hawaiians; Victor Maves, pianist.
WSUI, Iowa City, Iowa (483.6), 12 m., Kenneth Forbes, cellist; "How to Become a Good Speller," Dr. Ernest Horn; 7:30, college of air lectures; 9, speech department.

Mountain Time Stations

CFAC, Calgary, Can. (435.9), 8-9 p. m., studio program, Dean Brothers, directors.
KFAW, Ogden, Utah (261), 9-10 p. m., Fashion shop.
KOA, Denver, Colo. (322.4), 6:30 p. m., Herbert White and his Silver State orchestra; 8, Mu Phi chapter of Nu Phi Epsilon; program, Moszkowski's "Suite for

fitting company; 8-9, program, L. W. Stockwell company; 9-10, program, Listenvaller & Gough; Elie trio, Louise Sullivan, soprano; 10-11, Goodrich Silvertown Cord dance orchestra; Lillian May Challenger, contra-contralto; 11-12, Ray West's Coconut Grove dance orchestra from Ambassador hotel.
KPO, San Francisco, Calif. (428.3), 6:40-7 p. m., Waldemar Lind and the States restaurant orchestra; 7-7:30, Rudy Seiger's Fairmont hotel orchestra; 8-8:30, Uda Waldrop, organist; 9-10, studio program; 10-11, Waldemar Lind and the States restaurant orchestra.
KTAB, Oakland, Calif. (240), 4-5 p. m., women's club notes; 8-10, Western States Life Insurance company.

Tuesday, November 3

Headliners Today

Eastern	Central	Mountain	Pacific
8	7	6	5
WEAF (491.5) Davis saxophone quintet.			

Index to Popular Concerts

TABULATED below is a time table of the stations giving popular concerts this week. Stations are divided into the four different standard times in use. The hours are given in the kind of time in use at each listed station. By using this table as an index and referring to the complete programs below, full information will be obtained.

Popular

Eastern Time Stations

Saturday, October 31: 8:30, WGBS; 8:45, WEAF; 9, WEAF, WGBS, WNYC; 9:30, WGBS; 10, WREO; 10:30, WEAF, WRC; 10:45, WEAF.

Monday, November 2: 7:30, WHN; 7:45, WAHG; 8, WGBS; 8:30, WOR; 8:45, WAHG; 9, WCAU, WEAF, WGR, WOO; 9:15, WAHG; 9:30, WGR, WHAZ; 10, WGR, WMCA; 11, WLIT; 11:30, WHN; 12, WAHG; 1, WAHG.

Tuesday, November 3: 7, WMCA; 8, WEAR; 8:30, WMCA; 9, WBZ, WEAR; 11, WHN; 11:30, WHN.

Wednesday, November 4: 7:30, WAHG, WEEL, WHN; 7:45, WAHG; 8, WAHG, WEBJ, WEEL, WGCP, WMCA; 8:15, WAHG, WGCP; 8:30, WEBJ, WGCP; 9, WEBJ, WGCP, WNYC; 9:30, WAHG; 9:45, WAHG, WCAU; 10, WGCP; 11, WHN.

Thursday, November 5: 7:30, WEAF; 8, WCAE, WCTS, WEAF, WFI, WMCA; 8:15, WBZ; 9:30, WCAU; 10, WHN, WNYC; 10:20, WBZ.

Friday, November 6: 7:30, WEEL; 7:45, WAHG, WGY; 8, WGCP, WJR; 8:30, WEEL, WGCP, WHN; 9, WGR; 9:15, WBZ, WGCP; 9:30, WAHG, WHN; 9:45, WGCP; 10, WLIT; 10:30, WHN, WLIT; 11:30, WHN, WTIC.

Central Time Stations

Saturday, October 31: 6:30, WFAA; 7:20, WLS; 7:30, WMBB; 8, WBBM, WENR, WLS, WMAQ; 8:30, WGN, WLS; 9, KPRC, WBBM, WENR, WGN, WMBB; 9:30, WEBH; 10, KFVE, WBBM, WMBB, WOK, WQJ; 10:30, WEBH; 11, KOIL, WBBM, WLS, WQAW, WOK, WQJ; 11:30, WEBH; 11:45, WDAF; 12, WBBM, WEBH, WENR, WOK, WQJ, WSAI; 12:30, WBBM, WEBH, WENR, WOK, WQJ, WSAI; 12:30, WDAF, WOK, WQJ; 1, WBBM, WENR, WQJ.

Sunday, November 1: 7:30, KOIL; 8, WBBM; 9, WBBM; 10:15, KTHS; 11, KTHS; 12, WBBM.

Monday, November 2: 6, WBBM; 6:30, WFAA, WQAW; 6:45, WCCO; 8:30, KFAB, WOK; 9, WMBB, WOK; 9:25, KTHS; 9:30, KFAB; 10, KFAB, KFVE, WMBB, WOK; 10:30, WHT; 11, KOIL, WOK, WOK; 11:45, WDAF; 12, WHT, WOK.

Tuesday, November 3: 6, WQAW; 7:30, KPRC, WBAP; 8, WBBM, WSB; 9, WBBM, WMBB, WQAW; 10,

KFVE, WBBM, WHT, WMBB, WOK, WQJ; 10:15, WSB; 10:30, WGN; 11, KOIL, WBBM, WFAA, WMC, WOK, WQJ; 11:45, WDAF; 12, WFAA, WHT, WQAW, WOK, WQJ; 1, WQJ.

Wednesday, November 4: 7, KFNF, WLS; 7:30, KOIL, WBAP, WHO; 8, WBBM; 8:30, KFAB, WHO; 9, KPRC, WBBM, WHO, WMBB; 9:30, KFAB, WBAP; 10, KFAB, KFVE, KYW, WMBB, WOK, WQJ; 10:30, KYW, WGN, WHT; 10:45, WSB; 11, KYW, WOK, WQJ, WSAI; 11:45, WDAF; 12, KYW, WBBM, WHT, WOK, WQJ; 1, WBBM, WOK, WQJ.

Thursday, November 5: 6:30, WFAA; 7, WOC, WSAI; 7:30, WBAP; 8, WBBM, WHAD; 9, KMA, WBBM, WHAD, WMBB; 9:30, KTHS; 10, KMA, KYW, WBBM, WMBB, WOK, WQJ; 10:03, WLW; 10:30, WGN, WHT; 10:45, WSAI; 11, KOIL, WBBM, WFAA, WOC, WOK, WQJ; 11:20, WLW; 11:45, WDAF; 12, WHT, WOK; 12:15, WLW, WQJ; 1, WQJ.

Friday, November 6: 6:30, WFAA; 8, WBBM, WLS, WOC; 9, WBBM, WDAF, WHAD, WQAW; 9:45, WLS; 10, KFVE, KYW, WOK, WQJ; 10:30, KYW, WGN, WHT; 10:45, WSAI; 11, KOIL, WMC, WOK, WQJ; 11:30, KYW; 11:45, WDAF; 12, WHT, WOK, WQJ; 1, WQJ.

Mountain Time Stations

Wednesday, November 4: 10, KFWA.
Friday, November 6: 10, KFWA.

Pacific Time Stations

Saturday, October 31: 8, KFWE, KNX; 9, KNX, KPO; 10, KFWE; 11, KNX; 11:30, KHJ, KTCL; 12, KNX; 12:30, KHJ; 1, KNX; 1:30, KHJ.

Sunday, November 1: 8, KHJ; 9, KFWE; 10, KFWE.

Monday, November 2: 9, KNX; 10, KFWE; 11, KFWE; 12, KFWE.

Tuesday, November 3: 8, KFWE, KNX; 9, KNX, KPO; 10, KFWE, KNX; 11, KFWE.

Wednesday, November 4: 8, KGW, KPO; 9, KFWE, KNX; 10, KNX; 11, KFWE; 11, KNX.

Thursday, November 5: 8, KHJ; 9, KHJ, KTAB; 10, KFWE, KHJ; 11, KNX.

Friday, November 6: 8, KFWE; 9, KFWE, KHJ, KNX; 10, KFWE, KNX; 12, KFWE, KNX; 1, KNX.

Eastern	Central	Mountain	Pacific
8:15	7:15	6:15	5:15
WEZ (333.1)	Theatrical program.		
9:30	7:30	6:30	5:30
WHAS (399.8)	Zoeller's Melodists.		
	8	7	6
KDKA (309.1)	Little symphony.		
9:30	8:30	7:30	6:30
WCB (344.6)	Mandolin-guitar band.		
9:40	8:40	7:40	6:40
WLW (422.3)	Pumpkin Vine gang.		
10	9	8	7
KPRC (296.9)	Bridge, Lesson 1.		
11:10	10:10	9:10	8:10
KGO (361)	Vladimir Drucker.		
11	10	9	8
KPO (428.3)	Gypsy and Marta.		
1	12	11	10
KNX (336.9)	Movie night.		

Tuesday, silent night for: CFCA, CHIC, CKNC, CNRC, CNRE, CNRM, CNRO, CNRW, CNRT, KFUA, KFRU, KFUD, KFUA, KOA, KOB, KUOM, KWSC, WAHG, WAMD, WBBR, WEAD, WGCP, WHAD, WHAZ, WKAQ, WLIT, WOR, WOS, WSMB, WSUI, WTAM.

Eastern Time Stations

KDKA, Pittsburgh, Pa. (309.1), 6:15 p. m., dinner concert; 7:45, address, University of Pittsburgh; 8, world cruise, Ross E. Skinner; 9, KDKA Little symphony orchestra; Rhenman Whiteside Burnett, contra-tenor; 11:35, Grand theater.
WAFL, Port Huron, Mich. (275), 8-10 p. m., Port Huron Boy Scout orchestra.
WBZ, Springfield, Mass. (333.1), 6:30 p. m., Leo Reinstones; 9-10:30, Lake Merritt Ducks' program, special theatrical program; Charles Hector's orchestra and vaudeville; 9:30, Alandale hour.
WCAU, Philadelphia, Pa. (277.6), 7:30 p. m., recital, N. Snellenburg and company; 8, building and loan

Two Violins and Piano; KOA orchestra; Rosie Rosenblum, Faye Roswell, Cliff Garrison, LuYeta Bortscay-Krohn, pianist; Frankie Nast and Julian C. Riley, violinist; Katherine Morrell, soprano.
KOB, State College, N. M. (348.6), 7:30-8:30 p. m., "Results of an Attempt to Grow Tobacco," Mr. Overbeck; "Electric Power as an Aid to Farming," President Kent.
KWCS, Pullman, Wash. (348.6), 7:30-9 p. m., vocal solos, Glow Williamson; Ruth Faulkner, pianist; Gladys Wren, violinist; Dorothy Sturgis, saxophonist; Fay Morris, banjoist; Edna Daw, drummer; "New Developments in Industrial Chemistry," Prof. J. L. Culbertson; readings.
KFOA, Seattle, Wash. (454.3), 6:45-8:15 p. m., Sherman, Clay and company program; 8:30-10, Times studio program.
KFG, Hollywood, Calif. (238), 8-9 p. m., Maggie O'Shea, the Flannery girl, in Irish and Scotch ballads; 9-10, Hollywood orchestra; David Stuart, baritone; Ruth Chambers, soprano.
KFWB, Hollywood, Calif. (252), 6:30-7 p. m., Altadena program, E. P. Jones; 7, microphone brevities; 8-9, program, Star Motor Car company, Million Dollar Four orchestra, Sol Hoopii's Junior Hawaiian trio; Tom Mitchell, baritone; Debbe; "Talks on Constructive Selling," Neville Rich; "Chats About New Books," Joseph Henry Jackson; "It Pays to Analyze Character," Roscoe D. Wyatt; "National Farm Radio Council."
KGW, Portland, Ore. (491.5), 8-9 p. m., concert; 9-10, Hudson and Essex orchestra; soloists.
KLX, Oakland, Calif. (508.2), 6-7 p. m., Aunt Elsie's Irate Pirate for children; 8-9, program, Piggy Wigley stores; 9-10:30, Lake Merritt Ducks' program.
KNX, Hollywood, Calif. (336.9), 6:15 p. m., travel talk, W. F. Alder; 6:30-7, Atwater Kent Radio Orchestra, Paul Finstein, leader; 7-7:30, Mutual Motors mirth contest; 7:30-8, program, Columbia Out-

talk; 8:30, National School of Oratory players; 8:30, Mae Smith, soprano; Kathryn O'Boyle, pianist; 9, "The Wrong Psychology in Politics," J. W. Stockwell; 9:10, Robert Trueser, gospel singer; Emma Becker, pianist; 9:10, Harry Link and Willie Horowitz, songs and jests; 10:30, Billy Hayes and his Cathay Tea Garden orchestra.
WCX, Detroit, Mich. (517), 6 p. m., dinner concert, Book-Cadillac hotel; 10, The Red Apple club.
WEAF, New York, N. Y. (491.5), 6-7 p. m., dinner music, Waldorf-Astoria; 7:15, Nancy McCord, soprano; lecture, Columbia university; Davis Saxophone octette; Gold Dust Twins; Eveready hour; 11-12, Meyer Davis Lido-Venice orchestra.
WEBJ, New York, N. Y. (272.6), 7-7:30 p. m., Original Mobile quartet; 7:15-8, Sara Turits, soprano; 8-8:10, G. T. Geer, 8:15-8:30, Anthony Wayne, entertainment reporter; 8:35-9:15, dance orchestra.
WEEL, Boston, Mass. (348.6), 2 p. m., Joe Rines and his artists; 6:30, Big Brother club; 7:20, "Air Lines," G. W. Hamblin; 7:30, musicale; 7:45, Harvard Observatory talk; 8, WEAF program, Ross Gorman's Earl Carroll theater orchestra; 8:30, Gold Dust twins; 9, Eveready hour; 10, WEAF Grand opera company.
WGBS, New York, N. Y. (491.5), 6-6:30 p. m., Uncle Geebee; 6:30-7, boys' club program; 7-8, ahead Inn concert orchestra; 8-9, Y. M. H. A. vocational forum; 9:15-9:30, Leona Borrowm, soprano; 10:30-11:30, Arrowhead inn dance orchestra.
WGBU, Fullford-by-the-Sea, Fla. (278), 6:30-7:30 p. m., Eric Steele's orchestra; 10-1, Blue Steele's orchestra; Theresa Horton, pianist.
WGCP, New York, N. Y. (315.6), 3-3:15 p. m., Nat Osborne and Eddle Meredith, songs; 3:15-3:30, Silvio De Rienzo, pianist; 3:30-3:45, Isabelle Henderson, soprano; 3:45-4, Estelle Cohn, songs; 4-4:15, Leslie McLeod, tenor; 4:15-4:30, studio program; 4:30-4:45, William J. Rietz, songs; 4:45-5, Ona Welch, pianist.
WGR, Buffalo, N. Y. (319), 3-3:30 p. m., WGI's afternoon program; 6:30-7:30, Vincent Lugo, 7-8:15, after dance orchestra, Harold Gieser, director; 8-11, jointly with WEAF, including Gold Dust twins and the Eveready hour.
WGY, Schenectady, N. Y. (379.5), 6:20 p. m., American Phonological program; 6:30, Hotel Van Carter orchestra; "Sources of Electricity and Practical Applications," Prof. Peter T. Wolf; 7-7:45, WGY orchestra; Ethel Crookes, contraalto; Margaret E. Waterman, pianist; 10, "The Grand Tour," WJZ; 10:30, W. Spencer Tupman's Hotel Mayflower orchestra.
WHAR, Atlantic City, N. J. (275), 7:30 p. m., book review, Mrs. James Lord; 8, Seaside hotel trio; 11:15, Strand theater organ recital.
WHN, New York, N. Y. (361.2), 12:30-1 p. m., Marsh McCurdy, organist; 2:15-2:15, overture and vaudeville, Loew's State theater; 3:15-4:30, Lexington theater orchestra; 4:30-4:45, Uncle Robert and his pals; 7-7:30, Iceland orchestra; 7:30-8, Will Oakland's Chateau Stanley; 11-11:30, Caravan club orchestra; 11:30-12, Rodeo club orchestra; 12-12:45, Club Kentucky revue and orchestra.
WIP, Philadelphia, Pa. (508.2), 8 p. m., Elliott Lester, dramatic critic; 8:15, talk, Hon. Henry B. Ehlens; 8:30, artist recital; 10:05, Emo's weekly movie; 10:30, Club Pagoda orchestra.
WJAR, Providence, R. I. (305.9), 1:05 p. m., Providence Biltmore hotel orchestra; 7:30, Lloyds orchestra; 8:30, WEAF Grand opera company; 10, Eveready hour.
WJR, Detroit, Mich. (517), 7 p. m., Jean Goldkette Petite symphony orchestra; 9, Jean Goldkette's serenaders.
WJZ, New York, N. Y. (455), 9 p. m., N. Y. Edison hour.
WLWL, New York, N. Y. (288.3), 8 p. m., services, sermon, benediction; Paul's choristers.
WMAA, New York, N. Y. (340.7), 6-6:30 p. m., Olcott Vail and his Hotel McAlpin string ensemble; 6:30-7, Frank Gibbia's Red Lion inn orchestra; 7-8, Jack Wilbur's personalities; 8:30-9:30, Sheppard Knapp musicale; 10-10:15, talk, Darius A. Davis; 11-12, Ernie Golden and his Hotel McAlpin orchestra.
WNYC, New York, N. Y. (520), 7-7:10 p. m., market high spots; 7:10-7:30, the Canadians; 7:30-7:35, police alarms; 7:35-8, the Canadians; 8-9:30, studio program; 9:30-10, Harry Ash's orchestra; 10:10-10:30, lecture, board of education; 10:30-10:35, police alarms and weather forecast; 10:35-11, Harry Ash's orchestra.
WOR, Newark, N. J. (405.2), 3-4 p. m., Fred Koester's Clifford Lodge orchestra; 6:15-6:17, "Words Often Mispronounced"; 6:17-6:30, dinner music, Hotel Shelton; 6:30-7, Man in Moon; 7-7:15, dinner music, Hotel Shelton; 7:15-7:30, sports talk, Bill Wathey.
WPG, Atlantic City, N. J. (299.8), 6:15 p. m., organ recital, Arthur Scott Brook; 7, Hotel Morton trio, J. Leonard Lewis, director; 8, Ethel Rattay Fowler's fashion flashes; 8:15, concert; Cecile Steiner, violinist; Margaret Irwin, pianist; Henrietta Harrison, contraalto; 9, Chalfone-Haddon Hall dual trio; 11, Silver Slipper.
WREO, Lansing, Mich. (285.5), 8:15 p. m., Reo Motor Car company band; Romine Hamilton, violinist.
WTAG, Worcester, Mass. (268), 12:05-2 p. m., luncheon music, WTAG trio; 5:15, Twinkle Twinkle story teller; 8-8:30, Ross Gorman and his Earl Carroll Vanities orchestra, WEAF; 8:30-9, vocal selections, Operatic and Broad; 9-10, WEAF Eveready hour; 10-11, operating concert, WEAF Grand opera company.
WTIC, Hartford, Conn. (475.9), 6:30 p. m., Hub restaurant trio; 7, Laura Gaudet, pianist; 7:20, dinner music; 8, Marechal ladies' quartet; 9, Louis Sokolof,

(Continued on page 27)

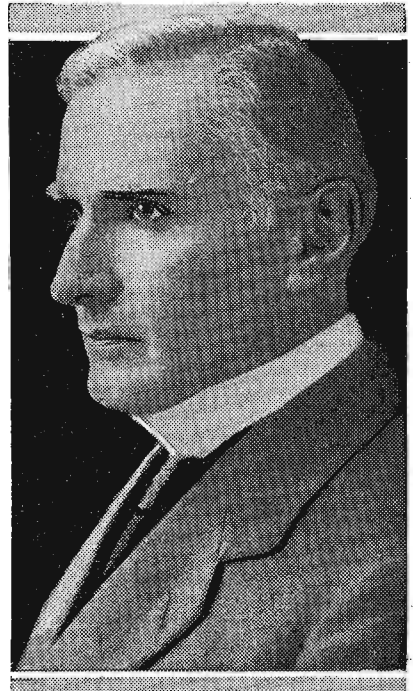

Walter Damrosch, the great American composer and conductor, will be the pianist-conductor in a notable performance of the Kreutzer sonata to be given Sunday, November 8, at WJZ, New York. This program is given the Radio audience through the courtesy of Steinway and Sons.

ELSHUCO TRIO WEDNESDAY AT WJZ

Tuesday, November 3

(Continued from page 26)

violinist; Robert McCarthy, pianist; 9:30, organ recital, Helen Wheeler.
WWJ, Detroit, Mich. (352.7), 6 p. m., dinner concert; 8, concert from WEAF.
Central Time Stations
KFAB, Lincoln, Nebr. (340.7), 3:15-3:45 p. m., matinee musicale; 5:30-6:30, Buick Little Symphony; Belshaw's orchestra; Buick Athletic club; 8:30-10:30, U. of Nebraska musical program.
KFDM, Beaumont, Texas (315.6), 8-10 p. m., musical program.
KFNF, Shenandoah, Iowa (266), 7 p. m., pipe organ concert.
KFVE, University City, Mo. (240), 10 p. m., regular studio entertainers; Orchestra Romana.
KLDS, Independence, Mo. (449.9), 8 p. m., lecture series, Mrs. M. A. Etzenhauser; 8:15, ladies' sextet; Ada McClain, reader.
KMA, Shenandoah, Iowa (252), 6-7 p. m., May Flower orchestra; June and Jim Taylor, Bobbie Ross; lower talk, Lina Ferguson; 9-11, May's Mandolin musicians.
KOIL, Council Bluffs, Iowa (278), 7:50 p. m., Mary Fitzsimmons, soprano; Wilma Millock, contralto; Marjorie Seybert Annis, soprano; Donald Baird, pianist; Betty Zabriske, cellist; Mrs. Karl Werdorff, concert pianist; 8:50, Creighton educational period; "Hospitals," Dr. Herman Von Schulte; 11, College club orchestra.
KPRC, Houston, Texas (296.9), 7 p. m., Billie Mack and his orchestra; 8, Ruth Lloyd Kinney, contralto;

WHAS, Louisville, Ky. (399.8), 7:30-8:30 p. m., Carl Zoeller's Melodists; 8:30-9:20, Georgetown night.
WHO, Des Moines, Iowa (526), 7:30-8 p. m., Raleigh quintet; 8-9, Bankers Life trio; 11-12, Bankers Life Little symphonic orchestra.
WHT, Chicago, Ill. (399.8), 6-7:30 p. m., classical program; Grayling's string trio; Eleanor Gilmore, soprano; Helen Rain, pianist; John Clark baritone; Oscar Heather, tenor; Al Carney, organist; Loftis period; (238), 7:45-9:15, musical features; (399.8), 9:30, Jelte entertainers; Kitchen Klensz Klaxics; Larry Shay, tenor; U. S. L. program; Al Carney, organist; Husk O'Hare's orchestra; 12, Pat Barnes and Al Carney.
WIBO, Chicago, Ill. (226), 6-8 p. m., classical dinner concert; string trio, artists; 12-2 a. m., midnight jamboree.
WJJD, Moseheart, Ill. (302.6) 10 p. m., Ambrose Wyrlick; Rushmore ensemble; 12, Purple Grackie orchestra rebroadcasting.
WLIB, Elgin, Ill. (302.8), 7-8 p. m., dinner concert, Drake concert ensemble; Blackstone string quintet; 9-10, Fred Haum's orchestra; organ recital; 10-11, Jack Chapman's and the Blackstone hotel dance orchestras; jazz artists; 1-2 a. m., Chapman's orchestra and Blackstone hotel dance orchestra; jazz.
WLS, Chicago, Ill. (344.6), 6:30 p. m., Barton organ, Ralph Emerson; 7, lullaby time, Ford and Glenn; 7:15, Lee Ludig, tenor; 7:30, Indian music, WLS trio.
WLW, Cincinnati, Ohio (422.3), 6:30 p. m., Pupils from class of Arnold P. Schroeder; 7:30, the second in a series of O. Henry stories, "Pimenta Pancakes"; 8, The Crosby Feature orchestra in connection with "Harvest Time," 8:20, "Election Night," Hon. Senator Schultz; 8:35, Bob and Jim, Musical Handshakes; 8:40, Uncle Jake Rutz, famous Pum'kin Vine gang, Miami-town, Ohio; 9, concert, Formica Insulation company, William Stoes, director.
WMAQ, Chicago, Ill. (447.5), 6 p. m., Chicago theater

win Piano company; 8, Radio Breezes, KCB; 8:10, KGO Little Symphony orchestra.
KGW, Portland, Ore. (491.5), 7:45-8 p. m., talk; 8-9, educational hour, "Sound Investments," George Burr; style talk; Rose City trio; 9-10, General Cord orchestra; 10-12, dance music.
KHJ, Los Angeles, Calif. (405.2), 6-6:30 p. m., Leighton's Arcade cafeteria orchestra, Jack Cronshaw, leader; 6:30-7:30, history story, Prof. W. S. Hertzog; weekly visit of Queen Titania and Sandman from Fairyland; 7:30, talk on dogs, H. M. Robertson; 8-10, program, Peerless Laundry company, arranged by J. Howard Johnson; 10-11, Art Hickman's Baltimore hotel dance orchestra.
KNX, Hollywood, Calif. (336.9), 6:15 p. m., travel talk, W. F. Alder; 6:30-7, Atwater Keut Radio orchestra.

The Treaty of Portsmouth"; 10-11, Ipana Troubadours; 11-12, Ben Bernie and his orchestra.
WEBJ, New York, N. Y. (272.6), 8-8:30 p. m., Amphion dance orchestra; 8:45-9, Doris Sheldon, contralto; 9-9:30, Busoni's Neapolitan troubadours; 9:30-10, Fred Steele, Billy Hoagney, songs.
WEEL, Boston, Mass. (348.6), 10:45 a. m., "Extravagant Economies"; 3 p. m., "Sculpturo," Cyrus Dallin; 3:15, Johnnie Bowles and his orchestra; 6:30, Big Brother club; 7:30, musicale; 8, Huyler's Bon Bon Buddies.
WEAF, 8:30, Radio Equipment company concert; 9, Waterman's "Points of Progress"; 10, WEAF Ipana troubadours.
WGBS, New York, N. Y. (315.6), 6-6:30 p. m., Uncle Geebee; 6:30-7:30, Yerkes Florida orchestra.
WGBU, Fulford-by-the-Sea, Fla. (278), 6:30-7:30 p. m.,



The Steinway feature for Wednesday, November 4, at WJZ, New York, consists of a program of chamber music by the Elshuco trio. Willem Willecke is the cellist of this famous group, William Kroll, violinist, and Aurelio Giorni, pianist.



Paul Feinstein, leader; 7-7:45, Don Clark and his La Monia dance orchestra; 7:45-8, talk on health, Dr. Robert T. Williams; 8-10, KXN feature studio program; 10-12, movie night at the Ambassador, Ray West's Coconut Grove dance orchestra.
KPO, San Francisco, Calif. (428.3), 6:40 p. m., Waldemar Lind and the States Restaurant hotel orchestra; 7-7:30, Rudy Seiger's Falmouth hotel orchestra; 8-9, U. S. 30th Infantry band; 9-10, Mona Motor Oil company; Mona Motor Oil trio; 10-11, Jack Coakley's Cabarins.
KTAB, Oakland, Calif. (240), 8-10 p. m., program, Mutual Stores.

Theresa Horn, pianist; 10-1, Blue Steele's orchestra; talk on Florida, M. C. Tebbets.
WGCP, New York, N. Y. (315.6), 3-3:15 p. m., Henry Rogers, pianist; 3:15-3:30, Waller, Banks and Raza; 3:30-3:45, Frank Gallast, composer; 3:45-4:15, Clarence Williams trio; 4:15-4:30, Bert Dagmar, songs; 4:30-4:45, studio program; 4:45-5, Charlotte Tyvstmann, pianist; 7-8, Dominio Giger Ale orchestra; 8-8:15, Charol de Thomee, pianist; 8:15-8:20, health talk; 8:20-8:30, Ona Welch, pianist; 8:30-8:45, Hoek and Jerome; 8:45-9, William J. Rietz, songs; 9-9:15, Hughie Woolford, pianist; 9:15-9:30, Nat Osborne and Eddie Meredith, songs; 9:30-9:45, Steiger and Los Carizo, violin and piano; 9:45-10, Win Finger, songs; 10-11, Strickland's orchestra; 11-11:45, Club Richman entertainers; 11:45-12, studio program; 12-12:30, Connie's orchestra.
WGR, Buffalo, N. Y. (319), 2:30-4:30 p. m., WGR's afternoon program; 9-11, jointly with WEAF, including Waterman's Points of Progress and the Ipana troubadours; 11-1 a. m., Vincent Lopez Hotel Statler dance orchestra, Harold Gieser, director.
WGY, Schenectady, N. Y. (379.5), 6:45 p. m., Albany Strand theater orchestra, Julius Boxhorn, conductor; Floyd H. Walters, organist; 7, "Book of Knowledge," program; 8:15, WJZ Steinway series.
WHN, New York, N. Y. (361.2), 7:30-8 p. m., Caravan club orchestra; 10-10:30, Roseland dance orchestra; 11-11:30, Silver Slipper orchestra; 11:30-12, Ed Lewis and his orchestra; 12-12:30, Harry Richman and his Club Richman entertainers.
WIP, Philadelphia, Pa. (508.2), 6:05 p. m., Benjamin Franklin concert orchestra.
WIAR, Providence, R. I. (305.9), 1:05 p. m., studio program; 7:30, U. S. Army band WCAP; 9, Waterman's Points of Progress; 10, musical program.
WJR, Detroit, Mich. (517), 7 p. m., Petite symphony orchestra; 9, Burroughs hour; 11:30, Pettit Jesters.
WJZ, New York, N. Y. (435), 8:30 p. m., Elshuco trio.
WKAG, San Juan, P. R. (340.7), 7-9 p. m., municipal band, Prof. Manuel Tizol, director.
WMAA, New York, N. Y. (340.7), 6-6:30 p. m., Oleott Vail and his Hotel McAlpin string ensemble; 6:30-7:30, Ernie Golden and his Hotel McAlpin orchestra; 7:30-8, Luella E. Burns, soprano; Dorothy Blydenburgh, pianist; 8-9, services, Northminster church; 10-11, Andy Aseultito's Paragon orchestra; 11-11:30, Hofbrau Haus entertainers; 11:30-12, Jack Smith, whispering baritone.
WNYC, New York, N. Y. (526), 6:10-6:20 p. m., market high spots; 6:20-6:30, piano recital; 6:30-7, elementary Spanish lessons; 7:30, advanced Spanish lessons; 7:30-7:35, police alarms; 7:35-8:30, dance program; 8:30-10:30, studio program; 10:30-10:35, police alarms and weather forecast.
WOR, Newark, N. J. (405.2), 6:15-6:17 p. m., "Words Often Mispronounced"; 6:45, dinner music, Hotel Shelton; 7-7:15, sports talk, Bill Wathey; 7:30-8, Vincent Lopez orchestra; 8-8:10, topics of the day, Spencer Armstrong; 9:30-9:45, Sam Siegel, mandolin virtuoso; 9:45-10, talk, Dr. Frank H. Vitzelty; 10-10:15, Sam Siegel; 10:30-11:30, Zit's Central Park Casino orchestra.
WTAG, Worcester, Mass. (268), 12:05 p. m., luncheon music, WTAG trio; 7:15, Twinkle Twinkle story teller; 8, Spanish lesson, Mrs. De La Parra; 8:15, concert program.
WTIC, Hartford, Conn. (475.9), 6:30 p. m., Hotel Bond trio, vocalists; 7:20, dinner music; 10, Bill Tasillo's dance orchestra.
WWJ, Detroit, Mich. (352.7), 6 p. m., dinner concert; 8, News orchestra; 9, program, WEAF.

Wednesday, November 4

Headliners Today

Eastern 8:30	Central 7:30	Mountain 6:30	Pacific 5:30
WHAS (399.8) Virg. Vetter's entertainers.			
KPRC (296.9) Hawaiian travelogue.			
WJZ (455) Elshuco trio.			
9	8	7	6
WEBJ (272.6) Neapolitan Troubadours.			
12	11	10	9
KFWB (252) Old Favorites.			

Wednesday, silent night for: CHIC, CKNC, CNRA, CNRC, CNRE, CNRM, CNRR, CNRV, CNRW, KFAU, KFD, KLD, KOB, KTAB, KTCL, KUOM, WBBR, WCB, WFAA, WFL, WGBS, WHAR, WHAZ, WIP, WLWL, WMC, WOAW, WORD, WPG, WRC, WREO.

Eastern Time Stations
CNRO, Ottawa, Can. (435), 8 p. m., Chateau Laurier concert orchestra; instrumental trio; Mrs. Weston Allan, soprano; Allan Carr, tenor; E. Gosselin, violinist; Chateau Laurier, dance orchestra.
KDKA, Pittsburgh, Pa. (509.1), 6:15 p. m., dinner concert; 7:30, KDKA mailbox; 7:45, U. of Pittsburgh; 8, Dry Slitz hour of music.
PWX, Havana, Cuba (400), concert, General staff band, Cuban army.
WAFD, Port Huron, Mich. (275), 10-12 p. m., musical program, Addison hotel.
WAHG, Richmond Hill, N. Y. (315.6), 12-12:55 p. m., musical program, Billy Eisenhuth's "Lynbrooklyn"; 8:30-8:45, Judith Roth, soprano; 8:45-9, Michael Lamherli, cellist; 9-9:15, James Savell, baritone; 9:15-9:30, Michael Lambert; 9:30-9:45, Judith Roth; 9:45-9:55, Clifford Kilby, banjo; 9:55-10, time signals and weather report; 10-10:15, James Savell; 10:15-11:15, Joe Zimmerman and his orchestra.
WBZ, Springfield, Mass. (333.1), 6:30 p. m., Leo Relsman's Hotel Lenox ensemble; 7:05, Dorothy Morgan, soprano; 7:30, nature story, Thornton Burgess; 8, J. Malcolm Warren, tenor; 8:15, Michael L. Bryant, soprano; 8:30, Steinway Hall program, WJZ; Elshuco trio; Willem Willecke, Aurelio Giorni and William Kroll; 9:30, organ recital, Edith Lang, concert organist.
WCAP, Washington, D. C. (468.5), 7:20-12 p. m., WEAF program.
WCAU, Philadelphia, Pa. (277.6), 7:20 p. m., "Motherhood," Col. Alice V. Herring; 7:30, Lew Chapman and his Hotel Pennsylvania orchestra; 8, stage dancing lesson, Al White; 8:15, U. of Pennsylvania quartet; 9, Hill's instrumental trio; 9:30, health talk; 9:40, popular ditties, Moe and Joe; 9:50, songs, Morris Wager; 10, Penn-Shanery Collegians.
WCK, Detroit, Mich. (517), 6 p. m., dinner concert, Bond-Cadillac hotel; 8, studio program.
WEAF, New York, N. Y. (491.5), 6-7 p. m., dinner music, Waldorf-Astoria; 7-7:30, services, United Synagogue of America; 7:30-8, concert, United States Army band; 8-8:30, "Huyler's Bon Bon Buddies"; 8:30-9, Pooley concert; 9-10, "Waterman's Points of Progress—

organ recital; 6:30, Hotel LaSalle orchestra; 8, "Literary Sidlights," Harry Hansen; 8:20, musical program; 8:40, travel talk, Clara Laughlin; 9, U. of Chicago lecture; 9:20, Western Electric quartet.
WBBB, Chicago, Ill. (250), 7-8 p. m., Trianon duo, Beatrice Teller, Lindsey McPhail, Clarence Jacobs, Mildred Matejka, Jean Ballard, Babi and Barr; artists; 9-11, Trianon orchestra; Dell Lampe, conductor; A. Stephenson, Jimmy Eggert, Woodlawn theater orchestra; Armin F. Hand, conductor; Billie Hoff, popular program.
WOAW, Omaha, Nebr. (526), 6 p. m., classical; 6:30, orchestra; 7:10, Radio review, Neal Jones; 9, father and son program; 9:30, Hansen-Van Brunt company; Florence Long Arnoldi, soprano; 12, Rialto Alarm.
WOC, Davenport, Iowa (483.6), 7:30 p. m., WEAF; 8-9, WEAF; 9:30-10:30, Jeannette Brewbaker, soprano; Robert Lynch, baritone; John McGreevy baritone.
WOK, Homewood, Ill. (217.3), 6-7 p. m., Genevieve B. Burnham, soprano; Clement Laskowski, tenor; Bob Motres, pianist; Banks Kennedy, organist; 10-1, Kraft Harmony boys; Bill Hay, bass; Herman Sinaiko, violinist; Harriet Lee, contralto; Evelyn Johnson contralto; Jack Armstrong, violinist; Carl Stockenberg, harmonica soloist; Banks Kennedy, organist.
WORD, Batavia, Ill. (275), 8 p. m., Webster hotel concert trio; 8:15, Cosmopolitan school of music; 9:15, Bible questions and answers.

WQJ, Chicago, Ill. (447.5), 7-8 p. m., Ralph Williams and his Rainbow Gardens orchestra; Kenneth Sterling, baritone; Fontella trio; 10-1, Ralph Williams and his Rainbow Skylark; Jerry Sullivan; Rose Vanderbosch; Hall Lansing; Everett George Opie; June Lee, comedienne; Bert Davis; Will Rossiter; Merrill Carder; 1-2, Ginger hour.
WSA, Cincinnati, Ohio (326), 7:45 p. m., chimes, Rob-WEB, Atlanta, Ga. (428.3), 8 p. m., Baltimore salon orchestra; 10:45, Cona's Bohemians.
WVOR, Danbury, Conn. (423.3), 8 p. m., microphone Badgley; 8, Everedy hour of music; 9-9:30, Radio Auction Bridge game; 9:30, Fred Raine, tenor; Austin Brothers; Anderson and Schoelver.
WSOE, Milwaukee, Wis. (246), 5:30 p. m., S. O. S. club, Cousin Howard; Elmer Ibrke, pianist; 7:30, musical musings, Miss Mercury; 8:45, philm phancies, Peggy Patton; 9, Milwaukee Institute of Music.
WSUI, Iowa City, Iowa (483.6), 12 p. m., Esco Obermann, tenor; address, George D. Stoddard.

Mountain Time Stations
CFAC, Calgary, Can. (435.9), 7 p. m., bedtime story; 9-11, Canadian National railways programs; Miss Craigon, contralto; Mrs. Thurston, reader.
CNRR, Regina, Can. (336), 8 p. m., Regina Rover Scout band.
KOA, Denver, Colo. (322.4), 12:15 p. m., Rialto theater musicale; 6:30, Herbert White and his Silver State orchestra; 7:30, News-Times concert.
Pacific Time Stations
KFOA, Seattle, Wash. (454.3), 6:45-8:15 p. m., Rhodes Department store; 8:30, program; 9:30-11:30, Eddie Harkness and his orchestra.
KFPG, Hollywood, Calif. (238), 8-10 p. m., KFPG concert orchestra, Tom Mitchell, baritone.
KFWB, Hollywood, Calif. (252), 6:30-7 p. m., Altdana program E. P. Jones; 7, Howard Beall's talk on golf; 7:15, talk by Dr. W. I. Schuster; 7:30, microphone brevities; 8-9, "PEP" program, Kellogg Sales company; 9-10, "PEP" program, H. L. Crockett, Paul Jones, guitar, H. L. Crockett, baritone, Elito trio, Way Watts and ukulele, Louise Sullivan, soprano; 10-11, Warner Brothers frolic, direction Norman Manning.
KGO, Oakland, Calif. (361), 5:30 p. m., "As a Woman Thinketh," Louise Laverdy; 6-7, dinner concert, Bald-

win Piano company; 8, Radio Breezes, KCB; 8:10, KGO Little Symphony orchestra.
KGW, Portland, Ore. (491.5), 7:45-8 p. m., talk; 8-9, educational hour, "Sound Investments," George Burr; style talk; Rose City trio; 9-10, General Cord orchestra; 10-12, dance music.
KHJ, Los Angeles, Calif. (405.2), 6-6:30 p. m., Leighton's Arcade cafeteria orchestra, Jack Cronshaw, leader; 6:30-7:30, history story, Prof. W. S. Hertzog; weekly visit of Queen Titania and Sandman from Fairyland; 7:30, talk on dogs, H. M. Robertson; 8-10, program, Peerless Laundry company, arranged by J. Howard Johnson; 10-11, Art Hickman's Baltimore hotel dance orchestra.
KNX, Hollywood, Calif. (336.9), 6:15 p. m., travel talk, W. F. Alder; 6:30-7, Atwater Keut Radio orchestra.

Theresa Horn, pianist; 10-1, Blue Steele's orchestra; talk on Florida, M. C. Tebbets.
WGCP, New York, N. Y. (315.6), 3-3:15 p. m., Henry Rogers, pianist; 3:15-3:30, Waller, Banks and Raza; 3:30-3:45, Frank Gallast, composer; 3:45-4:15, Clarence Williams trio; 4:15-4:30, Bert Dagmar, songs; 4:30-4:45, studio program; 4:45-5, Charlotte Tyvstmann, pianist; 7-8, Dominio Giger Ale orchestra; 8-8:15, Charol de Thomee, pianist; 8:15-8:20, health talk; 8:20-8:30, Ona Welch, pianist; 8:30-8:45, Hoek and Jerome; 8:45-9, William J. Rietz, songs; 9-9:15, Hughie Woolford, pianist; 9:15-9:30, Nat Osborne and Eddie Meredith, songs; 9:30-9:45, Steiger and Los Carizo, violin and piano; 9:45-10, Win Finger, songs; 10-11, Strickland's orchestra; 11-11:45, Club Richman entertainers; 11:45-12, studio program; 12-12:30, Connie's orchestra.
WGR, Buffalo, N. Y. (319), 2:30-4:30 p. m., WGR's afternoon program; 9-11, jointly with WEAF, including Waterman's Points of Progress and the Ipana troubadours; 11-1 a. m., Vincent Lopez Hotel Statler dance orchestra, Harold Gieser, director.
WGY, Schenectady, N. Y. (379.5), 6:45 p. m., Albany Strand theater orchestra, Julius Boxhorn, conductor; Floyd H. Walters, organist; 7, "Book of Knowledge," program; 8:15, WJZ Steinway series.
WHN, New York, N. Y. (361.2), 7:30-8 p. m., Caravan club orchestra; 10-10:30, Roseland dance orchestra; 11-11:30, Silver Slipper orchestra; 11:30-12, Ed Lewis and his orchestra; 12-12:30, Harry Richman and his Club Richman entertainers.
WIP, Philadelphia, Pa. (508.2), 6:05 p. m., Benjamin Franklin concert orchestra.
WIAR, Providence, R. I. (305.9), 1:05 p. m., studio program; 7:30, U. S. Army band WCAP; 9, Waterman's Points of Progress; 10, musical program.
WJR, Detroit, Mich. (517), 7 p. m., Petite symphony orchestra; 9, Burroughs hour; 11:30, Pettit Jesters.
WJZ, New York, N. Y. (435), 8:30 p. m., Elshuco trio.
WKAG, San Juan, P. R. (340.7), 7-9 p. m., municipal band, Prof. Manuel Tizol, director.
WMAA, New York, N. Y. (340.7), 6-6:30 p. m., Oleott Vail and his Hotel McAlpin string ensemble; 6:30-7:30, Ernie Golden and his Hotel McAlpin orchestra; 7:30-8, Luella E. Burns, soprano; Dorothy Blydenburgh, pianist; 8-9, services, Northminster church; 10-11, Andy Aseultito's Paragon orchestra; 11-11:30, Hofbrau Haus entertainers; 11:30-12, Jack Smith, whispering baritone.
WNYC, New York, N. Y. (526), 6:10-6:20 p. m., market high spots; 6:20-6:30, piano recital; 6:30-7, elementary Spanish lessons; 7:30, advanced Spanish lessons; 7:30-7:35, police alarms; 7:35-8:30, dance program; 8:30-10:30, studio program; 10:30-10:35, police alarms and weather forecast.
WOR, Newark, N. J. (405.2), 6:15-6:17 p. m., "Words Often Mispronounced"; 6:45, dinner music, Hotel Shelton; 7-7:15, sports talk, Bill Wathey; 7:30-8, Vincent Lopez orchestra; 8-8:10, topics of the day, Spencer Armstrong; 9:30-9:45, Sam Siegel, mandolin virtuoso; 9:45-10, talk, Dr. Frank H. Vitzelty; 10-10:15, Sam Siegel; 10:30-11:30, Zit's Central Park Casino orchestra.
WTAG, Worcester, Mass. (268), 12:05 p. m., luncheon music, WTAG trio; 7:15, Twinkle Twinkle story teller; 8, Spanish lesson, Mrs. De La Parra; 8:15, concert program.
WTIC, Hartford, Conn. (475.9), 6:30 p. m., Hotel Bond trio, vocalists; 7:20, dinner music; 10, Bill Tasillo's dance orchestra.
WWJ, Detroit, Mich. (352.7), 6 p. m., dinner concert; 8, News orchestra; 9, program, WEAF.

(Continued on page 28)

JAZZ-CLASSICAL CONTEST AT KOA

Wednesday, November 4

(Continued from page 27)

KPRC, Houston, Texas (296.9), 7:30 p. m., Philharmonic saxophone sextet; 8, Frances Miller, pianist; 8:30, Lawrence H. Damerfeldt, piano; 8, D. Burdick, travelogue; 9, George Jassei, Russian violinist; 11, Mr. and Mrs. V. L. Carcia.

KSAC, Manhattan, Kan. (340.7), 9 a. m., rural school; 12:35 p. m., "The Baby Beef in the Feed Lot," R. W. Kiser; 12:55, "Some Field Results from Gopher Poisoning," A. E. Oman; 4:30, football, basketball, baseball course; 6:35, opportunity talks; 6:50, "Educational Sociology"; 7, "Household Electric Heating Units," R. G. Kloeffler; 7:15, "Efficiency Factors in Power Production," J. P. Calderwood.

KSD, St. Louis, Mo. (545.1), 6:55 p. m., WEAJ chain "Good Will."

KTHS, Hot Springs National Park, Ark. (374.8), 9-10 p. m., Meyer-Davis ensemble; Lon Chassy, violinist; John G. Heyne, pianist.

KYW, Chicago, Ill. (526), 6:35-7 p. m., Uncle Bob's bedtime story; 7-7:30, dinner concert, Congress hotel; 8-9, musical program; Beatrice Archambault, reader; Lawrence Casey, tenor; 10-12:30 a. m., revue; Com Sanders Original Nighthawks; Albert Malotte, organist.

WBAP, Fort Worth, Texas (475.9), 7:30-8:30 p. m., Pauline Hawaiian duo; 9:30-10:45, Fred Calhoun's Texas hotel orchestra.

WBBM, Chicago, Ill. (226), 8-10 p. m., Sunset male quartet; Bert Davis; William Molnaire, tenor; Ted Coleman, cellist; Frances Ingram, contralto; Merry Garden orchestra; Burdette Cleveland, pianist; 12-2, Harold Anderson, accompanist; Montmartre orchestra; Burdette Cleveland, pianist; Charlotte Garland, Nate Caldwell, Eddie Loftus, Uler and Farwell.

WCCO, Minneapolis-St. Paul, Minn. (416.4), 10:45 a. m., "Extravagant Economies"; 2 p. m., woman's hour; 2:30, concert; 4, Readers' club, Eleanor Poehler; 6:30, children's hour; 7, church service; 8, WEAJ program, "Points of Progress"; 9-10, Ipana troubadours; 10:05, dance program; American Hotel orchestra; 10:15, hotel orchestra; 11:30, organ recital, Eddie Dunstetter.

WDAF, Kansas City, Mo. (365.6), 10:45 a. m., Betty Crocker Gold Medal Flour home service talk; 3:30-4:30, Star's string trio; 6-7, address, speaker, Health Conservation association; address, Ralph E. Herrick; Tell-Me-a-Story Lady; Triloum ensemble; 8-10, Star's Radio string orchestra; 11:45-1, Plantation players; Eddie Kuhn's Kansas City Athletic club orchestra; Earl Coleman's orchestra.

WEBH, Chicago, Ill. (370.2), 7-8 p. m., Oriole orchestra; Florence Behrend, soprano; 9-10, Oriole orchestra; Correll and Gosden; Robert York, tenor; 11-1, Oriole orchestra; Correll and Gosden; Robert York, tenor; Oriole orchestra.

WGES, Oak Park, Ill. (250), 5-7 p. m., Betty Bebb and Helen Cameron, vocal duo; McDevitt sisters; pianists; Tiffin theater organ and orchestra; 8-9, Ethel Giese, soprano; Ruth Kalthoff, contralto; Peter Mathews, basso; John Stamford, tenor; Tiffin theater organ and orchestra; 11-1 a. m., Philips twins, vocal duo and ukulele soloists; Tiffin theater organ and orchestra; Sereaders; Morris Hoffman, tenor.

WGN, Chicago, Ill. (370.2), 6:30-7 p. m., Drake concert ensemble, Blackstone string quintet; 8-9, WGN string trio; 10-11, Jack Chapman's orchestra; Blackstone hotel orchestra.

WHAD, Milwaukee, Wis. (278), 6-7 p. m., Arthur Richter, organist; 9-10, Wisconsin Roof Garden orchestra.

WHB, Kansas City, Mo. (365.6), 7-8 p. m., Royal Merry Makers orchestra; Mrs. Allene Spreng, soprano.

WHAS, Louisville, Ky. (399.8), 7:30-9 p. m., Virginia Vetter's entertainers.

WHO, Des Moines, Iowa (526), 6:30-7:30 p. m., Reese-Hughes orchestra; 7:30-9, Kate Miller, whistler; Maude Hughes, accompanist; Old King Cole; Paul Blakemore; Ed Chase, Smith sisters; Harmony girls; 9-10, Corn Sugar orchestra; 10:30-12, dance program.

WHT, Chicago, Ill. (399.8), 6-7:30 p. m., classical program; Pauline Sachs, soprano; Oscar Heather, tenor; Helen Rauh, pianist; Al Carney, organist; Grayling's string trio; (288), 7:45-9:15, musical features; (399.8), 9:30, request organ recital; Hickey and Johnson, harmony boys; Carl Strodel, baritone; Marie Wright, soprano; Leola Laabs, soprano; Al Carney, organist; 12, Pat Barnes, "Your Hour League"; Al Carney.

WIBO, Chicago, Ill. (226), 6-8 p. m., vocalists; 10-12, popular program; Ted Florio and Dan Russo orchestra.

WJJD, Mooseheart, Ill. (302.8), 10 p. m., Ambrose Wyrick; Rose Kutta, Alois Brangola, Purple Crackle orchestra; 12, Purple Crackle orchestra; popular songs.

WLIB, Elgin, Ill. (302.8), 7-8 p. m., dinner concert, Drake concert ensemble; Blackstone string quintet; 9-10, Fred Hamm's orchestra; organ recital; 10-11, Jack Chapman's and the Blackstone hotel dance orchestras; jazz artists; 1-2 a. m., Chapman's orchestra; Blackstone hotel dance orchestra; jazz.

WLS, Chicago, Ill. (344.6), 6:30 p. m., Barton organ, Ralph Emerson; 7, lullaby time, Ford and Glenn; 7:15, WLS solo concert; 8:15, Original Little Symphony orchestra; 9, Charles and Katherine Korvac; 9:30, Mrs. C. W. Anderson, pianist; 9:45, Bate Ballinger, contralto; 10, Celtic quartet in Irish program; 10:45, Ford and Glenn; 11, organ.

WLW, Cincinnati, Ohio (422.3), 12:15, musical program; 7 p. m., concert, Hotel Gibson orchestra, Robert Viscotti, director; 7:30, National Radio Farm council; 8:15, first concert of season by orchestra, Cincinnati Conservatory of Music, Ralph Lyford, conductor; 9:30, soprano solos, Mary L. Cheney, accompanist, Ethel Adkins; 9:45, pianist, Carl Bamberger; 10, the second in a series of "Pup" concerts, University of Cincinnati; Beta Nu Chapter of Beta Theta Pi; 10:30, male quartet; 11:15, Tridyn instrumental trio, William Steeds, violin; Arthur Knecht, cello; Rosemary Stoess, piano and organ.

WMAQ, Chicago, Ill. (447.5), 6 p. m., Chicago theater



Irene Downing gives novelty piano numbers at WKRC, Cincinnati. She is pleasing fans with gay interpretations of classical favorites, which she gives a semi-popular rhythm.

WGCP, New York, N. Y. (315.6), 3-3:15 p. m., Edu Josephs, pianist; 3:15-4, Empire State orchestra; 4-4:15, Richard Wallace Douglas, ukulele, songs; 4:15-4:30, Hughie Woolford, pianist; 4:30-4:45, studio program; 4:45-5, Sylvia Schatz, pianist.

WGR, Buffalo, N. Y. (319), 2:30-4:30 p. m., WGR's afternoon program; 6:30-7:30, Vincent Lopez Hotel Statler dance orchestra, Harold Gieser, director; 8-11, jointly with WEAJ, including Larkintines and the Goodrich Silvertown Cord orchestra.

WGY, Schenectady, N. Y. (379.5), 6:30 p. m., Ten Eyck concert trio; 7:30, book chat, William F. Jacob; 7:45, WGY orchestra; Clarice Warren, contralto; Marion Taylor, accompanist; 8:15, U. S. Army band, WRC; 9:30, Royal hour, WLZ; 10:30, WGY orchestra; 11:30, organ recital, Stephen E. Boisclair.

WHAR, Atlantic City, N. J. (275), 7:30 p. m., "Keeping Well"; 8, Seaside hotel trio; 9, studio concert.

WHN, New York, N. Y. (361.2), 12:30-1 p. m., Lexington organ recital; 3:15-4:30, Lexington theater orchestra; 4:30-5, Miller, Piotti and Val; 6:30-6:40, Leslie McLeod, tenor; 6:40-7, "Sunshine Talks," Billy B. Van; 7-7:30, Iceland orchestra; 7:30-8, Cecil B. Kennedy's quintet; 8-8:30, Will Oakland's Shateau Shantley; 10-10:30, Caravan club orchestra; 10:30-11, Club Kentucky revue and orchestra; 11:30-12, Bandbox revue and orchestra; 12:12-30, Ted Lewis and his orchestra.

WIP, Philadelphia, Pa. (508.2), 6:05 p. m., Club Pagoda orchestra; 8, Sesqui centennial talk, Harry A. Mackey; 8:15, Laserow quartet; 9, Imperial string quartet; 10:05, Joe Ray and the California Nighthawks.

WJAR, Providence, R. I. (305.9), 1:05 p. m., Joe McNamara and his Twin Elm orchestra; 8, the Larkintines; 8:30, Ionic quartet; 10, Goodrich Silvertown Cord orchestra.

WJR, Detroit, Mich. (517), 7 p. m., Jean Goldkette's symphony orchestra; 9, Jean Goldkette's serenaders; 10, Jean Goldkette's Victor Recording orchestra.

WJZ, New York, N. Y. (455), 8 p. m., U. S. Army band.

A. P. McManigal, below, is the chime ringer at WEAQ, Columbus. This picture shows him pulling the ropes which cause the bells to ring.

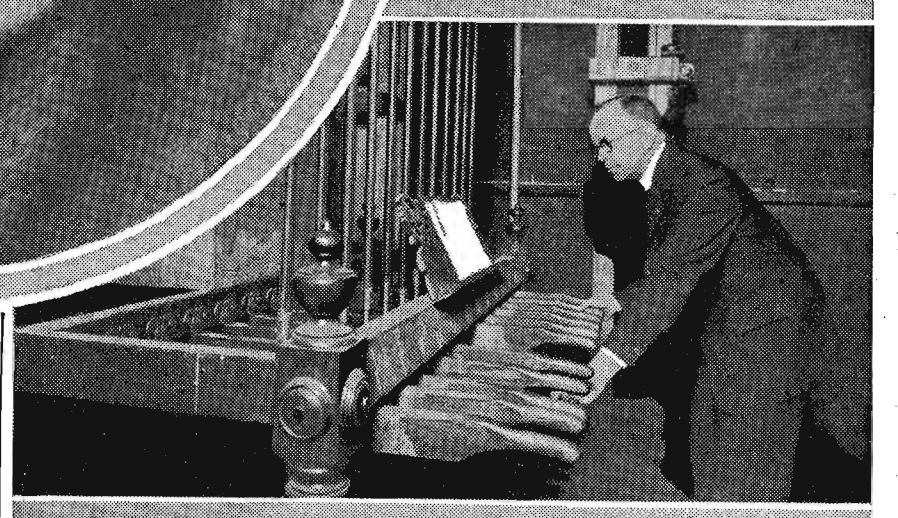

Thursday, November 5

Headliners Today

Eastern	Central	Mountain	Pacific
8:15	7:15	6:15	5:15
WIP (508.2) Laserow quartet.	WKRC (422.3) Russian church music.	8:30	7:30
8:30	7:30	6:30	5:30
KDKA (309.1) With famous composers.	WBAP (475.9) Harmony club.	10	9
10	9	8	7
KTHS (374.8) Negro spirituals.	11	10	9
11	10	9	8
KGO (361.2) Family gathering.	12	11	10
12	11	10	9
WFAA (475.9) Western Electric hour.	12:15	11:15	10:15
12:15	11:15	10:15	9:15
WLW (422.3) Excerpts, popular plays.			

Thursday, silent night for: CHIC, CKNC, CNRA, CNRE, CNRO, CNRR, CNRT, CNRV, KFAB, KFAU, KFDM, KFMO, KFMY, KFNA, KFRU, KFUB, KFVE, KFWA, KGW, KOA, KOB, KTCL, KWSC, PWX, WAFD, WAHG, WCEE, WEAQ, WEBJ, WGCP, WHAD, WHAZ, WJJD, WLIT, WLWL, WOR, WOS, WSUI, WTAM.

Eastern Time Stations

KDKA, Pittsburgh, Pa. (309.1), 6:15 p. m., KDKA Little symphony orchestra; 7:45, address, U. Pittsburgh; 8:30, half hour of famous composers; KDKA Little symphony orchestra; 7:45, address, U. of Pittsburgh; 8:30, Richard Kountz, KDKA Little symphony orchestra; 9, KDKA Little symphony orchestra; Antler male quartet; 11, midnight concert.

WBBR, New York, N. Y. (272.6), 8 p. m., Hawaiian quartet; 8:10, Mrs. B. Brown, soprano; 8:20, International Sunday school lesson, S. M. Sipina; 8:40, Mrs. B. Brown, soprano; 8:50, Hawaiian quartet.

WBZ, Springfield, Mass. (333.1), 6:30 p. m., Hotel Kimball trio; Jan Geerts, director; 7:05, "Backgrounds of English Literature," Dennis A. Dooley; 7:30, announced; 8, musical program, Noyes Buick company; 10:05, McNeely's singing orchestra.

WCAU, Philadelphia, Pa. (277.6), 6:30 p. m., Billy Hayes and his Cathay Tea Garden orchestra; 7:30, Snellenburg symphony orchestra, John A. Carroll, director; 8, Clara Bissel, soprano; Barry O'Moore, Irish tenor; Kathryn O'Boyle, pianist; 9, program; 9:15, Central Radio artists; 9:30, songs of yesterday, Frank Cook; 10, Sesqui Centennial hour.

WCX, Detroit, Mich. (517), 6 p. m., dinner concert, Book-Cadillac hotel; 8, studio program.

WEAF, New York, N. Y. (491.5), 6-7 p. m., dinner music, Waldorf-Astoria; 7-11, services, Greater New York Federation of Churches; Cushman serenaders; the Larkintines; talk, George Elliott Cooley; Silvertown Cord orchestra; 11-12, Vincent Lopez and his Hotel Pennsylvania orchestra.

WEEI, Boston, Mass. (348.6), 3:15 p. m., Jay Riseman and his orchestra; 6:30, Big Brother club; 7:15, "Books and Plays," Sherwin L. Cook; 7:30, Pat Gaffney, violinist; 8, WEAJ Larkintines; 8:30, Pop concert; 9, WEAJ musicale; 10, Goodrich Silvertown Cord orchestra.

WGBS, New York, N. Y. (315.6), 6-6:30 p. m., Uncle Geebee; 7-8, Voltaire hour of music; 8-8:45, Crystal Palace orchestra; 8:45-9, Juanita Stewart; Negro spirituals; 9-10:30, old-time minstrelism; direction, Daily Paskman; 10:30-11:30, Arrowhead Inn orchestra.

WGBU, Fulford-by-the-Sea, Fla. (278), 6:30-7:30 p. m., Blue Steele's orchestra; 10-1, Blue Steele's Fulford-by-the-Sea orchestra; Theresa Horn, pianist.

WKAQ, San Juan, P. R. (340.7), 7:30-9 p. m., music, La Cafeteria.

WMCA, New York, N. Y. (340.7), 6-6:30 p. m., Olcott Vail and his Hotel McAlpin string ensemble; 6:30-6:45, Robert Sofer, pianist; 7-7:30, Joe Chappello's Sunnyside orchestra; 7:30-8:30, Leonard's orchestra; 9:30-9:45, "You and Your Job," Frank G. Wadsworth; 10-10:15, "How to Drive Automobiles," Harry Rainess; 11-12, Ernie Golden and his Hotel McAlpin orchestra.

WNYC, New York, N. Y. (526), 6-7:10 p. m., market high spots; 7:10-7:30, dance program; 7:30-7:35, police alarms; 7:35-8, dance program; 8-10, studio program; 10:10-10:30, talk, Dr. Sydney Neville Usher; 10:30-10:35, police alarms and weather forecast; 10:35-11:35, Hotel St. George dance orchestra.

WOR, Newark, N. J. (405.2), 2:45-3 p. m., talk, Dr. George W. Little; 6:15-6:17, "Words Often Mispronounced"; 6:17-7:15, dinner music, Hotel Shelton; 7:15-7:30, sports talk, Bill Wathey.

WPE, Atlantic City, N. J. (299.8), 6:45 p. m., Arthur Scott Brooks, organist; 7, Alfred Traymore dinner music; 8, "World's Wide Excursions," Alfred James McClure; 8:15, concert; 11, Silver Slipper.

WREO, Lansing, Mich. (285.5), 8:15 p. m., Reo Broadcasting orchestra; Reo male quartet; Rajoan trio; James J. Brown, saxophonist.

WVAG, Worcester, Mass. (268), 12:05-2 p. m., Luncheon music, WTAC; 4:30, indoor Sports club entertainment; 5:15, Twinkle Twinkle story talks; 6:30, Larkintines, WEAJ; 8:30-9, WEAJ Pop concert; 9-10, concert ensemble; 10-11, Silvertown Cord orchestra, Joseph Knecht, director.

WVIG, Hartford, Conn. (475.9), 6:30 p. m., Hub restaurant; 7:30, "November Stars," Prof. Frederick Slocum; 7:45, dinner music.

WWJ, Detroit, Mich. (352.7), 6 p. m., dinner concert; 8, concert from WEAJ.

Central Time Stations

KFNF, Shenandoah, Iowa (266), 7 p. m., concert, Fort Grove farmers, Hortense Kemery, director.

KLDS, Independence, Mo. (440.9), 8 p. m., lecture series, Mrs. M. A. Etzenhauser; 8:15, classical program, Bernice Griffith, soprano; Maude Mildred Evans, pianist; Emily Foley, contralto; Gildred Redfield Connolly, pianist.

KMA, Shonandoah, Iowa (252), 6-7 p. m., flower talk, Lina Ferguson; 9-11, Delmonico Dreamers.

KPRC, Houston, Texas (296.9), 7:30 p. m., Blanchard's dance orchestra; 8:30, Mrs. Sadie Larkins, pianist; Dr. Earle J. Shay, tenor; J. Harry Kobusch, pianist.

KSAC, Manhattan, Kan. (340.7), 9 a. m., rural school; 12:35 p. m., readings; 12:40, "Fowl Typhoid," J. E. Lumb; "Fall Management of Sheep," C. G. Eiling; 4:30, "Community Civics"; 6:30, "Business English," J. O. Faulkner; "The Characteristics of Cotton and Linen," L. McElmurry; "The Influence of Preschool Days," Jean S. Dobbs.

KSD, St. Louis, Mo. (545.1), 6:55 p. m., WEAJ chain "Good Will."

KTHS, Hot Springs National Park, Ark. (374.8), 9-9:45 p. m., negro spirituals, Valentine Quartet Cecil, Robert E. A. Andrews, Bill Valentine, Charles G. Andrews, Paul B. Valentine; 9:45-10, Louis Culp, organist; 10-10:45, New Arlington hotel orchestra.

KYW, Chicago, Ill. (526), 6:35-7 p. m., Uncle Bob's bedtime story; 7-7:30, Congress hotel dinner concert; 7:33-7:53, speeches; 8-8:30, reading, Rev. C. J. Perin; 8:20-9:20, musical program; 9:20, "O Bee (f) Where Is They Sting," John Cutting; 10-11:30, evening at home program; 1-2, symphony club.

WBAP, Fort Worth, Tex. (475.9), 7:30-8:30 p. m., Harmony club; 9:30-10:45, Jack A. Davis, pianist.

WBBM, Chicago, Ill. (226), 8-9 p. m., know the world program; 9-10, Stewart-Warner string quartet; Ziegler sisters; Montmartre; Four Crows quartet; Leona Hayes, harpist; 10-12, Merry Garden orchestra.

WCB, Zion, Ill. (344.6), 8 p. m., marimba quartet; Mrs. A. E. McKee and Mrs. E. Wood; vocal duo; Mark Whiteside, baritone; Mrs. Florence Hill, soprano; Edith Carey, contralto; G. R. Sparrow, tenor; Marion Lee, reader; Mary Ross, pianist.

WCCO, Minneapolis-St. Paul, Minn. (416.4), 12 noon.

(Continued on page 29)



Arthur Comby will be the feature artist Wednesday at WLIT, Philadelphia. Mr. Comby has an unusually fine baritone voice which is well liked in the east.

Thursday, November 5

(Continued from page 28)

concert, Donaldson's orchestra; 2. 'Among the Musicians', H. A. Bellows; 4. Readers' club, Eleanor Poehler; 5:30, children's hour; 7 WEAF program, the Larkinies; 7:30-8, Pop concert; 8, concert; 9, Silvertown Cord orchestra; 10-05, travel talk.

WFAA, Dallas, Texas (475.9), 6:30-7:30 p. m., Baker hotel orchestra; 8:30-9:30, Mrs. Albert E. Smith, soprano; Mrs. Howard Parks, contralto; Mrs. Phillips Jones, pianist; 11-12, Western Electric four.

WJAZ, Chicago, Ill. (322.4), 10-12 midnight, Henry Sopkin, John Baus, violinists; first act of "Mikado," Zenith opera company; George G. Smith; Florence G. Smith; accompanist; Esther Gelo, soprano; Jack Hancomann, pianist; program, E. Warren K. Howe, director.

WJLB, Birmingham, Ala. (302.8), 10 p. m., Lols White, Elizabeth Peppers, Ambrose Wyrick, Ruth Allanson; 12, Purple Grackle orchestra, popular songs.

WJPD, Jacksonville, Fla. (302.8), 7-8 p. m., dinner concert, Drake concert ensemble, Blackstone string quintet; 9-10, Fred Hamer's orchestra; organ recital; 10-11, Jack Chapman and the Blackstone hotel dance orchestra; jazz artists; 1-2 a. m., Chapman's orchestra; Blackstone hotel dance orchestra, jazz.

WJSD, San Diego, Calif. (428.3), 8 p. m., entertainment; 10:45, football finale, Howard Backstake bunch.

KFWB, Hollywood Calif. (252), 6:30-7 p. m., Aludena program; E. P. Jones; 7:30, microphone brevities; 7:50, Jack Boaz, fishing scout; 8:30, program, Starr Piano company, Hollywood Rhythm Kings, Ina Mitchell Butler, soprano and Estelle Shake, blue singers, William Mays, pianist and others; 9-10, program, Don P. Smith, Inc., Diana-Moon orchestra, Dan Gridley, tenor, Sol Hoopii's Hawaiian trio, Ashley sisters, Salvine Balano, violinist; 10-11, Warner Bros. radio, direction Norman Manning.

KGQ, Oakland, Calif. (381), 8 p. m., Sherman, Clay & company, honor Dr. James L. Gordon; Margaret Raas Waldrop, soprano; Uda Waldrop, pianist; Josephine Holob, violinist; Margaret Avery, cellist; Joyce Barthelsson, pianist; Helen O'Neal, soprano; Allan Wilson, tenor; 10-12, Ben Black's orchestra.

KHJ, Los Angeles, Calif. (405.2), 6-6:30 p. m., Leighton's Arcade cafeteria orchestra, Jack Cronshaw, leader; 6:30-7:30, history story, Prof. W. S. Hertzog; Dickie Brandon, screen juvenile and Uncle John; 7:45, talk on health, Dr. Philip M. Lovell; 8-10, program, Pacific Electric Railway company, arranged by J. Howard Johnson; 10-11, Art Hickman's Biltmore hotel dance orchestra.

KNX, Hollywood, Calif. (336.9), 6:15 p. m., travel talk, W. P. Alder; 6:30-7, Atwater Kent Radio orchestra, Paul Finstel, leader; 7-8, program, Elite trio, H. L. Crockett, baritone; 8-10, KNX feature studio program; 10-11, Ray West's Coconut Grove dance orchestra from Ambassador hotel.

KPO, San Francisco, Calif. (428.3), 6:40-7 p. m., Waldemar Lind and the States Restaurant orchestra; 7-7:30, Rudy Seiger's Fairmont hotel orchestra; 8-9, George W. Caswell Coffee company; Radio Eight symphony orchestra; 9-10, studio program; 10-11, Jack Coakley's Cabriians.

KTAB, Oakland, Calif. (240), 8-9 p. m., program, Olympic club; 9-10, California Transit company.

Friday, November 6

Headliners Today

Table with 4 columns: Eastern, Central, Mountain, Pacific. Lists station call letters and program titles like 'Petite symphony', 'Artist organ recital', 'Herring Motor band', etc.

Friday, silent night for: CHIC, CKNC, CNRC, CNRM, CNRO, CNRR, CNRT, CNRW, KFMQ, KFRU, KFUD, KGO, KLDL, KOB, KPRC, KUOM, WAFD, WBBR, WBCB, WBAO, WFI, WGBS, WHAZ, WIP, WKRC, WLV, WOR, WRC, WRRO, WSAI, WSMB, WSUI, WTAM.

Eastern Time Stations
CNRA, Moncton, Can. (291), 8:30 p. m., CNRA orchestra; Walter Neale, tenor; Mrs. W. A. Fitch, violinist; Markowski trio; Jack Powell, tenor; E. Schofield, bass; Lucien Labelle, cellist; P. Dupuis, Major A. V. MacCallum; E. C. Girvan, baritone; comedy, Jack Grace, Jack Powell.

WMAQ, Chicago, Ill. (447.5), 6 p. m., Chicago theater organ recital; 6:30, Hotel LaSalle orchestra; 8, garden talk, James Burdett; 8:15, financial talk; 8:30, talk; 9, U. of Chicago lecture; 9:20, musical program; 9:40, P. U. League of Nations association.

WMAO, Chicago, Ill. (447.5), 6 p. m., Chicago theater organ recital; 6:30, Hotel LaSalle orchestra; 8, garden talk, James Burdett; 8:15, financial talk; 8:30, talk; 9, U. of Chicago lecture; 9:20, musical program; 9:40, P. U. League of Nations association.

AN EVENING AT HOME WITH THE LISTENER IN CENTRAL TIME

Main table with columns: Call, Location, Met., Saturday, Sunday, Monday, Tuesday, Wednesday, Thursday, Friday. Lists various stations and their broadcast schedules.

STATIONS IN ORDER OF WAVE LENGTHS USED

Table with 6 columns: Meters Call, Meters Call, Meters Call, Meters Call, Meters Call, Meters Call. Lists stations and their corresponding wave lengths.



The Mark of
quality whether
you buy or build!

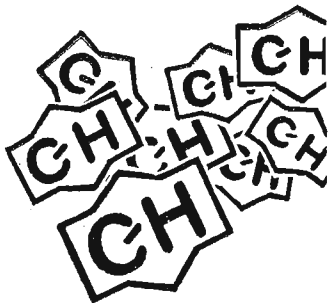
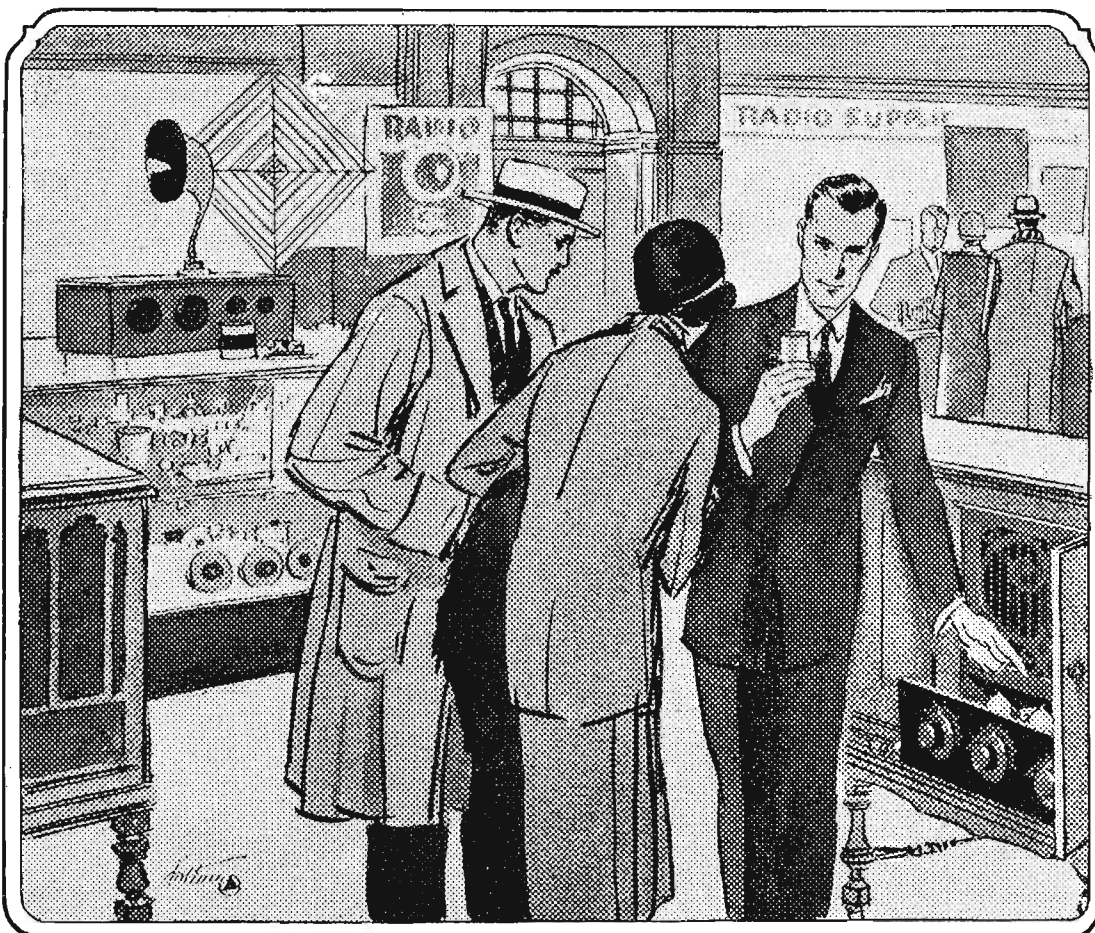

Manufacturers know by careful testing what fans have learned from experience

A list of some of the
prominent radio
manufacturers using
C-H products

Acme Apparatus Co.
American Bosch Magneto Co.
Astral Radio Corporation
Boissier Radio Corporation
Chelsea Radio Co.
Crosley Radio Corporation
Dayton Fan & Motor Co.
Dictagraph Products Co.
Dubilier Condenser & Radio
Corporation
Electrad, Inc.
Freed-Eisemann Radio Corp.
Garod Corporation
Gilfillan Bros., Inc.
Allen T. Hamscomb
Harding Mfg. Co.
Howard Radio Co.
The Keyport Laboratories
King Electric Mfg. Co.
Kodel Radio Corporation
LeMor Radio, Inc.
Magnus Electric & Radio Co.
Malone-Lemmon Laboratories
Glenn L. Martin Co.
Wm. J. Murdock
Newport Radio Co.
Phanstiehl Mfg. Co.
Philadelphia Storage Bat. Co.
Radio Master Corp. of America
The Radio Compak Co.
R. B. Radio Co.
Robbins Radio Co.
Signal Electric Co.
Silver-Marshall Co.
Simplex Radio Co.
R. E. Thompson Co., Inc.
J. S. Timmons
Workrite Mfg. Co.
Zenith Radio Co.

YOUR new radio set can have C-H quality *whether you buy or build.* Today, reliable dealers everywhere carry C-H radio parts because fans have learned by experience to demand this trade-mark that insures proper design—highest quality at lowest cost.

But most of these dealers also sell radio sets and accessories that incorporate this same high C-H quality. Radio manufacturers have learned by careful testing what fans already know from experience—the economy of good parts.

Whether you buy or build—the C-H trade-mark on the parts of your radio set is a guarantee of satisfaction.

THE CUTLER-HAMMER MFG. COMPANY

Member Radio Section, Associated Manufacturers
of Electrical Supplies

MILWAUKEE, WISCONSIN

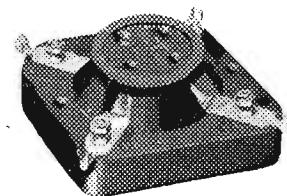

The New C-H UX Socket
for the new UX tubes. Same C-H one piece, silver plated, double grip contacts as in standard socket. Heat proof Thermoplax body—terminals cannot loosen under heat of soldering iron.

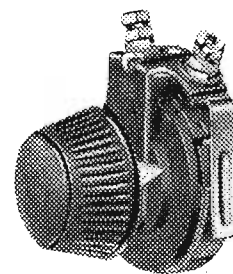

The Perfected C-H Rheostat
Designed to radio engineers' specifications. Revolving drum type with one hole mounting. All spring tensions adjusted at factory and undisturbed by mounting. Instrument cannot turn on panel. Very small size—less than 3/4 inch back of panel and narrower than standard socket. Operation smooth and quiet. 6 ohms, 15 ohms, and 30 ohms—perfect control for all tubes and their combinations.

CUTLER-HAMMER

Radio Parts for Performance

FOLLOWING SPORTS THROUGH MIKE

Pulitzer Cup Race on Four Different Waves

Airplane Transmitter, WGMU, WAHG and WBOQ Broadcast

RICHMOND HILL, N. Y.—When Lieut. Cy Bettis rushed through the air at a four-mile-a-minute clip to win the Pulitzer cup race at Mitchell Field recently, Radio fans far distant from the scene heard the whir of the motors and the announcements of the judges over the air. WAHG and her smaller sister, Station WBOQ, rebroadcast the entire meet from the pick-up of WGMU, the Grebe portable automobile 65-meter transmitter.

The race description really underwent a triple broadcast. The voice of Wrigley Douglas rode on one wave from a plane encircling the course. This was picked up by the automobile and sent over the 65-meter wave from which the Richmond Hill stations picked it up and put it out on the 316- and 236-wave lengths.

The announcer in the plane described the machines in the races and the crowds below. This was sent out on a wave of 440 meters and many fans in New York city and vicinity were able to pick up the direct broadcast. Fading was noticed when the transmitting plane changed course due to trailing antenna.

Football Broadcasts

Saturday, October 31

- Ames-Missouri, KFRU (499), WOS (440.9).
- Cincinnati-Dayton, WSAI (325.9).
- Holy Cross-Bucknell, WBZ (333.1), WTAG (268).
- Iowa State-Wabash, WSUI (483.6).
- Marquette-Creighton, WHAD (275).
- Michigan-Navy, WJR (517), WWJ (352.7).
- Minnesota-Wisconsin, WCCO (416.4).
- Nebraska-Oklahoma, KFAB (340.7).
- Northwestern-Indiana, KYW (535.4), WBBM (226), WMAQ (437.5).
- Ohio State-Wooster, WEOA (293.9).
- Pennsylvania-Illinois, WGY (379.5), WJZ (454.3).
- Pittsburgh-John Hopkins, KDKA (309.1).
- Queens-Varsity, CFCA (356.9).
- Southwestern U.-Rice Institute, KPRC (296.9).
- Vanderbilt-Mississippi, WSM (282).
- U. of Washington-Washington State College, KFOA (454.3).
- Yale-Army, WEAJ (491.5), WGR (319), WJAR (305.9).

WHAD Joins Ranks of Sport Announcing Radio Stations

MILWAUKEE.—The Marquette University-Milwaukee Journal station, WHAD, is broadcasting Milwaukee local football games play-by-play. Broadcasting is done by the Journal's sporting news organization. The majority of the Marquette games are being put on the air.

On the following dates football games will be broadcast:

- October 31, Marquette University-Creighton.
- November 7, Marquette University-Kansas Aggies.
- November 14, Marquette University-South Dakota Aggies.
- November 21, Marquette University-North Dakota.

WHO Gives Series to Show

DES MOINES, IOWA.—Over three thousand people daily listened to special play-by-play reports of the world's series broadcast by Station WHO here and amplified by a special outfit in a truck at the Iowa industrial show held in the coliseum.

NEW REMOTE CONTROL ADDED TO KPO STRING

Legion of Honor Palace Organ to Be Heard

SAN FRANCISCO.—Another new remote control connection will be added in the immediated future to those of Station KPO, Hale Brothers and the San Francisco Chronicle, when the new California Palace of the Legion of Honor will be linked to the local broadcaster.

The Legion of Honor Palace, the gift to the city of the late A. E. Spreckels and Mrs. Alma de Bretteville Spreckels, is one of the show places of the city and houses a \$100,000 organ, especially built and presented to the city by John D. Spreckels. Music from this organ will be picked up as also will be other musical features produced at the palace under the direction of Marshall W. Giselman.

In addition to this new connection, KPO is linked with the San Francisco Civic Auditorium, the Palace and Fairmont hotels, Loew's Warfield theater, the Cabiria cafe and the States restaurant.

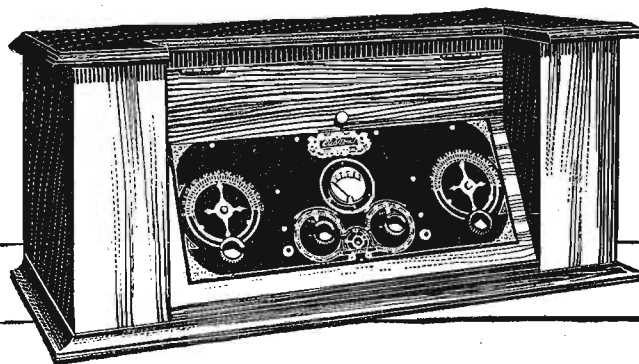

A Wonderful New Loop Set For Dry Cell Operation

Sold complete by a reliable manufacturer with seven tested tubes, batteries, loop, loud speaker. There is nothing else to buy.

Prices \$185 to \$275

This remarkable new set which requires no outdoor antenna or ground wire, brings in distant stations on the Loud Speaker, and reproduces music and voice with beautiful tone. It can be readily moved to any room in the house.

It is offered by an old line reliable radio concern, which selects and tests and installs all equipment in the set before it is shipped. You are sure that every part is good and that they all work together properly.

Clearitone Complete radio sets have beautiful cabinet work; they are made of the finest material by careful workmanship. In performance the set equals the best sets that work on an outdoor aerial and wet batteries. Current consumption is low. Dry cell operation makes it very desirable for the farm or the apartment house. Ask your nearest radio dealer to arrange for demonstration.

- Model 90 Table Type with detached Loud Speaker \$185 Complete
- Model 91 Table Type with built in Loud Speaker \$200 Complete
- Model 92 Console with built in Loud Speaker \$275 Complete

DEALERS: You need this set to complete your line. You can demonstrate it anywhere and the demonstration sells it. Strong newspaper advertising and other helps given in your own locality. Protected territories.

The Clearitone Radio Company
2435 Gilbert Ave.
CINCINNATI, O.

CLEARITONE Complete RADIO SETS

The New

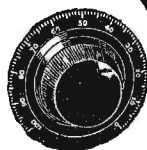
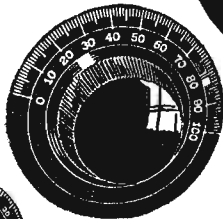
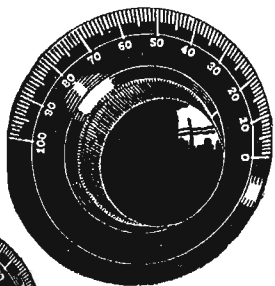

See Our Booth No. 3, Section T at the Chicago Radio Show Nov. 17-22

Kurz-Kasch Aristocrat Line

Quality stands right out in Kurz-Kasch products. The smooth, lustrous finish, the clear cut markings, the even edges and perfect moulding stamp them as quality products.

Radio Manufacturers in ever increasing numbers are turning to Kurz-Kasch for their requirements. Ask your dealer to show you the Kurz-Kasch line—they beautify and improve your set. Ask him to demonstrate the Kurz-Kasch patented split bushing method of mounting dials, knobs, etc.

"Aligns rite—Holds tite"

- Dials
- Knobs
- E-Z-Toon
- Potentiometers
- Rheostats
- Sockets
- also
- Special Moulding from mfgs. specifications.

Kurz-Kasch products have this trade-mark



moulded in them. Insist on the genuine.

THE KURZ-KASCH COMPANY
Largest Exclusive Moulders of Bakelite
Factory and Main Office, Dayton, Ohio

Radio Digest Illustrated

Published by the Radio Digest Publishing Company, Inc.
510 North Dearborn Street
Chicago, Illinois
Telephones: State 4372, 4373, 4374, 4375

E. C. RAYNER, Publisher

Eastern Office, Park-Lexington Building, 247 Park Ave.,
New York. Telephones: Ashland, 8144, 8145, 8146

Member of the Audit Bureau of Circulations



PUBLISHED WEEKLY

SUBSCRIPTION RATES

Yearly in U. S. and Possessions and Canada, \$5.00
Foreign postage, \$1.00 additional. Single copies, 10 cents.

Vol. XV Saturday, October 31, 1925 No. 4

Let Them Have a Million?

WE ARE searching for a plan—something that will help to get the public thoroughly aroused—and we wonder if perhaps one of our readers hasn't the key to the situation in his or her mind? How can we arouse the great American Radio public to a danger which threatens it seriously, yet so indirectly that the talons of the GROPING OCTOPUS are successfully camouflaged?

The American Society of Composers, Authors and Publishers is beginning to wield its powers, permissible under the present copyright law so it seems, to extract ONE MILLION DOLLARS from the broadcasting stations THIS YEAR.

Those of us who were listening in two years ago remember the exposure Radio Digest made of the society's tactics. Poor old CONGRESS, blinded by a lavish lobby of expert actors whose role (assigned by the society) was to imitate impoverished music publishers, and starving writers, FAILED TO ACT.

The society of publishers, song writers and verse producers have been very active since that time.

License fees, varying with the ability of each station to pay, have been assessed. Believing in the honesty of the society, many stations have paid the fees. Then, after purchasing the right to broadcast copyrighted music controlled by the society, the many and various lawyers (the society seems to be made up of a great many lawyers) retained in different parts of the country, have notified the licensed stations, it is reported, that certain numbers were recalled and could not be broadcast.

You buy something, then you find the selling firm has left several holes in the contract, by which the selling firm can acquire back exactly what you bought without refunding to you in the least!

There is no fair and uniform system in the sales of American Society music licenses. There is no assurance that you get what you buy—it can be taken away from you whenever the society desires. THERE IS NO ASSURANCE THAT THE FEE WON'T BE DOUBLED, TREBBLED OR QUADRUPLED THE NEXT YEAR when your present license expires, and you wish a renewal.

If you are making more money, you are going to be hit that much harder by THE OCTOPUS.

Broadcasters, this publication, and the public also, we are sure, are all in favor of making the American Society adopt business ethics in their dealings with broadcasters.

We contend that broadcasters are entitled to as much fairness in buying the right to broadcast music, as is accorded by the copyright law to music roll and phonograph record manufacturers who buy the right to make records of the music. A DEFINITE FEE is FIXED BY THE LAW in the latter case.

CONGRESS MUST ACT, and we, like a contemporary editor who has risen to defend the right, want to know how to ROUSE THE PUBLIC so that CONGRESS WILL ACT.

Amateurs on Decrease. Why?

ACCORDING to the Radio section of the department of commerce, there were 340 less American amateur transmitting stations licensed during the fiscal year than a year ago. The number of amateurs is now 15,110. For some reason amateur Radio is decreasing in popularity. Why?

Perhaps many boys (and girls—some have taken Radio very seriously), who would otherwise have taken out licenses, have become content to experiment with broadcast reception and so have not bothered to learn the code or dabble in transmission. Their technical interest is satisfied by the construction of receivers and the reception of broadcasting stations. In the old days they would have to learn the code before they could understand or be understood.

Perhaps a few less licenses have been issued to transmit, but we dare say that the number of intensive, earnest experimenters in Radio has increased manifold over last year's figure. The experimenting, more on the side of reception than transmission, is naturally being done without transmitting licenses.

RADIO INDI-GEST

A Radio Dinner

Today it's fun to get dinner
While tunes fly through the air;
It lightens the burden of housework,
To tune in anywhere.

There's jazz from California
And concerts from the east;
A good barn dance from 'way down south,
While I prepare the feast.

While some nights I get the dinner
With tunes from 'ol New York;
Though way out in 'ol Missouri,
I'm roastin' piggy pork.

RHEA SHELDON.

Oh, Rhea, please have a heart for a lonely man who just dotes on roast pork! If our battery was not a complete wreck we would turn on the set some evening, instead of patronizing the Greek restaurant around the corner, and tune in a Kansas City station. Then we might be listening to the same music that is helping the apple sauce garnish your "piggy pork."

Dope This Out

A man's year in this country is a busy one. He
Sleeps 8 hours a day.....2,920 a year
Rests 8 hours a day.....2,920 a year
Eats 3 hours a day.....1,095 a year
52 Sundays of 24 hours.....1,248 a year
52 half days Saturdays.....624 a year
Vacation of 14 days.....336 a year
Total time enumerated is 9,143 hours a year. 365 days of 24 hours each is 8,760 hours. Leaving a deficit of 383 hours which are spent listening for DX on a crystal set. No provision is made for work, so it ain't such a bad world after all.

STATIC TISHAN.

"Yes, Sir, That's My Baby" is fast passing into that overworked class so infamous for such numbers as "Three O'clock in the Morning," the Mammy songs, "Sally" and "See You in My Dreams." We heard a man (baritone, tenor, basso, or something, so alleged) go through the words of that baby song from WWAB the other night and if he really was singing (?) about a "baby" she is no doubt on her way to China or some other place where she will never hear him warble again. He takes any prize that might be offered for the worst jazz singer on the air, (except ourself).

"PRESENTS HUBBY WITH NEW LOUD SPEAKER"—so read a headline in a Chicago paper telling of the birth of a son to the wife of a Radio editor. The copy-reader who wrote that head must be a bachelor. You can shut a loud speaker off at will!

X-Y-Z Course in Radio Funnymenals

Chapter MXXV—Two Cylinder Engines

By London Bobby

All those who are still interested in the wireless craze are discussing the new principles worked out by Mr. Chapman. Among other things, Mr. Chapman has discovered that there is no layer in the upper atmosphere, but only a dense electronic field.

Now, as I see it, this will mean the transference of the latitudinal orbit on to a longitudinal plane, which, while varying the frequency of magnetic penetration and control, will considerably change inductances, without the relay, which is a

component of downward reflection, nor should the alternative beam, which, by short valves, directs the ray from the latter to the former, thus modifying the heat generated in the tuning crystal, whereby the Gulper theory is extended from the coils and directional atmospheres.

An interesting development, you must admit. The diagram shows a section of a major inductance after transmission.

*Draw your own diagram from clear explanation given, our artist is too busy building set described.

Advice for Actors

Actor, after listening to broadcast of "Hamlet"—
"That, my boy, is the way I want to do 'Hamlet' next time—by Radio. They can't throw things at one then!"
SHAKE S. PEAR.

We Donut No!

Dear Indi: It is about time for someone to kick in with a pun about the loss of a doughnut coil being less than the volume of the hole left in a doughnut after the outer ring has been properly dunked and devoured. By the way, will you be at the Chicago Radio Show?
CAP.

Yes, we will be at the Chicago Radio Show, thinly disguised as the contents of a one time full stein that has been within reaching distance of the left mit of the Third Trombone Player. Please leave all bouquets at the boxing office, free list suspended.

RADIO EPITAPHS NO. 1

BY THE THIRD TROMBONE PLAYER

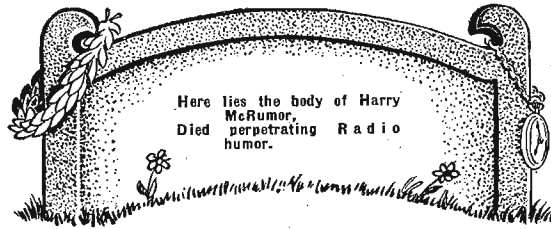

News of the Week



STRICTLY AMERICAN MODEL

"KIM OF THE WORLD" KFXB WILL REBROADCAST.

Condensed BY DIELECTRIC

WBZ was on the air recently with an orchestral program of good selections, if a little frayed in parts. Of all the numbers played that evening there can be no doubt of the place the famous march from the opera "Aida" held. It is a number full of pomp and grandeur to which the musicians lent their skill with pleasing results. However often this march is played (if at all acceptably) you don't feel bored.

On an evening when most of the stations were paying their respects to jazz, WTAM, Cleveland, presented a program rendered by their efficient orchestra of pieces more or less classical. The director of the orchestra had no difficulty with a group of pieces arranged and composed by that king of violinists, Fritz Kreisler. Whether he had carefully studied the phrasing of this master or not, the evidence tends to show a thorough familiarity with it and is deserving of praise.

If the object of the Fitzgerald company kitchen brigade is to bring to that culinary department of the household an atmosphere free of drudgery, they succeed in no small measure. Their male quartet is by no means amateurish in performance with voices that blend well and a regard for the ensemble effect. Songs familiar to every listener, old or young, made a pleasing contrast to some of the stuff owned and "leased" by the society of authors, composers and publishers. These very men are intent on crippling broadcasting. We listeners must awaken. Tune to WHT, Chicago!

Rather an interesting program was given to the Radio audience from station WEBH, when the members of the station's light opera company entertained with some old favorites. Many of Victor Herbert's light operas will hold an important place on concert programs over years to come. A well trained company can prove considerable of an addition to any broadcast program. There are lots of good scores to choose from.

One of the largest times ever had in the city of Omaha, Nebr., was due to the convention of the American legion meeting there. Fans who could tune Omaha stations were privileged to hear President Coolidge and a varied program presented throughout the sessions. Among all such features none was more entertaining than the program which the Cedar Falls band offered, chief in musical interest of the numbers was the "Oriental Love Dream," steeped in the oriental idioms.

WJR, Pontiac, Mich., devoted a part of a program to the singing of operatic selections by soloists of fair attainment. Particularly unfortunate was the work of a tenor whose fear of singing flat, put him a half-tone sharp in nearly all of his efforts. There were some good duets, but it was not a real grand opera cast, and in saying that I do not compare the singers with the world's best at all. Maybe another time they will have improved somewhat. Try it again.

WEAF, New York, recently turned their mike over to the official musical critic for the government of Great Britain who gave to the listeners a valuable and interesting talk. What the gentlemen said of the musical development of people in every land where Radio programs are presented is highly encouraging. He showed how this great medium had introduced the classics to folks for the first time and that listeners were more and more showing a preference for music of lasting quality. He also admitted receiving adverse criticisms.

Interesting and Simple Explanation of Radio

Chapter I—An Understandable Analysis of Electricity

By H. G. Tanner, Associate Professor University of Oregon

THE thrill of sitting night after night before an innocent looking cabinet and listening to musicians hundreds or thousands of miles away has shaken the imagination of everyone. Some are content to let it remain a mysterious marvel, even shunning any explanation for fear such might reduce it to the commonplace.

But many others desire to know how it works, and never regret the effort required to learn. In this series of articles about Radio it is intended to present the underlying principles in the most elementary terms. An attempt will be made to answer such questions as:

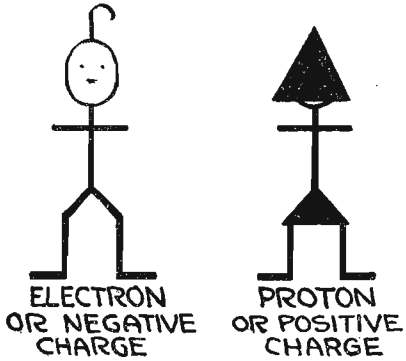

The electron and proton are here illustrated as the figures "Joy" and "Gloom." mentary terms. An attempt will be made to answer such questions as:

How is an ether wave produced? What is a modulated carrier wave? What happens when an ether wave strikes a receiving antenna? How is music obtained from ether waves?

But before these questions can be answered it will be necessary to make sure the reader has in mind a few clear cut conceptions about what electricity is, where it is found, and how it behaves.

Electricity in Wood, Stars, Rocks, Etc. There are many who are accustomed to associate electricity only with lightning, dynamos, batteries and cats' backs, but

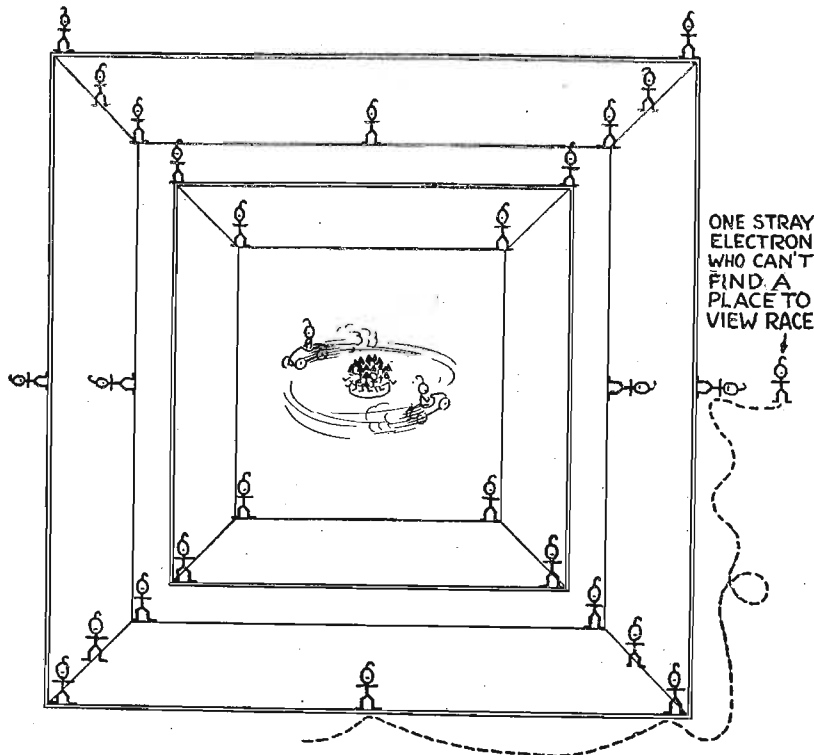

If one would form the above picture of the Copper atom, perhaps its atomic structure and the electron theory would be far more simple to understand.

as a matter of fact electricity is also present in wood, water, rocks, rubber, salt, stoves, and stars. The list is not complete because such a list would include the names of all known substances.

During the past 25 years scientists have been able to find electricity in everything, and have come to the conclusion that matter not only contains electricity, but that matter IS electricity.

It is only when some of this electricity is out of its usual place that we notice it. Thus when a cat's back is rubbed vigorously, some of the electricity is dislodged from its usual place and the sparks which we see are the effects produced when this electricity is jumping back home.

There are two varieties of electricity and, since they have opposite characteristics, they are called positive (+) and

negative (-). Not much is known about the positive variety, but considerable is known about the negative kind.

Electrons and Protons

Both exist in the form of grains like grains of sand, only they are incomparably smaller. They are the smallest things known and it is truly remarkable that their dimensions have been measured. The grain of negative electricity is called an electron and the positive grain is called a proton.

The electron is so small that it would take 60,000,000,000,000 (sixty trillion) of

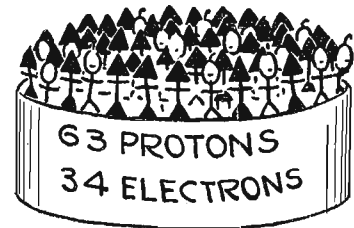

The above is a close-up of the "grand stand" or nucleus of the Copper atom.

them side by side to make a row an inch long. Counting rapidly without ever resting it would take a person about 60,000 years to count this number.

Nature Builds Atoms from Electricity

Nature uses these two kinds of electricity to construct what are called atoms. These atoms in turn are the bricks of which all familiar substances are built. Eighty-eight varieties of atoms are known and they differ from each other chiefly in regard to the quantity and distribution of the electricities which they contain.

In their ordinary condition all atoms contain just as much positive electricity as negative. In other words they are electrically neutral. All the protons are always located at the center of the atom

(Continued on page 44)

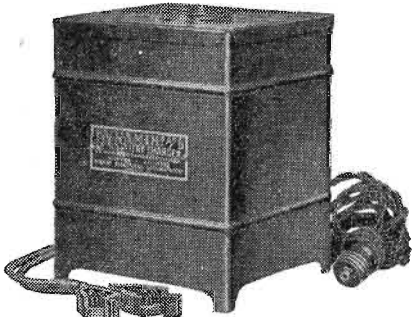

A New Charger That Does NEW Things!

Never before such a charger as this. Think of it, fans! The new Silent DYNAMIK will not only charge your "A" Battery, but it will charge your wet "B" Batteries—all of them, the full 96 volts in series—and, you won't have to add any resistances, nor will you have to break your batteries up into 24 volt parallel units as you do with other chargers! This is an innovation!

—and it charges while you listen in!

Battery low? Connect your charger and go right ahead listening in. Full power, no hum, and no danger to tubes—the way this charger is built. The new Silent DYNAMIK is the correctly designed charger and a real quality product.

At your dealers—or direct \$14.00 (Without Bulb)

The SILENT DYNAMIK

Charger for "A" and "B" Wilson Electrical Laboratories 1416 Morse Ave., Chicago.

DISTRIBUTORS: S. R. FRALICK & CO. Chicago 15 So. Clinton St. SCOTT SALES CO. Los Angeles 443 San Pedro St.

B-T "COUNTERPHASE"

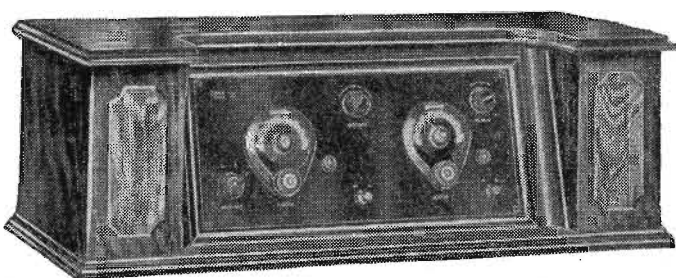

A Set with a Circuit A Circuit with a Pedigree

By All Odds the Finest—

that can be built. Not merely to "look nice" but to perform. The famous B-T "Counterphase-Six" is a set that is built behind the panel to give satisfaction to the man in front.

It is built in the B-T factories from B-T apparatus using an exclusive, patented B-T circuit—the only one that provides a means of operating with equal efficiency on all broadcast wave lengths. You owe to yourself to at least investigate the "Counterphase." It is by all odds the finest you can buy.

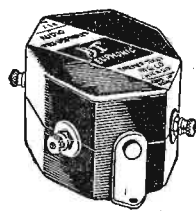

"THE BEST TRANSFORMER WE EVER TESTED"

is the report from a leading laboratory.

B-T engineers decided that better audio transformers were necessary to do full justice to B-T circuits and apparatus, so they designed the B-T "Euphonic."

In addition to being a superior transformer the "Euphonic" has an exclusive mechanical feature that permits any type of mounting—base-board, sub panel or side—with terminals always in correct position for wiring. This feature eliminates howling and distortion due to leads being too close together.

For better tone and convenience in building buy B-T "Euphonics."

See us at the Chicago Radio Show, Coliseum, Nov. 17-22.

Send for literature describing all B-T products. Include 10 cents for "Better Tuning"—the greatest help to the set owner or builder ever published.

BREMER-TULLY MFG. CO.

532 S. CANAL ST.

CHICAGO, ILL.

CARDWELL

Announces

TYPE C

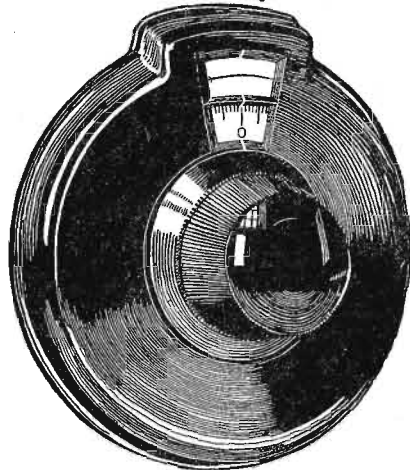
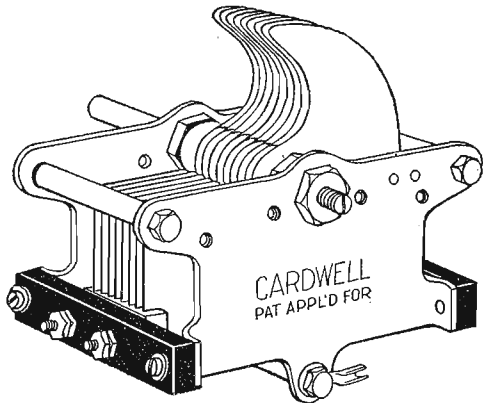

THE EQUITROL

TYPE D-217

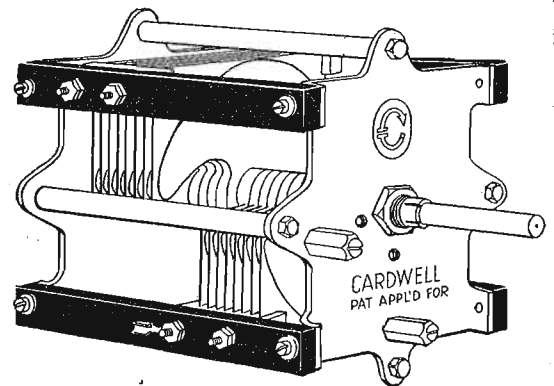

Three STRAIGHTLINE Units

SLW—TYPES B & C

ALL Cardwell TYPE B Condensers are straight-line for wavelength when used with the EQUITROL dial. These condensers were the first low-loss condensers and were originated by CARDWELL. As they are widely imitated, be sure the name "CARDWELL" is stamped on the ends. Type B condensers have semi-circular rotor plates and are SLC.

TYPE C, illustrated above, is exactly the same as TYPE B, except that the rotors have been shaped to give semi-SLW calibration. TYPE C condensers give ample separation of stations on the lower scale.

We recommend either TYPE B or TYPE C as giving maximum selectivity with any dial, regardless of tuning curves. They are matched.

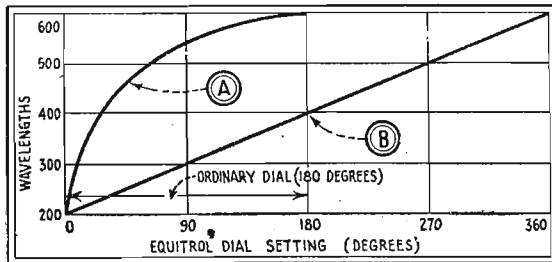

EQUITROL YOUR SET

In the above graph note that "A" is the way the standard (SLC) condenser tunes with a 180° dial. "B" shows how this has been converted into SLW by the EQUITROL and is spread over 360° of the dial. Space is provided for marking stations in upper window.

EQUITROL your set. No need to take out old condensers and put in new ones. EQUITROLS give your receiver that professional appearance. They turn clockwise.

With the EQUITROL you have more dial visibility than with 180° "SLF" condensers.

Sold singly, \$3.50; in sets of three, \$10.00

SLF—TYPE D

OVERCOMES every objection to ordinary straight-line-frequency types. Balanced rotors permit velvet-like shaft rotation. Rugged CARDWELL double-end construction with well spaced, heavy plates insures fixed calibration—not true of lighter types.

No more overall than with standard CARDWELL, being barely one inch deeper and taking less than four inches panel space.

Dual SLF TYPE D-217 especially recommended for de luxe SLF receivers.

Other types adapted to single-end (or standard) CARDWELL construction, are available, if desired. Write for circular No. 78.

Price, TYPE 217-D, each \$8.00

SERIES "B"

Max. C \ddagger	Min. C \ddagger	Type No.	Plates	List Price
47	7	159B	3	\$4.00
98	6	188B	5	4.00
142	8	154B	7	4.00
240	10	141B	11	4.25
340	13	153B	15	4.50
380	14	152B	17	4.75
480	15	123B	21	5.00
954	25	137B	41	6.00

SERIES "C"

Max. C \ddagger	Min. C \ddagger	Type No.	Plates	List Price
88	6	167C*	5	\$4.00
131	6	168C*	7	4.00
218	9	169C*	11	4.00
260	11	170C*	13	4.25
350	12	171C*	17	4.50
429	14	172C*	21	4.75
517	15	173C*	25	5.00
750	19	193C*	35	6.00

CARDWELL Design Means Greater Selectivity

DO not confuse straight-line with selectivity. The only way you can get selectivity is by using low-loss condensers with low-loss coils. There are no condensers more efficient electrically or mechanically than CARDWELLS.

To get sharp tuning and thereby separate stations which are on neighboring wavelengths, always use CARDWELLS. Their heavy, well spaced plates with rigid frame supports assure fixed logging and bring long distance stations in at definite settings—not true of light, filmy, cheap condensers, even if so-called SLF.

Note carefully why CARDWELL design has never been excelled. Insist on low-loss CARDWELLS.

†M. M. F. *Specify 'R' for Clockwise, 'L' for Counter-Clockwise.

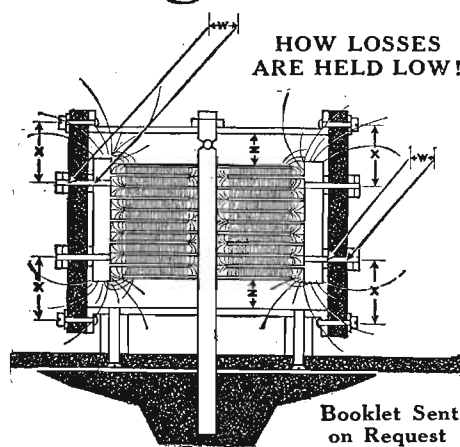

THEORETICAL Sketch (cross section), showing how losses are held low. Note that the shaft and rotor plates are one side of circuit and are grounded to end plates. The stator plates are supported by screws, which hold the blocks into which the plates are swedged. These screws give no real contact to the rubber, but the inner seating washers and the outer lock nuts are relatively small in surface, resting against the rubber.

The distances (W) are practically air spaced from the rubber. This reduces the amount of surface of the high (stator) side to the rubber, thereby reducing hysteresis losses to a minimum. The intensity of the field is indicated by the fine lines between the plates and the stray field by the fine curved lines.

Note that the blocks holding the stator plates act as shields to keep the stray fields out of the rubber. Also note that the distance (X) is relatively large and affords an extremely high resistance path to the currents which might tend to leak across the rubber. The distances (Z) permit a low minimum capacity, as does also the plate spacing between rotor-shaft elements and stator plate edges.

QUALITY RADIO PARTS

THE ALLEN D. CARDWELL MFG. CORPN., 81 PROSPECT ST., BROOKLYN, N. Y.

OPERATING AND TROUBLE SHOOTING

OPERATING and Trouble Shooting, is a Radio Digest feature the purpose of which is to give practical information on the operation, care and cure of simple troubles in every kind of receiver. Usually a standard manufactured receiver of wide distribution is studied, but it is the purpose of the article this week to give general information of value to everyone. The suggestions below, if executed faithfully, will make winter broadcast listening yield all there is to yield to the reader and give your set a fair chance.

WHAT one cannot hear, see, taste, feel or smell, one is apt to refuse to consider seriously. The leakage of minute currents at radio frequencies cannot be detected by any of our senses, but it makes the difference between satisfactory and unsatisfactory receiver operation. Disconnect the lead-in, the ground, the speaker, the storage battery and the B batteries (and C batteries, if used) so you can get at each part readily.

It would be an excellent idea to take the storage battery around to a battery station and have the repairman empty out the solution and fill it up with new. While doing this, he will also wash out the cells and clean out the sediment which has probably collected in the bottom of the jars. If he is thorough, he will clean off the terminals and the tops of the cells. If not, do this yourself, using a rag dipped in ammonia water. Then, when ready to make connections later, fasten the wires securely, being sure of your plus and minus terminals, and coat the metal parts and con-

nections on top of the battery with vaseline.

The B Batteries

If B batteries are of the storage type, and were in use all last season, new solution would do them a great deal of good—not forgetting to clean off the tops of cells, also. The majority of sets are, however, still provided with dry cell B units. If new dry B's were installed prior to last April and the set has been in use a great deal, they probably are not in very good condition. If tested with a voltmeter after a long rest, they may show 85 per cent pressure, but to get a true reading they should be tested after being in use several hours. On such a test, an old 45-volt unit will not, as a rule, show 34 volts or better. If it does, try it several evenings, testing after each evening's use. If it does not read 34 volts or more, discard it and put in new units. Do not try to use a new block of B between minus B and detector plus, with an old one between detector plus and 90 plus. For several good reasons this is poor policy.

Incidentally, there is real economy in the large jumbo sizes, when one's set has 5, 6, 7 or 8 tubes.

Inspect the Tubes

Tubes of the 201A or 199 types that have had 800 to 1,500 hours of use are rather weak and the recently developed tube rejuvenation process should be used. If you do not have one of these rejuvenating units yourself, take the tube to a dealer that has and let him fix them up. The dealer probably also has a tube checker and, after being given a new lease on life, each tube should show a plate current of one milliamperer or better. Any tube that does not read this high should be replaced.

With a nail file lightly go once across the bottom of each pin in the bases of the tubes, or, if your sockets are of the side contact type, scrape the sides of the pins lightly all around with a knife.

If the springs in the sockets are of the flat, bottom-of-pin-contact type, see that the surface of each is bright. This can be done with a sharp edged screw driver

or broken knife blade. A narrow strip of emery paper folded around the end of a pencil or some other long, narrow object will do for this, but be sure all filings and emery dust are blown out of the socket and set afterwards. Each spring may well be bent up slightly to be sure of good contact with the tube pins.

Remove Dust With Cloth

The dust on socket bases, panel and baseboard creates most of the leakage which pulls down volume and range. With a soft, dry cloth go over every part within the set that you can reach. Even though binding posts are close together, do not neglect the narrow strips of surface but

go in there, between the posts, with the cloth over a match or pencil. Frequently it is difficult to reach the surface of socket bases, but especial care must be paid to getting the dust off the narrow ledge on the outside around the cylindrical part and between the four terminal or connection posts. The back of the panel, between condensers and rheostats also should not be overlooked. Most variable condensers these days are of the grounded rotor type, with a thin strip of hard rubber or bakelite on each side supporting the stator plates between the end plates. The half-inch length between end plates and stators should be cleaned thoroughly.



Old Tubes Made Good As New

THIS latest Laboratory product will recondition any old, run-down, even worthless tubes, as long as the filament still lights. Makes them as good as new in a few minutes' time. Costs but few cents more than new tubes! Simple, efficient, practical. Big money-saver. Operates on either A. C. or D. C.—110-120 Volts. Model No. 20 for UV-201A (C-301A, etc.) and all similar types. Model No. 10 for UV-199 (C-299, etc.) and all similar types. Bound to do the work on our

Money-Back Guarantee

Money cheerfully refunded if desired results fail. But we are sure you will find the Mack Reconditioner pays for itself in one evening. Many making good money restoring friends' and neighbors' old tubes. You cannot lose! Act quick on this special short-time introductory price. Sent Postpaid with full directions on receipt of \$2.95. Be sure to state Model No. wanted. Our guarantee refund price protects you. Send now.

\$2.95

For fine tone quality, volume, and distance, your tubes **MUST** be in perfect condition.

718 Cass St. **MACK LABORATORIES** Chicago, Ill.

MACK RECONDITIONER

"THE CURE FOR RUN-DOWN TUBES"

Tested



Approved

Straight Line Frequency and Compensated Multiple Condensers

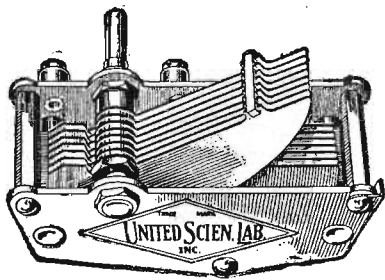

A Perfect Straight Line Frequency Job

Separates the stations and distributes them evenly over the dials. It will materially improve the selectivity of any set, and make the sharpest tuning quick and easy. Low minimum with uniform maximum capacities. Made in all standard sizes.

Only Real, Practical One Dial Control Unit

A straight line, low loss product, combining maximum selectivity with simplicity of tuning. Can be built into any T. R. F. circuit and cuts down space and panel requirements. Evenly matched and balanced, and electrically and mechanically perfect. Genuine Bakelite dial and two knobs.

Capacity—.00035 mfd. per unit.

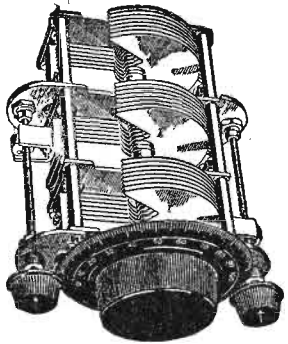

Write for Further Particulars and Prices

UNITED SCIENTIFIC LABORATORIES, Inc.
80 FOURTH AVENUE, NEW YORK CITY

BRANCH OFFICES

Chicago, Ill. 53 W. Jackson Blvd.
Minneapolis, Minn. 1026 Second Ave., So.
San Francisco, Cal. Pacific Building
Omaha, Nebraska 625 Securities Bldg.
Boston, Mass. 53 State St.

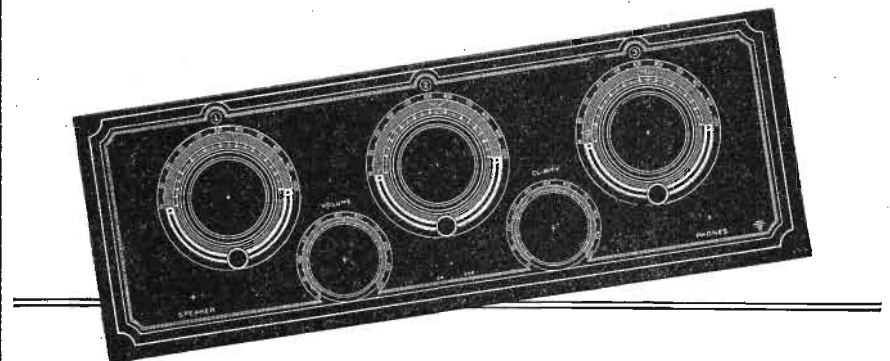

Exceptional Technical Resources Alone Make Formica Possible

Veri-Chrome Panels

By the purchase of a controlling interest in the Veri-Chrome laboratories, the financial and production resources of the Formica Insulation Company have been placed behind this remarkable new process for decorating radio panels. Elaborate decorations can be produced much more rapidly and more economically than by engraving. Decorations designed by the leading American artists are offered. Tuning scales may be marked directly on the panel eliminating the standard dial and substituting pointers instead. The reduction in cost is large. Write for prices on complete panels finished in this way in quantity.

THE exceptionally fine finish, remarkable uniformity, and evenly maintained quality of Formica over many years are due to the first rate technical resources which the Formica Insulation Company has concentrated on its work.

The Formica laboratories have been leaders in developing the material, and the largest producing equipment in the country has given first rate service to manufacturing and trade users of radio panels and insulation.

Formica has not only the largest organization in the world devoted to this product, but it is an organization that concentrates all its attention on just one thing.

Formica panels for home set builders, in gloss black, dull black, walnut and mahogany are packed in neat craft paper envelopes and sold by leading dealers everywhere.

Insist on Formica and build your set for permanence.

THE FORMICA INSULATION COMPANY

4667 Spring Grove Avenue, Cincinnati, Ohio

- Formica is used by nearly all the leading set makers—and has for years been used by more set makers than any other material.
- Formica is unaffected by weather and time—it lasts forever.
- Formica in appearance is the finest of all panel materials and always remains so.
- Formica's electrical qualities of every kind far exceed any possible requirement.
- Formica has high mechanical strength and will not break in use.
- Formica will not sag from heat or cold flow under pressure. It retains its dimensions. Everything you fasten to it stays tight and precisely where you put it.
- Formica panels are sold in neat craft paper envelopes which assure you that you are getting the genuine.
- Formica is one of the most widely approved materials in radio.

SALES OFFICES

NEW YORK.....50 Church Street
CHICAGO.....9 South Clinton Street
CLEVELAND.....516 Caxton Building
ROCHESTER.....327 Cutler Building
TOLEDO.....419 Ohio Building
MINNEAPOLIS.....1026 Second Avenue, S.
NEW ORLEANS.....Whitney Central Building

PITTSBURGH.....422 First Avenue
SAN FRANCISCO.....585 Mission Street
PHILADELPHIA.....725 Bulletin Building
BALTIMORE.....709 Title Building
HABANA, CUBA.....55 Calle Obispo
BOSTON.....6 Beacon Street
DENVER.....1420 16th Street
ST. LOUIS.....1362 Syndicate Trust Bldg.

FORMICA

Made from Anhydrous Bakelite Resins
SHEETS TUBES RODS

Hear the Formica Orchestra over WLW every Tuesday evening from 9 to 10 Central Standard Time.

No Matter What Circuit— Far, Far, Better Results with KARAS Orthometric Condensers

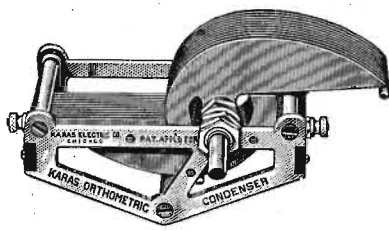

Karas instruments have been tested and recommended by leading technical editors for use in all types of sets from the most elaborate supers to the simplest low loss 3-tube receivers. Nothing can take the place of these scientifically designed, precision instruments. Use them in your next set—or improve your present set by installing them? It's easy to do.

Spreads Stations Evenly Over the Dial

—No Crowding Whatever

The Karas Orthometric Condenser positively separates all adjoining wavelengths by EQUAL distances on the dial—giving you full benefit of the 10 Kilocycle frequency separation fixed by the government. Ordinary condensers jam 70 of the 100 Government allotted wavelengths into the first 30 points on the dial—even straight-line-wave-length condensers crowd 57 of them below 30. But with Karas Orthometrics, each point on the dial corresponds to one of the 100 allotted wavelengths. The result is marvelous simplicity in tuning—and better, clearer reception—all side bands without interference.

AND—

KARAS HARMONIK TRANSFORMERS

Karas Harmoniks deliver perfect music with loads of volume from stations one to two thousand miles distant. DX broadcasting becomes really enjoyable.

Even from far away points, Karas Harmoniks bring out full, round musical tones. All the vital harmonics and rich overtones are fully retained. Low bass notes pour forth, rich, sweet, sonorous. If you want music like this, you must have Karas in your set. Get a pair TODAY! The best transformer money can buy.



If your dealer is out of Karas Instruments

Order Direct on this Coupon

Most good dealers everywhere sell Karas parts. If your dealer happens to be one who doesn't, we will supply you direct at no trouble on your part—on our 30-day money back guarantee. Just fill in and mail this coupon at once. Send no money. You can pay the postman on delivery.

Karas Electric Co., 4049 N. Rockwell St., CHICAGO, ILLINOIS
For more than 30 years makers of PRECISION Electrical Apparatus.

Karas Electric Co., 4049 N. Rockwell St., Chicago
I enclose \$..... for which please ship me, postage paid, the instruments checked below. It is understood that I have the privilege of returning these goods, for full refund, within 30 days, if they do not prove entirely satisfactory.

.....Karas Harmonik Audio Transformers, (\$7.00 each)

.....Karas Orthometric Condensers: Size.....
(23 plate \$7 ea.; 17 plate \$6.75 ea.; 11 plate \$6.50)

Name.....

Address.....
If you send cash, with order, we'll send package postpaid

You'll be mighty glad you sent for this book

BECAUSE it contains all the information that you need to be really well informed about radio batteries.

It not only tells you what functions radio "A" and "B" Batteries perform in radio reception, but explains how it is done.

It tells you, by means of simple charts, how to select the proper capacity storage batteries for any type of radio set.

It tells you how to install and connect batteries so that their care and maintenance in proper condition is simple and easy.

It tells you how to recharge your batteries and how to care for them so that they will give you many years of excellent service.

If you want to be the best posted man on storage batteries in your neighborhood and at the same time know how to get the best results from your own radio, write today for this book.

It will be sent to you by return mail entirely free of charge.

THE PREST-O-LITE CO., INC.
INDIANAPOLIS, IND.
New York San Francisco
In Canada: Presto-O-Lite Company of Canada, Ltd.
Toronto, Ontario

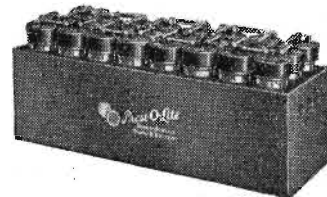

Prest-O-Lite

THE TUBE WITH A SENSIBLE GUARANTEE



Made with Precision!

Right from the start at our factory each SUPERTRON is produced with PRECISION as the dominating factor.

The material, each process, the triple test, and the final inspection, are all guided by the most exacting PRECISION. The unit of PRECISION called SUPERTRON is serial numbered and wrapped in a certificate bearing a corresponding number.

Thus giving you a means of identification to assure full satisfaction.

DISTRIBUTORS

- | | |
|--|--|
| Hinsdill Electric Co.....Troy | Fireside Radio Set Co.....Chicago |
| American Phonograph Co.....Albany | Yahr & Lange.....Milwaukee |
| Rosen Talking Machine Co.....Boston | The Roycraft Co.....Minneapolis |
| Balt. Hub Wheel & Mfg. Co.....Baltimore | L. W. Cleveland Co.....Portland, Maine |
| Cycle Auto Supply Co.....Buffalo | Sorenson Lamp Co.....Des Moines |
| H. D. Taylor Co.....Buffalo | Hippee-States Auto Sup.....Des Moines |
| Iroquois Sales Co.....Buffalo | Orr Bros.....Cedar Rapids |
| Hamburg Bros.....Pittsburgh | Radio Dealers Sup. Co.....San Francisco |
| Radio Stores, Inc.....Denver | Western Light & Fix. Co.....Los Angeles |
| Reynolds Radio Co.....Denver | Franklin Elec. Sup. Co.....Philadelphia |
| Burr-Fowler.....Syracuse | Keystone Radio Dist. Co.....Philadelphia |
| Ed. J. Goetz Co.....Cincinnati | American Radio & Sup. Co.....Cincinnati |
| Elgin Radio Corp.....Elgin | Allentown Radio Dist. Co.....Allentown |
| Alberta Radio Co.....Alberta, Canada | Goodlin Auto Sup. Co.....South Bend |
| Imp. Radio Co.....Sault Ste. Marie, Can. | Swanson Electric Co.....Evansville |
| F. X. Guillemin.....Montreal, Canada | M. H. Johnson Electric Co.....Utica |

BRANCH OFFICES THRUOUT THE UNITED STATES

SUPERTRON MFG. CO., Inc., HOBOKEN, NEW JERSEY
Export Department, 220 Broadway, New York City

SUPERTRON

A SERIAL NUMBER GUARANTEE

Fireside: 6 Tube Set of Perfect Reception

Part I—Explanation of Set and Circuit

By Jacques Fournier

WHEN the technical editor of Radio Digest asked me, some time ago, to design and write up a receiver that would combine the exceptional in tuned radio frequency with the exceptional in audio frequency reproduction, the assignment was taken over gladly and with enthusiasm. I had had that set in mind too long to delay building it much longer. There were a lot of splendid features in various pieces of apparatus on the market that I wanted to combine into one receiver that would provide the home-loving family with endless hours of entertainment and for which there would be no regrets and no excuses necessary to guests. It should be typically a set that could be placed near a fireplace full of glowing coals, around which a group of music lovers could gather and spend the entire evening. Hence the name Fireside. It occurs to me that many builders will be interested in following my line of thought in the choice of parts used and in their layout.

Aero Coils Used

With the first burst of low loss enthusiasm out of the way, most of us, I believe have got down to a valuation of coil efficiency by means of the term "power factor." Put another way, this term means the value of inductance

the desired value of inductance with the lowest radio frequency resistance and, from tests made with various coils, this writer has come to the conclusion that the single layer, closely wound coil is a highly efficient unit. In this belief, I have with me also, G. H. Browning of Browning-Drake fame and Milo Gurney whom you all know from his recent splendid series on bridge circuits.

On looking over the various units available on the market and of this type, the Aero coils appealed to me because they not only used this type of winding but also eliminated practically all of the dielectric or tube without the use of dope. Not that dope hurts a great deal but it certainly doesn't help any. Considering these units further, one finds that

This lends itself to a number of desirable uses, chief of which is the adjustment of selectivity to suit antenna length and location with respect to stations.

I have an idea that the fact that Benjamin make a variable condenser is going to be something of a surprise to most of you. Radio set builders and experimenters have long been familiar with the Benjamin socket, and a few know that this concern builds an excellent set of inductances, but even friends of mine long in the Radio industry have asked what make of condensers those were.

but from the shape of the blades it seems highly probable that, with the proper inductance, the plotted curve would be close to straight line wave length. Low wave stations are well spread out although not equally spaced when plotted in kilocycles. Never before used, to my knowledge, there is a friction disc just in front of the single bearing by which the friction tension on the shaft can be easily adjusted at a touch of the finger. Data is not available on the minimum capacity but it cannot be higher than 10 "micro-mikes." (Continued on page 38)

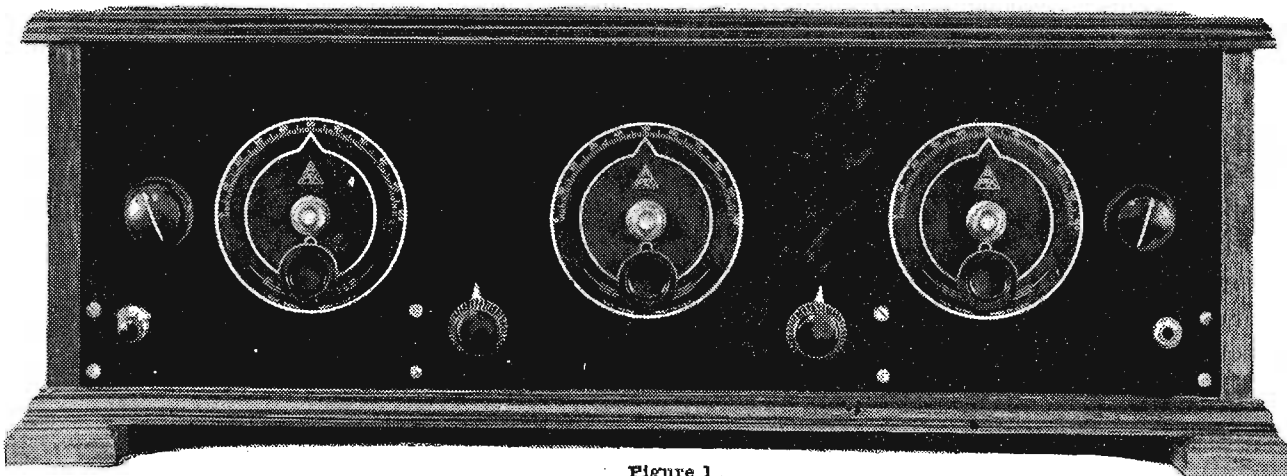

Figure 1

LIST OF PARTS

1 Kit of 3 Aero Tuned R.F. Coils	Aero Products, Inc., Chicago	12.00
3 Benjamin .00035, type 8661 Cond.	Benjamin Elec. Mfg. Co., Chicago	14.25
6 Benjamin Clearstone Sockets	Benjamin Elec. Mfg. Co., Chicago	6.00
2 Pairs Benjamin Brackets	Benjamin Elec. Mfg. Co., Chicago	1.40
3 Thordarson Autoformers	Thordarson Elec. Mfg. Co., Chicago	15.00
1 Yaxley Midget Switch, No. 10	Yaxley Mfg. Co., Chicago	.50
1 Yaxley Open Circuit Jack	Yaxley Mfg. Co., Chicago	.50
1 C-H Rheostat, 6 Ohm	Cutler-Hammer Mfg. Co., Milwaukee	.75
1 C-H Rheostat, 30 Ohm	Cutler-Hammer Mfg. Co., Milwaukee	.75
1 C-R-L Resistor, 200,000 Ohm	Central Radio Lab., Milwaukee	1.65
1 C-R-L Resistor, 500,000 Ohm	Central Radio Lab., Milwaukee	1.65
4 Dubilier .5 mfd. Bypass Cond.	Dubilier Cond. & Radio Corp., N.Y.C.	3.60
1 Dubilier 1.0 mfd. Bypass Cond.	Dubilier Cond. & Radio Corp., N.Y.C.	1.25
1 Dubilier .001 mfd. Fixed Cond.	Dubilier Cond. & Radio Corp., N.Y.C.	.40
2 Daven Resistors, 1/2 Megohm	Daven Radio Corp., Newark, N. J.	1.00
2 Daven Mountings, No. 50	Daven Radio Corp., Newark, N. J.	.70
1 Daven Leakandenser, No. 24	Daven Radio Corp., Newark, N. J.	1.00
1 Jones Cabelug, 4 Foot	Howard B. Jones, Chicago	1.00
1 Formica Panel, 7x24x3/16	Formica Insulation Co., Cincinnati	3.36
1 Formica Panel, 7x23 1/2x3/16	Formica Insulation Co., Cincinnati	3.29
2 Walnut Bind. Posts, ANT and GND	Walnut Eleo. Mfg. Co., Chicago	.22
1 Cabinet 24x7x10	Any Available Make	10.00
3 Apex Silver Satin Dials, zero left	Apex Elec. Mfg. Co., Chicago	7.50
Miscellaneous, such as bus bar, screws, etc.		2.50
Total Cost		\$90.27

against the resistance at radio frequencies.

If these two factors only, are taken, the measurements of all coils considered must be made at the same wave length or frequency. Otherwise, a formula must be applied which allows for the difference in frequencies used. Now, naturally, that coil can be considered best which gives

in the second and third units, the primary is so placed that there is plenty of coupling to the secondary for transfer of energy but very little capacity coupling, which type of coupling would be undesirable. Moreover, in the first unit, used to couple the antenna and ground system to the first tube, there is variable coupling possible between primary and secondary.



Vigilance

Constant vigilance is the price of uniformity and constant vigilance is maintained over Magnatrons. That is why Magnatrons are uniform, and uniformly good.

The Magnatron DC-201A, DC-199, and DC-199 (rare base) now list for only \$2.50 each.

CONVEY ELECTRIC LABORATORIES
Magnatron Building Hoboken, N. J.

MAGNATRONS

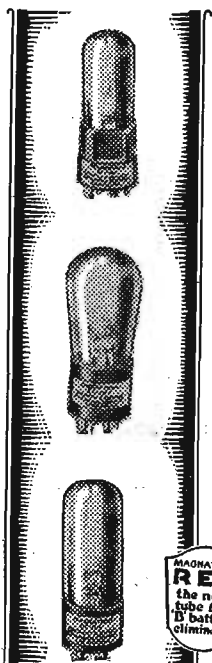

MAGNATRON REX
the new tube for B battery eliminators

ERLA Engineers design new Equispace condenser

Spreads low wavelength stations without crowding those from 50° to 100°. Lightweight and compact in style.

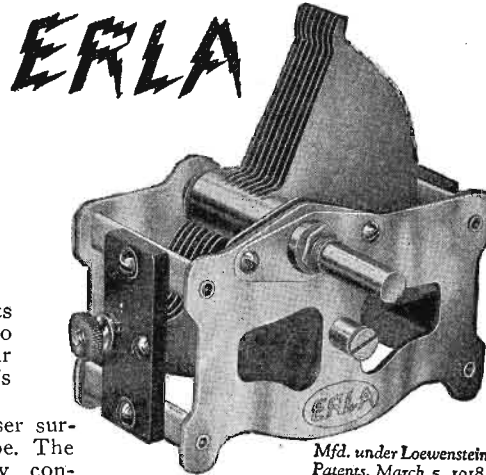

Mfd. under Loewenstein Patents, March 5, 1918.

RADIO science now offers you its newest condenser. Results are so amazing we ask you to test it in your own set. Get it at any Erla dealer's today.

The new Erla *Equispace Condenser surpasses in results every present-day type. The conventional straight line frequency condenser spreads stations on the low wavelength portion of the dial, but it also brings stations between 50° and 100° too close together. On the higher wavelengths are many high-powered stations that are extremely difficult to separate.

The Erla Equispace makes allowance for this. It gives maximum spreads between stations over the entire range of the dial. Specially designed plates make this possible.

Now all stations, low frequency as well as high frequency, are spaced on the dial to insure the best results. Both sensitivity and selectivity are materially increased due to the marked reduction in ordinary losses. Plates of special spring brass are scientifically spaced and give maximum conductivity. Scientific tests show a resistance far lower even than costly laboratory types.

Equispace is small and compact, requiring little space. Very light but having extreme rigidity because of four riveted cross members.

Go to any radio store and see this amazing condenser today. It will make a striking difference in any set.

Send you name and address today and we will mail free, news of the latest radio discoveries and inventions.

*Trade Mark Registered

Made by

ELECTRICAL RESEARCH LABORATORIES

Chicago, U. S. A.

Special Erla Features

Minimum capacity only 10 m. m. f.

Ratio of maximum to minimum capacity 35 to 1.

Total resistance of only 3 ohms at 1000 cycles.

Four riveted cross-members supporting stator plates provide rigidity unapproached.

Single-hole mounting makes it easy and quick to attach.

Light weight plates of special spring brass appreciably reduce bulk and weight, and minimize tendency toward misalignment from rough usage.

Electrical Research Laboratories, 7-A
Dept. 7-A, 2500 Cottage Grove Ave., Chicago, Ill.
Tell me what's new in radio.

Name

Address

City

County..... State.....

CIRCUIT DIAGRAM FOR THE NEW "FIRESIDE" RECEIVER

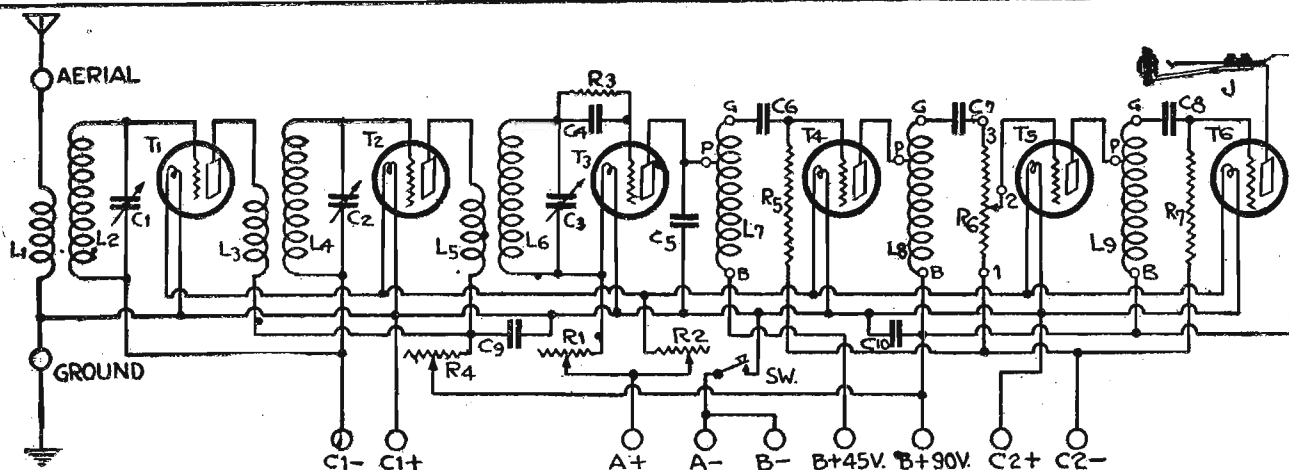

Figure 2

"FIRESIDE" RECEIVER

(Continued from page 37)

The choice of coils and condensers largely determines the efficiency of the tuned radio frequency part of this set, so we can now consider what I used to produce something superior in the way of reproduction. Word went around the Radio field some time ago that a new system of audio frequency amplification would shortly be brought out by Thordarson. In fact it was so good, according to the story, that this type of speech amplification was being installed in the voice amplifiers of our best broadcasting stations. Since stories of new and wonderful apparatus go around the Radio field on an average of two or three a week, that didn't mean much, but the point that this stunt was good enough for broadcast transmission was unusual, and efforts to get some of these units were started at once.

Autoformer, for that is the name of the new unit, came fully up to its advance stories. While impedance coupling has been known for many years, no one had

ever worked out a complete system for its use. Autoformer coupling is a system in which one must consider three values—impedance, capacity and resistance. Not alone must the engineer determine the impedance value best suited to our tubes, but for use with that value, he must ascertain the correct capacity of the fixed condensers between plate and grid, and correct resistance of the grid leaks to

keep the tubes at the proper grid bias. Thordarson did all this and, while they supply only the impedances as Autoformers, in the way of parts, they supply also the correct diagram and values of the associated units.

The voltage step up between tubes is not as great through the Autoformer as when signals are passed through a transformer, which is the reason three tubes

are used instead of two, but the step up at all audible frequencies, especially those below 60, is the same. This cannot be said for any transformer even though some of them have a pretty flat curve from 60 up. Unlike resistance coupling, which also gives even amplification at all frequencies, the Autoformer system does not require a B voltage any higher than that to which we have been accustomed. One can use from 112 to 135 volts if he prefers, but I haven't seen the speaker that will take the resultant output, and 90 volts gave me all I could want—or all the neighbors in our block. Late at night, many of them probably wish I had only 20 volts.

C-R-L Variable Resistors

In any tuned radio frequency set it is desirable to have some means of bringing the R.F. tubes up to maximum regeneration, or just below oscillation, at all wave lengths within the range of the set. Since plate circuits are not tuned to the received wave lengths, it is preferable to put any sort of resistance control in those circuits, so I have chosen the system whereby a 200,000-ohm variable resistor is inserted in common B supply wire to the two R.F. tubes. This may be identified in the circuit diagram, figure 2, as unit R-4. This system has been called "deresonating," but this always seemed to me to be a misnomer and the term "devoiting" would be more accurate though not, perhaps, as euphonious. Nothing is detuned or deresonated; we merely pull down the plate voltage a little.

(Continued on page 42)

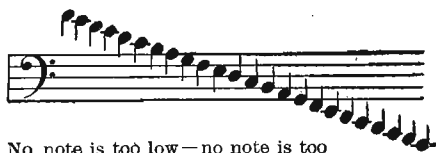

No note is too low—no note is too high—to be fully amplified by Thordarson Autoformers. Autoformers are all frequency amplifiers—they amplify with even magnitude ALL notes within range of the human ear. Developed, perfected and built only by Thordarson.

A Thordarson Autoformer Amplifier built in accordance with instructions and diagrams furnished with each instrument.

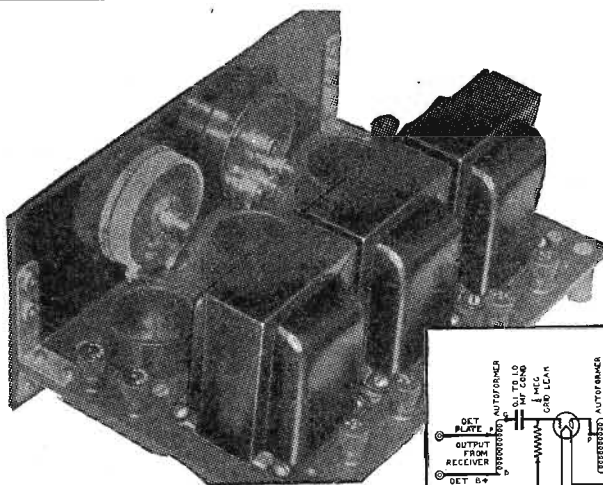

FANS!

Send for our new interesting bulletins on Autoformer amplification. They contain hook-ups and complete directions.

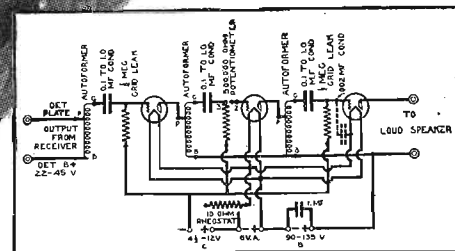

Insure YOUR Radio Tubes!

Avoid Mistakes

Equip your battery leads with these new CROWE everlasting markers. Bold markings permanently etched in black on metal.

25c

A Packet of Nine

CROWE CABLE MARKERS

Easily attached with ordinary pliers

At your dealers in this display box.

DEALERS—Write for introductory offer, giving name of jobber.



CROWE NAME PLATE & MFG. CO.
1749 Grace St. Chicago

Autoformer Amplification Amazes Vast Crowds

Used at Radio World's Fair, New York City, to Amplify Programs and Announcements Broadcast by Loud Speakers Throughout the Great Halls

Tens of thousands of radio enthusiasts were completely won to Autoformer amplification during the Radio World's Fair in New York. The Thordarson Booth was besieged by fans, amazed and delighted over this latest Thordarson achievement. It was hailed on all sides as the outstanding development of the year in amplification. "What is it?" "How may I use it with my set?" Such questions were continually repeated.

Our answer was this: As the world's oldest and largest exclusive makers of transformers, we have led for years in broadening their amplifying range. In the Autoformer

we have finally developed an all-frequency amplifier—a new instrument capable of fully amplifying all notes audible to the human ear. Thus the deepest notes of the grand organ, bass viol, tuba, English horn, etc., at last are brought out as clearly as those in the middle and upper registers of the musical scale. Improved long distance reception and better volume control are further advantages.

Autoformer amplification is expressly for those who seek the finest reproduction of programs to be had. May be used with any set in place of present amplifying transformer hook-up. Autoformers are \$5 each.

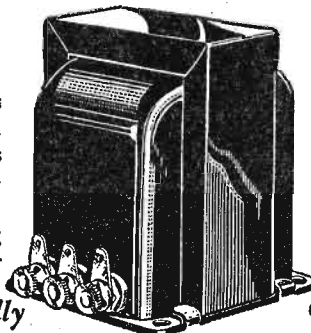

Unconditionally

Guaranteed

THORDARSON Autoformer

All Frequency Amplifier

THORDARSON ELECTRIC MANUFACTURING CO.
Transformer specialists since 1895
WORLD'S OLDEST AND LARGEST EXCLUSIVE TRANSFORMER MAKERS
Chicago, U.S.A.

ZENITH
KENNEDY
Radiodyne
Planstiehl
Howard
Thermodyne
OZARKA
Deresnadyne
ADLER-ROYAL
MURDOCK
MU-RAD
Valley
LEICH
Silver-Marshall
GLOBE
ULTRADYNE
Newport
BUCKINGHAM
NUNN-LANDON
KUSTOMBILT and many others

Also choice of the MacMillan Arctic Expedition

use Thordarson Super Amplifying Transformers. Leading set builders use more Thordarsons than all competitive transformers combined.

The Grand Prix Eight Tube Super-Heterodyne

Part II—Drilling and Assembly

By James McDonald

THE writer is acquainted with a great many people who have not built themselves super-heterodynes only because they did not have confidence in their own ability to construct "an eight tube set." The fact that it had that many tubes and such a long name had them "buffaloeed" when, as a matter of fact, such a receiver is no more work than a five tube job.

There is slightly more on the sub base, but less on the front panel. There is a little more wiring to a super possibly but the additional work is the intermediate amplifier and, with a unit like the Super-Multiformer, you cannot go wrong on this part.

Just out of curiosity, the writer has checked the number of holes that must be

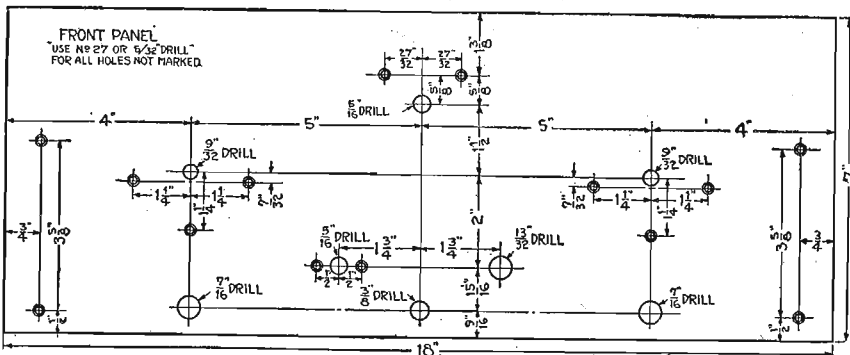

Figure 2

spring. The hole near the bottom and squarely in the center is for the Cutler-Hammer toggle switch; that slightly above it and to the right is for the Amsco single hole mounting potentiometer. The three grouped holes above and to the left of the switch are for the Amsco 2-ohm rheostat; this is the only resistance unit in the Amsco line requiring three holes but the Amsco engineers for some good reason seem to feel this type is better for a power unit.

How to Drill Panels and Sub Base

To get the center points on the panel, clamp (with small "C" clamps) or paste the full size template to the panel and, with center punch and hammer, make a small indentation on each little cross. Then remove the template and drill care-

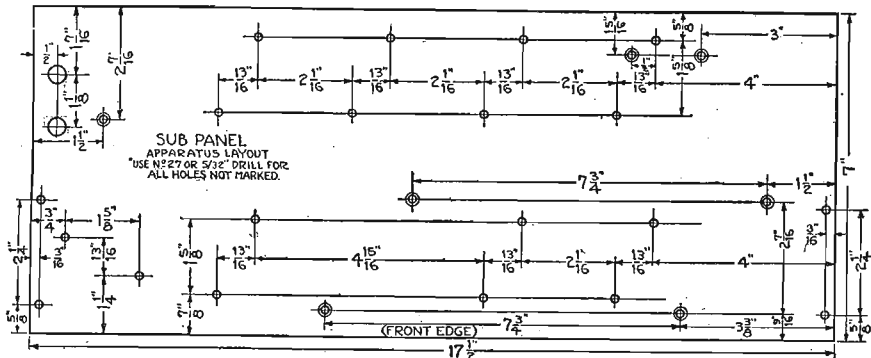

Figure 3

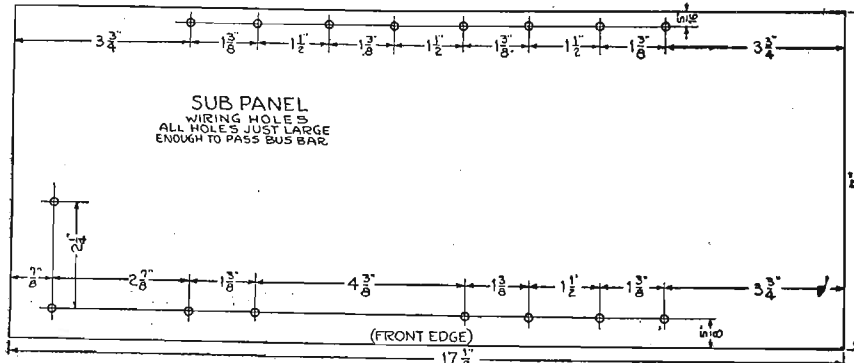

Figure 4

drilled for the Grand Prix in front panel and sub base against the number to be put through these panels in John Ryan's Traveler set and, while Grand Prix needs 22 holes in the panel against only 14 in the Traveler, the latter outfit needs 39 in the sub base to only 29 in the writer's. So they are about even on that score.

Taking up the holes for wiring, Grand Prix uses only 16 in the sub base against 39 in the five tube Traveler. These figures are not given in any sense of criticism but only to show that the building of an

eight tube super is not, necessarily, so very difficult.

The drilling template for the front panel is shown here as figure 2 and it should be enlarged to full size on either wrapping paper or the envelope that the panel comes in. For those who do not care for the two-hour job of measuring their templates, Radio Digest has made full size blueprint panel and sub base templates that will be sent on receipt of 25c to Department 5, Radio Digest, 510 N. Dearborn street, Chicago, Ill.

But getting back to figure 2, the two holes near the left edge of panel are for the Precise bracket, the four midway the height of the panel are for the loop tuning condenser, Cardwell 123-B, and the large hole below them is for the Carter open circuit jack.

Near the top and in the center lengthwise, there are three holes for the Lincoln Oscilloscope oscillator coupler. The right side of the panel is identical with the left, but the condenser is to tune the oscillator and the jack is a Carter four-

fully as shown on the three diagrams.

All holes should be put through first with a No. 27 or 5/32" drill after which the larger drills can be applied in the sizes indicated in the drawing. If you haven't all the sizes shown, use the next smallest and ream the hole to size. Small reamers are very inexpensive. Those holes around which there is a larger circle shown, are to be countersunk with a 45-degree countersink. The Yankee people in their line have such a tool to go in a hand drill. (Continued on page 40)

Now—Build a Real Set!

Get this Kit of Matched Coils for the "FIRESIDE" T. R. F. RECEIVER described in this issue of RADIO DIGEST

T R. F. Kit No. TRF-120 \$1200



THE selectivity, distance and volume of which a receiver is capable are determined by the effective high frequency resistance and distributed capacity of the radio frequency transformers used.

Aero Coils, by reason of their patented construction, have a much lower high frequency resistance and distributed capacity than others. They therefore tune into

95% Air Dielectric Dopeless Uniformly Air-Spaced Windings Patents Prevent Imitation

resonance on a "knife's edge"; they do not "spread" on powerful locals, and because their loss factors are reduced to new lower minimums, Aero Coils deliver more energy to the detector tube. This means distance with volume! But more! Aero Coils are matched! The dials all read alike. Obtain a set of Aero Coils at your dealers and build the Radio Digest Aero-Dyne now!

WRITE FOR FREE AERO BOOKLET

AERO PRODUCTS, Inc. 217 No. Desplains St., Chicago

AERO COIL LOW LOSS INDUCTANCE SYSTEMS

See Our Exhibit Chicago Radio Show Nov. 17th to 22nd

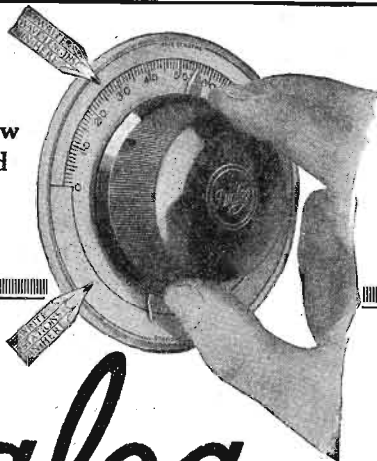

With erasable metal logging disc

\$1.25

Dialog

--essential for proper set performance

Your set is capable of far more than you are getting out of it! Five minutes of tuning after you have equipped your set with Dialogs prove this.

Smooth, easy vernier control, such as only Dialog can give, permits adjustment to the minute capacity variation necessary to successfully separate close stations. And there is nothing in Dialog to wear out! No extra drilling to install on any set.

- \$1.25 with black bakelite knob and black dial plate. \$1.25 with black bakelite knob and silvered dial plate. \$1.50 with brown bakelite knob and gold finished dial plate.

0-100 or 100-0 dial readings.

—And the new WALNART Station Selecting CONDENSER

The Walnut Condenser is not a straight line wave length nor a straight line frequency—but, a station-selecting condenser! Exactly what you have hoped for. Uncrowds all the stations making it easy for anyone to turn to the right condenser setting for any station. Put Walnut Station-Selecting Condensers in your set. Radio will mean more to you—from that day on.

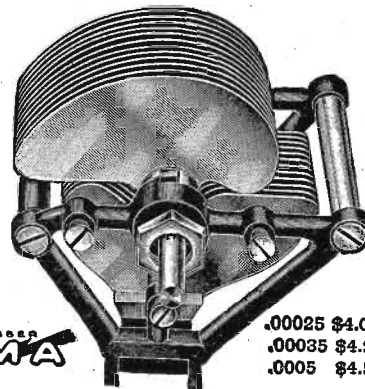

WALNART ELECTRIC MFG. CO.

308 So. Green St. CHICAGO "Makers of Good Goods Only"

.00025 \$4.00 .00035 \$4.25 .0005 \$4.50

LOOKING DOWN ON ASSEMBLED GRAND PRIX SUPER-HET

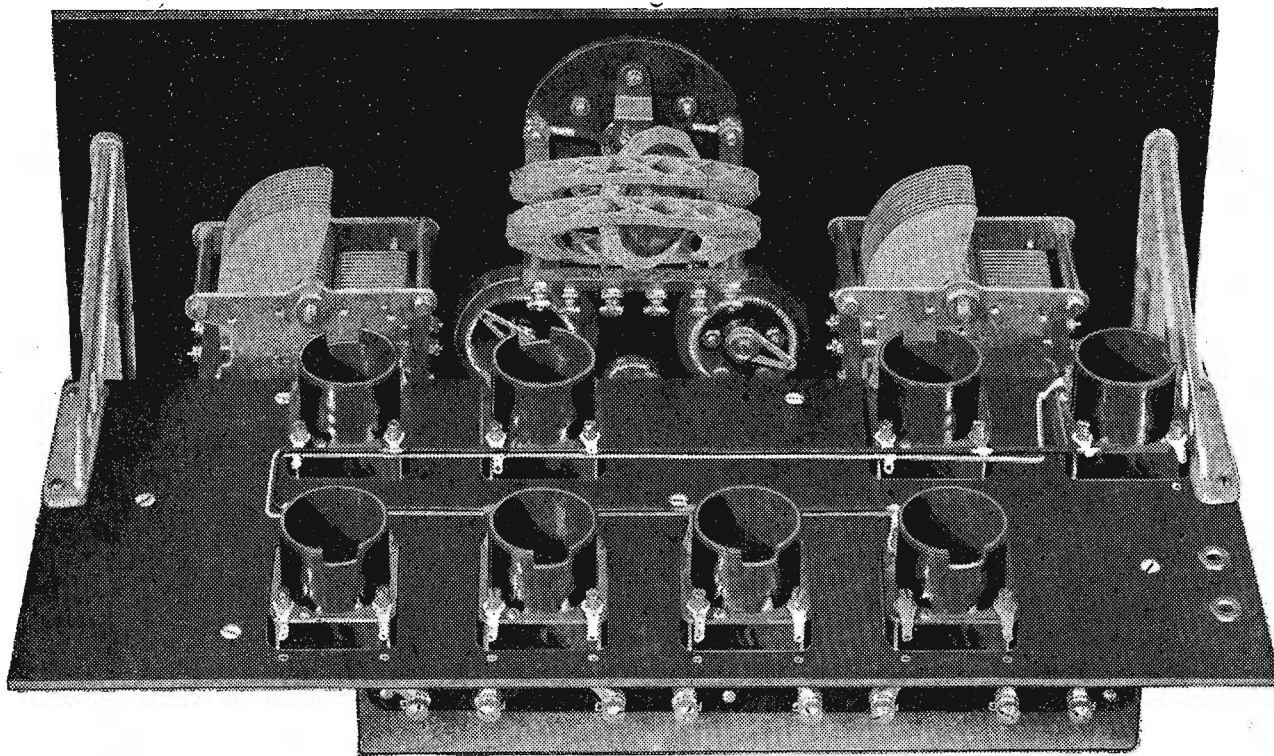

Figure 5

GRAND PRIX SUPER-HET
(Continued from page 39)

Mount the switch first, being careful to get the engraved "Off-On" plate vertical when tightening the large nut. The terminals at the rear should be at each side. Then put in the rheostat and, if the holes were carefully center punched, there will be no trouble putting flat head machine screws through panel and instrument.

The potentiometer is next and should cause no trouble at all. Next put in the jacks with frames downward; after them, put on the brackets.

Before putting on the brackets, however, some work must be done on them. On measuring, it will be found that the

flat surface which goes against the panel is 5 1/2" long. The next operation is to take off 1/2".

On each bracket it will be noted that, at the slot where the sub base goes, there are wings on one side of the bracket but not on the other. Place the brackets flat together with the wings on each toward the outside. Now hold them with the flat surface which will go against the panel toward you. This is the position in which they go in the set; they are merely spread 17" apart later. Now, at the bottom of this flat mounting surface, measure up 1/2" and draw a line across both brackets with a pencil.

Place one bracket in a vise and, with a hack saw cut through the soft aluminum at right angles to the mounting surface.

This will take you through part of the brace part also. Now do the same with the other bracket. The lower mounting hole will then be 1/2" from the sawed end, while the upper mounting hole remains 3/8" from the round end.

The two condensers can then be put on and the oscillator coupler comes last. It should be noted that, in this order of assembly, the sturdier parts are put on first while the more delicate components that might be injured are put on toward the last.

Sub Base Drilling

The reader can now make his own drilling template from figure 3, if he cares to, and get the center holes punched into the sub base just as was done with the front panel. All holes but two are left the same size as drilled with a No. 27 or 5/32" drill, those two being for the Carter Imp jacks at the rear left corner of the sub base. Countersink all holes with an outer circle in figure 3.

The holes through which wires pass from above to below the sub base are shown on figure 4 and these have been given as a separate template to avoid confusion. The reader can either add them to his first sub base template or make a new one. The latter method is to be recommended but requires that both templates be accurately placed on the sub base before center punching. No drill size is given but the smallest you have that will pass bus bar should be used.

Sub Base Assembly

The instruments to go beneath sub base go on first. Super-multiformer goes first using the following holes: One is near the left end, slightly behind and to the right of the front Imp jack hole; the other is 4 1/2" from the right edge of sub base and 15/16" from rear edge. Both are countersunk.

Put the machine screw (6-32) through from the top, slip on an old battery nut about 1/4" thick next, then the super-multiformer and then a hexagon nut. This is done in both cases and puts the base of the unit 1/4" below the sub base, through which space the wires are later carried.

The audio frequency transformers are next put on, and in both cases the P and B plus terminals go to the right. In

(Continued on page 42)

The AMSCO
ALLOCATING
CONDENSER

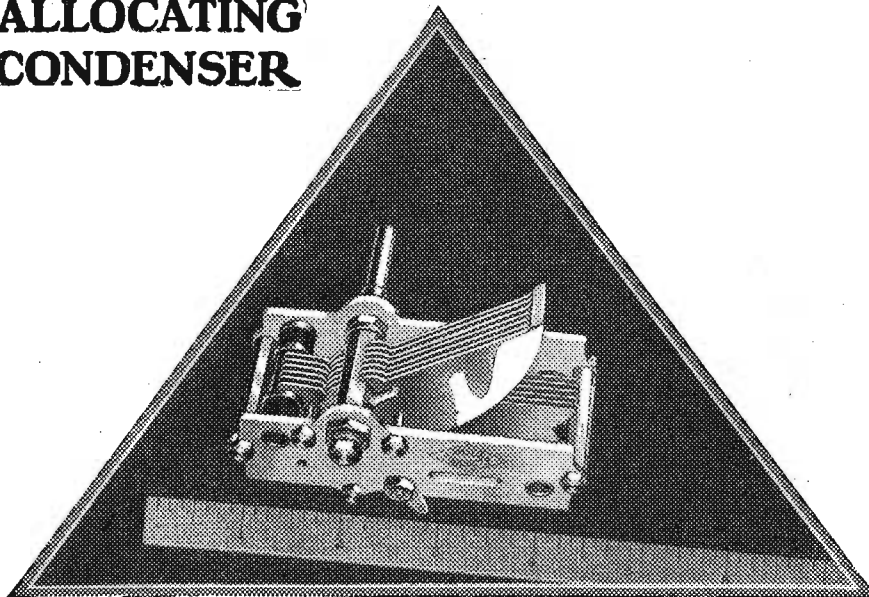

IT SAVES SPACE!

This straight line frequency condenser is a space-saver in the radio cabinet . . . It can usually be substituted for the old time condensers in existing sets . . . Once installed, it revolutionizes your ideas about tuning . . . Those AmSCO half-a-heart-shaped plates add Kilocycles at the rate of ten to each dial division—giving "a station for every degree" . . . All wavelengths—high or low on the scale—tune in with equal ease . . . AmSCO allocation of the stations is uniform and correct to within a fraction of 1% . . . Insist on AmSCO Allocating Condensers . . . Made in six space-saving models, three Single and three Siamese, at very reasonable prices.

AmSCO Products, Inc.,
Dept. O
Broome & Lafayette Sts.
New York, N. Y.

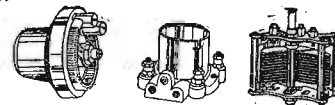
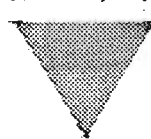

OTHER AMSCO PARTS
Write for our booklet, "The Heart of the Hook-up" for full details and prices of the entire AmSCO line. AmSCO for Excellence.

by popular choice
(as shown by official figures)
the
World's Largest
makers of
Neutrodyne
Radio
FREED-
EISEMANN

'Traveler' Doughnut Coil Tuned R.F. Receiver

Part IV—Connecting and Operating

By John G. Ryan

IN PART III, which covered the wiring of Traveler, the writer omitted mention of the two wires necessary for the use of the Jewell meter. The first of these is to be bus bar of the type used for wiring the rest of the set and is to be dropped from the left terminal of the meter, labelled plus, straight down below the sub base and back to the long wire which was number 1. To the other terminal, a flexible lead is attached terminating in either a spade connector or small clip. Presuming that these have been put in, we are ready to set up the Traveler.

Batteries Necessary

Three power units are needed, a six-volt storage battery of any ampere hour capacity between 60 and 120, two large 45-volt B batteries such as the Eveready number 770, and a small 4½-volt C battery.

Two small holes should be drilled either in the bottom of the cabinet near the rear edge or in the back close to the bottom, for the antenna and ground wires. The set can be slipped into the cabinet temporarily to get these opposite their proper binding posts. The leads from the storage battery and B batteries can well be brought in on a Belden cable, consisting of five wires each insulated from the others and all encased in a heavy protecting braid. This will make it necessary to drill but one hole 3/8" in diameter opposite the B minus binding post.

Connecting Batteries

The plus 45 terminal on one of the Eveready units is connected to one of the wires in the Belden cable and the other end of that wire, identified by its color scheme, is slipped into the left binding post of the group of seven, labelled plus 90. The negative terminal of that same B battery unit is attached to the plus 45 of the other B unit by a short length of wire and also to another of the wires in the five-wire cable. The other end of this wire is put on the plus 45 binding post in the set, which is the second from the left. The negative terminal on this

second B unit is then attached to another wire in the cable, the opposite end of which is to be put under the third binding post in the set identified as negative B.

The plus terminal of the storage battery is usually identified either by being painted red or with POS. or + stamped into the case close to it. This terminal should be connected to one of the two remaining wires in the cable, the opposite end of which connects to the fourth binding post in the set, lettered plus A. The other terminal of the storage battery is the negative, and the remaining wire of the five in the cable should be connected to it. The opposite end of this wire, in the set, connects to the next binding post which is negative A.

The C battery can either be placed within the set on the rear edge of the sub

base leaning against the back of the cabinet or can be placed just behind the cabinet with leads brought in through two small holes drilled directly behind the two C battery binding posts. In either case, the plus terminal of this battery connects, by a short wire, to the sixth binding post identified as plus C, and the negative 4½-volt terminal of the battery connects to the seventh and last binding post.

Aerial, Ground and Tubes

The antenna lead-in, which the writer sincerely hopes has been kept well insulated all the way down from the antenna and where it comes through the wall, is then slipped through the small hole in the cabinet opposite the binding post in the rear left corner and is slipped into that binding post. The ground lead, from water pipe, well or a buried mass of

metal, is slipped through the next hole and connected to the other binding post of the two in the left corner.

Five tubes of the amplifier type known as "A" tubes, are used in this set and they should now be inserted by pushing down slowly and firmly and then turned to the right. A loud speaker can be inserted now in the jack at the right end of the set or a pair of phones in the jack next to it. The filament switch should be pulled out, whereupon the two tubes at the right should light if speaker jack is used or only number 4 if the phone jack is used.

Operation of Receiver

The right rheostat should be turned clockwise until the arrow points horizontally to the left. This is presuming that both pointers were adjusted to be vertical (Continued on page 44)

A Benjamin Product

Four delicately adjusted springs support the socket and absorb all jars and shocks.

The Cle - Ra - Tone Socket "floats" above its base.

Stops tube noises.

Assures clear reception.

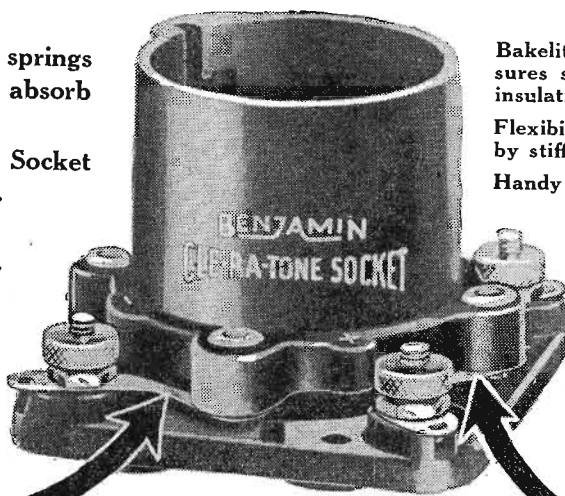

Bakelite, used wherever possible, insures sturdiness, long life and high insulation.

Flexibility of springs is not affected by stiff bus wiring.

Handy lugs make soldering easy.

Prevents the transmission of outside vibrations into microphonic disturbances.

SPRING SUSPENDED

SPRING SUSPENDED

The CLE-RA-TONE Shock Absorbing Radio Socket

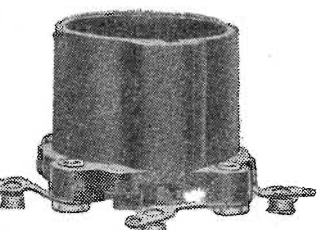

Without Bakelite Base for Mounting Direct to Shelf

These sockets are covered by the following U. S. Patents owned by the Benjamin Electric Mfg. Co.

Weeks, No. 991,185, dated May 2, 1911
Benjamin, No. 1,547,722, dated July 28, 1925

Other Patents Pending

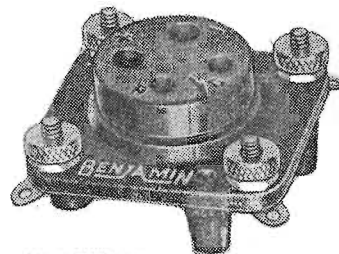

"PUSH" TYPE CLE-RA-TONE SOCKET

Designed to accommodate the new standard UX "push" type base radio tube. It will also take tubes with the ordinary bases, excepting the UV-199.

Nationally Distributed Through Radio Jobbers and Dealers

Made Exclusively by

Benjamin Electric Mfg. Co.

120-128 South Sangamon Street, Chicago

247 West 17th Street, New York

448 Bryant Street, San Francisco

Manufactured in Canada by the Benjamin Electric Mfg. Co. of Canada, Ltd., Toronto, Ontario



Resistance Coupled Amplification?

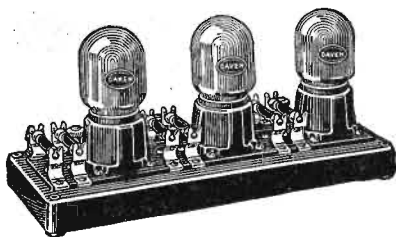

BECAUSE this method of amplification is the only way to procure quality of tone without the slightest distortion. The Daven Super-Amplifier can be conveniently put into any existing set. Use it also in the new set you are going to build.

To increase volume 50% and have no distortion use Daven High Mu Tubes in Resistance Coupled Amplifiers. Prices—High Mu-20, \$4.00. Mu-6 (for last or output stage), \$5.00.

Mail the coupon for complete information.

The Sine of Merit
DAVEN RADIO CORPORATION
Resistor Specialists
Reg. U. S. Pat. Off. Newark New Jersey



DAVEN RADIO CORPORATION L-10-25
168 Summit Street, Newark, N. J.
Please send me the following:
... Resistor Manual, 30c is enclosed.
... Complete Catalogue (free).

Name.....
Address.....

Get the Handbook of Resistance Coupled Amplification. At Dealer's 25c. By mail 30c.

FOR DEALERS: Send your letterhead and we will have our nearest distributor communicate with you.

THE BIG LITTLE THINGS OF RADIO

BOTTOM OF ASSEMBLED GRAND PRIX SUB BASE

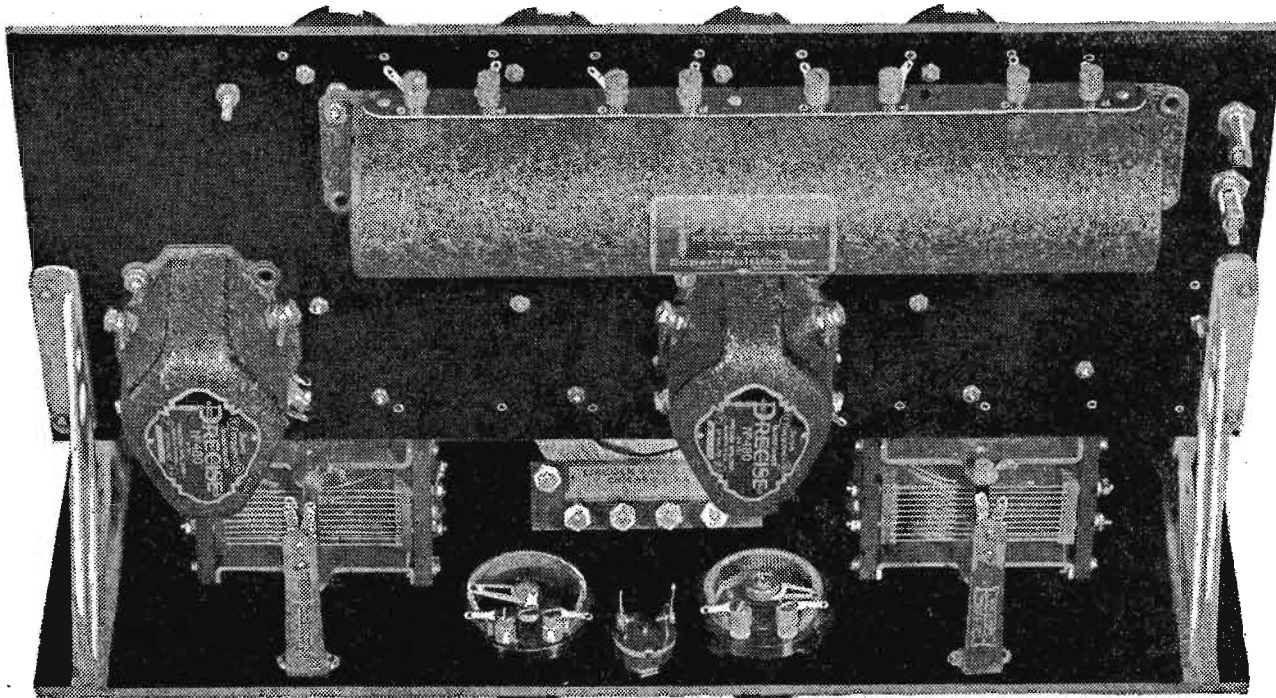

Figure 6

GRAND PRIX SUPER-HET

(Continued from page 40)

figure 3 there is a countersunk hole near the front edge to the left of the lettering "Front Edge." Behind and to the right of it is another, 7/8" from right edge of panel. These hold one transformer.

The other audio transformer uses these two holes: the first is 3 3/8" from right edge of panel and 9/16" from front edge; the second is 3" from front edge and 1 1/2" from right edge. These are mounted flat against under side of the sub base, no battery nut being used to space them.

The eight B-T sockets are now put on the upper side of sub base, each having two mounting holes which require 4-36 machine screws. The four in the rear row are mounted with the P and G terminals to the rear and it will be noted that there is a wiring hole directly below each. Be careful not to tighten up too strongly on the small "hex" nut you use on the under side of sub base as the pressure would crack the thin shell of the socket base, which is to be avoided.

Referring to figure 3, the two holes in the front left corner which are 2 1/4" apart are for the brackets later, but we are concerned now with the two holes diagonally placed to their right: A socket is placed on these with P and G posts to the left. There are two more holes to the right of this socket and on these place the sixth socket with P and G to the front. Sockets 7 and 8 go on the two remaining pairs of diagonally placed holes in the front row with P and G to the front in each case. The Imp jacks are now placed in the two large 3/8" holes by slipping off the lock nut on each, pushing jack through the tightening up nut. The body of the jack is below sub base so that loop terminals can be pushed into them from above.

One hole is left 15/16" from rear edge and in 3" from right edge, and a flat head 6-32 machine screw about 1" long is placed in this for the time being which will later be used to clamp the Belden battery cable in place.

Figures 5 and 6 show the panel and sub base put together with all the indi-

vidual parts in place. The filament wires, of which only two are required, are shown in figure 5 to show how easy it is to wire this set. Usually five or six are needed. The panel and sub base are not put together at this stage however, as this is reserved for part of the wiring operation to be explained next week.

(In the next issue Mr. McDonald will thoroughly describe the wiring in detail, although this is not as necessary in this set as with most receivers due to design and careful planning. The same numbering system as was used in the Traveler descriptions will be brought into use.—Editor's Note.)

"FIRESIDE" RECEIVER

(Continued from page 38)

While there are now several units available to supply 200,000 ohms resistance for this purpose, the C-R-L was the first brought out and has been developed to a high state of efficiency. Nothing rubs the resistance element and variation is smooth.

For control of the volume Thordarson recommends, and I have tried this out to be sure of it, that a variable resistor in the grid circuit of the second audio amplifier tube is better than several jacks and switching of the phone plug from tube to tube. Here again, C-R-L supplies a unit for the purpose, identical in appearance to the first mentioned unit, but provided with 500,000 ohms resistance from end to end and a separate connection for each end and the variable element. This will be found in figure 2 associated with the fifth tube and labelled R-6.

Non-Microphonic Sockets

I have, personally, always liked the Benjamin sockets since their construction counteracts any jars or mechanical vibrations that may reach the sub base and which would otherwise get to the filaments of the tubes and produce, at the speaker, a disagreeable "bong." The springs permit positive connection to the pins in the base of the tube but also absorb the shocks. This is a clever mechanical and electrical design.

There are not many brackets as yet on the market that are nationally distributed and of the two or three that might be so considered, I found the Benjamin most suited to our purpose. Two C batteries are used and can be inserted beneath the sub base with very short leads and there is plenty of room provided by the use of these brackets for our 1.0 mfd. condenser and the four 0.5 mfd. condensers on the under side of sub base.

Why Cutler-Hammer Rheostats?

Cutler-Hammer rheostats received the choice for three very good reasons. First they are made in the exact resistance values I wanted, second they are unusually compact, and third they do not have to be taken apart to put them in. Many a good rheostat gets ruined for best results when taken apart by the builder and again assembled when mounted. They are

(Continued on page 46)

**A REAL RADIO SET
for \$27.27
Built Around
THE HEATH CONDENSER**

Designed by Citizen's Radio Call Book Laboratory

NOW you can build a super-efficient radio set at an extremely low cost.

The well-known performance of the Heath Condenser caused the Citizen's Radio Call Book Laboratory to design a radio set featuring this remarkable Condenser. There are two points of vital interest about the HEATH CONDENSER—

1. Permanent Flat Plates—stamped under huge presses to absolute flatness and tempered to prevent warping.
2. A micrometer geared vernier that reduces ordinary adjustments to hair breath distinction.

To each purchaser of a Heath .0025 Variable Condenser we are giving a complete set of plans, and instructions on how to build this high quality, low cost radio set. See your dealer and get yours today, or if your dealer cannot supply you, order direct, giving your dealer's name.

HEATH RADIO AND ELECTRIC MFG. COMPANY
206-210 First St. Newark, N. J.

MANUFACTURERS OF
Heath Condensers Heath Sockets Heath Dials
Heath Resistance Coupled Amplifiers





**Jones
Cable Plug**
PATENT PENDING

Combining
Cable and Soldering Lugs
(NO BINDING POSTS NECESSARY)
Little Brother to the
**Jones
MULTI-PLUG**
THE STANDARD CONNECTOR

4Foot \$1.00
8Foot \$1.25



HOWARD B. JONES 618 S. CANAL ST., CHICAGO, ILL.

RASLA STRATE-LYNE

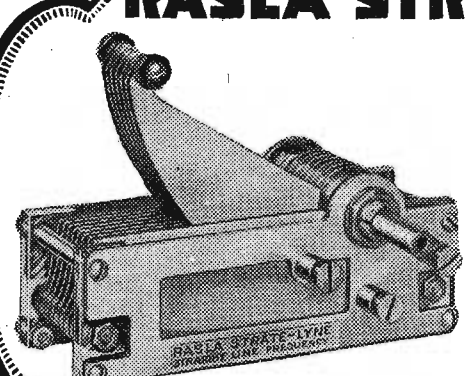

HERE is a real straight line frequency condenser at last—a condenser that really eliminates crowding, that really spaces stations evenly over the dials. It is the creation of Rasla, a name made famous by fine parts.

The RASLA STRATE-LYNE is built to standards usually adhered to only for laboratory instruments. The acid-dipped plates are heavier than on any other condenser, the spacing and alignment is more accurate. Split bushings are provided at both ends.

LIST PRICES

.0025	\$4.60
.0003	4.75
.0035	5.00
.005	5.25

At your dealer's or direct if he can't supply you.

The Rasla Fixed Detector is sensitive—and remains so. At your dealer's, \$1.25.

FREE—Write for the complete Rasla hook-ups.

DAVIDSON RADIO CORP.
222 Fulton Street, New York City

Friday, November 6

(Continued from page 29)

ist," W. H. Downes; 3:15, Art Rubin and his orchestra; 6:30, Big Brother club; 7:15, talk, E. E. Clive; 7:30, "Books and Plays," Sherwin L. Cook; 8, Neapolitan ice cream company concert; 8:30, Sager's half hour of hospitality; 9, musical; 9:30, Bianca Blacking, pianist; Viola Grant, soprano; 10, American House Marimba and orchestra.
WGBS, New York, N. Y. (315.6), 6-6:30 p. m., Uncle Geesee; 6:30-7:30, Anzell's orchestra.
WGBU, Fufford-by-the-Sea, Fla. (278), 6:30-7:30 p. m., Billy Steele's orchestra; 7:30-8:30, Blue Steele's orchestra.
WGPC, New York, N. Y. (315.6), 8:15-8:30, Jimmy Flynn, organ; 8:30-8:45, Eva Rothenberg, pianologue; 8:45-9, Ukulele Bob McDonald; 9:15-11, Shirley Herman, songs; 9:15-9:45, studio program; 10-11, Strickland's orchestra; 11-11:30, Club Ritz orchestra; 11:30-12, Club Roco entertainers; 12-12:30, Connie's orchestra.
WGR, Buffalo, N. Y. (319), 2:30-4:30 p. m., WGR's afternoon program; 6:30-7:30, the Claxo trio; 9-9:30, Winger's Crescent Park entertainers; "The Old Blacksmith Shop"; 9:30-10:30, program featuring Mary Louise Conover, soprano; 10:30-11, "Thirty Minutes of Something Different," Hewitt Rubber company; 11-11 a. m., Vincent Lopez Hotel Stadler dance orchestra, Harold Gleser, director.
WGY, Schenady, N. Y. (379.5), 6:30 p. m., International Sunday School lesson; 7, Albany Strand theater orchestra; Julius Boxhorn, conductor; Floyd E. Walters, organist; 7:30, health talk; 7:40, violin recital, Edward Rice; Ollie Yettru, accompanist; 8:15, WJZ Steinway series; 10:30, comedy drama, "Smiling Through," Allen Langdon Harton; Ten Eyck Clay, director.
WHAR, Atlantic City, N. J. (275), 7:30 p. m., fashion talk; 8, Seaside hotel trio; 11:15, Strand theater organ recital.
WHN, New York, N. Y. (361.2), 6:40-7 p. m., "Sunshine Talks," Billy B. Van; 7-7:30, Club Blehman entertainers; 7:30-8, "Cheerful Philosopher," Burr Mcintosh; 8-8:30, Colonial Aces; 10:30-11, Roseland dance orchestra; 11-11:30, Rodeo club orchestra; 11:30-12, Club Alabama orchestra; 12-12:30, Silver Slipper revue and orchestra.
WIP, Philadelphia, Pa. (508.2), 6:05 p. m., Benjamin concert orchestra.
WJAR, Providence, R. I. (305.9), 1:05 p. m., Woodstock entertainers; 8, musical program; 9, Maine Creamery hour; 11, Providence Biltmore dance orchestra.
WJR, Detroit, Mich. (617), 7 p. m., Jean Goldkette's Petite symphony orchestra; 8, Summerfield and Hecht presentation.
WJZ, New York, N. Y. (455), 8:30 p. m., Steinway program, Maier and Pattison; 10, Colgate program.
WKAQ, San Juan, P. R. (340.7), 8-9 p. m., entertainment, Porto Rican Athenaeum.
WLWL, New York, N. Y. (288.3), 8 p. m., question box; Rev. James Gillis; 2, Catholic study club; vocal and instrumental numbers.
WMCA, New York, N. Y. (340.7), 6-6:30 p. m., Olcott Vail and his Hotel McAlpin string ensemble; 6:30-7:30, Ernie Golden and his Hotel McAlpin orchestra; 8-8:15, "We Women," Betty Brainerd; 8:50-9, talk, Arthur L. Lee; 9-10, Hardman hour of music; 11:15-11:45, Donald Flamm, dramatic critic.
WNYC, New York, N. Y. (526), 6:10-6:20 p. m., market high spots; 6:20-6:30, piano recital; 6:30-7, elementary French lessons; 7-7:30, advanced French lessons; 7:30-7:35, police alarms; 7:35-8, resume of meeting of board of education; 8-10, studio musical program; 10:10-10:30, lecture, Prof. J. G. Carter Troop; 10:30-10:35, police alarms and weather forecast.
WOB, Newark, N. J. (405.2), 3:45-4 p. m., talk, E. P. Adams; 6:15-6:27, "Words Often Mispronounced"; 6:17-6:30, dinner music, Hotel Shelton; 6:30-7, Man in Moon; 7-7:15, dinner music, Hotel Shelton; 7:15-7:30, sport's talk, Bill Wathey.
WPG, Atlantic City, N. J. (299.8), 6:45 p. m., organ recital, Arthur Brook, organist; 7, Hotel Mortou dinner trio, J. Leonard Lewis, director; 8, educational series, Clara H. Kramer; 8:15, studio program; 9, Hotel Ambassador concert orchestra, Harry Loventhal, director; 10, organ recital, Jean Wiener.
WTAG, Worcester, Mass. (268), 12:05-2 p. m., luncheon

music, WTAG trio; 7:15, Twinkle Twinkle story teller; 8, concert program.
WTIC, Hartford, Conn. (475.9), 6:30 p. m., Young People's half hour; 7, dinner music, Emil Heimbarger's Hotel Bond trio; 8:30-12, community night program; midnight popular half hour for distant listeners.
WWJ, Detroit, Mich. (352.7), 6 p. m., dinner concert; 8, News orchestra; 9, dance program.
Central Time Stations
KFAB, Lincoln, Neb. (340.7), 5:30-6:30 p. m., Belshaw's orchestra; Buick Little symphony; 8:30-10:30, 30-minute night, Arnold.
KFNF, Shenandoah, Iowa (266), 7 p. m., Sunday school lesson; 7:30, St. Paul's Lutheran band.
KFVE, University City, Mo. (240), 10 p. m., Tom, Dick, Harry and Jack, entertainers; Orchestra Romaine.
KMA, Shenandoah, Iowa (252), 9-11 p. m., musicale, Seed and Nursery company.
KSAK, Manhattan, Kan. (340.7), 9 a. m., rural school; 12:35 p. m., "Routing the Rats," Roy Moore; garden talk, A. J. Schott; 4:30, lessons in color and design; 6:35, traveling and public speaking; "English Literature," "Water Purification," H. W. Brubaker; "Boundaries of a Farm," A. F. Peine.
KSD, St. Louis, Mo. (545.1), 6 p. m., Benjamin Rader's orchestra; 7:30, Commerce hour, Joseph Gustat, cornetist.
KTHS, Hot Springs National Park, Ark. (374.8), 9-10-10 p. m., New Arlington hotel ensemble; 10-10:30, Bennie Ford's DeSoto orchestra.
KYW, Chicago, Ill. (526), 6:35-7 p. m., Uncle Bob's bedtime story; 7-7:30, Congress hotel dinner concert; 7:30-8:30, Home Lover's hour; 10-12:30 a. m., revue; Coon-Sanders Original Nighthawks; Albert Matotte, organist.
WBAP, Fort Worth, Texas (475.9), 7:30-8:30 p. m., Junior Euterpean club; 9:30-10:45, Texas Christian university.
WBBM, Chicago, Ill. (226), 8-10 p. m., Ted Coleman, cellist; Manhattan quartet; Burdette Cleveland, singer; Carl Strodel, baritone; Montmarre orchestra.
WCCO, Minneapolis-St. Paul (416.4), 10:45 a. m., "The Versatile Potato"; 12 noon, Dick Long's Daytime trio; 2, woman's hour; 4, Readers' club, Mrs. W. Stevens; 5:30, Court of Gold Medal; 6:15, dinner concert, Dick Long's Nankin cafe orchestra; 7:30, "Canned Foods," Carey Emerson; 7:45, "Dairy Farming," 8:15, musical program; 10:05, Golden Pheasant orchestra.
WDAF, Kansas City, Mo. (365.6), 10:45 a. m., Betty Crocker series; 3:30-4:30 p. m., Star's string trio; 6-7, piano tuning in number; address, speaker Kansas City Children's bureau; Tell-Me-a-Story Lady; Trianon ensemble; 8-9:30, Star's Radio orchestra; 11:45-1, Plantation players; Eddie Kuhn's Kansas City Athletic club orchestra.
WEBH, Chicago, Ill. (370.2), 7-8 p. m., Oriole orchestra; Uptown theater; 9-10, Oriole orchestra; Katherine Forbes, soprano; Beulah Ladon, violinist; 10-11 a. m., Oriole orchestra; stories, Wayne Myers; Paul Small.
WFAA, Dallas, Texas (475.9), 6:30-7:30 p. m., Hawaiian music; 8:30-9:30, Schubert choral club recital.
WGES, Oak Park, Ill. (250), 5-7 p. m., Lydia Werner, soprano; John Brown, pianist; Katherine Gray, contralto; Edwin Kemp, tenor; Tiffin theater organ and orchestra; 8-9, Thomas Pappas, accordion; Tiffin theater organ and orchestra; John Stamford, tenor; McDevitt sisters, vocal duo; 11-11 a. m., Remington Welsh, organist; Parish and Ward; Sandy McAdish, Scotch comedian; Bebb and Cameron, duettists; Thomas Pappas, accordionist.
WGN, Chicago, Ill. (370.2), 6:30-7 p. m., Drake concert ensemble, Blackstone string quintet; 8-9, WGN string trio; 10-11, Jack Chapman's orchestra; Blackstone hotel dance orchestra.
WHAD, Milwaukee, Wis. (278), 6-7 p. m., Arthur Richter, organist; 7:05, Bill Juhre's Radio Cartoon game; 8:30-10, Wisconsin theater revue.
WHB, Kansas City, Mo. (365.6), 7-8 p. m., Sweeney Radio orchestra.
WHAS, Louisville, Ky. (399.8), 7:30-9 p. m., concert, Southern Baptist theological seminary.
WHO, Des Moines, Iowa (526), 7:30-9 p. m., Herring motor band; 11-12, dance program.
WHT, Chicago, Ill. (399.8), 6 p. m., classical program; Genevieve Burnham, soprano; Bob York, tenor; Grayling's string trio; Al Carney, organist; (238) 7:45-9:15, musical features; (399.8), 9:30, Loftis half hour of music; Freddie Whitmer, pianist; Samuel Rowe, tenor; Oscar Heather, tenor; Pat Barnes, tenor; Helen Ruhn, pianist; Husk O'Hare's orchestra; 12, Pat Barnes "Your Hour League," Al Carney.
WIBO, Chicago, Ill. (266), 6-8 p. m., studio program; 10-12, popular program; O'Henry quartet.

WJJD, Moseheart, Ill. (302.8), 10 p. m., Senator Kessinger, Ambrose Wyrick, Emma Butler, Jean St. Anne, Christian A. Grimm; Purple Grackle orchestra; 12, Geneva organ.
WLIB, Elgin, Ill. (302.8), 7-8 p. m., dinner concert, Drake concert ensemble; Blackstone string quintet; 9-10, Fred Hamm's orchestra; organ recital; 10-11, Jachras; jazz artists; 1-2 a. m., Chapman's orchestra; Blackstone hotel dance orchestra, jazz.
WLS, Chicago, Ill. (344.6), 6:30 p. m., Ralph Emerson, Barton organist; 7, lullaby time, Ford and Glenn; 7:15, Rodeheaver program, direction Vivian Tripp; 7:45, poet's corner, Wallace Bruce Ambsary; 8, R. F. D. program; 9, WLS trio; 10, Lillian Johnson; 10:40, Ford and Glenn.
WMAA, Chicago, Ill. (447.5), 6 p. m., Chicago theater organ; 6:20, Family Altar League; 6:30, Wide Awake club program; 8, musical lecture, Mr. and Mrs. Marx E. Obendorfer; 8:30, Whitney trio; 9, University of Chicago talk; 9:20, Elizabeth Stokes, soprano; 9:45, Christian Endeavor topics.
WMBB, Chicago, Ill. (250), 7-8 p. m., Beatrice Teller, Joel Lay; Jean St. Anne, Florence White Rusic; 9-11, Trianon orchestra; Morey Alswang, Jack Murnane, Cecil & Esther Ward, Stokes & Agne, Edward Hines.
WOAW, Omaha, Nebr. (526), 6 p. m., music review, Heater Bronson; 6:30, orchestra; 7:10, sport talk, Ivan L. Gads; South Omaha; 10:30, Gilbert Jaffy and his Little symphony.
WOC, Davenport, Iowa (483.6), 8-9 p. m., Eddie Stein, organist; Heuer's whizz bang orchestra.
WOK, Homewood, Ill. (217.3), 6-7 p. m., Ed Kemp, tenor; Jean Carlson, soprano; Kenyth Dunn, pianist; 10-11 a. m., Harry Davis, tenor; Haymakers trio; Herman Sinaiko, violinist; Harriet Lee, contralto; Berger Wedberg, tenor; Rosemary Hughes, soprano; Banks Kennedy, organist.
WORD, Batavia, Ill. (275), 8 p. m., Webster hotel concert trio; 8:15, Mary McMahon, pianist; Donald Rice, trombonist; William Loblaw, cornetist; 9:15, business talk, Mark Law.
WQJ, Chicago, Ill. (447.5), 7-8 p. m., Rainbo Gardens orchestra; Clement Laskowski, tenor; Maude Shapton Cause, soprano; Henrietta Nolan, violinist; "Weekly Road Review," I. J. Mors; 10-11, Rainbo Skylarks; Dr. H. Lucile Long, woman harmonica player, Blues Destroyers trio; Parish and Ward; Ed McGinnis, accordionist; 1-2, Ginger hour.
WSB, Atlanta, Ga. (428.3), 8 p. m., Independent quartet; 10:45, entertainment.
WSM, Nashville, Tenn. (282.8), 6:30 p. m., Beasley

Smith's orchestra; 7, Bonnie Barnhardt's bedtime story.
WSD, Milwaukee, Wis. (246), 5:30 p. m., Caroline Ramming, soprano; Adolph Suppan, clarinetist; 6:45, week end's best book, Bookworm; 9, Iver-John mandolin-guitar quintet.
WSUI, Iowa City, Iowa (483.6), 12 m., Mrs. Mildred B. Paddock, soprano; school of music.
Mountain Time Stations
CFAC, Calgary, Can. (435.9), 7-8 p. m., dinner program, Gladys Foster, director.
KFAA, Ogden, Utah (261), 9-10 p. m., studio program, KOA, Denver, Colo. (322.4), 12:15 p. m., Rialto theater musicale; 6:30, dinner concert, Herbert White and his Silver State orchestra; 8, contest, jazz-classical, Dr. Lindsay B. Longacre; Denver concert quartet; Barbara Loomis, pianist; KOA orchestra; Dr. Edwin J. Stringham, dean, Denver College of Music; Harmony Peerless orchestra; Jim Sill, banjoist; Louette Milton, soprano; Bernie Clements, pianist; Rivoli theater.
Pacific Time Stations
KFOA, Seattle, Wash. (454.3), 6:45-8:15 p. m., Sherman, Clay and company, studio program; 8:30-10, Times studio program; 10-11:30, Eddie Harkness and his orchestra.
KFPJ, Hollywood, Calif. (238), 8-10 p. m., KFPJ concert orchestra, Charles Beachamp, dramatic tenor.
KFWB, Hollywood, Calif. (252), 6:30-7 p. m., Alladema program, E. P. Jones; 7:30, microphone brevities; 7:45, Eye-O-Logue, Dr. Marchutz; 8-9, Warner Brothers synopsators, Charles Beachamp, tenor; 9-10, program, Paralta studios, Drove Norton Lindsay, tenor; Paralta orchestra and others; 10-11, Warner Brothers frolic, direction Norman Manning.
KGW, Portland, Ore. (491.5), 9-10:30 p. m., concert, Sherman, Clay and company; 10:30-12, Hoot Owls, Rose City trio; Pantagas acts.
KHJ, Los Angeles, Calif. (405.2), 6-6:30 p. m., Leighton's Arcade cafeteria orchestra, Jack Cronshaw, leader; 6:30-7:30, history story, Prof. W. S. Hertzo; Richard Hendrick and Vyola Von, screen starlets; bed time story by Uncle John; 7:30, "Romance of Santa Fe Trail," Miss Gladys DeWitt; 8-10, program, Western Auto Supply company, arranged by J. Howard Johnson with Western Glant Cord orchestra; 10-11, Art Hickman's Biltmore hotel dance orchestra.
KLX, Oakland, Calif. (508.2), 6-7 p. m., Aunt Elsie's Late Pirate for children; 8-9:45, Modesto night, bands, solo artists; 9:45-10:30, Sweet's ballroom, Harry Davis and his entertainers.
(Continued on page 46)

Advertisement for Victoreen Super-Heterodyne radio. Features an image of the radio and the Eiffel Tower. Text includes: 'Verified Reception from Paris by Cadiz, Ohio, Radio Fan', 'Coast to Coast On a Loop is easy with a Victoreen Super-Heterodyne', '4—No. 170 R. F. TRANSFORMERS at \$7.00 each and 1—No. 150 Oscillator Coil at \$5.50', 'Constitute the Heart of the Circuit', 'No oscillations, howls or squeals—no matching of tubes.', 'Complete parts to build the "Victoreen" can be purchased of your dealers for between \$50.00 or \$75.00—depending on quality of material selected.', 'THE GEORGE W. WALKER CO. Cleveland, Ohio', 'Branch Sales Offices Are Located at: 50 Church St., New York City; 719 Raymond St., Philadelphia, Pa.; 1323 Wall St., Dallas, Texas; 910 Terminal Sales Bldg., Seattle Wash.; 300 Sugar Bldg., Denver, Colo.; 332 St. Catherine St., W., Montreal, Que., Can.; 383 Brannan St., San Francisco, Calif.; 508 So. Dearborn St., Chicago, Ill.; 45 Ruggery Bldg., Columbus, Ohio; 443 So. San Pedro St., Los Angeles, Calif.; Box 321, Boise, Idaho; 332 St. Catherine St., W., Montreal, Que., Can.'

Advertisement for Sterling Tube Testers. Features images of two models: 'Universal' Tube Tester and 'Home' Tube Tester. Text includes: 'Check Your Tubes and Find Your Troubles!', 'These Two Home-Service Instruments Belong in Every Set Owners Equipment', 'Universal Tube Tester: More than a tube tester; really a set servicing instrument for it tests vacuum tubes, transformers, sockets and wiring circuits. It determines the plate current and hence the amplifying value of tubes by readings shown on plate and filament emission meter and plate milliammeter. PRICE: \$18.00', 'Home Tube Testers: Don't judge your tubes by the glow nor the time they've been in service. Test them with a scientific Sterling Tube Tester that anyone can understand and quickly determine whether a tube is a good, fair or poor amplifier. Also used to locate other troubles. PRICE: No. 399 for small tubes . . . \$10.00 No. 401 for large tubes . . . 8.50', 'THE STERLING MANUFACTURING COMPANY Cleveland, Ohio', 'Sterling TUBE TESTERS and Set Servicing Instruments', 'ON EXHIBIT At Chicago Radio Show Space Number K-3.'

Advertisement for The Kane Antennae. Features text: 'The Greatest Achievement in Radio Since the Advent of the Super Broadcast Station', 'The Kane Antenna eliminates all power noises and most all the squeals from regenerative sets. It filters the air bringing music to your set as it leaves the broadcast station. What more can you ask?', 'Enjoy your set the year 'round. No need to lay it up in the summer. The KANE ANTENNA TAKES CARE OF ALL DISAGREEABLE NOISES. You have invested a lot of money in your set. Why not give it a chance with a good aerial. Your car will run on distillate, but how much better does it run on a high grade of gas? So with your radio set. It will operate on most any old aerial, even the clothes line or bed springs, but just hook it on to a KANE ANTENNA, and HEAR AS YOU HAVE NEVER HEARD BEFORE.', 'THE KANE ANTENNA makes all sets good sets, makes listening a pleasure and not a pain. If you are not troubled with power noises the KANE ANTENNA WILL GIVE YOU BETTER RECEPTION.', 'The Kane Antennae Co., Apt. 810, The Argonne, Washington, D. C., May 27, 1925. Gentlemen: As you know, a short time ago I purchased a set of working drawings of the Kane Antennae. On account of my living in an apartment house I was unable to construct one for myself, but I bought all the material necessary for installation and sent it home to my younger brother who lives in the country and who is also an ardent radiophan, asking him to install it as soon as practicable and then write me what he thought of it in comparison with the single wire antennae he had been using. In a few days he wrote me to the effect that the first night he tried it he was amazed at the result: that one stage of audio had delivered as much if not more volume than two stages did when using a single wire and the usual ground connection. His letter was an unqualified endorsement of all your claims and stated further that in addition to the extra loud signals, stations came in twice as clear as formerly and that the selectivity of the receiver was accordingly increased to a marked degree. All of which makes me want one just like it so much that I am seriously considering moving to a new location in the city where I can erect one of the Kane Antennae for my own use. And who wouldn't want one when it is evident that your Antennae is without a peer among all makes of antennae. Respectfully yours, VIRGIL MCOMAS.', 'If you prefer to build your own antenna, or would like to look over the full working drawings of the Kane Antenna, just enclose a dollar bill and we will send you a complete set of working drawings and instructions for erecting. These drawings will be accepted back by us at full purchase price on an order for an antenna.', 'The Kane Antenna is now sold only from Factory to consumer. Only one small profit instead of three, the consumer getting the benefit of the price.', 'The Kane Antenna is made in two styles. The regular for all sets other than R. C. A. Super Hets.....Price, \$13.00 The Special for R. C. A. Super Hets only, \$6.50 Full working drawings (stamps not accepted) \$1.00 Mail to any part of the U. S. postpaid on receipt of price. Sent C. O. D. when 25% accompanies order.', 'THE KANE ANTENNAE CO., 3343 W. Monroe St., Chicago, Ill.', 'The Kane Antennae has linked the Atlantic and Pacific.', 'NOTE—The Kane Antennae Company have moved their factory from Hoquiam, Washington, to Chicago.'

"TRAVELER" FIVE TUBE

(Continued from page 41)

when rheostat is turned to left as far as will go and in the off position.

The left rheostat is also turned clockwise until the indicator points horizontally to the left.

Reading from left to right, the three large tuning dials will be considered as numbers 1, 2 and 3. Now when tuning, it will be found that maximum sensitivity in the first two tubes is obtained, on the lower dial numbers, with the left hand rheostat slightly below horizontal while, on the higher numbers, the rheostat is to be turned until almost vertical.

This left rheostat acts as a control over regeneration and, with it, regeneration and the consequent gain in sensitivity, can be secured at any wave length. In other words, the set can be made to squeal or go into oscillation at any wave length—a condition to be avoided by all means. This rheostat should be brought up toward maximum, at any setting of the dials only until the hissing is heard or the crackling of static. One quickly learns the approximate position of the rheostat pointer, over its effective arc of about one inch, for any setting of the dials.

Tuning Dials 1, 2 and 3

In this connection, one is guided by the settings of dials 2 and 3 which run together and rarely, if ever, should be more than a degree apart when adjusted for maximum strength on a station. Dial 1 is affected by the close coupling of the antenna system and will be found to run from 5 to 10 degrees below the other two. The following paragraph gives the settings of dials 2 and 3 on the writer's set for a number of stations and, if the specified parts have been used throughout, these stations should be found on approximately the same numbers.

WOK, 217.3 meters, 9; KFNF, 266 meters, 34; WFBM, 268 meters, 39; WPG, 299.8, 49; KDKA, 309.1 meters, 52; WSAI, 325.9 meters, 58; WTAM, 389.4 meters, 74; WLIT, 394.5 meters, 76; WLW, 422.3 meters, 80; WCAE, 461.3 meters, 85; WSUI, 483.6 meters, 89; KSD, 545.1 meters, 96. Since the lowest class B station is KTAB at Oakland, Calif., with a wave length of 215 meters, it can be readily seen that this outfit covers the range nicely. KSD uses the highest wave length released in this country.

Grid Leak Adjustment; Voltmeter Use

With an out-of-town station tuned in, one can adjust the variable grid leak (to the right of the third Thorola coil) for maximum sensitivity and then leave it alone. Turning this Bradley leak to the left increases the resistance and increases the sensitivity on distant stations until a point is reached where everything sud-

denly "plops" out and the grid leak must be turned back until the station again comes in. The right rheostat which controls the detector tube can likewise be set. This should be done by strength and clearness of program and not by voltmeter.

The voltmeter is employed as follows: The detector rheostat has, presumably, been set with the storage battery fully charged. This charge (and likewise the voltage) will gradually go down. With best setting, connect the flexible negative wire of the voltmeter to point X-1 of figure 2 which appeared in the October 10 issue. This point on the set is either end of wire 34, preferably the end which attaches to the right terminal of the right rheostat. The voltmeter reading should be carefully observed and jotted down. Each evening, before beginning operations it is an excellent idea to clip this wire to the point mentioned and adjust rheostat until voltmeter again gives the recorded reading.

However, in the initial tryout period, after determining the correct detector voltage, switch the flexible wire to point X-2 of figure 2 to get the voltmeter readings on several different wave lengths. This point is either end of wire 27, the writer using that end which connects to the left terminal of the left rheostat. As described before, this rheostat is varied as one uses the upper or lower end of the scale on the tuning dials. The flexible lead can very well be left on this point and control of the radio frequency amplifier tubes' voltage varied by the voltmeter readings. For example one quickly learns that at 10 on the dials 2 and 3, the meter may show 4½, at 40 on the dials the pointer may be a fraction under 5, while at 80 on the dials, the voltmeter may read around 6. These figures will depend, of course, on the tubes, the battery lighting them and the B batteries.

The Air Line Radio Map and Log

Has a mile scale that gives distance

IN LINE RADIO MAP AND LOG

INSTRUCTIONS FOR USING AIR LINE RADIO MAP AND LOG

This Map is Up-to-Date When You Get It and Is Kept That Way

monthly supplemental service, for the whole season.

Order NOW for Real Radio Enjoyment

Printed in three colors. Price 50c. Size 12 x 18.

Lists stations by call letters, also by wave lengths. UNIQUE BROADCASTING SCHEDULE. LOG shows location; difference in time; power, meters and kilocycles; spaces to list dial settings; time heard, distance, signal strength. Whether you use outdoor aerial or loop.

At your dealers, or sent postpaid. Dealers and Jobbers Write at Once.

MULTIVIDER CO. ST. JOHN AND ASKEW. KANSAS CITY, MO.

Increasing Selectivity; Tone Quality

If one has trouble with selectivity and either cannot separate two locals completely or cannot break through them to get out of town, shift the flexible aerial lead to the other A point.

If one still has trouble in securing selectivity even on the better of the two, the antenna length must be cut down about 10 feet and, if originally over 110 feet including lead-in, may have to have two or three 10-foot pieces chopped off.

Another alternative is to take the flexible lead from the antenna binding post and solder it to a .00025 mfd. fixed condenser, the other terminal of which is to be soldered to the antenna binding post.

There should be no trouble with clarity of programs. The writer had none and the builder should have none either. However, it is possible that a slight blurring on strong signals may be noticed. In this case, try connecting a fixed condenser of a size between .00025 mfd. and .001 mfd. across either audio frequency secondary or the second audio primary. If a fixed grid leak cartridge and its clips are around, results can sometimes be improved by connecting it across any of the pairs of terminals just mentioned.

Surprise—Using a Loop

No mention has as yet been made of the use of the left jack which, in the circuit, is placed between the first Thorola and the first variable condenser. It was saved as a surprise feature.

A loop antenna can be used on this tuned R.F. set, due to the fieldless coils. This has been impossible on neutrodynes

and most tuned R.F. sets because of interaction between the loop and the coils. The first question is, "Can you get out of town on the loop?" to which the answer is that you certainly can, in any location but a steel building or a house badly shielded by a large steel apartment building or factory next to it.

When the air is comparatively static-free and DX good, use the outside aerial. When the conditions are good for long range but there is considerable static, use the loop. If there is a particularly wonderful musical number on some nearby station and you wish it absolutely clear of all interference and static, use the loop. The loop will pick up practically none of the blurrings of howling sets nearby, picks up no power hum unless in the house, and covers a good range when pointed properly toward stations, but the same range cannot be expected as that obtained on the outside antenna.

(CONCLUSION)

EXPLANATION OF RADIO

(Continued from page 33)

together with some of the electrons. Around this cluster of protons and electrons is distributed the remainder of electrons.

A copper atom for example is made up of a total of sixty-three protons and sixty-three electrons. At the center are

(Continued on page 45)

B ELIMINATORS

Assured Success

With New Type Tubes and

DONGAN

Transformers Chokes

Designed especially for operation with the new Filament and Non-Filament Tubes, Dongan Transformers and Chokes are most essential parts of the remarkable new B-Eliminators. These new Eliminators are thoroughly endorsed by Cockaday and other authorities.

Transformers

No. 509 Full wave For Raytheon Tubes
No. 537 Full wave U X 213 For R. C. A. Tubes
No. 537 Full wave C X 313 For Cunningham Tubes
No. 538 Half wave U X 216-B For R. C. A. Tubes
No. 538 Half wave C X 316-B For Cunningham Tubes

\$7.00

Chokes

No. 514 20 henry \$5.00
No. 506 30 henry
No. 539 50 henry

B. BARSOOK

53 W. Jackson Blvd. Chicago, Ill.
DONGAN ELECTRIC MANUFACTURING CO.
3001 Franklin Street Detroit, Mich.
Transformers of Merit for 15 years

The TOWN CRIER

Radio's Most Beautiful Speaker

WRITE today for illustrated description in colors of this beautiful instrument—"The Speaker with the Voice that Thrills." You will be delighted with the artistic stippled finish and the gorgeous colors of the Town Crier models in Green and Golden Polychrome. Ask your Dealer to show you a Town Crier—you will recognize its surpassing excellence instantly.

PRICE \$17.50 \$18.50

West of the Rockies

GALE RADIO LABS.

2513 Irving Park Blvd. CHICAGO

AMBASSADOR

ALL LONDON

FOR FREE 4 PAGE COIL FOLDER

COILS HAVE RECEIVED ROME AND LONDON BOTH VERIFIED

AMBASSADOR SALES CO., 108 Greenwich St., N.Y.

New Perpetual LOG

Loose Leaf for Revisions

Full of Information

Call letters and State Wave length Power in Watts Remarks

Radio Map FREE With 1st Order

New 64 page log. Corrected sheets may be secured as changes in calls, wave lengths, owners, etc., occur. Holds 504 stations. Shows call, city, wave lengths, 4 dial settings, remarks, etc. Tuning suggestions. Station list by wave lengths—by states, etc. Owners. Trouble aids. Other valuable information. So convenient. Worth many times small cost. Get more pleasure from your radio. Only \$1.

Send No MONEY Pay postman after log arrives. Postpaid if pay with order. Money refunded if not delighted. Order today—now.

Radio Printers, Dept. 8817, Marengo, Ill.

Reg. U.S. Pat. Office

Lincoln

RADIO PRODUCTS

Oscilloscope

For the Grand Prix "Superhet"

The Lincoln Oscilloscope permits such delicate control of the oscillations that it produces remarkable results. It supplies the builder of "Superhets" with one of the most important pieces of apparatus used in construction of the set. A perfect oscillator, a compact unit of quality materials and fully guaranteed.

If your dealer cannot supply you, send check or money order direct.

Price \$6.50

Writes for Lincoln Catalog

Lincoln Radio Corporation

224 N. Wells St. CHICAGO

Morrison

Loud Speaker

Matchless Reproduction with the

MOCKING BIRD UNIT

and your Phonograph

For complete enjoyment of all that is best in radio, for purity of tone and plenty of volume on distant stations, be sure your set reproduces through a Morrison Unit—a standard for four years. Attach the Mocking Bird Unit to the tone arm of your phonograph (fits all popular makes) and you have the finest possible means of reproducing radio reception, \$7.50.

Mocking Bird Cabinet \$30

Be sure your holiday orders are in early. Remember the rush for Morrison Loud Speakers will surpass all previous years. Set Mfg's. We are able to supply units in quantity orders at attractive prices. Deliveries are assured with acceptance of order.

To own a Mocking Bird Cabinet is to possess the peer of all loud speakers. The Morrison Unit is instantly adjustable—just one conspicuous advantage. Built to out-last your set you can depend upon long life from your Morrison Speaker. You will be proud of your Mocking Bird—not only its performance but the artistry of its design and workmanship.

If your dealer cannot supply you send money order or check to factory. If you prefer we will ship C. O. D. Every Unit sold on money back guarantee.

Morrison Laboratories

343 E. Jefferson Ave. Detroit, Mich.

Wow that Static!

KILL STATIC

Enjoy clear reception of all stations without annoyance. The Static Eliminator—the newest and most startling thing in Radio—cuts out practically all static without loss of volume.

And in addition it will help increase selectivity, tune out local stations, sharpen signals, remove noises, lessen interference and stop re-radiation!

Use it with any receiving set—hook it up in less than a minute and enjoy perfect reception unmarred by static.

\$1.00 Postpaid

Mail Your Order Today. Satisfaction Guaranteed. Money refunded at once, if returned within 3 days.

Static Eliminator Company

611 United Bank Bldg. CINCINNATI, OHIO

Not a Bit of Static!

Questions and Answers

3

Delco Plant Interference

(14779) JWM, Wawota, Sask., Can.
How can we make it possible to operate our receiving set while our Delco lighting plant's engine is running? We need the lights at the same time we want to use our receiver.

A.—To be sure of ridding yourself completely of all interference caused by the Delco system, you should read "Radio Inductive Interference and Its Cure," which was published in two parts in the issues of Radio Digest dated August 1 and 8. Copies of these may be secured from our circulation department at 10 cents a copy, if you do not have them in your files.

Internal combustion engine interference may be considerably reduced by making the leads from the magneto or spark coil to the engine as short as possible and running them through a grounded shield such as a metal conduit or lead covered cable. The frame of the engine, magneto, and all shield should be thoroughly grounded.

Use of A. C. for Filament Lighting

(14739) FCJ, Lachine, P. Q., Can.
Is the use of stepped-down A. C. from the house lighting supply for the purpose of lighting audio frequency amplifier tube filaments, to be recommended, or can it be compared with a good storage battery for the same purpose?

A.—A good storage battery is best. Articles on the use of A. C. for this purpose were published in Radio Digest for the purpose of informing experimenters who wished to play with it.

Can "S" tubes be used in B battery eliminators in place of 201A or W.E. tubes? The latter have a very short life (from 400 to 600 hours) when so used, whereas the "S" tube life is rated at 3,000 hours. Can you suggest any other rectifier tubes more suitable for B eliminators?

A.—The "S" tube can be used, and several manufacturers are using it. The new UX-213 Rectron, made by the R. C. A., is suitable. This Rectron permits full wave rectification. The UX-216B permits half wave rectification.

Reversing Storage Battery Charge

(14782) CW, Kansas City, Mo.
Can a storage battery be charged in reverse? What should I do to get it back in order? Will it hurt the efficiency of the battery?

A.—If you have charged reverse by mistake, you have simply discharged the battery by so doing. Charge it to the proper gravity in the correct order. It is not believed that you have hurt the efficiency of the battery.

EXPLANATION OF RADIO

(Continued from page 44)

the sixty-three protons but only thirty-four of the electrons. The remaining twenty-nine electrons are distributed at quite some distances from this central cluster. Let us draw the copper atom on a large scale.

Word Picture of Copper Atom

Imagine the sixty-three protons and thirty-four electrons in one compact cluster at the center of a race track six-

teen miles in radius (length of track lap equals 105 miles approximately). On this track are two electrons each about the size of an automobile. They are chasing each other around the track and going at the rate of 5,000 miles per hour.

The race track is enclosed within two concentric boxes (one within the other) on which sit other electrons as spectators. Only the eight corners of the first box are occupied and these corners are 48 miles away from the race track. There are 18 electrons on the next box and they must view the race from a distance of 128 miles.

There is but one electron unaccounted for. The seats are all filled so he is compelled to stay outside. The nearest he is allowed to approach is 240 miles from the track. He wanders around trying to find some place to view the glorious race within, like a boy with no money trying to see a ball game through a knot-hole. Occasionally he gets disgusted and runs over to a neighboring atom, several hundred miles away, in search of better luck. His luck does not improve so he continues to wander. During this time some other electron in similar circumstances may be temporarily occupying his original knot-hole.

This natural tendency for some of the electrons of copper atoms to wander is responsible for copper being classed as a good conductor of electricity.

Other metals are constructed similarly. The great ease with which electrons can be sent from one end of a copper wire to the other is of supreme importance.

Reducing Race Track to Actual Size

The description of the copper atom has been on a colossal scale. It had to be in order to get the electrons as large as a familiar object. Actually, the outermost electron, instead of traveling at an ap-

proximate distance of 256 miles from the center of the atom, is only 1/200,000,000 (one two-hundred-millionth) of an inch away.

The electron itself is only one ten-trillionth of an inch in diameter.

The description of the atom given above puts the atom on a par with the heavens above as far as the relative amount of space is concerned, and copper is just an example.

There is so much space within and between all the atoms composing the earth that if it could be pressed out the earth would be only one-half mile in diameter!

An electron in a piece of 14-gauge copper wire, one inch long, has about as much space in which to move as a fish has in all the oceans. Yet, in this short piece of wire there are 4,500,000,000,000,000,000 atoms all widely separated and each one contains sixty-three protons and sixty-three electrons distributed as described above.

Who said learning about Radio would destroy its beauty?

Electrons Not Protons, Move

Returning to the structure of copper, it will be seen that the electrons do the moving. Therefore, the conduction of electricity ordinarily has to do with the movements of electrons (instead of protons) and the expressions "currents of electricity" and "current of electrons" are used synonymously.

For the same reason, when a substance is said to be positively charged, it usually means that some electrons have been removed rather than protons added to it. A negatively charged body is one containing an excess of electrons.

(Next week Mr. Tanner will discuss ether waves. The explanations will be made just as clear with commonplace similes as those contained in this article.—Editor's Note.)

B Eliminator for Hetduogen

(14705) AEC, Jackson, Mich.
Will a B battery eliminator prove satisfactory on a six tube Hetduogen?

A.—Yes, providing the B eliminator is of a type that will supply about 20 milliamperes without a voltage drop. The larger B eliminators do this.

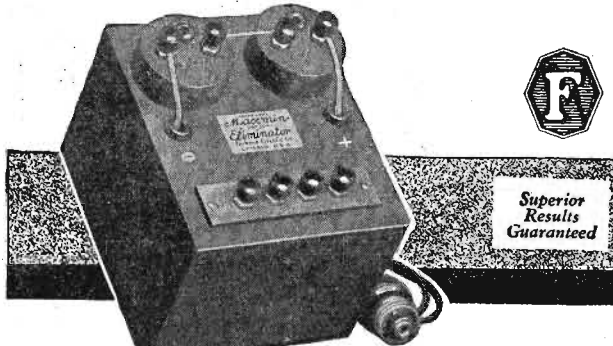

Superior Results Guaranteed

\$9.75

Now-Plate Voltage for any Set — and You can afford it!

First Cost Economy now makes it possible for EVERYONE to obtain efficient "B" current supply right from their electric light socket. Now one of the biggest improvements in modern-day radio reception is placed within the reach of all. Think of it! A perfect, always efficient source of plate voltage for any set for \$9.75! It marks a revolutionary step forward and will be welcomed by millions of radio enthusiasts.

Ferbend "B" Eliminator

The price of this remarkable new unit is spectacular in more than one way. Besides saving you from \$15 to \$50 it is amazingly low considering the quality and superiority. You may ask "how could it be possible to build such a unit for the ridiculously low price of \$9.75?" True mechanical genius and resourcefulness alone are responsible. But the logical way to answer this question is to equip your set at once with this marvelous unit and be convinced.

ASK YOUR DEALER—OR SEND DIRECT

FERBEND Wave Trap

This company also manufactures the famous Ferbend WAVE TRAP—the instrument which has been widely imitated but never equaled. It is the only original and genuine. See advertisement on page 46.

Until nation-wide distribution is completed it is possible that your dealer hasn't stocked the MAXMIN "B" Battery Eliminator as yet. So you will not have to wait, we will make prepaid shipment direct to you upon receipt of \$9.75, or C. O. D., plus postage. Remember, superior results are guaranteed or your money back. Be one of the first to own and use the Ferbend MAXMIM "B" Battery Eliminator.

Use the COUPON NOW!

Ferbend Electric Company
427 West Superior Street
Chicago, Ill.

Ferbend Maxmin "B" Eliminator

FERBEND ELECTRIC CO.
427 West Superior St., Chicago

Send Postpaid. I am enclosing \$9.75.
 Send C. O. D. Plus few cents postage.
 Send Literature.

Name.....
Address.....
City.....
State.....

Complete, nothing else to buy.

Operates at maximum efficiency at all times on either direct or alternating current, any frequency.

Delivers unlimited current to any receiving set regardless of number of tubes.

Delivers 100 volts to ANY set.

Cost of operation less than 50c a year.

It lasts indefinitely.

All parts are specially designed and manufactured by us for this purpose only.

Unconditionally Guaranteed

to be equal or superior to any eliminator on the market, regardless of price.

New Radio Static Filter

Increases Volume
Decreases Interference

Easily Attached

This new radio invention actually separates radio tones from static, clearing reception by detouring static.

Study the diagram shown at the side of this ad. It shows where the static and radio tones enter the Filter together. Inside the Filter, the static and radio tones are separated, the static being detoured to the ground through the "A" Storage battery. But the radio tone waves are filtered through entering the set purified, clearer and increased in volume.

Attach the Filter to any set—no matter what kind—note the reception—cut out the Filter—note the difference.

With the "A B C" Filter attached to your set, you hear music as it is really played by the artists—you hear the dramatic climaxes of speeches—you understand the market reports and other announcements. Distant stations are brought in easier, due to the increased volume.

Lightning Proves Claims

We have on file a sworn statement by a Stockton, Illinois, business man Lightning struck his building and was carried by a radio aerial to a set equipped with the "A B C" Filter. The lightning was carried through the Filter to the ground with absolutely no injury to the tubes, batteries, tuning unit or cabinet. The building was unharmed. The Filter is a perfect lightning arrester. If it will detour lightning—it will detour static. Write for a copy of the sworn statement. In event your dealer cannot supply you with the "A B C" Filter, simply mail us \$5 00, and we will send one direct with full instructions for attaching. Full guarantee with each Filter.

THE FREEPORT RADIO CORPORATION
Manufacturers "A B C" Static Filter. (Patent Pending)
11-15 West Stephenson Street
Freeport, Illinois, U. S. A.

Sold On Money Back Guarantee

Static and radio tones enter Filter here, coming direct from aerial.

Static or lightning detoured here through the "A" Storage Battery to the ground.

Radio tone waves leave Filter here, purified, clearer and in greatly increased volume.

DEALERS
If you have a store or business of your own and are prepared to work cooperatively with aggressive sales and advertising help, write us today for full particulars about our proposition to dealers. We are desirous of forming connections with responsible dealers interested in selling a product of real merit, and the "A B C" has demonstrated itself to be this.

...will commence early in December. Judge. ...up before the

Friday, November 6

(Continued from page 43)

KNX, Hollywood, Calif. (336.9), 6:15 p. m., travel talk, W. E. Alder; 6:30-7, Atwater Kent Radio orchestra, Paul Finstein, leader; 7-7:30, dinner hour music; 7:30-8, program, Eastern Outfitting company; 8-9, West Coast theaters; 9-10, Carlylo Stevenson and his El Patio ballroom orchestra; 10-11, Order of Optimistic Donuts, Davis Perfection Bread company; 11-12, Ray West's Coconut Grove dance orchestra from Ambassador hotel.

"FIRESIDE" RECEIVER

(Continued from page 42)

not vernier rheostats, but vernier types are not needed here and we save some money.

There is not much choice in jacks or switches to be sure, as they are all simple and built pretty much alike. However, the Yaxley line has always appealed to me for good sound design and consistently good production so the single jack used is a Yaxley, as is the switch.

Fixed Condensers, Large and Small Among the various bypass condensers of large size that might be used, I have put in Dubiliers largely because they seem to be more available in all parts of the country than are other makes. They

Wanted—

Commercial operator for 100-watt Radio station, in town of 100,000. Regular or part time. Radio department sales work in connection with the operating. Steady employment year round. Good salary. Pleasant place to work. Advise fully about yourself in first letter. X. Y. Z., CARE OF RADIO DIGEST 510 North Dearborn St. CHICAGO, ILL.

Advertisement for Ambassador coils, featuring a large illustration of a coil and text: 'SEND FOR FREE 4 PAGE COIL FOLDER. COILS GOT KFI ON INDOOR ANTENNAE VERIFIED ONLY 2 TUBES. AMBASSADOR SALES CO. 108 Chicago, Ill.' The illustration shows a person working on a radio set.

Advertisement for Radio Experts, featuring an illustration of a man working on a radio and text: 'RADIO EXPERTS EARN BIG MONEY. Thousands of big pay opportunities open to the radio trained man. Success easily won in the fastest growing industry of all time. From land and sea comes the urgent call for men who can construct, install, operate, repair, maintain and sell radio equipment. CASH for Your Spare Time! Take orders from your neighbors for radio sets. Get big fees for your services and advice. Home study qualifies you—short course, low cost, easy terms, money back guarantee. FREE Wonderful tube receiving set of latest design. Range over 1000 miles. Write today for FREE copy of "Radio Facts". A. G. MOHAUPT, Radio Engineer RADIO ASSOCIATION OF AMERICA 4513 Ravenswood Ave., Dept. RD-2 Chicago

Advertisement for World Storage Batteries, featuring an illustration of a battery and text: 'RADIO Storage "B" Battery Lasts Indefinitely—Pays for Itself Economy and performance unheard of before. Recharged at a negligible cost. Approved and listed as Standard by leading Radio Authorities, including Pop. Radio Laboratories, Pop. Sci. Inst. Standards, Radio News Lab., Lofax, Inc., and other important institutions. Equipped with Solid Rubber Case, an insurance against acid and leakage. Extra heavy glass jars. Heavy, fitted plates. Order yours today! SEND NO MONEY Just state number of batteries wanted and we will ship day after tomorrow. Extra Offer! 4 batteries in series (66 volts), \$12.75. Pay expressman after examining batteries. 6 per cent discount for cash with order. Mail your order now! WORLD BATTERY COMPANY 1219 So. Wabash Ave., Dept. 76 Chicago, Ill. Makers of the Famous World Radio "A" Storage Battery. Prices: 6-volt, 100 Amp., \$11.25; 20 Amp., \$15.25; 40 Amp., \$21.00. All equipped with Solid Rubber Case. Set your Radio Dials at 210 meters for the new 1000 watt World Storage Battery Station, WSCB, Chicago. Watch for announcements. WGN WWS KHL KGO KFAT WYV KOL

have also, however, the advantage of compactness which is to be considered when designing any set. Mounting lugs are sensibly placed and construction is sturdy. The two smaller fixed condensers are Electrad because as substantially built against capacity change as any other and a means of securing them to the sub base is provided. Using the bus bar as support is all very well but why not have everything secured solidly if possible?

I feel sure you will like the use of the Jones Cabelug in preference to the five binding posts that would otherwise be necessary. This method of connecting the batteries makes it impossible for wires to come loose at the binding posts and short circuit B voltages through the tubes. If anything is to be done within the set it is very easy to disconnect the minus A, minus B and plus B-45 at the batteries.

(Due to his long association with the Radio field, Mr. Fournier's choices as to parts are apt to be perfect when choosing the best possible units for a set of the type we requested. Radio Digest readers

Long Distance Radio \$2.95. Lambert's newest crystal success. No tubes. No batteries. No grief. Always ready. Works 600 miles. Fully guaranteed. We pay postage. Order direct from this ad. Leon Lambert, Wichita, Kansas.

Advertisement for The Accurate Dialing Chart, featuring a grid illustration and text: 'The Accurate Dialing Chart is always Up to Date. It gets you the station regardless if the wave length has been changed. It is small like an envelope. It does away with the logs, maps, etc. Money back if not the best you have seen. Price 50 Cents Post Paid Accurate Dialing Chart Co., Kingsburg, So. Dak.

Advertisement for FREE RADIO STAMPS, featuring an illustration of a stamp and text: '616 beautiful copper etched American, Canadian, and European stamps, each with the call letters of a station. FREE with Ideal 48-page Radio Stamp Album and Log. Also contains complete list of stations both alphabetically and by call letters. As you hear new stations, just put the proper stamps in your album. Album and stamps become a permanent and interesting record of the stations you receive. You and your children will enjoy it. Complete album, 8"x11", heavy board covers, \$1 plus postage. Send No Money Just pay postman after album and stamps arrive. We prepay postage if you prefer to pay with order. MONEY REFUNDED if not DELIGHTED. Send order today—NOW. Postal will do. IDEAL CO., Dept. 8817, 366 Wrigley Bldg., Chicago

Advertisement for 22 1/2 VOLT \$2.95 battery, featuring an illustration of a battery and text: 'It's OUT—Complete everlasting ready to run non-acid, non-sulphating 22 1/2-volt rechargeable "B" storage battery, \$2.95. Includes chemical. Does not lose its charge standing idle. Special 2-22 1/2 volts (45 volts) \$5.25; 90 volts \$10.00; 112 1/2 volts \$12.50; 135 volts \$14.75; 157 1/2 volts \$16.80. Nearly 3 years sold on a non-red tape, 30-day trial offer, with complete refund if not thoroughly satisfied. Further guaranteed 2 years. Knock-down kits at still greater savings. Complete ready to run "B" battery charger \$2.75. Sample cell 35c. Order direct—send no money—simply pay expressman its cost on delivery, or write for my free literature, testimonials and guarantee. Same day shipments. My large 36-page radio goods catalogue 10c. B. D. Smith, 31 Washington Ave., Danbury, Conn.

Advertisement for The MOLLIFORMER "B" UNIT REPLACES "B" BATTERIES, featuring an illustration of a battery unit and text: 'The MOLLIFORMER "B" UNIT REPLACES "B" BATTERIES BUILD IT YOURSELF You can assemble this powerful B Unit in an hour, at a great saving, and use the current from the light socket. Excellent for Supers and all TRF Sets —Noiseless—no Tubes or acid—Utilizes full wave rectification. Guarantees greater Clarity, DX and Volume at cost of 1/10c per hour. Completely eliminates "B" Battery, and is sold with a positive GUARANTEE of satisfaction or money refunded. Write for descriptive circular. PRICE Complete Kit—60 Cycle Unit.....\$22.50 Complete Kit—25 Cycle Unit..... 24.50 Kits include Rectifiers. Parts sold separately if desired. DEALERS—Write for our proposition. C. E. JACOBS, Sole Mnfr. 2802 N. Kedzie Ave. CHICAGO

are getting the benefit of the experience of an expert. Next issue Mr. Fournier takes up the layout and drilling of the panel and sub base.—Editor's Note.)

Advertisement for Watch Ground Line Carefully, featuring text: 'Efficiency can be increased from 25 to 100 per cent by the proper installation of both aerial and ground. The latter has been neglected much more than the former connection. Contrary to general opinion a water pipe is not always the best ground line. The actual ground connection starts at the real ground where the conductor enters it. Rather than have a water pipe connection running from the third story to the ground, it is better to have a counterpoise of equal or longer length.

RADIO CLUB MEMBERSHIP FREE. Also pay cash for new members. LOG Club, Bedford Building, Chicago.

WRITE FOR OUR RADIO CATALOGUE. Before buying your Radio and accessories, THE MALONE RADIO CO., 8 West Ontario Street, Chicago.

Advertisement for BUILD A NOISE REDUCER "AERIAL", featuring text: 'We have given it a year's test and found it satisfactory. Cost less than \$5 to build it. Blue Print and Instructions Mailed Upon Receipt of \$1.00 Tidmarsh's Radio Supply, Elwood, Ind.

Advertisement for AT LAST One-tube Cabinet Set for only \$6!, featuring an illustration of a radio cabinet and text: 'Lowest Price on the market Absolute Satisfaction Guaranteed Every home should have one of these Economy sets. Selects stations at longest distances, giving clear, full tone quality. The kind of reception that makes radio worth while. Finest joined wood cabinet, beautifully finished in crystallizing enamel. Large, sensitive tuning dial. Any number of earphones can be attached at one time. An excellent buy for the whole family. Send no money. Write now for an Economy Set, and pay the postman when he delivers it. If notified within five days that the set does not satisfy, we will exchange it or refund your money. Economy Radio Company, Temple Bar Bldg., Cincinnati, O.

Advertisement for B-Metal B-Metal B-Metal, featuring an illustration of a crystal and text: 'Best for Crystal Sets Best for Reflex Sets B-METAL REFINING CO. METAL LOUD TALKING CRYSTAL 25 CENTS DETROIT Approved by RADIO NEWS also POPULAR RADIO Concert Tested—Guaranteed Absolutely Peerless Third Radio Season on the Market Crystals come and Crystals go, but the B-Metal Loud Talking Crystal remains the American Standard Radio Crystal because a Quality Product made by Specialists who have a Reputation to Maintain. Some of Our Other Products Are The Star Fix't Crystal. Price.....\$1.00 The Crystalstat. Price.....\$2.50 Responsible Factory DISTRIBUTERS wanted for all broadcasting cities. STAR-B-METAL COMPANY 525 Woodward Ave. Detroit, Mich.

Advertisement for THE PERFECT TUBE THE ELIXIR OF Set LIFE, featuring an illustration of a tube and text: 'Detector and Amplifier Types SSP-201A, SSP-199, SSP-12 Bakelite Base Silvered and Blue Just as the heart is the most vital organ of the human body—the tube is the most vital part of the radio set. The Simplex Super Power Tube performs its function in the radio set with the same sensitiveness, accuracy and regularity as a healthy heart in the human body. Rejuvenate your set with the Simplex Super Power tubes, they mean longer life and better reception. PRICE—Silvered tube.....\$2.00 Blue tube..... 2.50 GUARANTEE: Your dealer is authorized to exchange or return money for any defective tube within ten days. Titania Manufacturing Company Makers of the "SIMPLEX SUPER POWER" RADIO TUBES 105 West 40th Street New York City

Advertisement for Some Pipes Bad Grounds, featuring text: 'Steam pipes usually have rubber gaskets at the joints, limiting the current path to the connecting bolts, thus resulting in high resistance and poor ground. Gas pipes also have rubber and other insulating materials at the joints and besides are tabooed by insurance companies.

Make your own B-Eliminator with our imported French parts, high quality, minimum cost. Send stamp for details. B-Free Co., 6453 Bosworth, Chicago.

Jos. J. Hoffmann, Burlington, Wis., publishes and puts beautiful ballad on the air. Call or write your favorite radio station, ask them to sing or play, "DEAR LITTLE PAL," for you.

Advertisement for Yaxley RADIO SETS AND LOUD SPEAKERS, featuring an illustration of a boy and text: 'Exclusive Proposition to Dealers and Agents H. E. GELHART & CO. Rock Island, Ill.

Advertisement for radio dealers, featuring an illustration of a radio and text: 'for radio dealers —our big new catalog; fully illustrates the best in radio. Write on letterhead for copy — ask for AD1005 We Ship Fast Wakem & McLaughlin, Inc. 225 E. ILLINOIS STREET CHICAGO, ILL.

Advertisement for The Traffic Cop of the Air, featuring an illustration of a person and text: 'Add a Ferbend Wave Trap to your Radio Set and "Police" your reception. Regulate traffic! Guaranteed to tune out any interfering station. Widely imitated but never equalled. Not a "toy"—quality, material, workmanship equal to that of the finest receiving sets. The original and only successful WAVE TRAP. Now in its fourth year. Sent postpaid upon receipt of \$8.50 or C. O. D. plus postage. Send for Free Booklet. Ferbend Electric Co. 427 W. Superior St., Chicago See the new Ferbend "B" Eliminator announcement on page 45 U. S. Post Office, Billings, Mont. "Ferbend Electric Co. Gentlemen: With my Fada Neutrodyne and Ferbend Wave Trap I received the address of Fern Coollidge from WOA-W Omaha, on a special wave length. Many fans tried to get it but failed. Also the beautiful World Set from WOA-W and K.M.A. Shenandoah, Iowa. Had W.E.F. New York, loud enough to carry across the street. Will put my Set and Wave Trap up against any in the city regardless of price. (Signed) J. A. Thompson, Supt. of Mails."

Advertisement for A New SUPER KIT \$17.50, featuring an illustration of a kit and text: 'With Perfectly Matched Transformers and Filter This Is a SUPERADIO Product—Your Guarantee of Satisfaction! The most selective, the most powerful, longest ranged, finest toned 8 tube super ever designed. Intermediate transformers matched to identical peaks and filter tuned to same peak. Kit includes Antenna Coupler, Oscillator Coupler, Special Variable Condenser, Tuned Input Transformer, 3 matched intermediate transformers and hardware. Complete with booklet, diagrams and full sized working drawings which positively assure perfect success. Order now. Only \$17.50. SAVE MONEY ON THIS COMPLETE OUTFIT Every Kit Made Up of Individually Tested Parts as Follows: Superadio Inductance and Transformer Kit, 2 Heath Radiant Condensers, 2 Keystone Audio Transformers, 3 Benjamin Sockets, 2 Carter Rheostats, 1 Potentiometer, all necessary fixed condensers, 2 "Megs" Grid Leaks, 1 Mounted Binding Post Board, 1 Base Board, 1 Drilled Panel, 2 "Dialog" Vernier Dials, 2 Truflux Rheostat Dials, 3 Carter Jacks, 1 Carter Filament Switch, Soldering Lugs, Bus wire and wood screws, diagram and instructions. \$73.50 WRITE FOR OUR FREE RADIO CATALOG OF NEWEST PARTS WILLIAM A. WELTY COMPANY 36-38 So. State St. Chicago

For Some—a “radio” For others—Zenith!



Super-Zenith IX
Built-in Zenith loud-speaker;
ample compartments for dry
and storage batteries.

Super-Zeniths priced from \$240 to \$355
DeLuxe Art Model Cabinets From \$500 to \$2,000
Other Zenith Sets \$100 and \$175



New Zenith De Luxe Chinese Model

Equipped with two built-in loud speakers, Bates
Rotary Log, illuminated dial, single control
specially constructed Zenith Radio Circuit

Some prefer the blare of a circus band
—or the friendly jangle of a hurdy-
gurdy. To them it is the only music.

Those who delight in blare and jangle
do not *need* a Zenith—but they will find
that even such music rings truer to their
ears brought in by Zenith radio.

Others go breathless at the golden notes
of a lyric soprano—or the rapturous
harmonies of a great symphony.

Such people—born with a love for
music—should *never* content them-
selves with any radio instrument less
fine than Zenith.

Zenith's appeal to the eye is instant—
and enduring. Its clear, sweet tone is a
revelation.

To see and hear one of the new Super-
Zeniths for the first time is a memorable
experience. Yet that experience is yours
for the asking—in your own home if
you so desire.

Simply telephone your nearest Zenith
dealer.

Again Commander Donald B. MacMillan chose Zenith
for his Arctic Expedition. When human lives may
depend upon the reliability of radio performance, only
one reason can explain his choice: Zenith has proved
to be the best obtainable at any price.

ZENITH RADIO CORPORATION
Straus Building, Chicago

ZENITH
TRADE MARK REG
LONG DISTANCE
RADIO

It Costs More

But It Does More!