

How to Wire Fireside—the Perfect Reproduction Set; Tuning of Grand Prix; Pictures of Ford and Glenn, CYL, Mexican Broadcaster, and KFVB, Hollywood

Radio Digest

EVERY WEEK **Illustrated** PROGRAMS **TEN CENTS**

REG. U. S. PAT. OFF. & DOM. OF CANADA

Vol. XV

Copyright 1925
By Radio Digest Publishing Co.

SATURDAY, NOVEMBER 14, 1925

No. 6

LIGHT TUBE HELPS RADIO

RADIO ADDRESS AIDS IN STOPPING SUICIDE

WEAF LISTENER TUNES IN
AND HESITATES IN ACT

Inspirational Talk of Rev. Caddell Halts
Plans for Self Destruction, Writes
Fan to Station

NEW YORK.—A Radio fan's inability to resist the impulse to turn on the Radio set and hear what was going on before committing suicide, resulted in saving her life, for she happened to tune in an eloquent inspirational address by Rev. D. V. Caddell of Philadelphia, which was being broadcast by WEAF here, direct from the Radio Industries banquet. The letter tells the story:

"Just a few lines to let you know just what the Radio means to me, and dear God knows how many more it has helped. My husband has been out of work a long time and I have tried ever so hard to get work, so it just seems I could not stand any more so had intended to end my life.

"I was all alone Wednesday evening and intended to end it all. Now don't think me crazy, but it just seemed I could not pass my Radio set without tuning and I did and got WEAF broadcasting the Radio Industries' banquet from New York and a doctor from Philadelphia was making an address. The part about souls made me wake up to the fact of the wrong I was intending to do."

Marjorie Maxwell, below, recently enjoyed as a singer on the WGN Sunday programs, has now joined the Chicago Civic Opera company.



NEW HOOK-UP WILL BENEFIT AIR PICTURES

Photo-Electric Cell Combined with
Radio Amplifier Has Vast
Possibilities

NEW YORK.—The photo-electric cell, which is used in turning light into electrical current in picture telegraphing, in talking films, in new types of phonographs, in television experiments and in many other processes, has been combined by V. K. Zworykin, a physicist of the Westinghouse Electric Research Laboratories, with the Radio vacuum tube amplifier forming a new scientific device of vast possibilities, which was exhibited publicly for the first time.

Variations of light falling on this instrument, which looks nearly the same as an ordinary Radio tube, instantly become variations of electrical current and are amplified many thousandfold.

The photo-electric cell, which makes
(Continued on page 2)

One of the brightest of the "Bright Lights," a feature of the WMCA, New York programs was Mlle. Otero, left. Below is Miss Dorothy Wilkins, of WHT whose Radio voice brought her a contract with Snubert's "Student Prince."



NEW TUBE HELPS RADIO

(Continued from page 1)

electricity out of light, is built into the standard Radio tube. One end of the Radio tube is coated on the inside with potassium or some other alkaline metal which throws off showers of electrons when light falls on it. Electron showers are electrical currents. The shower is feeble if the light is feeble, heavy if the light is strong. Any variation in light changes the intensity of the electron shower. The current which the light strikes out of the alkali metals is amplified before it leaves the tube.

Represents Three Years Work

Three years ago Zworykin got the idea of uniting the tube and the photo-electric cell. For the last year and a half he has been at work in the Westinghouse laboratories overcoming the practical difficulties. The instrument was so complex and sensitive that it was difficult to prevent any one part from interfering with the action of the others. For instance, if any of the filaments of the tube produced a light of its own, this would upset the whole apparatus, because the photo-electric cell would respond to that light, instead of to external light.

Overcoming these difficulties, Zworykin exhibited yesterday a tube so sensitive to light changes that the smoke of a cigarette was utilized to ring a bell. The smoke came between a lantern and the Zworykin device. It intercepted enough light to lower the electrical current which the light from the lamp had been producing. The fall in current permitted a switch to close and rang the bell. Using the device in connection with a loud speaker the inventor produced a howl by passing a wire one millimeter thick between the lantern and the cell.

Has Many Uses

The photo-electric cell is at present used in combination with the amplifying tubes for a great variety of purposes, including the turning of printed words into musical sounds, so that the blind may read by ear; the steering of torpedoes, ships or automobiles by Radio; the transmission of pictures by wire and Radio; the attempt to transmit motion pictures by Radio; the reproduction of sound by phonographs which use films instead of wax records, and the measuring of the light of stars and planets.

When used in combination, the current which is produced by light in the photo-electric cell is led off to the vacuum tube and there amplified. This method requires the use of more apparatus and tends toward cumbersomeness. Zworykin's invention makes it possible to simplify apparatus in all processes which call for the conversion of light into electricity.

Mr. Zworykin said yesterday that the Westinghouse company was working on a process for transmitting pictures by Radio, and that this would be useful in this connection.

Optimistic on Television

Speaking of television, or the projection of motion pictures, on which several inventors are working, Mr. Zworykin said:

"All the processes that are needed for projecting motion pictures are in existence already. The theory is all right, but at present the apparatus would have to be endless, cumbersome and uncertain. But it will be simplified. It will take some years, but we will have eventually the instantaneous or near-instantaneous transmission of motion pictures."

The inventor said he thought the new combination tube was a step in the direction of television, but nothing more. One of the Zworykin patents covers a combination of his photo-electric and Radio tube with the interferometer invented by A. A. Michelson, the American astronomer. The interferometer is the most sensitive measuring instrument known.

Expects Extensive Patent

The Michelson invention is so sensitive that its performances can be disturbed by the slightest sound. The patent, which Zworykin is seeking to cover both his own combination of devices and the interferometer, is intended to give him the rights over any microphone that may be produced by the combination of all three.

"It might be possible," he said, "to combine the principles and produce the most sensitive microphone in the world. The interferometer responds to pressure by changes in its shadows, or interference fringes. It might be possible to arrange the grids of the photo-electric cell in such relation to the interference fringes so as to produce disturbances of current corresponding to the disturbances produced by the sound waves in the interferometer. The trouble is now that such a combination of instruments would react wildly and violently to sound. It would be necessary to find some way of controlling their oversensitivity. I covered this combination by patents, but of course, many things are patented which do not come to pass."

The physicist said that his invention could be used for measuring the light of stars and for recording continuously the

Control Old Warship Target Via Wireless

Does Everything But Return Fire Without Man Aboard

LONDON, Eng.—The British Radio-controlled warship Agamemnon is being used by the Atlantic Squadron of the British navy as a target. Without a man on board the Agamemnon can maneuver, change course, increase or decrease speed—do everything, in fact, except hit back when attacked. Probably she will do that soon, too!

All her movements are controlled by Radio from the destroyer Shikari. During the last target practice visibility was bad, but the big ships opened at very long range, fire being directed by spotting airplanes.

When the cruisers closed, the Agamemnon turned to windward, put up a smoke screen, and hid herself completely from the ships, all by Radio, but she could not escape the eyes of the planes above, and salvo after salvo struck her, but the shells, having no bursting charge, did practically no damage.

light of variable stars. This is now being done by astronomers using the photo-electric cell and the tube separately.

Another application is a burglar alarm, alarm, the gong being set in action when the burglar passes between a window and the photo-electric cell. It is said to have manifold uses in railroad signaling.

HALLOWEEN PARTY IS NEW WLS DEDICATION

Use 5,000-Watt from New Hotel Sherman Studios

CHICAGO.—The inaugural program of the new superstation of WLS, of the Sears-Roebuck Agricultural Foundation was broadcast the evening of Saturday, October 31, under the direction of Director Edgar L. Bill. The 5000-watt station is located at Crete, Illinois, on the Dixie Highway. The new studio, an example of an entirely new type of art, is in the New Hotel Sherman here.

A Halloween party formed the initial program. Starting at 6:30 p. m., Ralph Emerson, on the Barton organ, demonstrated the new studio pipe organ, built especially for broadcasting, in a Halloween skit.

This was followed by Lullaby Time, with tick-tacking, witches and goblins under the direction of the Lullaby Boys, Ford and Glenn. Then came an old-time Halloween party for the members of the R. F. D. club, including a barn dance, apple-bobbing and corn-husking bee.

Play Reviews Make Big Hit

PHILADELPHIA.—"Both Sides of the Footlights," a feature which is put on the air from WLIT here every Tuesday evening, at 7:50, eastern time, has proved so popular that a New York publisher has written to Allyn C. Saurer, who conducts this feature, asking him to prepare enough copy for this type of material for a book. The publisher's idea came after he had listened in to one of Mr. Saurer's dramatic reviews and sidelight talks.

SEA TO LAND PHONE SERVICE IS SUCCESS

MARCONI TELLS OF 2-WAY SIMULTANEOUS TALKS

Can Be Extended to Any Subscriber on Communication Lines Proved By Test

LONDON.—"It is too early to go into details about the use of Radio telephony at sea, but technically, complete success has been achieved," declared Senatore Guglielmo Marconi in an interview just granted.

"For some years," the Radio wizard continued, "telephony has been carried out on board ship, and recently special attention has been directed to the problems involved. Experiments have been carried out between ships themselves and also between ships and the land.

"Radiophone messages have been sent and received over a distance of 400 miles, and satisfactory apparatus has been designed which can be fitted on board ship to give a perfect service of duplex Radio telephony either between two ships or between a ship and the shore.

Can Link with Shore

"The use of this instrument can be further extended by linking the shore station with the post office telephone lines, and so establishing a service between a ship at sea and any telephone subscriber in the British Isles. The multiplicity of spark Radio telegraph stations on the coast causes considerable interference between one station and another. This makes it difficult to arrange for a new Radio service, particularly a phone service, which could be fitted in without being subject to interference from other stations, and itself interfering to some extent with broadcast reception on the coast. This is the greatest difficulty in establishing a service of this kind.

"Another question involved is the commercial one as to whether the demand for such a service is sufficient to justify the cost of its adoption. It is possible to provide a ship with a telephone service which will enable the captain and passengers of a vessel at sea to converse easily with officers and passengers on other vessels, and this service could be linked up with the land telephone network.

Germany Not Leading

"The impression seems to have been created that Germany is ahead of us in this matter, but we are in a position to meet any demands that may be made for such a service.

"Recent experiments carried out between a post office telephone exchange at Southampton and the steamer Princess Ena demonstrated how easily and satisfactorily such a service could be carried on. Conversations took place between the vessel fifty miles from Southampton and telephone subscribers in Southampton, London, Leeds, Liverpool, and other cities.

"If Radio telephony is to be made available to ship passengers, the apparatus will have to be in a separate cabin.

"The apparatus used on the Princess Ena for experiments in linking up with the landline system, was a set of small power using only 400 watts. It is similar in principle to a set already widely used in the linking up of outlying islands, towns, railway centers, and business offices, with the addition of a connection to the post office landline telephone network.

Uses Two Wave Lengths

"The Radio set is operated on two wave lengths, one for transmission and the other reception, with a sufficient difference between them to avoid mutual interference. No technical knowledge is needed to use the set. The switching on of the power puts everything in operation, and conversation can be carried on in the same way as with the ordinary telephone.

"By this duplex system two persons can converse freely, as distinct from the simplex system which was first used in Radio telephony, in which only one person could speak at a time, and in which it was necessary for a switch to be thrown over when one person had finished speaking and wished to hear the reply of the other subscriber.

"The apparatus is compact and takes up very little room."

First Turkish Woman Broadcasts

LONDON.—Listeners here have just had the opportunity of hearing from 2LO the voice of the first Turkish woman ever to be broadcast. She is Mme. Aly Sami Bey, wife of the director of the Government School of Arts and Crafts, Constantinople, and the subject was "The Turkish Lady Yesterday and Today." The program also contained selections of genuine Turkish music.

CONTENTS

Radio Digest, Illustrated, Volume XV, Number 6, published Chicago, Illinois, November 14, 1925. Published weekly by Radio Digest Publishing Company, 510 N. Dearborn Street, Chicago, Illinois. Subscription rates, yearly, Five Dollars; Foreign Postage One Dollar additional; single copies Ten Cents. Entered as second class matter at the post office at Chicago, Illinois, under the Act of March 3, 1879.

All the Live News of Radio.....	1 to 10
Classics from WEAF Charm Millions.....	4
New Tickets, Children, for New Woodshed Show.....	5
KFWB, Where Movie Stars Are Radio Stars.....	6
A Junket to the Mexico City Studios of CYL.....	7
Following Sports Through Mike.....	10
Operating and Trouble Shooting.....	11
Advance Programs for the Week.....	13 to 21
Evening at Home With the Listener In, a chart in central time, showing when to listen in for your favorite stations.....	20
Editorials, Indi-Gest and Condensed by Dielectric.....	22
Interesting and Simple Explanation of Radio, Chapter III—How Music Is Converted Into Ether Waves, by H. G. Tanner.....	23
The Grand Prix Eight Tube Super-Heterodyne, Part IV—Putting It in Operation, by James McDonald.....	25
Fireside: 6 Tube Set of Perfect Reception, Part III—The Wiring, Which Should Be Done Slowly, by Jacques Fournier.....	27
Good Impedance Coupled Amplifier; Other Kinks.....	29
Questions and Answers.....	30
Directory of Radiophone Broadcasting Stations, Part I.....	31

Looking Ahead

Overland in a Box Car with Radio for Company—Adventuresome as it sounds, that's just what "George," one of our Indi-Gest column contributors, is used to. And his "private" box car, fitted with Radio, aeriols and everything, will be shown. How "George" gets his inspirations for the poetry he writes, may also interest many readers.

Everyone Cannot Vacation at Atlantic City, but many who have been fortunate enough to pick up WHAR, the Seaside hotel station in that famous resort, have been there in spirit while the tubes were bringing in a program from the ocean shore. Next week we will take a peek into that plant in a page of pictures and words.

The Inner Workings of WBBM, one of Chicago's newest and most popular broadcasters, will be revealed in another page feature with many pictures.

The "DX-Seven" Is a New Type of Super-Heterodyne involving the use of the famous D-coil principle in its intermediate transformers. Regeneration is also employed in the loop circuit, and so many other refinements have been incorporated that John G. Ryan, who gave you the "Simplest Super" and "Traveler," has found it unnecessary to use more than one stage of audio frequency amplification. Hence the name, long range or DX-Seven.

The Operation of Fireside, the Perfect Tuned R.F. Set forms the fourth article by Jacques Fournier. In next week's issue, he tells how to hook it up and how to use the regeneration and volume controls that make this set unique.

Newsstands Don't Always Have One Left

WHEN YOU WANT

Radio Digest

YOU WANT IT!

BE SURE OF YOUR WEEKLY COPY BY SUBSCRIBING NOW

SEND IN THE BLANK TODAY

Publisher Radio Digest,
510 N. Dearborn St.,
Chicago, Illinois.

Please find enclosed check M. O. for Five Dollars (Six, Foreign) for One Year's Subscription to Radio Digest, Illustrated.

Name

Address

City..... State.....

KFWB, Where Screen Stars are Air Stars

Dorothy Devore (below) was one of Hollywood's thirteen Wampas Baby Stars of 1925—a broadcasting baby, too, at Hollywood's Station KFWB.

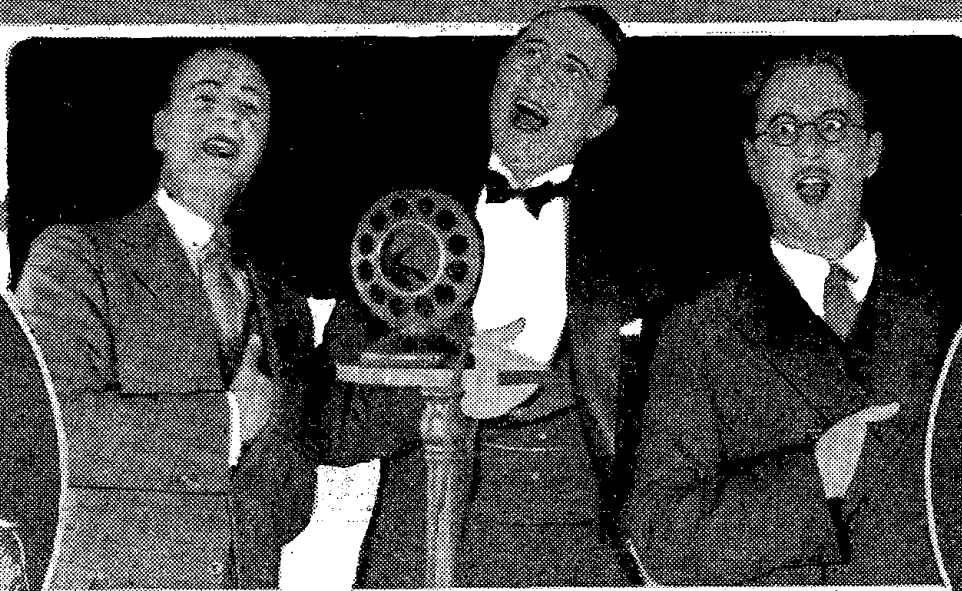

Louise Fazenda's microphonic drollery makes a hit over KFWB. Ben McGlashan (right, below)—not "Big Ben" but "Big Brother" to western kiddies.



Where the "Blues" come from—because that is Monte Blue right next to the little listener; Huntley Gordon (left) and Matt Moore (right). Now—one, two, three—watch the "mike" tremble when they hit that ultramarine note! Oh boy! But did you hear the four of them? The other man just went out for some more cough drops. Those KFWB fans just love this Blue trio.

IT ALL came about this way. Frank Murphey, who is the head of the electrical department of Warner Bros. Hollywood motion picture studios, answered a call put out for him by Jack Warner, who is the head of production at Warner's.

"Frank," said Mr. Jack Warner when Murphey had finally presented himself after regretfully parting with a balky generator, "we want a Radio station, a regular, full-sized Radio broadcast station. Like to have it up by March 4. Think you had better put it up out in front over on the east side of the lot. Go ahead and fix it up."

"You want a what, and when?" asked Murphey, for this request sounded a little different from the thousands of queer ones he had heard in a lifetime around the studios.

"I want a Radio broadcast station and I want it on the air by March 4," patiently explained Mr. Warner as if he were explaining something absurdly simple to a backward child. "That gives you 28 days from today. What more do you want. I haven't time to bother with details; get it up, get it going and come back and tell me about it."

And that, as the saying goes, was that! Did Jack Warner know that the Western Electric company would not promise delivery of a set for at least four months; that no studio was built—not even on a drawing board—that no towers were

erected, that no one around Warner Bros. had the slightest idea what a Radio station was and what to do with it after it was built? He did not, and he did not care. After the quaint ways of the old Roman emperors he had given his orders and now it was up to his organization to come through and produce the goods. To him it was no more than stating that so-and-so would play in Warner Bros. next picture, such-and-such, production to cost a certain sum and be done in six weeks.

One hour after Murphey left the one-sided conference, half of which was spent in expressing to the great Hollywood out-of-doors in colorful Hollywoodese profanity what he thought of the proposition, carpenters had their orders to build the Radio studio and the first-class Radio minds of Southern California had been summoned by telephone and telegraph to state and show what they knew about Radio.

True to schedule, KFWB came on the air March 4, 1925, with a 500-watt Western Electric station, just 28 days after Jack Warner had put out his order. Two 150-foot steel towers had been erected in front of the executive office building on Warner Bros. studio lot, a Radio studio had been built and completely equipped, staff hired and talent booked. But the night that KFWB opened up did not see Murphey among those present. He had just received an order to produce a six foot flash of artificial lightning and had just figured it out, he needed about 1,500,000 volts of electricity to do the job right, which is about one million more volts than our great industrial laboratories usually like to fool with.

So KFWB came on the air. It is a station with an unusual setting. It is the one and only Radio broadcast station owned and operated by a motion picture producing company and it is located on the production lot only a few feet away from the stages where some of our best movies are made.

And KFWB is an unusual Radio station. Whether this is due to its affiliation with the motion picture industry, the climate of California, or Norman Manning, it is a little hard to say. Perhaps because of all three.

In the first place, many famous stage and screen stars appear over the air at KFWB as guest announcers that no other station, less fortunately located, could command.

In the second place, the climate of California has attracted so many people of note in the entertainment and musical world that Hollywood and KFWB have a greater array of talent than can be secured anywhere else, with the possible exception of New York.

And lastly, Norman Manning. Look behind the scenes of every highly successful enterprise and you will find some personality that is the main-spring. In Radio stations you seldom will hear their names or know their voices as contact is made with a Radio station's audience through the announcing staff and not across the manager's desk.

Norman Manning came to KFWB without the slightest knowledge of Radio. He did not even know what a vacuum tube looked like, much less what it did. But he had a background of (Continued on page 10)

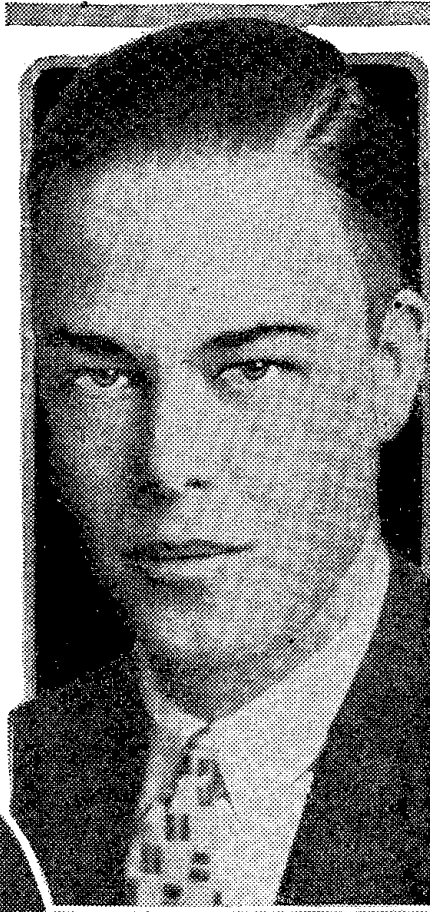

Hi Moulton, right, is the red headed leader of that red pepper orchestra, the Hollywood Revelers. Below, Warner Bros. movie and Radio studio, beneath tower.

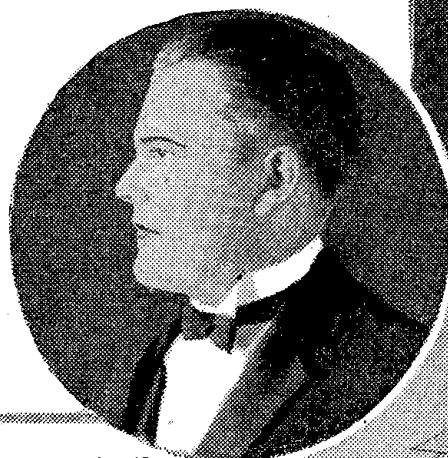

Patsy Ruth Miller (left) — there's your Patsy darling folks, just as she stands when you hear her sweet voice over KFWB. Norman Manning (below), manager of KFWB.

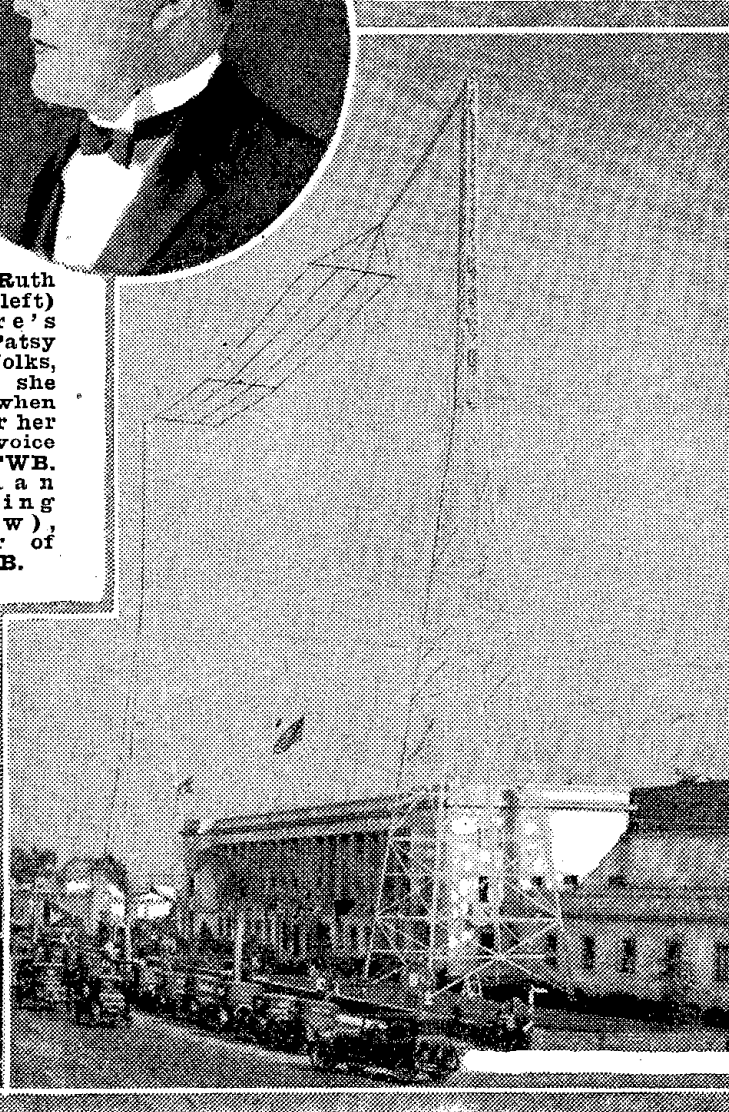
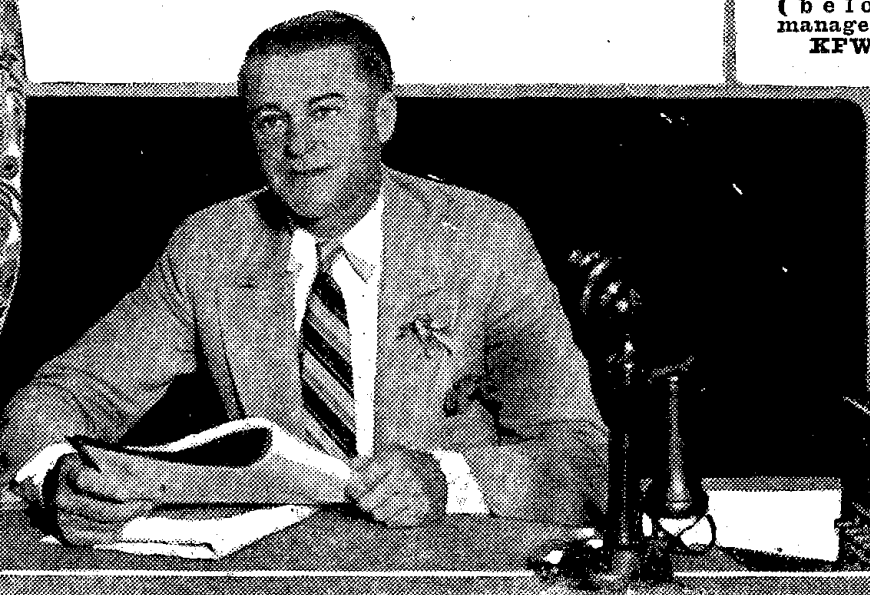
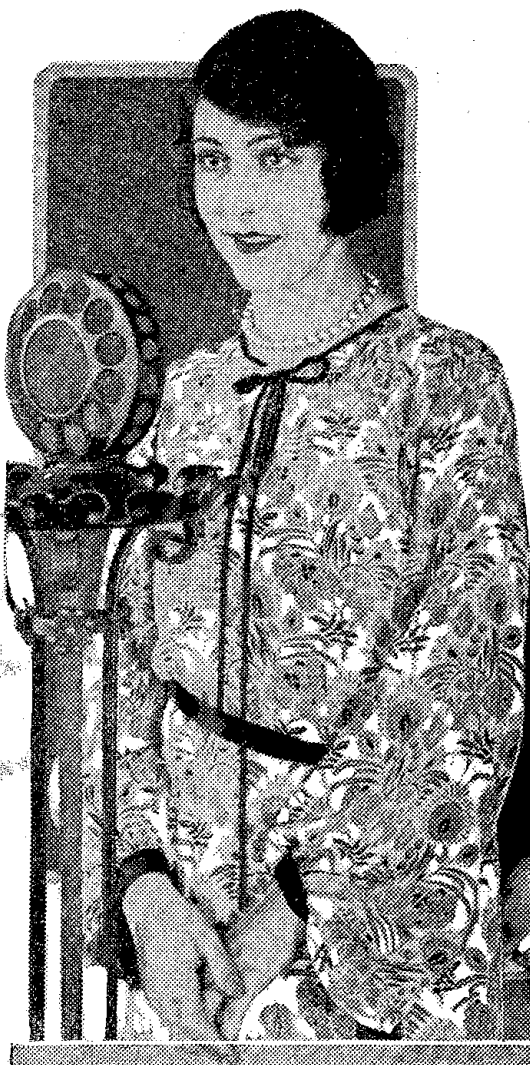

New Tickets, Children, for Woodshed Show



FORD AND GLENN, the lullaby boys of Station WLS, Chicago, have moved into their new woodshed at the Hotel Sherman. That means all the thousands of boys and girls who attend the woodshed show at the Radio lullaby hour will have to buy new tickets. The old tickets are no good in the new woodshed.

So you had better ask daddy or mother or whoever is reading this to you to send WLS two pins for a new ticket right away so you can hold it up in front of the Radio and enjoy the whole show.

If you never did see Ford and Glenn here they are just as they look when they put on the woodshed show, in their clown suits and with the pins that the boys and girls have sent them for tickets from all over the country.

The one up there on this side (we are pointing to the left) is Ford. His last name is Rush. Maybe you didn't know that. That is a pin he is holding. Say, wouldn't you hate to get stuck with a pin like that? It is thirty-six inches long and was sent to admit all the members of the Kenosha club of Kenosha, Wis.

(Continued on page 8)

Classics Relayed by WEA F Charm Millions

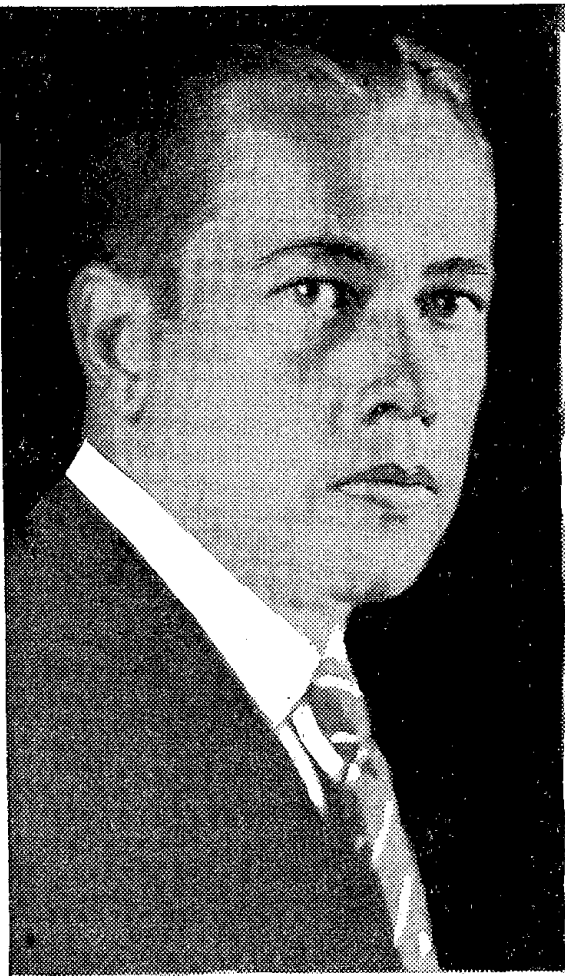

Cheer and sunshine are coming through the air these sad autumnal Sundays because of this galaxy of opera and concert stars who sing and play through WEA F and eleven other stations. Reinald Werrenrath (left), baritone. Toscha Seidel (below) and Mme. Louise Homer, contralto.



Salvatore de Stefano, whose glorious harp is known to both hemispheres and Mary Lewis (below) of the Opera Comique of Paris, also of Monte Carlo.

AUTUMN days with rain and bluster, inviting the Radio fan to stay inside and try out the dials, have brought to the friends of a dozen stations scattered through the East and Middle West a program of unusual charm.

It emanates originally from WEA F, New York, and from there is relayed through a chain that caters particularly to the programs of class and refined music.

The program is broadcast from New York each Sunday night from 9:15 to 10:15 eastern time and is known as the "Atwater Kent Radio Hour."

Among the list of artistic personnel are those whose faces are seen on this page and who already have been heard in this unusual feature. For many thousands the great baritone voice of Reinald Werrenrath was a revelation. Toscha Seidel is world renowned for his sympathetic understanding of the violin. He has played before millions and, yet, it is doubtful if ever before he had been heard before as large an audience as was his when he stood before the WEA F microphone in this unusual series.

Then we had Mme. Louise Homer, the famous mezzo-soprano and contralto of the Chicago Civic opera and Salvatore de Stefano, whose golden harp transmits its charm so eloquently through the air. Others who are equally notable are May Peterson of the Metropolitan Opera; Mme. Olga Samaroff, celebrated pianist; Paul Kochanski, Russian violinist; John Powell, distinguished American pianist and composer; Eva Gauthier, announced as "the high priestess of modern song," and dainty Mary Lewis, straight from the Opera Comique of Paris and famed for her personal charm as a former Ziegfeld beauty.

The stations through which these concerts may be heard are: WEA F, New York; WEEL, Boston; WGR, Buffalo; WCAE, Pittsburgh; WCAP, Washington; WJAR, Providence; WTAG, Worcester; KSD, St. Louis; WCCO, Minneapolis; WOC, Davenport; WSAI, Cincinnati. WOO, Philadelphia, has alternate Sundays with WFL.



Olga Samaroff (above), called "America's greatest pianist." Right, is May Peterson, Metropolitan star and American born.



Paul Kochanski bringing the violin art of the old Russian regime.



Eva Gauthier, "the High Priestess of Modern Song," and John Powell, well-known American pianist, composer and concert artist.



STATION WIBO HUNTS DX AND TELLS FANS

"RADIO SCOUTS" REPORT ON DISTANCE PROGRAMS

First Station to Tell Audience How to Tune Them Out and Get Other Plants

CHICAGO.—Much of the pioneering in American civilization has been forwarded by the work of scouts of various kinds. In the early days the Colonial Scouts pushed over the eastern mountains and helped settle the Ohio and Mississippi valleys. Later on came the Western scouts who assisted in the conquest of the West. The Indian scouts furthered this work afterwards by their loyalty to the newcomers. The famous military organization that did much to bring order out of chaos in the far distant islands of the Pacific, the Philippine scouts, has made its mark in American history. And now with all these wonderful precedents set by scouts, WIBO comes forth with a new group known as "DX Radio Scouts."

This is the name given four employees of Radio Station WIBO who search the air for "distance" stations and programs from far-off microphones. At regular intervals they will report general Radio conditions at that particular time. The four Radio scout's reports are telephoned to Station WIBO, compared, and then the announcer will give the report immediately to his listeners.

Will Help DX Hounds

For instance, WIBO will interrupt its own program to inform its listeners that KHJ in Los Angeles can be heard very distinctly at that moment at a certain wave length; or it may be Havana which is being received particularly well.

Dan Russo, one of the owners of WIBO (and for all his scant 24 years of youthfulness), a Radio veteran whose melodies have been sent across the country for years from WEBH where he maintains, with Ted Florito, the Edgewater Beach hotel Oriole orchestra, has inaugurated this new service from WIBO.

Four Laboratories Assist

"Thousands of Radio owners in Chicago and vicinity have the idea that they cannot get distant stations on account of the large number of local stations that broadcast simultaneously," says Russo. "They grow weary of the delicate tuning necessary to find far-off programs even if they have Radio sets capable of tuning out different local broadcasting. We have set up four laboratories in different parts of the city, placing experts in each, equipped with standard Radio sets such as the larger companies supply to the public in large quantities. These experts do the work for our listeners. They hunt out distant stations and telephone headquarters where and how the reception is best. We announce this instantly.

"We believe that WIBO is the first station to ask its listeners to tune it out and turn to some other station, but we believe it is a service that is wanted by our patrons. Listeners know that they can get us any time and these distant stations less frequently, and according to indications they appreciate our innovation."

Michigan State Radio College Course Opens

Five Day Schedule Is All Inclusive in Educational Scope

EAST LANSING.—The Radio school of the Michigan State college opened November 2 and will continue until December 19. Three lectures on varied topics will be broadcast each evening from the college station, WKAR. Starting promptly at 7:15 o'clock eastern time, the lectures last until 8 o'clock.

Monday evenings of each week will be turned over to the English, history and sociology departments. Members of the faculty in these departments will lecture on their particular subjects. The departments chosen to handle Tuesday evening programs are marketing, zoology or geology and soils.

Wednesday evening programs will be conducted by the agricultural engineering, entomology and forestry departments. Each Thursday evening will be devoted to lectures in marketing, botany and soils. The last of the five days to be used for purposes of the school will be in charge of the agricultural engineering, English and forestry departments.

Rome Gets 12 Kw. Plant

LONDON.—The Marconi company has received an order to erect a broadcasting station of high power in Rome for the Italian government. As soon as the new station, which of 12 kw., is in operation, the present 6 kw. station will probably be removed to Naples.

NO IDLE HOURS FOR WJAG SHUT-IN SETS

NORFOLK, Neb.—When a shut-in, who was furnished a Radio set through the efforts of Radio-telephone WJAG, here, died recently, the receiver was turned back to the station and was immediately put in the hands of another unfortunate. The World's series broadcast netted some \$300 in dimes and pennies, which makes a total of about \$2,000 gathered through Karl Stefan's microphone appeals. Nearly sixty people have had their dreary hours cheered by these sets from the WJAG fund.

"HOME, SWEET HOME" SOUNDS FINE IN JAIL

DENVER.—From the Jefferson county jail in Colorado more than a dozen prisoners, ranging from speed demons to bootleggers, have written a mutual letter to KOA here, to say that "Home, Sweet Home" over Radio never sounded sweeter than from behind the bars. "Yes, sir; that number which Marjorie Nash played this noon during the Rialto theater organ recital sure made us think of home and mother. When they turn us out, we're going to pay KOA a visit," the prisoners wrote.

FROM THE "SHOW ME" STATE

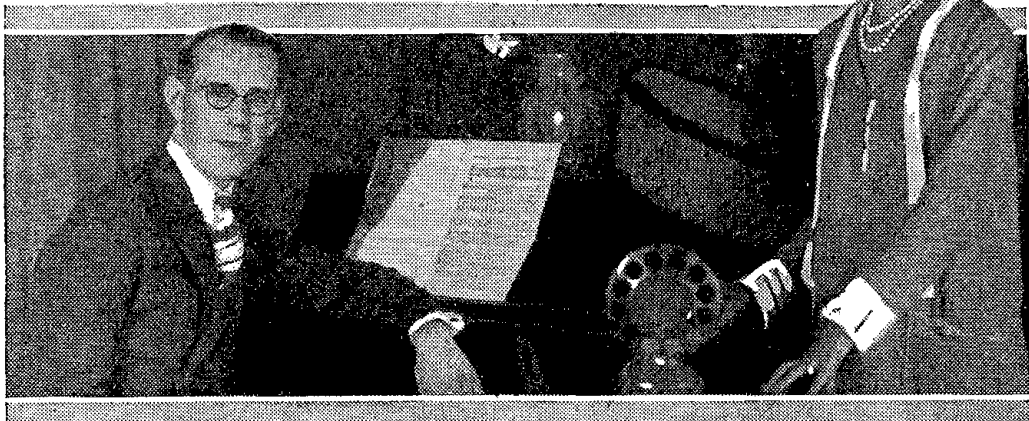

HELEN G. HATFIELD, announcer and program director of Station WSBF, of Stix, Baer & Fuller department store in St. Louis, Mo., is pictured at the top of the above illustration alone, and at the bottom she is shown at the microphone with "Vin" James, the McGraw broadcasting pianist, one of the station's biggest features.

Miss Hatfield is one of the few women announcers who have really made good in Radio. Perhaps her success can be accounted for by the fact that she started in Radio back when the little five-watt that first used the WSBF call was considered some broadcaster. She has grown up with Radio and in doing so has become part of Radio itself.

Miss Hatfield tells us she has brown eyes and short brown curls. Her many friends say she is much more animated than she appears, to be in these photographs. And she would have to be animated to be as versatile as she is. Besides putting all of WSBF's programs on the air she fills in announcing such sports as baseball, football and even prize fights.

Before the lure of the microphone reached out for Miss Hatfield, she was a student at the University of Illinois, preparing to become a domestic science teacher. Now in one little talk at the microphone she teaches a class larger than would have been the combined classes she would have taught in a lifetime of classroom work.

World's Most Noted Rabbi to Talk from Station WBZ

BOSTON.—The third broadcast from Ford Hall Forum of Boston by Westinghouse Station WBZ will present Dr. Stephen S. Wise, the most famous rabbi in the world today, in an address on "The Tragedy of American Self-Isolation," Sunday evening, November 15.

In last year's broadcast from Ford Hall Forum, Dr. Wise created a sensation by his address on the Ku Klux Klan. He has just returned from a long visit to Europe and has seen the League of Nations at work, so that his address will be replete with important information.

NEW YORKERS WANT STRIKE FOR SILENCE

MANHATTAN FANS TRY FOR BOYCOTT ON STATIONS

Have Hard Fight in Field Where There Has Never Been Silent Night Agreement

NEW YORK.—And now this city is going through a strike for a silent night such as was recently conducted in Chicago by the Broadcast Listeners association of America. Not much headway has been gained at present by those in the walkout due to the fact that there has never been a silent night in this area and thus the strikers have no definite grounds upon which to base their arguments.

There are sixteen stations in the New York area, four of which already observe a silent night. However, of these four not more than two are silent consistently on the same night. WGBS is silent on Fridays, WAHG is silent Tuesday, Thursday and Saturday. WHN remains off the air Saturday and WBJ duplicates the silence of WAHG. The other stations which are on the air every night are: WFBH, WJZ, WEAJ, WNYC, WMCA, WGCP, WLWL, WRNY, WOR, WAAM, WHAP and WOKO.

BLA Is Cooperating

According to Frank H. McDonald, president of the Broadcast Listeners association, which is cooperating with the New York fans, all of the four stations listed above as being silent on some nights, prefer Saturday as the permanent silent night with the exception of WGBS. The National Association of Broadcasters has been asked to cooperate and it is understood from one of the member stations that Saturday is the favored night for silence.

However, according to Mr. McDonald, the listeners want Friday for their DX seeking evening. They are attempting to line up the retail dealers, and those of that group who are sympathetic are also said to be in favor of Friday.

Issue Strike Cards Soon

The Citizens Radio committee, the local organization in charge of the boycott, has communicated with all the stations and is awaiting their replies and possible cooperation. To date the committee reports that Stations WEAJ and WJZ are ignoring the proposition. Strike cards similar to those used as weapons in the Chicago strike, whereon, the strikers sign pledges not to listen to offending stations at any time, are being prepared and sent all over the area by the citizens committee. Extra cards will be forwarded to the Chicago association for their cooperative use.

The Broadcast Listeners association is already in receipt of letters from many centers, where the fans promise their support to the New York fans.

During the Chicago fracas, which really terminated by the stations going back to their old schedules at the end of the summer period as they had promised to do before the strike started, Mr. McDonald claimed the support of 27 states. In the New York strike, he says the same 27 will be lined up to assist the listeners in Manhattan.

One Man Directs Nine Sings Over One Radio

Eight Communities Join Concert Directed from KNX Mike

LOS ANGELES.—An unusual feat was accomplished by the park board of the City of Los Angeles in conjunction with Station KNX when community singing was held in nine city parks on a recent Sunday afternoon. The directing was all done by one man.

The parks of Los Angeles are equipped with receivers and public address systems, and an input panel is centrally located at one of the parks where entertainment is regularly broadcast, by being sent to KNX via telephone wire, thence picked up by the receivers located in the various parks.

Hugo Kirckhofer, nationally-known community sing leader, was stationed at the microphone in Westlake Park and led the singing in the other eight parks by Radio. A small band of trained singers were in each park to form a nucleus for the general community sing. The singing went on in each park just as though Mr. Kirckhofer was there in person.

Identifying "Jean Campbell"

SAN FRANCISCO.—Radio listeners who have wondered about the identity of "Jean Campbell," frequently heard as accompanist on KPO programs, are notified that she is Mrs. Frederick Crowe, hostess and program director of the station.

A Junket to the Mexico City Studios of CYL



Sr. Paul Azcarraga (left) owner and director of the CYL, El Universal. George Marron, announcer (above). Ever hear that Spanish three-barreled flute of Sr. Azcarraga?

By Susan Haymes

WHEN one dials CYL of "El Universal" and "La Casa del Radio" (The House of Radio), Mexico City, Mexico, a thrill is experienced akin to that of visiting on foreign shores; one feels, too, a keen desire for becoming better acquainted with the station that sheer nerve built on the other side of the silvery Rio Grande.

For it was in November, 1923, that CYL went on the air as the first broadcaster in Mexico with its initial concert; this, despite a law prohibiting Radio broadcasting and reception except for governmental purposes, on account of the revolution in Mexico. Later on, ironical as it may appear, General Calles himself made his campaign for the presidency of the Republic, via CYL.

Incidentally, the voice of Calles has a rare and extraordinary quality in it; a depth and cadence that

can only belong to a powerful man. The part CYL played in carrying to the people the voice of this man, his subsequent election and eminently successful reign is too well known for further elaboration on these pages.

This station was the idea of the late President Porfirio Diaz. It was designed by Raul Azcarraga, who owns and directs the station, and was built by Sandal Hodges. George Marron is the gracious and popular announcer. The cost to the Mexican government was eight million pesos. That's something else for you to consult your banker about; ascertain just how many good American eagles that represents.

CYL is ideally situated from the standpoint of transmission, in the center of the city, facing the Garage Alameda, directly in front of the famed National theater. Wonderful records have been obtained from points in North America, Central America and South America. During the trans-continental tests, this was the only station that reached

President Calles (above, center) campaigned over CYL. Sr. Azcarraga locating station on map. Below is the famous old cathedral organ, described by Mrs. Haymes; left, Sr. George Marron.

S. A. Hodges (right), installed this Mexico City broadcasting station in 1923 when revolutionary disturbances made public broadcasting illegal. The station idea originated with the late President Diaz.

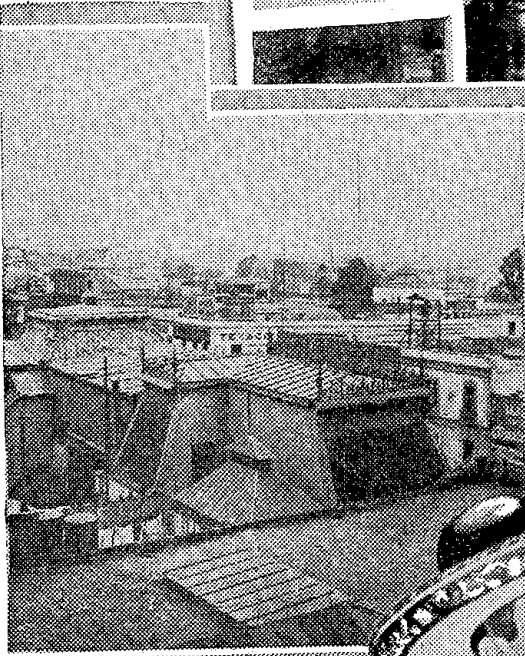
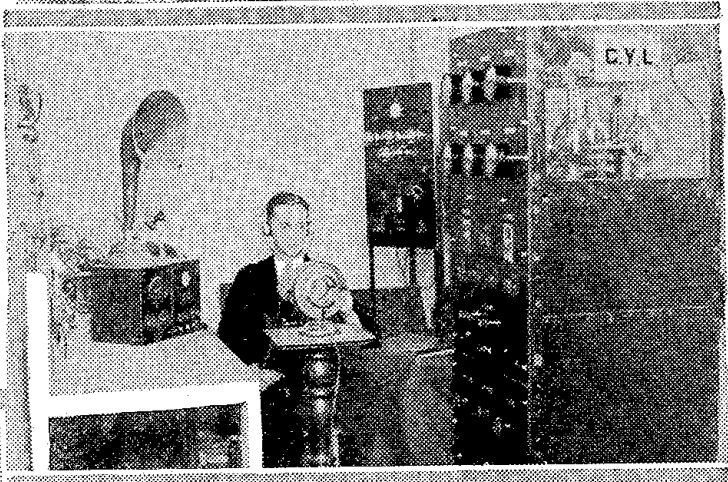

CYL antenna, whence come those Tuesday and Friday Mexican concerts in Spanish.

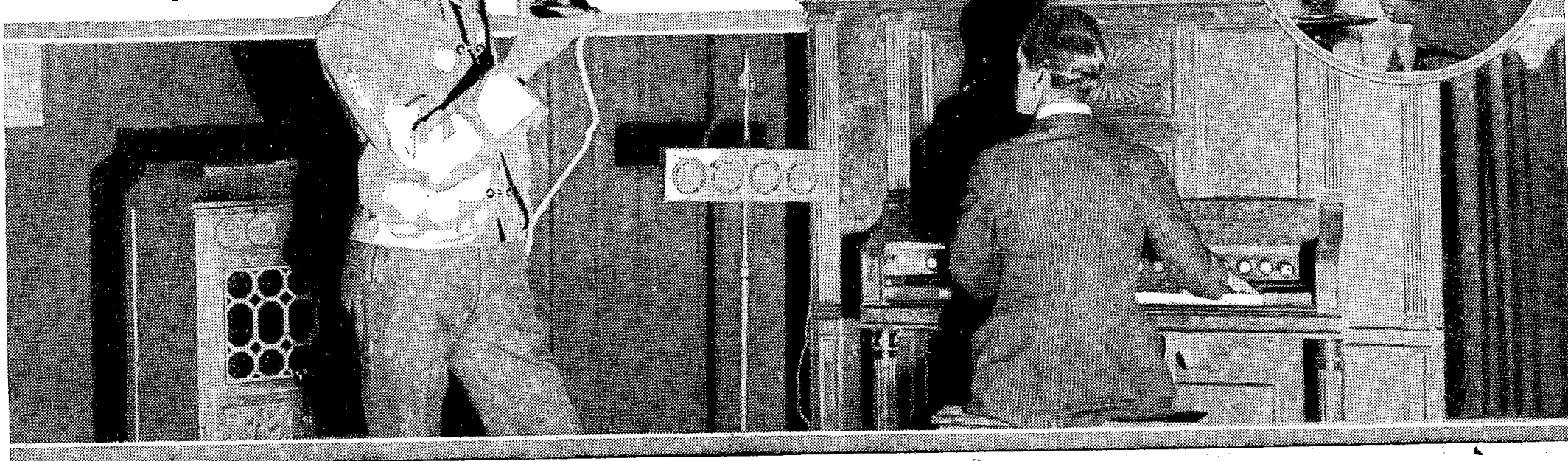
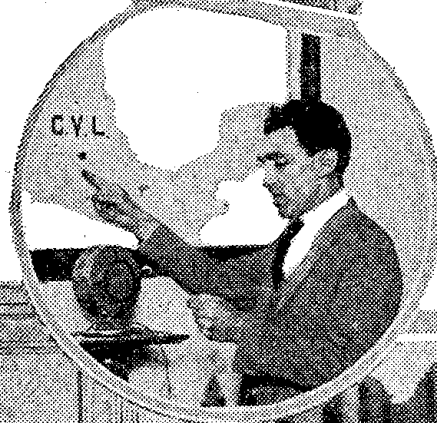
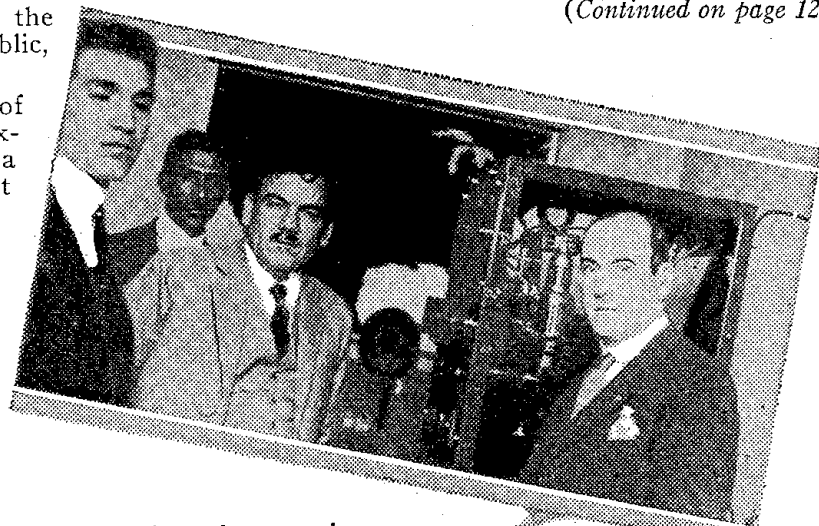

Buenos Aires, London and the Berring Strait. High altitude, clarity of atmosphere, the unusually fine antenna system and standard 500-watt equipment are attributes to its success.

Acoustically perfect, the studio is artistically draped in heavy folds of rich red silk; with the dim lights of decorative floor lamps and antique candelabra, a most alluring roseate hue is lent to the surroundings. Both a piano and an organ are in evidence. Quite an interesting history is woven around this beautiful handmade organ.

The organ originally belonged to the magnificent old church, Basil de Guadalupe; this mecca of tourists and haven of worshippers was established by the Spaniards over a century ago. But queer things happened to churches back in the fourteen stormy years of revolution and destruction, and this hand-carved, seventy-five year old instrument, with its unique engraved marquetry of solid ebony, passed eventually into the hands of CYL. Its tone is as rich as of old, yet one idly fingers its yellowed keys with mingled emotions and thoughts of God, of love, of human sacrifices, and of man's inhumanity to man.

The programs over CYL are varied and recipients of much praise. The Cathedral of Mexico sends a priest each Sunday at 10:30 a. m. to conduct very impressive church

(Continued on page 12)

"MAGIC RUG" KEEPS SPEAKERS IN PLACE

KOATECHNICIANS PREVENT ROAMING ABOUT STAGE

Use Psychology Rather Than Mechanical Means to Improve Broadcasts of Lectures

BROADCASTING officials have concocted psychological remedies which are guaranteed to glue public speakers before the microphone during an address and otherwise cure pernicious pacing and wandering about the lecture platform.

Credit for this unique discovery—called "the magic rug remedy"—goes to technical staff members at KOA, Denver broadcasting station of the General Electric company. First announcement of the cure was made recently following a ten month trial involving the worst offenders among national and western speakers who have appeared before Radio listeners.

Placed Before Microphone

"Not once has our magic device failed to turn the trick," asserted Alfred Thomas, resident engineer in charge of technical operations. "Most any type of rug fills the bill if it is soft and of contrasting color with the floor. It should, however, be of small dimensions, say three or four feet. It is placed a few feet from the microphone, the distance depending wholly upon the voice of the person to be heard.

"Unconsciously, the speaker assumes a position on this rug before the microphone and there remains until his remarks are concluded. Subconsciously, he regards this piece of floor-covering, with its imaginary boundaries, as an island of safety and is disinclined to venture elsewhere about the stage. As a result, broadcast listeners are enabled to hear the talk in full. Otherwise, some of the speaker's comments would be lost to the invisible audience."

Ministers Best Behaved

Ministers, it was pointed out, are the best behaved before the microphone, while political speakers are the worst.

"KOA's plan to prevent a speaker from taking gymnastic exercises on the lecture platform is indeed novel," declared Dr. D. E. Phillips, eminent psychologist of the University of Denver.

"The small rug upon which he stands gives him the unconscious or dimly conscious suggestion that it was intended for that specific purpose. As he proceeds with the talk, any tendency to step off likewise gives an unconscious warning.

"The opposite is also true—a wide open platform gives a stimulus to parade about."

The Finnish amateur Radio operators have decided to adopt the call letters SZ as a prefix for all private stations in Finland.

RADIO BABY WINS FIRST PRIZE

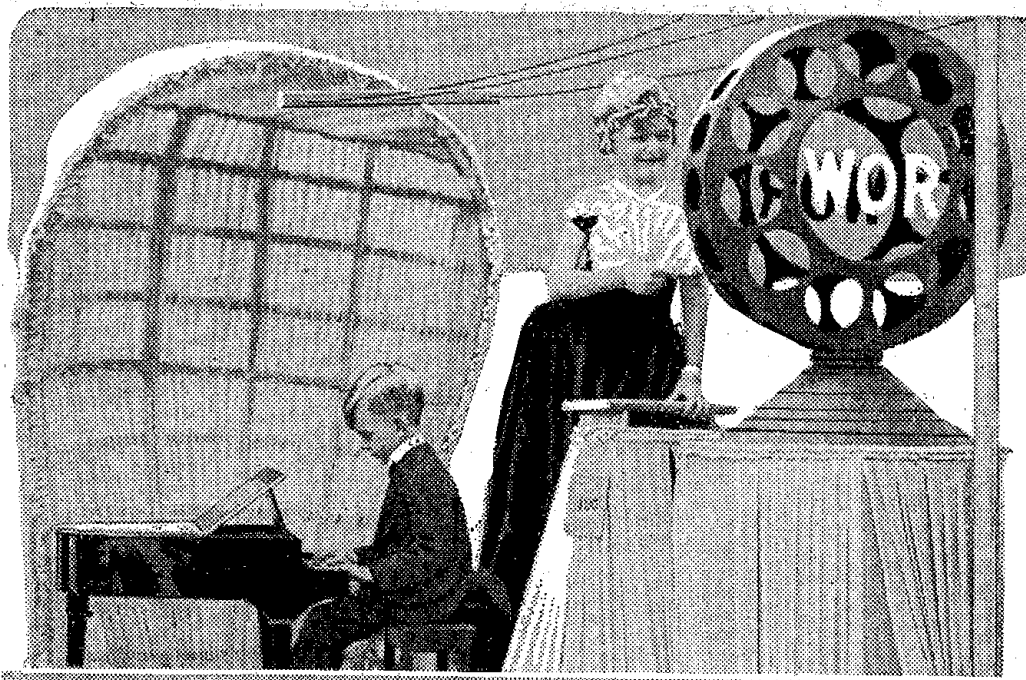

Six-year-old Janice Elgin of New York represented WOR Radiophone station in the recent Asbury Park Baby parade and when the judges' votes were counted it was found that the Radio Baby and her float representing the broadcasting studio had won first prize. Blue-eyed and with golden hair, Janice appeared radiant and beautiful, attired in a gown of black velvet after the style of a grand opera prima donna. Her accompanist was five-year-old Richard Jack.

Now Coast Station Radio Announcers Has Welcome Song Elect 'Governors'

Charles Wellman of KFWB, Writes and Sings Greetings for Opening Studio Each Night

HOLLYWOOD, Calif.—Not content with using a good night song, such as first sung by Jack Nelson of WJJD, and later by Jerry Sullivan of WQJ, Charlie Wellman, announcer and studio manager of Warner Brothers movie station, KFWB, has inaugurated a new way of opening his programs.

The evening programs at KFWB open with news items given from a newspaper by remote control. At their conclusion a signal is flashed to the main studio, the microphone thrown on and Charlie begins to sing his welcome song. The words run as follows:

If you want to hear a station,
Don't go 'way, folks; don't go 'way;
Just turn your dials and wait awhile,
We'll be on the air to stay.
We will try to make you happy
From Hollywood to Tennessee
From Warner Brothers' studio,
K-F-W-B.

The innovation, for it is a new thing on the Pacific Coast, has been greeted by many fan letters of commendation.

THE "LULLABY BOYS"

(Continued from page 5)

Now the other funny man is Glenn and HIS last name is Rowell. They sometimes call him "Little Glenn" but he isn't as little as he used to be and that's because he has grown up, of course. They call him "little" because he is not as tall as Ford but he is just as nice—we think.

They are Sears Roebuck's boys and you know who he is, certainly.

When they began asking the boys and girls to buy tickets to the mythical woodshed theater they didn't say what kind of pins they wanted to pay for the tickets so they received all kinds of pins, clothes pins, safety-first pins and just plain every day stick-in-your-skin pins. You can see some of them in the picture.

The Marcasco Players, an employe's organization of the Maryland Casualty company, recently gave a Radio party which was broadcast by WCAO. Programs, under the direction of A. B. Wilkie are given before the same microphone monthly under the title of "The Marcasco Book of Music." At the party a set on the stage represented a huge receiver. When Isabelle Fincher (left) and Mildred Adams (right) turned the dials, the set opened and showed the audience the company in the studio just as they are below.

CHICAGO SHOW WILL BE RADIO'S BIGGEST

WILL ECLIPSE ALL OTHERS IN SIZE AND CONTENT

Coliseum Not Large Enough for All Who Wish to Exhibit; Two Additions Made

The greatest Radio exposition in the history of the industry will be thrown open to the trade and the public when the fourth annual Chicago Radio Show opens in the Coliseum on November 17, and continues over November 22. It is certain to eclipse all other shows both in number and excellence of exhibits. It is the official show of the Radio Manufacturers' Association and as such will draw dealers and jobbers from all over the Middle West and even from as far as the Pacific Coast.

Many of the larger manufacturers have been busy improving their models of the earlier season, and these improvements will be shown for the first time at the Chicago show.

Overflow Causes Expansion.

The tremendous demand for space has made it necessary for U. J. Herrmann and G. Clayton Irwin, Jr., the directors of the show, to use not only the Coliseum, but the north hall and the annex. In addition to this, it has been found necessary to use the balcony of the main building for many of the exhibits.

"With this show it was not a matter of disposing of the space," said Mr. Irwin, "but a question of being able to take care of all the exhibitors who wanted to take part in the show."

Also, it is announced that for 1926 the management has secured an earlier date at the Coliseum and will stage the exposition early in October.

Entirely new equipment will be used in the coming show. The booths will be arranged differently from last year and will be much more attractive.

Exhibits Are Attractive.

"The manufacturers have also learned the necessity of putting in real exhibits," said Herbert H. Frost, president of the Radio Manufacturers' Association and chairman of its show committee. "In the earlier shows many of the exhibits were no more attractive than those which can be seen in any good Radio retailer's store. The manufacturer now realizes that he must show something really distinctive if he is to please the public and the result will be demonstrated during the Chicago show."

All jobbers and dealers who are planning to attend the show are requested to write to the Chicago Radio Show, 127 North Dearborn street, so that proper credentials can be furnished to them.

Send Market Reports to Fans

NEW YORK.—The market reports printed by the United States department of agriculture and broadcast from WEAJ each noon, will be sent to anyone on application without charge by the U. S. Department of Agriculture, 97 Warren street, New York city. Market reports printed and distributed by the New York State Department of Farms and Markets, also heard through WEAJ, will be sent to residents of New York state for the cost of printing and mailing upon application to the New York state department of farms and markets, 53 Park place, New York city.



GIANT SIKORSKY PLANE ENABLES RADIO FANS TO HEAR THE "STARS"

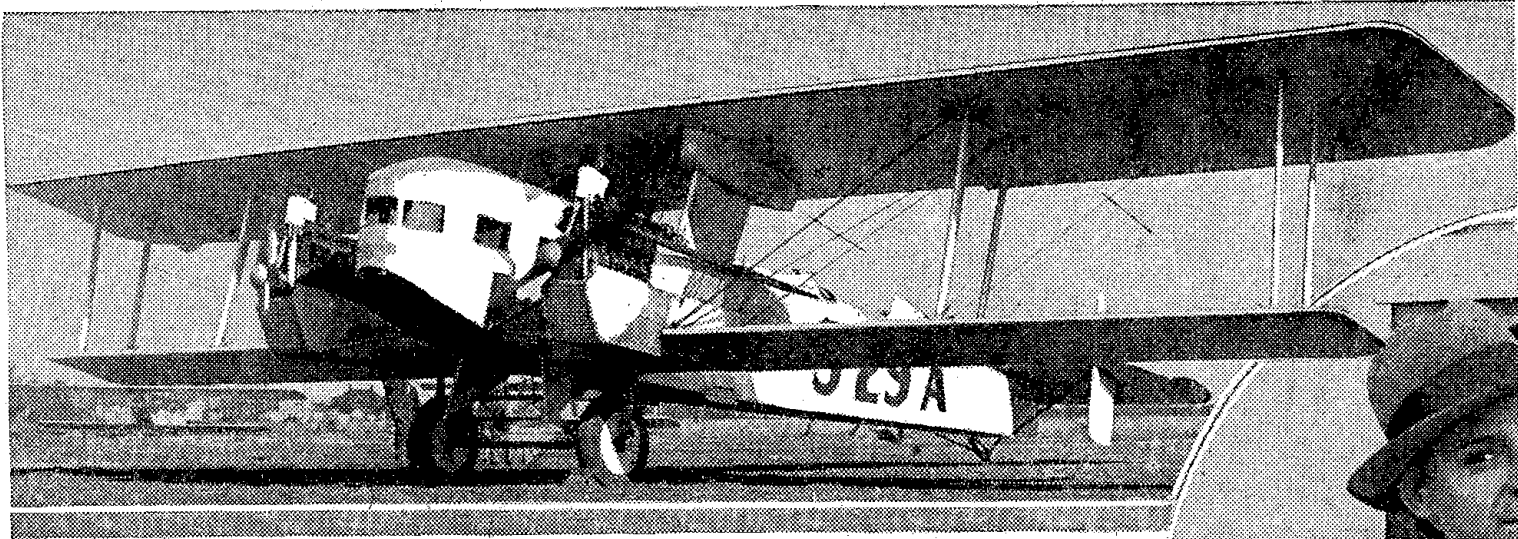

Eastern listeners were enabled to hear two stars singing in the skies, recently when Helen Ford and Charles Purcell, below, of the "Dearest Enemy" musical comedy company, broadcast from the giant Sikorsky air transport, (left), while enroute to open the big air meet at Hartford, Conn.



KIDDIE'S THEATER IS INNOVATION AT WOR

CLARE TREE MAJOR PRESENTS CHILD'S PLAYS

Woman Producer Has Had Long and Successful Experience in Juvenile Stage Workings

Radio fans are familiar with the work of various stations in broadcasting plays for adult Radio audiences. Heretofore no attempts have been made to broadcast plays especially for children from eastern stations until WOR evolved the idea of starting a Children's Radio theater. Station WLS, Chicago, has presented plays in its Woodshed theater during the past year.

The WOR feature which went on the air on Wednesday, November 4 at 2:45 p. m., was presented by members of the cast of the Children's Saturday Morning theater, a professional company which began a season on October 31 at the Princess theater with "The Golden Apple," by Lady Gregory.

"The Three Wishes" First

The Children's Radio theater chose as its first production a one-act fairy play called "The Three Wishes." Clare Tree Major, who is the director of the Children's Saturday Morning theater, also directed this playlet. Mrs. Major is well known for her activities in the cause of good plays for children. Three years ago she began at the Lexington theater a series of Saturday matinees of "Cinderella" for children. They proved so successful that an entire year of children's plays followed. The second year, the Children's Saturday theater gave its performances in the Heckscher theater.

Six Plays Scheduled

In 1924 Mrs. Major moved her headquarters to the Princess theater, where, owing to the necessity of devoting Saturday afternoons to the professional matinees of productions housed there, the children's performances had to be temporarily discontinued. This year, however, an entire season of six plays will be given, including besides "The Golden Apple," such classics as "Alice in Wonderland," "Hansel and Gretel," and "The Magic Mirror," a dramatization of "Snow White" and the "Seven Little Dwarfs."

Wherever possible, Radio adaptations of these plays will be made, and scenes of the children's play then being broadcast will be given to the Radio audience of children. When the story of the play depends too much upon pantomime, scenery and properties to make this adaptation possible, the Radio adapter of the Children's Radio theater will draw upon the vast field of folk-tales and fairy-stories for the younger members of the WOR Radio audience.

Pan-American Union Starts Series of WRC Programs

WASHINGTON.—The first of a series of Pan-American programs, to be broadcast here by Station WRC and WJZ in New York this fall and winter, will be presented October 1, under the auspices of the Pan-American Union.

The speakers for the first of these performances will be General James G. Harbord, president of the Radio Corporation of America, and Dr. Leo S. Rowe, director-general of the Pan-American Union. An elaborate musical program has been arranged to inaugurate the new series of Latin-American nights, which will be featured by music of the United States Army band, directed by Captain William J. Stannard; a double saxophone sextet of the army band, and a group of Washington's most prominent vocal and instrumental soloists.

New Stations

Amid the ghostly static of Halloween, KHQ, the new 1000-watt station of Spokane, Washington, was launched on the air. The Inland Empire Broadcasting association is in charge of the new venture KHQ was formerly of less power and located at Seattle.

KQP, Portland, Oregon, has increased in power from 100 to 500 watts. H. B. Read is the owner of the station.

Two new broadcasters were licensed last week—KFYF, Oxnard, Calif., 10 watts, 205.4 meters, and WMBC, Detroit, Mich., 100 watts, 256 meters.

WHK, Cleveland, Ohio, has changed owners. The Radio Air Service corporation now operates this station, working on 273 meters with 250 watts.

Three stations announce an increase of power. WKAF, Milwaukee, is now a 500-watt broadcaster. KOCH, Omaha, uses 250 watts. WBRE is listed as 100 watts.

KFOB is the new call of the Burlingame, Calif., Chamber of Commerce station.

WLS, Chicago, former home of George Hay, is now a superpower station, having dedicated its new 5,000-watt set with a formal opening on Halloween.

November 1 saw the advent of one of the largest broadcasters in the South, erected at Boca Raton, Fla., by the Mizner Development corporation. The station has a power of 1,000 to 2,500 watts and the call WFLA.

New Device Gives Operator Chance When SOS Goes Out

LONDON, Eng.—Designed to give the Radio operator of a ship a chance of life with the rest of the crew if the vessel should sink, a new British SOS sending device gives automatically the ship's call sign, the latitude and longitude and the distress signal. The machine will continue sending out the call until the ship sinks. No operator is needed.

SETS 2,000-MILE AS DAY RADIO MARK

KYW Reaches Listeners in Seattle During Broadcast of High Noon Program

CHICAGO.—Westinghouse Station KYW established what is believed to be the record daylight Radio reception, when Summer Osborne of Seattle, Washington, wired a detailed description of KYW's noonday broadcast.

This broadcast takes place each day from 1 to 2 p. m., which is 11:00 a. m. to 12 noon Pacific standard time, and on that day Coon & Sanders Nighthawks were percolating band music onto the ether and now comes a telegram from Seattle, telling of how Summer Osborne heard KYW.

This is a distance of approximately 2,000 miles, which for night time reception is only ordinary, but for high noon broadcast, it established somewhat of a record.

Station WCAU, Philadelphia, has started a series of stage dancing lessons. Al White, who taught Anne Pennington, Louise Brown and other stage stars, is giving these lessons every Wednesday.

NOTED ORGANISTS IN BIG MUSICAL SERIES

IMPORTANT INSTITUTIONS TO BE HEARD AT WAHG

Skinner Company Presents Musicians from Many Colleges and Universities in Great Artists Series

NEW YORK.—That Radio plays an important part in college and university life is indicated by the institutions which are linked together for the organ recitals to be presented by the Skinner Organ company through Station WAHG, Richmond Hill, N. Y., for thirty-six consecutive Friday nights, beginning last Friday, at 8 o'clock, eastern time.

George Rogers Pratt, organist of the University of Virginia, represents the far east, while Warren D. Allen, organist of the Leland Stanford university, California, is one of the contributing artists from the Golden West. Others include Walter Hartley of Pomona college, California; Allan Bacon, College of the Pacific at Stockton, California.

The tall corn country is represented by Marshall Bidwell of Coe college, Cedar Rapids, Iowa; the Mid West by Palmer Christian, organist of the University of Michigan at Ann Arbor.

Western New York brings Hugh Porter, organist of the Chautauqua Institution summer school; while central New York presents Harold Gleason of the Eastman school at Rochester. Western Pennsylvania will be represented by Charles Helmroth, organist of the Carnegie Institute, Pittsburgh.

Other interesting figures in the organ world, who will join in this Grebe series of "Great Artists" recitals, include Lynnwood Farnham, Canadian organist; Dr. T. Tertius Noble, president of the National Association of Organists; Albert W. Snow, organist of the Boston Symphony orchestra; Edwin Arthur Kraft, organist of the Trinity Cathedral, Cleveland; W. A. Goldsmith of St. Andrews, New York city; Maurice Garabrant of St. Thomas, New York city; Louis Potter of the Baptist Temple, Charleston, W. Va.; Gordon Balch Nevin of Johnstown, Pa.; Guy Filkins, former organist of the American Cathedral, Paris, and now of the Central Methodist Episcopal church of Detroit; Alexander McCurdy of Morristown, N. J.; Alfred Greenfield of the Fifth Church of Christ Scientist, New York city; Arnold Dann of the First Methodist Episcopal church, Pasadena, Calif.; Walter P. Zimmerman, organist of the Chicago Symphony orchestra; Herbert E. Hyde of St. Lukes, Evanston, Ill.; G. H. Federlein, First Church of Christ Scientist, Chicago; William Zeuch of Boston; Henry F. Seibert of Holy Trinity church, New York city; Edward Rechlin, the Bach Recitalists and Clarence Dickinson, composer-organist of the Brick Presbyterian church, Fifth avenue, New York city.

NEW MASK FOR MYSTERY SINGER



Although they could not see him, the audience of the WEAF "Silver Masked Tenor" objected to his old shabby mask, so they raised a fund and purchased a beautiful new, suitably engraved one. The mystery man is wearing it (left), and comparing it with the old one.

FOLLOWING SPORTS THROUGH MIKE

YALE-TIGER FIGHT ON SEVEN MIKES

WBZ Ties Up with Other Stations to Tell of Big Three Game

BOSTON.—The second "Big Three" contest, the Yale-Princeton game, will be broadcast direct from the Yale bowl at New Haven by Westinghouse station WBZ Saturday afternoon, November 14. In order to send out the play-by-play account of this battle, which ranks as one of the leading and most important classics on the eastern football schedule, WBZ will make use of its direct line connection with New York and will tie-in with Stations WJZ and WGY. Stations WCAP, WEA, WJAR and WTIC will also make the big event. With these seven stations, the most powerful broadcasting stations on the Atlantic coast, sending out a running description of the game, listeners interested in the destinies of the two college teams will be able to hear the broadcast regardless of the part of the country in which they may be located.

KFWB, MOVIE STATION

(Continued from page 6)

15 years experience in the amusement and theatrical world and has shown such a genius for gauging what the general public will do that whenever the movie industry in Hollywood decides to throw a big show or put on a big spectacle of any kind wherein all hands join forces to make it a big success as only Hollywood can, the cry goes up for Norman Manning.

After looking over a few text books on Radio he decided it was too complicated for him to pick up in a few days so he decided not to be troubled with the knowledge. After all, Radio is largely entertainment and the psychology and showmanship necessary to put Radio entertainment on the air is not essentially different from that of the stage, the circus and the fire department making a run. So, forgetting all about Radio as such, Norman Manning has made KFWB a center of entertainment and presents his entertainment much as he would on the stage, forgetting or not knowing a lot of things other stations do as a matter of custom and every once in a while sneaking up on other stations with a new idea that fairly knocks their eyes out. In the short time that KFWB has been on the air its audience has grown so that it can claim as great a one as any other station of its power in the West. And a great deal of the credit must be given to Mr. Norman Manning.

Smiling Charlie Wellman is the announcer at KFWB. Starting in three years ago as a singer at KYW, Chicago, later at KHJ with the Saturday afternoon frolics and Lost Angels programs he came to KFWB with considerable announcing experience and his snappy way of conducting a program and his "Don't go 'way, folks" are known throughout the country. Charlie is never very busy. During the morning and afternoon he holds audition periods at KFWB for new talent and at night announces the programs, ending up with the Warner Bros. frolic which he conducts. Between the end of the morning shave and before the ham and eggs he practices a few new songs and sometime, its hard to find when, he goes over to the Brunswick phonograph plant in Los Angeles and makes records of the latest popular songs.

At most of our stations giving children's programs the period is given over to some older person who reads the nursery rhymes and tells the bedtime stories. More often than not, their audience is not what they think it is being mostly adults who get a great kick out of the rhymes and stories of their old childhood days. Not so at KFWB. Big Brother of this station is a youngster. Ben McGlashan, The Big Brother, attends classes at the University of California and his hour for the kids, from 6 to 7 on Mondays, Tuesdays and Wednesdays, is different from any children's hour you ever listened to.

"What do the kids want over the Radio?" Ben asked himself. "They don't care for jazz or classical music, except when rendered on the harmonica; talks on golf, facial surgery, food hints and a hundred other subjects do not interest them. They tune out the bedtime stories put on for their benefit." And then the idea. Ben's little brother, like yours and mine, is always asking questions and he soaks up information like a sponge does water. Therefore, the children's hour at KFWB should answer questions put by the children themselves and that is exactly what is done and it is very successful. That might be of interest to other station managers.

You cannot enumerate the features that

Football Broadcasts

Saturday, November 14

- Colorado Aggies-U. of Colorado, KOA (322.4).
- Chicago-Dartmouth, WMAQ (477.5).
- Cincinnati-Ohio (Athens) WSAI (325.9).
- Holy Cross-Rutgers, WTAG (268).
- McGill-Varsity, CFCA (356).
- Michigan-Ohio State, WEAQ (293.9), WJR (517), WWJ (352.7).
- Minnesota-Iowa WCCO (416.4); WOC (483.6).
- N. M. State College-Junior College, KOB (348.6).
- Oklahoma-Missouri, WOS (440.9).
- Oregon Aggies-U. of Oregon, KGW (491.5).
- Pittsburgh-U. of Pennsylvania, KDKA (309.1).
- Princeton-Yale, WBZ (333.1), WCAP (468.5), WEA (491.5), WGY (379.5), WJAR (305.9), WJZ (454.3), WTIC (475.9).
- Purdue-Northwestern, KYW (535.4), WBBM (226).
- Texas A. & M. College-Rice Institute, KPRC (296.9).
- Washington-California, KFOA (454.3), KLX (508).

have appeared at KFWB. They are too many and they change too often. But this fall it is the intention of Warner Bros. to put on one stunt that we know will be popular. By simply running a few feet of wire out onto the production lot and hooking a microphone on the end of it KFWB will broadcast, exactly as it is done every day, the direction and taking of motion pictures. Then the "Lights! Camera! Action!" that opens up a KFWB program will be the real thing and the whole country will be able to actually hear the clicking of the camera, the director's voice as he instructs some famous star, and the playing of the emotional music that accompanies each scene.

Nor is that all. If present plans are carried to completion KFWB's power will be greatly increased and it is not unlikely that Warner Bros. will erect several more stations throughout the country and become one of our largest investors in Radio transmitters, with a national tie-up for special features. The least that will happen is that every new Warner Bros. theater, and there are several now under way, will broadcast through either their own or some other station.

Let us quote Jack Warner about Radio and pictures: "There are some who think that in attaching a Radio station to our picture studio, we are fighting our own interests and creating formidable opposition for ourselves. We believe the contrary to be the case and are confident we are increasing the number of our friends and patrons for the entertainment we nightly broadcast places us in more intimate contact with the public and increases the friendly feeling they have for Warner Bros. We are using Radio as it is today—not what it will be tomorrow, although I confidently expect that in time the Radio and the picture business must join forces permanently to produce a superior type of entertainment that will combine all the elements of the stage, the screen and Radio."

Education Week Will Be Observed by KGO

Coast Educators to Deliver Series of Tropical Talks

OAKLAND, Calif.—Radio as an aid to educational institutions will be exemplified throughout the nation during "American Education Week" from November 16 to 22. At KGO, General Electric Pacific Coast station, special educational programs, coordinated by the bureau of education with the national program, will be broadcast. Speakers prominent in educational circles will be heard.

During the regular KGO Monday evening educational program, November 16, Frederick M. Hunter, superintendent of the Oakland (Calif.) public schools, will speak. His subject will be "The Constitution, and Respect for Law." On the following evening, "Patriotism in Education" will be discussed by Dr. Aurelia Henry Reinhardt, president of Mills college, Oakland. Cora L. Williams, founder of the Williams Institute, Berkeley, and well known to KGO listeners for her many contributions to educational broadcasts, will speak on Wednesday afternoon, November 18, at 3:30 o'clock. And on Saturday evening, November 21, J. M. Gwinn, superintendent of schools, San Francisco, will talk on "A Sound Mind in a Sound Body."

Earn \$50 to \$200 a Week in RADIO

You can! Hundreds of ambitious men are already earning thousands of dollars in this wonderful new industry—you, too, can get your share. Mail coupon below for Free Book which describes fully the amazing money-making opportunities in Radio and tells you how YOU can earn from \$5,000 to over \$10,000 a year.

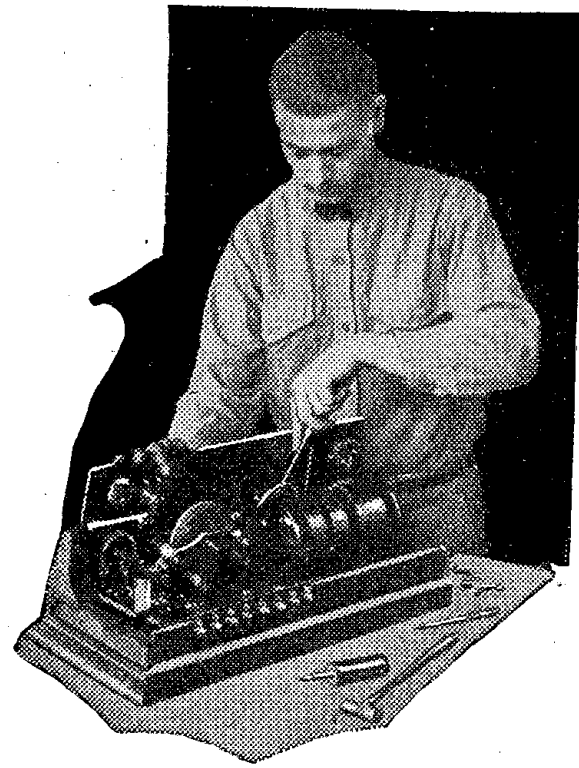

THE astounding growth of Radio has created thousands of big money opportunities. Millions of dollars were spent during the past year on Radio, and thousands of young men are needed right now to meet the ever-increasing demand of work.

Men are needed to build, sell and install Radio sets—to design, test, repair—as Radio engineers and executives—as operators at land stations and on ships traveling the world over—as operators at the hundreds of broadcasting stations. And these are just a few of the wonderful opportunities.

Easy to Learn Radio at Home in Spare Time

No matter if you know nothing about Radio now, you can quickly become a Radio Expert, by our marvelous new method of practical instruction—instruction which includes all the material for building the latest up-to-date Receiving Sets.

Scores of young men who have taken our course are already earning from \$75 to \$200 a week. Merle Wetzel of Chicago Heights, Ill., advanced from lineman to Radio Engineer, increasing his salary 100% even while taking our course! Emmet Welch, right after finishing his training, started earning \$300 a month and expenses. Another graduate is now an operator of a broadcasting station—PWX of Havana, Cuba—and earns \$250 a month. Still another graduate, only 16 years old, is averaging \$70 a week in a Radio store.

Wonderful Opportunities

Hardly a week goes by without our receiving urgent calls for our graduates. "We need the services of a competent Radio Engineer."

"We want men with executive ability in addition to Radio knowledge to become our local managers."

"We require the services of several resident demonstrators"—these are just a few small indications of the great variety of opportunities open to our graduates.

Take advantage of our practical training and the unusual conditions in Radio to step into a big paying position in this wonderful new field. Radio offers you more money than you probably ever dreamed possible—fascinating, easy work—a chance to travel and see the world if you care to, or to take any one of the many Radio positions all around you at home. And Radio offers you a glorious future!

The National Radio Institute is one of America's Pioneer Radio Schools—established in 1914. Our course is an absolutely complete one which qualifies for a government first-class commercial license. It trains you for bigger paying jobs in Radio.

Send for FREE RADIO BOOK

Learn more about this tremendous new field and its remarkable opportunities. Learn how you can quickly become a Radio Expert and make big money in Radio.

We have just prepared a new 48-page book which gives a thorough outline of the field of Radio—and describes our amazing, practical training in detail. This Free Book, "Rich Rewards in Radio," will be sent to you without the slightest obligation. Mail coupon for it now!

For a short time we are offering a reduced rate to those who enroll at once. Act promptly and save money.

Doubles Salary

I can very easily make double the amount of money now than before I enrolled with you. Your course has benefited me approximately \$3,000 over and above what I would have earned had I not taken it.

T. WINDER, Grand Junction, Colo.

From \$15 to \$80 a Week

Before I enrolled with you I was making \$15 a week on a farm. Now I earn from \$2,080 to \$4,420 a year, and the work is a hundred times easier than before. Since graduating a little over a year ago, I have earned almost \$4,000, and I believe the course will be worth at least \$100,000 to me.

(Signed) GEO. A. ADAMS, Tamaqua, Pa.

National Radio Institute, Dept. 55NB, Washington, D. C.

National Radio Institute, Dept. 55NB, Washington, D. C.

Please send me without the slightest obligation your Free Book, "Rich Rewards in Radio," and full details of your special Free Employment Service. Please write plainly.

NAME

ADDRESS

CITY STATE

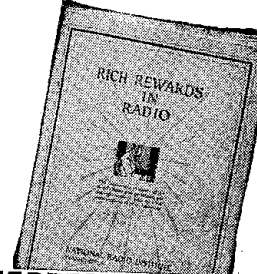

OPERATING AND TROUBLE SHOOTING

OPERATING and Trouble Shooting, is a Radio Digest feature the purpose of which is to give practical information on the operation, care and cure of simple troubles in every kind of receiver. Standard Radio receivers of wide distribution and use are studied from the standpoint of instructions for installing and connecting, tuning and operating, and remedying little difficulties. The suggestions below, if executed faithfully, will make winter broadcast listening yield all there is to yield to the reader and give your set a fair chance to show its worth.

For the Owner of an Atwater Kent Model 20

EXTENSIVE tests with this set showed that it could be used, with excellent results, on almost any type of antenna. Naturally, the best results are secured with a high outside wire since more energy reaches this type. The length over-all, including the lead-in and ground should, preferably, not exceed 100 to 150 feet. If one long straightaway wire is impossible and an aerial of two or more wires is used, the space between wires should be not less than 3 feet and greater separation would be to advantage.

Antenna and Ground

Between a loop antenna and an indoor wire, tryouts proved the indoor to be slightly better. A wire was strung straight down a hallway about 40 feet in length and 6 inches below the ceiling, at-

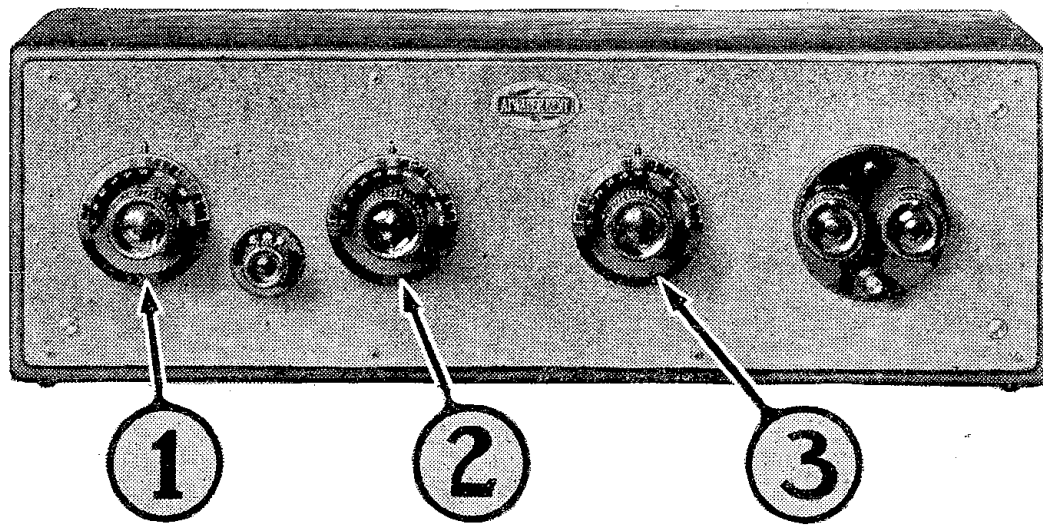

tached at each end to the top of a door frame with insulators. This worked very nearly as well as the outside wire. Since an antenna strung behind the picture moulding of two rooms was available this was also tried and, while the volume was not quite as great, the selectivity was increased to knife-like sharpness and the range differed not at all. Although it was not tried, there seems good reason to believe that an attic antenna would give even better results than the wire strung in the hall.

The ground, as usual, was made by scraping the water pipe and tightening a substantial ground clamp around the clean portion. In this case the connection was made in the basement near a window, the wire run out through a small hole in the basement window frame and up to the window through which the antenna lead from the outside wire was passed. Both wires are brought, in porcelain tubes, through a board under the sash.

Tubes and Batteries

Following the manufacturers' instructions, five "hard" tubes of the A type were used, instead of four A tubes and a soft detector. Although the set performed well on the first insertion of tubes, they were switched around while the set was left tuned to a station to ascertain whether any of them performed better as

Radio frequency amplifiers. Some improvement in both volume and clearness was perceptible when the first Radio frequency tube and the detector tube were exchanged. The battery is a 6-volt, 120 ampere hour unit and, while it may be used for several days and then recharged for several hours at a high rate, it has been found better practice to charge it a little each evening while at dinner to make up what was used the evening before. A charging rate of 2½ amperes for an hour seems to keep this one about right.

Model 20 was used on both storage and dry cell B batteries. Performance over a period of six weeks is apt to be more consistent with the former, but no difference could be noted during the two nights' test of this set, though the dry cell blocks were 10 per cent gone and the

storage cells freshly charged. When making connections to this receiver, or any other for that matter, make one complete connection from set to battery at a time, rather than making five connections to the batteries and then connecting all the loose wires to the set. Care should be observed when connecting the loud speaker that the cord with the red hthread interwoven in it is connected to the post marked "Red Tracer Lead."

Check all battery, antenna, ground and speaker connections once before putting in any tubes; then insert one in any socket and pull the filament switch out. Turn the rheostat over slowly and, if tube lights dimly it will be alright to insert the other four tubes. Turn both rheostats to right nearly to the maximum position, and one is ready to tune in stations.

Operation

It will be found that the second and third dials will always be at very nearly the same setting for any given stations, while the first dial will be at some point slightly above or below them, depending on the position of the tap switch. This switch is provided to adjust the set to any antenna with which it may be used. A few trials will show on which tap it should be set for maximum results, after which it can be left there. In the case of our tests it was found that tap number 2 worked slightly better than the others. First of all set dials 2 and 3 on, let us say, 56. Then swing dial 1 slowly from 40 to 70. If no program is heard, even faintly, shift dials 2 and 3 to 54 and again swing dial 1 through the short arc. After two or three shifts, a station will be heard

(Continued on page 12)

The AMSCO ALLOCATING CONDENSER

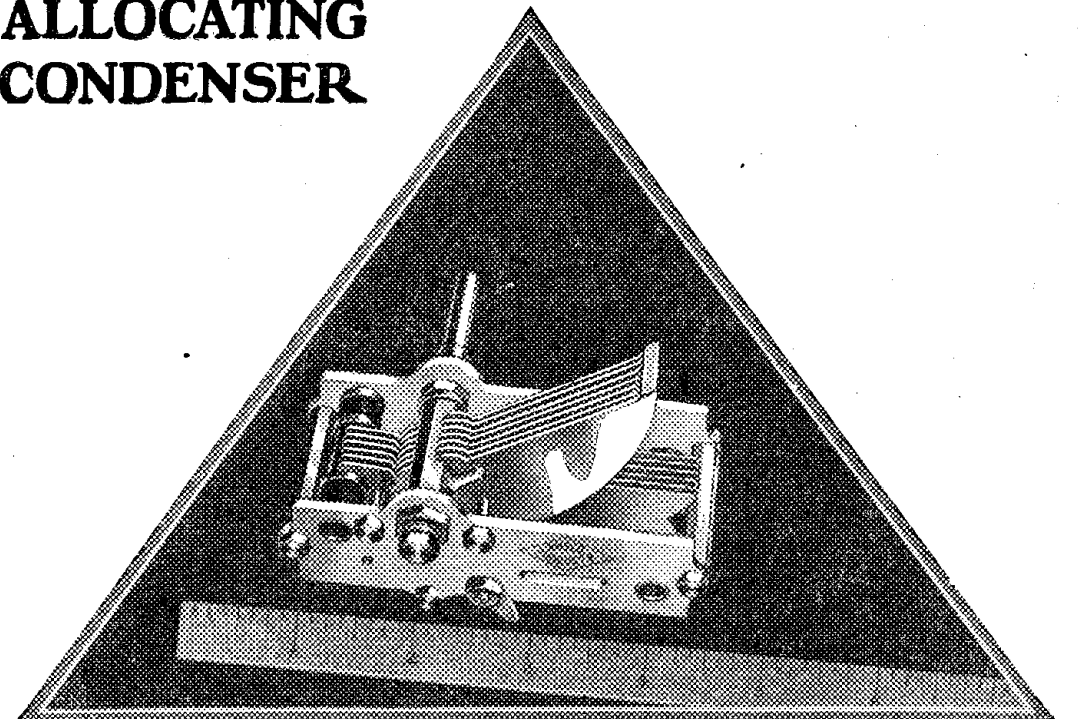

IT SAVES SPACE!

This straight line frequency condenser is a space-saver in the radio cabinet . . . It can usually be substituted for the old time condensers in existing sets . . . Once installed, it revolutionizes your ideas about tuning . . . Those Amsco half-a-heart-shaped plates add Kilocycles at the rate of ten to each dial division—giving "a station for every degree" . . . All wavelengths—high or low on the scale—tune in with equal ease . . . Amsco allocation of the stations is uniform and correct to within a fraction of 1% . . . Insist on Amsco Allocating Condensers . . . Made in six space-saving models, three Single and three Siamese, at very reasonable prices.

Amsco Products, Inc.,
Dept. O
Broome & Lafayette Sts.
New York, N. Y.

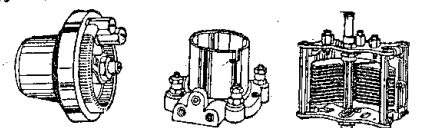

OTHER AMSCO PARTS
Write for our booklet, "The Heart of the Hook-up" for full details and prices of the entire Amsco line. Amsco for Excellence.

Build the Radio Digest "Fireside" T. R. F. Set

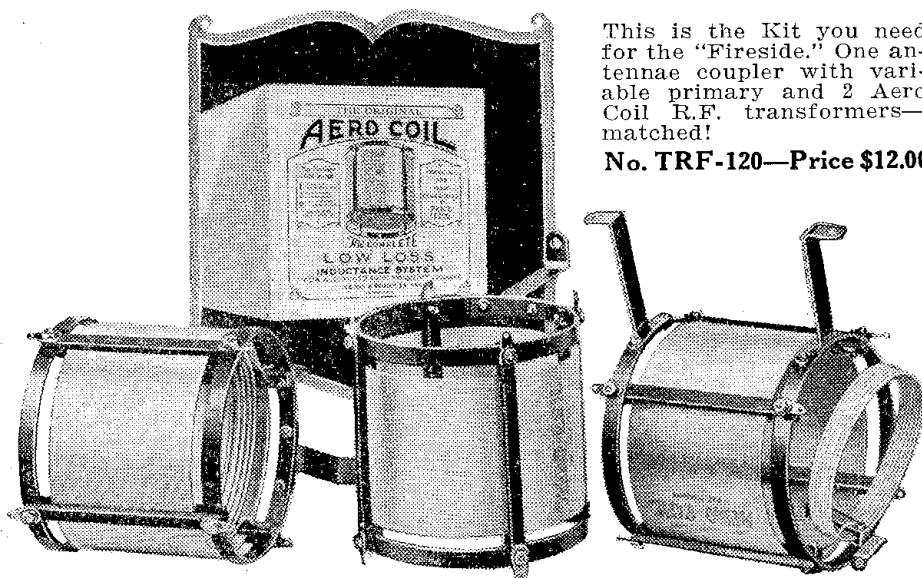

This is the Kit you need for the "Fireside." One antennae coupler with variable primary and 2 Aero Coil R.F. transformers—matched!
No. TRF-120—Price \$12.00

for SELECTIVITY and POWER!

THOSE are the two things you want. **Selectivity** to tune out the locals and **power** to bring in the distant stations, loud and clear like the locals.

The secret of these results—the secret of the "Fireside" set is primarily the **Aero Coils!** They have such a low high frequency resistance

95%
Air Dielectric
Dopeless
Uniformly Air-Spaced
Windings
Patents Prevent Imitation

and distributed capacity that they give **selectivity with power!**

Build this wonder set. See what Aero Coil's 95% air dielectric and dopeless air-spaced windings and correct, patented construction will do for you. Obtain a set of Aero Coils from your dealers or direct. **Write for free Aero Booklet.**

AERO PRODUCTS, INC., 217 N. Desplaines St., Chicago

AERO COIL
LOW LOSS
INDUCTANCE SYSTEMS

MUSICAL COMEDY IS NEW CHAIN ADDITION

MINIATURE PLAY PROJECT TO REACH MANY FANS

Noted Authors and Composers Combine to Present Series to WEA and Link Stations

NEW YORK.—Announcement was recently made via Radio through WEA, here, and a connected chain of stations stretching as far west as St. Louis, Mo., stating that original miniature musical comedies would be broadcast through these stations each Thursday night from 10:00 to 11:00 o'clock by the "Goodrich Zippers," sponsored by the B. F. Goodrich company of Akron, Ohio, who have engaged Lieut. Gitz Rice and George V. Hobart, two of Broadway's most prominent impresarios, to not only write the lyrics and music, but stage each weekly presentation.

"World Whirl" Series First

The first of the series, to be known as "A Whirl Around the World," is entitled "Cupid and the Cop," a whirling romance of Fifth avenue and Forty-second street, New York city, and will be presented before the microphone in the studios of WEA here. In addition to being broadcast by WEA, the following stations will be linked for simultaneous broadcasting: WJAR, Providence, R. I.; WEEL, Boston, Mass.; WTAG, Worcester, Mass.; WFL, Philadelphia, Pa.; WCAE, Pittsburgh, Pa.; WGR, Buffalo, N. Y.; WADC, Akron, Ohio; WSAI, Cincinnati, Ohio; WWJ, Detroit, Mich.; WCCO, Minneapolis-St. Paul, Minn.; WOC, Davenport, Iowa, and KSD, St. Louis, Mo.

Lieut. Gitz Rice, internationally known Canadian soldier-composer, is most popularly remembered as the composer of that famous war ballad which will never die, "Dear Old Pal of Mine." Aside from his many musical compositions he has had a wide and varied theatrical career. He has appeared in vaudeville with Blanche Ring, Irene Bordoni, Harold Forde and others, and has written musical comedies for the Messrs. Shubert in America and Andre Charlot in London. Only recently he was commissioned to journey to Paris to write several musical numbers for "Charlot's Revue" now on its way to New York after a remarkable success in Paris.

Hobart Well Known Also

George V. Hobart is perhaps best known through his adaptations of "Experience," "Sonny" and "Buddies" for the stage and his many sketches written expressly for Florenz Ziegfeld's "Follies."

Assisting Lieut. Gitz Rice and George V. Hobart will be Joseph Knecht, director of music for the Waldorf Astoria in New York City and well known to Radio listeners, and a cast which includes Frank Croxton, Albert Campbell, John Meyer, the "Silver Masked Tenor" (who previously appeared with the Silvertown Cord orchestra and whose identity still remains hidden), Ruby Hoffman, Miriam Moreman and Marion Ross. An orchestra will play light popular music both before, during and after each weekly presentation.

CYL—VOICE OF MEXICO

(Continued from page 7)

services. Music is broadcast each Tuesday from the Hotel Regis and from Abel's Cabaret. On Friday nights, two-hour concerts are given. The first part consists of Mexican typical music and folk songs by well-known charro singers and senoritas, and the charro typical band. The most popular selections, beloved alike by Americans and natives are: "La Paloma" (the Dove) and "La Golondrina," known as the Mexican Home Sweet Home song. A real treat for the Radio fan, accustomed to box-office prices, is the last half of the program which is given by real opera singers.

Emphasis is placed on the better type of music always, for the Mexican is essentially a musician and a lover of good music, from the president in the national palace at Chapultepec to the humble peon beside his little hut. And we might say right here that King Jazz doesn't hold the sway over their hearts—and feet—as it does in the States.

CYL has played no small part in teaching students of the Spanish and Mexican languages the correct pronunciation of their softly spoken tongues. Spanish classes throughout the country listen regularly.

Many telegrams and cables of appreciation are received by CYL. An innovation for confirmation to the listeners in, instead of the Ekko stamp, is their decorative genuine zarape. This blanket, in miniature, is beautifully designed in a combination of many colored yarns; often two or three days are required for the native Aztec Indians to weave one by hand. A charge of one dollar for a size

OPERATING MODEL 20

(Continued from page 11)

and all dials can quickly be set to maximum response. Then adjust the two rheostats to the point where both volume and clearness are at maximum, but do not turn them any further to the right as this would merely be burning up energy uselessly and will shorten the life of the tubes.

With a distant station tuned in, try shifting the switch located between dials 1 and 2 and reset the dials slightly. If any increased response is noted write down the dial settings and then tune in another station with the switch back on the point at which it was before. Then shift switch and reset dials as before. This procedure on different stations located in several directions will determine once and for all the switch setting and it should then be left alone. It will be found an excellent idea to keep a little red tag or something else bright in color attached to the filament switch for a few days, as otherwise if one leaves the set at a time when signals are not tuned in, it is very easy to go off and leave the tubes burning, possibly for many hours. The tag serves to attract one's attention and remind that the switch should be pushed in. After the fact that the switch is there and is to be used, has been sufficiently impressed on one's mind; the tag can be removed.

Dial Settings

The dial settings we found with the antenna compensating switch on point 2 are shown here and it seems reasonable to believe that other Model 20 sets will follow these settings very closely.

Wave Length	Dial 1	Dial 2	Dial 3
278	18	22	22
309	24	28	28
337	30	34	34
380	41	45	45
429	52	56	56
469	64	68	68
492	70	74	74
517	78	82	82
536	84	88	88

WJAZ Signs E. W. K. Howe, Musical Director

Noted Musician Directs First Zenith Station Program

CHICAGO.—E. Warren K. Howe, identified with the better things musical about Radio in Chicago for some time, has been selected by Station WJAZ of the Zenith Radio corporation to fill the position of musical director. Mr. Howe arranged and conducted his first program on the evening of November 5 from the new Straus building studio.

That Mr. Howe's influence cannot help but be a tremendous factor in giving to the public only the highest type of musical program is indicated by his training in the musical field. Through the influence of a genuine artistic environment in his youth, Mr. Howe enjoyed unusual advantages for a healthy development of his decided musical gifts.

He has had at various times under his baton in conjunction with musical festivals the country's best artists and the New York Symphony orchestra, the Chicago Symphony orchestra, the St. Louis Symphony orchestra, and the Minneapolis Symphony orchestra seven times. He has also been at the head of the vocal department of one of America's foremost conservatories for several years.

Promote William Stoess to Crosley WLW Studio Head

CINCINNATI.—William Stoess, former musical director of the Crosley WLW studios, has been promoted to the position of studio director. Stoess came to WLW two years ago, and has since served in various capacities, acting as studio director during the summer months of this year. He is a graduate of the Cincinnati College of Music and holds a post-graduate diploma from that institution. He is not only an excellent solo violinist, but has had considerable experience as an orchestra leader as well.

8x14 inches is made; a smaller size may be had for fifty cents. These may be used as souvenir mats, as a decoration or framed for use as a tray. The charge is necessary on account of postage, wrapping and payment to the Indians, many of whom obtain their meager livelihood by handweaving. Those desirous of obtaining these original zarapes may send remittance to Radio CYL, Juarez No. 62, Mexico City, Mexico.

Through arrangements made with stations in the United States, it is expected to increase the number of listeners to CYL during the coming winter season.

Artie Bittong and his Midnite Raiders are a popular feature of the Morning Glory club concert, which is broadcast every Friday evening at 10 p. m., eastern time, from WLIT.

sent FREE

What every owner of a radio should know about storage batteries

You'll be mighty glad you sent for this book

BECAUSE it contains all the information that you need to be really well informed about radio batteries.

It not only tells you what functions radio "A" and "B" Batteries perform in radio reception, but explains how it is done.

It tells you, by means of simple charts, how to select the proper capacity storage batteries for any type of radio set.

It tells you how to install and connect batteries so that their care and maintenance in proper condition is simple and easy.

It tells you how to recharge your batteries and how to care for them so that they will give you many years of excellent service.

If you want to be the best posted man on storage batteries in your neighborhood and at the same time know how to get the best results from your own radio, write today for this book.

It will be sent to you by return mail entirely free of charge.

THE PREST-O-LITE CO., INC.
INDIANAPOLIS, IND.
New York San Francisco
In Canada: Presto-O-Lite Company of Canada, Ltd.
Toronto, Ontario



Presto-O-Lite

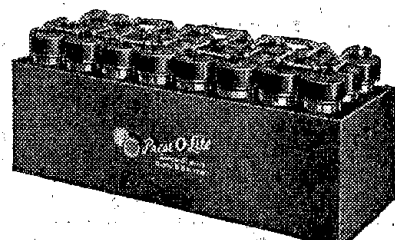

ADVANCE PROGRAMS FOR THE WEEK

Saturday, November 14

Headliners Today

Eastern	Central	Mountain	Pacific
8:30 p. m.	7:30 p. m.	6:30 p. m.	5:30 p. m.
KYW (536) Home Lover's hour.			
9	8	7	6
WLW (422.3) "The Valiant," play.			
WMAQ (417.5) Chicago theater revue.			
WRC (469) Two-piano recital.			
9:15	8:15	7:15	6:15
WCCO (416.4) University of Minnesota homecoming.			
9:30	8:30	7:30	6:30
KFVE (240) Comedy and jazz.			
10	9	8	7
KFPG (238) Ramblers hour.			

Saturday, silent night for: CFAC, CFCA, CHIC, CNRA, CNRC, CNRE, CNRM, CNRR, CNRT, CNRV, CNRW, KFAU, KFDM, KFMX, KFRU, KFUD, KLDS, KLX, KMA, KOB, KSAC, KTAB, WBAP, WBZ, WCAL, WCAP, WCAU, WCX, WEAO, WEBJ, WEEI, WGCP, WGST, WHAD, WHAZ, WHB, WHN, WHO, WJAD, WJAR, WLWL, WOI, WOS, WSUI, WTAB, WTIC, WWJ.

Eastern Time Stations

CFAC, Toronto, Can. (356), 2:15 p. m., McGill-Varsity football game.

CHIC, Toronto, Can. (356.9), 8 p. m., CHIC instrumental trio; Simeon Joyce, pianist; Ethel Peake, vocalist; 9:30, J. Wilson Jardine and his Palais Royal orchestra.

CNRO, Ottawa, Can. (435), 7:30 p. m., cosy corner for boys and girls, Uncle Dick; S. Chateau Laurier concert orchestra; 9, C. E. Goodall, baritone; Mrs. Edythe Young, soprano; Mrs. C. H. Burton, soprano; comedy, Bert Lloyd; Jeanne Seed, contralto; Helen Langdon, cellist; Chateau Laurier dance orchestra.

KDKA, Pittsburgh, Pa. (309.1), 7:15-8 a. m., morning exercises; 6:15 p. m., dinner concert, Westinghouse band; T. J. Vastine, conductor; 7:30, Westinghouse band concert, T. J. Vastine, conductor; 7:45, "Last Minute Helps to Sunday School Teachers," Carman Johnson.

PWX, Havana, Cuba (400), 8:30-11 p. m., concert, Clara R. de Nicola; Rosita Dihigo, S. Mendez, Mrs. Menendez de R. Valdes.

WAFD, Port Huron, Mich. (275), 9-11 p. m., studio program; 11:30-2 a. m., musical program, Addison hotel.

WAHG, Richmond Hill, N. Y. (315.6), 12-12:55 p. m., musical program.

WBBR, New York, N. Y. (272.6), 8 p. m., Fred Ehrenberg, musical saw soloist; 8:10, L. Marlon Brown, soprano; 8:20, Bible questions and answers, Judge Rutherford; 8:40, L. Marlon Brown, soprano; 8:50, Fred Ehrenberg, musical saw soloist.

WBZ, Springfield, Mass. (333.1), 2:30 p. m., Yale-Princeton football game.

WCAP, Washington, D. C. (468.5), 6:45-7 a. m., health exercises; 7:20-7:45, health exercises; 1:45 p. m., Princeton-Yale football game.

WCX, Detroit, Mich. (517), 2 p. m., news and markets; 6, dinner concert, Book-Cadillac hotel.

WEAF, New York, N. Y. (491.5), 1:45-5 p. m., Princeton-Yale football game; dance orchestra; 6-7, dinner music, Waldorf-Astoria; 7-11, musical program; 11-12, Vincent Lopez and his Hotel Pennsylvania orchestra.

WEAR, Cleveland, Ohio (389.4), 7 p. m., Hotel Statler concert orchestra; Maurice Spitalny.

WEEI, Boston, Mass. (348.6), 6:45 a. m., exercises; 7:45, morning watch, Estey organ studio.

WGBU, Fufford-by-the-Sea, Fla. (279), 6:30-7:30 p. m., Theaters, Miami, pianist; 10-12, Miami Daily Tab musical melange; 12-1, Blue Steele's orchestra.

WGCP, New York, N. Y. (252), 3:15-5 p. m., Henry Rogers, pianist; 3:15-3:30, Henrietta Cross, Maurice Abrahams, songs; 3:30-3:45, Ukulele Lon Hayes; 3:45-3:55, Rust and Henrickson, banjosts; 3:55-4:05, Johanna Cohen, ukulele; 4:05-4:15, Jack Davis, songs; 4:15-5, Richard Cheatham's Club Basha orchestra.

WGR, Buffalo, N. Y. (319), 1:45 p. m., intercollegiate football game through WEAF, Princeton vs. Yale at New Haven.

WGY, Schenectady, N. Y. (379.5), 2:15 p. m., Yale-Princeton football game; 9, bridge lesson; 9:30, dance program, Hotel Van Ouden.

WHAR, Atlantic City, N. J. (275), 2 p. m., Seaside hotel trio; 7:30, lecture period; 8, Seaside hotel trio.

WIP, Philadelphia, Pa. (338.2), 6:45 a. m., setting-up exercises, Dr. Francois D'Eliscu; 7, exercises; 10:30, reducing exercises; 1 p. m., organ recital, German-town theater; 3, Pennsylvania-Pittsburgh football game; 6:45, dinner music, Benjamin Franklin concert orchestra; W. Irving Oppenheim, director; 7, Uncle Wip's bedtime story, Roll Call; 8, sports corner, Dr. Francois D'Eliscu; 8:15, recital, announced; 10:05, Benjamin Franklin dance orchestra.

WJAR, Providence, R. I. (305.9), 1:45 p. m., Princeton-Yale football game; N. Y. Philharmonic.

WJR, Pontiac, Mich. (517), 2:30 p. m., Ohio State University vs. University of Michigan football game; 7, Jean Goldkette's Petite symphony orchestra, soloists; 9, Jean Goldkette's serenaders, soloists; 10, Jean Goldkette's orchestra; 11:30, Jewett Jesters, The Merry Old Chief.

WLIT, Philadelphia, Pa. (394.5), 12:02 p. m., daily almanac; Stanley theater organ recital; Arcadia cafe concert orchestra; 4:30, dance music; 7:30, Arcadia cafe concert orchestra.

WMCA, New York, N. Y. (340.7), 6-6:30 p. m., Olcott Vail and his Hotel McAlpin string ensemble; 7-7:30, the Amphons; 8:15-8:30, Cecilia Reichman, soprano; 9-9:15, Miriam Waller, soprano; Thomas Waller, tenor; 9:45-10, Regalibuto sisters, pianists; 11-12, Ernie Golden and his Hotel McAlpin orchestra.

WNYC, New York, N. Y. (526), 7-7:30 p. m., dance program; 7:30-7:55, police alarms; 8-8:15, police quartet; 8:30-9, Regina Besner, pianist; 9-10, concert; 10-10:30, lecture service, board of education; 10:30-10:35, police alarms and weather forecast.

WOR, Newark, N. J. (405.2), 3:15-3:45 p. m., Zit's Central Park Casino orchestra; 6:15-6:17, "Words Often Mispronounced," 6:17-7:15, dinner music, Hotel



The Post-Wurlitzer programs, from WKRC, Kodel station in Cincinnati, are creating a favorable impression in the radio world. These are novel, varied, sometimes classical and sometimes jazz. Beatrice Moser, violinist, plays classical selections on Thursday evenings.

High Lights of the Week

A THRILLING drama will make front seats desirable Saturday evening at WLW's theater of the air. "The Valiant," with a splendid cast, will be presented. Alumni unable to attend homecomings will find Radio is bringing these annual college affairs to them. Saturday WCCO broadcasts the University of Minnesota's homecoming.

Mabel Garrison, soprano, who is the Atwater Kent guest this Sunday, was scheduled to appear several weeks ago. Her appearance at that time being impossible the date was postponed to November 15. The Germantown theater is giving "Fedora," this Sunday. Ben Stadt and his WIP little symphony orchestra will assist.

One of the favorite Monday programs at WCCO is the dinner concert given by Gordon Cooke ensemble. Meta Ashwin Birnbach, soprano, is the soloist. WBAP, Fort Worth, introduces a new baritone, Victor B. Acers, a recent graduate of the New England conservatory. While studying in the East he sang frequently at WEEI, Boston. His first concert at WBAP will be given Monday, November 16.

At midnight Tuesday, two pretty maidens, the Lee sisters, will entertain before the microphone of WJJD. Their pictures are on pages 16 and 17. The San Francisco Danish Sing-

ing society is famous for the ensemble work of the thirty-two male voices. The society directed by Axel Pihlstrom may be heard at 8 p. m., pacific time at KPO. Ninety-seven people, including chorus of seventy-five voices, a mixed quartet and a symphonic orchestra will present a series of selections from "Robin Hood" at WTIC. This feature will begin at 8 p. m., eastern time.

Folk songs of the nations is the title of the program at WBZ Wednesday. These ballads which have sprung from the people and have been enjoyed by all because of their universal appeal will be presented in a most delightful fashion by Mrs. Helen Campbell Triplett, soprano, Mrs. Norman B. Brainerd, mezzo-soprano and Arthur Ballance, baritone.

President Coolidge, whose voice is now a household sound may be heard again Thursday when his address before the United States Chamber of Commerce is broadcast by WRC and WJZ Thursday evening. The president will begin speaking at 9 p. m., eastern time.

A good old-fashioned spelling bee, is the Friday feature at WLIT. It is to be known as the Philadelphia Championship spelling bee. Tune in and see how many words you really know how to spell. KLX celebrates its second anniversary this same evening.

Shelton; 7:15-7:30, sports talk, Bill Wathey; 7:30-8:30, Van's collegians; 11-12, Eddie Elkins Ciro orchestra.

WPG, Atlantic City, N. J. (299.8), 1:30 p. m., Hotel Morton luncheon music, J. Leonard Lewis, director; 6:45, Arthur Scott Brook, organist; 7, Hotel Ambassador dinner music; 8, studio concert; 9, Hotel Traymore concert orchestra; 11, dance orchestra.

WRC, Washington, D. C. (469), 12 m., organ recital; 1 p. m., New Willard hotel orchestra; 7, Hotel Washington orchestra; 7:45, Zoological talk; 8, Bible talk; 8:15, musical program; 10:30, Crandall's Saturday Nighters; 12, Colonial room orchestra.

WREO, Lansing, Mich. (285.5), 6-7 p. m., Speed-

Wagon Serenaders; Gold Standard ensemble; 10, Speed-Wagon Serenaders.

WTAG, Worcester, Mass. (268), 12:05-2 p. m., WTAG trio; 2:30, Holy Cross-Rutgers college football game.

WTAM, Cleveland, O. (369.4), 12:15-1:15 p. m., June hour, music, popular entertainers; 6-7, Hotel Hollenden orchestra, Carl Rupp, director; 8-9, Radio show; 9-12, novelty program, Ev Jones and the Coo Coo club.

WWJ, Detroit, Mich. (352.7), 12:05 p. m., Jules Klein's Hotel Statler orchestra; 2, football, U. of M.-Ohio State.

Central Time Stations

KFAB, Lincoln, Neb. (340.7), 2:30 p. m., football

game; 5:30-6:30, dinner concert; 8:30-9:30, Schmolter and Mueller musical program.

KFAU, Boise, Idaho (276), 7:30 p. m., dance program.

KFNF, Shenandoah, Ia. (266), 7 p. m., High School quartet, A. M. Burch, director.

KFVE, University City, Mo. (240), 8:30 p. m., amusement review, Romaine Fielding; dance night, Cens Wacker's orchestra; comedy and jazz.

KPRC, Houston, Tex. (296.9), 12 noon, Fatty Martin's End of Main dance orchestra; concert pianist; vocal entertainer; 3:30 p. m., Texas A. and M. College-Rice Institute football game; 7:35, Universal Bible class, Rev. Claud L. Jones; 8, studio concert; 11, midnight frolic program.

KSD, St. Louis, Mo. (545.1), 7 p. m., orchestral program, stage specialties, Grand Central theater.

KHS, Hot Springs National Park, Ark. (374.8), 9-9:15 p. m., football report; 9:15-9:45, dance concert, Meyer Davis orchestra, Lon Chassy, director; 9:45-10:15, program, Louis Davis; 10:15-10:45, dance tunes.

KYW, Chicago, Ill. (535.4), 6:30-7 a. m., morning exercises, Paul A. Leonhardt; 7:30, morning daily worship; 10:30, farm and home service; 11:35, table talk, Anna J. Peterson; 12:05-1 p. m., concert, Commonwealth Edison company; Coon Sanders Original Nighthawks; 6-6:30, musical program, Commonwealth Edison company; 6:35-7, Uncle Bob's bedtime story; 7-7:30, dinner concert, Congress hotel; 7:30-8:30, Home-lover's hour; 8:30-10:30, Congress classic, Edwin Borroff, director; 11-1 a. m., Congress carnival; 1-2, insomnia club; Coon Sanders Original Nighthawks.

WAMD, Minneapolis, Minn. (234.8), 12 m., Carl Schmid, tenor; Bayne Cummins, pianist; Marion Latta, contralto; Russell Murphy, baritone; 7 p. m., Harmony Twins, Minnesota male quartet; Don Schilken, banjoist; Osborn Billings, tenor; 11, skyrocket frolic, George Osborn's Skyrockets.

WAP, Fort Worth, Texas (475.9), 7:30 p. m., Sunday school lesson, Mrs. W. F. Barnum; music, Mrs. W. D. Smith; Mrs. Dan Brown, contralto.

WBBM, Chicago, Ill. (426), 4-6 p. m., popular program, Valentino Inn orchestra; 8-8:30, Merry Garden orchestra; Burdette Cleveland, concert pianist; Charlie Garland, Nate Caldwell, Corrine Jordan, Eddie Loftus; 9:30-10, popular program; Merry Garden orchestra; 11-1 a. m., Sunset quartet; Stewart-Warner string quartet; Montmartre orchestra; Lew Russell; George Marbach, tenor; Leona Hayes, harpist; 1-2, Hotsy Totsy hour; syncopation program for West Coast.

WCCO, Minneapolis-St. Paul, Minn. (416.4), 10:45 a. m., home service talk, girls' club; 12:30 p. m., Golden Pheasant concert orchestra; 2, Minnesota-Iowa football game, homecoming; 6:15, dinner concert, Biley's St. Paul hotel orchestra; 7:30, talk, Carey Emerson; 8, "Fireside Philosophies," Rev. Roy L. Smith; 8:15, musical program, U. of Minnesota homecoming night; 10:05, dance program, Arnold Frank's St. Paul hotel orchestra.

WDAF, Kansas City, Mo. (365.6), 3:30-4:30 p. m., Star's String trio; 6-7, piano tuning-in number; address, Roger W. Babson; organ music, Pantages theater; Trionon ensemble; 11:45-1 a. m., Nighthawk frolic; Plantation Players; Johnnie Campbell's Kansas City club orchestra; Earl Coleman's orchestra; Eddie Kuhn's K. C. Athletic club orchestra.

WEBH, Chicago, Ill. (370.2), 7:30-8 p. m., orchestra; Howard Neumiller, pianist; 9:30-10:30, orchestra; Marie Kelly, reader; Kay Ronayne, songster; 11:30-1 a. m., Oriole orchestra; Frank Grief, tenor; Blanche and Rudi Bale; Wayne Myers, reader.

WFAA, Dallas, Tex. (475.9), 12:30-1 p. m., Dr. J. D. Boon, astronomer; 2:30-3, Tom Fowler, violinist and uke soloist; 6:30-7:30, Baker hotel orchestra, Don Bestor's Best; 8:30-9:30, Mrs. A. E. Smith, soprano; Howard Parks, contralto; 11-12, Adolphus hotel orchestra.

WGN, Chicago, Ill. (370.2), 12:40 p. m., Drake concert ensemble, Blackstone string quintet; 1:30, Ohio State-Michigan; 6:30-7, Drake concert ensemble, Blackstone string quintet; 8-9, Tribu-z string trio; 10-11, Jack Chapman's and Blackstone hotel dance orchestras.

WHAS, Louisville, Ky. (399.8), 4-5 p. m., concert, Harry S. Currie's Music Box; readings, Martha Pope Robinson; 7:30-9, concert, Barney Rapp and his orchestra.

WHT, Chicago, Ill. (399.8), 6 p. m., classical program; Grayling's string trio; Eleanor Kaplan, violinist; W. Dyckman, baritone; Al Carney, organist; (288), 7:45-9:15, musical features; (399.8), 9:30, Jekke entertainers, Kitchin Klenzer Klaxies, Harry Langdon, harmonica; soloist; Marie Wright, soprano; Golden trio; Oscar Heather, tenor; Al Carney, organist; 12, Pat Barnes and Al Carney.

WJJD, Moseheart, Ill. (302.8), 10 p. m., Robert Duphney, Robert DeWar, Marie Winters, Purple Grackle orchestra; 12, Jack Mason, Fayette Miller, Purple Grackle orchestra.

WKRC, Cincinnati, O. (326), 10 p. m., dance music, Marion McKay and his Swiss Garden orchestra; studio features.

WLS, Chicago, Ill. (344.6), 12:45 p. m., "Talks to Young Trappers," S. T. Keshen; 7, lullaby time, Ford and Glenn; 7:15-1, national barn dance program, Tony Corcoran, Irish baritone; Grace Wilson, contralto; barn dance fiddlers, Joe Bren Minstrel company.

WLW, Cincinnati, Ohio (422.3), 7 p. m., Johanna Grosse, organist; 7:30, football results; 7:35, Secretary Hawkins; 7:50, James Boyce, baritone; 8:00, "The Valiant," cast: Ethel Goldsmith, Eugene Segal, Edwin L. Meyers, Charles Meade; 8:30, James Boyce, baritone; 8:45, Paul Hilling, pianist.

WMAQ, Chicago, Ill. (447.5), 2 p. m., Chicago-Dartmouth football game; 6, Chicago theater organ; 6:30, Hotel LaSalle orchestra; 8, Russell Pratt and Fredrick, Daw; 8:30, photogues, "The Balkan Signation," Dr. Bernadotte E. Schmitt; 9, Chicago theater review.

WMBB, Chicago, Ill. (250), 7-8 p. m., Trionon duo, Beatrice Teller, Frank Borden; 9-11, Trionon orchestra; Woodlawn theater orchestra; Billie Allen Hoff, Bob Bennett; Stokes and King.

WMC, Memphis, Tenn. (499.7), 8:30 p. m., musical program.

WOAW, Omaha, Neb. (526), 6 p. m., Val McLaughlin; Rialto orchestra; 7, Gilbert Jaffy and his Hittie

Tantalizing, mesmerizing, speedy! There's nothing faster on the air than Charles Agne and the Trionon Syncopators, a regularly featured orchestra at WMBB, Chicago.



(Continued on page 14)

"VALIANT" ON WLW'S SATURDAY BILL



Orley See is the director of the Breuner string ensemble, a San Francisco organization now winning fame at station K T A B, Oakland. The ensemble entertains every Friday with classical selections.

Saturday, November 14

(Continued from page 13)

symphony; 7:30, speakers' hour; 9, program, Omaha Printing company; 11, Arthur Hays, organist.
WOC, Davenport, Ia. (483.6), 5:45-6 p. m., chimes; 6:30-6:50, Sandman; 9-10, Griggs concert company; 11-12, LeClaire hotel orchestra; Peter MacArthur, baritone.
WOI, Ames, Iowa (270), 12:30 p. m., college chimes; 12:45, "Soils," questions and answers, Prof. P. E. Brown.
WOK, Homewood, Ill. (217.3), 12-2 p. m., Bob Duffy, tenor; Gus C. Edwards and his orchestra; 5:30-7, Howard Will, tenor; Robert York, tenor; Banks Kennedy, organist; WOK string trio; Gus Edwards and his orchestra; 10-11 a. m., Fred Witmer, pianist; Harold Morava, tenor; Herman Sinaiko, violinist; Harriet Lee, contralto; WOK string trio; Bill Hay, bass; Banks Kennedy, organist.
WORD, Batavia, Ill. (275), 8-10 p. m., Webster hotel orchestra, concert program, B. Callog, director; World News Digest; Chicago Motor club speaker.
WOS, Jefferson City, Mo. (440.9), 2 p. m., Oklahoma-Missouri football game.
WQJ, Chicago, Ill. (447.5), 11 a. m.-12 noon, "Too Fat—Too Thin," J. Teed, talk; P. E. Ormsby; "Correct Fiction," Peggy Richter; 7-8 p. m., dinner cert., Ralph Williams and his Rainbo Garden's orchestra; Everett G. Mitchell, baritone; Otis Jester, soprano; Kane McDuffee, whistler; 10-3 a. m., Ralph Williams and his Rainbo Skylarks; Carl Bertschinger, concert pianist; C. B. Roe, baritone; Jerry Sullivan; Rose Vanderbosch, soprano and pianist; Hal Lansing, uke soloist; Everett George Oble, character reader; June Lee, comedienne; Bert Davis, clown of the air; Clarence Theders, tenor; Sandy Meek, Scotch tenor; Harry Sosnick, pianist; Williamson Brothers, steel guitarists; Joey Stool, tenor; Brundage and Kraemer, harmony singers; artists.
WSAI, Cincinnati, Ohio (326), 2-4:30 p. m., football game, U. C.-Ohio university; 7:45, Story Lady, Mrs. Ethel Knapp Behrman; 8, Radio chimes, Robert Badley; 8:15, Bicycle playing card sextet; 9, U. S. Playing Card weekly news review; 9:15, Bicycle Playing Card sextet.
WSB, Atlanta, Ga. (428.3), 8 p. m., programs; 10:45, Hired help.
WSMB, New Orleans, La. (319), 8:30-10:30 p. m., Guy Bayl and artists, concert program.
WSOE, Milwaukee, Wis. (246), 3:30 p. m., matinee program, Cudahy high school band; 7:30, Third Annual Wisconsin Radio exposition; Van Buren's Hall-walls; opera stars, German opera company; 9, Sunday school lesson, Rev. H. S. Wise.

Mountain Time Stations

KFWA, Ogden, Utah (261), 5-6 p. m., Ogden Radio dealers' program; 9-12, Olive Reeves and his dance orchestra.
KOA, Denver, Colo. (322.4), 2:30 p. m., Colorado Agricultural college-U. of Colorado; 7, football final; 8, orchestra music.
KOB, State College, N. M. (348.6), 3 p. m., football game, State College-Junior College of El Paso.

Pacific Time Stations

KFOA, Seattle, Wash. (454.3), 8:30-9:30 p. m., program; 9:30-11:30, Eddie Harkness and his orchestra.
KFPG, Hollywood, Calif. (238), 5-6 p. m., home hour with Mammy Simmons; 6-7, dinner music by Olga Trumbull trio; 8-9, Maggie O'Shea, "The Blarney Girl" of KFPG; 9-11, Rambler's hour, Ben Sears presenting his "Jazz Babies of 1885" in old time dances and music.
KFWB, Hollywood, Calif. (252), 6:30-7 p. m., Bill Hatch and Ray Kellogg in E. P. Jones' program; 7:15, microphone brevities; 7:30, program, Elmer R. Stry company; 8-10, Radio Doings Revels; 10-11, Warner brothers frolic; 11-12, Henry Halstead and his Hollywood Roof orchestra.
KGO, Oakland, Calif. (361), 11:30-1 p. m., luncheon concert; 4-5:30, concert orchestra, Hotel St. Francis; 8, sport review; 8:10, Wiley B. Allen company studio, Eva Gruninger Atkinson, contralto; William Van den Burg, cellist; Michel Maskewitz, pianist; 10-12, Hotel St. Francis dance program.
KGW, Portland, Ore. (491.5), 12:30-1:30 p. m., Rose City trio; 2:30, football game, O. A. C.-U. of O.; 10-12, Indian Grill dance music.
KHJ, Los Angeles, Calif. (405.2), 6-6:30 p. m., Leighton's Arcadia cafeteria orchestra, Jack Crowsnaw, leader; 6:30-7:30, history story, Prof. Hertzog; Jack Searle, Jane Smith, Henrietta Poland in Radio Kiddies hour with Uncle John; 8-10, feature program de luxe, J. Howard Johnson; 10-11:30, Art Hickman's "Biltmore hotel" dance orchestra, Frank Ellis, leader; 11:30-2 a. m., Lost Angels of KHJ.
KLX, Oakland, Cal. (508.2), 2:30 p. m., Washington-California football game.
KNX, Hollywood, Calif. (336.9), 5:30-6:15 p. m., Wur-titzer pipe organ studio, Town Tattler; 6:15, travel talk, W. F. Alder; 6:30-7, Atwater Kent Radio orchestra, Paul Feinstein, leader; 7, talk on insect life, H. W. McSpadden; 7:15, church announcements; 8-10, KNX feature program; 10-11, Ray West's Coconut Grove dance orchestra from Ambassador hotel; 11-2 a. m., Hollywood Night.
KPO, San Francisco, Calif. (428.3), 1-2 p. m., Rudy Seiger's Fairmont hotel orchestra; 2:30-3:30, popular music, Bob Gershenson and his orchestra; 6:35-7:30, Waldemar Lind and the States Restaurant orchestra; 8-12, Cabrera Cafe orchestra, Jack Coakley, director.

Sunday, November 15

Headliners Today

Eastern 7 p. m.	Central 8 p. m.	Mountain 5 p. m.	Pacific 4 p. m.
WGY (379.5)	Carillon program.		
WLW (422.3)	Pogue company concert.		6
WIP (508.2)	Opera, "Fedora."		6:15
WEAF (491.5)	Atwater Kent artists.		8
			9
KTHS (374.8)	Singing orchestra.		9
			10
KNX (336.9)	C. Luboviski trio.		

Sunday, silent night for: CHIC, CKNC, CNRA, CNRC, CNRE, CNRM, CNRO, CNRR, CNRV, CNRW, CNRT, KFAB, KFAU, KFMO, KFQA, KFPG, KFVE, KFWA, KLX, KMA, KOB, KSAC, KWSC, WAHG, WBAP, WCAU, WCX, WDAF, WEAQ, WEBJ, WGES, WGBS, WGPC, WGST, WHAD, WHAS, WHAZ, WIP, WJAD, WJR, WLIT, WMC, WNYC, WOK, WOR, WORD, WRC, WSAI, WTAM, WTIC.

Eastern Time Stations

KDKA, Pittsburgh, Pa. (309.1), 10:45 a. m., church service; 4 p. m., Dr. Charles Heinroth, organist; 4:45, vesper services; Shady-side Presbyterian church; 6:30, dinner concert; 7:45, church service.
WAFO, Port Huron, Mich. (275), 10-11:30 a. m., services; 7:30-8:30 p. m., musical program.
WBFR, New York, N. Y. (272.6), 10 a. m., Watchtower orchestra; L. Marion Brown, soprano; 9 p. m., I. B. S. A. choral singers; Watchtower violin choir; Bible lecture, R. H. Barber.
WBZ, Springfield, Mass. (333.1), 10:50 a. m., services, Trinity church; 8 p. m., "The Tragedy of American Self-Isolation," Rabbi Stephen S. Wise.
WCAU, Philadelphia, Pa. (277.6), 5 p. m., Robert Gabriellian, tenor; Kathryn O'Boyle, pianist; 5:15, undenominational church service, Rev. J. W. Stockwell; 5:25, "Ten Important Books," John W. Stockwell; 5:35, recital; 5:45, "Does the World Notice a Good Deed?" Rev. Stockwell; 6:30, Hotel Pennsylvania trio; 7:30, Cathay Tea Garden concert orchestra; 8:30, Bonwit Teller recital.
WCX, Detroit, Mich. (517), 10:30 a. m., services, Central Methodist Episcopal church.
WEAF, New York, N. Y. (491.5), 2-3:45 p. m., "Sunday Hymn Sing," Greater New York Federation of churches; 3:45-5:30, men's conference, Bedford branch, Y. M. C. A.; 7:20-9:15, "Capitol Gang," Capitol theater; 9:15-10:15, Atwater Kent Radio hour, Mabel Garrison, soprano.
WEI, Boston, Mass. (348.6), 10:50 a. m., services, Old South church; 3:45 p. m., Dr. S. Parkes Cadman; 7:20, Major Bowes and his Capitol theater family; 9:15, Atwater-Kent hour.
WGBU, Fulford-by-the-Sea, Fla. (278), 9-11 p. m., sacred program.
WGCP, New York, N. Y. (252), 8-8:15 p. m., Charlotte Trystmann, pianist; 8:15-8:30, Dick's ukulele club; 8:30-8:45, studio program; 9-9:15, Isabelle Henderson, soprano; 9:15-9:30, Leslie McLeod, tenor; 9:30-9:45, Sylvia Schatz, pianist; 10-11, Strickland's orchestra.
WGR, Buffalo, N. Y. (319), 3 p. m., vesper service, Buffalo Council of Churches; 7:45, Central Presbyterian church service; 9:15-10:15, jointly with WEAF, Atwater Kent radio hour, featuring Mabel Garrison, soprano.
WGY, Schenectady, N. Y. (379.5), 11 a. m., choral celebration of the Holy Eucharist, Rev. Richard H. Nelson; 12:30 p. m., Detroit theater orchestra; 4, choral evensong, Cathedral of All Saints; 7, Carillon program; 7:30, Godfrey Ludlow, violinist, WJZ.
WHAR, Atlantic City, N. J. (275), 10:45 a. m., services; 2:15 p. m., Seaside hotel trio; 2:45, sermon; 7:50, Chelsea Baptist church; 9, Seaside hotel orchestra; 11:15, Strand theater organ recital.
WHN, New York, N. Y. (361.2), 1-1:30 p. m., Lexington organ recital; 2:30-3:30, Christian Endeavor program; 5-5:30, Roseland dance orchestra; 7:30-10, services, Calvary Baptist church; 10:45-11:15, Janssen's Hofbrau orchestra; 12-12:30, Club Richman entertainers.
WIP, Philadelphia, Pa. (508.2), 10:45 a. m., service, Holy Trinity church; Rev. Floyd W. Tomkins, rector.
WIAR, Providence, R. I. (305.9), 7:20 p. m., Capitol theater gang; 9:15, Atwater-Kent Radio hour; Mabel Garrison, soprano.
WLT, Detroit, Mich. (517), 8:30 p. m., Merry Old Chief, Jewett, lecturer.
WLIT, Philadelphia, Pa. (394.5), 2 p. m., Arcadia cafe concert orchestra; 4, Kentucky Mountain Boys; 8, open forum.
WLWL, New York, N. Y. (288.3), 8 p. m., Paulist choristers; sermon, Rev. Duane, S. J.
WMCA, New York, N. Y. (340.7), 6-7 p. m., Roemer's Homers; 7-7:30, Ernie Golden and his Hotel McAlpin string ensemble.
WPC, Atlantic City, N. J. (299.8), 3:15 p. m., Arthur Scott Brook, organist; Arvida Waldane, soprano; 4:15, St. James Episcopal church; Rev. William Blatchford, rector; 9, Hotel Ambassador concert orchestra; 10, Arthur Scott Brook, organist.
WREO, Lansing, Mich. (285.5), 10 a. m., chimes, Belfry Plymouth Congregational church; 10:30, church services, Plymouth Congregational church; 7:30 p. m., Central M. E. church.
WTAG, Worcester, Mass. (268), 3:45-5:30 p. m., men's conference, Y. M. C. A.; Dr. S. Parkes Cadman; 7:20-9:15, Major Edward Bowes and Capitol gang; 9:15-10:15, Atwater Kent Radio hour, Mabel Garrison, soprano.
WVI, Detroit, Mich. (352.7), 11 a. m., St. Paul's Episcopal cathedral; 2 p. m., Detroit News orchestra; 7:20, Capitol theater gang.

Central Time Stations

KFAB, Lincoln, Neb. (340.7), 4-5 p. m., vesper service.
KFDM, Beaumont, Texas (315.6), 8-9 p. m., sacred program.
KFMX, Northfield, Minn. (337), 7-8 p. m., college vesper service.
KFNF, Shenandoah, Ia. (266), 10:45 a. m., services, First M. E. church; 2:30 p. m., Golden Rule song service; 3, Men's Gospel team; 6:30, service, Golden Rule circle; 7:30, Christian church services.
KFUO, St. Louis, Mo. (545.1), 4 p. m., "I am the

True Vine," Rev. John Bajus; 9:15, The Land of the Reformation, Dr. H. Koch.

KLDS, Independence, Mo. (440.9), 11 a. m., Stone church service; 6:30 p. m., Nina Grenawalt Smith, soprano; Alice M. Burgess, contralto; George Anway, tenor; Frank Russell, bass; sermon, Elder U. W. Greene; 9, "Shakespeare and Religion," Ralph W. Farrell; KLDS orchestra; Pauline Becker Etzenhauser, organist; Albert Brackenburg, baritone.
KPRC, Houston, Texas (296.9), 10:45 a. m., services; 7:30 p. m., South End Christian church services; Rev. William Dunn Ryan, pastor; Coralie Gregory, choir director; W. R. Shriner, organist; 10, Frank Tilton, pianist.
KSD, St. Louis, Mo. (545.1), 7:55 p. m., WEAF chain.
KTHS, Hot Springs National Park, Ark. (374.8), 11 a. m.-12:15 p. m., services, Central Methodist church, Rev. J. J. Stowe; Arthur Platz, organist; 9-10, classic hour, New Arlington ensemble, Lon Chassy, director; Arthur Platz, tenor; John G. Heyne, accompanist; 10-11:30, Tower frolic, Phil Baxter's singing orchestra.
KYW, Chicago, Ill. (536), 11 a. m., Central church service, Rev. Frederick F. Shannon; 2:30, Chicago church federation; 3:30-5:30, studio concert, Edwin Harper, director; 7, Chicago Sunday evening club, speaker, Dr. Ernest M. Hopkins, President Dartmouth; 9:30-11, Sunday Evening music.
WAMD, Minneapolis, Minn. (243.8), 6 p. m., George Osborn's Radison hotel orchestra; 9:30, Jerry Harrington, tenor; Gayle Wood; Arline Suore, soprano; 11, George Osborn's Skylarks.
WBAP, Fort Worth, Texas (475.9), 11 a. m., First Methodist church; 12:30, Uncle Billy reads the comic section; 5-6, sacred harp singers; 11-12, popular music Abe Chesney and his music.
WBBM, Chicago, Ill. (226), 12-2 p. m., Sunset male quartet; 4-6, Harold Anderson, Merry Garden orchestra, Charlie Garland, Maurice Silverman, Burdette Cleveland, Blue Deuces, Zeigler Sisters; 8-10, Frances Ingram, contralto; Merry Garden orchestra; Wendel Weigert, violinist; Jeanne St. Anne, baritone; Christian Grim, accompanist; Ted Coleman, cellist; Joseph Raelff, pianist; 12-2, Nutty club request feature.
WCAL, Northfield, Minn. (337), 8:30 a. m., Norwegian services; sermon, J. Jorgen Thompson; 9, sacred program; sermon, Rev. Nils Kleven; Gertrude Boe-Overby, soprano; Lyla Pederson, contralto; Valeria Mischeels, pianist.
WCBZ, Zion, Ill. (344.6), 8 p. m., ladies' chorus, brass quartet; E. B. Paxton, baritone; Florence Farrar, contralto; Alexander DePew, flutist; Klowman and Studebaker, clarinetists; Mr. and Mrs. Richard Hire, violinists; Hester Robinson, reader; Richard Hire, pianist.
WCCO, Minneapolis-St. Paul, Minn. (416.4), 11 a. m., Westminster Presbyterian church, Rev. John E. Bushnell; 4-10 p. m., House of Hope Presbyterian church; 8:15, Atwater Kent program, Mabel Garrison, soprano.
WEBB, Chicago, Ill. (370.2), 10:40 a. m.-12 noon, services, Seventh Church of Christ, Scientist; 7-9, artist program.
WEBW, Beloit, Wis. (268), 4:30 p. m., vesper services, Beloit college.
WFAA, Dallas, Tex. (475.9), 3-4 p. m., Sunday hour for farmers; 6:30-7:30, Radio Bible class, Dr. William Anderson; 7:30-8:30, First Methodist Episcopal church services, Dr. Carl C. Gregory, pastor; 9:30-11, Chime's Collegians.
WGN, Chicago, Ill. (370.2), 12 m. comies, Uncle Walt; 1 p. m., Chicago theater; 2:30-3:30, Lyon & Healy organ recital; 3:30-5, Chicago Musical college; 9-10, Drake concert ensemble.
WHAS, Louisville, Ky. (399.8), 9:57 a. m., organ prelude; 10, Broadway Christian church; 4:30-5:30, evening choral service, Christ church.
WHO, Des Moines, Iowa (526), 11 a. m., services; 7:30-8:30, Reese-Hughes orchestra.
WHT, Chicago, Ill. (398.8), 2:15 p. m., Fellowship program; 2:50, services, Chicago Gospel tabernacle; 5:30, Young Women's council; 6:30, concert, Tabernacle band; choir; sermon, Paul Rader; 9:30, request program; 10:30, Paul Rader and chapel staff.
WKRC, Cincinnati, O. (326), 6:45 p. m., songs and service, Rev. J. J. Castleberry, Walnut Hills Christian church; 10, classical program; Merrill Schwarz, baritone; Gene Perazzo, pianist.
WLS, Chicago, Ill. (344.6), 6:30 p. m., Ralph Emerson, organist; 7-7:55, Little Brown church; Little Brown church quartet.
WLW, Cincinnati, Ohio (422.3), 9:30 a. m., editorial staff, Sunday school publications, Methodist Book concern; 11, services, Seventh Presbyterian church, Jesse Halsey, minister; Dan Beddoe, soloist, Adolph Stadermann, organist; 7, services, First Presbyterian church, Dr. Frederick McMillan, pastor; 8, H. & S. Pogue company concert, Walter Esberger, director.
WMBB, Chicago, Ill. (250), 3-5 p. m., Trianon orchestra; Woodlawn theater orchestra; Earle Smith, Bob Bennett, Walter Duffy; 9-11, Trianon orchestra; Woodlawn theater orchestra; Jack Goodwin, Ed Hines; Stokes & King; Coconut trio.
WOAI, San Antonio, Texas (394.5), 11 a. m., services, First Presbyterian church, Rev. P. D. Hill, pastor; 7:45, services, Central Christian church, Rev. Hugh McLellan, pastor.
WOAW, Omaha, Neb. (526), 9 a. m., chapel service, Rev. R. B. Brown; 2:30 p. m., matinee program; 9, chapel service.
WOC, Davenport, Iowa (483.6), 1-2 p. m., orchestral concert, Palmer Little symphony; Erwin Swindell, conductor; Paul J. Yiperman, tenor; 6:30-7, services; "The Gospel of Good Cheer," Rev. J. C. Yemm; 9:45-11:45, Palmer Little symphony; Erwin Swindell.

The most critical enjoy hearing Mrs. H. J. Collins, violinist, play at W H A D. Mrs. Collins is a Milwaukee artist of the first rank and through Radio has been able to reach a vast audience.



conductor; musical reading, "King Robert of Sicily," Dick Reed.
WOI, Ames, Iowa (270), 10:45 a. m., college chimes; 11, chapel services, Dr. E. A. Steiner.
WOK, Homewood, Ill. (217.3), 6:30-8:30 p. m., WOK string trio, mixed quartet, Gus Edwards and his orchestra.
WORD, Batavia, Ill. (275), 10 a. m., hymns, sacred songs, duets and solos; 10:15, Bible lecture, C. W. Appar; 9 p. m., hymns and sacred songs, I. B. S. A. choral singers; 9:10, Bible lecture; Oscar Olson; 9:30, sacred musical program.
WOS, Jefferson City, Mo. (440.9), 9:30 a. m., Christian church, Rev. Haushalter; 7:30 p. m., Methodist church, Rev. C. E. Ruyler.
WQJ, Chicago, Ill. (447.5), 9:30-11:30 a. m., sermon and services, Peoples' church; Dr. Preston Bradley officiating; 100 voice choir; Clarence Eddy, organist; 3-4 p. m., concert, Marvin Hinshaw and artist pupils, Hinshaw conservatory; 8-10, Ralph Williams and his Rainbo Gardens orchestra; Saida A. Ballantine artists; Frederick Clark, tenor, operatic quartet, Avallon singers; Agnes Lighthall, soprano; Lenora Altwater, contralto; Joseph Rodella, tenor; Roger Bromley, baritone; Helen Jule Keller, pianist; Elizabeth Breen, violinist; Iola Juhl, operatic soprano; Grace Wallace, soprano; Sheppard Levine, tenor; Helen Reed, accompanist; Gertrude Wolf Quentlin, soprano.
WSAI, Cincinnati, Ohio (326.9), 2:45-4:30 p. m., address, Dr. S. Parkes Cadman; Gloria trumpeters; 7:45, chime concert, Robert Badley; 8, serenade, Rev. John F. Herget; 8:15-9:15, Atwater Kent hour, WEAF; Mabel Garrison, soprano; 9:15, Union Central Life Insurance company orchestra; Sigmund Culp, director.
WSOE, Milwaukee, Wis. (246), 3:30 p. m., Third Annual Wisconsin Radio exposition, Mandolin club; 9, Dad Sattler, O. E. Schmidhull, soprano; Marion Henke, violinist; Jerry Christensen, tenor.
WSUI, Iowa City, Iowa (483.6), 9:15 p. m., familiar hymns, William G. Edmonds, Jr., tenor.

Mountain Time Stations

KOA, Denver, Colo. (322.4), 11 a. m., United Episcopal service; sermon, Rt. Rev. Charles Woodcock; address, Rev. Irving Johnson; 4 p. m., organ recital, St. John's Episcopal cathedral, Karl O. Staps, organist; 7:30, service, St. John's Episcopal cathedral; sermon, Benjamin Dagwell.

Pacific Time Stations

KFPG, Hollywood, Calif. (238), 8-9 p. m., KFPG concert hour, Turner orchestra, direction Loren Powell.
KFWB, Hollywood, Calif. (252), 9-11 p. m., Late news and Warner brothers movie frolic, featuring several Warner brothers movie stars.
KGO, Oakland, Calif. (361), 11 a. m., service, First Church of Christ; 3:30 p. m., KGO Little Symphony orchestra; Edilberto G. Anderson, guest artist; 8, First Church of Christ Scientist.
KGW, Portland, Ore. (491.5), 10:25-12 noon, services, First Presbyterian church; 7:25-9 p. m., First Presbyterian church.
KHJ, Los Angeles, Calif. (405.2), 6:30-7 p. m., Leighton's Arcadia cafeteria orchestra, Jack Crowsnaw, leader; 7-7:30, organ recital, Arthur Blakely, organist; 8-10, program, Young's Market company, arranged by Neva Chilberg.
KNX, Hollywood, Calif. (336.9), 7-8 p. m., First Presbyterian church of Hollywood, Stewart P. MacLennan, pastor; 8-9, Ambassador hotel concert orchestra, Josef Roserdl, leader; 9-10:30, program, Beverly Hills nurseries, Calmon Luboviski trio, Raquel Nieto, soprano; David Stuart, baritone.
KPO, San Francisco, Calif. (428.3), 9:45-10:45 a. m., Undenominational and non-sectarian church service; "The New Birth," Dr. M. H. Alexander; Hal Dover, baritone; Uda Waldrop, organist; 5-6 p. m., organ recital, Marshall W. Giselman; 6-6:30, Waldemar Lind and the States Restaurant orchestra; 6:35-7:30, Palace hotel concert orchestra, Cyrus Trobbe, director; 8-8:30, Palace hotel concert orchestra; 8-10:10, Rudy Seiger's Fairmont hotel orchestra.
KTAB, Oakland, Calif. (240), 9:45 a. m., Bible lecture, Prof. Linsly; 11, church service; 7:45 p. m., church service; 8:30-11, concert.

Monday, November 16

Headliners Today

Eastern 7:30 p. m.	Central 6:30 p. m.	Mountain 5:30 p. m.	Pacific 4:30 p. m.
WCCO (416.4)	Gordon Cooke ensemble.		
WBAP (475.9)	Victor B. Acers.		5
			6
WGY (379.5)	Chorus.		
WTAM (389.4)	One-act play.		6
			7
KDKA (309.1)	Happy home hour.		
WMC (499.7)	Moonlight syncopators.		
WSB (428.3)	Songs cycle.		
			6:30
WHAZ (379.5)	"Ancient Art of Bridge Building."		
			7
KTHS (374.8)	Versatility program.		
WKRC (326)	American Legion program.		
WSOE (246)	Send a Candygram frolic.		
			7:30
WGR (319)	Buffalo Arts club.		
			8
			9
KSD (545.1)	Kiburtz flute quartet.		
			9
			10
KFWB (252)	Eskimo revue.		

Monday, silent night for: CNRA, CNRC, CNRE, CNRM, CNRO, CNRR, CNRV, CNRW, CNRT, KFDM, KFMO, KFMX, KFRU, KHJ, KLDS, KNCT, KYW, WBBM, WCBZ, WEAQ, WEBB, WEBJ, WGES, WGN, WHAS, WHT, WIP, WJJD, WLBS, WLS, WMAQ, WMBB, WOC, WORD, WQJ, WRC, WREO.

Eastern Time Stations

CHIC, Toronto, Can. (357), 8 p. m., instrumental quartet, songs from Italy; Cosmopolitan quartet; Norma Wilcock, soprano; Edward Evans, baritone; vocal duet, Norma Wilcock, Grace Tyndal; musical reading, George Miner, Olive Seely, soprano.
CKNC, Toronto, Can. (357), 8-10 p. m., Toronto Conservatory trio; Frank Blachford, violinist; Leo Smith, cellist; Alberto Guerrero, pianist; Ella McQuillan, contralto; Arthur Blight, baritone.
KDKA, Pittsburgh, Pa. (309.1), 6:15 p. m., dinner con-



Thousands have been thrilled with the beauty of Irma Carpenter's soprano voice. She has been heard in all parts of the world during the Monday evening programs of the Spear's Happy Home hour at KDKA, Pittsburgh.

(Continued on page 15)

WIP WILL FEATURE OPERA "FEDORA"

Monday, November 16

(Continued from page 14)

cert; 7:30, children's period; 7:45, "International Art," Homer Saint-Gaudens; 9, Spear's happy home hour.

WAFD, Port Huron, Mich. (275), 9-10 p. m., studio program.

WAHG, Richmond Hill, N. Y. (315.6), 12-12:55 p. m., musical program; 7:30-7:45, Hon. Maurice E. Connolly; 7:45-8, Josiah B. Free, baritone; 8-8:30, Synchrophase trio; 8:30-8:45, Frank Almon and Eddie Smith; 8:45-9, Josiah B. Free; 9-9:15, Mabel Besthoff, pianist; 9:15-9:55, Synchrophase trio; 9:55-10, time signals and weather report; 10-10:15, Mabel Besthoff; 10:15-11:15, Glenn C. Smith's Paramount orchestra.

WBRR, New York, N. Y. (272.6), 8 p. m., Jubilee entertainers; 8:10, World news digest.

WBZ, Springfield, Mass. (333.1), 6:30 p. m., organ recital, Rene Dagenais; 7:05, "The Psychology of Understanding People," Prof. Abraham Myerson; 7:30, Capitol theater orchestra; 8, W. Edward Boyle's Copley Plaza orchestra; 8:30, Dr. Lawrence Obrey, tenor and yodler; John Thomas, pianist, accompanist; 9, Aleppo drum corps; 9:30, Florentine trio; Clara Geiber, pianist; Selestia Powers, violinist; Florence Kramer, cellist; 10:05, Hotel Brunswick orchestra.

WCAU, Philadelphia, Pa. (278), 8 p. m., Carolyn Thomas, soprano; Elmer Glasgow, bass; 9, Amsterdam Girl; 9:10, Nokol man; 9:30, Delaware County

trude Wilcox Harrod; 9, A. & P. Gypsies; 10, WEAF grand opera company.

WJR, Detroit, Mich. (517), 7 p. m., Jean Goldkette's Petite symphony orchestra; 9, Paige Six, Jewett Six; 11:30, Jewett Sisters.

WLIT, Philadelphia, Pa. (394.5), 12:02 p. m., daily almanac; Stanley theater organ recital; Arcadia cafe concert orchestra; 2, Arcadia cafe concert orchestra, Evelyn Gross Robinson, contralto; Marcella North, pianist; 4:30, Henry L. Wilson, baritone; Nettie Schaffer Conrad, soprano, Marcella North, accompanist; 7:30, Dream Daddy's bedtime stories; 8:30, May Farley quartet; 9:10, Stanley Hour of Music; 10, Arcadia cafe dance orchestra; 10:30, Howard Lanin's Benjamin Franklin hotel dance orchestra; 11, vaudeville features.

Hot Springs National Park introduces a new favorite, Louis Davis, who has a rich baritone voice. He sings regularly at KTHS, New Arlington hotel station there.



Mary Grant has charge of the studio presentations of the San Francisco Y. W. C. A. These programs, which are given every Friday from KGO, Oakland, Calif., involve many new educational ideas.

Although still in her "teens," this demure little girl, Dora Minovich, has aroused the attention of the illustrious music critics of Washington, D. C. Her recitals from WRC have shown a surprising skill for one so young.

serenaders; 10, Freedman and Travalline; 10:20, James Dougherty.

WCA, Detroit, Mich. (517), 2 p. m., news and markets; 6, dinner concert, Book-Cadillac hotel; 8, musical program.

WEAF, New York, N. Y. (491.5), 4-5 p. m., musical program; 6-7, dinner music, Waldorf-Astoria; 7-10:30, Elizabeth Kuntzer, pianist; dramatic recital, Josef Geiger; Colonial Aces; Hawaiian trio; Tower health talk; music, A. and P. Gypsies; "Your Hour"; 10:30-11:30, Ben Bernie and his Hotel Roosevelt orchestra.

WEEI, Boston, Mass. (346.9), 10:45 a. m., Betty Crocker's home service talk; 2 p. m., Happy Hawkins and his orchestra; 3, talk, A. J. Philpott; 7, Big Brother club; 7:45, J. Norton Blinkley, tenor; 8, anonymous orchestra; 8:45, WEAF, Tower health talk; 9, A. & P. Gypsies; 10, American House Marmalade and orchestra.

WGBU, Fulford-by-the-Sea, Fla. (278), 6:30-7:30 p. m., Blue Steele's Fulford-by-the-Sea orchestra; 10-11, Blue Steele's Fulford-by-the-Sea orchestra.

WGCP, New York, N. Y. (252), 3-3:15 a. m., Eva Rothenberg, pianologue; 3:15-4:15, Andy Pendleton's orchestra; 4:15-4:30, Joe Ross, harmonica; 4:30-5, Uncle Robert and his little pals; 5-5:15, Shirley Herman, songs; 6-6:45, Littmann's orchestra; 6:45-7, Daddy Winkum; 7-8, Dominion Ginger Ale orchestra; 8-8:15, Silvio De Rienzo, pianist; 8:15-8:30, studio program; 8:45-9, Bob Ward and the three little wards; 9-10, Strickland's orchestra; 10-11, Radio Shack hour; 11-11:30, Club Ritz orchestra; 11:30-12 a. m., Bob Murphy's entertainers; 12-12:30, Connie's orchestra.

WGHP, Detroit, Mich. (270), 8 p. m., WGHP Little Symphony.

WGR, Buffalo, N. Y. (319), 2:30-4:30 p. m., WGR's afternoon program; 6:30-7:30, Cliff Dwellers orchestra; 8:30-9, Dutch Master's program; 9-9:45, John Dodsworth, reader, and associates; 9:45-10, Doris Golokow, mandolinist; 10-11, Ethel Johnson and Bardinie Bartemus in a popular program; 11-11 a. m., Vincent Lopez Hotel Statler dance orchestra, Harold Gieser, director.

WGY, Schenectady, N. Y. (379.5), 2 p. m., Asia club orchestra; 2:30, Cooking lesson, "Suggestions for Thanksgiving," Jessie B. Lane; "Fish in the Diet," Mary Henry; 6:30, Hotel Van Curier orchestra; 7, WGY program for farmers; 7:45, "Constitution Day," Hon. Ellis T. Staley; 8, State college chorus; T. Frederick H. Candlyn; "Literary Appreciations, John Burroughs, Earth's Lover," William L. Widdemer.

WHAR, Atlantic City, N. J. (275), 2 p. m., Seaside hotel trio; 7:30, fashion review; 8, Seaside hotel trio.

WHAZ, Troy, N. Y. (379.5), 9 p. m., concert; 9:30, "The Ancient Art of Bridge Building," Prof. Leroy W. Clark; 10:30, Palladino's Artisan dance orchestra.

WHN, New York, N. Y. (361.2), 7-7:30 p. m., Marlboro State trio; 7:30-8:15, Swanee club orchestra; 8:15-8:20, talk, H. B. Shontz; 8:20-8:30, Roseland dance orchestra; 9-9:30, Guardians entertainers; 10-10:30, Billy Wynne's orchestra; 11-11:30, Cotton club orchestra; 11:30-12, Silver Slipper revue and orchestra; 12-12:30, Ted Lewis and his orchestra.

WIP, Philadelphia, Pa. (508.2), 1 p. m., Gimbel tea room orchestra; 3 artists recital, Philadelphia Conservatory of Music, Hendrik Ezerman, director; 6:05, Benjamin Franklin concert orchestra; 7, Uncle WIP's bedtime story and roll call; dancing lesson, Miss Miller.

WJAR, Providence, R. I. (305.9), 10 a. m., housewives Radio exchange, Mrs. Wood; 1:05 p. m., studio program; 8, Berry spring time; 8:30, Anna M. Herlihy, soprano; 8:50, "Home Care of the Sick," Mrs. Ger-

WLWL, New York, N. Y. (288.3), 9 p. m., Catherine Winston, soprano; WLWL trio; question box, Rev. J. M. Gillis; William P. Carney, tenor; J. C. Ungerer, organist.

WMCA, New York, N. Y. (340.7), 6-6:30 p. m., Olcott Vail and his Hotel McAlpin string ensemble; 6:30-7:30, Ernie Golden and his Hotel McAlpin orchestra; 7:30-8, lullaby music; 8-8:15, Edward French, pianist; Helman Weinstein, violinist; 9-10, lecture, Christian Science; 10:15-11:15, Radio Shack entertainers.

WNYS, New York, N. Y. (526), 6:10-6:20 p. m., market high spots; 6:20-6:30, piano selections; 6:30-7, elementary German lessons, V. H. Berlitz; 7-7:30, advanced German lessons, V. H. Berlitz; 7:30-7:35, police alarms; 7:35-8:15, dance program; 8:15-10, musical program; 10-10:30, lecture service, board of education; 10:30-10:35, police alarms and weather forecast.

WOR, Newark, N. J. (405.2), 3:45-4 p. m., talk, Charm Magazine; 6:15-6:17, "Words Often Mispronounced"; 6:17-7:15, dinner music, Hotel Shelton; 7:15-7:30, sports talk, Bill Wadley; 7:30-8:30, Eddie Elkins Ciro orchestra; 8:30-9:30, Al Reid's hour; 9:30-9:45, talk, Edward H. Bierstadt; 10-10:15, talk; 10:30-11:30, Archie Slater's Palais D'Or orchestra; 11:30-12, New Hobraun Haus orchestra.

WPG, Atlantic City, N. J. (299.8), 4:30 p. m., Chalfonte Haddon hall afternoon tea music; 6:45, Arthur Scott Brook, organist; 7, Hotel Morton trio; 8, children's hour; 8:30, Billy Buckley and his crew; 9, Hotel Trayance concert orchestra; 11, dance orchestra.

WRC, Washington, D. C. (469), 10 a. m., women's hour; WJZ; 12 noon, organ recital; 1 p. m., Shoreham hotel orchestra; 4:30, musical program.

WREO, Lansing, Mich. (285.5), 6-7 p. m., Speed-Wagon serenaders; Gold Standard ensemble; 8:15, Reo Motor Car company band; Reo Motor Car company band glee club.

WTAG, Worcester, Mass. (269), 10:45 a. m., talk, Sherer staff nurse, Marjorie Woodman; 12:05-2 p. m., WTAG trio; 7, science talk, Fred D. Aldrich; 8-9:55, concert; 10-11, grand opera.

WTAM, Cleveland, O. (389.4), 12:15-1:15 p. m., lunch hour music, popular entertainers; 6-7, dinner hour music, popular entertainers; 8-11, "The Game of Chess," one-act play; 11-11 a. m., Guy Lombardo and his Royal Canadians.

WTIC, Hartford, Conn. (475.9), 6:30 p. m., Emil Heimberger's Hotel Bond trio; 7:45, "Artificial Rubber," Prof. Cavelli; 8, dinner music.

WWJ, Detroit, Mich. (352.7), 7:30-8 a. m., setting-up exercises, R. J. Horton; 9:30, "Tonight's Dinner," 12:05 p. m., Jules Klein's Hotel Statler orchestra; 3, Detroit News orchestra; 6, dinner concert; 8, Ford Motor company band; WEAF A and P. Gypsies.

KFUO, St. Louis, Mo. (545.1), 8 p. m., "Marriage," Rev. A. Kuehnert.

KFVE, University City, Mo. (240), 8:30 p. m., concert, Brunswick-Balke-Collender company; Orchestra Romaine.

KPRC, Houston, Texas (296.9), 12 noon, Frank Tilton, boy pianist; 5:30 p. m., Uncle Judd's kiddies' hour; 7:30, Records' Ramblers dance orchestra; 8:30, Humble Oil and Refining company band, Charles Parker, director.

KSAC, Manhattan, Kan. (340.7), 12:35-1:05 p. m., "Remodeling the Old Poultry House," Walter G. Ward; "Why Not a Farm Flock?" M. H. Coe; 4:30-5, second year English literature; 6:30-7:30, psychology, P. P. Brainard; "Competition in Hog Production," W. E. Grimes.

KSD, St. Louis, Mo. (545.1), 6:45 p. m., Abergh's concert ensemble; 9, artist recital, Mrs. Ruth Hazlett Wunder, soprano; Paul Friess, pianist; 10, Dutch Masters' Cigar hour, F. Burtz flute quartet.

KTHS, Hot Springs National Park, Ark. (374.8), 9-10 p. m., Meyer Davis orchestra; Lon Chassy, violinist; Charles Garden, saxophonist; 10-11, hour with Fensterlick's California serenaders.

KYW, Chicago, Ill. (536), 11:35 a. m., table talk, Mrs. Anna J. Peterson; 1 p. m., noonday concert, Commonwealth Edison company; Coon Sanders original night-hawks; Joska DeBabary and his orchestra; 6:35-7, Uncle Bob.

WAMD, Minneapolis, Minn. (243.8), 12 m., Charles Cordray, tenor; Helen Collins, pianist; Ristow sisters; 6 p. m., George Osborn's Radisson hotel orchestra; 7, a trip around the world; 11, Skyrrocket frolic.

WBAP, Fort Worth, Texas (475.9), 12:05-12:30 p. m., Jordan sisters, Coots, Boots, Wren; 6-6:30, Texas Hotel Tokio Royals; 7:30-8:30, Victor B. Acres, soloist; Betty Williams, pianist; 9:30-10:45, "Trail Blazers," 11-12, entertainers, Majestic theater.

WBBM, Chicago, Ill. (266), 4-6 p. m., Valentine Inn orchestra; 6-7, Montmartre orchestra; Marie Morgott, harpist; Charlie Garland, Nate Caldwell; Two Jays, Corrine Jordan, Fred L. Jeske, Ted Coleman, cellist; Lew Russell, Pete Kules.

WCAI, Northfield, Minn. (337), 9:45 a. m., St. Olaf college chapel services; 8:30, Lawrence Halvorsen, flutist; Naomi Hanson, soprano; Thorman Groth, basso; mixed quartet.

WCCO, Minneapolis-St. Paul, Minn. (416.4), 10:45 a. m., "A Menu for Thanksgiving Dinner," Betty Crocker; 12 m., Donaldson's orchestra; 2:30, afternoon concert; 4, readers' club, Mrs. Walter Stevens; 6:30, Gordon Cooke ensemble, Meta Ashwin Birmbach, soprano; 7:45, farm lecture, poultry raising, lesson V; 8, U. of Minnesota program; 9, program; 10:05, "Hay Standards Made Official," F. H. Steinmetz.

WDAF, Kansas City, Mo. (365.6), 3:30-4:30 p. m., Star's Radio orchestra; 6-7, C. M. Raron, reader; Tell-Me-a-Story Lady; Trianon ensemble; 8-9, Around the Town; 9-10, Ivanhoe band; Glee club; Edward Gill, director; 11:45-1 a. m., Plantation players; Ted Meyn, organist; Eddie Kuhn's Kansas City Athletic club orchestra; Earl Coleman's orchestra.

WFAA, Dallas, Tex. (475.9), 12:30-1 p. m., Trent's Happy synopaters; 6:30-7:30, Artie Collins and his Ozark Inn orchestra; 8:30-9:30, Sears-Roebuck Agricultural Foundation program.

Central Time Stations

WGN, Chicago, Ill. (370.2), 12:40 p. m., Drake concert ensemble, Blackstone string quintet; 2:30, artist series, Lyon & Healy; 3, talk, John Reed Tyson; 3:30-4:15, tea time music, Marshall Fields tea room orchestra; 5:30, Skeezix time; 6:30-7, Drake concert ensemble, Blackstone string quintet.

WGST, Atlanta, Ga. (270), 9-10 p. m., E. D. Arwood, flutist; Lenora Case, soprano; Helen Murray, pianist.

WHAS, Louisville, Ky. (399.8), 4-5 p. m., concert, Music Box; children's stories, Eleanor Huber; fashion talk, Peggy True; readings.

WHO, Des Moines, Ia. (526), 7:30-8 p. m., program, Drake University Conservatory of Music, Dean Holmes Cowper, director; 8-9, faculty program; 11-12, organ recital.

WIAD, Waco, Tex. (352.7), 8:30-10 p. m., Schubert choral club, J. T. Guthrie, director.

WKRC, Cincinnati, O. (326), 6:15 p. m., dinner program, Alvin Roehr's Hotel Alms orchestra; 8, Post-Vulturner popular series; Freda Sanker's Famous orchestra; 9, musical program, American Legion; Charles Partington, accordionist; 12, theatrical stars; 12:30, Wesley Helvey's Troubadours, popular orchestra.

WLW, Cincinnati, Ohio (422.3) 7:30 a. m., morning exercises, William Stradtman, Y. M. C. A.; 7:45, morning devotions, auspices Parkway Y. M. C. A.; 9:00, Crosley elementary school program, musical appreciation lesson, Sarah Y. Chine; 9:10, talk, Mrs. F. G. Richard, Miami university, "How the National Hero Became Famous"; 9:20, Agricultural Primer, J. W. Schwab, Purdue university, "The Pig's Dinner"; 9:25, calisthenics, direction Parkway Y. M. C. A.; 12:15 p. m., noonday service, Rev. George H. Kase; 4, student recital, pupils of Leo Stoffregen; 6:30, special theatrical feature; 7, dinner hour, Hotel Gibson orchestra directed by Robert Visconti; 7:30, theatrical review; 7:40, Gibson concert; 8, the Cincinnati Times Star concert, personnel from first stands of Cincinnati Symphony orchestra, William J. Kopp, director, Howard Hafford, tenor; Sigmund Culp, violinist.

WMAQ, Chicago, Ill. (447.5), 12:45 p. m., Radio farm school; 3 p. m., shut-in program; 4, mothers in council; 4:30, "Fables of the Moment," Mrs. Graham Aids; 4:45, Glenn Dillard Gunn School of Music; 5:15, Topsy Turry time; 6, Chicago theater organ recital; 6:30, Hotel LaSalle orchestra; 6:40, Family Altar league.

WMC, Memphis, Tenn. (499.7), 8 p. m., Bennett's Moonlight synopaters.

WOAI, San Antonio, Tex. (394.5), 3 p. m., musical program.

WOAW, Omaha, Neb. (526), 12:45 p. m., Randall's Royal Fontenelle orchestra; 5:40, Val McLaughlin; 6, Phyllis Grindoff, organist; 6:50, Fontenelle orchestra; 9, de luxe program.

WOC, Davenport, Ia. (483.6), 12:15-12:35 p. m., "Hog Day," Prof. John M. Eppard; "How to Make a Fall Pig a Success"; 3-3:30, Aunt Jane; 5:45-6, chime concert.

WOI, Ames, Ia. (270), 12:30 p. m., college chimes; 12:45, Dairy production discussion, Earl Weaver.

WOK, Chicago, Ill. (217.3), 12-2 p. m., Banks Kennedy, organist; Bob Mokrejs, pianist; Gus C. Edwards and his orchestra; 6-1, Jimmy Tenor; Herman Sinaiko, violinist; Jimmy Cairns, tenor; Norman Bartlette, bass; Gus C. Edwards and his orchestra.

WOS, Jefferson City, Mo. (440.9), 8 p. m., conservatory of music, Christian college.

WOJ, Chicago, Ill. (447.5), 11-12 noon, home economics program, Helen Harrington Downing; "Time," Mrs. G. W. Cornwell; 3-4 p. m., "New Pastry Wrinkles," Helen Downing; "Care of the Skin and Hair," Madame Huntingford; book review, Rev. Fred Harrison.

WSAI, Cincinnati, Ohio (325.9), 10-12 midnight, studio concert.

WSB, Atlanta, Ga. (428.3), 8 p. m., Lula Clark King song cycle; 10:45, concert.

WSD, Milwaukee, Wis. (246), 2 p. m., cooking chats, Prudence Penny; 5:30, twilight hour, Aunt Happy; Laurine Ludwig, soprano; Elmer Ihke, pianist; 6:30, "Hog Raising," F. B. Hansen; 9, Send a Candygram frolic; Elmer Clemens and his Red Oak Country club orchestra; E. Erving, baritone; Van Buren's Hawaiians; Victor Maves, pianist; Charles Bennett, blind piano-accordionist.

WSUI, Iowa City, Ia. (483.6), 12-12:30 p. m., Harry Thatcher, Jr., pianist; "Improvement of the Written Examination," Dr. G. M. Ruch; 7:30-8:50, college of the air lectures; 9, musical program.

Mountain Time Stations

KFAU, Boise, Idaho (278), 8 p. m., bedtime stories, Mrs. Forrest Pitts; male quartet.

KFWA, Ogden, Utah (261), 5-6 p. m., Ogden Radio dealers' program; 9-10, studio program.

KOA, Denver, Colo. (322.4), 12:15 p. m., Rialto theater musicale; 6:30, dinner concert, Brown Palace string orchestra, Howard Tiltson, director; 7:30, Sandman's hour; 8, program, Lamont School of Music, Florence Hinman, director; piano, violin and cello solos, readings, choral numbers, student talent; piano and vocal solos, faculty program; Iris Ruth Payey, reader; Gregor Cherniavsky, Edward Millstone, Miriam Frosh Jacobs, violin solos; Frances Cornwell harpist.

KOB, State College, N. M. (348.6), 7:30-8:30 p. m., "Soil Alkali—Its Cause and Correction," Prof. Jordan; "Sunlight and Health," Miss O'Loughlin.

Pacific Time Stations

KFOA, Seattle, Wash. (453.3), 6:45-8:15 p. m., Sherman, Clay and company program; 8:30-10, Times studio program.

(Continued on page 16)

MABEL GARRISON, SOPRANO, ON WEA

Index to Popular Concerts

TABULATED below is a time table of the stations giving popular concerts this week. Stations are divided into the four different standard times in use. The hours are given in the kind of time in use at each listed station. By using this table as an index and referring to the complete programs below, full information will be obtained.

Popular

SATURDAY, NOVEMBER 14			
Eastern	Central	Mountain	Pacific
7:30 p. m.	6:30 p. m.	5:30 p. m.	4:30 p. m.
WEAA.	7	6	5
8	7	6	5
WLS.	8	7	6
9	8	7	6
WBBM, WEA, WENR, WGBS, WLS, WMAQ, WNYC.	9	8	7
10	9	8	7
KFAB, KPRC, WBBM, WENR, WGN, WLS, WMBB, WREO.	10	9	8
11	10	9	8
KFVE, KFVB, KNX, KTHS, WBBM, WL, WMBB, WOK, WQJ, WRC.	11	10	9
12	11	10	9
KNX, KOIL, KPO, KPRC, WBBM, WLS, WOA, WOK, WQJ.	12	11	10
1 a. m.	12 m.	11	10
KFWB, WDAF, WBBM, WEBH, WENR, WL, WOK, WQJ, WSAI.	1 a. m.	12 m.	11
2	1 a. m.	12 m.	11
KNX, WBBM, WENR, WQJ.			

SUNDAY, NOVEMBER 15			
Eastern	Central	Mountain	Pacific
9 p. m.	8 p. m.	7 p. m.	6 p. m.
WBBM.	9	8	7
10	9	8	7
WBBM, WMBB.	10	9	8
11	10	9	8
WMBB.	11	10	9
12	11	10	9
KNX, KTHS.	12	11	10
1 a. m.	12 m.	11 p. m.	10
KFWB, WBBM.	1 a. m.	12 m.	11
2	1 a. m.	12 m.	11
KFWB.			

MONDAY, NOVEMBER 16			
Eastern	Central	Mountain	Pacific
7 p. m.	6 p. m.	5 p. m.	4 p. m.
WBBM, WFAA, WOAW.	7	6	5
8	7	6	5
WGBS.	8	7	6
9	8	7	6
WCAU, WEA, WGR, WKRC, WOK.	9	8	7
10	9	8	7
KFAB, WGR, WKRC, WMCA, WOAW, WOK, WSOE.	10	9	8
11	10	9	8
KFAB, KFVE, WOK.	11	10	9
12	11	10	9
KLX, KNX, KOIL, WHO, WOK.	12	11	10
1 a. m.	12 m.	11	10
KFWB, KLX, WAHG, WDAF, WHT, WKRC, WOK.	1 a. m.	12 m.	11
2 a. m.	1 a. m.	12 m.	11
KFWB.			

TUESDAY, NOVEMBER 17			
Eastern	Central	Mountain	Pacific
7 p. m.	6 p. m.	5 p. m.	4 p. m.
WMCA, WOAW.	7	6	5
8	7	6	5
WBBM, WEAR.	8	7	6
9	8	7	6
WBBM, WEAR, WBZ, WSB.	9	8	7
10	9	8	7
WBBM, WMBB, WOAW.			

WEDNESDAY, NOVEMBER 18			
Eastern	Central	Mountain	Pacific
8 p. m.	7 p. m.	6 p. m.	5 p. m.
KFNE, WAHG, WEBJ, WEEL, WMCA.	8	7	6
9	8	7	6
WBBM, WEBJ, WGCP, WNYC.	9	8	7
10	9	8	7
KFAB, KPRC, WBBM, WGCP, WHO, WMBB.	10	9	8
11	10	9	8
KFAB, KFVE, KGW, KPO, KWSG, KYW, WBBM, WBN, WMBB, WOK, WQJ.	11	10	9
12	11	10	9
KFWA, KFVB, KNX, KYW, WOK, WQJ, WSAI.	12	11	10
1 a. m.	12 m.	11	10
KNX, KYW, WBBM, WHT, WOK, WQJ.	1 a. m.	12 m.	11
2	1 a. m.	12 m.	11
KFWB, KNX, WBBM, WOK, WQJ.			

THURSDAY, NOVEMBER 19			
Eastern	Central	Mountain	Pacific
8 p. m.	7 p. m.	6 p. m.	5 p. m.
WCAE, WEA, WJAR, WMC, WOC, WSAI.	8	7	6
9	8	7	6
WBBM, WHAD.	9	8	7
10	9	8	7
KMA, WBBM, WEEL, WHAD, HN, WMBB, WMC, WNYC, WOAW, WSOE.	10	9	8
11	10	9	8
KHJ, KMA, KYW, WBBM, WMBB, WOK, WQJ.	11	10	9
12	11	10	9
KHJ, KTAB, KOIL, WBBM, WDAF, WEAA, WKRC, WOC, WOK, WQJ.	12	11	10
1 a. m.	12 m.	11	10
KFWB, KHJ, WDAF, WHT, WOK, WQJ.	1 a. m.	12 m.	11
2	1 a. m.	12 m.	11
KNX, WQJ.			

FRIDAY, NOVEMBER 20			
Eastern	Central	Mountain	Pacific
8 p. m.	7 p. m.	6 p. m.	5 p. m.
WGCP, WJB.	8	7	6
9	8	7	6
WBBM, WGB, WLS, WOC.	9	8	7
10	9	8	7
KFAB, WBBM, WMC, WDAF, WHAD, WMBB, WOAW, WSOE.	10	9	8
11	10	9	8
KFVE, KFVA, KHJ, KLX, KYW, WMBB, WOK, WQJ.	11	10	9
12	11	10	9
KFWB, KHJ, KNX, KOIL, WMC, WOK, WQJ.	12	11	10
1 a. m.	12 m.	11	10
KFWB, KHJ, WDAF, WHT, WOK, WQJ.	1 a. m.	12 m.	11
2	1 a. m.	12 m.	11
KNX, WQJ.			

Monday, November 16
(Continued from page 15)

KFPG, Hollywood, Calif. (238). 5-6 p. m., home hour, Mammy Simmons; 6-7, dinner music Olga Trumbull; 7:30-8, short lectures on history and astronomy; 8-10, KFPG concert hour, Turner orchestra, direction Loren Powell.

KFWB, Hollywood, Calif. (252). 5-6 p. m., children's hour, Big Brother of KFWB; 6:30-7, Altadena program, E. P. Jones; 7-8, microphone brevidollar Four orchestra, LeRoy Kulberg and his ukulele and others; 9-11, The Eskimo Revue presented by the Globe Ice Cream company and Weber Baking Co., featuring the Five Little Eskimos; 11-12, Henry Halstead and his Hollywood Roof orchestra.

KGO, Oakland, Calif. (361). 7:30 a. m., health training exercises; 7:45, pep class, Hugh Barrett Dobbs; 8:15-8:30, health training exercises, Hugh Barrett Dobbs; 8:30, daily strength; 10, classroom instruction, sixth grade; 11:30-1 p. m., luncheon concert, Pacific States Electric company; 3-4, musical program, interpretations of the classics, Wilda Wilson Church; 6-7, twilight concert, Wiley B. Allen company; 8, "The Constitution and Respect for Law," Frederick M. Hunter; "Government," Talks on Constructive Selling, B. J. Williams; "Chats About New Books," Joseph Henry Jackson, "The San Francisco Bay Chemical Industries," H. L. Oak; Arion trio.

KGW, Portland, Ore. (491.5). 12:30-1:30 p. m., Rose City trio; 8:30, concert.

KLX, Oakland, Calif. (508.2). 4-5 p. m., women's hour; 5-5:30, Aunt Elsie's Irate Pirate for children; 8-9, Lemar Bread company program; 9-10:30, Order of Lake Merritt Ducks, special guest night; Order of Redmen.

KNX, Hollywood, Calif. (336.9). 5:30-6:15 p. m., Wurlitzer pipe organ studio, Town Tattler; 6:15, travel talk, W. F. Alder; 6:30-7, Atwater Kent Radio orchestra, Paul Finstein, leader; 7-7:30, Mutual Motors mirth contest; 7:30-8, program, Columbia Outfitting Co.; 8-9, program, L. W. Stockwell company; 9-10, program, Listenwaller & Gough, Rola string quartet; Elite trio; 10-11, Goodrich Silvertown Cord dance orchestra, Lilyan May Challenger, contralto.

KPO, San Francisco, Calif. (428.3). 7:30, 8 a. m., daily dozen exercises; 1-2 p. m., Rudy Seiger's Fairmont hotel orchestra; 2:30, Constitution Day talk; Educational Week opening; guitar, uke and banjo trio; 5:30-6:15, children's hour, Big Brother; 6:40-7, Waldemar Lind and the States Restaurant orchestra; 7-7:30, Rudy Seiger's Fairmont hotel orchestra; 8-10, Uda Waldrop night, organ selections, Uda Waldrop; 8:45, "How Much Exercise Should the Growing Boy or Girl Take," Wiley Winsor; 10-11, Waldemar Lind and the States Restaurant orchestra.

KTAB, Oakland, Calif. (240). 4-5 p. m., women's club notes; 8-10, Western States Life Insurance company.

KWSC, Pullman, Wash. (348.6). 7:30-9 p. m., Audrey Savage, reader; Fresh vocal quartet; Ronald Rice, flutist; special number, Lickeny and Moon; "Ideals of American Education," Pres. E. O. Holland; "Making the Best Use of Spare Time," Dr. F. F. Nalder.

Tuesday, November 17

Headliners Today			
Eastern	Central	Mountain	Pacific
6 p. m.	5 p. m.	4 p. m.	3 p. m.
WRBO (285.5) Gold Standard ensemble.	7	6	5
7	6	5	4
WTIC (475.9) Selections from Robin Hood.	8:30	7:30	6:30
WEAF (491.5) Gold Dust Twins.	8:30	7:30	6:30
WHAS (399.8) Zoeller's Melodists.	9	8	7
WEAF (491.5) Eveready hour.	9:30	8:30	7:30
WBB (338.1) Alandale minstrels.	10	9	8
11	10	9	8
WMCA (340.7) South American Troubadours.	11	10	9
12	11	10	9
KFWB (252) Pep program.	12	11	10
KFA (428.3) Danish Singing society.	1 a. m.	12 m.	11
1 a. m.	12 m.	11	10
WJJD (302.8) Lee Sisters.			

Tuesday, silent night for: CFC, CHIC, CKNC, CNRC, CNRE, CNRM, CNRO, CNRW, CNRT, KFAU, KFRU, KFUO, KFWA, KLX, KOA, KOB, KPOM, KWSG, WAHG, WAMD, WBBR, WCAL, WGCP, WGST, WHAD, WHAZ, WIAD, WLIT, WLWL, WOR, WOS, WSM, WSMB, WSUI, WTAM.

Eastern Time Stations
CNRA, Moncton, Can. (291). 7 p. m., juvenile program, Prof. C. M. Wright, director; 8, Truro artists, quartet; Mrs. Frank Dickie, songs; John Spott, D. R. Henderson, violinist; Gordon McPhail, Horace McDougall; 10, CNRA orchestra, Walter Neale.
KDKA, Pittsburgh, Pa. (309.1). 6:15 p. m., KDKA Little symphony orchestra; 7:45, "Has Education Made Good?" Dr. G. H. Alderman; 8, world cruise, Ross H. Skinner; 9, KDKA Little symphony orchestra; Pittsburgh sextet; 11:35, Grand theater concert.
WAFD, Port Huron, Mich. (275). 8-10 p. m., Port Huron Boy Scout orchestra; 10-12, musical program, Addison hotel.
WAHG, Richmond Hill, N. Y. (315.6). 12-12:30 p. m., Joe Zimmerman, pianist.
WBZ, Springfield, Mass. (333.1). 6:30 p. m., Leo Reisman's Hotel Lenox ensemble; 7:05, Hotel Kimball dance orchestra, Bob Patterson, director; 7:20, Frank Davis, tenor; Stephen Boisclair, pianist; 7:35, dance orchestra, Hotel Kimball; 7:45, banjo selections, Alfred Seher; Ruth Carroll, pianist; 8, Gertrude Hatcher, mezzo-soprano; 8:15, special theatrical program; 9:30, Alandale hour, minstrels; William Mackay, director.

WCAU, Philadelphia, Pa. (278). 7:30 p. m., N. Snell-entburg and company, Philomela quartet; 8, building and loan talk; 8:10, Three Brothers; 8:25, Ambrose McIntyre, baritone; Marie McGuigan, soprano; Kathryn O'Boyle, pianist; 9:20, Robert Fraser; Blind Gospel singers; 9:40, Harry Link, Willie Horowitz; 10:30, Billy Hayes and his Cathay Tea Garden orchestra.
WCX, Detroit, Mich. (517). 2 p. m., news and markets; 6, dinner concert, Book-Cadillac hotel; 10, the Red Apple club.

WEAF, New York, N. Y. (491.5). 4-4:15 p. m., Dorothy Mueller, contralto; 4:15-4:30, Dorothy Wilder, pianist; 4:30-5, women's program; 6-7, dinner music, Waldorf-Astoria; 7-7:10, Mina Hager, contralto; 7:10-7:30, lecture, Columbia university; 7:30-8, Davis saxophone sextet; 8-8:10, talk, Dudley F. Fowler; 8:10-8:30, Ross Gorman and his Earl Carroll Vanities orchestra; 8:30-9, the Gold Dust Twins; 9-10, "Eveready Hour"; 10-10:30, "Your Hour"; 10:30-11, Vincent Lopez and his orchestra; 11-12, Meyer Davis' Lido-Venice orchestra.

WEAO, Columbus, Ohio (293.9). 9 p. m., chimes; farm topic, "Soils," Prof. F. E. Bear; 9:30, "Our Progressive Heritage," Prof. F. W. Coker.

WEBJ, New York, N. Y. (272.6). 7:30 p. m., Siebert's Original Midnight Serenaders; 7:45-8, Joe Sherman; Lew Pollack; 8-8:15, talk, G. T. Geer; 8:15-8:30, Sara V. Turits; Sadie Goldfarb, accompanist; 8:30-9:30, International dance orchestra, direction, Ed. Behringer.

WEEL, Boston, Mass. (348.6). 7:45 a. m., morning watch; 2, Joe Rines, Radio artists; George Joy, Neil Cantor; 7 p. m., Big Brother club; 7:45, talk; 8, WEAF, Earl Carroll theater orchestra; 8:30, Gold Dust Twins; 9, Eveready hour; 10, musicale; 10:30, Vincent Lopez and his orchestra.

WGBU, Fulford-by-the-Sea, Fla. (278). 6:30-7:30 p. m., Blue Steele's orchestra; 10-1, Blue Steele's orchestra; Theresa Horn, pianist.

WGCP, New York, N. Y. (252). 3-3:15 p. m., Silvio De Rienzo, pianist; 3:15-3:30, Nat Osborne and Eddie Meredith, songs; 3:30-3:45, Isabelle Henderson, soprano; 3:45-4, Leslie McLeod, tenor; 4-4:15, studio program; 4:45-5, J. Vincent Moore, tenor.

WGHP, Detroit, Mich. (270). 8 p. m., Skylark dance band.

WGR, Buffalo, N. Y. (319). 2:30-4:30 p. m., WGR's afternoon program; 6:30-7:30, Vincent Lopez Hotel Statler dance orchestra, Harold Giesler, director; 8-11, jointly with WEAF, including Gold Dust Twins, Earl Carroll theater selections, Eveready hour and Vincent Lopez and his Casa Lopez orchestra.

WGY, Schenectady, N. Y. (379.5). 2 p. m., "Conservation of Our National Resources," Mrs. E. C. Whitmyre; health hints, Dr. C. W. Woodall; 2:30, Stephen E. Boisclair, organist; 6:30, dinner program, Hotel



The leader of the Philadelphia orchestra liked Amedee Vergnaud's viola solo selections so well, he was invited to join the Philadelphia organization. Since then WIP has been fortunate enough to secure Mr. Vergnaud as a studio artist. He will play Sunday with Ben Stad and his WIP little symphony.

Van Curler orchestra; 7:30, "Water Purification," Prof. Warren C. Taylor; 7:45, WGY orchestra; 7:55, "Patriotism Day," Dr. James Sullivan; 10, "The Rhine"; 10:30, Hotel Mayflower orchestra.

WHAR, Atlantic City, N. J. (275). 2 p. m., Seaside club orchestra; 7:30, book review, Mrs. James Lord; 8, Seaside hotel trio; 11:15, Strand theater organ recital.

WHN, New York, N. Y. (361.2). 12:30-1 p. m., Lexington organ recital; 2:15-3:15, overture and vaudeville, Loew's State theater; 3:15-4:30, Lexington theater orchestra; 7-7:30, Iceland orchestra; 7:30-8, Will Oakland's Chateaux Stanley; 11-11:30, Caravan organ orchestra; 11:30-12, Rodeo club orchestra; 12-12:45, Club Kentucky revue and orchestra.

WIP, Philadelphia, Pa. (508.2). 10 a. m., menu, Mrs. Anna B. Scott; 1 p. m., organ recital, Germantown theater; 3, Carolyn Schimming, soprano; Babette Gerhach, contralto; Elizabeth O. Gear, pianist; Flora Ripka, accompanist; 6:05, Joe Ray and the California Night Hawks; 7, Uncle Wip's roll call and birthday list; songs, Eleanor Urviler; 8, Elliott Lester, dramatic critic of WIP; 8:15, negro composers, Carl Dixon, composer-pianist; Wilmette Kealing Jackson, soprano; Julia Gilbert, contralto; G. L. Payne, tenor; Brodie McCormick, bass; Edwin Francis Hill, violinist; Joseph Lockett, pianist; talk on negro music, Carl Dixon; 10:05, Joe Ray and the California Night Hawks.

WJAR, Providence, R. I. (305.9). 1:05 p. m., Providence-Biltmore concert orchestra; 7:30, musical, Clarence Chadwick, director; 8, speaker, Providence Safety Council; 8:30, Gold Dust Twins; 9, Eveready hour.

WJR, Detroit, Mich. (517). 7 p. m., Jean Goldkette's Petite symphony orchestra; 9, program.

WLIT, Philadelphia, Pa. (594.5). 11 a. m., organ recital; 12:02 p. m., daily almanac; Stanley theater organ recital; Arcadia cafe concert orchestra; 2, Arcadia cafe concert orchestra; 2:30, Helen Munder Good, contralto; 4:30, Miriam Cohen, violinist; Arthur Comby, baritone; Marcella North, accompanist; 7:30, Dream Daddy's bedtime stories; 7:50, theatrical review, Allyn C. Saurer.

WMCA, New York, N. Y. (340.7). 6-6:30 p. m., Olcott Vail and his Hotel McAlpin string ensemble; 6:30-7, Frank Gibbala and his Red Lion Inn orchestra; 7-8, Jack Wilbur's personalities; 8-8:15, Raymond G. Parker, tenor; Dorothy Taylor, contralto; 9-10, Polka Dot club orchestra; 10-10:30, South American Troubadours; 10:30-11, Manhattan Serenaders; 11-12, Ernie Golden and his Hotel McAlpin orchestra.

WNYC, New York, N. Y. (526). 7-7:10 p. m., market high spots; 7:10-7:30, the Canadians; 7:30-7:35, po-



lice alarms; 7:35-8, the Canadians; 8-10, studio program; 10-10:30, Harry Ash's orchestra; 10:30-10:35, police alarms and weather forecasts; 10:35-11, Harry Ash's orchestra.

WOR, Newark, N. J. (405.2). 3:30-3:45 p. m., Fred Koester's Clifford Lodge orchestra; 6:15-6:17, "Words Often Mispronounced"; 6:17-6:30, sports talk, Bill Wathey; 6:30-7, Man in Moon; 7:15-7:45, dinner music, Hotel Shelton.

WPG, Atlantic City, N. J. (299.8). 1:30 p. m., Hotel Ambassador luncheon music; 6:45, Arthur Scott Brook, organist; 7, Hotel Morton dinner music; 8, Ethel Ratay Fowler's fashion flashes; 8:15, studio concert, Cecile Steiner, violinist; Margaret Irwin, pianist; 9, Chalfonte Haddon hall trio; 10, WPG male quartet; 11, dance orchestra.

WRC, Washington, D. C. (469). 10 a. m., women's hour, WJZ; 12 noon, organ recital, Otto Beck; 1 p. m., New Willard hotel orchestra; 6:50, "Show Shopping," Leonard Hall; 8, Wurlitzer musicale, WJZ; 9, WJZ Edison hour; 10, "The Grand Tour," WJZ; 10:30, W. Spencer Tupman and his Hotel Mayflower orchestra, WJZ.

WTAG, Worcester, Mass. (268). 10:45 a. m., talk to mothers, Rosebelle Jacobus; 12:05-2 p. m., WTAG trio; 8-8:30, Ross Gorman and his Earl Carroll Vanities orchestra; 8:30-9, "Long and Broad"; 9-10, Eveready hour; 10-10:30, program; 10:30-11, Vincent Lopez and his orchestra.

WTAM, Cleveland, O. (389.4). 12:15-1:15 p. m., popular entertainers; 6-7, Hotel Hollenden orchestra, Carl Rupp, director.

WTIC, Hartford, Conn. (475.9). 6:30 p. m., Hub Restaurant trio; 7, Spencer, Perry, baritone; 8, selections from "Robin Hood," Travelers mixed quartet; Travelers choral club; 9:30, Joseph C. Beebe, organist.

WV, Detroit, Mich. (352.7). 9:30 a. m., "Tonight's Dinner"; 12:05 p. m., Jules Klein's Hotel Statler orchestra; 3, Detroit News orchestra; 6, dinner concert; 7, WEAF program.

Central Time Stations
KFAB, Lincoln, Neb. (340.7). 8:30-10:30 p. m., University of Nebraska musicale.
KFDM, Beaumont, Tex. (315.6). 8-10 p. m., musical program.
KFMX, Northfield, Minn. (337). 10:10-10:30 p. m., piano lesson, Frederick Locke Lawrence.
KFNF, Shenandoah, Iowa (266). 7 p. m., concert, Kodaway, Iowa Lloyd Means, director.
KFWE, University City, Mo. (240). 8:30 p. m., studio entertainers; classical piano selections.
KLDS, Independence, Mo. (440.9). 8 p. m., lecture course series, Mrs. M. A. Etzenhauser; 8:30, Walnut Park orchestra; Margaret Gard, contralto; Fern Cox, soprano.
KPRC, Houston, Texas (296.9). 12 noon, popular program; 5:30 p. m., Uncle Judd's kiddies' hour; 7:30, Billie Mack and his orchestra; 8:30, H. M. Garwood, vocalist; J. D. Brightwell, accompanist; 9, "How to Play Auction Bridge," lesson II.
KSAC, Manhattan, Kan. (340.7). 12:35-1:05 p. m., "Utility and Beauty in Poultry Breeding," J. H. McAdams; 4:30-5, woman's club program; 6:30-7:30, better speech; "Community Organization," Walter Burr; "Feeding Stock Cattle," B. M., Anderson; "Recent Changes in Poultry Management."
KSD, St. Louis, Mo. (545.1). 6:55 p. m., WEAF chain.
KTHS, Hot Springs National Park, Ark. (374.8). 9-9:15 p. m., organ selections, Louis Culp; 9:15-9:45, Edison company; 6:40-7, children's story, Walter Wilson; 7-7:30, Congress hotel; 7:35-7:53, speeches, American Farm Bureau Federation; "Good Debts and Bad Debts," George Woodruff; 8-9, Congress hotel; 9-10, Commonwealth Edison company; 10-12, evening at home program, Coon Sanders' Original Night-hawks, Insomnia club.

DANCE
Central
Saturday, Nov.
8, Wjr, Wbn
8:30, Wfaa, 3
9, Wbbm, Ww
Wnye, Wroa; 9
Wip; 9:30, K
Wor, Wrc;
Kfwa, Koa, E
Wgn, Wjr, W
Wnye, Wor, W
Wtam; 10:0
10:30, Wanc
Wls; 11, K
Kfwb, Kpo, W
Wgbu, Wbo, V
Kfoa; 11:45
Kfwa, Kgo, I
Wgbu, Wjdd

Monday, Nov
8, Wgcp; 9, W
Wjar, Wor; 9
10, Kths, W
Wgr, Wnye, W
Wor; 10:30, E
Wbn; 11, K
Wgbu, Wgcp;
Who; 11:45,
Knx, Kpo.

Tuesday, Nov
9, Wbbm, W
9:30, Weau, W
Wip; 9:35, W
Kfve, Wbbm
Wgbu, Wgcp, W
Wmbb; 10:05
9:15, Wbb; 9
Who; 9:30;
Wbap; 9:40-10:05
10:30, Wbap;
Koll, Kpb, W
Wgcp; 9:45, K
Wdaf; 10:12, K
Kpo, Wjdd.

Thursday, Nov
8, Wjr; 9, W
Wgbu, Wbo, W
Wmbb; Wsai;
Wb; 9:30, W
Wbz, Wwh; 9
Wgy, Wwh; 9
10, Kths, W
Wgbu; Wwh; 9
Wjdd; 10:30, T
Wbbm; Wgub;
11:45, Wdaf;
Khl, Knx, Kp

VICTOR B. ACERS AT WBAP MONDAY

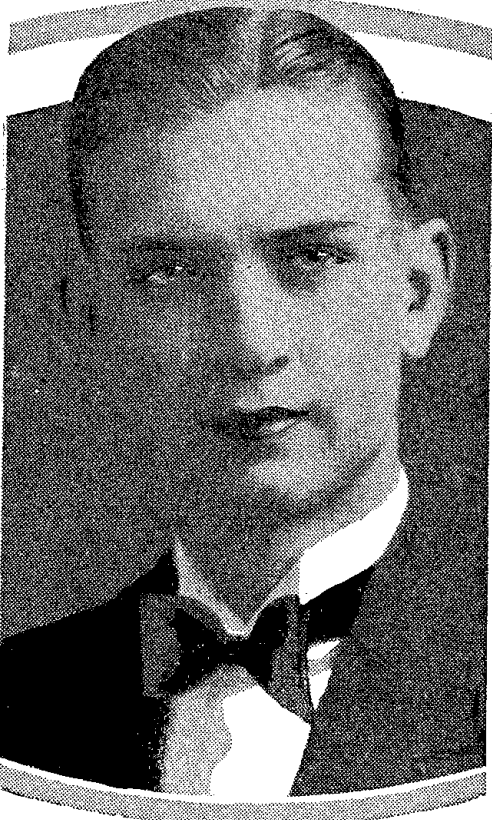

Jack Passey is the good looking leader of the orchestra which entices Utah fans to tune for KFWA, Browning Brothers, at Ogden.

Wednesday, November 18

(Continued from page 17)

WBZ, Springfield, Mass. (333.1), 6:30 p. m., Leo Reisman's Hotel Lenox ensemble; 7:05, program, Don Ramsay; 7:30, nature story, Thornton W. Burgess; 8, concert series; folk songs of nations, Helen Campbell Triplet, soprano; Mrs. N. Brainerd, mezzo-soprano; Arthur Ballance, baritone; Milton Aronson, violinist; instrumental trio; 9, Mae Shepard-Hayward, soprano; Hazel Leonard, violinist; Edith Greene, pianist.

WCAU, Philadelphia, Pa. (278), 7:30 p. m., Lew Chapman and his Hotel Pennsylvania orchestra; 8, stage dancing lesson, Al White; 8:15, Girls' vocal trio; 9, Mr. Hill's instrumental trio; 9:30, health talk; 9:40, Moe and Joe; Micky Marr, pianist; 10, Hal Chase's Pennsylvania Collegians; 10:30, Morris Wager; 10:45, Frank Cook, songs of yesterday.

WCX, Detroit, Mich. (517), 2 p. m., news and markets; 6, dinner concert, Book-Cadillac hotel; 8, studio program.

WEAF, New York, N. Y. (491.5), 4-4:45 p. m., Ray Nichols orchestra; 4:45-5, talk, Elizabeth Timlow; 6-7, dinner music, Waldorf-Astoria; 7-7:30, services, United Synagogue of America; 7:30-8, concert, United States Army band; 8-8:30, "Huyler's Bon Bon Buddies"; 8:30-9, Pooley concert; 9-10, WEAF concert ensemble; 10-11, Ipana Troubadours; 11-12, Ben Bernie and his Hotel Roosevelt orchestra.

WEAO, Columbus, Ohio (293.9), 8 p. m., "Eye Conservation," Prof. Howard Minchin; 8:15, football, A. Lee Henderson; 9, "The Schools and Social Progress," Prof. H. Bode.

WEBJ, New York, N. Y. (252), 8-8:30 p. m., Barnett's orchestra; 8:45-9, Robert Sener, pianist; 9:15, Bernard Bromens, tenor; Norman Hennefeld, pianist; 9:15-9:45, McLean's dance orchestra.

WEEI, Boston, Mass. (348.6), 10:45 a. m., Betty Crocker's home service talk; 3 p. m., Johnnie Bowles and his orchestra; 7, Big Brother club; 8, Huyler's Bon Bon Buddies; 8:30, Radio Equipment company program; 9, musicale; 9, Ipana Troubadours.

WGBU, Fulford-by-the-Sea, Fla. (278), 6:30-7:30 p. m., Theresa Horn, pianist; 10-11, Blue Steele's orchestra; talk on Florida, M. C. Tebbets.

WGCP, New York, N. Y. (252), 3-3:15 p. m., Henry Rogers, pianist; 3:15-3:30, Frances O'Connor, ukulele; 3:30-3:45, Webster, songs; 3:45-4:30, Clarence Williams, trio; 4:30-4:45, Harry Spear, songs; 4:45-5, Charlotte Trystmann, pianist; 6-6:45, Dominick Ginger Ale orchestra; 8-8:15, Charol de Thomee, pianist; 8:15-8:30, Hock and Jerome, songs; 8:30-8:45, Hughie Woolford, pianist; 8:45-9, Nat Osborne and Eddie Meredith, songs; 9-9:15, Twentieth Century entertainers; 10-11, studio program; 9:45-10, Win Unger, songs; 10-11, Strickland's orchestra; 11-11:30, Club Richman entertainers; 11:45-12, Strickland's orchestra; 12-12:30, Connie's orchestra.

WGHP, Detroit, Mich. (270), 8 p. m., WGHP Little symphony.

WGR, Buffalo, N. Y. (319), 2:30-4:30 p. m., WGR's afternoon program; 7-7:30, Harmony Six orchestra; 8:30-9, Gospel Melodists; 9-10, Vernon Curtis and associates; 10-11, jointly with WEAF, Ipana Troubadours; 11-11 a. m., Vincent Lopez Hotel Statler dance orchestra, Harold Gleser, director.

WGY, Schenectady, N. Y. (375.5), 6:30 p. m., program for children; 6:45, Albany Strand theater orchestra; Floyd H. Waters, organist; 7:30, Book of Knowledge program; 8:15, "School and Teacher Day," Dr. Frank P. Graves.

WHN, New York, N. Y. (361.2), 7-7:30 p. m., Cotton club orchestra; 10-10:30, Roseland dance orchestra; 11:30, Silver Slipper orchestra; 12-12:30, Club Richman entertainers; 12:30-1, Ted Lewis and his orchestra.

WIP, Philadelphia, Pa. (508.2), 10:30 a. m., special reducing lessons, Dr. Francis D'Eliscu; 1 p. m., Gimbel tea room orchestra; 3, Temple university school of music, Dr. Thaddeus Rich, dean; E. F. Ulrich; 6:05, Benjamin Franklin concert orchestra; 7, Uncle Wip's bedtime story and roll call.

WIAR, Providence, R. I. (305.9), 10 a. m., housewives Radio exchange, Mrs. Wood; 1:05 p. m., studio program; 7:50, U. S. Army band; 9, Waterman's Points of Progress; 10, musical program.

WJRB, Detroit, Mich. (517), 7 p. m., Jean Goldkette's Petite symphony orchestra; 9, Burroughs hour; 11:30, Jewett Jesters.

WLIT, Philadelphia, Pa. (394.5), 12:02 p. m., daily almanac; Stanley theater organ recital; Arcadia cafe concert orchestra; 2, Arcadia cafe concert orchestra; 2:30, Mary V. Shoop, pianist; 7:30, Dream Daddy's bedtime stories; 8, Lehigh Valley Glee club; 10, Arcadia cafe dance orchestra.

WMCA, New York, N. Y. (340.7), 5:45-6:30, Olcott Vail and his Hotel McAlpin string ensemble; 6:30-7:30, Ernie Golden and his Hotel McAlpin orchestra; 8-9, services, Northminster Church; 9:45-10, talk, W. Curtis Nicholson; 10-11, Andy Ascutto's Paragon dance orchestra; 11-11:30, Hofbrau Haus entertainers; 11:30-11:45, Jack Smith, whispering baritone.

WNYC, New York, N. Y. (526), 6:10-6:20 p. m., market high spots; 6:20-6:30, piano selections; 6:30-7, elementary Spanish lessons; V. H. Berlitz; 7-7:30, advanced Spanish lessons, V. H. Berlitz; 7:30-7:35, police alarms; 7:35-8:15, dance program; 8:15-10:10, studio program; 10:10-10:30, health talk, George A. Keane; lecture service, board of education; 10:30-10:35, police alarms and weather forecast.

WOR, Newark, N. J. (405.2), 6:15-6:17 p. m., "Words

Index to Classical Concerts

TABULATED below is a time table of the stations giving classical concerts this week. Stations are divided into the four different standard times in use. The hours are given in the kind of time in use at each listed station. By using this table as an index and referring to the complete programs below, full information will be obtained.

Classical

SATURDAY, NOVEMBER 14

Eastern 6 p. m.	Central 5 p. m.	Mountain 4 p. m.	Pacific 3 p. m.
WCX, WEAF, WMCA, WREO.	6	5	4
KGO, KYW, WEAR, WENR, WMAQ, WNYC, WOAW, WOK, WRC.	7	6	5
KDKA, KFNF, KOIL, KSD, KYW, WBRR, WGN, WMBB, WNYC, WOAW, WQJ.	8	7	6
KFOA, KPRC, KHJ, KYW, WHAS, WIP, WLW, WORD, WSAI, WSOE.	9	8	7
KNX, KYW, WEAF, WMAQ, WMC, WOAW, WOC, WORD.	10	9	8
KGO, WOA.	11	10	9

SUNDAY, NOVEMBER 15

Eastern 8 p. m.	Central 5 p. m.	Mountain 4 p. m.	Pacific 3 p. m.
WCAU.	7:20	6:20	5:20
WCAE, WCAU, WEAF, WEAR, WEEI, WJAR, WTAG, WWJ.	8	7	6
KYW, WBZ, WEAR, WGBS, WGCP, WKAQ, WLS, WORD.	9	8	7
KFDM, KPRC, KSD, WBZ, WCAU, WCBBD, WCCO, WEAR, WGY, WJAR, WHI, WNYC, WQJ.	9:15	8:15	7:15
WEEI, WJAR, WTAG.	10	9	8
KHJ, KNX, KTHS, KYW, WCCO, WFAA, WNYC, WOC, WQJ, WSOE.	11	10	9
KFVE, KHJ, KNX, KPO, KTHS, KYW, WHN, WKRC, WOC.	12 m.	11	10
KHJ, KNX, WOC.	1 a. m.	12 m.	11
KNX.	1 a. m.	12 m.	11

MONDAY, NOVEMBER 16

Eastern 6 p. m.	Central 5 p. m.	Mountain 4 p. m.	Pacific 3 p. m.
KGO, WCX, WEAF, WMCA, WREO, WWJ.	7	6	5
KMA, WCCO, WEAF, WEAR, WHAD, WJR, WOAW, WOK.	8	7	6
KFNF, KSD, WBRR, WBZ, WCAU, WCX, WEAR, WHI, WJAR, WLW, WMBB, WTAG, WTIC.	9	8	7
KFOA, KGO, KHJ, KPRC, WBRR, WCCO, WBZ, WCAE, WEEI, WHAD, WHO, WJAR, WLW, WORD, WOS.	10	9	8
KMA, KPO, KPRC, KSD, KTHS, WCCO, WEAF, WHAD, WJAR, WOAW, WSUI, WTAG.	11	10	9
KGW, KHJ, KMA, KSD, KTHS, KWSC, WHN, WSAI.	12 m.	11	10
KGW, WBAP, WSAI.	1 a. m.	12 m.	11
KHJ.	1 a. m.	12 m.	11

TUESDAY, NOVEMBER 17

Eastern 6 p. m.	Central 5 p. m.	Mountain 4 p. m.	Pacific 3 p. m.
WBZ, WCX, WEAF, WMCA, WREO, WWJ.	7	6	5
KGO, KMA, WEAR, WEBJ, WGBS, WHAD, WJR, WMAQ, WOAW, WOK, WOR, WTIC, WWJ.	8	7	6
KFNF, KSD, KYW, WBZ, WCAE, WCAU, WCX, WEAR, WEEI, WGR, WHAR, WHI, WLS, WMBB, WQJ, WRC, WTIC.	9	8	7

Central Time Stations

CNRV, Winnipeg, Can. (384.4), 7:30 p. m., Aunt Aimee's bedtime story; 8, musical program, Fort Garry hotel; 8:40, Waterhouse string orchestra; 10, Fort Garry hotel orchestra.

KFAB, Lincoln, Neb. (340.7), 8:30-10:30 p. m., Hazel Miller and Frank Carroll, vocal duetists; Belshaw's orchestra; Ralph Hall, banjoist, uke soloist and singer; C. A. Atkins, banjoist; Genevieve Harmer Dart, pianist; Beatrice Ellis, soprano.

KFMX, Northfield, Minn. (337), 9-10 p. m., musical program.

KFNF, Shenandoah, Ia. (266), 7 p. m., mixed program, L. A. Corbin, director.

KFUD, St. Louis, Mo. (545.1), 9:15 p. m., "The Unique Language of the Bible," Prof. O. Boecler.

KFVE, University City, Mo. (240), 8:30 p. m., Paul and Jack Snyder; Orchestra Romaine.

KPRC, Houston, Tex. (296.9), 12 noon, talks and music; 5:30 p. m., Uncle Judd's Kiddies' hour; 7:30, Fatty Martin's End-o'-Main dance orchestra; Mark Westcott, vocalist; 8:30, Ewing Werlein, bass; Margaret Britton, lyric; Mary Louis Britton, accompanist; 11, choir recital.

KSAC, Manhattan, Kan. (340.7), 12:35-1:05 p. m., "Prepare Now for Sweet Clover," E. B. Wells; 4:30-5, football lecture; 6:30-7:30, educational sociology; V. L. Strickland; "The Use of Paint on the Farm," E. C. Graham; "Relation of Power to Agriculture," W. H. Sanders.

KSD, St. Louis, Mo. (545.1), 7 p. m., Benjamin Barber's orchestra.

KTHS, Hot Springs National Park, Ark. (374.8), 9-9:45 p. m., Meyer Davis string quartet; ensemble, Lon Chassy, director; 9:45-1, novelty program, Como Al Reynolds, comedian; 10-10:15, jazz singing, piano

Eastern 9 p. m.	Central 8 p. m.	Mountain 7 p. m.	Pacific 6 p. m.
KFDM, KFOA, KGO, KHJ, KLDL, KYW, WCAE, WCBBD, WCCO, WEAF, WEEI, WGR, WHAS, WJAR, WLW, WMAQ, WOC, WORD, TAG.	9	8	7
KFAB, KFDM, KFMO, KMA, KNX, KPRC, KTHS, WCAE, WCCO, WEAF, WEAR, WEEI, WLW, WMCA, WOC, WSAI, WSOE, WTAG.	10	9	8
KO, KHJ, KMA, KYW, WSAI.	11	10	9
KPO, KYW, WHO, WMC.	12	11	10

WEDNESDAY, NOVEMBER 18

Eastern 6 p. m.	Central 5 p. m.	Mountain 4 p. m.	Pacific 3 p. m.
WCX, WEAF, WMCA, WREO, WWJ.	7	6	5
KGO, WEAR, WHAD, WJR, WMAQ, WOK, WTIC.	8	7	6
KFNF, KPRC, KSD, KYW, WBZ, WCX, WEAF, WEEI, WHT, WLW, WMBB, WMCA, WQJ, WTAG, WWJ.	9	8	7
KFOA, KGO, KPRC, KSD, KYW, WBZ, WCCO, WDAF, WEEI, WGR, WHAD, WHAS, WJAR, WMAQ, WOR, WOS, WORD.	10	9	8
KFMX, KMA, KNX, KTHS, WCCO, WEAF, WEEI, WGR, WHAD, WJAR, WLS, WMAQ, WNYC, WOC, WSOE.	11	10	9
KGO, KGW, KMA, KPO, KTHS, WCAE, WLS, WLW, WOC, WSAI.	12 m.	11	10
KGW, KPO, WHAD, WLW.	1 a. m.	12 m.	11
WLW.	1 a. m.	12 m.	11

THURSDAY, NOVEMBER 19

Eastern 6 p. m.	Central 5 p. m.	Mountain 4 p. m.	Pacific 3 p. m.
WBZ, WCX, WEAF, WIP, WMCA, WREO, WWJ.	7	6	5
KGO, KSD, WEAF, WEAR, WGBS, WHAD, WJR, WMAQ, WOAW, WOK, WWJ.	8	7	6
KYW, WBRR, WBZ, WCAU, WCCO, WCX, WEAR, WEEI, WGR, WGY, WHAR, WHI, WLS, WLW, WMBB, WOAW, WQJ, WTAG, WTIC.	9	8	7
KHJ, KLDL, WBAP, WCAE, WCAU, WCBBD, WCCO, WEAF, WEEI, WGR, WHAR, WHAS, WJAR, WNYC, WOC, WORD, WRC, WASI, WSB, WTAG.	10	9	8
KNX, KPRC, KTHS, KYW, WGR, WGY, WHAD, WMC, WOAW, WOC, WSAI.	11	10	9
KGO, KPO, KTHS, WBAP, WKRC.	12 m.	11	10
KGW, KPO, WHO, WKRC.	1 a. m.	12 m.	11

FRIDAY, NOVEMBER 20

Eastern 6 p. m.	Central 5 p. m.	Mountain 4 p. m.	Pacific 3 p. m.
KGO, WCX, WMCA, WREO, WWJ.	7	6	5
KGO, WEBJ, WGY, WHAD, WJR, WMAQ, WOAW, WOK, WOR, WTIC.	8	7	6
KYW, WAHG, WBZ, WCAU, WCX, WEBJ, WEEI, WHT, WLS, WQJ, WTAG, WTIC, WWJ.	9	8	7
KFDM, KFNF, KFOA, KGO, KHJ, KSD, KYW, WBAP, WBZ, WCAU, WDAF, WEEI, WHAD, WHAS, WJAR, WMAQ, WMCA, WOS, WSAI, WTIC.	10	9	8
KFAB, KFDM, KOA, WCCO, WHAD, WMAQ, WNYC.	11	10	9
KFMX, KHJ, KNX, KPO, KWSC.	12 m.	11	10
KPO.	1 a. m.	12 m.	11

solos, Pauline Simpson; 10:15-10:45, Southerners' dance orchestra.

KYV, Chicago, Ill. (536), 11:35 a. m., table talk, Mrs. Anna J. Peterson; 1-2 p. m., Coon Sanders Original Nighthawks; 6:35-7, Uncle Bob; 7-7:30, Congress hotel; 7:35, talk, Vivette Gorman; 7:45, safety first talk; 8-9, Congress hotel; 10-12:30, midnight revue; Earl Ash and his orchestra; 1-2, insomnia club, Coon Sanders Original Nighthawks.

WAND, Minneapolis, Minn. (243.8), 12 m., Jim McDonough, Emory White, Armella O'Brien, George Geize, Thelma Wilson; 7 p. m., Jack Malerick, organist; Garrick theater symphony orchestra; Alice O'Reilly, contralto; Marion Berthold, contralto; Stella Reed, accompanist; Olympian trio; Adeline Wagner, soprano; Donald Mensin, violinist; 8, Land O'Lakes quartet; 11, Skyrocket frolic.

WBAP, Fort Worth, Tex. (475.9), 12:50-12:30 p. m., Duke Vance, pianist; Gerold Stewart, banjoist; 6:30, Texas Hotel Tokio Royals; 7:30-8:30, Panther Hawaiian trio; 9:30-10:45, Texas Hotel Tokio Royals.

WBBM, Chicago, Ill. (226), 4-6 p. m., Valentino Inn orchestra; 8-10, Sunset male quartet; Jordan and Jeske, William Molnare, tenor; Ted Coleman, cellist; Burdette Cleveland, contralto; Merry Garden orchestra; accordionist; Montmartre orchestra; Charlie Garland, Nate Caldwell, Uler and Farwell, Harry Sosnick, Sandy Meek.

WCAL, Northfield, Minn. (337), 9:45 a. m., St. Olaf college chapel services.

WCCO, Minneapolis-St. Paul, Minn. (416.4), 10:45 a. m., home service talk, Betty Crocker, "Thanksgiving Dinner Made Easy"; 6:30, flour, feed, fax markets, Capt. A. F. G. Raikes; 6:45, talk, Carey Emerson; 7, Midwest church service, First Evangelical church; 8, program WEAF; 10:05, Emmet Long's Golden Pheasant orchestra; 11:30, Eddie Dunstetter, organist.

WDAF, Kansas City, Mo. (365.6), 10:45 a. m., Betty Crocker Gold Medal Flour home service talk; 3:30-4:30, Star's string trio; 6-7, address, speaker, Health Conservation association; address, Ralph E. Herrick; Tell-me-a-story lady; Trianon ensemble; 8-9, Star's Radio string orchestra; 9-10, Dutch Master musical program; 11:45-1, Plantation players; Eddie Kuhn's Kansas City Athletic club orchestra; Earl Coleman's orchestra.

WEBH, Chicago, Ill. (370.2), 7-8 p. m., orchestra; Florence Behrend, soprano; 9-10, orchestra; 11-1 orchestra; artists; Oriole orchestra.

WFAA, Dallas, Tex. (475.9), 12:30-1 p. m., Sears-Roebuck Agricultural Foundation program.

WGS, Oak Park, Ill. (250), 5-7 p. m., Betty Bebb and Helen Cameron, vocal duo; McDewitt sisters; pianists; Tiffin theater organ and orchestra; 8-9, Ethel Giese, soprano; Ruth Kalthoff, contralto; Peter Mathews, bass; John Stamford, tenor; Tiffin theater organ and orchestra; 11-1 a. m., Philips twins, vocal duo and ukulele soloists; Tiffin theater organ and orchestra; Serenaders; Morris Hoffman, tenor.

WGN, Chicago, Ill. (370.2), 12:40 p. m., Drake concert ensemble, Blackstone string quintet; 2:30, Lyon & Healy; 3:30-4:15, tea time music, Marshall Fields tea room orchestra; 6:30-7, Drake concert ensemble, Blackstone string quintet; 8-9, Tribune string trio; 10-11, Jack Chapman's and Blackstone hotel dance orchestra.

WHAS, Louisville, Ky. (399.8), 4-5 p. m., Music Box; readings; 7:30-9, Sylvian trio.

WHO, Des Moines, Ia. (526), 6:30-7:30 p. m., Reese-Hughes orchestra; 7:30-9, Santa Claus; quartet; Harry Armigido and Robert Robertson, banjoists; Kate Miller, whistler; 9-11:30, dance program.

WHT, Chicago, Ill. (399.8), 6-7:30 p. m., classical program; Pauline Sachs, soprano; Oscar Heather, tenor; Al Carney, organist; Grayling's string trio; (238), 7:45-9:15, musical features; (399.8), 9:30, request organ recital; Hickey and Johnson, harmony boys; Carl Strodel, baritone; Marie White, soprano; Leota Laabs, soprano; Al Carney, organist; 12, Pat Barnes, "Your Hour League," Al Carney.

WJAD, Waco, Tex. (352.7), 8:30-10 p. m., Methodist Home entertainers; popular music, orchestra.

WJD, Moseheart, Ill. (302.8), 10 p. m., Marie Dumke, Mrs. Leo Peltzer, Dorothy Nierengarten, Georgia N. Haines; 12, George Sparks, Purple Grackle orchestra.

WKRC, Cincinnati, O. (326), 8 p. m., book review, Alice B. Coy; 8:15, Marion McKay and his Swiss Garden orchestra; 8:45, popular songs; 9:15, Marion McKay's Swiss Garden orchestra.

WLS, Chicago, Ill. (344.5), 6:30 p. m., organ concert, Ralph Emerson; 7, lullaby tune, Ford and Glenn; 7:15, WLS string trio; 7:35, Gladys Welforth, contralto; 7:45, WLS theater; 8:15, Alice LaTart, pianist; 8:30, Westminster quartet; 9, Harmony Zither and Mandolin club; 9:30, Jimmie Westbrook, tenor; 9:40, New Music hour; 10:40, Ford and Glenn time; 11, Ralph Emerson, organist.

WLW, Cincinnati, Ohio (422.3), 7:30 a. m., morning exercises; William Stradtman, Y. M. C. A.; 7:45, morning devotion, auspices Parkway Y. M. C. A.; 12:15, musical program, Irene Downing; 3:30, American Educational week program; 4, "Shut-Ins" program, Mr. and Mrs. Wm. Duning directing, assisted by Cincinnati quartet; 7, dinner hour concert, Hotel Gibson, Robert Visconti, director; 7:50, talk, representative of the Brookline Economic Service; 8:15, first concert of the season, College of Music orchestra, Adolph Hahn, conductor; soloists, Herbert Newman, organist, Dorothy Stolzenback, pianist; Ronald McFarland, flutist; Mrs. Stanley McKie, soprano; 9:15, program, "Dutch Club," Dayton Ohio H. V. Lytle, director; Chas. Gidway, pianist; 10, third in a series of "Pep" concerts, Fraternities from University of Cincinnati, arranged by Alpha Chi Chapter of Pi Kappa Alpha; 10:30, recital, George Conyer, tenor; Prof. Henry C. Lersch, accompaniment; The Crosley Salon orchestra; 11:15, organ features, Johanna Grosse, pianologues; "Newport," Carl Bamberg.

WMAQ, Chicago, Ill. (447.5), 12:45 p. m., Radio Farm school; 1, Chicago Association of Commerce luncheon; 2 shut-in program; 4, Cosmopolitan School of Music; 4:30, Red Cross talk; 6, Chicago theater organ recital; 6:30, Georgene Faulkner, story lady; 8, lecture, Northwestern university; 8:30, Elsa Kressman, soprano; 9, WMAQ plays.

WMBB, Chicago, Ill. (250), 7-8 p. m., Trianon duo; Beatrice Tebler, Genevieve Burnham; Ralph Elliott, Marie Caruso; 9-11, Trianon orchestra; Woodlawn theater orchestra; Lionel Carter, Bob Wilson, Harry Davis, Billie Allen Hoff, Jimmy Eggert, Marquette banjo four; Charles Agne.

WOAI, San Antonio, Texas (394.5), 3 p. m., musical program, Radio Trades association; 8:30-9:30, Army night musical program.

WOAW, Omaha, Neb. (526), 5:40 p. m., Val McLaughlin.

WOC, Davenport, Ia. (483.6), 12:15-12:25 p. m., Dairy Day; "Our Experience in Line Breeding," Prof. H. P. Davis; 3-3:30, home management, Aunt Jane; 4-4:45, juvenile musicale; 5:45-6, chime concert; 6:30-6:50, Sandman; 9-10, Ipana Troubadours, WEAF; 10-11, musical program; Erwin Swindell, organist; Harold Puls, baritone.

WOL, Ames, Ia. (270), 12:30 p. m., college chimes; 12:45, "Poultry Husbandry," questions and answers, Prof. H. A. Bittender.

WOK, Chicago, Ill. (217.3), 12-2 p. m., Harold Morava, tenor; Jean Carlson, soprano; Banks Kennedy, organist; Bob McKrejs, pianist; WOK male quartet; Gus C. Edwards and his orchestra; 5:30-7, Ed Kemp, tenor; Bryce Talbot, baritone; Banks Kennedy, organist; Bob McKrejs, pianist; WOK string trio; Gus C. Edwards and his orchestra; 10-11, Ned Miller, tenor; Rita McFawn, soprano; Herman Sinalko, violinist; Harriet Lee, contralto; Harold Morava, tenor; WOK male quartet; Charles Lord, tenor; Henry Byler, tenor; Jack Keyes, baritone; Norman Bartlett, bass; Banks Kennedy, organist; WOK string trio; Gus C. Edwards and his orchestra.

WRB, Batavia, Ill. (275), 8 p. m., Webster hotel concert trio; 8:15, hymns and sacred songs, I. B. S. A. choral singers; 8:30, Bible lecture, D. J. Morehouse; 8:50, sacred solos and duets; 9, Education week address.

WOS, Jefferson City, Mo. (440.9), 8 p. m., "Europe as I Saw It," George W. Reavis; musical program, Lincoln university.

WQJ, Chicago, Ill. (447.5), 11-12 noon, home economics program, Harrington Downing; "Fish Dinner," Frank Wendt; "The Middle-aged Woman,"

(Continued on page 19)

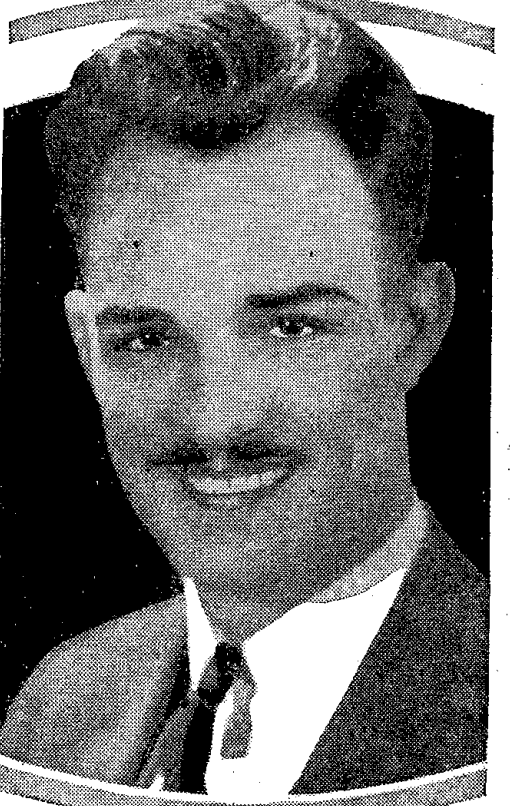

WBAP has a new baritone to offer the invisible audience this winter. Victor B. Acers, graduate of the New England Conservatory of Music, has traveled to the Lone Star state where he will give his first recital at WBAP Monday, Nov. 16.

SPELLING BEE WILL BUZZ AT WLIT

Wednesday, November 18

(Continued from page 18)

Dr. Bertha Van Haasen; 3-4 p. m., "New England Recipes," Helen Downing; "Traditional Recipes," Martha Logan; 7-8, dinner concert, Ralph Williams and his Rainbo Gardens orchestra; Sophie Lobel, concert pianist; Clement Laskowski, tenor; 10-1 a. m., Ralph Williams and his Rainbo Skylarks; Maria Dneprova, Russian soprano; Melodians; Esther Trostrud, mezzo-soprano; Clarence Theders, tenor; Sandy Meek, Scotch tenor; Harry Sosnick, pianist; J. Edwin Peterson, basso; Joey Stool, tenor; artists; 1-2, Ginger hour.

WSAI, Cincinnati, Ohio (325.9), 7:45 p. m., art talk, Cincinnati Art club; 10, Congress Playing card string quartet; 11, popular program.



July Four; 9, musical program; 10, Goodrich Zippers. WJZ, Detroit, Mich. (517), 7 p. m., Jean Goldkette's Petite Symphony orchestra; 9, Jean Goldkette's Serenaders; 10, Jean Goldkette's Victor Recording orchestra.

WLIT, Philadelphia, Pa. (394.5), 12:02 p. m., daily almanac; Stanley theater organ recital; Arcadia cafe concert; orchestra; 2, Arcadia cafe concert; orchestra; 2:30, Schumann concerto in A Minor; Marcella North and Frances Babcock, pianists; 7:30, Dream Daddy's bedtime stories.

WLWL, New York, N. Y. (288.3), 9 p. m., Dorothy McDonough, soprano; WLWL trio; Bernard Mintz, tenor; "Marriage and Divorce," Msgr. McMahon, organ recital.

WMCA, New York, N. Y. (340.7), 6-6:30 p. m., Olcott Vail and his Hotel McAlpin orchestra; 6:30-6:45, Robert Soffer, pianist; 7-7:30, Joe Chappello's Sunny-side orchestra; 7:30-8, Lanson's orchestra; 8-8:30, "Hale and Hearty"; 10-10:15, "How to Drive Automobiles," Harry Rainess; 11-12, Ernie Golden and his Hotel McAlpin orchestra.

WNYC, New York, N. Y. (526), 7-7:10 p. m., market high spots; 7:10-7:30, dance program; 7:30-7:35, police alarms; 7:35-8, dance program; 8-10:10, studio program; 10:10-10:30, talk, Dr. Sydney N. Lusher; lecture service, board of education; 10:30-10:35, police alarms and weather forecast.

WOR, Newark, N. J. (405.2), 6:15-6:17 p. m., "Words Often Mispronounced," Man in Moon; 7-7:15, sports talk, Bill Wathey.



Mabel Garrison, operatic soprano, center, who was scheduled to sing several weeks ago, postponed her appearance at WEAJ and chain until this Sunday, November 15. She is the guest artist on the Atwater Kent hour. William L. Widdemer, left, gives the interesting literary appreciations over WGY, Schenectady. His talk Monday will be about John Burroughs. Right, Adelaide Timereck's melodious voice is a regular feature of WGES, Chicago.

WSB, Atlanta, Ga. (428.3), 10:45 p. m., Biltmore salon orchestra.

WSOE, Milwaukee, Wis. (246), 5:30 p. m., twilight hour, Aunt Julie, children's stories; Elmer Burke, pianist; Van Buren's Hawaiians; 8:30, travelogue talks, "Twice Travelled Tommy"; 9, musical selections, talks.

WSUI, Iowa City, Ia. (483.6), 9-9:30 a. m., high school assembly program; 12-12:30 p. m., Dorothy Marshall, violinist; "Hunting Sea Lions with Quillagute Indians at La Push," Prof. Homer R. Dill; 7:45-8:45, college of the air lectures.

Mountain Time Stations

KFWA, Ogden, Utah (261), 5-6 p. m., Ogden Radio dealers' program; 9-10, studio program; 10-12, Olie Reeves and his orchestra.

KOA, Denver, Colo. (322.4), 12:15 p. m., Rialto theater musicale; 6:30, dinner concert, Brown Palace string orchestra, Howard Tillotson, director; 7:30, Book of Knowledge; 8, selections from famous oratorios, Brighton (Colo.) Municipal Choral society, John Henry Bodkin, director; J. O. Carr, accompanist; miscellaneous vocal numbers, Civitan trio; 10, Harmony Peerless dance orchestra.

Pacific Time Stations

KFOA, Seattle, Wash. (454.3), 6:45-8:15 p. m., Hopper Kelly company; 8:30-10, Times studio program.

KFPG, Hollywood, Calif. (236), 5-6 p. m., home hour, Mammy Simmons; 6-7, dinner music, Olga Trumbull trio; 7:30, Miss Nancy of the Bookshelf; 8-10, KPFG concert hour, Turner orchestra, direction Loren Powell; Tom Mitchell, baritone.

KFWB, Hollywood, Calif. (252), 5-6 p. m., children's hour, Big Brother of KPWB; 6:30-7, Altadena program presented by E. P. James; 7-7:30, Mutual Motors mirth contest; 7:30-8, microphone brevities; 8-9, program, Check Neal Coffee Co., Maxwell House Coffee; 9-10, program, Western, Western Pacific Securities company of Santa Monica; 10:11, Warner Brothers frolic; 11-12, Henry Halstead and his Hollywood roof orchestra.

KGO, Oakland, Calif. (361), 8:45 a. m., inspirational songs, Mme. Etirelda Wynee; 11:30-1 p. m., luncheon concert, Pacific States Electric company; 3-4, American Education week, speaker, Cora L. Williams; "Right Teachers for the Right Schools," folk songs, Dorothy Williams, soprano; May C. Williams, accompanist; 4-5:30, concert orchestra, Hotel St. Francis; 6-7, Norman Woodside's Metropolitan orchestra.

KGW, Portland, Ore. (491.5), 12:30-1:30 p. m., Rose City trio; 8-9, concert; 10-11, concert, Sherman, Clay and company.

KHJ, Los Angeles, Calif. (405.2), 6-6:30 p. m., Leighton's Arcade cafeteria orchestra, Jack Cronshaw, leader; 6:30-7:30, history story, Prof. Hentzen; Dick Winslow, juvenile reporter; McBan screen juvenile, Roland Pendleton, saxophonist; 8, Dr. Mars Baumgardt, scientific lecturer; 8:30-10:30, program, Broadway department store, arranged by J. Howard Johnson; 10:30-11:30, Art Hickman's Biltmore hotel dance orchestra, Frank Mills, leader.

KLX, Oakland, Calif. (508.2), 4-5 p. m., women's hour; 5-5:30, Aunt Elsie's Irate Pirate for children; 8-9:10, educational program; 9:10-10, program, Olin S. Grove Radio stores; 10-11:30, Sweet's ballroom, Harry Davis and his entertainers.

KMX, Hollywood, Calif. (336.9), 5:30-6:15 p. m., Wurlitzer pipe organ studio, Town Tattler; 6:15, travel talk, W. P. Alder; 6:30-7, Atwater Kent Radio orchestra, Paul Finstien, leader; 7-8, Ambassador hotel concert orchestra; Josef Rosenfeld, director; 8-9, program, Security Trust and Savings bank; 9-10, program with a kick, Hercules Gasoline company; 10-11, dance music.

KPO, San Francisco, Calif. (428.3), 7-7:30, 8 a. m., daily dozen exercises; 10, sewing talk; 1-2 p. m., Rudy Seiger's Fairmont orchestra; 2:30, school talk; Hawaiian music, Duke Kamoku and his Royal Hawaiians; 3:30, fashion talk; 5:30-6:15, children's stories, Big Brother; 6:40-7, Waldemar Lind and the States Restaurant orchestra; 7-7:30, Rudy Seiger's

Fairmont hotel orchestra; 8-9, Atwater Kent artists; 9-10, Goodrich Silvertown Cord orchestra; 10-11, Waldemar Lind and States Restaurant orchestra.

KWSC, Pullman, Wash. (348.6), 7:30 p. m., Margaret Wagner, reader; saxophones, Ed Chittendon, Bob Chittendon, Vincent Hiden; George Hunt, banjoist; Raymond Howell, violinist; Howard Darst, vocalist; "Is Anyone Too Old to Learn?" Dr. F. V. Nadler; "Pasteurization," E. V. Ellington.

Thursday, November 19

Headliners Today			
Eastern	Central	Mountain	Pacific
8:30 p. m. 7:30 p. m.	6:30 p. m.	5:30 p. m.	5:30 p. m.
KDKA (309.1) Famous composers.	6	5	
WJAR (305.9) Honolulu four.	8	7	6
WBZ (333.1) Rigoletto, opera.	9	8	
WJZ (455) President Coolidge.	8:15	7:15	6:15
WSB (428.9) Footlight frolic.	8:30	7:30	6:30
WTIC (475.9) President Coolidge.	9:30	8:30	7:30
WIP (508.2) Fraternity night features.	10	9	8
KPRC (296.9) Girls' Musical club.	10	9	8
WBAP (475.9) Whistler.	10	9	8
WCAU (278) Musical Chets.	10	9	8
KDKA (309.1) Midnight revue.			
KGO (361) "The First Year," comedy.			
KHJ (405.2) Fitzgerald Music company program.			

Thursday, silent night for: CHIC. CKNC. CNRA. CNRE. CNRW. CNRR. CNRT. CNRV. CNRW. KFAB. KFAU. KFDM. KFMO. KFMY. KFOA. KFRU. KFUD. KFVE. KFWA. KGW. KLX. KOA. KOB. KTCL. KWSC. PWX. WAFD. WAHG. WCEE. WEBJ. WGPC. WHAD. WHAZ. WIAD. WIJD. WLIT. WOAI. WOR. WOS. WSM. WSUI. WTAM.

Eastern Time Stations

CNRM, Montreal, Can. (411), 8:30 p. m., studio program; Markowski trio; Lucien Labelle, cellist; Oscar O'Brien, pianist.

KDKA, Pittsburgh, Pa. (309.1), 6:15 p. m., KDKA Little symphony orchestra; 7:45, current events, Dr. Elmer D. Graper; 8, farm program; 8:30, "Peter Rabbit Tschalkovsky," Richard Kountz, KDKA Little symphony orchestra; J. Lloyd Mahony, baritone; 9, KDKA Little symphony orchestra; Bradlock male quartet; 11, Pittsburgh Post midnight revue.

WAHG, Richmond Hill, N. Y. (315.6), 12-12:55 p. m., musical program.

WBRR, New York, N. Y. (272.6), 8 p. m., Carl Park, violinist; 8-10, Herald male quartet; Sunday school lesson; Herald male quartet.

WBZ, Springfield, Mass. (333.1), 6:30 p. m., announced; 7-05, Backgrounds of English literature course; "Odinism," Old English religion; 7:30, Hotel

Kimball dance orchestra, Bob Patterson, director; 8, musical program, Noyes Buick company; 9, evening of opera, "Rigoletto," Madame Vinello-Johnson; 10:05, program, William Anderson.

WCAU, Philadelphia, Pa. (278), 6:30 p. m., Billy Hayes and his Cathy Tea garden orchestra; 7:30, Snellenburg symphony orchestra; 8, recital; 9, Barry O'Moore, Irish tenor; 9:15, Central Radio sycopators; 9:30, musical chefs; 10, Sesqui centennial hour.

WGX, Detroit, Mich. (517), 2 p. m., news and markets; 6, dinner concert, Book-Cadillac hotel; 8, musical program.

WEAF, New York, N. Y. (491.5), 4-5 p. m., musical program; 6-7, dinner music, Waldorf-Astoria; 7-11, services, Greater New York Federation of churches; Cushman's serenaders; the Larkinites; talk, George Elliott Cooley; the Silvertown Cord orchestra; 11-12, Vincent Lopez and his orchestra.

WEAO, Columbus, Ohio (293.9), 9 p. m., chimes; "Soils," Prof. Bear.

WEEI, Boston, Mass. (348.6), 1 p. m., assembly luncheon; 3, Jay Risenman and his orchestra; 5:30, Joe Herman and his Terrace Garden orchestra; 7, Big Brother club; 7:45, talk; 8, WEAJ, Larkinites, Goodrich Zippers.

WGBU, Fulford-by-the-Sea, Fla. (278), 6:30-7:30 p. m., Blue Steele's orchestra; 10-1, Blue Steele's Fulford-by-the-Sea orchestra; Theresa Horn, pianist.

WGCP, New York, N. Y. (252), 8:15 p. m., Elvira Rosa Geiger, pianist; 8:15-8:30, Bobby Grey songs; 8:30-4:15, Bill Mendez, orchestra; 4:15-4:45, studio program; 4:45-5, Sylvia Schatz, pianist.

WGHF, Detroit, Mich. (270), 16 p. m., midnight mariners.

WGR, Buffalo, N. Y. (319), 2:30-4:30 p. m., WGR's afternoon program; 6:30-7:30, Vincent Lopez, Hotel Statter dance orchestra; Harold Gieser, director; 8-11, jointly with WEAJ, including the Larkinites and Goodrich program.

WGY, Schenectady, N. Y. (379.5), 2 p. m., "Survey of Sociology—The Principles of Balance," "Vitamins in Canned Food," Dr. Edith Nason; 6:30, Ten Eyck concert trio; 7:30, WGY book chat, William F. Jacob; 7:45, William A. Fay, baritone; 7:50, "Conservation and Thrift Day," Dr. A. R. Brubacher; 8, 10, 8, Army band; 9, address, President Coolidge; 10, Royers, hour, Royal Salon orchestra; 11:30, Stephen E. Bolsclair, organist.

WHAR, Atlantic City, N. J. (275), 2 p. m., Seaside hotel trio; 7:30, health talk; Dr. Henry Reik; 8, Seaside hotel trio; 9, studio concert.

WHN, New York, N. Y. (361.2), 12:30-1 p. m., Lexington organ recital; 3:15-4:30, Lexington orchestra; 7-7:30, Iceland orchestra; 7:30-8, Kennedy's quintet; 8-8:30, Will Oakland's Chateau Shanley; 8:30-9, 8-8:30, entertainment; 9-9:20, Jimmy Clarke and his entertainers; 10:30-11, Club Kentucky orchestra; 11-11:30, Swane, club orchestra; 11:30-12, Rodeo club orchestra; 12-12:30, Ted Lewis and his orchestra.

WIP, Philadelphia, Pa. (508.2), 10 a. m., menu, Mrs. Anna B. Scott; 1 p. m., Gimbel tea room orchestra; 3, Combs conservatory of music; 6:05, Pagoda cafe orchestra; 7, Uncle Wip's roll call; trombone solo, Ellsworth Felton; 8, Sesqui-centennial, talk, Hon. Harry A. Mackey; 8:15, services, United Synagogue of America; 9, talk, member, Philadelphia Board of Education; 9:15, Fraternity night features; 10:05, Joe Ray and the California Nighthawks.

WJAR, Providence, R. I. (305.9), 1:05 p. m., Joe McNamara and his Twin Elm orchestra; 8, Hono-

WPG, Atlantic City, N. J. (299.8), 1:30 p. m., Hotel Morton Luncheon music; 4:30, Chalfonte Haddon hall afternoon tea music; 6:30, sports, Billy Rocap; 6:45, Arthur Scott Brook, organist; 7, Hotel Ambassador dinner music; 8, World Wonder Excursions, Alfred James P. McClure; 8:15, concert, Atlantic City Board of Education; William O. Miller, reader; Helen McCoy, soprano; Reinhold Schmidt, baritone; 11, dance orchestra.

WRC, Washington, D. C. (469), 10 a. m., women's hour; WJZ; 12 noon, organ recital; 1 p. m., Hotel Washington orchestra; 7, Lee House trio; 7:45, Smithsonian talk; 8, concert, Army band, William Stannard, band leader; 9-10, annual dinner, Chamber of Commerce, WJZ; address, President Coolidge; 10, Royal Salon orchestra, WJZ; 11-12, Meyer Davis, LeParadis band.

WREO, Lansing, Mich. (285.5), 6-7 p. m., Speed-Wagon serenaders; Gold Standard ensemble; special anniversary program.

WTAG, Worcester, Mass. (268), 8-8:30, Larkinites; WEAJ; 8:30-9, pop concert; 9-10, program, WEAJ; 10-11, Silvertown Cord orchestra.

WTAM, Cleveland, O. (389.4), 12:15-1:15 p. m., popular entertainers; 6-7, Hotel Hollenden orchestra, Carl Rupp, director.

WTIC, Hartford, Conn. (475.9), 6:30 p. m., Hub Restaurant trio; 7:30, "Education in Connecticut," Hon. A. B. Meredith; 7:45, dinner music. "Tonight's Dinner," 12:05 p. m., Jules Klein's hotel Statter orchestra; 3, News orchestra; 6, dinner concert; 8, WEAJ program.

Central Time Stations

KFMQ, Fayetteville, Ark. (298.8), 8 p. m., "Chemistry the Ball Bearing of Progress," Harrison Hale; "Objects of Electrification," W. B. Stitzer; "Food Factors that Influence Every Day Health and Vigor," Emma Johnson; "Educational Principles Underlying the Activities of the Primary School," E. Purnell Wilson; "What Should Be Done with Our District School System?" C. M. Reinebold; "Your Home Town and You—As an Engineer Sees It," B. F. K. Mullins.

KFNH, Shenandoah, Ia. (266), 7 p. m., Ruby family.

KLDS, Independence, Mo. (440.9), 8 p. m., lecture course, Mrs. M. A. Etzenhauser; 8:30, concert, Gertrude Concannon School of Music.

KPRC, Houston, Tex. (296.9), 12 noon, station program; 5:30 p. m., Uncle Judd's kiddie hour; 7:30, Blanchard's dance orchestra; Claude Blanchard, leader; 8:30, Girls' Musical club, varied arts.

KSAC, Manhattan, Kan. (340.7), 12:35-1:05 p. m., "Trends in the Cattle Market," E. A. Stokdyk; "The Farm Shop Equipment," C. K. Shedd; 4:30-5, community civics; 6:30-7:30, music, art; business English, J. O. Faulkner; "The Lure of the Bargain Counter," Alene Hinn; "Making Your Own Equipment," Harriet W. Allard.

KSD, St. Louis, Mo. (545.1), 6:45 p. m., WEAJ chain.

KTHS, Hot Springs National Park, Ark. (374.8), 9-9:15 p. m., organ recital, Louis Culp; 9:15-10, symphonic jazz concert, Meyer Davis orchestra; Clyde Foley and Arthur Cochard, singers; 10-10:40, Louise Bowen, lyric soprano; Eulalia Wylie, contralto; Mrs. J. Manier, violinist; 10:40-11, dance tunes.

KYW, Chicago, Ill. (536), 11:35 a. m., table talk, Mrs. Anna J. Peterson; 12-1 p. m., noon-day concert, Commonwealth Edison company; 1-2, Congress hotel; 2:35-4, afternoon frolic; 6:10-6:30, Commonwealth Edison company; 6:40-7, Uncle Bob; 7:30, Congress hotel; 7:35-7:53, American Farm bureau, "The Place of Boys and Girls Club Work in Agricultural Shows," Henry Helde; "Recent Developments in the Hog Market," E. C. Brown; 8-8:20, "Twenty Minutes of Good Reading," Rev. C. J. Perrini; 8:20-9:15, musical program; 10-12, evening at home program; 1, Innis club.

WAND, Minneapolis, Minn. (243.8), 12 m., Harriet Johnson, soprano; Irving Winslow, violinist; Chuck Johnson; 7, band concert; 10, Earl Bedard, banjoist; Bill Reed, accompanist; Gordon Bowen, saxophonist; R. Bolt, tenor; Merle Fuller, accompanist; Adeline Wagner, soprano; 11, Skyrocket frolic.

(Continued on page 20)

Thursday, November 19

AN EVENING AT HOME WITH THE LISTENER IN CENTRAL TIME

(Continued from page 19)

WBAP, Fort Worth, Tex. (475.9), 12:05-12:30 p. m. "Trail Blazers," Montgomery Ward and company orchestra; 6-8:30, Texas Hotel Tokyo Royals; 7:30-8:30, Samuel L. Ball School of Artistic Piano playing; 8:30-10:45, Harmony club.

Table with columns: Call, Location, Met., Saturday, Sunday, Monday, Tuesday, Wednesday, Thursday, Friday. Lists radio stations and their broadcast schedules.

Sheldon, Jr., organist; 10:45, footlight frolic, Howard theater; backstage bunch.

Mountain Time Stations
CNRC, Calgary, Can. (453.8), 7 p. m., kiddies' bedtime story; Jack Rushton's orchestra; Gladys Webb Foster, violinist; Frank Hays, pianist; Bert Fisher, banjoist; Art Kneeshaw, drummer; Jack Rushton, saxophonist.

Pacific Time Stations
KFGP, Hollywood, Calif. (238), 5-6 p. m., home hour, Mammy Simons and pupils of Carter Weaver; 6-7, dinner music, Olga Trumbull trio; 7:30, talk, Prof. Walter J. McManus of Univ. of Calif.; Southern branch; 8-10, KFGP concert orchestra, direction Loren Powell, Charles Beauchamp, tenor.

Headliners Today
Eastern 7:30 p. m. WFAA (475.9) Six Sassy Synchropters.
Central 5:30 p. m. WJAZ (322.4) "Taming of the Shrew."
Mountain 5:30 p. m. WJAZ (322.4) "Taming of the Shrew."
Pacific 4:30 p. m. WJAZ (322.4) "Taming of the Shrew."

Friday, November 20

Headliners Today
Eastern 7:30 p. m. WFAA (475.9) Six Sassy Synchropters.
Central 5:30 p. m. WJAZ (322.4) "Taming of the Shrew."
Mountain 5:30 p. m. WJAZ (322.4) "Taming of the Shrew."
Pacific 4:30 p. m. WJAZ (322.4) "Taming of the Shrew."

Friday, silent night for: CHIC, CKNC, CNRC, CNRM, CNRO, CNRW, KFMQ, KFRR, KFUD, KGO, KLDL, KOB, KUFM, WAFD, WBBR, WCBP, WEAO, WGBS, WGST, WHAZ, WIP, WKRC, WLW, WLWL, WOR, WRC, WRO, WSAI, WSCI, WTAM.

WCCO WILL FEATURE META BIRNBACH

Friday, November 20

(Continued from page 20)

WGCP, New York, N. Y. (252), 3-3:15 p. m., Ona Welch, pianist; 3:15-3:30, Nat. Osborne and Eddie Meredith, songs; 3:30-3:45, Leslie McLeod, tenor; 3:45-4, William J. Rietz, songs; 4-4:15, Clarence Profit, pianist; 4:15-4:30, Hugo Angelo, tenor; 4:30-4:45, studio program; 4:45-5, Carol de Thomee, pianist; 5-5:45, Littmann's orchestra; 5:45-7, Daddy Winkum; 7-8, Dominion Ginger Ale orchestra; 8-8:15, pianist; 8:15-8:45, Clarence Williams trio; 8:45-9, Shirley Herman, songs; 9-9:15, Ukulele Bob McDonald; 9:15-9:30, Jimmy Flynn, songs; 9:30-9:45, Eva Rothenberg, pianologue; 9:45-10, studio program; 10-11, Strickland's orchestra; 11-11:30, Club Ritz orchestra; 11:30-12, Bob Murphy's entertainers; 12-12:30 Connie's orchestra.

WGHP, Detroit, Mich. (270), 10 p. m., Skylark orchestra and soloist.

WGR, Buffalo, N. Y. (319), 2:30-4:30 p. m., WGR's afternoon program; 6:30-7:30, Clet trio; 8-9:30, Winger's Crescent Park entertainers; 9:30-10:30, program of the Buffalo Arts club; 10:30-11, Hewitt Rubber Company's "Thirty Minutes of Something Different;" 11-1 a. m., Vincent Lopez Hotel Statler dance orchestra, Harold Giesler, director.

WGY, Schenectady, N. Y. (379.5), 2 p. m., Asia club orchestra; 2:30, "Fables of Aesop;" 7, Strand theater orchestra; Floyd H. Walters, organist; 7:30, vocal talk; 7:40, "Know Your School Day;" Dr. George M. Wiley; 7:50, "The Taming of the Shrew;" WGY players; "The Violin Maker of Cremona;" WGY players; 10:30, vocal program, pupils, A. Y. Cornell.

WHAR, Atlantic City, N. J. (275), 2 p. m., Seaside hotel trio; 7:30, talk; 8, Seaside hotel orchestra; 11:15, Strand theater organ recital.

WHN, New York, N. Y. (361.2), 7-7:30 p. m., Club Richman entertainers; 7:30-8, Melody club; 10-10:30, Billy Wynne's orchestra; 10:30-11, Roseland dance orchestra; 11-11:30, Caravan club orchestra; 11:30-12, Alabam club orchestra; 12-12:30, Silver Slipper revue and orchestra.

WIP, Philadelphia, Pa. (508.2), 1 p. m., Gimbel tea room orchestra; 6:05, Benjamin Franklin concert orchestra; 7, Uncle Wip's bedtime story; songs, Mary and Helen Leonard.

WJAR, Providence, R. I. (305.9), 10 a. m., housewives Radio exchange; 1:05 p. m., Woodstock entertainers; 8, Margaret Reid; 8:15, Beethoven quartet; 9, Roxy and his gang; 11, Providence-Billmore dance orchestra.

WJR, Detroit, Mich. (517), 7 p. m., Jean Goldkette's Pettie symphony orchestra; 8, Summerfield and Hecht presentation.

WLIT, Philadelphia, Pa. (394.5), 12:02 p. m., daily almanac; Stanley theater organ recital; Arcadia cafe concert orchestra; 2, Arcadia cafe concert orchestra; 4:30, Marcella North, pianist; 7:30, Dream Daddy's bedtime stories; 8, sports talk; 8:45, championship spelling bee; 10, Morning Glory club concert; Arcadia cafe dance orchestra.

WMCB, New York, N. Y. (340.7), 6-6:30 p. m., Olcott Vail and his Hotel McAlpin string ensemble; 6:30-7:30, Ernie Golden and his Hotel McAlpin orchestra; 7:30-8, educational program; 8:50-9, "The Municipal Housewife;" Fred M. Zittel; 9-10, Hardman hour of music; 11:15-11:45, Donald Flamm, dramatic critic.

WNYC, New York, N. Y. (526), 6:10-6:20 p. m., market high spots; 6:20-6:30, piano selections; 6:30-7, elementary French lessons; 7-7:30, advanced French lessons; 7:30-7:35, police alarms; 7:35-8, resume of meeting; 8, concert of education; 8-9, concert; 9, recitation; A. Russ Patterson; 9:10-9:30, recital, Herman Newman; 9:40-10, Rudolph Joskowitz, violinist; 10-10:30, talk, Prof. J. G. Carter Troop; lecture service, board of education; 10:30-10:35, police alarms and weather forecast.

WOR, Newark, N. J. (405.2), 6:15-6:17 p. m., "Words Often Mispronounced;" 6:17-7:15, dinner music, Hotel Shelton; 7:15-7:30, sports talk, Bill Wathey.

WPG, Atlantic City, N. J. (299.8), 6:45 p. m., Arthur Scott Brock, organist; 7, Hotel Milton trio; 8, educational series, Thomas Barker; 8:15, Atlantic City high school orchestra; 8:55, weekly line of cheer, Mrs. John Kendrick Banks; 9, Hotel Traymore concert orchestra; 10, Jean Wiener, organist.

WRC, Washington, D. C. (469), 10 a. m., women's hour, WJZ; 12 noon, organ recital; 1 p. m., Hamilton hotel orchestra; 5, WRC's Foolish entertainers, George F. Ross and Ellsworth Tompkins; 6, book reviews.

WREO, Lansing, Mich. (285.5), 6-7 p. m., Speed-Wagon serenaders; Gold Standard ensemble.

WTAG, Worcester, Mass. (268), 10:45 a. m., "Food Hints;" Mildred C. Thomas; 12:05-2 p. m., luncheon music, WTAG trio; 8, concert.

WTAM, Cleveland, O. (389.4), 12:15-1:15 p. m., popular entertainers; 6-7, dinner hour music.

WTIC, Hartford, Conn. (475.9), 6:30 p. m., young people's half hour; 7, Emil Heimberger's Hotel Bond trio; 7:15, Margaret Purves, soprano; 8:30, Travelers mixed quartet; Marcus H. Fleitzer, violinist; Mrs. Gertrude McAuliffe, contralto; Spencer Terry, baritone; Russell Besser, tenor; 10, Hotel Bond orchestra; 11:30, popular half hour.

WVJ, Detroit, Mich. (352.7), 7:30-8 a. m., setting-up exercises; R. J. Horton; 9:30, "Tonight's Dinner;" 12:05 p. m., Jules Klein's hotel Statler orchestra; 3, News orchestra; 6, dinner concert; 8, News orchestra, soloists; 9, dance program.

Central Time Stations

KFAB, Lincoln, Neb. (340.7), 8:30-10:30 p. m., Richard Low, Chinese baritone, entertainers; musicale, International Typo Union.

KFDM, Beaumont, Texas (315.6), 8-10 p. m., Magnolia Petroleum company's refinery band.

KFMX, Northfield, Minn. (337), 10-11 p. m., organ recital.

KFNF, Shenandoah, Ia. (266), 7 p. m., religious discussion; 7:30, pipe organ concert.

KFVE, University City, Mo. (240), 8:30 p. m., studio entertained orchestra; Remainder orchestra.

KPRC, Houston, Tex. (296.9), 12 noon, Frank Tilton, boy pianist.

KSAC, Manhattan, Kan. (340.7), 12:35-1:05 p. m., "Future of Legumes for 1926;" L. E. Willough; "Concrete Feeding Floors;" Walter G. Ward; 4:30-5, lesson in color and design; 6:30-7:30, travelog; English literature, G. W. Matthews; "What Business English Is;" H. W. Davis; "Prevention and Treatment of Scarlet Fever;" L. D. Bushnell.

KSD, St. Louis, Mo. (545.1), 7:30 p. m., Joseph Oswald, violinist; Seth Abergh, pianist; 8, Irish program.

KTHS, Hot Springs National Park, Ark. (374.8), 9-9:10 p. m., football results; 9:15-10, novelty program, W. L. Maddox, oldtime fiddler; H. M. Gibson playing auto harp, hand saw, broomstick, guitar; 10-10:40, dance concert, New Arlington hotel orchestra; 10:40-11:10, violin recital, Natalie Brigham Arnoux.

KYW, Chicago, Ill. (536), 11:35 a. m., table talk, Mrs. Anna J. Peterson; 12:05-1 p. m., Commonwealth Edison company; 1-2, Coon Sanders Original Night-hawks; 6:35-7, Uncle Bob; 7-7:30, Congress hotel; 9-10, Commonwealth Edison company; 10-12:30, midnight revue, 1, Insomnia club, Coon Sanders Original Night-hawks.

WAMD, Minneapolis, Minn. (243.8), 12 m., Bob Edlund, banjoist; Cobe Sheffield, pianist; Edna Weese, soprano; 7 p. m., Minneapolis public school hour; 8, U. of Minnesota program; 11, Skyrocket frolic.

WBAP, Fort Worth, Tex. (475.9), 12:05-12:30 p. m., Shelly Lee Alley and his entertainers; 6-6:30, dinner music, Texas Hotel Tokio Royals; 7:30-8:30, Texas Christian university; 9:30-10:45, program, E. T. Ke-hort, whistler.

WBBM, Chicago, Ill. (226), 4-6 p. m., Valentine Inn orchestra; 8-10, Ted Coleman, cellist; Manhattan quartet; Burdette Cleveland, concert pianist; Carl Strobel, baritone; Montmartre orchestra.

WGAL, Northfield, Minn. (337), 9:45 a. m., St. Olaf college chapel services; 8:30 p. m., book talk, George Weida Spohn.

WCCO, Minneapolis-St. Paul, Minn. (416.4), 10:45 a. m., "An Casual Luncheon Dish;" Betty Crocker;



A sweet soprano voice, which carries in spite of its high notes, has been attracting fans to WCCO on Monday nights during the Gold Medal station's dinner hour program. Meta Ashwin Birnbach, above, is the possessor of the lovely voice. She sings with the Gordon Cooke ensemble.

12 m., Dick Long's Dayton trio; 4, readers' club, Mrs. Walter Stevens; 6:15, Biley's St. Paul hotel orchestra; College quartet of St. Olaf; 7:45, farm lecture, "Dairy Farming" lesson V; 8:15, musicale; 9, negro music; 10:05, Arnold Frank's St. Paul hotel orchestra.

WDAF, Kansas City, Mo. (365.6), 10:45 a. m., Betty Crocker series; 3:30-4:30 p. m., Star's string trio; 6-7, piano tuning in number; address, speaker Kansas City Children's bureau; Tell-me-a-Story Lady; Trianon ensemble; 8-8:30, Star's Radio orchestra; 11:45-1, Plantation players; Eddie Kuhn's Kansas City Athletic club orchestra.

WEBB, Chicago, Ill. (370.2), 7-8 p. m., orchestra; recital; 9-10, orchestra; WEBB light opera company; 11-1 a. m., orchestra; stories; artists.

WFAA, Dallas, Tex. (475.9), 12:30-1 p. m., farmers' period; address, Horace Whaling; 3:30-4, Sears-Roebuck Agricultural foundation program; 4:30-5, Woman's hour, book review; 6:30-7:30, Six Sassy Synopaters; 8:30-9:30, Alice Knox Ferguson, pianist; J. H. Smith, singer.

WGES, Oak Park, Ill. (250), 5-7 p. m., Lydia Werner, soprano; John Brown, pianist; Katherine Gray, contralto; Edwin Kemp, tenor; Tiffin theater organ and orchestra; 8-9, Thomas Pappas, accordion; Tiffin theater organ and orchestra; John Stamford, tenor; McDevitt sisters, vocal duo; 11-1 a. m., Remington Welsh, organist; Parish and Ward, Sandy McTavish, Scotch comedian; Bebb and Cameron, duettists; Thomas Pappas, accordionist.

WGN, Chicago, Ill. (370.2), 12:40 p. m., Drake concert ensemble, Blackstone string quintet; 2:30, Lyon & Healy artist series; 3, interior decorating, Walter Murray; 6:30-7, Drake concert ensemble, Blackstone string quintet; 8-9, Tribune string trio; 10-11, Jack Chapman and Blackstone hotel dance orchestras.

WHAS, Louisville, Ky. (399.8), 4-5 p. m., concert; readings, Courier-Journal; Louisville Times editorials; 7:30-9, elite club, Louisville, Jefferson County Children's home.

WHO, Des Moines, Iowa (526), 7:30-9 p. m., colored ladies quartet.

WHT, Chicago, Ill. (399.8), 6 p. m., classical program; Bob York; tenor; Grayling's string; Al Carney, organist; (238), 7:45-9:15, musical features; (399.8), 9:30, Lotis half hour of music; Freddie Whitmer, pianist; Samuel Rowe, tenor; Oscar Heather, tenor; Pat Barnes, tenor; Helen Raulin, pianist; Husk O'Hare's orchestra; 12, Pat Barnes "Your Hour League;" Al Carney.

WIAD, Waco, Tex. (352.7), 8:30-10 p. m., Prof. Kenneth E. Runkel's popular program.

WJJD, Moseheart, Ill. (302.8), 10 p. m., Senator Harold C. Kessinger; Emma Benvenue Butler, Jean St. Anne, Purple Grackle orchestra; 12, midnight organ recital.

WLS, Chicago, Ill. (344.5), 6:30 p. m., Ralph Emerson,

STATIONS IN ORDER OF WAVE LENGTHS USED

Meters Call	Meters Call	Meters Call	Meters Call	Meters Call	Meters Call
215 KTAB	275.3 WJAS	315.6 WAHG	361.2 WHN	406 WBAR	468.5 WRC
217.3 WOK	278 KOIL	315.6 WGBS	365.6 WDAF	410.7 CKAC	475.9 WBAP
226 WBBM	278 WCAU	319 WGR	365.6 WBB	416.4 WCCO	475.9 WTIC
226 WIBO	278 WGBU	319 WSMB	370 CYB	421 KIAF	475.9 WFAA
240 KFVE	278 WOQ	322.4 KOA	370.2 WEBB	422.3 WLW	480 CYL
240 WOAX	280.2 WNAC	322.4 WJAZ	370.2 WGN	422.3 WKRC	483.6 WOC
243.8 WAMD	282.8 WOAN	325.9 WSAI	374.8 KTHS	428.3 WSB	483.6 WSUI
250 WGES	282.8 WSM	330 CYX	379.5 WGY	428.3 KPO	491.5 KGW
250 WMBB	285.5 WKAR	333.1 WBZ	379.5 WHAZ	434.5 CNRO	491.5 WEAF
252 KFWE	285.5 WREO	336.9 KNX	384.4 CKY	434.5 NAA	499.7 WMC
252 WGCP	288.3 KFKX	337 KFMX	384.4 KJR	434.5 CFCN	508.2 KLX
266 KFNF	288.3 WLWL	340.7 KFAB	384.4 WMBP	435 AT9	508.2 WIP
266 WBCN	293.9 KTEB	340.7 WKAQ	389.4 WEAR	440.9 KLDS	508.2 WOO
268 WTAG	293.9 WEAO	340.7 WMCB	389.4 WTAM	440.9 WDFW	516.9 CJCA
270 WGHP	296.9 KPRC	344.6 WCBP	394.5 WFI	440.9 WOS	516.9 WCX
272.6 WBBR	299.8 KFMQ	344.6 WLS	394.5 WLIT	447.5 WMAQ	516.9 WJR
273 KWKH	299.8 KSL	348.6 KOB	394.5 WOAI	447.5 WQJ	526 WHO
272.6 WBBJ	299.8 WPG	348.6 KWSC	399.8 WHAS	454.3 KFOA	526 WNYC
272.6 WFBH	302.8 WJJD	348.6 WEEI	399.8 WHT	454.3 WJZ	526 WOAW
273 WRW	305.9 KTCL	352.7 WWJ	400 PWX	455 KTW	535.4 KYW
275 WHAD	305.9 WJAR	356.9 CFCA	405.2 KHJ	461.3 WCAE	535.4 WHA
275 WHAR	309.1 KDKA	356.9 CKNC	405.2 WJY	467 KFI	545.1 KFUD
275 WORD	315.6 KFDM	361.2 KGO	405.2 WCB	468.5 WCAP	545.1 KSD

organist; 7, lullaby time, Ford and Glenn; 7:15, homecoming program, University of Indiana, Bloomington, Vivian Tripp, director; 9:30, Wallace Bruce Amsharry, "Poet's Corner;" 9:40, WLS string trio; 10, A. W. Youngblood, tenor; Catherine Youngblood, mezzo-soprano; 10:15, Laurel Lou Twelve club minstrel; 10:40, Ford and Glenn time.

WLW, Cincinnati, Ohio (422.3), 7:30 a. m., morning exercises, William Stradman, Y. M. C. A.; 7:45, morning devotions, auspices Parkway Y. M. C. A.; 9, Crosley elementary school program, musical appreciation lesson, Sarah Y. Cline; 9:10, "The Realization of a Childhood Dream;" Asst. Prof. Justice, University of Cincinnati; 9:20, agricultural primer, J. W. Schwab, Purdue university; "A Pig's Experience at an Experiment Station;" 9:25, calisthenics, direction Y. M. C. A.; 12:15, noonday concert.

WMAQ, Chicago, Ill. (447.5), 1 p. m., Radio farm school; 2, shut-in program; 4, talk, pro-school child; 4:30, "Fables of the Moment;" Mrs. Graham Aldis; 5, child life stories; 6, Chicago theater organ; 6:20, Family Altar league; 6:30, Wide-Awake club program; 8, Wisconsin football rally; 9, U. of Chicago; 9:20, Elizabeth Stokes, soprano; 9:45, Christian Endeavor topics.

WMBB, Chicago, Ill. (250), 7-8 p. m., Trianon duo; Beatrice Teller, Frank Bordner, Marie Caruso; 9-11, Woodlawn theater orchestra; Bob Bennett, Stokes and King.

WMC, Memphis, Tenn. (499.7), 8:30 p. m., Atwater Kent Radio corporation; 11, Frolic.

WOAI, San Antonio, Tex. (394.5), 3 p. m., musical program, Kamma's Hawaiians; 8:30, musical program, Menger hotel trio.

WOAW, Omaha, Neb. (526), 12:45 p. m., Sunshine Sunday dinner menu; 1, Gilbert Jaffy and his Little symphony; 5:40, Val McLaughlin; 6, music review, Chester Bronson; 6:30, orchestra; 7:10, sport talk, Ivan L. Gaddis; 9, De Luze program.

WOC, Davenport, Ia. (483.6), 12:15-12:25, special farm service day; 3-3:30, home management, Aunt Jane; 4-5, musical program, Crescent orchestra; 5:45-6, chimes concert; 8-9, musical program, Troy Laundry Machine company band.

WOI, Ames, Ia. (270), 12:30 p. m., college chimes; 12:45, "Agriculture, Economics;" questions and answers, Prof. C. I. Holmes.

WOK, Chicago, Ill. (217.3), 12-2 p. m., Banks Kennedy, organist; Thomas B. Stephenson, tenor; Marianne Powell Babcock, soprano; Elsie C. Stephenson, pianist; WOK male quartet; Gus C. Edwards and his orchestra; 5:30-7, Jean Carlson, soprano; Kenyth Dunn, pianist; WOK string trio; Gus C. Edwards and his orchestra; 10-11, Harry Davis, tenor; Arnold B. Stephenson, musical saw soloist; Harriet Lee, contralto; Herman Sinaik, violinist; Banks Kennedy, organist; WOK string trio; WOK male quartet; Charles Lord, tenor; Henry Byler, tenor; Jack Keyes, baritone; Norman Bartlett, bass; Gus C. Edwards and his orchestra.

WORD, Batavia, Ill. (275), 8 p. m., Webster hotel concert trio; 8:15, Uncle Dan's Radio study club; 8:30, musical program, Episcopal choir, Hammond, Ind.; 9:30, Education Week address, Henry P. Conkey.

WOS, Jefferson City, Mo. (440.9), 8 p. m., "What a Day's Work Reveals;" H. O. Hartwood; "Unfriendly Bacteria and How They Work;" Homer A. Wilson; Versailles music club.

WQJ, Chicago, Ill. (447.5), 11-12 noon, Sunday dinner menu, Ted Wilmes; 3-4 p. m., "The Seventh Lesson in the Domestic Science Course;" Helen Harrington Downs; "The Art of Hanging Pictures;" George U. Garagy; 7-8, dinner concert, Ralph Williams and his Rainbo Gardens orchestra; Lavina Price, pianist; Maude Couse, lyric soprano; Henrietta Nolan, violinist; Eleanor Wasserstrom, whistler; 10-1 a. m., Ralph Williams and his Rainbo Skylarks; West Brothers, Hawaiian guitarists; H. Lucille Long, harmonica player; Eleanor Terry and Marie Pollette; Blues Brothers trio; Melodians; Lean Terrill, baritone; Ed McGinnis, accordionist; artists; 1-2, Ginger hour, Ralph Williams and Little Skylarks.

WSB, Atlanta, Ga. (428.3), 8 p. m., concert; 10:45, concert.

WSOE, Milwaukee, Wis. (246), 5:30 p. m., twilight hour, Aunt Julie, children's stories; Caroline Ramming, soprano; Claudine Clark, pianist; 8:45, "Week End's Best Books;" 9, musical program, Wack's Iver-Johnson mandolin-guitar quintet; S. J. Newton, baritone; N. Barkdoll, declamist; Lucille Melster, violinist; Irma Frankenstein, pianist.

WSUI, Iowa City, Ia. (483.6), 12:30 p. m., William G. Edmondson, Jr., tenor.

Mountain Time Stations

CNRE, Edmonton, Can. (516.9), 7:30 p. m., children's half hour; 8:30-10:30, Gayety club.

KFAU, Boise, Idaho (278), 8 p. m., O. A. C. pep band; U. of I. pep band.

KFWA, Ogden, Utah (261), 5-6 p. m., Ogden Radio Dealers' program; 9-10, Lion Coal company, Ellis Fuel company.

KOA, Denver, Colo. (322.4), 12:15 p. m., Rialto theater musicale; 3:30, housewives' matinee; 4, culinary hints; 4:15, fashion review; 6:30, dinner concert, Brown Hotel string orchestra; 7:30, International Sunday School lesson; 8, two-act melodramatic farce, "Seven Keys to Baldpate;" KOA players; Iris Ruth Payve, director; KOA orchestra.

Pacific Time Stations

CNRV, Vancouver, Can. (291), 8 p. m., address; 8:30, Mrs. James Peter Ferguson, Edith Schact, James Peter Ferguson; "A Sacrifice;" drama; 10:30, Cabaret orchestra.

KFOA, Seattle, Wash. (454.3), 6:45-8:15 p. m., Sherman Clay and company, studio program; 8:30-10, Times studio program; 10-11:30, Eddie Harkness and his orchestra.

KFPG, Hollywood, Calif. (238), 5-6 p. m., home hour, Mammy Simmons; 6-7, dinner music, Olga Trumbull trio; 7:30, "Color Photography;" Charles W. Bean; 8-10, KFPG concert orchestra, direction Loren Powell, David Stuart, baritone.

KWB, Hollywood, Calif. (252), 6:30-7 p. m., Altadena program with Bill Hatch and Ray Kellogg; 7:30, Eye-ogue; 8, Dr. Marshutz; 7:45, microphone brevities; 8-9, program, John Wright, "The Night Tailor, with John Wright orchestra;" 9-10, program, Paralta studios features Ray Bailey's trio; 10-11, Warner Brothers frolic; 11-12, Henry Halstead and his Hollywood roof orchestra.

KGO, Oakland, Calif. (361), 11:10 a. m., Prudence Penny home-making talks; 11:30-1 p. m., luncheon concert; 3-4, violin recital, Rodion Mendelievich; 4-5:30, concert orchestra, Hotel St. Francis; 6-7, Norman Woodside's Metropolitan orchestra.

KGW, Portland, Ore. (491.5), 12:30-1:30 p. m., Rose City trio; 9-10:30, concert, Sherman Clay and company; 10:30-12 midnight, Hoot Owls, Rose City trio; Pantages acts.

KHJ, Los Angeles, Calif. (405.2), 6-6:30 p. m., Leigh-ton's Arcade cafeteria orchestra, Jack Cronshaw, leader; 6:30-7:30, history story, Prof. Hertzog; Richard Headrick, screen juvenile, Bettlemee Pfeifferkorn, singer, Uncle John; 7:30, "Romance of Santa Fe Trail;" Gladys De Witt; 8-10, program, Western Auto Supply company, Western Giant cord orchestra; 10-10:30, Piggly Wiggly Girls string trio; 10:30-11:30, Art Hickman's Biltmore hotel dance orchestra, Frank Ellis, leader.

KLX, Oakland, Cal. (508.2), 4-5 p. m., women's hour; 5-5:30, Aunt Elsie's Irate Pirate for children; 8-10:30, special second anniversary program.

KMX, Hollywood, Calif. (336.9), 5:30-6:15 p. m., Wur-litzer pipe organ studio, Town Tattler; 6:15, travel talk, W. F. Alder; 6:30-7, Atwater Kent Radio orchestra, Paul Binstein, leader; 7-7:30, El Patio Ballroom dance orchestra; 7:30-8, program, Eastern Out-fitting company; 8-9, West Coast theaters by remote control; 9-10, Order of Optimistic Donuts, Davis Perfection Bread Co.; 10-11, Ray West's Cocoanut Grove dance orchestra from Ambassador hotel.

KPO, San Francisco, Calif. (428.3), 7-7:30 a. m., exercises; 12:45 p. m., talk; 1:30-2, Rudy Seiger's Fairmont hotel orchestra; 5:30-6, entertainment for children; 6:30-7, Reg Code's dance orchestra; 7-7:30, coded limericks, S. B. Dickson; 8-11, Palace hotel dance orchestra, Gene James, director.

Radio Digest Illustrated

Published by the Radio Digest Publishing Company, Inc.
510 North Dearborn Street
Chicago, Illinois
Telephones: State 4372, 4373, 4374, 4375

E. C. RAYNER, Publisher

Eastern Office, Park-Lexington Building, 247 Park Ave.,
New York. Telephones: Ashland, 8144, 8145, 8146

Member of the Audit Bureau of Circulations



241
PUBLISHED WEEKLY

SUBSCRIPTION RATES

Yearly in U. S. and Possessions and Canada, \$5.00
Foreign postage, \$1.00 additional. Single copies, 10 cents.

Vol. XV Saturday, November 14, 1925 No. 6

"Starving Composers" Again

EVEN learned college professors and wise newspaper columnists are falling for the "starving composer" propaganda of the American Society of Composers, Authors and Publishers. The following quotation, taken from a column in the Chicago Herald-Examiner, by James Weber Linn, English professor at the University of Chicago, shows how successful the association is in winning uninformed people to their cause.

"The prices of certain commodities are fixed by the government at certain times, because it seems more to the advantage of more people to fix them than to abide by the principle of fair sale in an open market. But that any one commodity, like music, should be singled out for discrimination in this fashion seems to me hopelessly unjust. There are fewer millionaires now among the composers than among the broadcasters. Until the balance tips heavily the other way, I favor abiding by the ordinary principles of justice."

Of course there are fewer millionaires among the broadcasters than among the composers. If the broadcasters were dealing directly with the composers, the men who actually wrote the music, there would be a better chance for higher income tax returns among that group. It is hard for a man to realize big profits from his work if he has to split with a highly organized group of tricky lawyers and high-power propagandists on a ninety-ten basis.

Evidently Prof. Linn is laboring under the impression that every cent of the millions extracted by the music trust from the broadcasters goes directly into the pockets of the geniuses who write the "Mammy" songs. Perhaps for the sake of American music it is well that such efforts are not rewarded as generously as he thinks they are. Nevertheless they do not even receive enough to reward them for the nerve they display in putting their names to such efforts.

"Ordinary principles of justice"—that is the phrase Mr. Linn uses in summing up the case for the starving authors, and that is just what the National Association of Broadcasters is striving for from Congress. Back in 1909 Congress, "singled out music," when it enacted the present copyright law, placing therein a special paragraph having to do with mechanical reproduction, by which is meant phonograph records, piano-player rolls, etc., and the fees that should be paid for use of copyrighted music on each. The aim was to prevent a monopoly, and to fix a statutory payment which would make copyright music available to all mechanical reproducers upon the same terms and conditions. A special provision permits a copyright owner to refuse to release his copyright for mechanical reproduction, thus giving the owner full control of his property. But the law further provides that if the copyright owner releases his copyright (musical composition) to one mechanical reproducer, then he is compelled to release to all others at the rate which the law provides. This law has been in operation for sixteen years and has protected the interests of all parties concerned with fairness and equity, including the public.

All the broadcasters are asking is that the same law be extended to Radio reproduction of the copyright music. They do not want the music for nothing? They want to pay a fair price for it.

Making Radio Programs

DO YOU help make Radio programs? The responsibility for the class of programs is much like the responsibility for what happens in elections—those who vote decide them, and those who do not have no kick coming.

It is so easy to express our appreciation of what we like in programs we hear, and the more we do this the more we vote for that style of program.

Do not give general blanket applause, which loses its real value, but give specific applause to numbers and artists. Blanket applause discourages the exceptionally good and encourages the exceptionally bad, while specific applause pleases the good and discourages the bad.

RADIO INDI-GEST

Radio Barometer

With static bad on frosty nights
You'll often see the Northern Lights.

When piercing squeals assail the ear,
Turn down your tubes, go on low gear.

Some fading often lets you know
A wire is swinging to and fro.

When tuning whistles at you mock,
Another set's within a block.

If lights and signals both "go west,"
You'd better both your batteries test.

GEORGE.

An Ideal Silent Night Program

1. America—by the students of the Bingville Deaf and Dumb school in the sign language.
2. Card tricks by Professor O. Watta Nutte.
3. Juggling of Rubber Balls, by E. Nefer Dropsem.
4. Bareback Riding and High School Horse act, by Lotta Nervino.
5. Heavy Weight Lifting, by Bigga DeMus.
6. Slack Wire Walking, by Ima Birde.
7. Pant-o-mine, "Look at the Fit," by Hart Schaffner and Marks.
8. Closing Chorus, "Hail, Hail, the Gang's All Here," by the Crook County Jail chorus performing before a dead microphone.

CAP.

My Radio Girl

Your voice through the ether
Made me think of an angel.
Your picture in the Radio section
Had a Madonna air about it.
I sought you out and met you.
Now I know that I should have left you
At the microphone.
Off the air you were just like
Any other girl:
Harder to understand than the mysteries of Radio.

PINQUE.

Too bad, Pinque, old chap! We advise you read the professor's articles on Radio. His words are simple and the joys and glooms illustrations are easy to understand. Our experience leads us to believe that it is easier to find the fourth dimension than to find the meaning of the word "because" used by most women in answer to your "why."

Well, Isn't It?

Dear Indi: The girl friend is so dumb she thought the Seaboard Air Line was a Radio broadcasting company.

TWO CIRCUIT JACK

Big boy, if you have ever tried to sleep in a Pullman on that line you would think it had something to do with Radio. The flat wheels remind you of static. The leaky air brakes whistle like an old single-circuit regenerative outfit, and it is never sure of getting any distance.

A Reader's Phew

Dear Mistuh Editor: Specks yer will be sprized ter git dis-but Ise bin reedin yer papuh fer a long time—in fact—when de staticks am 2 bad ter get KDKA or WSAI I jes open up dat Radio digester an enjoys Radio jus de same.

Sho glad dey is goin ter hav a meeting an hep mistuh Hoover clare up de air frum all dis hare in-ter-ferrences. hope sum wize guy sugges sum skeem ter nock de stuffin out uv ole man staticks—an dat sum udder guy will fix it so dat Miss Fade Away will sho nuf fade away an hep us poor fellers down here in Dixie, so we can lissen wid-out havin ter kuss.—an again—ter sugges dat sum uv dem an-nouncers say mo but dont talk so much. . we likes ter hare de stashun call letters mo offen but dat will be bout all cept de nex number on de program. as ever

ZED.

Really, Zed, your letter belongs in the Reader's View column, but we guess we will not miss the space here. The postmark said "Sumter, S. C." We remember that town. Long before we ever heard of Radio we used to cause static there with our cheers, as we went back to Charleston after the annual Thanksgiving game with Carolina.

But Who Pays the Bills?

Dear Indi: I have solved the problem. The missus insists on listening to "Old King Cole" every night and I much prefer to tune in prize fights, bike races, wrestling matches and all that sore of he-man stuff. So to settle it I bought another set. Clever, eh what?

MOUSE.

A bit clever we admit, but why not get a set like ours. You can hear both things at the same time.

RADIO EPITAPHS NO. 2 BY THE THIRD TROMBONE PLAYER

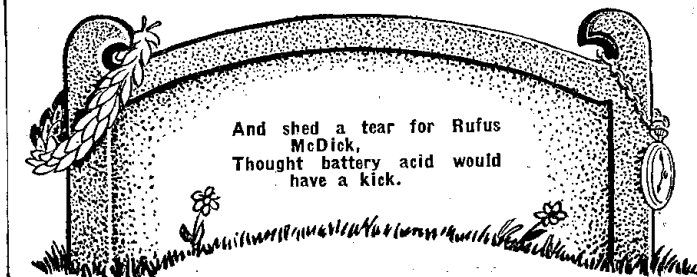

News of the Week

AND NOW, THAT THEY HAVE
REMOVED THEIR "SPECKS"



Condensed

BY DIELECTRIC

One feature of importance came from the studio of WLW, Cincinnati, and while occupying but a small part of the evening's program made a lasting impression upon all who heard. Edgar Guest has made for himself a unique place in the hearts of those familiar with his writings and to hear the man in person read into mike lines of optimism, as few compose them, was something few of us will ever forget. Thanks Crosley station.

Most of us know of a new theater in the city of Chicago, thanks to WEBH, which station broadcasts a portion of the musical program at the theater. We were told of the matchless beauty of this new place of amusement, possibly to encourage trekking from our home towns to view its splendors. I have always contended broadcasting would keep no one from opera, concert, prize fight, or theater who could possibly attend—and the same holds true of church services—but where distance may not be annihilated except by Radio, no possible harm can result from providing amusement or instruction through the air.

WPG, the world's playground station at Atlantic City, offered to organ music enthusiasts a treat as Miss Ringer was introduced to the unseen audience. She chose selections which were light in character for the most part yet admirably suited to her instrument. Her playing disclosed grace and a delightful appreciation of the values of various stops. Whether she, or another, be selected to play this instrument of grandeur it is to be hoped such concerts will continue to feature WPG's programs.

Now we are back on sporting schedules again. Football games are on in earnest with a goodly number of broadcasting stations giving enthusiasts an exciting time following their favorites on the gridiron. If circumstances prevented you from listening to football contests in the afternoon hours, a turn to WSAI, Cincinnati, gave everyone a play-by-play, account of an evening game. It is quite true that some announcers are far more successful in getting their eyes and tongue working together than some others, for it is something of a knack to entertainingly describe what the Radio reporter views before him. Anyway, sport fans are happy.

Station WOR, in Newark, N. J., tried an innovation with more or less success in the broadcasting of bicycle races from the Veledrome in that city. There were motorcycle races, also, in which the attention of the listeners was perhaps greater because of the fact that some notion of speeding vehicles was conveyed by periodic roaring as they raced passed Mike. A lengthy race grows tiresome, though, for the announcer's explanations do not synchronize with the successive passing of each racer.

Appearing for the first time before a mike, Madam Louise Homer, one of America's foremost contraltos, showed no evidences of stage fright in her recital from the studio of WEA, New York, another of the series of superrecitals given the Radio public by Mr. Kent. Others may differ with me when I suggest that the harp is not an instrument ideally suited to broadcasting, despite the fact of being played by so eminent an artist as Mr. de Stefano. Madam Homer made her way into homes where only her name was known prior to this concert, but where she would be most welcome any time she cares to sing to listeners in.

Interesting and Simple Explanation of Radio

Chapter III—How Music Is Converted into Ether Waves

By H. G. Tanner, Associate Professor University of Oregon

THE human ear cannot hear vibrations in the ether no matter what their frequency but it can detect vibrations in the air below 20,000 per second. Most of our music, in fact the great majority of all the sounds we hear are air vibrations whose frequency is below 3,000.

It is not practical to generate ether



The giant in seven league boots carrying the musician on to his destination, presents a good analogy to the carrier (giant) wave in Radio bearing the modulator (musician or sound) wave.

waves at frequencies less than 10,000, and since music requires frequencies below 3,000 the problem of broadcasting music by Radio was not an easy one to solve. Concisely, the feat is accomplished by producing ether waves of practical frequency (above 10,000) and changing the amplitude (height) of some of these waves at sound frequency.

To produce waves of such a character the broadcasting station reduced to simplest terms, consists of two alternators (electron pumps) connected to an antenna and ground. Let the first of these alternators pump electrons into the antenna out of the ground and then reverse the procedure 600,000 times per second. The waves generated in the ether would be 500 meters (1,640 feet) long.

Let the second alternator pump electrons in and out of the antenna at the same frequency as some sound vibration, say 600 times per second. On every thousandth stroke (cycle) of alternator No. 1, the two alternators will be acting exactly together (in phase) and will thereby produce an extra high wave in the ether. There will be 600 of these extra high waves produced every second.

At the Receiving End

If at the receiving station some arrangement could be made to convert only these extra high ether waves into air waves, a sound would be heard. It would have a pitch corresponding to 600 vibrations per second.

If alternator No. 2, were to change its frequency to 300, then only 300 high waves would be produced in the ether, and the note heard at the receiving station would have this frequency. By varying the frequency of alternator No. 2, any sound we wish may be transmitted.

In a broadcasting station this frequency is automatically varied by the sound to be sent. By having alternator No. 1 go at constant speed the waves sent out are all the same distance apart and the effect of alternator No. 2 is to periodically vary the height (amplitude) of some of these waves.

Alternator No. 1 is said to produce "carrier" waves which are "modulated" by alternator No. 2.

At the receiving station the apparatus is so constructed that it can be adjusted to accept waves of a definite frequency (or wave length) irrespective of their amplitude. After these waves have en-

tered the set, only the high ones are "detected" and made to produce air waves which we recognize as music, speech, etc.

Ocean Waves Resemble Radio

One might get a clearer picture of the character of the waves sent out from a broadcasting station by recalling how the tide comes in on an ocean beach. The waves come in at regular intervals—perhaps one every fifteen seconds—but at less frequent intervals an extra big wave comes rolling in. On one beach the writer noticed about every ninth wave was an extra high one.

high speed and the other at low speed in accordance with the sound to be transmitted.

Essentially this is what a broadcasting station is, but a visitor for the first time in a broadcasting station would be surprised at its complexity and wonder where the alternators were concealed. To go into these details, however, would defeat the main object of this series of articles which is to point out the major principles applied in Radio to those entirely unacquainted in this field.

As the complex modulated carrier wave

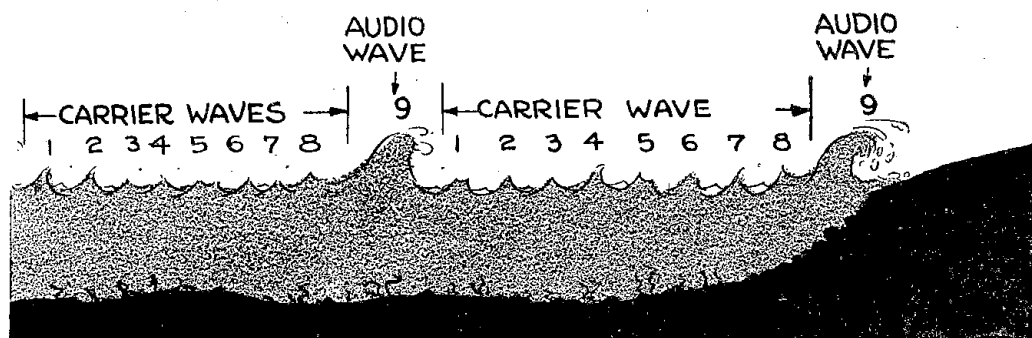

Ocean waves roll to the beach in a somewhat regular frequency. The author observed one beach where every ninth wave was an extra large one. The first eight waves then could be considered as carrier waves, and the ninth is the sum of a carrier and an audio wave, and is extra high.

Translated into the technical language of Radio, the low waves are the carrier waves and they occur at radio frequency.

The larger waves are the "audio" waves. They are so named because (from a broadcasting station) they occur at audible (sound) frequency. Together they constitute a modulated carrier wave.

To avoid the confusion of too much detail the broadcasting station has been represented as consisting of two "electron pumps" or alternators, one running at

leaves the broadcasting station it travels with incredible speed in all directions. Material objects do not greatly affect it because they are chiefly ether themselves.

The electrons composing a wall of a building, for example, offer about as much resistance to a Radio wave as do the fishes to an ocean wave. Although the fish may have some slight effect on the ocean wave the effect of the wave on the fish is apt to be large, especially if the fish can

(Continued on page 24)

Equip Your Set

with

Dialog

\$1.25

With erasable metal logging disc

Smoo-ooth vernier dials

THESE dials were designed for you! They fit your set, and you can attach them in a second or two. No holes to drill, no trouble at all. Slip off your old dials, slip on Dialogs. Then—smoo-oothly, and without the bother of back lash you'll separate close stations with ease.

And Dialog is the really practical vernier dial. No gears or cams to get loose or wear out. They last a lifetime and always work right. Get them today. At your dealers.

- \$1.25 with black bakelite knob and silvered dial
 - \$1.25 with black bakelite knob and black dial
 - \$1.50 with brown bakelite knob and gold finished dial
- Dial readings 0-100 or 100-0

See Our Exhibit
Chicago Radio Show
Nov. 17-22

WALNART ELECTRIC MFG. CO.
308 So. Green St. CHICAGO
"Makers of Good Goods Only"



Autoformer Amplification Amazes Vast Crowds

Used at Radio World's Fair, New York City, to Amplify Programs and Announcements Broadcast by Loud Speakers Throughout the Great Halls

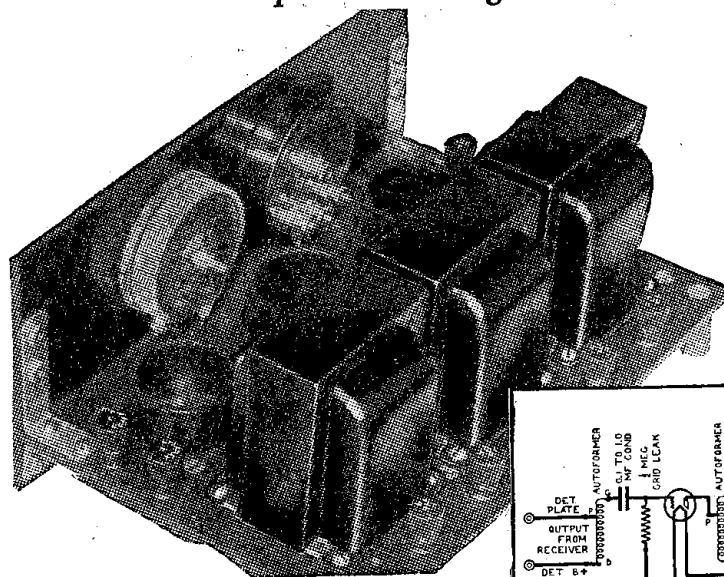

A Thordarson Autoformer Amplifier built in accordance with instructions and diagrams furnished with each instrument.

No note is too low—no note is too high—to be fully amplified by Thordarson Autoformers.

TENS of thousands of radio enthusiasts were completely won to Autoformer (Trade Mark Reg.) amplification during the Radio World's Fair in New York. The Thordarson Booth was besieged by fans, amazed and delighted over this latest Thordarson achievement. It was hailed on all sides as the outstanding development of the year in amplification. "What is it?" "How may I use it with my set?" Such questions were continually repeated.

Our answer was this: As the world's oldest and largest exclusive makers of transformers, we have led for years in broadening their amplifying range. In the Autoformer we have finally developed an all-frequency amplifier

—a new instrument capable of fully amplifying all notes audible to the human ear. Thus the deepest notes of the grand organ, bass viol, tuba, English horn, etc., at last are brought out as clearly as those in the middle and upper registers of the musical scale. Improved long distance reception and better volume control are further advantages.

Autoformer amplification is expressly for those who seek the finest reproduction of programs to be had. May be used with any set in place of the present amplifying transformer hook-up. Autoformers are \$5 each, at dealer's or by mail. Send for free literature.

THORDARSON ELECTRIC MANUFACTURING CO.
Transformer specialists since 1895
WORLD'S OLDEST AND LARGEST EXCLUSIVE TRANSFORMER MAKERS
Chicago, U.S.A.

HOW RADIO GOES THROUGH WALLS

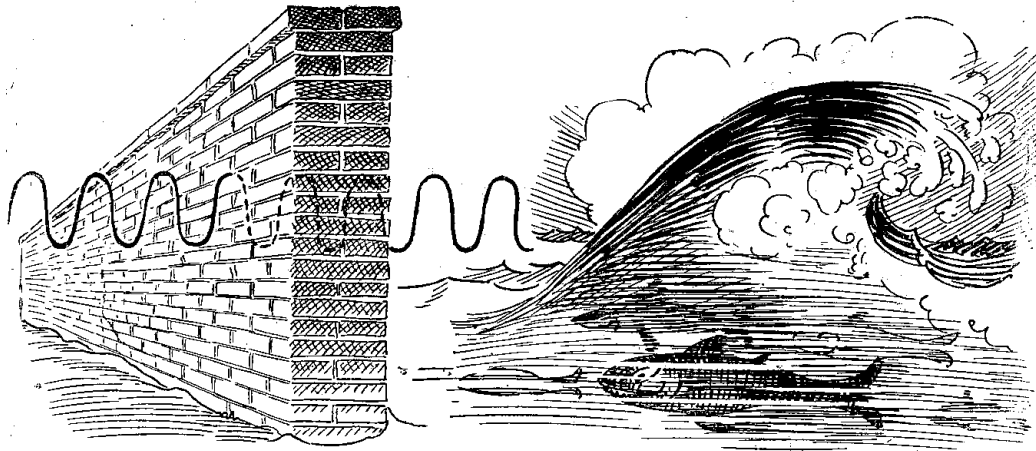

The electrons (all matter is composed of electrons) making up a brick wall offer about as much resistance to the Radio wave as do the fishes to an ocean wave. The ocean wave is liable to knock or roll the fishes around a bit, and likewise, Radio waves are liable to roll or knock electrons around a bit; not so much in a brick wall as a copper wire, however.

EXPLANATION OF RADIO

(Continued from page 23)

be easily moved around—like the electrons in copper and other metals.

It is difficult to appreciate the sensations of a fish without being one, although some of us have tried hard to be with varying degrees of success.

Bouncing Bather Like Antenna Electron.

Let us return to the ocean beach and watch a bather who is wading out into the ocean and who cannot swim. He has waded out until he is just lightly walking on the bottom. A wave strikes him and he is lifted up on his toes but after a moment he is in the trough of the wave with his feet quite solidly on the ground. He enjoys this bouncing sensation for quite a while and then there comes a great big wave. He has no time to run to shore for the huge wave is upon him. It lifts him completely from his footing and he lives years in a small fraction of a second. He does not drown for the water just behind this wave is shallower than usual and he is able to recover his footing.

The Radio ether waves have precisely this same effect on the electrons in the antenna wire. It bounces them up and down and furthermore the amplitude of bouncing is proportional to the height of the wave. An audio wave gives the electrons an unusually big bounce.

Bouncing Electrons Make Alternating Current

When a wire contains a lot of bouncing electrons all going in the same direction at the same time, an alternating current (first flowing in one direction, then in the opposite) is said to be flowing through (really in) the wire.

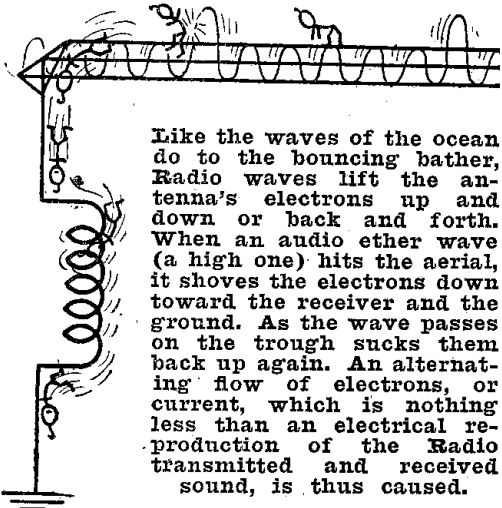

Like the waves of the ocean do to the bouncing bather, Radio waves lift the antenna's electrons up and down or back and forth. When an audio ether wave (a high one) hits the aerial, it shoves the electrons down toward the receiver and the ground. As the wave passes on the trough sucks them back up again. An alternating flow of electrons, or current, which is nothing less than an electrical reproduction of the Radio transmitted and received sound, is thus caused.

The antenna wire is connected to the wires within the Radio set, and these in turn are connected to the ground. When the electrons in the antenna are lifted upward they pull some of the electrons out of the wires within the receiving set and this in turn sucks electrons out of the ground. When the trough of the wave occurs, the electrons are literally shoved downward toward the receiver and this shoving effect continues on to the ground. This action is repeated by each ether wave. Thus it is that an ether wave produces a tiny alternating current within the receiver.

Use of Queer or No Antennas

Since the receiving set contains a lot of wire with movable electrons, one might ask why do not the ether waves affect the electrons therein directly and dispense with the antenna? This may be done provided the set is very sensitive and the ether wave very powerful. But because an antenna intercepts more of the ether wave a greater effect is produced. Too large an antenna is undesirable for reasons which will be made clear when the subject of tuning is discussed.

In this connection a few remarks might be made about the use of bed springs, chandeliers, clothes lines etc., for antennas. There is nothing particularly mysterious about the success one occasionally has with these freakish connections.

Ether waves and electrons are not con-

cerned with outward appearances, but certainly a correctly designed and well-insulated antenna is many more times efficient and reliable.

Bare or Insulated Wires?

Two other questions which are frequently asked are: Must copper wire be used for an antenna? Does it make any difference if it is bare or insulated?

Copper wire is preferred to other metals for an antenna as well as other electrical uses because it conducts electricity so very well. Silver is the best electron conductor known, but copper ranks a close second, gold is third, and aluminum fourth. The easier it is for the electrons to move or be moved, the greater the effect produced by an ether wave. Excluding silver, copper best satisfies this requirement. This advantage is lost, however, if one uses very small wire for his antenna, or in winding the coils for his receiving set etc., because in a small wire the electrons must move along a narrow, crowded passageway which is difficult.

As to the wire being bare, or covered with insulation: It makes no difference in the case of an antenna.

From the ether point of view insulation is mainly ether anyway so an ether wave has no difficulty getting through it to the wire.

From an electron point of view an insulator is a bunch of well-anchored electrons. They cannot wander around like those in the copper and so cannot exchange places (refer Chapter I). This prevents the electrons which are moving in the copper wire from getting to the ground before going through the receiving set. The only places where insulation is actually needed on an antenna wire is where the electrons might get off onto a gutter, or a wet tree, etc., and get to the ground. Insulation anywhere else does neither harm nor good.

(Chapter IV of Mr. Tanner's series will discuss tuning and how music is produced from ether waves. His treatise on the "life and travels of the Radio electron" will continue to be simple and even more interesting.—Editor's Note.)

Traveling Man's Antenna

I find many hotels where it is difficult to get any reception on a loop or indoor antenna. Here is the scheme I use to overcome this and I get reception from all points, loud and clear on a three tube reflex.

I took two yardsticks and cut 12 inches off each end, and with the four pieces,

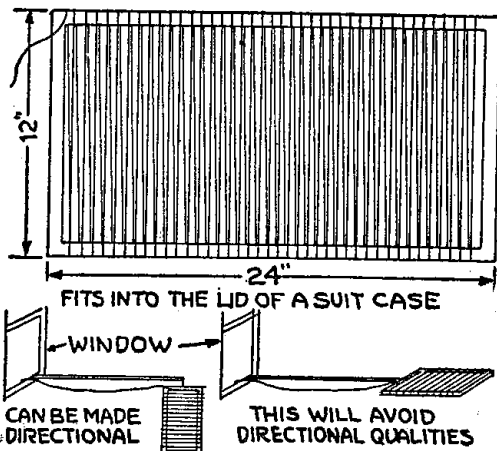

made a frame 12x24 inches. Over this I wound 100 feet of talking tape. I get a stick and hang this frame on it and then put it out the window and jam the window down on the end of the stick. I find this far better than an indoor aerial.—Jack Lenox, Orpheum Circuit.

Do Not Oil Condenser

Capillary action spreading even the lightest of oil will soon ruin a condenser. Manufacturers treat these instruments to a life time lubrication before they leave the factory and it is not necessary or advisable for you to attempt to oil the bearings or rotors.

ALWAYS RELIABLE

EVEREADY Radio Batteries are always uniform and reliable! Evereadys perform the same, everywhere, for everybody, needing no skill, calling for no experimentation, wasting no time, saving you money. Trouble-proof, wonderful Evereadys. There is an Eveready dealer nearby.

Manufactured and guaranteed by

NATIONAL CARBON COMPANY, INC.
New York San Francisco
Canadian National Carbon Co., Limited, Toronto, Ontario

EVEREADY HOUR EVERY TUESDAY AT 9 P. M.

Eastern Standard Time

For real radio enjoyment, tune in the "Eveready Group."

Broadcast through stations—

WEAF New York	WGR Buffalo	WCCO Minneapolis
WJAR Providence	WGAE Pittsburgh	WOC St. Paul
WEEL Boston	WSAI Cincinnati	WOC Davenport
WFI Philadelphia	WJL Detroit	WTAG Worcester
	KSD St. Louis	

EVEREADY Radio Batteries

—they last longer

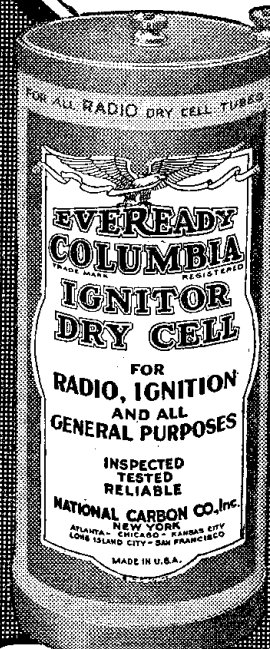

Eveready Columbia Ignitor "A" Battery, the proven dry cell for all radio dry cell tubes 1 1/2 volts

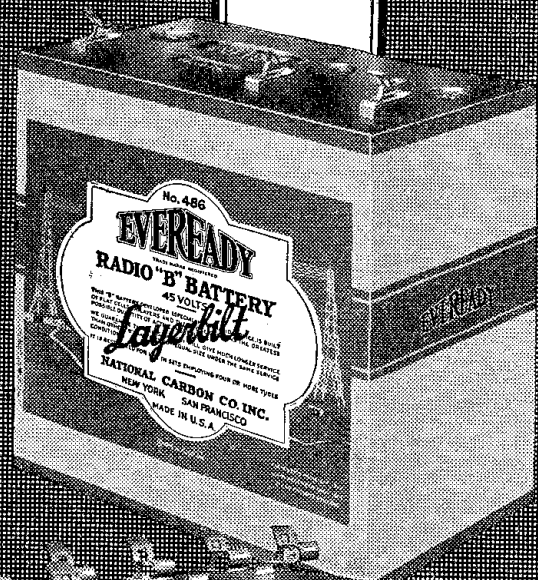

No. 486 45-volt Layerbilt Extra-Large Vertical Price \$5.50



No. 766 22 1/2-volt Large Horizontal Price \$2.00

The Grand Prix Eight Tube Super-Heterodyne

Part IV—Putting It in Operation

By James McDonald

THE wiring having been completed by the fifty operations described in last week's article, Grand Prix is now ready to be connected to its accessories and put to use. Builders in some parts of the country may have had difficulty securing Cardwell dials, in which case the writer would suggest, as two excellent substitutes, the Jewett dial made by Jewett Radio and Phonograph company of Pontiac, Michigan, and the Gee-Haw dial made by Otto R. Gischow company of New York city.

They have both been tried out on this set and, while the varying ratio of the Cardwell dial is not available in either of the other two types, excellent separation of stations on the lower wave lengths is had. Grand Prix is reproduced here with the Jewett dials, while the logging mentioned later in the article is the result of tuning on the Gee-Haw.

Preliminary Arrangements

Slip the Daven cartridge leaks of 2 megohms resistance into the clips provided by the Dubilier 601-G grid condensers. The set had best first be tried out without the cabinet. Place set where you wish it on the table, with loop, speaker and batteries where you intend to put them permanently. Push down the toggle switch to the "Off" position. The Belden cable is now brought to the A and B batteries for connection to them. In case you did not identify the five leads with Crowe markers, the colors connect as follows:

The yellow and black covered wire connects to the negative terminal of the storage battery, usually marked with NEG or a — sign. The red and black wire goes to the positive terminal of that battery, marked with POS or + sign or red paint. A short wire is to connect this positive terminal to the negative terminal of the B battery.

Connecting Batteries and Accessories

If two large dry cell B batteries are used, we have the negative of one connected to the positive of the A battery. The positive 45 of this battery is to be connected to the yellow lead of the Belden cable and, by a short wire, to the negative of the other B unit. The maroon lead connects to the positive 22 of this second battery which makes the maroon lead 67 volts positive with relation to the negative of the first B. The bright red lead of the cable connects to the positive 45 of the second B which makes it 90 volts positive with relation to the negative terminal of the first B and the red and black lead of the cable.

Two wires were put in as operations 48 and 49 for the C battery. Wire 48 is to be connected to the negative terminal of a 4½-volt C battery, while wire 49 goes to the positive terminal of that battery. The two leads from the loop are, presumably, furnished with phone tip terminals and these are to be inserted in the Imp jacks near the rear left corner of sub base. It makes no difference, for the tryout, which goes in which. The loud speaker terminals must be equipped with a phone plug such as the Saturn, for insertion in the jacks.

Inserting Tubes

Turn rheostat, RHEO, to the left, or in a counter-clockwise direction, as far as it

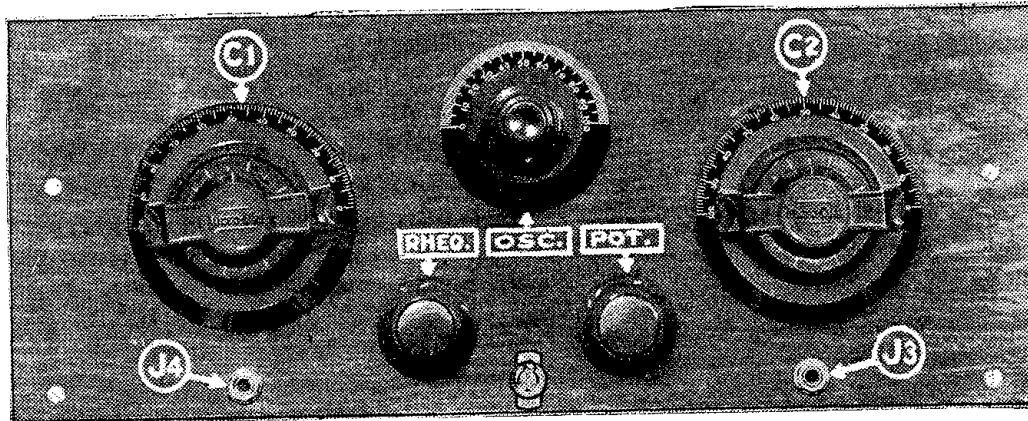

Figure 9

will go, which is the off position. Insert one tube in any socket, lift the C-H toggle switch to the "On" position, and turn rheostat slowly to right. If all connections are correct, tube should light dimly and increase in brilliancy as rheostat is turned. A seriously wrong connection, injurious to the tubes, will be indicated by extreme brilliancy of the tube used, and

with the right hand. Keep the left hand on the POT. knob and turn it rapidly back and forth while revolving C2.

A point will be found on C2, between 30 and 60, at which the hiss or crackling of static, is unusually loud and may even be a squawk. At this point the two dials are in the correct relation to each other for maximum efficiency on a signal which

GRAND PRIX ACCESSORIES

- 1 Loop Antenna
- 2 B Batteries, 45 volt
- 1 Storage, 6-volt, A Battery
- 8 Tubes of the "A" type
- 1 Loud Speaker

- 1 C Battery 4½-volt

Aero, Ajax, Lincoln, Duo-Spiral, Eveready, World, Prest-O-Lite, Hawley, World, Prest-O-Lite, Eveready. Dealer can recommend from tests. Thorola, Super-Speaker, Town Crier, Crosley, Stewart-Warner, Morrison, Music Master, DeForest, Atwater Kent, Kellogg, Fultone, Eveready.

RHEO. should be immediately turned back to left and off.

Should tube light up this way, the B batteries are in the filament circuit somewhere, and filaments would get either 45 volts or 90 volts instead of the intended six.

Presuming tube lights correctly, turn back rheostat and insert the remaining 7 tubes. The loud speaker plug is inserted in the right jack, shown in figure 9 above as J3. Now turn potentiometer POT. to about the center of its possible rotation, which can be seen by looking at the arm on the back where it runs over the wires. Turn RHEO. around to the right about two-thirds of its rotation. If a loud squawk is heard, turn POT. slightly to the right until squawk ceases and a hissing or rushing sound is heard, indicating strong regeneration and sensitivity, but not oscillation, of the tubes S1, S2 and S3.

Tuning Instructions

The tuning instructions from here on, are written from the use of dials on which the upper half of the circumference is divided into 180 degrees. If dials are used, such as the Jewett, on which the upper half is divided into 100 divisions, remember that my reference to 90 is equivalent to 50 on this Jewett type dial, and that 45 means the same point on the 180 degree (Gee-Haw) dial as 25 on the 100-division dial.

Place dial C1 at about 70 on its scale and revolve dial C2 between 30 and 60,

erating a frequency of the right number per second so that, when mixed in the first detector, tube S8, with the frequency of the incoming signal, the resultant frequency is that which is passed best by the transformers in the Multiformer unit. For every setting of dial C1 which tunes the loop antenna circuit, there are two points of maximum efficiency on dial C2.

Adjusting Knob POT.

When the dials are not in this perfect relationship with each other, the POT. knob can be turned clear around to the left, but, as one or the other is moved to a position approximating maximum efficiency, the POT. knob will have to be turned further back to the right to prevent the squawk of oscillation.

Local stations can be heard with the dials C1 and C2 set correctly and the knob POT. away around to the right and far from putting the circuits near oscillation, but to get range and volume, this knob must be brought up for each new combination of C1 and C2, to the loud hiss or crackling point.

Sample Dial Settings

A few sample combinations of C1 and C2 are given here to guide you in setting the dials and learning the operations. When these were taken, an Ajax loop and Gee-Haw 180-degree dials were in use. Only one setting of C2 is listed, but for each station there is also another, from 10 to 12 degrees below it.

WOK, 19 and 7; WMBB, 21 and 11; WSM, 33 and 20; WSMB, 45 and 30; WGN, 68 and 47; WSB, 90 and 70; WFAA, 113 and 87; WMC, 133 and 99; KYW, 150 and 118; KSD, 155 and 124.

The settings of the loop tuning dial C1 will vary on your Grand Prix from those shown but the settings of C2, given as the second number on each station listed above, will be pretty close to those given. Slight differences in wiring, and the various tubes which may be used as oscillator, may throw this off a little.

(Continued on page 26)

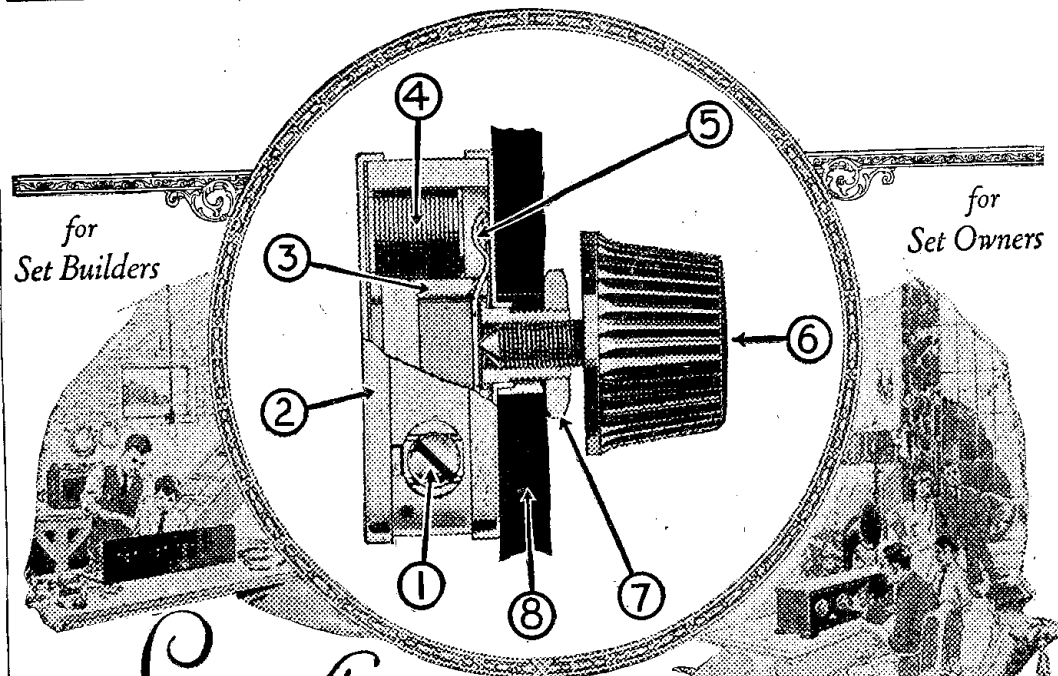

*Superfine—
in finish and performance*

WHETHER you build your own receiver or buy a factory-built set, you will improve your radio set by installing Allen-Bradley Perfect Radio Devices for the following reasons:

- 1 Terminals easily accessible.
- 2 Metal parts heavily nickled and polished.
- 3 Container is made of glazed porcelain.
- 4 Specially-treated graphite discs give noiseless control.
- 5 Internal switch opens battery circuit.
- 6 Bakelite knob is removable.
- 7 One hole mounting permits quick installation.
- 8 Use with any panel or in any set.

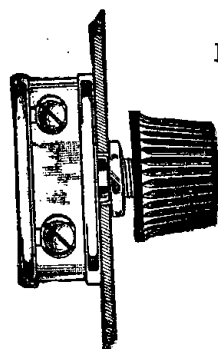

Bradleystat

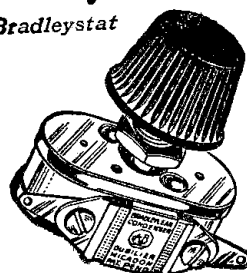

Bradleyeak

MAIL COUPON for latest literature on all Allen-Bradley Radio Devices

ALLEN-BRADLEY CO.,
290 Greenfield Avenue,
Milwaukee, Wisconsin

Please send me your latest literature on the complete Allen-Bradley line of Perfect Radio Devices.

Name
Address

A FACT!

The only man who doubts that a 3-tube set can give better results than a 5-tube set, is the man who has never made a performance comparison between the Crosley Super-Trirdyn and the best 5-tube set built.

Super-Trirdyn Regular, \$45

THE CROSLEY RADIO CORPORATION, Cincinnati, Ohio

CROSLEY RADIO

BETTER · COSTS LESS

GRAND PRIX SUPER-HET

(Continued from page 25)

One point you will soon find: Suppose the battery is fully charged and the RHEO. knob is from two-thirds to three-fourths "On." The potentiometer has been brought up to maximum possible signal strength without oscillation. If now, the rheostat is turned back a little, the regeneration is increased with a degree of fineness or smoothness impossible to get with the POT. knob.

With the RHEO. knob turned back, the POT. knob does not have to be turned to the left very far to get good regeneration. With the RHEO. knob advanced nearly to its limit, the POT. knob must be advanced much further to the left to again get the hiss and crackle of maximum sensitivity. If the volume with the former combination is just as good as when the RHEO. knob is advanced, as in the second combination, use it, as there is no use burning the tubes any brighter than one has to.

A point will be found on the RHEO. settings where best obtainable volume is obtained with all settings of C1 and C2, and the proper setting of POT. knob. Ultimately you will hit the combination where the RHEO. knob can be left alone, and the POT. knob also. Tuning can then be done entirely with the dials.

If Tubes Are Different

One last point to be covered. As I gave you the connections above, the yellow wire of the cable went to positive 45, the maroon wire went to positive 67 and the bright red wire went to positive 90 of the B battery. These are the connections for average tubes.

Should the tubes in the intermediate stages, S1, S2 and S3, be comparatively poor, a higher voltage may be desirable on them, and the maroon wire should then go to positive 90 instead of positive 67.

You may find that the detectors and the oscillator can use a higher voltage to advantage, and that better results are obtained with the yellow wire on positive 67. On the other hand, they may "perc" better at positive 22, 28, 30 or 40, if such taps are available on your dry cell or storage B batteries.

These are points which I cannot give definitely due to variations in tubes. I wish I could. If you have an Edison B, a type which is becoming more and more popular, and have a 135-volt tap, the bright red wire may give splendid volume on that tap. Personally, I have a Hawley alkali B, made by B. D. Smith of Danbury, Conn. Batteries are largely a matter of personal opinion, however, and I have noticed that Mr. Ryan, another writer of Digest articles, seems to like

the Prest-O-Lites he has. They're all pretty good these days.

C Battery Voltage

A 4½-volt C battery is specified and this value of grid bias will be found suitable for most tubes when 90 volts is applied to the bright red wire of the cable. If this voltage is increased, or exceptionally good tubes are used in sockets S5 and S7, it may prove better, for clearness, to employ two C batteries in series to yield 7½ or 9 volts total.

There you are; I've given you the results of a month's tests on Grand Prix, two Grand Prix, I should say.

Try not to operate with the POT. too far advanced if you want clearness. Better to tune dials C1 and C2 carefully to get squarely on the wave and the best heterodyning frequency, and be sure to get the loop turned exactly toward the incoming wave. Then you can still get suitable volume without too much regeneration and blurring of the program.

(CONCLUSION)

The Reader's View

J. B. H. Must Be Good

Have read with interest your announcement of the arrangement of WEAFF to use two men to broadcast football games. If you want to hear the premier sports announcer, listen in on WKAR.

This man, J. B. Hanselman, never misses a play, calls all players by name, calls all the formations, and in case of penalties, gives you the reason and explains the rules at the time of play.

Impartiality is his creed. He will criticize the home team as well as the opposition when needed, and give praise the same way.

He is not mechanical with his "running story of the game," for, being an athlete himself, he is still playing while announcing.

So if you want to hear a real description of a football game, you can hear it from WKAR.

New York may have some good ones, but not as good as one who can cause the "Hot Stove League" to give away their tickets when J. B. H. is on the air.

Hope you take advantage of this rare treat.—J. T. C., Haslett, Mich.

More About Silent Nights

In the issue of the Digest dated October 17 appears a letter from W. J. L., New Kensington, Pa., protesting against Chicago's silent night. With only four stations in Pittsburgh he doesn't need a silent night there very badly though I will wager from the tone of his letter he wishes KDKA would keep silent once

in awhile. If he were sitting under Chicago district's twenty-five or thirty stations I will venture to guess he would make just as much noise as we do here.

I am using a five-tube, very selective set but am frank to say that there is very little chance to get any stations on low wave lengths outside the Chicago district when Chicago is going wide open and I believe W. J. L. will be fair enough to admit that with twelve Chicago district stations logged from 0 to 15 on dials that KYW comes in on at 80 one has mighty little chance to "fish" or get advertised programs on these wave lengths. I know also from conversations with Radio fans in the east that there are a great many of them that would welcome a silent night in New York city.

I am strong for the Digest and its campaign for silent night. More power to you—H. V. T., Chillicothe, Ill.

They Should—But They Don't

It seems a puzzle to me why two or more broadcast stations on every wave make a practice of broadcasting every night at the same time. Everyone knows that congestion and interference spoil the result of all broadcasting.

It seems to me that every station on every wave should have some consideration for each other and the result would be better reception for all concerned.—E. D. T., Nebraska City, Neb.

Voices Across the Border

As you already know my opinion of Radio Digest, I will not waste time by repeating, however to myself, and I feel sure to thousands of other Canadian fans, the issue of October 3, 1925, contains the greatest visible blessing so far that Radio has bestowed upon us. I am referring to the announcement on page 3 that CKY announcer is to receive a special silver cup in honor of his leading the Canadian announcers during your popular contest.

The very fact that Radio has formed such an unbreakable, real friendship between two of the greatest and finest countries in the world, the price of all the Radio equipment of both countries

has been amply paid. The greatest statesman could not accomplish more. The honor of making such friendship a tangible fact rests with your good selves, the owners, etc. of "Radio Digest." The two nations have so many things in common that it is impossible to hear any important speech from your splendid stations, some part of which, does not equally apply to Canada; the speeches that we hear sometimes from your excellent president, Mr. Coolidge, contain thoughts that are worthy of any nation to abide by.

To me the progressiveness of Radio reflects the general attitude of the country at large. One has only to turn to page 2, October 3, 1925, issue, and read the impressions of Mr. Smith while in Europe and you have the whole European situation in a nut shell. The petty jealousy of the four stations mentioned is but a symbol as it were of the petty jealousy existing between those small nations. For a contrast just look at ourselves, just the opposite.

Mark my words, Radio will do more in an international way to reduce wars than any conference at Geneva or elsewhere could possibly hope to do. It carries the message of peace over every imaginary boundary set up by man to the people that abhor war most (all of us).—C. W., Kitchener, Ontario.

Want Slower Announcing.

Read an article in Reader's View about announcing call letters. I listened to WDAF four times before I could get the call letters. The trouble is the announcer talks too fast. I find the same thing with many other stations. I would suggest that the announcer give a signal with a gong before announcing call letters as KFOA, Seattle, does. It does not make any difference when the call letters are given just so they are given slowly. I think it will be a lot better for those who listen in and will boost the stations.—E. G. L., Larkspur, Calif.

If there is a possibility of the rheostat shorting on the shield on the panel, cut a piece of mica and place between the rheostat and the metal shield.

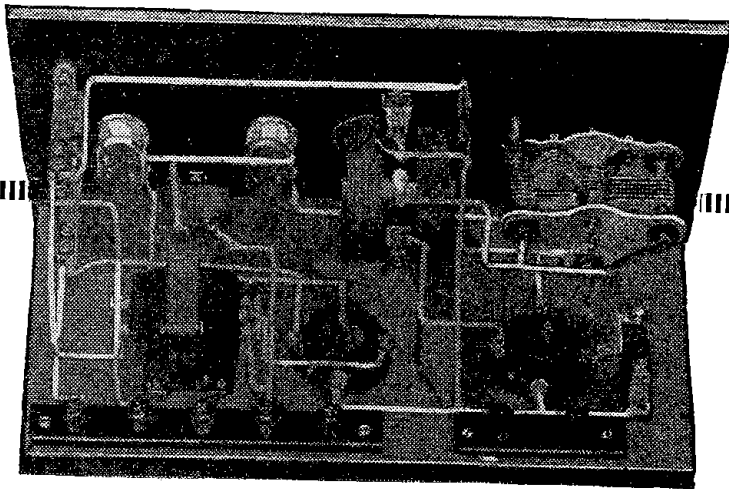

**You Can Build This
Efficient Receiver for \$27²⁷**

Built Around the
HEATH VARIABLE CONDENSER
By the Citizens Radio Call Book

THE remarkable performance of the Heath '0025 Variable Condenser caused The Citizens Radio Call Book Laboratory to design this remarkable high-power, low-cost radio set. Go to your nearest dealer and get your set of plans—they are free with each purchase of a Heath Condenser. Start right now to get the parts to build this super-efficient receiver. You'll have a radio that all your friends will envy. If your dealer doesn't carry Heath Condensers, write us direct.

HEATH RADIO AND ELECTRIC MFG. CO.
206-210 First St. Newark, N. J.

Manufacturers of
HEATH CONDENSERS HEATH SOCKETS HEATH DIALS
HEATH RESISTANCE COUPLED AMPLIFIERS

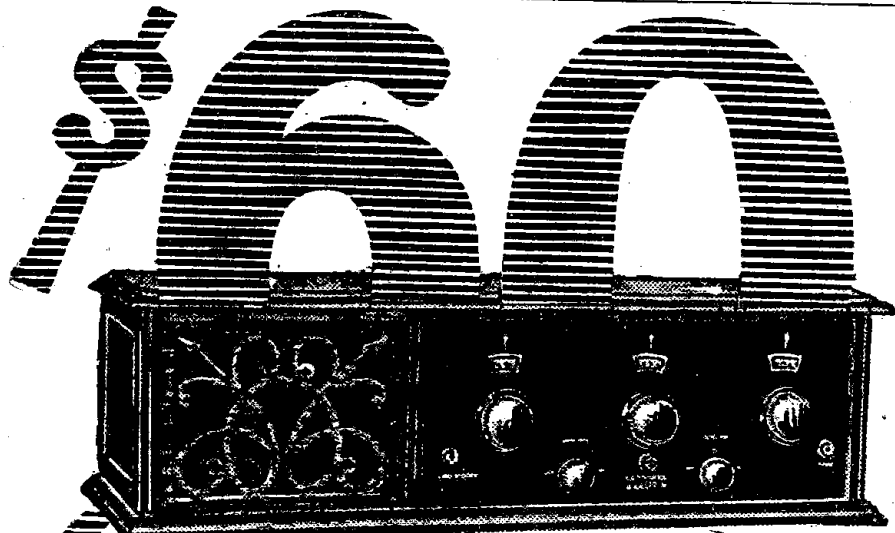

*The World's Greatest
Radio Receiver*

Model 5-F-5

New and Improved
**FRESHMAN
MASTERPIECE**

**With Built-in Loud Speaker
of great volume and superb tone**

A five tube tuned radio frequency receiver encased in a heavy, genuine five-ply mahogany cabinet.

Equipped with the new Freshman straight line wave-length condenser with vernier adjustment, permitting you to tune in the station you want, without interference, over the entire broadcasting range.

**For Sale by Authorized
FRESHMAN Dealers only, who
also install and service them**

Write for 24-page illustrated booklet full of useful information for all radio fans.

CHAS. FRESHMAN CO., INC.

240 W. 40th St., New York
2626 W. Washington Blvd., Chicago

Prices slightly higher
Denver and West

Fireside: 6 Tube Set of Perfect Reception

Part III—The Wiring, Which Should Be Done Slowly

By Jacques Fournier

THE ARTICLE in last week's issue of Radio Digest took us through the assembly of all the parts on the panel and sub base. Now see that all terminals have soldering lugs on them. The Benjamin sockets are provided with them, in the ends of the springs, the Autoformers come with lugs on them, as do the Aero coils. The C-R-L units each are shipped with lugs. Check all terminals and we are ready to start. At each corner of the Benjamin sockets there is a terminal with a hex nut and a round, knurled edge nut. Remove all round, knurled edge nuts and, with Spintite wrench or pliers, tighten down each hex nut, after which replace all round ones. Once this is done, I do not believe there is a better socket made.

Filament Wiring First

1. (a) Connect a wire from the right front terminal on socket 1 to the right front terminal on socket 2. (b) Now, in the rear row, connect the left front terminals on sockets 3, 4 and 5. (c) From (b) run a wire straight forward to the left front post on socket 6. (d) Wires (a) and (b) are connected by running a wire from the right front post on socket 2 to wire (b). (e) The next wire goes from right front terminal on socket 1 to the left terminal of the filament switch in the lower left corner of the panel. (f) From the right front on socket 1 put in a wire under sub base and back to the second binding post from left at rear edge of sub base. (g) On the front ring of Aero coil 1 there are two terminals on the upper side. From the right one, drop a wire down and through sub base to wire (f) just put in. (h) From the right terminal of the switch run a wire straight back 5 1/4 inches, then to the right to the dark green dotted terminal on the Cabelug. (i) A 1/2-inch wire to connect dark green dotted terminal with the pale blue dotted terminal next to it. This completes the negative filament circuit.

2. (a) Long wire is put in connecting left front on socket 1 to left front on socket 2, back above wire 1d, then to right above 1b. Slip on a piece of spaghetti, if bare bus wire is used, where this wire passes in front of socket 3. I use Celatsite wire throughout which is covered with spaghetti when you buy it. This wire goes to right, then back between Autoformer 2 and socket 5 to the left rear terminal on socket 5. (b) A wire is secured to (a), at the last bend, to go forward to left rear terminal on socket 6. (c) Another wire is soldered to (a) to go straight back between Autoformer 1 and socket 4 to left rear terminal on socket 4. (d) A wire from left front on socket 2 goes forward and down to upper terminal on left hand rheostat, R2.

3. From the upper terminal of the right hand rheostat, R1, wire goes up and to left to edge of sub base, then back on top, until under wire 1b, then to left and around socket 3 to the rear left terminal of socket 3.

4. The final wire in the filament circuits is put in by connecting a wire from the lower terminal of the left hand rheostat to the lower terminal of the right hand rheostat, then back to the dark red dotted terminal of the Cabelug.

Radio Frequency Amplifier Circuits

5. From the left binding post of the two in corner of sub base, run wire forward and up through hole to left terminal

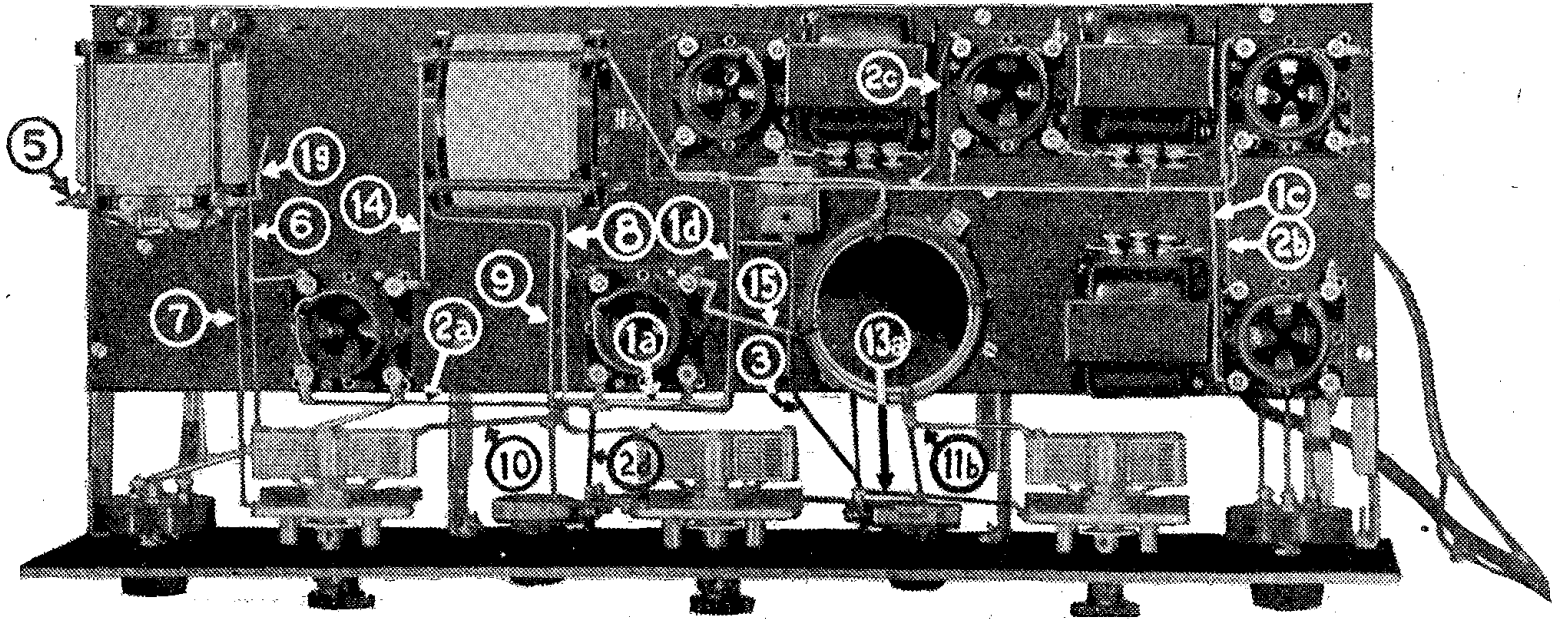

Figure 7

nal on upper side of front ring of Aero coil 1.

6. From the G terminal of Aero coil 1, which is the right one on underside of rear bakelite ring, run wire forward to the stator terminal of condenser C1 which is the left hand one of the three on the panel. Where this wire passes G terminal of socket 1, rear left corner, put in a short 3/4-inch wire to that terminal.

7. From the F terminal of Aero coil 1, which is the right one on the underside of the front ring, run a wire forward to the rotor terminal of variable condenser C1.

8. From the G terminal of Aero coil 2, which is at the front on the underside of the right ring, run wire down and to left almost to sub base, then forward until opposite the stator terminal of center variable condenser C2, then to right to that terminal. Where wire passes G, rear left terminal, of socket 2, put in 1/2-inch wire.

9. From the F terminal of Aero coil 2, at the front on the underside of the left ring, wire goes across to right in front of coil until above wire 8, then forward, until opposite the rotor terminal of center condenser C2, then to right to that terminal.

10. Connect wires 7 and 9, just back of variable condenser C1, with wire above 1a and 2a.

11. (a) The next wire goes from the G terminal of Aero coil 3, which is at the front of the lower ring, down through hole in sub base to the front terminal of the Leakandenser unit. (b) From that same G terminal, another wire goes to the right, to the stator terminal of condenser C3 at right of panel.

12. From rear terminal of Leakandenser unit, wire goes back to 1/2 inch from rear edge of sub base, then to the left and up through hole by the G terminal of socket 3 which is at rear right corner of that socket.

13. (a) Short wire now goes in connecting upper terminal of right hand rheostat R1 across to right to rotor terminal of condenser C3. (b) Drop a wire from F terminal on Aero coil 3, which is at the front of upper ring, to wire (a)

at a point about 1 1/4 inch from rheostat terminal.

14. From P terminal of Aero coil 2, at rear on underside of left ring, drop wire 1 inch, then forward to P terminal of socket 1, the rear right terminal.

15. Next wire goes straight up from P terminal, rear right on socket 2, 4 inches, then across to right to P terminal on Aero coil 3 on upper ring at left.

16. The B terminal of Aero coil 2 is on upper side of right ring. From it drop a wire down to a point about 1/2 inch above filament wires, then to right and down through hole which is 1/2 inch in front of the center of socket 3. On underside of sub base, it follows wire 1h to the left and forward, keeping with it almost to switch. Then this wire goes up, to the left terminal of the C-R-L unit R4 at left end of panel.

17. From the B terminal of Aero coil 3, located at rear of lower ring, next wire goes downward 1/2 inch, then to the left and to wire 16 just where it bends to go down.

18. Considering now the bypass condenser of .5 mfd. capacity just behind the filament switch on the underside of

sub base, drop a wire from the left terminal to wire 16.

19. From the right terminal of that condenser a wire goes forward to wire 1e.

20. If your C batteries are going to be placed under sub base between brackets, the next pair of wires can be about 4 inches long; if to be outside, they should be cut 15 inches long. These wires can be either a twisted pair or a piece of "twin conductor" and one is soldered to the front right terminal on socket 2 while the other is to be soldered to the joint of wires 9 and 10. Using twisted or twin conductor, we get the effect of a bypass condenser around the C battery.

Audio Frequency Amplifier Circuits

21. Terminal P, right front, of socket 3 is to be connected by 1/2-inch wire to lug on P terminal of Autoformer 1, the left hand terminal on that unit.

22. The Dubilier .001 fixed condenser is slipped under wire 2a and above 1b, with its rear terminal on wire 21 just put in. Solder to that wire. From the front terminal a short wire goes to the left to wire 1d.

(Continued on page 28)

Ward's New Radio Catalogue Is Yours Free

This Catalogue represents the world's greatest radio store

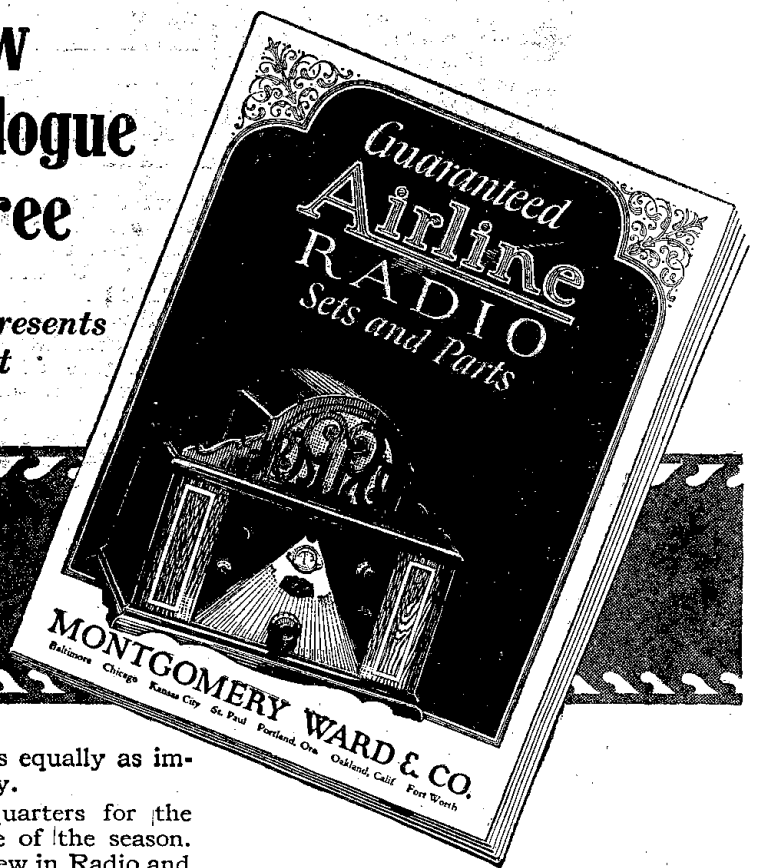

Where you buy Radio is equally as important as the set you buy.

Send to Radio Headquarters for the most complete Catalogue of the season. See for yourself what is new in Radio and what has been actually tested and approved.

See for yourself what low prices can be made on Radio when it is sold without the usual "Radio profits."

A Complete Radio Manual

This new 52 page Radio Catalogue shows everything in parts, batteries, cabinets, contains a list of stations, a radio log for recording stations. It shows the best of the new sets. One tube sets that give amazing results. Five tube sets with a

single dial to turn. Think of tuning in one station after another by turning a single dial!

Every price quoted means a big saving to you. Everything offered is tested by our own Radio Experts; in fact, the best experts compiled this Catalogue for you.

Write for this free 52 Page Book. It is yours Free.

Our 53 Year Old Policy

For 53 years we have sold only quality merchandise under a Golden Rule Policy. You can rely absolutely upon the quality of everything shown in this Radio Catalogue.

Write to the house nearest you for your free copy of Ward's new Radio Catalogue. Address Dept. 41-R

Montgomery Ward & Co.

The Oldest Mail Order House is Today the Most Progressive
Baltimore Chicago Kansas City St. Paul Portland, Ore. Oakland, Calif. Ft. Worth

AERIAL MASTS and FITTINGS

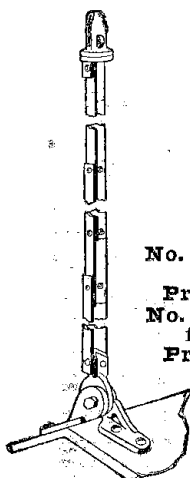

No. 60 Mast Seat for 1" Pipe Price \$3.00 each
No. 70 Mast Seat for 1 1/2" Pipe Price \$1.00 each

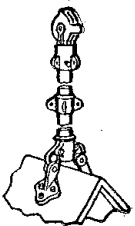

No. 65 Mast Seat for 1" Pipe Price \$2.50 each
No. 75 Mast Seat for 1 1/2" Pipe Price \$0.75 each

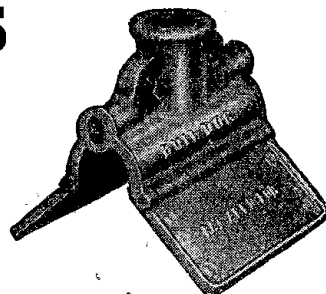
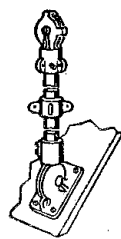

No. 4 Mast Seat for 1 1/2" Pipe Price each \$3.00

The "Bull Dog" and "Freidag" Masts and Fittings take the place of unsightly wood poles and can be erected in less time without damage to the roof.

Made in many sizes and types. Send for complete folders. Made under patents allowed and patents pending.

If your Dealer cannot supply you, use the coupon.

FREIDAG MFG. CO., Freeport, Ill.

Jobbers and Dealers: Write for folders, prices and discounts.

Send me, parcel post prepaid if in United States. Enclosed find \$...
Name.....
Address.....
City.....
State.....

BENEATH SUB PANEL WIRING OF FIRESIDE RECEIVER

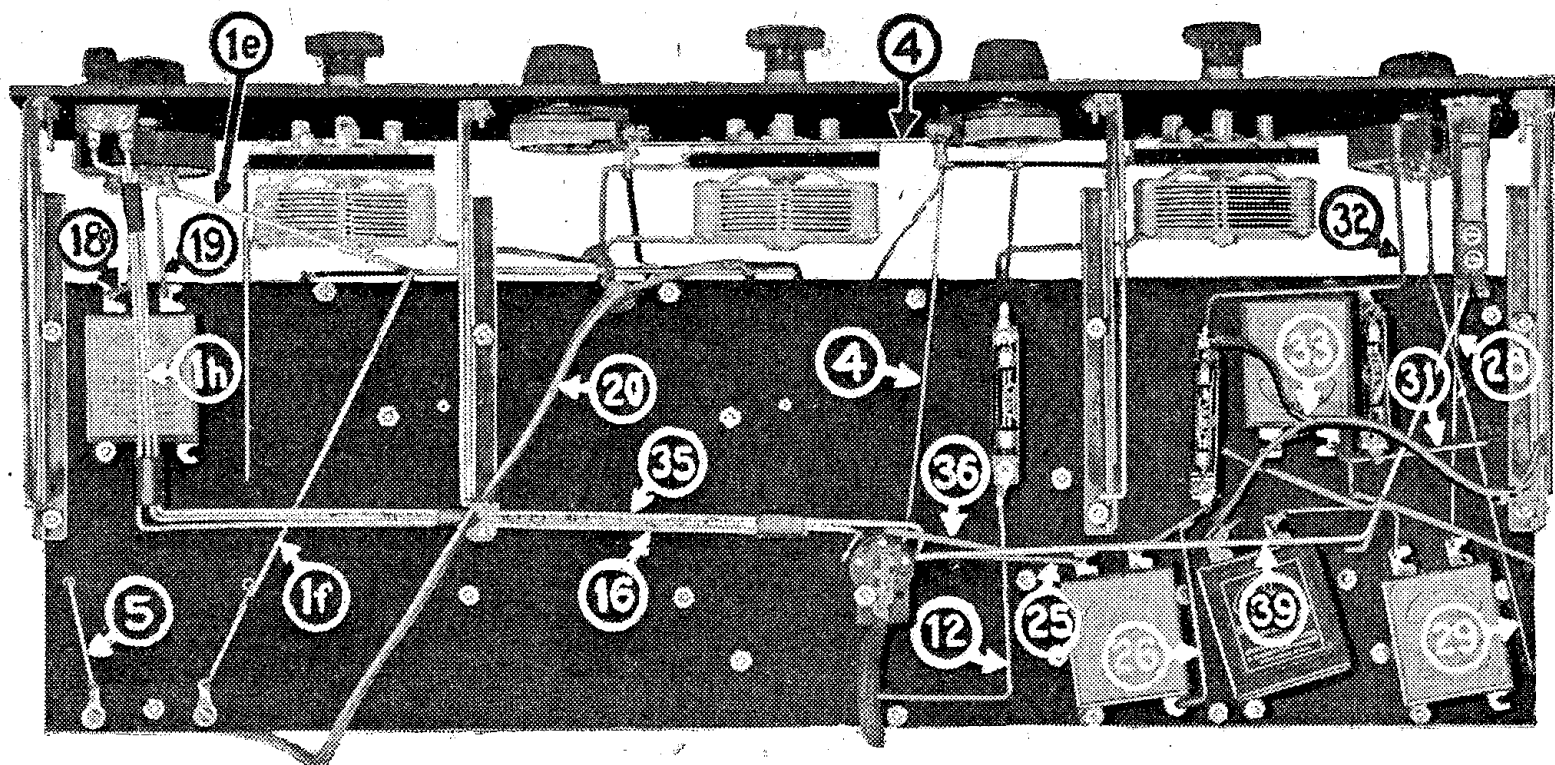

Figure 8

"FIRESIDE" RECEIVER

(Continued from page 27)

23. From terminal P, right front, of socket 4, put in 1/2-inch wire to lug on P terminal of Autoformer 2, left hand terminal on that unit.

24. Terminal P, right front, of socket 5. From it, run wire down through hole, to left, then up through hole by P terminal on Autoformer 3.

25. Drop a wire through sub base from G, center terminal, on Autoformer 1, then to right 2 inches, to left terminal of the .5 mfd. bypass condenser below socket 4.

26. From right terminal of that condenser, put in wire to the rear terminal of resistor R5. From that wire, close to where it joins resistor, run a wire to the rear between the .5 mfd. condenser just mentioned and the 1.0 mfd. condenser, up through hole to G terminal, rear right, of socket 4.

27. From G, center terminal of Autoformer 2, next wire goes up 1/2 inch, forward 3/8 inch, down through hole in sub base, to right 2 inches, back 1 inch to left terminal of bypass condenser C7, below socket 5.

28. From the right terminal of this .5

mfd. condenser, wire goes forward to right hand terminal (No. 3) on the C-R-L 500,000 unit at right end of panel.

29. From the center terminal (No. 2) of C-R-L unit, wire goes back, slanting across wire 28 to rear right corner of sub base, up through hole to G terminal, rear right, of socket 5.

30. From G, center terminal, of Autoformer 3, wire goes down through sub base to left terminal of .5 mfd. bypass condenser C8 just below Autoformer 3.

31. Next wire goes from the right hand terminal of this .5 mfd. condenser to right, across and touching rear terminal of the second .5 megohm resistor R7, to hole by G, rear right, terminal of socket 6. Solder to rear terminal of R7.

32. On the C-R-L 500,000-ohm unit at right end of panel, we still have the left hand terminal (No. 1) so wire goes from this, back to front terminal of resistor R7, across to left in front of bypass condenser C8 to the front terminal of resistor R5.

33. If C battery No. 2 is to be outside,

use a 1-foot piece of twisted or twin conductor, and put one wire on the front terminal of resistor R5 and the other to the left terminal of the 1.0 mfd. bypass condenser.

34. A very short wire is to go up through sub base from left terminal of the 1.0 mfd. bypass to wire 1b where it passes above that point on upper side of sub base.

35. On the 200,000-ohm C-R-L unit at left end of panel, the right terminal is still unconnected. From it, drop wire down, then follow wires 16 and 1h, back and to right and connect to the pink dotted terminal on the Cabelug. Wires 35, 16 and 1h can now either be cabled with heavy thread or held together in spots with tape.

36. Drop a wire through sub base from B terminal on Autoformer 2 to about 1 inch below sub base, then to left and down to yellow dotted terminal on Cabelug.

37. Drop a wire through sub base from B terminal on Autoformer 3 to about 1 1/4 inch below sub base, then forward and to right to the lower terminal of the jack.

38. Loosen the nut on machine screw holding mounting of resistor R5 so that a wire dropped through sub base from B terminal of Autoformer 3 can come through, and under edge of resistor mounting, to right and be connected to wire 37. Then tighten up nut so that mounting is tight again and edge is pressing down on this wire 38.

39. From this joint of wires 37 and 38, run a wire across to left keeping about 1 1/4 inch below sub base and connect it to pink dotted terminal on Cabelug.

40. From the right hand terminal on the 1.0 mfd. bypass condenser drop a wire to wire 39 just inserted.

41. Connect the upper terminal of the jack to P, the right front terminal, on socket 6.

42. Beneath sub base, connect the rear mounting screws of Autoformers 1 and 2 and the front mounting screw of Autoformer 3 with the left terminal of the 1.0 mfd. condenser. If necessary, scrape paint from Autoformer bases around screw holes to be sure of contact.

(Fireside is now completely wired and ready for use. In next week's issue, Mr. Fournier will describe connecting it up and the operation.—Editor's Note.)

Several speakers may be used at one time by connecting them in series. In this way dance music may be received sufficiently loud to be heard all over a dance hall of considerable size.

Here's How to Make the Old Tubes Good as New

ELECTRON tubes in Radio receiving sets eventually lose their sensitivity. This sometimes progresses to the point where the receiving set operates very poorly or not at all, even though the tube filament is not burned out. The user of the set frequently confuses this condition with that due to an exhausted B battery. If the tubes are of the thoriated tungsten (X-L) filament type, they can usually be rejuvenated by a simple process, and made to serve as well as new tubes in the receiving set. All this has been brought out by the bureau of standards.

It happens that most of the tubes now used are of the thoriated tungsten type, and it therefore becomes of quite general interest for the public to know how to secure the full life of their electron tubes. The WD-11 and WD-12 type of tubes are the only ones extensively used which cannot be reactivated. In these tubes the source of the electrons is a coating of certain oxides on the surface of the filament, and when this has been used up no process can renew it.

The thoriated tungsten filaments, however, used in most of the various other types of tubes, contain the oxide of thorium throughout the whole mass of the tungsten filament, this oxide having been originally put in incandescent lamps to keep the filaments from being too fragile. The filaments are given a treatment which produces a layer of atoms of thorium on the surface of the tungsten, and this thorium, which is Radioactive, emits electrons much more copiously than the tungsten would.

After long use, or after burning the filament too brightly, the layer of thorium atoms is evaporated off, and so few electrons are then emitted that the tube does not function properly. Reactivation is a process which boils additional thorium atoms out of the interior of the tungsten filament and forms a new layer of thorium atoms on the surface.

The thoriated filament was developed by the General Electric company, which has also developed the methods of reactivating tubes of this type. The bureau of standards has found that the reactivation process is quite successful, and frequently makes a wonderful difference in the results obtained with a receiving set. The process is essentially the operation of the filament for a very brief interval at a specified high voltage (called "flashing"), followed by a lower voltage for a longer time (called "aging"), all of this being done with no grid or plate voltage.

The flashing reduces some of the thorium oxide in the wire to thorium, and the aging forms the required surface layer. The following schedule of these operations is the result of extensive experience of the Radio corporation of America:

Exactly the same procedures apply for

FLASHING		
Tube Style	Fila-ment voltage	Time
	Volts	
UX and UV-199.....	10	30 Sec.
UX and UV-201-A..	15	1 Min.
UX-120.....	10	Do.
AGING		
UX and UV-199.....	4.5	10 Min
UX and UV-201-A..	7.5	Do.
UX-120.....	4.5	Do.

C and CX tubes as for the UX tubes of corresponding number; thus, C and CX-299 correspond to U and UX-199; C and CX-301-A to U and UX-201-A, and CX-220 to UX-120.

In carrying out this schedule it is absolutely essential to have a voltmeter of a good degree of accuracy and to use a watch with a second hand. No grid or plate voltages are used. Either alternating or direct current may be used for heating the filaments.

It is important that reactivation not be attempted until the tube user has assured himself that the tubes actually need this treatment; that is, he should make certain that his batteries are not run down, and that other parts of the receiving set are in proper order. The schedule above should be followed with great care. The process is useful only for the thoriated tungsten filament type of tubes.

The apparatus necessary for carrying out the process is simple. The filament is connected to the necessary source of voltage, nothing being connected to the grid and plate. A voltmeter is connected across the filament terminals. If alternating current is available the source of voltage can be a small transformer, such as those for running doorbells or electric toys. The voltage tap nearest the voltage specified should be selected and a rheostat in series with the filament used to adjust to the exact voltage. The voltmeter must be one for alternating current.

If alternating current and a transformer are not available dry batteries or storage batteries may be used as a source of voltage. A single dry cell when new will furnish approximately 1.5 volts. A rheostat should be connected in series to give the exact filament terminal voltage as indicated on a direct-current voltmeter.

There are several manufacturing companies that advertise tube reactivators at varying prices. Radio dealers are beginning to give tube reactivation service.

Simple, tight mechanical connections are better than poorly soldered ones.

Building a Super?

Ryan's Simplest Possible Super-het Manual

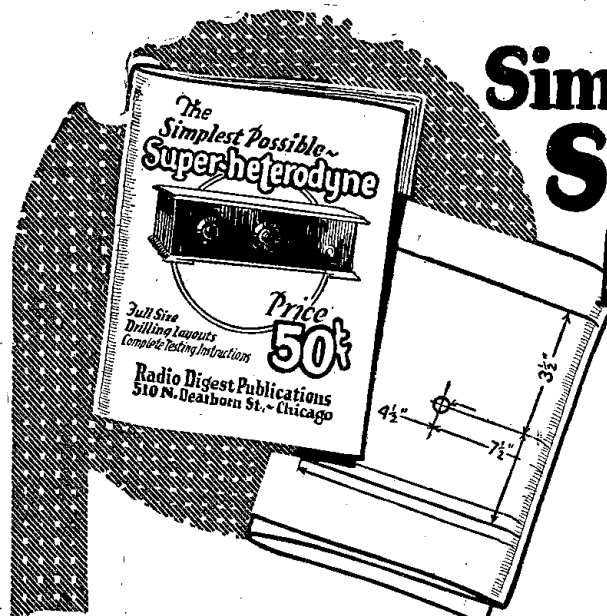

50¢

Full Size Drilling Templates-Loop Aerial Construction

ANYONE who has built a crystal set or single-tube can follow Mr. Ryan's concise, simply worded instructions and enjoy the range available only from a super-heterodyne. Every wire, every lug, is placed by his directions and you cannot go wrong.

The construction of loop aerials, storage "B" batteries, a charger and even the cabinet are gone into thoroughly. This manual covers the complete installation of a selective, quiet, long range Radio outfit. Send money order, stamps or currency to

Radio Digest Publications
510 N. Dearborn St., Chicago

Good Impedance Coupled Amplifier

Two Circuits Produce Tones of High Quality

The enclosed circuits of impedance coupled amplifiers have given me most excellent results so I send them in for the benefit of those of your readers that may be interested in experimenting with this

WORKSHOP KINKS EARN A DOLLAR—

THERE are many little kinks worked out at home that would aid your fellow Radio worker if only he knew about them. There are new hook-ups, new ways of making parts and various unique ways of operating sets that are discovered every day. Radio Digest is very much interested in obtaining such material. Send them in with full details, including stamped envelope, so rejected copy may be returned. The work must be entirely original, not copied.

RADIO KINKS DEPARTMENT
Radio Digest
510 North Dearborn St., Chicago

type of amplifier. In connection with the upper drawing, the condensers C1, C2, C3, C4 and C5 are all of .002 mfd. capacity. The inductances L1, L2, L3 and L4 are audio transformers with the primaries and secondaries of each connected in series. Those of 5 to 1 ratio seemed to give the best results but others may be used. The units designated as R1, R2, R3 and R4 are high resistance variable grid leaks. If there is any tendency to oscillate, either increase the capacity across the output or place a .00025 mfd. fixed condenser across the grid and plate of either the third or fourth tube.

In the second hook-up, the condensers C1 and C2 are .002 mfd. capacity. C3 is either .00025 or .0005 mfd. and its use is not necessary unless there is a tendency to oscillate. L1 and L2 are 5 to 1 audio transformers with windings in series, as before. Transformer T1 is also 5 to 1. Once adjusted properly the output of such an amplifier is perfect and the volume can be built up to suit anyone.—James F. Might, Charleroi, Pa.

Victrola Coil Winder

A good way to use the victrola for winding coils for Radio work is here

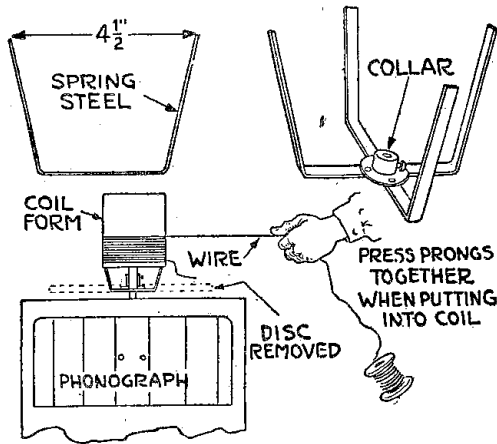

shown. Make the bracket as described with sketch and mount it on the shaft

HOOK-UPS FOR IMPEDANCE AUDIO

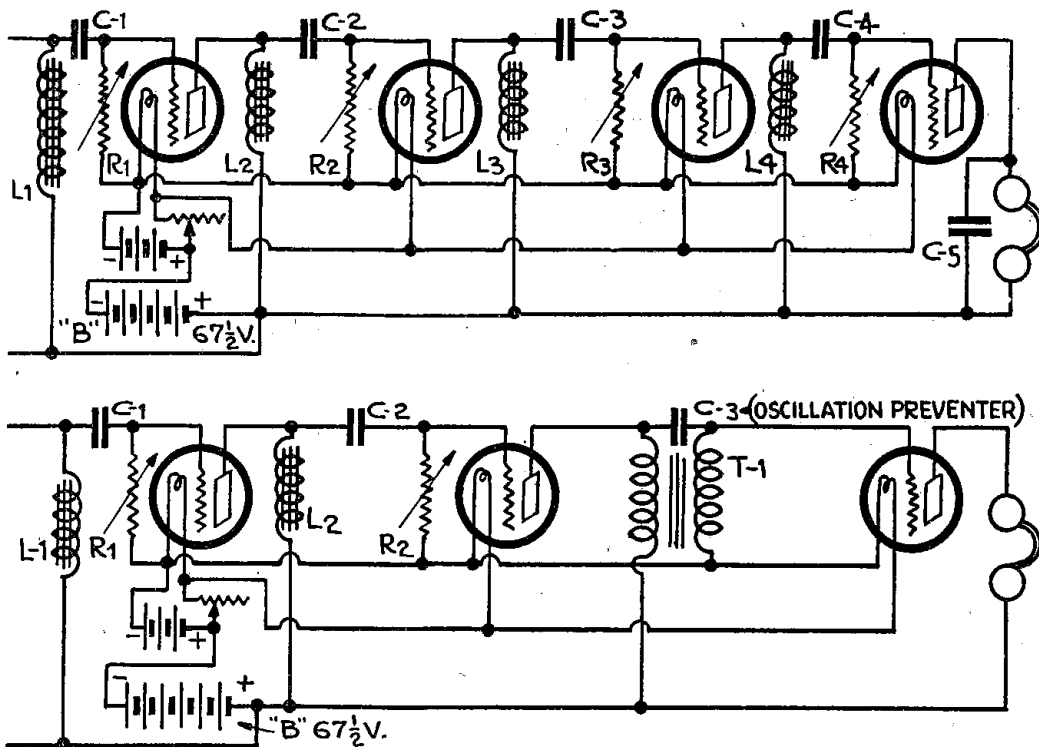

of the victrola after, of course, removing the record plate. Press the prongs together and push the coil form down over the prongs. Fasten the wire to one end of the form and turn on the motor of the victrola. You can regulate the speed by the regulator on the side. This does the work well and does it fast.—Harold Conwell, Brooklyn, N. Y.

Bottle Antenna Insulator

Many times when putting up an aerial an extra, unpurchased insulator is needed. When one is not readily at hand, a bottle can be used very nicely and will give good service. Bore a hole through the aerial pole where the insulator is to be placed.

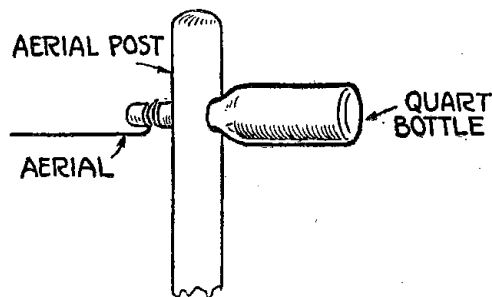

Push the neck of the bottle through the hole and fasten the aerial wire to it. If the neck of the bottle is too short, cut out a place on one side of the pole, so that part of the bottle can be placed as shown in the sketch.—Claude Lisman, Hooker, Okla.

A good radio frequency choke for the plate circuits of a Weagant type regenerative receiver can be constructed with a three-inch piece of wood dowel rod one-half inch in diameter. On this wind as many turns of No. 30 or 32 dec. wire as it will hold. One end connects to the plate of the detector tube and the other to the P terminal of the first audio frequency transformer. Another lead runs,

of course, from the plate of the tube to the fixed tickler and then to the stator plates of the regeneration control condenser.

Spider Web Coil Mounting

Desiring recently to make a portable set I hit upon the plan of mounting spider web coils without going to the trouble of securing special rods and bushings, etc. As may be seen from the sketch I secured

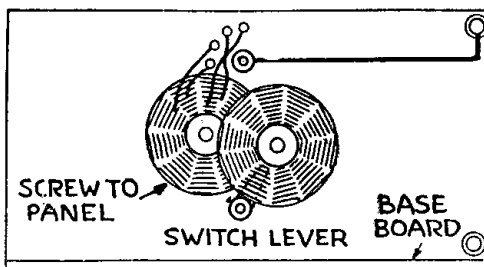

the stationary coil direct to the panel by means of a brass machine screw through the center.

The coil forms are of bakelite and the movable one has one of its spokes secured to a switch lever by a hole near its end, just outside the wire. I substituted a pointer for the lever on the switch and marked a scale on the panel. The switch should have a strong spring to hold the coil in position.—Guy Evans, Cuba, Ill.

Panel Light for DX Hunters

Many fans have to turn in early or tune in without lights because it is late and other members of the family want to

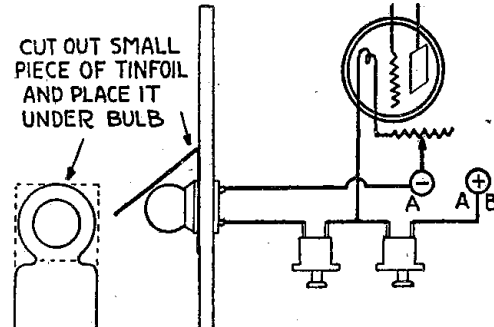

sleep. This difficulty may be solved by making panel lights from parts out of the junk box. A piece of tin foil, a 6-volt flashlight bulb and a socket for same are required. You pull the switch and dials are illuminated. This is hardly any drain on your battery and the light is independent of tubes.—John Mullikin, Washington, D. C.

Dust in Set Causes Loss

Dust in radio sets is often the cause of a large loss in efficiency. This is especially true in wet weather, when the dust becomes damp, and allows the feeble currents to leak.

The worst places for dust to be allowed to collect is about binding posts and terminals and between the plates of rotary variable condensers. It may be removed from between wires and around terminals with a small brush, about two inches wide. Many Radio engineers use pipe cleaners, the same as are used for cleaning the stems of ordinary smoking pipes, for removing dust from between condenser plates and from other otherwise inaccessible places.

It would be good practice for the set owner to carefully dust his set in this way, as often as once a month.

When boring holes in wood or bakelite, splitting on the under side can be avoided if the piece being drilled is clamped or kept firmly pressed against the top of the bench or another thick piece of plank. In effect, the bench surface or the plank is one with the panel being drilled and there is very little tendency for chips on the under side around the hole, to break away.

REX

REX answers the eliminator problem. The B Battery eliminator equipped with Magnatron Rex tubes works day in and day out—silently and economically.

Magnatron Rex is the product of long research by the oldest exclusive manufacturers of thermionic valves in the country. It has been designed primarily and only for eliminator work.

Magnatron and Excellence have come to mean one and the same thing. Impartial laboratories and radio engineers

West Coast supplied from complete stocks carried by PACIFIC RADIO LABORATORIES, 256 South Los Angeles Street, Los Angeles, California

for your B battery eliminator

throughout the country have certified this. Their reports explain why Magnatrons in your set will make it function better.

Your dealer has the Rex as well as the other Magnatrons. Ask him today!

They list for only \$2.50.

Write for your FREE copy of "Pot Pourri—a snappy review of mirth and music," to Dept. D.

CONNELLY ELECTRIC LABORATORIES
Magnatron Building, Hoboken, New Jersey

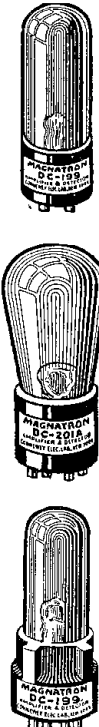

MAGNATRONS

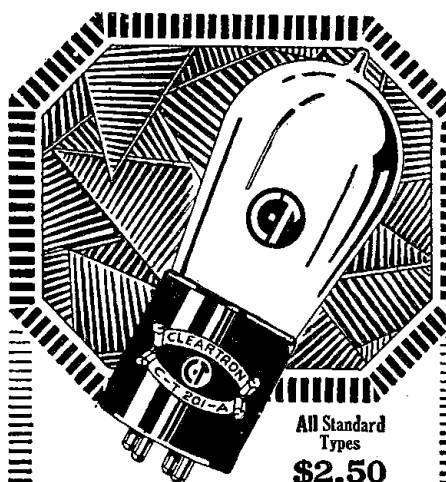

All Standard Types \$2.50

CLEARTRON

GUARANTEED RADIO TUBES

Cleartron tubes cut variation to the minimum, better the tone quality of your receiver, and materially increase its volume and sensitivity. Perfect service or instant replacement guaranteed.

At All Reliable Dealers
Write for FREE six page folder giving valuable information regarding radio tubes.

Hi-Constron Model C-T 101A
The original Hi-Mu Tube for Resistance Coupled Amplifiers

CLEARTRON VACUUM TUBE COMPANY
EXECUTIVE OFFICES
28 West 44th Street, New York City
FACTORIES
West New York, N. J., U. S. A.
Birmingham, Eng.

FOR BETTER RECEPTION



What is a L-E-A-K-A-N-D-E-N-S-E-R?



EVERY detector tube needs a grid leak of known and permanent value, and a grid condenser of fixed capacity.

Daven has again blazed the trail by combining in a single unit a grid condenser without mica and without tin foil plates, that does not change its capacity, and does away with wide variations, plus a Daven Grid Leak, standard of accuracy the world over.

The Leakandenser is simple, effective, sturdy, handsome. Precision-built, takes up less space, better looking, with new fastener clip—\$1.00.

Mail the coupon for complete information.

The Sine of Need

DAVEN RADIO CORPORATION
Resistor Specialists

Newark, New Jersey

DAVEN RADIO CORPORATION I-11-25
158 Summit Street, Newark, N. J.
Please send me the following:
...Resistor Manual, 30c is enclosed.
...Complete Catalogue (free).

Name.....
Address.....

Get the Handbook of Resistance Coupled Amplification. At Dealer's 25c. By mail 30c.
FOR DEALERS: Send your letterhead and we will have our nearest distributor communicate with you.

THE BIG LITTLE THINGS OF RADIO

Questions and Answers

Reinartz Trouble

(14650) DWC, Lebanon, Pa.
I have built a Reinartz circuit and am sure all parts are good and correctly wired, but I find on tuning that it is in a state of oscillation at all times. I cannot bring it up to a peak of regeneration as signals are mushy at any combination of controls. I reduce the filament voltage but must reduce it so low that by the time there is a clear signal, it is too weak to be entertaining.

A.—We note in your sketch that you have no bypass condenser across the phones. Place a .002 mfd. condenser across them and see if that does not help. Also try inserting a choke coil in the plate circuit above phones, constructed by using a three-inch piece of 1/2-inch dowel rod wound full with number 24, 26 or 30 sec. or ssc.-wire.

Two Tubes on Loop

(14679) LRP, Hammond, Ind.
I note in a recent issue you advised one of your readers, in answer to his inquiry, that the use of two tubes on a loop antenna was impossible. Are you positive, from actual experience, that it cannot be done? I have been playing with a regenerative set, using two WD-12 tubes and dry cells connected to a 100-foot indoor antenna and have logged "perfect receptions" from 63 stations, from KGO on the Pacific to WBZ on the Atlantic. I am inclined to believe that a copper wire loop of the proper capacity would DX on this two tube set and I intend to find out tonight. Will advise you as to results.

A.—You will note in our answer to inquiry No. 14149, that we said it was "practically" an impossibility, by which we meant that only the advanced experimenter in an exceptional location should try this arrangement with any hopes of success. The average beginner or even one who has played with Radio for a season, does not get an amplification of better than three or four out of a stage of tuned radio frequency, which is hardly satisfactory on the average poorly constructed loop, in the average location.

You will note in the inquiry which we are discussing that the gentleman was going to use a variocoupler between the first and second tubes which made it plain at once that he did not know a great deal about Radio practice. The variocoupler, as designed for a regenerative receiver, is not suited for use as a tuned radio frequency transformer. We will be interested in learning of the results you get when you try out this arrangement and we trust you will see our point of view in making reply to that inquiry as we did.

Four Filter Super-Heterodyne

(14700) VS, Clinton, N. C.
Finished the four filter super and since we have had a few good Radio nights have had opportunity to try it out. So far, results have been very good and quite up to expectations. Using a 75-foot outdoor antenna, I can bring in such stations as KDKA, WSAI, WGY and WBZ with the speaker in the detector jack. It was the only set in town to bring in the World Series on a speaker satisfactorily. I have not broken any distance records yet although I have had stations as far west as Denver, Colo., and Hot Springs, Ark. Its selectivity is about all that could be asked for.

I want data on the construction of a

CLASSIFIED ADVERTISEMENTS

B ELIMINATORS

Make Your Own B-Eliminator with our imported French parts, high quality, minimum cost. Send stamp for details. B-Free Co., 6453 Bosworth, Chicago.

BLUE PRINTS

Ryan's Simplest Super-Het 14 pages, full size working drawings; Neutrodyne, 24 pages with blueprints; Reinartz, 14 pages with blueprints; Radio Circuits, 28 pages with 48 hook-ups; Reflex De Luxe, 16 pages with blueprints; Miloplex, 16 pages with blueprints; Flewelling, 12 pages with blueprints. 3 for one dollar. 50 cents each. Book Department, Radio Digest, 510 North Dearborn Street, Chicago.

BOOKS

Slightly soiled books on Radio. Write for list and prices. Book Dept., Radio Digest, 510 North Dearborn Street, Chicago, Ill.

RADIO

Long Distance Radio \$2.95. Lambert's newest crystal success. No tubes. No batteries. No grief. Always ready. Works 600 miles. Fully guaranteed. We pay postage. Order direct from this ad. Leon Lambert, Wichita, Kansas.

DIRECTIONS FOR REQUESTING INFORMATION

The Questions and Answers department offers service to Radio Digest subscribers without charge and, to those not subscribers, the same service with a charge of 50c for each letter requiring up to three answers or diagrams. We feel that this policy is necessary for the protection and best interests of our regular readers, as the volume of correspondence to this department has increased to such an extent that it is almost impossible to give our subscribers' letters adequate attention nor a complete answer. To those who have long been newsstand readers this may, at first, seem an injustice but a little thought on the matter will show that this is the only possible solution of what has been, to the technical department, a very perplexing and difficult problem. We ask that the following suggestions be read carefully before writing:

- 1—Search carefully the back issues which you have, as the point in question has probably been covered several times before.
- 2—The book, "Radio Receivers," given free with each yearly subscription (when received by Radio Digest direct with full remittance of \$5), contains the answers to the majority of the questions asked. If you have this book, go through it thoroughly and it is probable that you will find the solution of your problem.
- 3—Letters for this department should be kept separate from all correspondence to other departments and on other subjects.
- 4—Questions should be written on one side of paper only and each sheet should bear the sender's name and address. All letters should be accompanied by a self-addressed stamped envelope of standard business size.
- 5—Unsigned (or anonymous) letters cannot be answered, either on

this page or by letter, nor can those without address.

6—No comparative statements on advertised apparatus will be given except as to efficiency in some particular circuit.

7—Drawing diagrams on a separate sheet of paper will save time and enable us to give all questions more attention.

8—Write each question as a separate paragraph.

9—Keep a copy of your letter and diagrams, to which we can refer without re-drawing.

10—The names and addresses of the writers of letters published will not be released except with the writer's permission.

11—We want to be of assistance to you in your difficulties, but are sometimes limited because of the length and time required for the proper consideration of the questions asked. Therefore, please make your letters brief.

loop for use with this set as with every one I have wound and tried on the outfit, the loop tuning condenser tunes so low that I cannot get below 300 meters. How can I get about 100 feet of wire on a loop so as to get the low wave lengths. I tried a standard manufactured loop with center tap and it was the same way.

Please advise how to make one or recommend a loop, with center tap, that I can buy.

A.—The variable condenser for tuning the first detector grid circuit, whether

GO into the RADIO BUSINESS

We specialize in Equipping New Dealers with entire stock—advice free.
Send for Our Radio CATALOG & BARGAIN LISTS Wholesale Only
MANHATTAN RADIO COMPANY
112 Trinity Place New York City

How to Get More Pleasure from Radio

You can now have a new 64 page loose leaf perpetual log. Corrected sheets may be secured as changes in calls, wave lengths, owners, addresses, etc., occur. Holds 504 stations. Shows 4 dial settings, remarks, etc. Tuning suggestions. Station list by wave lengths in meters and kilocycles. List by states. Trouble preventions. Trouble finders. Full of other valuable information. So convenient. Worth many times small cost. Many hours pleasure. Only \$1.
Pay postman after log and FREE map arrive. Postpaid if pay with order. Money refunded if not delighted. Order now. Radio Printers, Dept 9918, Marengo, Ill.



World Storage "B" Battery

32 Cells Lasts Indefinitely—Pays for Itself
Economy and performance unheard of before. Recharged at a negligible cost. Approved and listed as Standard by leading Radio Authorities, including Pop. Radio Laboratories, Pop. Sci. Inst. Standards, Radio News Lab., Reflex, Inc., and other important institutions. Equipped with Solid Rubber Case, an insurance against acid and leakage. Extra heavy glass jars. Heavy, rugged plates. Order yours today!
SEND NO MONEY Just state number of batteries wanted and we will ship day order is received. Extra Offer: 4 batteries in series (96 volts), \$12.75. Pay expressman after examining batteries. 6 per cent discount for cash with order. Mail your order now!
WORLD BATTERY COMPANY
1219 So. Wabash Ave., Dept. 76 Chicago, Ill.
Makers of the Famous World Radio "A" Storage Battery
Prices: 6-volt, 100 Amp. \$11.25; 120 Amp. \$13.25; 110 Amp. \$14.00.
All equipped with Solid Rubber Case.

Set your Radio Dials at 210 meters for the new 1000 watt World Storage Battery Station, WBSB, Chicago. Watch for announcements.
World STORAGE BATTERIES
WBSB—WBR—WIS—KID—KGO—KAKA—WOL—KGO

An Up-To-Date BROADCASTING LOG

"THE BLUE BOOK OF THE AIR" is a 24-page Log Book containing all stations (nearly 600) in the U. S.—also principal Canadian and Islands stations—arranged by states and call letters, showing location and power. This book has three blank spaces for your dials. It is printed on high grade paper—ink will not blur.

Price 50c, Post Paid—3 for \$1.00

Last Year's Log, 10c, Post Paid

Money Refunded If Not Satisfied

An Attractive Advertising Proposition for Radio Dealers—Write Us NOW

ALEXANDER & WATSON
476 Century Bldg. Indianapolis, Ind.

The Air Line Radio Map and Log



This Map is Up-to-Date When You Get It and Is Kept That Way

monthly supplemental service, for the whole season.

Order NOW for Real Radio Enjoyment—Printed in three colors. Price 50c.

Lists stations by call letters, also by wave lengths. UNIQUE BROADCASTING SCHEDULE. LOG shows location, difference in time; power, meters and kilocycles; spaces to list dial settings; time heard, distance, signal strength. Whether you use outdoor aerial or loop.
At your dealers, or sent postpaid. Dealers and Jobbers Write at Once.
MULTIVIDER CO. ST. JOHN and ASKEW
KANSAS CITY, MO.

on coupler or loop, was supposed to be .0005 mfd. as specified. Practically all loops on the market, and all printed instruction in publications for making them, are for use with that capacity, whether center tapped or not. It looks to us as though your loop tuning condenser was larger than .0005 mfd. Presuming the condenser is a .0005 mfd., and a standard loop is used, KSD or KYW should come in at 90 or above on the dial. That being the case, you should certainly be able to get down to 220 meters at least. If, on a standard loop, either of these stations comes in below 80 or 75, the tuning condenser is more than .0005 mfd. maximum. The writer has, and constantly uses, an Ajax, a Mattison, a Volumax and a Lincoln loop. Any of these, with genuine .0005 mfd. condensers, cover the range perfectly and put WOK, 217 meters, at about 9 on the dial.

FREE RADIO STAMPS

168 beautiful copper etched American, Canadian, and European stamps, (8 colors), each with call letters of a station, FREE with latest Ideal 48-page Radio Stamp Album and Log. Also contains complete list of stations both alphabetically and by call letters. As you hear new stations, just put proper stamps in album. A fascinating hobby. Album and stamps become permanent record of stations you hear. You and your children will enjoy it. Complete album, 8"x11", heavy cover. \$1.98 plus postage.

Send No Money

Pay postman after album and FREE stamps arrive. We prepay postage if you prefer to pay with order. MONEY REFUNDED if not DELIGHTED. Send order today—NOW. Postal will do. IDEAL CO., Dept. 9418, 366 Wrigley Bldg., Chicago

22 1/2 Volt

un-acid over-lasting rechargeable "B" STORAGE BATTERY \$2.95 Includes Chemical

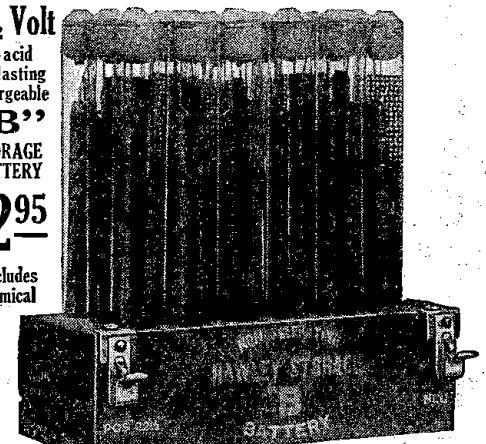

45 volts, \$5.25; 90 volts, \$10.00; 112 1/2 volts, \$12.50; 135 volts, \$14.75; 157 1/2 volts, \$16.80. Truly the biggest buy today. Easily charged on any current including 32-volt systems. Any special detector plate voltage had. Tested and approved by leading authorities such as Popular Radio Laboratories. Over 3 years sold on a non-refundable 30-day trial offer with complete refund if not thoroughly satisfied. Further guaranteed 2 years. Knock-down kits at great savings. Complete "Hawley" "B" battery charger, \$2.75. Sample cell, 35c. Order direct—send no money—simply pay the expressman cost on delivery. Or write for my free literature, testimonials and guarantee. Same Day shipments. B. Hawley Smith, 317 Washington Ave., Danbury, Conn.

Make \$100 Weekly—I Will Show You How!

YOU can do it in your spare time—evenings. Lay the foundation for a permanent, profitable business of your own. Give it all your time when you've proven the big opportunities it holds for you. Sell what the public wants—

Sell Radio In Spare Time!

Demonstrate the Ozarka in your own home or in your prospect's home. Sales experience not necessary—wetch you! Ozarka instruments priced right, with sales helps, national and local advertising, make your selling easy.

12 Selling Lessons FREE!

The Ozarka plan of selling radio is entirely different. Most practical—easier to explain. Sales are made quicker and easier. Knowledge of radio not necessary—we teach you every detail without charge! Our success with 3,100 men proves the merit of our teaching.

3,100 Men Are Doing It!

The Ozarka organization today consists of 3,100 men. In territory not now covered the right man is wanted. \$100 weekly in spare time is not unusual. Many Ozarka men are making far more—some have been with us for three years.

FREE Book Tells How—

Write me personally—tell me about yourself, and I'll see that my 64 page book, Ozarka Plan No. 100, is sent you without cost. Please mention the name of your county. To be sure of my personal attention, attach coupon below, to your letter.

J. Matheson Bell, Pres.
OZARKA INCORPORATED
122 Austin Avenue C. Chicago, Illinois

Gentlemen: 9-25-192C
I am greatly interested in the FREE BOOK "The Ozarka Plan" whereby I can sell your radio instruments.
Name.....
Address..... City.....
County..... State.....

Radiophone Broadcasting Stations

Corrected Every Week—Part I

United States

AT9, Fort Bragg, N. C. 435 meters. 750 watts. U. S. Government. Announcer, Lieut. James Y. LeGette. Slogan, "The Pioneer Broadcasting Station of the Army." Thurs, Sat, 8-9:55 pm, dance music, talks, bands, fights. Sun, 8-9:55 pm, service. Eastern.

KDKA, E. Pittsburgh, Pa. 309.1 meters. 1,000 watts. Westinghouse Elec. & Mfg. Co. Announcer, H. W. Arlin. Slogan, "The Pioneer Broadcasting Station of the World." Daily ex Sun, 9:45-10 am, 11:55, time, 12, market reports, weather; 2:30-5:30, baseball, music; 7, baseball; 9:55, time, daily except Sun, 8:30 pm; 8:45, concert; 9:55, time, Sat, 8:45 pm, concert; 9:55, time, Tues, Thurs, 10:30 pm, Sun, 9:45 am, 3 pm, 3:45, 6:45, Eastern.

KDLR, Devils Lake, N. Dak. 231 meters. 5 watts. Radio Elec. Co.-Wilson Ins. Agency. Daily ex Sun, 12:10 pm, weather; orchestra. Mon, 9:30-11:30 pm, Sun, 4:30-6, Central.

KDPM, Cleveland, O. 250-1817 meters. 750 watts. Westinghouse Elec. & Mfg. Co. Announcer, H. W. Irving. Experimental station.

KOYL, Salt Lake City, Utah. 245.8 meters. 50 watts. Newhouse Hotel. Announcer, Gene Pack. Slogan, "Out on the Great Divide." Daily ex Sun, 3-4 pm, 6:30-8, news, music, entertainment. Sun, 11-11 am, Mountain.

KDZB, Bakersfield, Calif. 209.7 meters. 100 watts. Frank Sturt. Daily ex Sun, 8-9 pm, reports, music. Pacific.

KFAB, Lincoln, Nebr. 340.7 meters. 1,000 watts. Nebr. braska Buick Auto Co. Announcer, Gayle Grubb. Daily ex Sun, Thurs, 3-4 pm; 5:30-6:30; 8:30-10:30, Thurs, 3-4 pm, Sun, 4 p. m. Central.

KFAD, Phoenix, Ariz. 273 meters. 100 watts. Electrical Equip. Co.-McArthur Brothers Mercantile Co. Announcer, Arthur C. Anderson. Slogan, "Where Summer weather, stock reports, music. Mountain.

KFAJ, Boulder, Colo. 261 meters. 100 watts. Univ. of Colo. Announcer, F. M. Orsborn. Tues, Sat, 9 pm, time, music, addresses by faculty. Thurs, 7:30 pm, Sat, 2:30-5 pm, sports. Mountain.

KFAN, Moscow, Idaho. 231 meters. 50 watts. University of Idaho.

KFAU, Boise, Idaho. 278 meters. 750 watts. Boise H. S. Announcer, Hoyt Cooper. Slogan, "Intermountain Station." Daily ex Sat, Sun, 4-4:45 pm, markets, weather, news. Mon, Fri, 8-10 pm, concert. Wed, 8-9 pm, Mountain.

KFAW, Santa Anna, Calif. 214.2 meters. 50 watts. Radio Den. Off the air temporarily.

KFBB, Havre, Mont. 275 meters. 50 watts. F. A. Buttery Co. Announcer, C. O. Boettger. Daily ex Sun, 12:45 pm, music, markets, weather, reports. Mountain.

KFCB, San Diego, Calif. 244 meters. 100 watts. W. K. Azbill. Sun, 9-10 am, Bible lesson, sermon. Tues, Thurs, 8-9 pm, Pacific.

KFBG, Tacoma, Wash. 249 meters. 50 watts. First Presbyterian church. Pacific.

KFBK, Sacramento, Calif. 248 meters. 100 watts. Sacramento Bee. Mon, Thurs, Sat, 7:30-10 pm, Pacific.

KFBL, Everett, Wash. 224 meters. 100 watts. Lesse Bros. Daily, 7:15-8:15 pm, Pacific.

KFBS, Trinidad, Colo. 238 meters. 15 watts. School District No. One.

KFBV, Laramie, Wyo. 270 meters. 500 watts. Bishop N. S. Thomas.

KFCB, Phoenix, Ariz. 238 meters. 100 watts. Nielsen Radio Supply Co. Announcer, E. A. Nielsen. Slogan, "When it's Wintertime in Michigan, it's Summer Time Down Here." Daily 7-7:30 pm, bedtime stories. Mountain.

KFCO, Helena, Mont. 248 meters. 10 watts. The First Baptist church.

KFCF, Walla Walla, Wash. 256 meters. 100 watts. Frank A. Moore. Slogan, "The Valley They Liked So Well They Named It Twice." Mon, 8-10 pm, Thurs, Fri, 8-12 midnight, Pacific.

KFCY, Le Mars, Ia. 252 meters. 50 watts. Western Union College. Announcer, D. O. Kime. Slogan, "College on the Hill." Fri, 9-11 pm, Central.

KFDD, Boise, Idaho. 275 meters. 50 watts. St. Michael's Episcopal Cathedral. Announcer, E. Mark Hanford. Sun, 11:15-12:30 pm, 7:30-9:15, Mountain.

KFDH, Tucson, Ariz. 258 meters. 50 watts. Univ. of Ariz. Announcer, Max Voss Kuefer. 500 watts. Oregon Agricultural College.

KFDM, Beaumont, Tex. 315.6 meters. 500 watts. Magnolia Petroleum Co. Announcer, Magnolene Mike. Slogan, "Call for Dependable Magnolene." Tues, Fri, 12:30-12:55 pm, band concert; 7-7:30, children's hour; 8-10:30, concerts. Sun, 11-12 m, 8-9 pm, Central.

KFDX, Shreveport, La. 250 meters. 100 watts. First Baptist church. Announcer, Hugh Claycomb. Sun, 7:50 am; 7:45 pm, Wed, 9-10 pm, Central.

KFDY, Brookings, S. D. 273 meters. 50 watts. S. D. State College. Announcer, G. A. Rietz. Daily ex Sun, 12:15 pm, livestock markets. Tues, 11-12 m, exercises. Thurs, 8-9 pm, programs. Central.

KFDZ, Minneapolis, Minn. 231 meters. 10 watts. Harry O. Iverson.

KFEG, Portland, Ore. 248 meters. 50 watts. Meier & Frank Co., Inc. Daily ex Sun, 12 m, weather, reports; 4-5 pm, music; 6:30 pm, weather, crop, markets, reports. Sat, 11 am-12 m, children's hour. Pacific.

KFEL, Denver, Colo. 254 meters. 50 watts. W. L. Winher, Inc. Announcer, Eugene P. Fallon. Daily ex Sun, 11 am, 2 pm, 4, Thurs, Sat, 8-12 midnight, Sleep Wrecker program. Mountain.

KFEQ, Oak, Neb. 263 meters. 500 watts. J. L. Serogin. Announcer, Clarence Koch. Daily ex Sun, 2-3 pm, orchestra. Sun, 4:30-6 pm, Central.

KEEY, Kellogg, Ida. 233 meters. 10 watts. Bunker Hill & Sullivan Mining & Con. Co. Announcer, Walter C. Clark. Slogan, "Voice of the Coeur d'Alene. Closed for the summer." 50 watts. First KFFP. Moberly, Mo. 242 meters. 100 watts. First Baptist Church. Announcer, Granville Ray. Slogan, "The Gospel Messenger of the Air." 50 watts. KFFV, Lamoni, Ia. 250 meters. 100 watts. Grace-land College. Mon, Thurs, 7:30 pm, Sun, 7:45 pm, service. Central.

KFGC, Baton Rouge, La. 268 meters. 100 watts. Louisiana State University. Temporarily off the air.

KFGD, Chickasha, Okla. 252 meters. 200 watts. Okla. College for Women. Tues, Thurs, 8 pm, music, lectures. Wed, 10 am, chapel service. 11 pm, special jazz program. Central.

KFGH, Stanford Univ., Calif. 270.1 meters. 500 watts. Leland Stanford Junior University. No regular schedule.

KFGI, Boone, Ia. 226 meters. 10 watts. Cray Hardware Co. Announcer, Harold E. Wilcox. Slogan, "Daniel Boone Station." Wed, 8-9 pm, Sun, 3-4 pm, Central.

KFGX, Orange, Tex. 250 meters. 500 watts. First Presbyterian church.

KFHA, Gunnison, Colo. 252 meters. 50 watts. West-ern State College of Colorado. Announcer, E. Rus-ell Wigham. "Where the Sun Shines Every Day." Tues, Fri, 6:30 pm, bedtime story; 8 pm, musicale; 10:30, orchestra. Mountain.

KFHL, Oskaloosa, Iowa. 240 meters. 10 watts. Penn College.

KFI, Los Angeles, Calif. 467 meters. 3000 watts. Earle C. Anthony, Inc. Announcer, Glen Rice. Slogan, "The Radio-Central Super-Station." Daily ex Sat, Sun, 5:30-6:30 pm, 6:45-11, Sat, 5:30-6:30 pm, 6:45-8 am, Sunday, 10-10:45 am, 4-5 pm, 6:30-11, 11-12:30 pm, first and third Sun of month. Pacific.

KFIF, Portland, Ore. 248 meters. 100 watts. Benson Tech. School.

KFIO, Spokane, Wash. 265.3 meters. 100 watts. Radio Club of North Central H. S. Fri, 8-9:30 pm, Pacific.

KFIP, Yakima, Wash. 256.3 meters. 100 watts. First Methodist Church. Announcer, Dr. I. M. Miller. Daily ex Sun, 7:30 pm, organ. Sat, 7 pm, Sun, 11 am, 7:30 pm, Pacific.

KFIU, Juneau, Alaska. 226 meters. 10 watts. Alaska Elec. Light & Power Co. Announcer, O. E. Shoem-bell. Mon, Wed, Fri, 6-7 pm, Alaskan, 100 watts.

KFIZ, Fond du Lac, Wis. 273 meters. 100 watts. Daily Commonwealth and Wisconsin Radio Sales, Inc. Announcer, Albert Mayer. Daily ex Sun, 5 pm, music, news, markets, weather. Central.

KFJB, Marshalltown, Iowa. 248 meters. 10 watts. Mar-

shall Elec. Co. Announcer, E. N. Peak. Slogan: "Marshalltown, the Heart of Iowa." Daily ex Sun, 10 am, markets. Tues, Fri, 8:30 pm, Central.

KFJC, Junction City, Kan. 218.8 meters. 10 watts. R. B. Pegan.

KJFF, Oklahoma City, Okla. 261 meters. 500 watts. National Radio Mfg. Co. Announcer, Tired Hand. Slogan: "Radio Headquarters." Daily ex Sun, 9-9:40 am, 12:15 pm, markets; 2:15, markets; 6:30, weather news. Mon, Fri, 8:30-10:30 pm, orchestra. Wed, 7:30 pm, Thurs, 9 pm, band concert. Sun, 11 am; 8 pm, church services. Central.

KFJJ, Astoria, Ore. 246 meters. 10 watts. E. E. Marsh and Liberty Theater. Announcer, E. E. Marsh. Wed, Fri, 10-11 pm, organ. Sun, 10:30-11 pm, Pacific.

KFJM, Grand Forks, N. D. 278 meters. 100 watts. University of North Dakota. Slogan: "Grand Forks, the Educational Center of the State."

KFJR, Portland, Ore. 263 meters. 50 watts. Ashley C. Dixon & Son. Mon, Tues, Wed, Thurs, 7:30-8 pm, Mon, 8-8:30 pm, Tues, 9-10:30 pm, Wed, 8-8:30 pm, Thurs, 7:30-10:30 pm, Sat, 1:30-2 pm, Pacific.

KFJX, Cedar Falls, Iowa. 258 meters. 50 watts. Iowa State Teachers' College. Educational programs.

KFJY, Fort Dodge, Iowa. 246 meters. 50 watts. Tun-Wall Radio Co. Announcer, Carl Tunwall. Daily 5-15 pm, markets, news, weather, bulletins. Sun, 11 am, Central.

KFJZ, Fort Worth, Tex. 254 meters. 50 watts. South-western Baptist Theological Seminary.

KFKA, Greeley, Colo. 273 meters. 50 watts. Colorado State Teachers' College. Announcer, Charles F. Valentine.

KFKQ, Conway, Ark. 250 meters. 100 watts. Conway Radio Lab.

KFKU, Lawrence, Kan. 275 meters. 500 watts. University of Kansas. Announcer, John F. Patt. Slogan, "Up at Lawrence on the Kaw." Mon, Thurs, 6:55-8 pm, Central.

KFKX, Hastings, Nebr. 288.3 meters. 2000 watts. Westinghouse Elec. & Mfg. Co. Slogans, "The Em-press of the Air," "The Pioneer Re-Broadcasting Station of the world." Daily ex Sat, Sun, 9:30 am,

7:30-9, church services. Mon, 9-10:30 pm, music. Central.

KFOX, Omaha, Nebr. 248 meters. 100 watts. Board of Education. Technical High. Announcer, Juno Johnson. Sept., 1926.

KFOY, St. Paul, Minn. 252 meters. 50 watts. Beacon Radio Service. Thurs, 11-12 m, Sun, 3:30-4:30 pm, Central.

KFPG, Los Angeles, Calif. 238 meters. 100 watts. *K. M. Turner Radio Corp.

KFPL, Dublin, Tex. 252 meters. 15 watts. C. C. Baxter, announcer.

KFPM, Greenville, Tex. 242 meters. 10 watts. The New Furniture Co. Announcer, Dave Ablowich, Jr. Slogan: "The New Furniture Co., the Home of Good Furniture, Located at Greenville, Texas, Where You Find 'The Blackest Land, the Whitest People.'" Daily ex Sun, 2 pm, music. Tues, Wed, Thurs, Fri, 8 pm, Sun, 11 am, services; 7:30 pm, irregularly. Central.

KFPR, Los Angeles, Calif. 231 meters. 500 watts. Los Angeles Co. Forestry Dept. Irregular schedule.

KFPW, Cartersville, Mo. 258 meters. 20 watts. St. John M. E. church, S. S. Slogan, "Keeping Pace with Christ Means Progress." Tues, Fri, 8-10 pm, popular program. Sun, 1-3 pm, chapel service. Central.

KFPY, Spokane, Wash. 266 meters. 100 watts. Symons Investment Co. Announcer, E. B. Craney. Daily ex Sun, Tues, 7-7:45 pm, Wed, 9-11 pm, Sun, 9-10 pm, Sat, 2-4 pm, Pacific.

KFOA, St. Louis, Mo. 261 meters. 100 watts. The Principia. Sun, 8 pm, church service. Central.

KFOB, Fort Worth, Tex. 263 meters. 2,500 watts. The Searchlight Pub. Co. Announcer, Horace B. Greene.

KFOC, Taft, Calif. 231 meters. 100 watts. Kidd Bros. Radio Shop.

KFOP, Iowa City, Iowa. 224 meters. 10 watts. George S. Carson, Jr. Wed, 8-9 pm, Central.

KFOQ, Denison, Tex. 252 meters. 10 watts. Texas National Guard. Announcer, Robert Cox.

KFOU, Holy City, Calif. 217.3 meters. 100 watts. W. Riker. Announcer, Arthur J. Landstrom. Daily ex

"The Voice of Automobile Row." Mon, Wed, Sat, 9:30-11 am; 8-10:30 pm, Pacific.

KFUZ, Virginia, Minn. 248 meters. 10 watts. Burton Hiers and Albin Lofback. Y. M. C. A. Closed until Sept., 1926.

KFVD, San Pedro, Calif. 205.4 meters. 50 watts. McWhinnie Elec. Co.

KFVE, University City, Mo. 240 meters. 500 watts. Film Corp. of America. Slogan, "You Will Always Know KFVE by the Tick of Her Clock." Daily ex Thurs, Sun, 10-12, Central.

KFVG, Independence, Kan. 236 meters. 10 watts. First Methodist Episcopal church. Sun, services.

KFVH, Manhattan, Kan. 218.8 meters. 10 watts. Whan Radio Shop. Announcer, Herbert Whan. Slogan, "Kansas Fans Very Happy." Daily ex Sun, 12 m, markets. Thurs, 8-12 midnight, dance music. Fri, 7:30-9 pm, Central.

KFVI, Houston, Texas. 240 meters. 10 watts. Head-quarters Troop 56th Cavalry Brigade.

KFVN, Welcome, Minn. 227 meters. 10 watts. Carl E. Bagley. Announcer, C. F. Gaarntum. Slogan, "The Voice of Martin County." Mon, Wed, Fri, 12:30 pm, markets; Sun, 3 pm, Central.

KFVR, Denver, Colo. 244 meters. 50 watts. Moon-light Ranch Broadcasting Station. Mon, Fri, 10-12 midnight, Tues, Sat, 8-9 pm, Wed, Thurs, 12-1 am, Mountain.

KFVS, Cape Girardeau, Mo. 224 meters. 50 watts. Cape Girardeau Battery Station.

KFVU, Eureka, Calif. 209.7 meters. 5 watts. Standard Pub. Co. Slogan, "On the Redwood Highway." An-nouncer, B. M. Ellis. Daily ex Sun, 12:30 pm, mar-kets, news; 6:30, Mon, Fri, 8-10 pm, Wed, 8-12 mid-night, Pacific.

KFVW, San Diego, Calif. 246 meters. 500 watts. Air-aid Radio Corp.

KFVX, Bentonville, Ark. 236 meters. 10 watts. Radio Shop. Daily ex Sun, 9-12 midnight, Central.

KFVY, Albuquerque, N. M. 250 meters. 100 watts. Radio Supply Co. Announcer, J. F. Walsh. Slogan, Center of the Sunshine State." Daily ex Sun, 5:30-6:30 pm, dinner concert; baseball. Tues, Fri, 8-9:30 pm, dance music. Mountain.

KFWA, Ogden, Utah. 261 meters. 500 watts. Brow-ning Brothers Co. Announcer, H. C. Mailander. Slogan, "Keeping Friends with All." Daily ex Sun, 4-5 pm, Zenith hour, stocks, markets, time. Mon, Wed, Fri, 9-10 pm, music. Mon, Wed, 10-11 pm, Sun, 9-12 midnight, music. Mountain.

KFWB, Hollywood, Calif. 252 meters. 500 watts. War-ner Brothers.

KFWC, Upland, Calif. 211.1 meters. 500 watts. L. E. Wall.

KFWD, Arkadelphia, Ark. 266 meters. 500 watts. Ar-kansas Light & Power company.

KFWH, Chico, Calif. 254 meters. 100 watts. P. Wellington Morse, Jr. Slogan, "Kind Friends We're Here." Daily 6:30-7:15 pm, dinner concerts. Daily ex Sun, 6:15-6:30 pm, news, music. Mon, Wed, Fri, 8-10 pm, Pacific.

KFWI, South San Francisco, Calif. 220 meters. 500 watts. Radio Entertainment, Inc.

KFWF, St. Louis, Mo. 214.2 meters. 250 watts. St. Louis Truth Center.

KFWM, Oakland, Calif. 206.8 meters. 500 watts. Oak-land Educational Society.

KFWO, Avalon, Calif. 211.1 meters. 250 watts. Major Lawrence Mott-Signal Corp. Slogan, "Katalina for Wonderful Outings." Daily, 7:30-9 pm, Tues, Thurs, Fri, Sun, 5-9 pm, Pacific.

KFWP, Brownsville, Tex. 214.2 meters. 10 watts. Rio Grande Radio Supply House.

KFWU, Pineville, La. 238 meters. 100 watts. Louisiana, La.

KFWV, Portland, Ore. 212.6 meters. 5 watts. Wilbur Herman.

KFXB, Big Bear Lake, Calif. 202.6 meters. 500 watts. Bertram O. Heller. Announcer, Charles Stillwell. Slogan, "Rim of World Super Station." Mon, 5-5:30 pm; 9-11, Daily ex Sun, 8-9 pm, Pacific.

KFXC, Santa Maria, Calif. 209.7 meters. 100 watts. Santa Maria Valley Railroad Company.

KFXD, Logan, Utah. 205.4 meters. 10 watts. L. H. Strong.

KFXE, Waterloo, Ia. 236 meters. 10 watts. Electrical Research & Mfg. Co. Announcer, G. Pelton.

KFXF, Colorado Springs, Colo. 250 meters. 1200 watts. Pikes Peak Broadcasting Company. Announcer, W. D. Pyle. Slogan, "The Pikes Peak Station."

KFXH, El Paso, Tex. 242 meters. 50 watts. Bledsoe Radio Company. Slogan, "The Voice of the Rio Grande." Mon, Wed, Fri, 8-10 pm, Central.

KFXJ, Colorado. 215.7 meters. 10 watts. Mountain States Radio Distributors, Inc. (Portable).

KFXM, Beaumont, Tex. 227 meters. 10 watts. Neches Elec. Co.

KFXN, Flagstaff, Arizona. 205.4 meters. 50 watts. *Mary M. Costigan.

KFYD, Muscatine, Iowa. 256 meters. 250 watts. N. Baker.

KFYF, Oxnard, Calif. 205.4 meters. 10 watts. Carl's Radio Den.

KGB, Tacoma, Wash. 249.7 meters. 100 watts. Tacoma Daily Ledger. Announcer, Alvin Stens. Slogan, "This is KGB in Tacoma, Washington, the Lumber Capital of America and the Gateway to Mount Tacoma." Mon, Wed, Fri, 7-9 pm, Tues, Thurs, Sat, 7-12 midnight, Pacific.

KGO, Oakland, Calif. 361.2 meters. 3000 watts. Gen. Elec. Co. Announcer, Howard I. Millholland. Daily ex Sun, 7:15-7:45, 8:15, am, exercises; 8:30, daily strength; 11:30 am, luncheon concert. Daily ex Sat, Sun, 1-3 pm; Sat, 12:30 pm, markets, weather. Mon, Wed, Fri, 3 pm, music. Daily ex Sun, Mon, 4-5:30 pm, concert orchestra. Mon, Tues, Wed, Fri, 6-7 pm, music; Mon, Tues, Thurs, Sat, 8-10 pm, lectures, music. Thurs, Sat, 8-12, Mon, 5:30-6 pm, Children's half hour; Mon, Tues, Wed, Thurs, Fri, 7 pm, stocks, markets, weather, baseball. Thurs, 5:30-6:30 pm, boys' hour. Fri, 5-5:30 pm, girls' half hour; Sat, 11-12 pm, 8 pm, church services; 3:30-5 pm, Little Symphony orchestra. Pacific.

KGTT, San Francisco, Calif. 206.7 meters. 50 watts. * Glad Tidings Tabernacle.

KGU, Honolulu, Hawaii. 270 meters. 500 watts. Marlon A. Mulroyn. The Honolulu Advertiser. Announcer, W. K. Karmen. Daily, 7:30-9 pm, Tues, Thurs, Sat, special program. Sun, 11 am, 7:30 pm, 1:50 meridian, 2 1/2 hours earlier than Pacific.

KGW, Portland, Ore. 491.5 meters. 500 watts. Port-land Morning Oregonian. Announcer, Dick Haller. Slogan, "KGW, Keep Growing Wiser." Daily ex Sun, 11:30-11:45 am, weather; Mon, Wed, Fri, 7:15-7:30 am, exercises. Daily ex Sun, 12:30-1:30 pm, Mon, Tues, Wed, Thurs, Fri, 7:30-7:45 pm, weather, police, markets, news. Mon, Tues, 8-10 pm, Tues, Sat, 10-12, Wed, 8 am, 10-11, Fri, 9-10:30 pm; 10:30-12, Hoot Owls. Sun, 10:30-12 m, 7:30-9, Pacific.

KGY, Lacey, Wash. 246 meters. 50 watts. St. Martins College. Announcer, Sebastian Ruth. Slogan, "Out Where the Cedars Meet the Sea." Sun, Tues, Thurs, 8:30-9:30 pm, Pacific.

KHJ, Los Angeles, Calif. 405.2 meters. 500 watts. Los Angeles Times. Announcer, John S. Dargett. Slogan, "Kindness, Happiness, Joy." Daily ex Sun, Mon, 7 am, 7:30, 12 m, 1:30 pm, 2:30, 3:30, 5:30, 11, Mon, 7-7:30 am, 12-1:30 pm, Sun, 10-12:30 pm, 6-7:30, 8-11, Pacific.

KHQ, Spokane, Wash. 273 meters. 1,000 watts. Louis Wasmer.

KIAF, Siltipoc, Minn. 421 meters. 500 watts. Steele Co. Slogan, "Far from the Maddening Crowd." Mon, Wed, Fri, 7-8 pm, Sun, 2-3 pm, Central.

KJBS, San Francisco, Calif. 220 meters. 5 watts. Julius Brunton & Sons Co. Announcer, Edward Ludes. Daily 2-3:30 pm, Tues, Thurs, Fri, 9-11:30 am, Fri, 8-11:30 pm, Royal Order Smoked Herring." Pacific.

KJR, Seattle, Wash. 384.4 meters. 1000 watts. North-west Radio Service Co. Announcer, Ross W. Swift. Slogan, "Radio Headquarters." Daily ex Sun, 10:30-11:30 am, educational program; 1-1:15 pm, stocks; 1:15-2, organ; 2-2:15, cooking; 2:15-2:30, produce re-port; 6-6:30, theater news; 7-11, Sun, 11-12:30 pm, service; 7-7:30, organ; 7:30-9, service. Pacific.

(Note—The second part of the station data list will appear next week.)

CHALLENGE!

ONE DOLLAR will be paid to the Radio fan submitting the most errors in any one station's listing in this directory. Letters must reach Radio Digest office not later than one week from date of issue corrected. Readers are not limited to correcting one station, but such corrections must be certified by the stations themselves, and NOT by comparison to other so-called accurate broadcasting directors and lists. Readers also must live in same state or province as stations corrected are located. Station verifications must accompany corrections.

That's just how sure Radio Digest is that this broadcasting station directory is correct! To make the challenge fair for everyone, broadcasting stations and their employees are barred from this offer. Why? Because the broadcasters are the source of all the data given herein. They are (or should be) interested enough to answer the inquiry sent them every time data on their station appears. This inquiry contains a proof of their last listing and must either be corrected or O.K'd as correct and returned to the Digest. Nevertheless,

sometimes the stations are careless and mistakes are made. But Radio Digest is so sure of the exactness of this directory that this challenge is made unconditionally.

With reference to the directory: It appears in six parts, serially continuously; the first four parts are station data listings, arranged alphabetically; the fifth part is a state, city index of stations; the sixth part is a wave length index. The information contained in each station data listing is given in the following order: Call letters, city, state, wave length used, watts antenna input, owner's name, announcer's name, slogan used if any, name of listener in "club," schedule of operating hours, and kind of time used, as "Central," "Mountain," etc. Asterisks have been placed in front of corrected listings and new stations in order to distinguish these.

Five successive issues of Radio Digest will give one the most complete and accurate list of broadcast stations obtainable. This service is original with this publication, and has been maintained from the start. Right of reproduction without permission of any or all of the data contained herein is denied.

Mon, 9-10 pm, Sun, 11-12 m, 9-10 pm, Pacific.

KFWQ, North Bend, Wash. 215.7 meters. 50 watts. The Photo Radio and Elec. Shop. Announcer, Carl F. Kiriyan. Slogan, "At the Western Entrance of Snoqualmie Pass." Daily ex Sun, 7:30-8:30 pm, Pacific.

KFQZ, Hollywood, Calif. 226 meters. 250 watts. Taft Radio company. Tues, Fri, 9-11 pm, Pacific.

KFRB, Beeville, Tex. 248 meters. 250 watts. Hall Brothers. Temporarily off the air.

KFRD, San Francisco, Calif. 268 meters. 50 watts. City of Paris Dry Goods Co.

KFRL, Grand Forks, N. Dak. 240 meters. 10 watts. Men's Club, First Presbyterian Church.

KFRM, Fort Sill, Okla. 242 meters. 500 watts. James P. Boland.

KFRU, Columbia, Mo. 499.7 meters. 500 watts. Stephens College. Wed, 8 pm, Sun, 7:30, 9:30 am, 7:30 pm, Central.

KFRW, Olympia, Wash. 218.8 meters. 50 watts. United Churches of Olympia. Slogan, "Make the World a Brotherhood." Thurs, 9-10 pm, Sun, 11-12:15 pm, Pacific.

KFRX, Pullman, Wash. 217 meters. 10 watts. J. Gordon Klemgard. Announcer, Gordon Klemgard. Slogan, "The Only Farmers Radio Station in the World."

KFSA, State College, N. M. 266 meters. 50 watts. New Mexico College of Agriculture and Mechanic Arts.

KFRZ, Hartington, Nebr. 222 meters. 15 watts. The Electric Shop. Announcer, P. M. Thies. Daily ex Sun, 11:55 am, news, markets; 4:15-5:15 pm, entertainment. Sun, 12-1:30 pm, entertainment. Central.

KFSG, Los Angeles, Calif. 275 meters. 500 watts. Angeles Temple, Tues, Thurs, Fri, Sat, 3:30-4:30 pm, Tues, 6:30-7:30 pm, Wed, 2:30-4:30 pm; 6:30-7:30, Thurs, Fri, Sat, 7:30-11 pm, Sun, 10:30-12:30 pm, 2:30-4:30, 7-9:30, Mon silent. Pacific.

KFSV, Helena, Mont. 248 meters. 10 watts. The Van Blaricom company. Wed, 7:30 pm, music, talks. Mountain.

KFUP, Breckenridge, Minn. 242 meters. 50 watts. Hoppert Plumbing & Heating Co. and Hoppert Radio Electric Co. Announcer, F. H. Rettig. Slogan, "Where the Red River of the North Finds Its Source." Daily ex Sun, 10:30 am, 5:40 pm, weather. Daily ex Sun, 10:40 am, 1:30 pm, 5:45 pm, markets. Mon, Wed, 8-9 pm, Central.

KFUL, Galveston, Texas. 258 meters. 50 watts. Thomas Grogan & Bros.

KFUM, Colorado Springs, Colo. 242 meters. 100 watts. W. D. Corley. Slogan, "Known for Unsurpassed Mountain Scenery." Tues, Sat, 8:30-10:30 pm, Sun, 11 am, 7:30 pm, Mountain.

KFUO, St. Louis, Mo. 343.1 meters. 500 watts. Concordia Theological Seminary (Lutheran). Announcer, Herm. H. Hohenstein. Mon, 8 pm, Wed, 9:15 pm, Sun, 9:15 pm, Central.

KFUV, Springfield, Mo. 252 meters. 10 watts. G. Pearson Ward.

KFUP, Denver, Colo. 234 meters. 50 watts. Fitzsimons General Hospital.

KFUR, Ogden, Utah. 224 meters. 100 watts. Peery Building Co. Tues, Thurs, Sat, 9:50-11:50 pm, dance music. Mountain.

KFUS, Oakland, Calif. 234 meters. 50 watts. The Sherman School. Slogan, "The City of Opportunity."

KFUT, Salt Lake City, Utah. 261 meters. 100 watts. University of Utah. Tues, Thurs, 12-10 pm, Mountain.

KFUU, Oakland, Calif. 215 meters. 50 watts. Mathewson Motor Co. Announcer, H. C. Colburn. Slogan,

Equip your set with Balkite Radio Power Units

*They provide unfailing, uniform
current for both circuits*

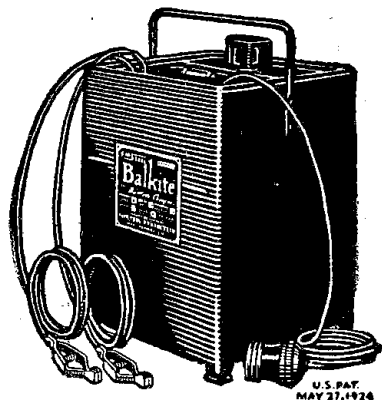

Balkite Battery Charger

This popular battery charger is entirely noiseless and can be used while the radio set is in operation. If your battery should be low you merely turn on the charger and operate the set. Charging rate 2.5 amperes. Operates from 110-120 AC 60 cycle current. Special model for 50 cycles. Also for 25-40 cycles with 1.5 ampere charging rate.

Price \$19.50
West of Rockies, \$20
In Canada, \$27.50

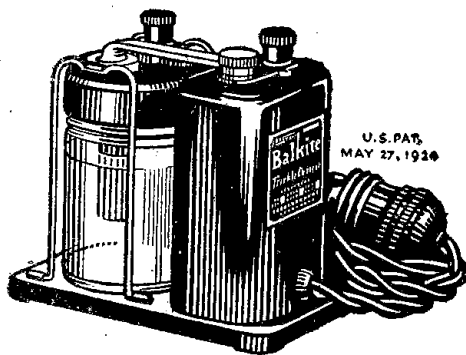

Balkite Trickle Charger

Charges both 4 and 6 volt radio "A" batteries at about .5 amperes. Usable in 3 ways: (1) As a regular charger with a low capacity storage battery for sets now using dry cells. (2) With storage battery sets of few tubes. Furnishes more current than used by 6 dry cell or 2 storage battery tubes, so that if used during operation it need be used at no other time. (3) As a "trickle" or continuous charger for sets of as many as 8 dry cell or storage battery tubes. Size 5 1/2 in. long, 2 3/4 in. wide, 5 in. high. Operates from 110-120 AC 60 cycle current. Special model for 50 cycles.

Low capacity batteries especially adapted for use with this charger with sets now using dry cells are being offered by practically all leading battery manufacturers this fall.

Reputable manufacturers are also offering this fall for use with this charger special switches which turn on Balkite "B" and turn off the charger when you turn on your set. This makes the current supply for both "A" and "B" circuits automatic in operation.

Price \$10
West of Rockies, \$10.50
In Canada, \$15

Equip your set with Balkite Radio Power Units. They improve and simplify radio reception. With their use your current supply is unfailing and always exactly what is required for each circuit. They reduce the amount of attention you give your set.

The Balkite Battery Charger is entirely noiseless and can be used while the radio set is in operation.

The Balkite Trickle Charger is especially adapted to sets of small "A" current requirements—any dry cell set, and storage battery sets of few tubes. It enables owners of sets now using dry cells to make a most economical installation.

Balkite "B" II is also well known. It was the outstanding development in radio last year. It eliminates "B" batteries and supplies plate current from the light socket. It fits any set.

The new Balkite "B" at \$35 is especially designed to serve sets of 6 tubes and less. With such sets it will perform exactly as does Balkite "B" II with sets of larger "B" current requirements.

Noiseless—No bulbs—Permanent

All Balkite Radio Power Units are based on the same principle. All are entirely noiseless in operation. They have no moving parts, no bulbs, and nothing to adjust, break or get out of order. They cannot deteriorate through use or disuse—each is a permanent piece of equipment with nothing to wear out or replace. They require no other attention than the infrequent addition of water. They do not interfere with your set or your neighbor's. Their current consumption is remarkably low. They require no changes or additions to your set.

An "A" battery, a Balkite Charger and a Balkite "B" constitute a complete, trouble-free radio power equipment, one that is economical, unfailing in operation, and eliminates the possibility of run-down batteries. At your dealer's.

Manufactured by

FANSTEEL PRODUCTS COMPANY, Inc., North Chicago, Illinois

FANSTEEL Balkite Radio Power Units

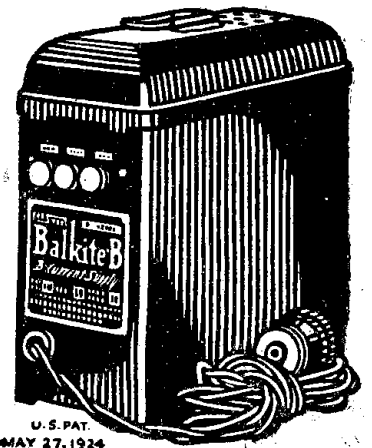

Balkite "B"

Eliminates "B" batteries. Supplies plate current from the light socket. Operates with either storage battery or dry cell tubes. Keeps "B" circuit always operating at maximum efficiency, for with its use the plate current supply is never low. Requires no changes or additions to your set. No bulbs—nothing to replace. Requires no attention other than adding water twice a year.

A new model, designed to serve any set requiring not more than 20 milliamperes at 90 volts—practically all sets of 5 tubes or less, and most 6 tube sets. Size 8 1/4 in. long, 8 in. high, 3 1/4 in. wide. Occupies about same space as 45 volt dry "B" battery. Operates from 110-120 AC 60 cycle current. Special model for 50 cycles.

Price \$35
In Canada, \$49.50

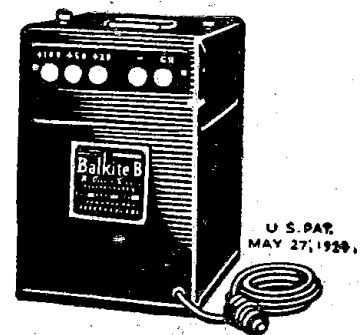

Balkite "B" II

The most outstanding development in radio last season. Same as the new Balkite "B" but will fit any set including those of 8 tubes or more. Current capacity 40 milliamperes at 90 volts. Size 9 in. high, 6 1/4 in. wide, 7 1/2 in. deep. Operates from 110-120 AC 60 cycle current. Special model for 50 cycles.

Price \$55
In Canada, \$75

The Gould Unipower, manufactured by the Gould Storage Battery Company, is equipped with a special Balkite Radio Power Unit

BALKITE BATTERY CHARGER • BALKITE TRICKLE CHARGER • BALKITE "B" • BALKITE "B" II

ALL BALKITE RADIO POWER UNITS ARE TESTED AND LISTED AS STANDARD BY THE UNDERWRITERS' LABORATORIES