

25
Second Installment of SOS Mystery

Radio Digest

EVERY
WEEK

ILLUSTRATED PROGRAMS

TEN
CENTS

Vol. XVI No. 9

Copyright 1926
Radio Digest Publis

Title Reg. U. S.
Off. &
Canada

MARCH 6, 1926



PWX, Havana, Lends Exotic Charm; "Hill Billies" Capture WRC; Women's Programs; Serial Story of "A Step On the Stairs," Now on the Air; How to Make Penetrola

I WON'T BLOOP CLUB IS AIDING RECEPTION

FANS ENTHUSIASTIC OVER EFFORT TO CLEAR AIR

Campaign Surpasses Most Extravagant Dreams of Originators as Pledge Cards Pour In

Besides the banding together of the Radio listeners in for the purpose of gaining united cooperation in the elimination of preventable interference, the I Won't Bloop club has become a veritable correspondence school. That the pledges given as applications for membership in the club were made in all sincerity is plainly evidenced by the thousands of fans who have written to the Radio Digest for solutions of their individual problems. The steady stream of signed pledge cards that is flowing into the offices of the Radio Digest would indicate that the movement will cover a greater field than the originators even dreamed. At the present time, cooperation of individuals, Radio clubs, broadcasting stations and newspapers has resulted in the most widespread movement for the betterment of Radio reception in the history of Radio.

What Pledge Means

Organizations that have received chapters in the I Won't Bloop club are sending in long lists of listeners who have pledged to operate their sets so as to reduce radiation or blooming, to equip their sets with anti-blooming devices in cases where it will benefit reception and reduce interference, and lastly, if other methods fail, to renew them with sets designed to limit howling and squealing. The immediate response given the organization clearly demonstrates the listeners realize that if each fan operates his receiver with consideration for his neighbor, one of the biggest problems of reception will be solved.

Innocent of Damage

That very little preventable interference is caused by malice is the belief of the Radio Digest. We have been vindicated in our assertion that the majority of bloopers are innocent of the damage they are causing and ignorant of what precautions should be taken to prevent it. The response to our theory that education in receiver operation will reduce the nuisance has been gratifying. Hundreds of inquiries into individual problems and thousands of letters of commendation on the series of articles on the elimination of blooming and man-made static have been received.

We feel certain that the members of the I Won't Bloop club will in the future operate their sets properly, and in doing so not only help Radio reception in their own neighborhoods, but will also manipulate their sets with greater efficiency and satisfaction by increasing their range and entertainment. The Radio Digest believes that if every listener signed and followed the pledge of the I Won't Bloop club, more would be done for Radio reception than could ever be accomplished through legislation.

Are you willing to do your part in the campaign to clear the ether? If you have not already filled out a pledge card of the organization, do so today. Read the series of blooming articles and follow the suggestions. If you have problems that have not been covered in the series to date, present them to some authority who may be able to solve your difficulties with simple explanations or adjustments.

Enlist Your Neighbor

Enlist your neighbor. Ask him to cooperate with you. Then work together. The signing of a pledge card eliminates a potential blooper. Certificates of membership have been printed and are ready for distribution.

BEAUTY ON COVER IS 1926 WAMPAS MAID

MISS JOYCE COMPTON is the fluffy-haired maiden who peeps forth so shyly from the Radio Digest cover this week. Yes, of course, she is from Hollywood, California. More than that, she is one of the 1926 models of the annual Wampas beauties recently selected by the Western Association of Motion Picture Advertisers for Fame. Miss Compton may be seen on almost any screen almost any day in any city in the United States but you will be most likely to hear her voice over the Los Angeles Express Radio station, KNX. Wampas programs are presented there every Tuesday between the hours 10 and 11 p. m., Pacific time.

PLEDGE CARD

Radio Digest

Illustrated
Reg. U. S. Pat. Off. & Dom. of Canada

I WON'T BLOOP CLUB

I pledge myself to operate my Radio set to reduce radiation or blooming. If I am unable to make my present set operate properly, I further pledge myself to replace it with a receiver that will create less interference.

Make of my set:	Signature
Number of tubes is:	Address
	City and State.....

I am cooperating in this campaign with Station.....
Upon mailing this pledge to Radio Digest, "I Won't Bloop Club" membership card suitable for wallet or framing will be issued.

Wills-Lenglen Tennis Match Broadcast Through WNAC

BOSTON.—The ability of the Radio to give the big news first was truly demonstrated recently when Station WNAC, the Shepard Stores, here, gave to New England the results of the finals in the international tennis match between Helen Wills of America and Suzanne Lenglen of France which was held at Cannes. The arrangements to broadcast this result were carefully completed by WNAC with the Boston Herald Traveler and the Associated Press.

Bill Proposes U. S. Monopoly Of Electrical Transmission

WASHINGTON, D. C.—Another Radio bill has been introduced in the house of representatives, this time by Representative Shallenberger of Illinois. The bill proposes "to secure to the United States a monopoly of electrical means for the transmission of intelligence for hire; to provide for the acquisition by the post-office department of the telephone and telegraph network; and to license certain telephone lines, Radio and telegraph agencies."

CONTENTS

Radio Digest, Illustrated, Volume XVI, Number 9, published Chicago, Illinois, March 6, 1926. Published weekly by Radio Digest Publishing Co. (Incorporated), 510 N. Dearborn Street, Chicago, Illinois. Subscription rates yearly, Five Dollars; Foreign Postage One Dollar additional; single copies Ten Cents. Entered as second class matter at the post office at Chicago, Illinois, under the Act of March 3, 1879. Title Reg. U. S. Patent Office and Dominion of Canada. Copyright 1926 by Radio Digest Publishing Co. All rights reserved.

All the Live News of Radio.....	1 to 11
FWX, Havana, Cuba, Scintillates Exotic Charm.....	4
"Hill Billies" Capture WRC.....	5
"A Step On the Stairs," Radio Digest Prize Mystery Story, Second Installment, by Robert J. Casey.....	6
Women's Page; Index to Women's Programs.....	11
An Evening at Home with the Listener In; A Chart in Eastern Time, showing when to listen in for stations.....	12
Advance Programs for the Week.....	13 to 21
Editorials, Indi-Gest and Condensed by Dielectric.....	22
A B C Radio Fundamentals for Everybody, Chapter IX—Radio Receiver Circuits, by Milo Gurney.....	23
How to Stop Blooming and Man-Made Static, Part IV—Construction of the Penetrol, by the Technical Staff.....	25
Two Tube, Short Wave, 15-130 Meter Receiver, Part IV—Adjusting and Operating, by John G. Ryan.....	27
The Reader's View.....	29
Directory of Radiophone Broadcasting Stations, Part V. (Revised).....	31

Looking Ahead

Whose Were the Snow-Covered Shoes Left at the Threshold of the "Door of Death?" Was Mary Williams as innocent as she seemed? Why did she repulse the ardent proposals of Henry Graves? Follow the "trail of the tigress" in the third installment of "A Step On the Stairs" in the next issue of Radio Digest.

Typical American Music Finds Its Elemental Source in the rhythm and chants of the American Indian, thinks Thurlow Lieurance, pianist and composer, who has spent most of his life in the study of native music, transcribing it to modern score. His story as told to WLS listeners in our next issue.

From a Nickel Picture Show in a Deserted Shoe Store to Multi-Millionaire owner of a string of amusement palaces and proprietor of Radio Station WMBB on the Trianon—"The World's Most Beautiful Ballroom"—is the history of Andrew Karzas. Story and picture in the next Radio Digest.

Boy Scouts Who Are Described as the Budding Flower of the American manhood of tomorrow have had much to do with the present success of Radio. A special page with a story from the New York headquarters is in preparation for a forthcoming issue of Radio Digest. Watch for it, boys.

Tuned R.F. Circuits, How You Get Them and Why, are an important part of Milo Gurney's next installment in the A. B. C. series. Present day Radio set owners will be interested in knowing how tuned radio frequency amplification was evolved.

More Methods for the Prevention of Blooming will be presented in the next issue by the Technical Staff. If only every listener in the country would consider the various arrangements being presented there would be no more squealing.

Newsstands Don't Always Have One Left

WHEN YOU WANT

Radio Digest

YOU WANT IT!

BE SURE OF YOUR WEEKLY COPY BY SUBSCRIBING NOW

SEND IN THE BLANK TODAY

Publisher Radio Digest,
510 N. Dearborn St.,
Chicago, Illinois.

Please find enclosed check M. O. for Five Dollars (Six, Foreign) for One Year's Subscription to Radio Digest, Illustrated.

Name

Address

City..... State.....

NEWS BRIEFS FROM THE BROADCASTERS

CINCINNATI SHRINE BAND OVER WLW WEDNESDAY

Play Shop Surprise Feature at WGN—
Repertory Frolic WBZ Success—
Irish Play at KGO

The popular Syrian Temple Shrine band, under the direction of Henry Fillmore, will return to WLW, Cincinnati, Wednesday, March 10, for a program of music and songs. This musical organization is known throughout the country for the excellence of its programs and makes two broadcasting engagements a year.

A midnight frolic and after-theater dance, the first of a series entitled "The Silver Forest," was given by the Repertory theater last Thursday at WBZ, Springfield. The affair was conducted along the lines of the famous Ziegfeld midnight frolic atop the New Amsterdam theater in New York.

An old-fashioned drama, "Kathleen Mavourneen," will be produced by the KGO players Thursday night, March 11, beginning at 8 p. m. Pacific time.

Quin Ryan and Frank Dahm are the directing geniuses behind the new Play Shop feature broadcasting at 10:10 p. m. Central time every night at WGN, Chicago. Skilled actors, readers and musicians are presenting these skits, burlesques, comedies or tragedies.

Don't turn up your nose at "Yes, We Have No Bananas." It comes of a very good family. "Its great grandfather was Handel's Hallelujah chorus," says Dr. Sigmund Spaeth, noted teacher and interpreter of music. Turning to his piano, he proves it. The highbrow learned to appreciate good jazz, and the lowbrow to understand a symphony at WLS, Chicago, last week when Dr. Spaeth gave a series of whimsical lectures on the appreciation of music.

The fans to whom the Barber Shop ballads recall pleasant memories will welcome the new trio of Shave, Haircut and Shoe Shine at WBBM, Chicago. Their old-time harmony numbers are, to say the least, unique.

The headliner artists of the WBZ programs have joined together in one large group that will be known as the WBZ Concert company. Ethel Curry, soprano; Ethel Woodman, contralto; Vincenzo Spozino, tenor, are a few of the young artists in this organization.

Whittall Anglo Persians, directed by Louis H. Katzman, may be heard on Friday nights over the WEAJ chain. Oriental music will be featured by this group.

Last week a real magician visited WLW, Cincinnati. Fans who listened to Howard Thurston's lecture on white magic have been able to pull rabbits out of hats, discover cards and handkerchiefs in strange places and in other ways puzzle their friends.

Radio fans will have an opportunity to hear the cream of Victor Herbert's musical library while listening in on Wednesday nights to "Roxy and His Gang" over WEAJ and a chain of stations. S. L. Rothafel has purchased from Ella Herbert, daughter of the famous composer, his entire personal library which contains not only Victor Herbert's own lilting melodies, but the symphonic scores, orchestrations and classic and light comedy music used by him during the many years he served as conductor of the leading orchestral organizations throughout the country.

Dressed as Mother Goose and carrying a calico goose, Miss Bessie Lillian Taft has become well known to kiddies in New England. She believes that children may learn to love animals and be kind to them and she tells her stories with this end in view. Her Radio audience of little folks dial for WTIC Mondays at 6:30 p. m. Eastern time.

An unusual program will be given Tuesday, March 9, when WLW, Cincinnati, transmits a program which was given in Hilversum, Holland. This unique event is to be broadcast by the Formica concert orchestra under the direction of William C. Stoess, and will give Radio fans the opportunity to hear a concert that is a replica of one given through broadcasting station HDO, Holland.

Wednesday afternoon will be devoted to discussions and courses in dramatics (Continued on page 21)

"MAGNETIC BLANKET" IS LIFTED

MYSTERY SERIAL IS SENSATION OF RADIO

"A STEP ON THE STAIRS" IMMEDIATE SUCCESS

Readers of Story Form and Listeners In Acclaim Work as Great Step Forward

"A Step On the Stairs" is out with a wow!

"It's a hit," wired E. H. Twamley, studio director of Station WOC, Davenport, Ia., to the Radio Digest. This was one of the first of the eighteen stations to put the remarkable story written especially for Radio transmission by Robert J. Casey on the air.

Scores of letters have been received by Radio Digest from readers who already are advancing theories as to the outcome of the story and seeking hints as to the solution of the first mysterious circumstances revealed in the first installment. Never in history has a new book come out with such an instantaneous audience. Millions will be following this remarkable story week by week as it unfolds with vivid realism in the pages of Radio Digest and through the air from the leading broadcasting stations of the nation.

Special Music Score

A special musical score of weird tunes and orchestral effects has been prepared to carry through the dramatization, serving much the same purpose as specially written music for the motion picture features. With lights turned low or enveloped in absolute darkness listeners are intrigued into an atmosphere that rustles with ghostly garments and eerie wails, the stage setting for the characters of the story. This makes possible a dramatic appreciation impossible under any other circumstances.

All the little tricks of suggestion and influence have been employed by Mr. Casey to make the listener feel in the very presence of the fantastic environment that haunts the old Turner manse where the successive owners have died and passed through the same fatal door to their graves.

Action Is Concentrated

The relatives are gathered about a table in the old hunt-room. The candles have been extinguished. They wait for the voice of the last master of the house—Peleg Turner—to come back to them through the Radio horn. He himself through his will has set the midnight hour for this mystic apparition. Then comes a shot. The voice, from a broadcasting station, states that a murder has been committed in the studio. Pandemonium follows.

In the current issue the situation becomes more tense. The thread of circumstances follows quickly. There are no tiresome descriptions. All is action and suspense. One grim incident follows another with surprising climaxes and at the end of the episode the underlying motives and unknown characters are more mysterious than ever. So far it has all taken place between 11:30 p. m. and 2 a. m.

One Man Knows Secret

Only one man knows the secret, the key to the whole situation and that man is Robert J. Casey. All the reader or listener needs to be is a mind reader and pluck the last chapter from the back of Mr. Casey's head. To be able to finish the story with a correct theory as to the outcome means a cash prize of \$250 for the best answer, \$100 for the next best answer and \$10 each for the next fifteen best answers. The details are published on page 7.

"I am very glad that some constructive effort, with the power of publicity behind it, is being made to encourage the writing of Radio drama," wrote Mrs. Wilda Wilson Church, one of the foremost producers of Radio drama in the world, in her acceptance of "A Step On the Stairs" for Station KGO, General Electric Co., Oakland, Calif.

"Count on WSB for this big idea, in Radio drama. By all means send us the dramatization of 'A Step On the Stairs,'" wired Lambin Kay, director of the Atlanta Journal broadcasting station.

An error in the Radio Digest office last week caused the publication of the wrong station for Cincinnati as the one from which "A Step On the Stairs" would be broadcast. The correct station is WLW of the Crosley Radio Corp., one of the widest range stations in the country.

Orson Stiles of WOAW, Omaha, said in accepting the Casey story, "We are not

(Continued on page 30)

CREATORS OF "THE NIGHT HERD"



NANCE O'NEIL, above, came flying halfway across the continent to play the part of Delores in "The Night Herd," the \$500 prize Radio drama which "opened" over WLS, Wednesday, February 17, before the largest first night audience for which any actress has ever had the privilege of appearing.

"The Night Herd," written by Levi Chambers Ballou, right, of Buffalo, N. Y., was produced under the direction of Alexander Dean, of the Drama League of America. George Arliss, who was one of the three judges who selected the winning play from more than five hundred entries, made the presentation of the Hoover trophy cup and the \$500 cash prize offered by WLS and the drama league, to Mr. Ballou.

Following its presentation from WLS, "The Night Herd" went on tour and played from Cincinnati, on Thursday evening, February 18; WSB, Atlanta, Friday; WRC, Washington, Saturday; WIP, Philadelphia, Monday; and closed at WGBS, New York, Tuesday.

The entire cast travelled to the various stations and made its appearance "in person."

The second prize winning play, "Back Stage," by Hilliard Booth, Brevard, N. C., for which \$200 was awarded, was to be produced at WLS on Wednesday, March 3. The play was to be toured to the same stations as presented "The Night Herd," and will be heard according to the same schedule of days.

On March 10, "Midnight," third prize play for which J. Frank Davis, of San Antonio, Texas, received \$100, will be heard from WLS, Chicago. "Midnight" will also be toured and presented from the six cities on the same days of the weeks as listed for the first prize winner.

"We have ten more plays beside the winners which we will give later," said Harry D. Saddler, director of WLS dramatic productions, "and probably thirty per cent of the five hundred plays received will be usable in some form. For



all the others produced we will pay the usual royalty."

The usual royalty per station is understood to be ten dollars a performance. This offer, it is believed, will stimulate the interest of writers in Radio.

Ear Phones Are Installed in Hospital for Canadian Vets

TORONTO, Canada.—When "Roxy" of the Capitol theatre was broadcasting for the Canadian government last summer he told of what had been done through Radio for the incurable war veterans in United States hospitals and suggested that similar work be done in Canada. To encourage the action he and his "Gang" donated \$500.

In the Christie Street hospital, here, 150 sets of ear phones have been installed to enable individual patients to listen in when the loud speakers were not in use. Although there are but 200 patients in the hospital, there are 300 beds and it is expected that each bed will be equipped with ear phones.

EXPLANATION LACKING, BUT RADIO BETTER

Leaving Brings Fans Joy

Mysterious Force That Has Enveloped Ether Departs; Reception Improves After Bad Spell

WASHINGTON, D. C.—The air is cleared again and the pale of gloom has gone. The atmosphere is once more cleared of a sinister, hovering figure, who seemed to press down upon the spirits of the Radio fans. The unknown stranger has rolled up his "magnetic blanket" that has enveloped the ether and has disappeared as silently and mysteriously as he came. With his going, happiness has returned to listeners in.

If one should not understand what the above means, there is no real cause for worry or alarm because no one else does either, except that reception conditions, which have been the worst experienced in winter during the past five months, have begun to improve. Electrical engineers are pondering on the phenomena and hope to have some means to prevent or master it on its next appearance.

Blame Everybody

Poor reception has been noticed over the entire continent since the first of the year and everybody with any connection with the Radio industry has come in for their share of blame for being responsible for it. The condition is said to have cost commercial broadcasters many thousands of dollars worth of publicity expected during the winter months through the usual good reception conditions.

Although the nature of the phenomena or what causes it is unknown, it just has to be called something, hence the name "magnetic blanket." The mysterious stranger started rolling it up about the end of the month and now during March, which is usually one of the best times in the year for Radio transmission, the listeners in may expect to enjoy broadcast programs.

Programs Distributed by Telephone Company

Broadcasts Picked Up and Furnished to Loud Speakers

DENVER.—On the heels of rapid developments in the broadcasting art, telephone officials at Hiawatha, Kans., are now able to provide loud speaker Radio service to their widely scattered subscribers, according to word received by KOA at Denver.

"Programs are picked up at a central receiving set and are then distributed over the lines to loud speakers in private homes," reads the communication from an enthusiastic listener of Hiawatha, R. A. Nevin. "This system is ideal except that we take what the operator gives us. On the whole, however, he gives us the best."

Similar experiments have been made near Colony, Okla., according to Guy H. Oglesby.

"We live out in the country about fifteen miles from the railroad," he declares. "Last night I connected my Radio on our 'home-owned' telephone line and enabled all my neighbors, approximately twenty farmers, to hear KOA, which is a favorite with us."

Sport Broadcasts

Wrestling Meet Saturday, March 6

WOI, Ames, Ia., (270m-1110kc), Nebraska-Ames. 3 p. m. Central time.

Basketball

Monday, March 8

WSUI, Iowa City, Ia., (483.6m-620kc), Ohio-Iowa. 7:30 p. m. Central time.

Hockey

Tuesday, March 9

WBZ, Springfield, Mass., (333.1m-900kc), Boston Bruins-New York. 8 p. m. Eastern time.

PWX Scintillates Exotic Charm

GEM OF THE ANTILLES Radiates Visions of Tropic Beauty to Colder Climes in North and South American Continents. Stimulates Foreign Interests.



"Estacion PWX,"—these words have been heard on both hemispheres from the lips of Announcer R. F. Falcon (above) at Havana, Cuba.

Cozy and artistic are the reception room (upper) and the studio (lower, center) in the famous station "sparkling" from the Gem of the Antilles.

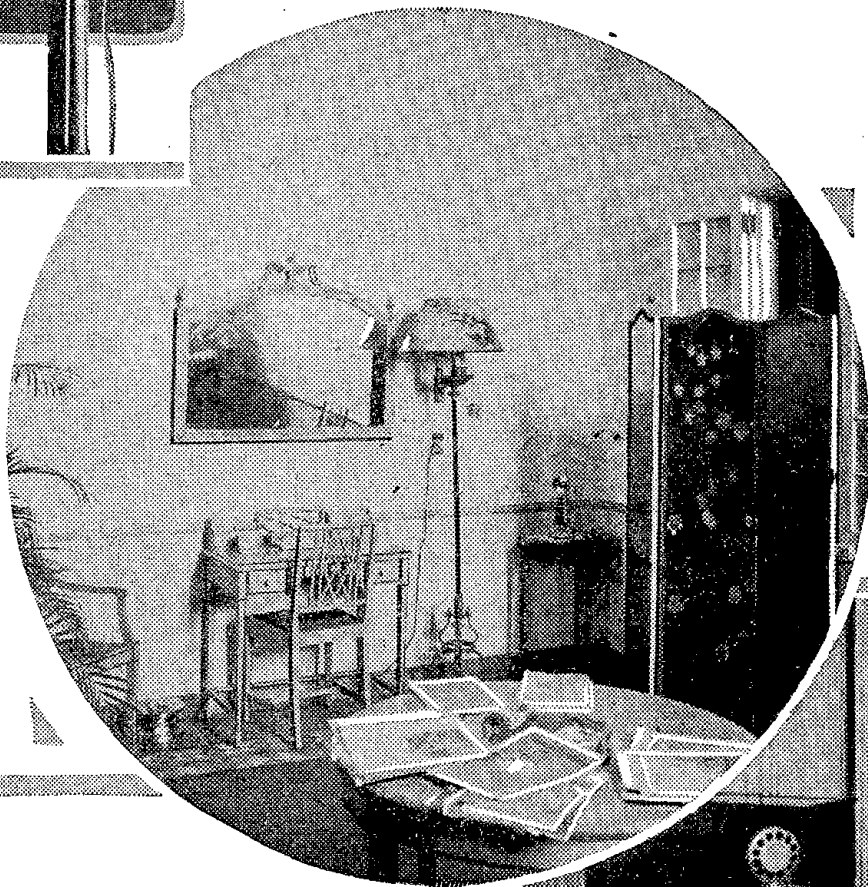

By JACK FORREST

IT'S a cold, clear night—just right for exploring the ether. The local stations are signing off, one by one, and the DX broadcasters are coming in as clear as a bell. As you slowly move the dials in an experimental way, around the 400-meter wave length, another stranger comes in. A band concert! The music reminds you of castanets, stamping heels, a shawl and a high comb in jet-black hair. Who is playing the Spanish music?

It stops. There is that expectant thrill as you wait for a new announcer's "This is station—," but it doesn't come. Instead, a clock suddenly begins a loud "tick-tock, tick-tock." Somebody told you once about a station that uses a Big Ben for its "trade mark." What station was that? The ticking ceases, and the band begins a lively tango. Sounds like Spain. But it must be some western station. It stops again. Then a voice— "Estacion PWX."

Havana! A foreign station! A voice across a wide stretch of the Atlantic, beyond the tip of Florida. The land of sugar cane and cigars! The tropics!

ONLY about half as far away from New York as the Pacific coast stations, but in another land. A land where Spanish is the native language, where tropical fruits grow abundantly, where cold winter and prohibition are unknown, and where Americans like to go. All these thoughts flash through your mind as the dials rest at 400 meters. The Spanish announcement changes to English to inform you that PWX is operated by the Cuban Telephone company. The words are slowly enunciated.

With a great deal of satisfaction you log the dial readings for future use. Your friends have boasted of getting PWX and you wondered why you had not tuned it in during your nocturnal hunting trips. Wait until they hear how strong it comes in on your loud speaker!

Whether it's because there's a lure to anything tropical, or be-

cause they get Cuba through the locals, and when they get PWX, they find in most cases it comes in with a bang!

A short time ago, the station was on the air only two nights a week. But now, there are about 50,000 receiving sets in Cuba alone—most of them homemade, as the Custom House figures of November, 1925, show that a total of 20,000 were imported—and the bulky mails from the United States and South American countries show that the audience of PWX has grown immensely abroad. So the number of programs have been increased, and plans are being made to use the station every night. Several American and Cuban organizations have arranged for entertainments to be given weekly, and it looks as if PWX were soon going to be busy all through the week.

* * *

SINCE this standard 500-watt station opened in 1922, it has served not only to entertain thousands of families in the island where it is located, but also to carry information about Cuba abroad to lands where only a vague idea of the island had been held before. As far as its voice is being heard, PWX is spreading information about Cuba, its desirable climate and its activities. That is one of the services this station is performing which is of mutual benefit to the island and to the foreign audiences.

Why did the Cuban Telephone company build this powerful station at Havana, to entertain unseen millions, scattered from the Equator to the Arctic Circle, and from mid-Pacific to Europe? Because it was seen that the Radio station would be a means of assisting in the (Turn to page 24)

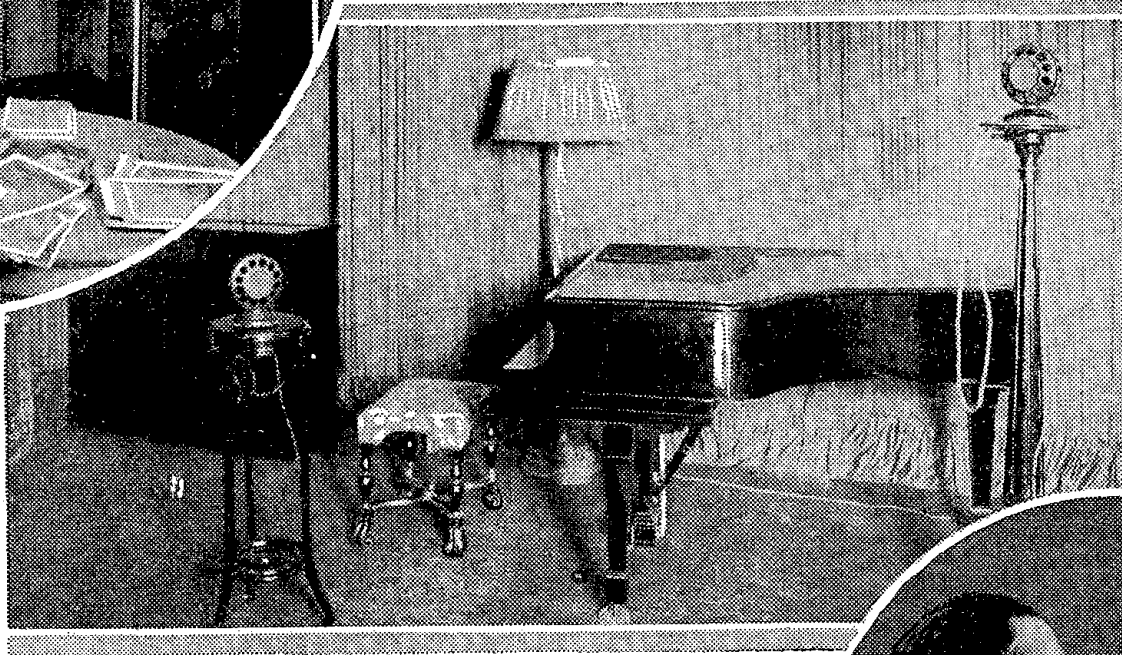

Cuban pickaninny thinks he hears "those angel voices sing-in" when Mr. Falcon (below) gives him the headphones. Luxurious verdure of tropics surround Station PWX (bottom).



cause of the entertaining Spanish programs, PWX enjoys an unusual popularity among the Radio fans, not only of the West Indies, but of North and South America, the British Isles and continental Europe. Four nights a week the Cuban Telephone company broadcasts a program, either a band concert from the Malecon bandstand by the General Staff band of the Cuban army, under the direction of Jose Molina Torres, or a recital by Cuban musicians and singers from the station studio. Every Monday, Tuesday, Wednesday and Saturday evening, from 8:30 to 11:30, Eastern standard time the DX fans of America and Europe tune in on 400 meters

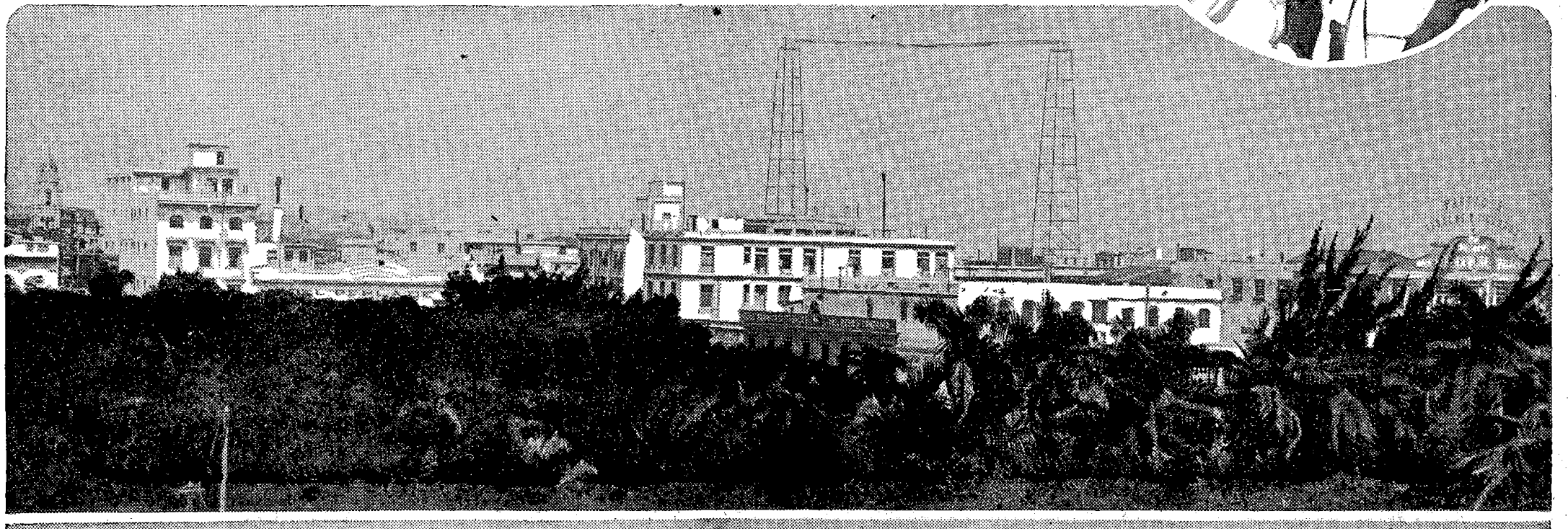

"Hill Billies" Capture WRC

Boys from Blue Ridge Mountains Take Washington With Guitars, Fiddles and Banjos; Open New Line of American Airs

MODERN improvements make slow progress in the hill country of the South. During the World war it was discovered that some of the more remote communities were living much as they did a century ago.

But Radio has taken hold of the primitive inhabitants with amazing alacrity. It's effect on the development of their education and communication with the outer world promises benefits untold. They are learning a new language. They are discovering America as it is today. To some who were born and have grown old within a few miles of the homes of their fathers it is a revelation. They scarcely associate it as being in reality a part of their own world. They do not all have receiving sets but there is one in the general store and they come from far and near to hear the concerts. The storekeeper in many instances has made it possible for individual families to own their own receiving sets.

A few weeks ago Radio Station WRC at Washington, D. C., broadcast a concert by an organization called "The Hill Billies." The response was astounding.

Letters and post cards arrived from the mountains of Tennessee, from the hills of Kentucky and the Carolinas and the Blue Ridge counties of Maryland and Virginia. Phone calls, local and long distance, demanded favorite numbers, and repeats, and what not.

* * *

A VOICE with a distinct Georgia drawl asked that they play "Long Eared Mule," and added the significant remark: "You-all caint fool me, ah know where them boys come from. They's Hill Billies for suah. They ain't nobody kin play that music 'thout they is bawn in the hills and brung up thar."

And he was right. The Hill Billies are really boys from the ranges that skirt the east coast states. They are six keen-eyed, ruddy-cheeked youths who have captured the

Below is the famous gang of Hill Billies who took nation's capital by storm. They are, from the left: A. E. Alderman of Carroll county, Virginia; Al, John and Joe Hopkins of "No'th Ca'lina," and "Fox-Hunt" Charlie Bowman of Tennessee. Every one of 'em from the "mountings" and born with the lingo.



rhythms of the hills, and who, with fiddles and other stringed instruments, present the classics of the country entertainments.

There isn't a bar of jazz in the Hill Billy music. There isn't a note of weird modern harmony or anti-harmony, nor is there a single skip-stop syncopation. And yet the Hill Billy music, with its "Sally-Ann" rhythm and its "Cinday" swing, starts feet to tapping unrestrainedly and unashamed. It is the folk music of America, to which the backwoods youth and the farmer boys "hoe it down" on rough-plank dance floors.

The Hopkins boys, the nucleus of the organization, form a vocal quartet, which, although of debatable value as to timbre of voices and blending of tone, is of indisputable predominance in volume and exactness of harmony. All four are natural baritones, but somebody has to sing tenor and somebody has to growl bass, and that's that. Joe Hopkins, now first tenor, until recently sang deep bass, but had to change because Elmer, who had been first tenor, contracted a cold and couldn't carry higher than baritone. When they "cut loose," as they say, one is reminded of their native habitat, and feels that "the strength of the hills is theirs also." WRC experimented with transmission for some time, and finally decided that the only way to keep them from "blasting" the microphone was to put them outdoors and hide the mike in a closet.

* * *

THOSE Hopkins boys, Al, Elmer, John and Joe, come from down Ash county way in No'th Ca'lina. For several years they have been "tank-towning" the South, playing for church and fraternal entertainments and dances, with Elvis Alderman (of Carroll county, V'ginia, suh) fiddling along with them. Carroll, if you must know, is the county in which the famous Allen gang, feudists extraordinary, lives and has its being, and takes occasional pot-shots at unsociable neighbors. (Continued on page 24)

Behold here a real Hill Billy, "Fox-Hunt" Charlie Bowman (above) who lives in a log cabin back in the hills ten miles from Mountain City, Tenn. Charlie came to town for a fiddlers' contest and the Hopkins boys from North Carolina were so pleased with his performance they induced him to join the Hill Billies gang.



a STEP ON the STAIRS

Synopsis of Preceding Chapters

MYSTERY, attaching to the manor house of the Turners, a sea-faring family of Pelican Bay, "since before the war" of the revolution, became an acute concern of the neighbors shortly before the opening of this story, when Jeremiah Turner, brother of Peleg Turner, owner of the place, was found murdered. John Carton, a favorite nephew disappeared and popular opinion identified him actively with the crime. Shortly thereafter Peleg Turner died. His death, apparently, was due to natural causes but his friends and relatives in Pelican Bay were free in the expression of their belief that more would come of it. Peleg Turner's body was carried out of the house as the bodies of the Turners always had been carried out, through a front door, opening from the old hunt-room, a door which legend and unbreakable custom had assigned to this one purpose.

The relatives of Peleg Turner gathered after his death to take part in a strange seance provided by his last will—to sit before a Radio receiver and listen while he should make an attempt to speak from the grave and solve the mysteries of the ancient house.

Through the storm that ushered in the evening of this weird meeting a man in a gray overcoat came across the dangerous waters of Pelican Bay, told Henry Mills, the caretaker, that he was one of the invited guests, and promptly thereafter disappeared.

In the house waiting for the word from Peleg Turner are Mary Williams, who maintains her belief in John Carton, Henry Graves, a distant cousin who would marry her, Aunt Helen Holmes, close relative of the Turners, Cousin William Turner, a diffident but sanctimonious youth, Frederick Ardwyn, Peleg's lawyer, Hari Singh, an East Indian servant, and other associates and relatives of the men who had died without solving the mystery of the hunt-room.

While the company was sitting before the radio receiver, locked in the darkened room, a step was heard on the stairs at the end of the outer hall and there came an untraceable echo of three short taps, three taps more widely spaced and then three more short taps—S-O-S. A draft gave sudden startling proof that someone had opened the front door through which none but the dead Turners had ever passed. But the fearsome effect of this discovery was lost in the noise of a fight in the broadcasting station to which the receiver was tuned—a pistol shot—and then a call for help from the station announcer. Briefly, then, the unanswered puzzles of the Turner manse were these:

Who was the man in the gray coat and what became of him?

Whose was the step on the stairs?

Who opened the door reserved for the dead?

Who killed Jeremiah Turner?

What was the truth about the death of Peleg Turner?

What happened to John Carton?

THE STORY CONTINUES.

CHAPTER THREE

Through the Front Door

IN THE ensuing pandemonium it was impossible to distinguish between the detached, ghostly shrieks of the Radio and the fleshly and pertinent plaints of the dozen panic stricken men and women who were the guests of the departed Peleg Turner. The long hunt-room, doubly vast now that darkness aided imagination, was filled with the cries of terror-crazed women and the

By **ROBERT J. CASEY**

Radio Dramatization by **FRED SMITH**

Illustrations by **HILMER C. OLSON**

futile cursing of men, with the crashing of overturned furniture and the vain beating of fists against the heavy oak panels of the doors.

It was not until the energies of the milling, struggling crowd had waned and the first ecstasy of fear had been tempered that the voice of Frederick Ardwyn, the lawyer, could be heard over the din.

"Ladies and gentlemen," he shouted. "Be quiet please. There is no danger. As Mr. Turner's lawyer—as his proxy at this meeting—I beg of you to believe that there is no cause for this commotion. Please be seated in the seats nearest where you happen to be. Mr. Graves, Mr. William Caryl and Mr. Milford Jones will please search the floor for the candles."

"But Mr. Ardwyn," came the plainting voice of Aunt Helen Holmes. "What has happened?"

"Nothing to be concerned about, Mrs. Holmes," the lawyer assured her. "We have let our nerves get the better of us because of the unusualness of this situation."

"But certainly there is nothing to cause alarm in a fight in a broadcasting station several miles away from here."

Aunt Helen's voice, still quivering in her reply, showed that she was far from being convinced.

"But the front door, Mr. Ardwyn," she reminded him. "The door that's never opened except when somebody's going to die . . . it was opened. I felt the draft. I know it was opened. And nobody's ever gone through it until he was a corpse."

"Hard luck for the fellow who broke in through it then," came an exasperated comment from the far corner of the room. "If I could find the bird that stepped on my hand I'd fix him so he wouldn't worry about Radio. But my glasses are busted and I can't see anyway in the dark. Get a match somebody . . ."

There was no response.

"Hasn't anybody got a match?"

Ardwyn once more counselled quiet.

"**W**E'LL get matches and a light in due time," he said. "And don't be alarmed about the front door. The latch is on the inside but no one could find the knobs to open it in the dark. I suspect anyway that it was nailed up as it generally is on such occasions after the last funeral."

"But somebody did open that door," protested Aunt Helen with increasing vehemence. "Do you mean to tell me I haven't the evidence of my own senses?"

"What of it?" inquired Ardwyn impatiently. "Suppose somebody did open the door, nothing has come of it. And I am telling you that it is humanly impossible to open that door in the dark. I have seen the locks . . ."

"Locks don't mean anything to a ghost," declared Aunt Helen.

The booming protest of the man who had bewailed the loss of his glasses broke into the weird ensemble of bodiless voices.

"It wasn't no ghost that stepped on my paw," he countered. "An' the ghost that

"Here?" inquired the unseen Graves. "Yes . . . that's it . . . you are brushing against me now."

"I'm not," came the startled denial. "I'm not brushing against anything. I'm in a puddle of something here. Something sticky spilled on the floor."

"Who was that at my feet?"

Ardwyn's query went unanswered.

"Who was that at my feet?"

"For the love of heaven light the lights," interrupted the woman who a short time before had voiced her fear of the dark. She seemed close to hysteria. "Lights . . ."

"Who was that at my feet?" roared Ardwyn.

Panic once more stalked the hunt-room.

A CHAIR overturned and there followed that undefinable whispering—a chorus of sharply drawn breath and muffled ejaculation that is the speech of fright. Then as chaos seemed about to be loosed once more, Henry Graves suddenly gave a cry of satisfaction.

"Here they are," he called. "The matches and a candle." A scratching noise followed and a flame turned from blue to yellow at a point in the blackness where most of the guests in their bewilderment had least expected it to be.

"Thank Heaven for the light," was the fervent prayer of the woman who had called for it and she fell forward across the table top sobbing as the rising blaze of the candle wick identified her as Hazel Stanton, a girl who had attracted the attention of Ardwyn at the beginning of the seance only because of her manifest poise and nerve. All about her were white, vacant faces, and startled, staring eyes.

"Who is that woman?" inquired Henry Graves. "She seems to have passed out."

"Her name is Stanton," replied Ardwyn. "Hazel Stanton. I don't know what branch of the family she comes from."

"I can't figure her either," admitted Graves. "But her face is familiar—or maybe it's that mop of red hair. I've seen her somewhere, and I'm suspicious." He broke off suddenly with a deprecating gesture. "I suppose I'm seeing things just like the rest," he added apologetically. "Who wouldn't be?"

"Who indeed?" conceded the attorney. "We'll get her a glass of water as soon as I can get the doors open. But first we'd better take an inventory."

"The place is certainly a wreck. Those upset chairs at the end of the room seem to show that everybody there made a dive for that barred window. Look at



"Thank Heaven for the light," was the fervent prayer of the woman who had called for it and she fell forward across the table top sobbing . . . All about her were white, vacant faces, and startled, staring eyes.

busted my glasses has somethin' comin' to him . . ."

"I wish someone would light the lights," whimpered a woman. "I am afraid . . ."

"Please be patient one moment more," advised Ardwyn. "The only box of matches seems to have been lost with the candles. They ought to be at this end of the table . . . Mr. Graves will you please search the floor near where I am."

Mary Williams will you. Not 125 pounds of her and you'd think to see her that nothing had happened. I don't believe she left her chair.

"She's the only one in the company who showed much sense," conceded the lawyer admiringly. "All the rest are here apparently ruffled but unharmed." He turned toward Helen Holmes who seemed to be debating with herself the advisability of fainting. "You see," he told her. "If anybody came in through

EIGHTEEN Leading Broadcasters Are Presenting This Mystery Story Weekly as a Play

the front door he didn't stay. There are no strangers here. The same ones who were here when we sat down to dinner are here now . . ."

A GASP from Henry Graves interrupted him. "The bearded pirate," he cried chokingly. "Milford Jones—that was his name, wasn't it—where is he?" "You're right," Ardwyn admitted in an awed tone. "He's gone. Where is Milford Jones? How did he get out?" "The front door," shrieked Aunt Helen. "That's how he got out. I told you somebody opened the front door." "Nonsense," declared Ardwyn unconvincedly. "As you can see, the front door is closed and there is a bar across it, even if one could ignore the locks. He couldn't have left the room that way." "And the hall doors were locked and the windows are barred," debated Aunt Helen in a high, shrill unnatural voice. "And Milford Jones is gone." "Yes," admitted Ardwyn reluctantly. "There seems to be no doubt about that point. There were twelve of us in this room. There are eleven. Milford Jones is gone."

CHAPTER FOUR

Tiger Bite

IN THE light of the lone candle, Henry Graves looked oddly at his right hand then hurriedly plunged it into his pocket. "We need more light here," observed Ardwyn. "Aren't there any more candle ends on the floor, Graves?" "There aren't," Graves assured him. "The candles were just about burned out when we extinguished them, if you remember." "Hari Singh," called Ardwyn. The Indian slipped in from the hallway as if he had been waiting a summons. "Yes, Mr. Ardwyn." "We need candles." "There aren't any, Sahib. All of the house but this room is lighted by electricity. Mr. Turner liked candles in here but he was not often in the house. We did not keep a large supply." "Fix up another room for us then," the lawyer suggested. "We shall leave here as soon as the light wanes. I do not suppose there is much use in continuing this seance."

"What interrupted it?" inquired Mary Williams. "Don't you think we ought to find out?" "Miss Williams' suggestion is pertinent," the lawyer ruled. "Where is Station FYX?" "It's scattered a bit," put in a youth whose voice, even unaccompanied by his blinking eyes, would have identified him as the unfortunate who had lost his glasses. "There's a studio in Portsmouth—ten miles up the bay road. The transmitting station is on Pelican point, probably half a mile from here on the same road." "Well," commented Ardwyn, "We ought to find out everything we want to know over at the station. Will you volunteer to take a run over there Mr. Tolliver?" The youth's reluctance was obvious, but it was apparent also that he felt the responsibility focused on him through the glances of the ten who silently awaited his answer. "Well," he said, "Well . . . I suppose I could go. But I don't like to think of chilblains and I'm sure to get chilblains if I go wandering around through the cedars at this hour of the night. I think I've got 'em already and besides somebody busted by glasses." He paused and looked around hopelessly as if expecting moral aid from someone of the ten who stared at him. "Oh all right," he suddenly decided. "I'll go."

A MINUTE later the door had slammed behind him and through the noises of the storm came the sounds of a starting motor car. The guests of Peleg Turner settled back limply in their chairs to await his return. Whether or not their future conduct might hinge on the report from the broadcasting station; whether or not the sounds of rioting at FYX had anything at all to do with the mysterious old house and the more mysterious old dead man who had owned it, nobody thought of suggesting any action until Tolliver should bring back the news. "He won't come back," croaked Aunt

Helen dismally. "I feel in my bones that he won't be back."

The candle flame wavered in an unfelt wind. The storm howled in the chimney and stirred the dead ashes in the hearth. Then presently there came the squealing of brakes under the porte-cochere and Hari Singh moved quickly toward the door. Tolliver entered and shook the snow from his great-coat with exasperating deliberation.

"Well?" inquired Ardwyn, "What did you find?"

"The riot, mayhem and murder didn't occur at the FYX studio," reported Tolliver genially. He paused with fine appreciation of dramatics as his audience sighed.

"That is something at least," admitted Ardwyn. "We may feel some relief at knowing that these wild events did not take place so close to home."

"No," said Tolliver. "They didn't happen so close to home. They happened closer. They happened right here in our back yard. The riot was staged at the FYX station on Pelican point." Once more he paused, this time with obvious pleasure at the effect he had created.

"Go on Tolliver," grated Ardwyn. "Don't be an ass! What happened?"

"I'm getting to that," the messenger explained pettishly. "It wasn't my riot. I can't change it around to suit your specifications."

"I went away from here along the Bay road to the Pelican Point station and I almost ran over some bird who stepped out of the cedars in front of the car."

"I didn't stop to ask him any questions—didn't think much about him to tell you the truth. But come to think about it maybe I'd have done better if I had given him the look, see. I haven't found out yet who smashed my glasses."

"Well I gets over to the station and there everything is in a fine mess. There's a motorcycle policeman at the door and a couple of operators and announcers running around the place looking foolish—just like you'd expect them to look."

"Whatcha want?" asks the cop. I tells him I heard somebody has strangled a soprano and that I've come over all these weary miles just to find out if this good news can be true. He pumps me a little. Finds out about our little party over here an' then he lets me into the station."

"And here . . . I almost forgot . . . Here's something they found on the floor of the station. I wiped it from the cop." He drew an envelope from his pocket.



"I don't make much of an inspection. I'm thinkin' all the while of havin' the cop get over here quick an' find out who smashed my glasses an' take this traveling madhouse someplace where it can be put under lock an' key."

FROM one of the operators I find out that tonight, just as they are gettin' ready for the midnight revue, a man comes bustin' in through the door. He shuts it an' then makes a dive for the door that leads into the battery shed. As they look back at it, they think he might have been thinkin' of headin' out through a back door there. Just then another man comes bustin' through the front door and the chief engineer comes out of the battery shed. The engineer gives one look at the fellow coming toward him an' lets out a yell—"Don't let him get me," or something like that. And he makes a reach for his hip. The second man gets out a rod and begins to shoot and the engineer is creased along the top of the skull.

"He's on his way to a hospital in Portsmouth unconscious but alive. The station microphone is turned on at the time so all of these festivities go onto the air. The operators think maybe the first man who came through the station was hit. They found blood on the floor."

But anyway he gets away. The bird who does the shooting, trips over a roll of cable and sprawls just long enough to let the other one get away.

"And that's about all there is except that there's a trail of blood in the snow near the studio an' quite a bit more of the same in the snow just outside our own cottage door, here. I noticed it as I came in. I also notice from where I stand that there is blood on the floor over there by the end of the table."

Ardwyn turned his attention suddenly from Tolliver.

"What is it Miss Williams?" he asked. The girl had risen and was staring white faced across the room.

"It's nothing," she said. "Mr. Tolliver startled me. I don't think those stains on the floor are blood. I'm sure they're not. Somebody is making a hideous joke of a very serious matter . . ."

"Blood or catsup, it's all the same to me," put in Tolliver magnanimously. "I think the whole plot is the silliest thing I ever got mixed up in. The idea of a wounded man coming here to this house for shelter—if he came—is the evening's brightest jape."

AND here . . . I almost forgot . . . Here's something they found on the floor of the station. I swiped it from the cop." He drew an envelope from his pocket. "It appears to be a letter . . ."

"God help us," breathed a voice that nobody thought to trace. And then Miss Williams, holding to the end of the table as she lowered herself weakly into her chair gave a spasmodic jerk that sent the candlestick and its lone light rocketing to the floor. Darkness came down and the old panic revived.

"The lights are out," cried Miss Stanton roused from a semi-stupor. "What has happened?"

"Nothing at all," Ardwyn assured her quickly. "Somebody jolted the candlestick off the table. We'll find it presently or we'll all go out into the library where we . . ." His speech was suddenly interrupted by a cry of pain.

"A woman!" he exclaimed and the others in the room, vainly attempting to see what was happening in the blackness, caught a glimpse of a silhouetted figure momentarily outlined against the dim twilight that filtered through the doorway from a room beyond the hall. "A woman" he repeated. "I had her . . . She's gone . . . Hari Singh! Hari Singh! Find a light . . ."

"Coming, Sahib," called Hari Singh from somewhere close by. And a match

(Continued on page 28)

\$500 in Gold FOR THE SOLUTION OF a Step On the Stairs

WITH the beginning of this exclusive and pioneering effort in coupling a master serial novellette with its production as a Radio play at a selected few of the country's best broadcasting stations, Radio Digest wishes to announce that \$500.00 in Gold prizes will be awarded to the persons who can best solve the mystery.

The story, "A Step On the Stairs," is written by Robert J. Casey, an author whose works in the literary world need no introduction. Furthermore he is well versed in the needs of such fiction for Radio presentation. His work, in turn, is being Radio dramatized by Fred Smith, Managing Director of the United States Radio Society, who can be counted among the first few men to write and present Radio plays.

Read the story and hear it played weekly from the selected stations. Don't miss this thriller, whether or not you intend to submit a solution!

The chosen stations, which will broadcast "A Step On the Stairs" in Radio play form, are given on page thirteen. The days and the hours are listed.

THE PRIZES

The prizes are seventeen in number. First prize is \$250; second prize is \$100; third to seventeenth prizes inclusive, are \$10 each. In the event of a tie for any prize offered, a prize identical in all respects with that tied for will be awarded to each tying contestant.

HOW TO WIN A PRIZE

Nine installments of Mr. Casey's story will be published consecutively each week, the first appearing in the February 27 issue. His tenth and final installment will not appear until the prize winning solutions have been selected by the judges. The solution nearest correct, that is, nearest to unravelling the mystery accurately, will win. The method of preparing the solution—its neatness, legibility, etc.—shall be considered in the selection of the winning solution.

RULES OF CONTEST

1. The contest opens with the February 27 issue. All solutions must be received by Radio Digest not later than midnight of Saturday, May 1. The ninth installment of the story will appear in the April 24 issue. The author's intended and final chapter will appear in the May 15 issue of Radio Digest, together with the announcement of the winners' names.
2. The contest is open to everyone except employes of Radio Digest and their families.
3. Contestants pay no fee and need not be subscribers to Radio Digest. Solutions, however, must be written upon but one side of paper, and names and addresses should be written or printed plainly.
4. The decision of the judges, to be named later in the contest, will be final.

POWEL CROSLLEY JR.

Radio Manufacturer

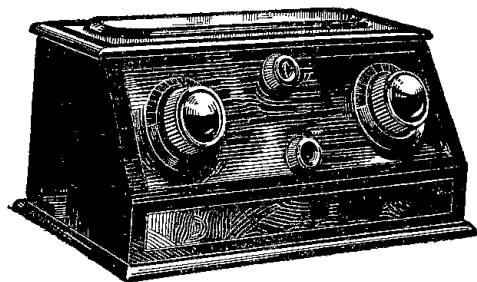
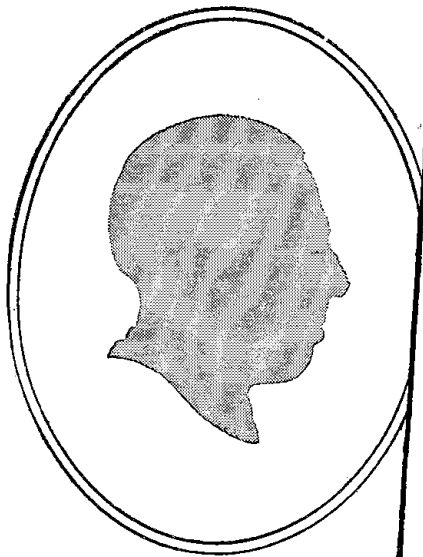

The Crosley 4-tube—4-29
in which the *Crescendon* is equal to one or more additional tubes of tuned radio frequency amplification. **\$29**



The Crescendon
—an amazing new volume control exclusive to Crosley sets. Hear it!

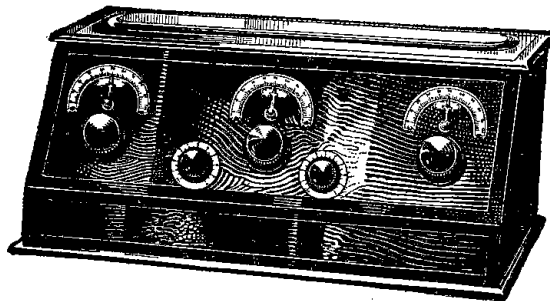

The Crosley 5-tube—5-38
All the volume, selectivity and purity of tone available in the best 5-tube set—plus the *Crescendon*. . . **\$38**

Widespread Popularity Marks Another Great Success

Spectacular as* has been each stride in radio achieved by Powel Crosley, Jr., never before has a Crosley success received such prompt and widespread recognition. Here in the radio plant which has made more radios than any other factory in all the world, every man and machine is going at top speed, every hour is a crowded hour, every night a working day, as the result of orders for the four new Crosley sets.

Even the sweeping success of the Crosley Musicone did not match this merciless demand upon an organization tuned to mass production. With the first demonstrations by Crosley dealers, public approval was expressed in orders that have increased in volume day by day and show no inclination to relax.

This popularity is distributed quite evenly between the four new 4- and 5-tube sets. Thousands who had formerly believed that worth while reception was exclusive to high priced sets, have found in Crosley 4-29 and

5-38 all that they could ask of radio. The accurate selectivity and pure tone of these instruments would be enough. That magnificent volume achieved through the *Crescendon* is the final touch.

And in Crosley "RFL" types there is a revelation for all. For here true cascade amplification makes its first appearance. Here what was considered *impossible* in expert opinion has been achieved by amplification closely approaching theoretical maximum efficiency per tube!

Your nearby Crosley dealer is now demonstrating these truly remarkable sets. By all means hear them. What a joy to find . . . and in a low priced set . . . rare beauty, rich tone, volume subject only to your desire, and no howling at any pitch by any mishandling under any conditions.

Each instrument delights the ear, fires the enthusiasm of the lay technician, converts the staunchest skeptic to love of radio.

See the new Crosley receiving sets at your dealer's or write Dept. 49 for descriptive catalog

Crosley manufactures radio receiving sets which are licensed under Armstrong U. S. Patent No. 1,113,149, or under patent applications of Radio Frequency Laboratories, Inc.

THE CROSLLEY RADIO CORPORATION, CINCINNATI, OHIO

Powel Crosley, Jr., President

Owning and Operating WLW, first remote control super-power broadcasting station in America

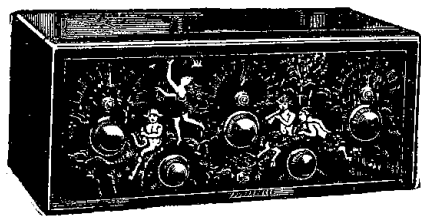

The Crosley 5-tube—RFL-60
A set of marvelous performance and beautified by the artistic decorative panel. . . . **\$60**

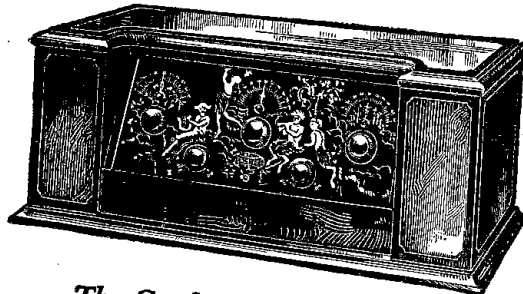

The Crosley 5-tube—RFL-75
Simplicity and speed in tuning, fidelity of tone, and decorative beauty, enhanced by the art panel. . . . **\$75**

Add 10% to all prices west of the Rockies

CROSLLEY RADIO

BETTER—COSTS LESS

FOR THE ENTERTAINMENT CORNER

Day in, day out, the laboratories of The Crosley Radio Corporation are busy. Night after night, the lights are burning as engineers and scientists of the Crosley research staff seek out the solutions of problems Powel Crosley, Jr., has set. New and better ways to make this part or that, revolutionary principles related to receiving and broadcasting, and entirely new fields for the employment of radio energy.

Always the eye of Mr. Crosley is on the work. Able as are his helpers in their respective fields, he alone directs their toil toward this goal or that. In his imagination originate the main objectives.

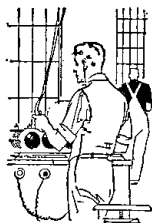

Out of this system of ceaseless search have come all those great improvements that Powel Crosley, Jr., has made in radio. Free of all restrictions of precedent and recognizing no bounds to possibility, Crosley research and engineering have already in several instances achieved the so-called "impossible." In fact, practically every Crosley improvement has been a radically new departure rather than a mere refinement of existing methods.

The Crosley Musicone is an outstanding example. In its first year it outsold all other makes, and today is replacing other types of loud speakers as fast as the world's largest radio plant can manufacture. True cascade amplification and the "Crescendon" are also examples of Crosley research results. And in this same department have originated the innumerable machines and devices now employed in the Crosley shops to simplify operations, speed production, and reduce costs.

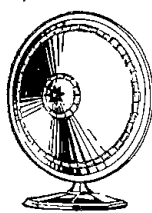

Out of Powel Crosley's devotion to research great things indeed have come . . . but greater things than these may be expected.

Better radio receiving in the common sense is not the only object of his search. It is Powel Crosley's conviction that radio energy can perform new feats for the public's entertainment and benefit, perhaps radio motion pictures in the home. . . . a thousand and one dreams are in this restless brain, and Crosley dreams so regularly come true. And even the potentialities of radio activity cannot hold his whole concern. Inasmuch as the great public service of Powel Crosley, Jr., has been in putting worth while radio reception within the common reach, he can clearly see that many other products which impose price burdens on the average man, likewise cry for cost reduction by mass production.



You may look to him to attack such problems as these. You may gauge your expectations of his success by the unusual facilities at his command and the repeated successes he has already won.

New and better ways to make this part or that, revolutionary principles related to receiving and broadcasting, and entirely new fields for the employment of radio

your expectations of his success by the unusual facilities at his command and the repeated successes he has already won.

that, revolutionary principles related to receiving and broadcasting, and entirely new fields for the employment of radio

receiving
of the
is
tion
form n
ertainn
radio n
ans a
and
y come
ven the
s of ra-
cannot
ole com-
such as
public
Powel
Jr., has
putting
le radio
within t
clearly
ducts w
on the
y for c
productio
look to h
ems as t
stations
ilities at
successes
out, the l
o Corpo
night, the
and scienti
seek out
Powel Crosley
ter ways to
tionary pri
d broadcast
of the emp
eye of Mr.
in the work
his helpers
ective fields,
irects their
d this goal
his imaginat
ate the main
is system o
arch have ce
ents that Pe
radio. Free
and recogn
ty, Crosley
have ahead
chieved the s
n fact, pra
improvement h
departure rat
of existing
sley Musicone
example. In
all other mak
ng other types
ast as the v
ant can manu
amplificati
on" are also
research resul
me department
oratories of The
tion are busy
ights are burning
of the Crosley
the solutions of
y, Jr., has set,
make this part or
ciples related to
ng, and entirely
yment of radio,

THREE RECIPES FOR WINTER CONSERVES

ORANGE MARMALADE CAN BE MADE ANY TIME

Miss Crocker Describes Method of Making Delicious Preserves if Fall Supply Is Used

Have you heard, and do you regularly listen for Betty Crocker's Radio talks? Miss Crocker is nationally known as a home food specialist who is broadcasting from a dozen of the country's largest stations. By special arrangement Radio Digest has secured a series of exclusive articles by Miss Crocker dealing with her current Radio talks. These broadcasts are made through WEAF, WJAZ, WJAB, WJBR, WEAR, WWJ, WDAF, WJAB, WHT, WFI, KSD, KFI, and WCOO, the Gold Medal station at Minneapolis-St. Paul. All of Miss Crocker's recipes and discussions are based upon actual investigations and work of herself and her assistants in model kitchens.—Editor's Note.

By Betty Crocker

SHORT time ago I received a letter from a young housekeeper asking if there is anything she can make at this time of the year to fill the jam pot. Last fall, she had canned what she thought was a generous supply of jams, jellies and conserves, but now they are almost gone and her husband wants more spread for hot biscuits and Johnny cake. No doubt there are others of you in the same predicament or perhaps some of you, for one reason or another, were unable to do any canning or preserving last fall.

We usually think of August and September as the season for preserving, but it is very easy to make good jams and conserves in the winter, and furthermore, it is decidedly more comfortable to stand over a hot stove now than in August or September.

Winter Time Conserves

Delicious conserves may be made of dried fruits, peaches, apricots, or prunes combined with commercial canned pineapple, or berries, or with raisins, oranges, or grapefruit. If you are fortunate enough to have a supply of canned rhubarb left from last summer you can make some very delicious conserves with the winter fruits. Rhubarb, raisins, and

GREETINGS AND PLAYS FOR WOAW ARTISTS



The position of hostess and accompanist at a broadcasting studio is a new vocation opened to women with the advent of Radio. Marie Kieny, above, does it well at WOAW, Woodmen of the World, Omaha.

oranges combine to make a delicious marmalade, or you may use rhubarb and pineapple with equally good results. Another good marmalade is made by combining apples and quince and, of course, there is nothing more delicious than orange marmalade. Nuts, the most expensive part of a conserve, are usually reserved for a special company treat, but if you have a supply of nuts from your woods, you can have a company treat every day. Nuts should never be boiled in the mixture, as boiling develops a strong flavor. They should be blanched, and

chopped, and added just a minute or two before the mixture is removed from the fire. All glasses and jars should be sterilized, before the mixture is poured into them, and after it is cold, the fruit should be covered with hot paraffin. If the paraffin is very hot, it will destroy any mold spores which may have settled on top of the fruit and thus prevent the formation of mold under the paraffin.

Orange Marmalade Recipe

Here is my kitchen-tested recipe for orange marmalade: Nine oranges, six lemons, four quarts of water, sugar.

Method: Peel the fruit, removing the peel in quarters. With a sharp knife or scissors cut the peel in thin strips. Slice fruit crosswise as thin as possible. Remove the seeds. Place fruit and peel in a preserve kettle. Pour over the water and let stand 36 hours. Boil for two hours. Measure the cooked fruit and add an equal amount of hot sugar. Cook until the mixture jells. Pour into sterilized glasses. When cold cover with hot paraffin. This amount will make ten glasses.

The reason for soaking the fruit in water for so long a time is to dissolve out the pectin so that the mixture will jell.

Apricot Conserve

The conserves made of dried fruit are perfectly delicious. I hope you will not scorn them until you have tried them. Here is the recipe for apricot conserve: One pound dried apricots, two cups shredded pineapple, juice of one-half lemon, sugar.

Method: Wash the apricots. Cover with water and let soak at least two hours. Cook very slowly in the water in which they were soaked. When almost done, add the pineapple. Cook until soft and measure. Add an equal amount of hot sugar. Cook to the jell test. Add the lemon juice just before it is done. Pour into sterilized glasses. When cold, pour over hot paraffin. This amount will make eight glasses.

Prune Conserve

The recipe for prune conserve is quite simple and very easily made. Two pounds prunes, four oranges, peel of one orange, juice of one-half lemon.

Method: Wash the prunes thoroughly. Cover with water and let soak at least an hour. Cook in the same water until

(Continued on page 12)

SHORT WAVES

By Marcella

After telling you last week how nice Harry Geise, ex-WIBO, was getting along on the Pacific coast, I regret to report that while last issue was on the press he was the figure of a rather unusual incident. It seems that he returned, meantime, to take a position at WWAE, Plainfield, Illinois. He also forgot to pay back alimony, so the story goes, to his ex-wife to the amount of \$375, and she had been hunting him relentlessly. While listening in one night recently she heard a familiar tune:

*I'm as happy as a cat—
Mamma don't know were I'm at,
What could be as fair as that?
How d'you do?*

It was her former hubby, singing away to the tune of \$375 to the good! Then she heard the call letters, WWAE. The next scene in the picture shows a deputy sheriff rapping on the studio door of WWAE. The next morning, after a sleepless night on a Cook county jail bed, the judge nominated Harry to membership in the "alimony club." Here Mr. Geise was accepted to membership and will stay, according to the jail chaperons, until business negotiations with Mrs. Geise are concluded—meaning Harry is to pay her \$375 in legal tender. He is reported to have composed a new song for the male quartet of the alimony club. It goes something like this:

*How d'you do, Mrs. Geise, how d'you do?
If you're gonna keep me here, what'll I do?
Till I pay, my dear, I fear
I'll be here for many a year,
Through the days of Christmas cheer,
How d'you do?*

Tune in some night to it from WWAE, for rumor has it that the station is going to install a direct wire pickup to Harry's cell-studio. There, reports say, the "Prisoner's Song" will be one of the favorite numbers, together with, "Sittin' on the Inside, Lookin' on the Outside," and "Linger Awhile."

Seriously (?) speaking, however, those

(Continued on page 12)

WOMEN'S PROGRAMS INDEX

Saturday, March 6

Eastern	Central	Mountain	Pacific
9:30 a. m.	8:30 a. m.	7:30 a. m.	6:30 a. m.
WWJ (352.7m-850kc)	Tonight's dinner.		
11	10	9	8
WEAR (389.4m-770kc)	Home service talk.		
12 n.	11	10	9
WGN (302.8m-990kc)	Household hints.		
12:35	11:35	10:35	9:35
WQJ (447.5m-670kc)	"Stories About Famous Pictures," Marjory Curry.		
1 p. m.	12 n.	11	10
KGW (491.5m-610kc)	Household helps, shopping guide.		
12:30	11:30	10:30	9:30
KMA (252m-1190kc)	Domestic science topics.		
12:35	11:35	10:35	9:35
WGN (302.8m-990kc)	Discussion of fashions.		
4	3 p. m.	2 p. m.	1 p. m.
KJR (384.4m-780kc)	Tonight's dinner.		

Monday, March 8

Eastern	Central	Mountain	Pacific
9:30 a. m.	8:30 a. m.	7:30 a. m.	6:30 a. m.
WWJ (352.7m-850kc)	Tonight's dinner.		
10	9	8	7
WJZ (454.3m-660kc)	Women's hour.		
10:45	9:45	8:45	7:45
WEAF (491.5m-610kc)	WFI (491.5m-610kc) Home service talk, Betty Crocker.		
11:45	10:45	9:45	8:45
WTAG (268m-1120kc)	Talk, Marjorie Woodman, nurse.		
10:50	9:50	8:50	7:50
WMC (499.7m-600kc)	Home economics discussion, Miss Kitty.		
11	10	9	8
WEAR (389.4m-770kc)	Home service talk.		
11:15	10:15	9:15	8:15
WVIC (475.9m-630kc)	"Extension Work in Hartford County," Olea M. Sands.		
11:30	10:30	9:30	8:30
KFAB (370.7m-880kc)	"How and Why of Four-H Canning Clubs," Jessie Greene.		
11:45	10:45	9:45	8:45
WCOO (416.4m-720kc)	"A Gold Medal St. Patrick's Party," Betty Crocker.		
12:30	11:30	10:30	9:30
WDAF (365.6m-820kc)	WHT (399.8m-750kc) Home service talk, Betty Crocker.		
12	11	10	9
WGN (302.8m-990kc)	Household hints.		
12:35	11:35	10:35	9:35
WQJ (447.5m-670kc)	Home Economics program. "Uses for Some of the Palm Trees," Maud R. Jacobs.		
12:15 p. m.	11:15	10:15	9:15
KYW (535.4m-560kc)	Meat talk.		
12:30	11:30	10:30	9:30
WEBH (370.2m-810kc)	Fashion and household hints.		
12:35	11:35	10:35	9:35
KYW (535.4m-560kc)	Table talk.		
2:30	1:30 p. m.	12:30 p. m.	11:30
KPNF (263m-1140kc)	Mothers' hour.		
3	2	1	12 n.
WCOO (416.4m-720kc)	Women's hour.		
3:15	2:15	1:15	12:15 p. m.
WSOE (246m-1220kc)	Cooking chats.		
4	3	2	1 p. m.
WIP (508.2m-590kc)	Market hints for housewives.		
4:30	3:30	2:30	1:30
WOC (483.6m-620kc)	Home management schedule, Aunt Jane.		
4:45	3:45	2:45	1:45
WQJ (447.5m-670kc)	"The Care of Children's Eyes," Dr. I. Beem.		
5	4	3	2
KJR (384.4m-780kc)	Home helps.		
7:15	6:15	5:15	4:15
WKAR (285.5m-1000kc)	"Newer Ideas in Child Training," Ruth Cowan.		

Tuesday, March 9

Eastern	Central	Mountain	Pacific
9:30 a. m.	8:30 a. m.	7:30 a. m.	6:30 a. m.
WWJ (352.7m-850kc)	Tonight's dinner.		
10	9	8	7
KDKA (309.1m-970kc)	Domestic Science. Arts for the Housewife.		
10:45	9:45	8:45	7:45
WTAG (268m-1120kc)	Talks to Mothers, Rosebelle Jacobus.		
11	10	9	8
WEAR (389.4m-770kc)	Home service talk.		
11:15	10:15	9:15	8:15
WJZ (454.3m-660kc)	Women's hour.		
11:30	10:30	9:30	8:30
WQJ (447.5m-670kc)	"What the Baby Teeth Are For," Evelyn Schmidt.		
12:30	11:30	10:30	9:30
WEBH (370.2m-810kc)	Fashion and household hints.		
12:35	11:35	10:35	9:35
KYW (535.4m-560kc)	Table talk.		
1	12 n.	11	10
KPO (428.3m-700kc)	Domestic science talk.		
1:15	12:15	11:15	10:15
WQJ (447.5m-670kc)	Talks. "The Proper Places to Wear a Felt Hat," Lillian Russell.		
1:45	12:45	11:45	10:45
WQJ (447.5m-670kc)	"What the Baby Teeth Are For," Evelyn Schmidt.		
2:30	1:30	12:30	11:30
WEBH (370.2m-810kc)	Fashion and household hints.		
2:35	1:35	12:35	11:35
KYW (535.4m-560kc)	Table talk.		
3	2	1	12 n.
WIP (508.2m-590kc)	Menu talk.		
3:15	2:15	1:15	12:15 p. m.
WOC (483.6m-620kc)	Home management schedule.		
4:30	3:30	2:30	1:30
WLIT (394.5m-760kc)	Household helps and hints.		
5	4	3	2
KJR (384.4m-780kc)	Home helps.		
5:30	4:30	3:30	2:30
KOA (322.4m-930kc)	Housewives' matinee.		
6	5	4	3
KOA (322.4m-930kc)	Culinary hints, Clara Hoover.		
6:15	5:15	4:15	3:15
KOA (322.4m-930kc)	Fashion review, Sally Dee.		
7	6	5	4
KFOA (454.3m-660kc)	Today's recipe.		
8	7	6	5
WPG (299.8m-1000kc)	Fashion Flashes.		
8:30	7:30	6:30	5:30
KGQ (361.2m-830kc)	As a Woman Thinketh.		
10	9	8	7
WDBO (240m-1250kc)	"A Straight Talk to the Home Buyer of Citrus Fruits."		

Wednesday, March 10

Eastern	Central	Mountain	Pacific
9:30 a. m.	8:30 a. m.	7:30 a. m.	6:30 a. m.
WWJ (352.7m-850kc)	Tonight's dinner.		
10	9	8	7
WIP (508.2m-590kc)	Menu.		
10:45	9:45	8:45	7:45
WEAF (491.5m-610kc)	Home service talk, Betty Crocker.		
11	10	9	8
WFI (491.5m-610kc)	Gold Medal Service talk, Betty Crocker.		
11:15	10:15	9:15	8:15
WTAG (268m-1120kc)	Talk to Housewives, Mrs. Lydia Flanders.		
11:45	10:45	9:45	8:45
WHT (399.8m-750kc)	Women's club, Jean Sargent.		
12:30	11:30	10:30	9:30
WNYC (526m-570kc)	Women's program.		

Thursday, March 11

Eastern	Central	Mountain	Pacific
9:30 a. m.	8:30 a. m.	7:30 a. m.	6:30 a. m.
WWJ (352.7m-850kc)	Tonight's dinner.		
10	9	8	7
KPRU (499.7m-600kc)	"Broomstick," Jessie Bur-		
10:45	9:45	8:45	7:45
WIP (508.2m-590kc)	Menu talk.		
11:15	10:15	9:15	8:15
WJZ (454.3m-660kc)	Women's hour.		
11:30	10:30	9:30	8:30
WRC (468.5m-640kc)	Women's hour.		
10:45	9:45	8:45	7:45
WTAG (268m-1120kc)	Talk, Marjorie Woodman, nurse.		
10:50	9:50	8:50	7:50
WMC (499.7m-600kc)	Home economics discussion, Miss Kitty.		
11	10	9	8
WEAF (491.5m-610kc)	Talks, cookery lecture.		
11:15	10:15	9:15	8:15
WHT (399.8m-750kc)	Women's club, Jean Sargent.		
12 n.	11	10	9
WGN (302.8m-990kc)	Household hints.		
12:15	11:15	10:15	9:15
WQJ (447.5m-670kc)	"A Few Treasures from an Old French Cook Book," Erna Bertram.		
12:30	11:30	10:30	9:30
WQJ (447.5m-670kc)	"Short Cuts in Cooking," Beatrice Cary.		
12:35	11:35	10:35	9:35
KYW (535.4m-560kc)	Table talk.		
1	12 n.	11	10
KPO (428.3m-700kc)	Domestic science.		
1:15	12:15	11:15	10:15
WOC (483.6m-620kc)	Home management schedule, Aunt Jane.		
1:45	12:45	11:45	10:45
WQJ (447.5m-670kc)	"Foot Troubles—Their Prevention," Dr. Frank Furch. "Golf—How to Improve Your Game," Ralph Thron.		

Friday, March 12

Eastern	Central	Mountain	Pacific
9:30 a. m.	8:30 a. m.	7:30 a. m.	6:30 a. m.
WWJ (352.7m-850kc)	Tonight's dinner.		
10	9	8	7
KDKA (309.1m-970kc)	Domestic science and Arts for the Housewife.		
10:45	9:45	8:45	7:45
WJZ (454.3m-660kc)	Women's hour.		
11:15	10:15	9:15	8:15
WVIC (475.9m-630kc)	"Health Education in Our Public Schools," Dr. Allen Ireland.		
11:30	10:30	9:30	8:30
KFAB (370.7m-880kc)	"Should the Homemaker Receive a Salary?" Ruby Simpson.		
11:45	10:45	9:45	8:45
WCOO (416.4m-720kc)	"Sea Foods for Inland Folks," Betty Crocker.		
12:30	11:30	10:30	9:30
WDAF (365.6m-820kc)	WEAR (389.4m-770kc) Betty Crocker's Home service talk.		
12:35	11:35	10:35	9:35
KYW (535.4m-560kc)	Table talk.		
1:45	12:45	11:45	10:45
WQJ (447.5m-670kc)	Sunshine Sunday dinner menu.		
3	2 p. m.	1 p. m.	12 n.
WCOO (416.4m-720kc)	Women's hour.		
3:15	2:15	1:15	12:15 p. m.
WHO (526m-570kc)	Recipes, household hints.		
4	3	2	1
WOC (483.6m-620kc)	Home Management, Aunt Jane.		
4:30	3:30	2:30	1:30
WQJ (447.5m-670kc)	"Refrigeration—from Cave to Kitchen," Catherine Spenser.		
4:45	3:45	2:45	1:45
WFAA (475.9m-630kc)	Homemakers program.		
5	4	3	2
KJR (384.4m-780kc)	Home helps.		
5:15	4:15	3:15	2:15
WMAQ (477.5m-670kc)	Housewives' matinee.		
5:30	4:30	3:30	2:30
KOA (322.4m-930kc)	Housewives' matinee.		
6	5	4	3
KOA (322.4m-930kc)	Culinary hints.		
6:15	5:15	4:15	3:15
KOA (322.4m-930kc)	Fashion review.		

JOSEF HOFFMAN OVER WEAFF CHAIN

Sunday, March 7

Headliners Today

Eastern 5 p. m.	Central 4 p. m.	Mountain 3 p. m.	Pacific 2 p. m.
WTIC (475.9m-630kc) Organ recital. 5:30	4:30	3:30	2:30
WEEL (348.6m-560kc) Grigorief chorus. 6	5	4	3
KGO (361.2m-830kc) Grieg music. WBZ (333.1m-800kc) Golden hour of music. 8	7	6	5
WJZ (454.3m-600kc) Bakelite hour. WHO (526m-570kc) Bankers Life trio. 9	8:15	7:15	6
WTIC (475.9m-630kc) Colt's band concert. 9:15	8:15	7:15	6:15
WEAF (491.5m-610kc), WEEL, WCAP, WOO, WJAR, WGR, WCAE, WSAI, WWJ, WOC, WCCO, WGN, WEAR, KSD, WTAG, Atwater Kent program. 9	8	7	6
KTBS (374.8m-800kc) Classic hour. 10:30	9:30	8:30	7:30
KPRC (296.9m-1010kc) Paramount Five. 12:30 a. m.	11:30	10:30	9:30
KTBS (374.8m-800kc) Special organ concert. 9			

Sunday, silent night for: CFAC, CHIC, CKNC, CNRA, CNRC, CNRE, CNRM, CNRO, CNRR, CNRT, CNRV, CNRW, KFAB, KFAU, KFKX, KFKU, KFOA, KFVE, KFWA, KFXF, KLX, KMA, KMTR, KOAC, KOB, KOWW, KSAC, KSD, KWSC, PWX, WABQ, WAHG, WCAD, WCAR, WDAF, WDBO, WEAD, WEBJ, WEBW, WFI, WGES, WGH, WGHP, WGST, WHAD, WHAS, WHAZ, WIP, WJAZ, WJJD, WJR, WKAF, WKAR, WKAR, WMAQ, WMAZ, WMC, WNYC, WOI, WRC, WRVA, WSB, WTAM.

Eastern Time Stations

CFCA, Toronto, Can. (356.9m-840kc), 11 a. m., St. Michael's cathedral; 7 p. m., Walmer Road Baptist church.
 CKAC, Montreal, Can. (410.7m-730kc), 2:45 p. m., Jerry Shea and his Capitol theater symphony; organ specialties, Buddy Payne; vocal and instrumental solos.
 KDKA, Pittsburgh, Pa. (309.1m-970kc), 11 a. m., church services; 4 p. m., Dr. Charles Heinroth, organist; 4:45, Shadyside Presbyterian church; 6:30, dinner concert; 7:15, chimes; 7:45, church services.
 WBAL, Baltimore, Md. (246m-1220kc), 6:30-7:30 p. m., WBAL concert orchestra; Jules Sims, cellist.
 WBBR, New York, N. Y. (273m-1100kc), 10 a. m., Watchtower string trio; 10:15, Sunday school lesson; 10:35, Fred Franz, tenor; 10:45, Watchtower string trio; 10:50, I. B. S. A. choral singers; 11, Bible lecture; 11:30, I. B. S. A. choral singers; 2 p. m., Watchtower orchestra; 2:20, Fred Franz, tenor; 2:30, Bible instruction; 2:45, Fred Franz, tenor; 3, Bible lecture; 3:30, Fred Franz, tenor; 3:40, Watchtower orchestra; 9, Watchtower violin choir; 9:15, Bible questions and answers; 10, Watchtower string quartet.
 WBZ, Springfield, Mass. (333.1m-900kc), 10:50 a. m., South Congregational church; Prof. Wilson P. Moog, organist; 6, music hour; 7, Sunday evening concert, Copley Plaza orchestra; 7:30, orchestra of 55 pieces.
 WCAE, Pittsburgh, Pa. (461.3m-650kc), 4 p. m., WEAF program; 6:30, dinner concert, William Penn hotel; 7:20, WEAF program; 9:15, WEAF program.



Josef Hoffman, above, one of the best known of American pianists, will be the guest artist to broadcast Sunday during the Atwater Kent hour over the WEAFF chain. To the left is a pleasing young pianist, Louise Acherman, who plays frequently at WEAO, Columbus.



WCAP, Washington, D. C. (468.5m-640kc), 11 a. m., Memorial United Presbyterian church; 4 p. m., Bethlehem chapel; 6:20-7:20, vesper string ensemble; 7:20-9:15, Capitol theater; 9:15-10:15, WEAF.
 WCAU, Philadelphia, Pa. (277.6m-1080kc), 5 p. m., recital; 5:15, undenominational church services; 5:35, address, Rev. John W. Stockwell; 6:45, Clarence Seaman and his Hotel Pennsylvania concert orchestra; 7:45, Cathay concert orchestra; 8:30, Bonwit-Teller Light Opera company; Potash and Perlmutter; 10, program of popular music.
 WCX, Detroit, Mich. (516.9m-580kc), 7:15 p. m., Central Methodist Episcopal church; Guy C. Filkins, organist.
 WBBO, Winter Park, Fla. (239.9m-1250kc), 11 a. m., church service; 5-6 p. m., vesper service; 8, church.
 WEAF, New York, N. Y. (491.5m-610kc), 2-3 p. m., Sunday services, Greater New York Federation of Churches; quartet; 3-4, Young People's Conference; 4-5:30, Men's Conference, address, Dr. S. Parkes Cadman, WEEL, WTAG, WCAE, WSAI; Gloria Trumpeters; George Betts, chime soloist; Mr. and Mrs. Howard Kimsey, baritone and accompanist; 5:30, Carolina Singers; 6, George Barrere's Little symphony orchestra, WJAR, WGN; 7, Chamber musicale, WJAR, WGN; 7:20-9:15, musical program, Major Edward Bowes and the "Capitol Family" orchestra, artists, WEEL, WCAP, WJAR, WTAG, WWJ, WCAE; 9:15-10:15, Atwater Kent hour, Josef Hoffman and Elizabeth Day, soprano, WEEL, WCAP, WJAR, WGR, WCAE, WSAI, WWJ, WOC, WCCO, WGN, WEAR, KSD, WTAG, WOO.
 WEAR, Cleveland, Ohio (389.4m-770kc), 8:30 p. m., Goodyear concert orchestra; 7, Lowe's theater orchestra; 7:45, fireside hour; 8:30, Vincent Percy, organist; 9:15, WEAF.
 WEEL, Boston, Mass. (348.6m-860kc), 3 p. m., chamber of commerce organ recital; 5:30, Grigorief chorus; 7:20, WEAF; 9:15, WEAF.

WOO, Philadelphia, Pa. (508.2m-590kc), 2 p. m., Sunday school exercises, Bethany Presbyterian church; 6, organ recital; 7:30, services, Bethany Presbyterian church; 9:15, Atwater Kent hour of music.
 WPG, Atlantic City, N. J. (299.8m-1000kc), 3:15 p. m., organ recital, Arthur Brook; 4:15, community vocal and instrumental recital, St. James' Episcopal church; 9:15, Hotel Ambassador concert orchestra; 10, organ recital, Arthur Brook.
 WTAG, Worcester, Mass. (268m-1120kc), 4-5:30 p. m., music, Gloria Trumpeters and George Betts, chime soloist, and Mr. and Mrs. Howard Wade Kimsey, baritone and accompanist; 7:20-9:15, musical program, Major Edward Bowes; 9:15-10:15, WEAF.
 WTIC, Hartford, Conn. (475.9m-630kc), 5 p. m., Prof. Harry B. Jepson, organist; 9, concert, Colt's band.
 WWJ, Detroit, Mich. (352.7m-850kc), 11 a. m., St. Paul's Episcopal cathedral; 2 p. m., Detroit News orchestra; 4, organ recital; 7:20, WEAF program; 9:15, operatic stars.

Central Time Stations

KFAB, Lincoln, Nebr. (340.7m-880kc), 4-5 p. m., vespers; 9-11, musicale.
 KFDM, Beaumont, Tex. (315.6m-950kc), 11 a. m., First Christian church; 7:30 p. m., First Christian church.
 KFH, Wichita, Kans. (268m-1120kc), 9:45 a. m., Mens Brotherhood Bible class; 10-11 p. m., Coleman string quartet; Dorothy Crewe, soprano and Elmer Wiley, tenor; soloists; 12:15-1:15 a. m., Harry Hunts Imperial orchestra.
 KFNF, Shenandoah, Iowa (263m-1140kc), 10:45 a. m., First M. E. church; 2:30 p. m., Golden Rule song service; 6:30, regular services; 7:30, Christian church.
 KFRU, Columbia, Mo. (499.7m-600kc), 7:30 a. m., sunrise service, Nellie Lee Holt; 9:20, Burrall Bible class, Jessie Burrall; 7:30 p. m., First Baptist church.
 K LDS, Independence, Mo. (441m-680kc), 11 a. m., services; Minute Mothers' quartet; Irene Burroughs, violinist; sermon, U. Green; 3 p. m., sacred program, First Christian church of Independence; 6:30, vesper service, quartet; Lilly Belle Allen, soprano; Mrs. Arthur Daniels, contralto; Elbert Dempsey, tenor; Dr. Frank Criley, bass; Wesley Brokaw, saxophonist; U. Green; Margaret Armstrong, soprano; Robert Millers, organist; sermon, Dr. Frederick Smith.
 KMA, Shenandoah, Iowa (252m-1190kc), 12:15-1:15 p. m., sacred songs; 4, church choir music; 5, Bible class.
 KPRC, Houston, Tex. (296.9m-1010kc), 10:45 a. m., South End Christian church; Mrs. W. R. Shriner, Jr., organist; 7:50 p. m., First Church of Christ, Scientist; Mrs. Vivian G. Buchanan, organist; 9:30, Paramount Five, quartet and accompanist.
 KSD, St. Louis, Mo. (545.1m-550kc), 6:15 p. m., Post-Dispatch concert orchestra; 8:15, Atwater Kent Radio hour.
 KTBS, Hot Springs National Park, Ark. (374.8m-800kc), 11 a. m., First Baptist church; 9-10 p. m., New Arlington hotel grand ensemble; W. C. Brown, baritone; 10-11:30, Arkansas Traveler Limited; 11:30-12:30 a. m., Lawson Reid, organist.
 KUOA, Fayetteville, Ark. (299.8m-1000kc), 7:30 p. m., services, First Christian church.
 KYW, Chicago, Ill. (535.4m-560kc), 11 a. m., Central church; 2:30 p. m., chapel service; 4:30, concert; Apollo quartet; 7, Chicago Sunday Evening club.
 WAMD, Minneapolis, Minn. (244m-1230kc), 10:30 a. m., First Unitarian church; 3 p. m., band concert; 6:15, George Osborn and his orchestra; 6:45, Arthur H. Faust, Leone Faust, WAMD Radio Stock company; 9:30, Gayle Wood, harmony hurricane.
 WBAF, Fort Worth, Tex. (475.9m-630kc), 11 a. m., First Presbyterian church; 5-6 p. m., sacred music, Baptist seminary; 9:30-11, Texas hotel orchestra.
 WBBM, Chicago, Ill. (226m-1330kc), 12:30-2 p. m., classical program; William P. Zimmer, tenor; Harold Morava, lyric tenor; Kantor A. Kritz; Sandy Meek and Harry Sosnik; Edna Wheeler Ballard, harpist; Little Caruso and the Moulin Rouge quartet; 4-6, Spencer, Laverne and Shayne, xylophone; Tip trio; Jack Crawford's Alemitte orchestra; Barber Shop Three; Ziegler sisters; Two Jays; Harold Anderson; Charlie Garland; Rudy Winter; Floyd Falch; 8-10, Jack Crawford's orchestra; WBBM quartet; Maurice Silverman; Pauline Stiffler Atlas, violinist; Rudy Winter; Floyd Falch; 12-2 a. m., Nutty Club; Moulin Rouge orchestra.
 WCAL, Northfield, Minn. (336.9m-890kc), 8:30 a. m., Norwegian church services; Dr. Martin Hegland; 9:15 p. m., evening services; Gertrude Boe Overby, soloist.
 WCB, Zion, Ill. (344.6m-870kc), 8 p. m., male chorus, celestial bells; Carey Sisters, duetists; violin duets, Mr. and Mrs. Richard Hire; L. J. Hire, violator; Beulah Mitchell, soprano; G. R. Sparrow, contralto; Alexander De Pew, flutist; Wesley Carey, reader.
 WCCO, Minneapolis-St. Paul, Minn. (416.4m-720kc), 10:50 a. m., Plymouth Congregational church; 3 p. m., Bible study, Lutheran Bible institute; 4:10, House of Hope Presbyterian church; 6:20, Second Church of Christ; 8:15, WEAF.
 WDAF, Kansas City, Mo. (365.6m-820kc), 3-4 p. m., program, Kansas City university; 4-4:45, Sabbath vespers.
 WFAA, Dallas, Tex. (475.9m-630kc), 6-7 p. m., Bible class; 7:30-8:30, First Baptist church; 8:30-9:30, William B. Muse, tenor; 11-12, Ligon Smith and his orchestra.
 WGN, Chicago, Ill. (302.8m-990kc), 11:45-12:45 p. m., Sunday noon musical hour, Chicago theater; 12:45-1:45 Chicago theater complete performance; 2-3, Edwin Stanley Seder's organ concert; 3-4, concert, Chicago Philharmonic orchestra; 4-5, musical program; 5-5:15, old-time favorite songs; 7-7:30, musical program; 7:30-7:45, old-time favorite songs; 7:45-8:15, musical program; 9:15-10, musical program.
 WHAS, Louisville, Ky. (399.8m-750kc), 9:57 a. m., organ prelude; 10, Fourth Avenue Presbyterian church; choir music; Esther Metz, soprano; Mrs. Virginia Shearer Herriek, contralto; Williams Layne Vick, tenor; William G. Meyer, baritone; 4:30-5:30, Christ Church Cathedral evening choral service; Ernest Arthur Simon, organist; boys' choir.
 WHB, Kansas City, Mo. (365.6m-820kc), 9:40 a. m., Linwood Boulevard Christian church; 11:15-12:30 p. m., Independence Boulevard Christian church; 8-9:15, church service; 11:15-1 a. m., Linwood theater Radio feature; Morrill Moore, organist; Don Anchors, poet.

Atwater Kent Program, March 7, over WEAFF and Chain*

Artists will be Josef Hoffman, pianist, and Elizabeth Day, soprano.

I.	
"My Mother Bids Me Bind My Hair".....	Haydn
"May Day Carol".....	Deems Taylor
"Brown Bird Singing".....	Hayden Wood
"By the Waters of Minnetonka".....	Lieurance
"Believe Me If All Those Endearing Young Charms".....	Old Irish
"Old Black Joe".....	Foster
Elizabeth Day	
II.	
"Ballad in G Minor".....	Chopin
"Minuet Waltz".....	Chopin
"Prelude in C Sharp Minor".....	Rachmaninoff
"Melody in F".....	Rubenstein
"Caprice Espagnole".....	Moszkowski
Josef Hoffman	

*The WEAFF chain for the Atwater Kent hour (9:15 p. m. Eastern, 8:15 p. m. Central time) includes WEAFF, WOO, WGR, WCAE, WCAP, WJAR, WTAG, WGN, KSD, WCCO, WOC, WSAI, WEAR, WEEL, WWJ.

FROLIC WITH COOKCOO CLUB AT WCAR

Sunday, March 7

WMBB, Chicago, Ill. (250m-1200ke), 3-5 p. m., Trianon orchestra; Woodlawn theater orchestra; Lucile O'Hara, soprano; Tommie Hughes, tenor; Bob Duffy, baritone; 7:40-9, Fifth Church of Christ, Scientist; 9-11, Trianon orchestra; Woodlawn theater orchestra; Scotty Welsh and Madison Sisters, "The Golden Harmony Trio"; Billie Allen Hoff, blues singer; Maxwell Treharne, tenor.

WOAW, Omaha, Nebr. (526m-570ke), 9 a. m., chapel service; 1:30 p. m., matinee; 6, Bible study period, Mrs. Carl R. Gray.

WOI, Ames, Iowa (270m-1110ke), 10:45 a. m., college chimes; 11, chapel services.

WORD, Batavia, Ill. (275m-1090ke), 10 a. m., services; 2:30 p. m., program, Rapid Transit company; 3:30, Bible lecture; 7, Webster hotel concert trio; 7:15-8, evensong; 9, Webster trio; 9:15-10:30, services.

WQJ, Chicago, Ill. (447.5m-670ke), 9:30-11:30 a. m., sermon and services, People's church, Dr. Preston Bradley; choir; Clarence Eddy, organist; 3-4 p. m., concert, Jerry Sullivan; Resurrection church choir; Lenten music; Helen Morris, Lovetta Crutman, Rachael Ryan, sopranos; Mrs. Elmer Roe, Katherine Gray, contraltos; Placide Profeta, Horlan Desmarais, John McDonough, tenors; Peter Mathews, basso; Margaret McDevitt, accompanist; 8-10, Jack Chapman and his Rainbow Gardens orchestra; Ambrose Wyrick, tenor; Jeanette Van Lempe, mezzo-soprano; Pierson Thal, concert pianist; Sheppard Levine, tenor; Fontella trio; Otto Moore, baritone.

WSAI, Cincinnati, Ohio (325.9m-920ke), 3-4:30 p. m., music, Gloria Trumpeters; 7:45, chime concert; 8, sermon; 8:15, WEAF program.

WSB, Atlanta, Ga. (428.3m-700ke), 5 p. m., First Christian church choir; 7:30, Wesley Memorial Methodist church.

WSM, Nashville, Tenn. (282.8m-1060ke), 7:30 p. m., First Presbyterian church.

WSUI, Iowa City, Iowa (483.6m-620ke), 9:15 p. m., familiar hymns, Mrs. L. Lawyer.

Mountain Time Stations

KFXF, Colorado Springs, Colo. (250m-1200ke), 11-1 p. m., First Presbyterian church; 7:30-9, First M. E. church.

KOA, Denver, Colo. (322.4m-930ke), 10:50 a. m., First Church of Christ, Scientist; 3 p. m., Olinger Highlander Boys' First band; 7:50, First Church of Christ, Scientist.

KSL, Salt Lake City, Utah (299.8m-1000ke), 10:50 a. m., Second Church of Christ, Scientist; 3 p. m., artists' hour; 5, program, Bryant Junior high; 8, Radio Products company; 9, service.

Pacific Time Stations

KFI, Los Angeles, Calif. (467m-642ke), 4-5 p. m., vesper services; 6:30, nightly doings; 7-7:30, A. H. Grebe and company, Synchrophase trio; 7:30-8, All-American string quartet; 8-9, Aeolian residence pipe organ, Dan L. McFarland, organist; 9-10, Mabelle Hein and her Blue Bird band; 10-11, Packard Six dance orchestra.

KFON, Long Beach, Calif. (232.4m-1290ke), 6-6:30 p. m., Brayton's theater organ; 7:45-9, services, First Church of Christ, Scientist; 9-10, dance music.

KFWB, Hollywood, Calif. (252m-1190ke), 9-11 p. m., Warner Brothers Sunday night movie frolic.

KGO, Oakland, Calif. (361.2m-830ke), 11 a. m., First Methodist Episcopal church; 3:30 p. m., KGO Little symphony; 7:30, First Methodist Episcopal church.

KHJ, Los Angeles, Calif. (405.2m-740ke), 4-5 p. m., Masonic service; 7-8, First Methodist Episcopal church; 8-10, program, Martin music company with Ruth Pitts, soprano; John Martin, concert pianist.

KNX, Hollywood, Calif. (336.9m-890ke), 6:30-7 p. m., Unitarian church service; 8-9, First Presbyterian church of Hollywood; 9-10:30, program, Beverly Hills Nurseries with Calmon Luboviski, master violinist.

KPO, San Francisco, Calif. (428.3m-700ke), 5-6 p. m., organ recital, Marshall W. Gisselman; 6-6:30, Waldemar Lind and the States Restaurant orchestra; 6:35-8:35, Palace hotel concert orchestra; 8:35-10, Rudy Seiger's Fairmont hotel orchestra.

KPSN, Pasadena, Calif. (315.6m-950ke), 10:30 a. m., church services; 8:45-9:45 p. m., Maryland artists' ensemble.

KTAB, Oakland, Calif. (240m-1250ke), 9:45-10:45 a. m., Bible lecture; 11-12:30 p. m., church service; 7:45-9:15 p. m., church service; 9:30-11, after-service concert.

Monday, March 8

Headliners Today

Eastern	Central	Mountain	Pacific
3:15 p. m.	2:15 p. m.	1:15 p. m.	12:15 p. m.
WHO (526m-570ke)	Jack Little.		

High Lights of the Week

THROUGH the kindness of W. S. Quinby of Boston, music lovers unable to attend the Boston Symphony orchestra in person will have the pleasure of hearing the entire concert Saturday evening through WEEI. Fans feeling in the mood for a little fun may prefer to tune in for the San Antonio Light's Cookcoo club of WCAR's at eleven p. m. Central time.

The Atwater Kent artists over the WEAF chain this week are Josef Hoffman, America's best known pianist, and Elizabeth Day, soprano. The Sunday afternoon concert at KGO will attract many listeners. Incidental music from the Norwegian drama, "Sigurd Jalsafar," by Grieg will be featured.

Monday schedules another Grieg program when Amy Wheelock returns to WTIC, Hartford. Miss Wheelock will be remembered for the fine program she gave at this station last year.

Cowboys and cowgirls are gathering this week at Fort Worth, Texas, for the annual Southwestern Exposition and Fat Stock show. WBAP will pick up the events of the rodeo, Tuesday evening. These will be described by the Hired Hand himself.

Tuesday night is also important because the WBAL opera company makes its debut in "Cavalleria Rusticana."

All pessimists are invited to tune in for the meeting of the Optimist club of New Orleans, at WSMB, Wednesday. The Hart House string quartet which has been engaged by the Canadian National railways to appear exclusively at CNR stations, will appear Wednesday at CNRE. Lovers of classical music will enjoy this program.

A debate between students of the University of Chicago and Iowa State college is scheduled for Thursday evening over WMAQ, Chicago. The debate, which takes place in Mandel hall will be relayed direct to the station. The 9 p. m. Pacific time program of KPO, San Francisco, presents the operetta "El Toroso," under the direction of Katharine Sharpstein.

Fiddlers of the North-Atlantic states are contesting at WBZ, Springfield, Friday, for the Henry Ford loving cup to be awarded the winner. Perhaps these champions from various parts of the U. S. will meet and a national champion will be chosen.



The handsome gentleman above is Mario Alvarez, who is a weekly feature at WOJ, Newark. His fine baritone voice has supported many a New York musical comedy. CNRO is the fortunate possessor of a charming hostess in Florence Charron, right. She is often called upon to charm her invisible friends over the microphone.



WBAL, Baltimore, Md. (246m-1220ke), 6:30-7:30 p. m., WBAL dinner orchestra; 7:30-8, Frederick D. Weaver, organist; 8-9, Edith Reinhardt, soprano; Minnie Faber, pianist; Arthur Ver Valen, baritone; 9:10-10, Bess Perry, contralto; Ruth Trullitt, violinist.

WBRR, New York, N. Y. (273m-1100ke), 8 p. m., Jubilee entertainers; 8:20, Jubilee entertainers; 8:50, Jubilee entertainers.

WBZ, Springfield, Mass. (333.1m-900ke), 6:30 p. m., Hotel Kimball dance orchestra; 7:30, Rene Dagenais, organist; 8, Capitol theater orchestra; 8:30, concert, Grace E. Campbell; Anne Embree, soprano; Beulah M. Sweetser, mezzo-contralto; Marie Van Praet, contralto; Grace Brandon, violinist; Sarah E. Ames, cellist; 9, concert; 9:30, Loew's State theater vaudeville attractions.

WCAE, Pittsburgh, Pa. (461.3m-650ke), 6:30 p. m., dinner concert, William Penn hotel; 8, studio concert; 9, grand opera, WEAF; 11, Ralph Harrison's Midnight Sons.

WCAP, Washington, D. C. (468.5m-640ke), 6:30-11 p. m., concert, Evangeline hotel; WEAF program.

WCAU, Philadelphia, Pa. (277.6m-1060ke), 7:30 p. m., recital, N. Snellenburg and company; 8, Carolyn Thomas, soprano; Ella Jacqueline Kratz, pianist; 8:30, The Hood Boys; 9, Mall's Merry Makers; 9:30, Sugar Cane orchestra; 10, Arlene R. Smith, soprano; Kathryn Fighorne, contralto; Sarah Snyder, pianist; 10:30, Parodians dance orchestra.

WCX, Detroit, Mich. (516.9m-580ke), 6-7 p. m., dinner program, Goldkette ensemble; 8-9, program.

WDBO, Winter Park, Fla. (239.9m-1250ke), 9:30-11 p. m., entertainment.

WEAF, New York, N. Y. (491.5m-610ke), 4-12 midnight, Vivian Sherwood, contralto; Godfrey James, tenor; Vincent Lopez and his orchestra; dinner music; Robert Lindholm, accordionist; Irene Peckham, pianist; "Pop Concert"; WOO; 8:45 p. m., health talk, WEEI, WCAP; 9, A. and P. Goyette, WEEI, WCAP, WWJ, WJAR, WOO; 10, "Samson and Delilah," grand opera, WOO, WCAP, WJAR, WTAG, WCAE; Ben Bernie and his orchestra.

WEAR, Cleveland, Ohio (389.4m-720ke), 7 p. m., Allen theater orchestra.

WEEL, Boston, Mass. (348.6m-860ke), 5 p. m., Rainbow Ramblers; 6:13, Joe Rines and his Hunters' Cabin orchestra; 6:45, Big Brother club; 7:30, Cecelia and Robert Gomberg, violinists; 8, Black Iron Shiners; 8:45, WEAF; 10, Scotty Holmes and his orchestra.

WFI, Philadelphia, Pa. (394.5m-760ke), 1 p. m., Tea Room ensemble; 3, recital, Comb's Conservatory of Music; 6:30, Bellevue Stratford concert orchestra; 7, Bellevue Stratford dance orchestra.

WGBS, New York, N. Y. (315.6m-950ke), 1:30 p. m., songs, Betty Chandler, Jerome Green; 2, Manhattan string trio; 3, Elsie McCormick; 3:30, Tex Sanderson, tenor; 3:40, League of Women Voters' program; 6:15, Little Bear Balalaika orchestra.

Eastern	Central	Mountain	Pacific
8 p. m.	7 p. m.	6 p. m.	5 p. m.
WGHP (270m-1110ke)	Little Symphony orchestra.		
WTAM (389.4m-770ke)	Excerpts from grand opera.		
WTIC (475.9m-630ke)	Amy Wheelock.		
8:30	7:30	6:30	5:30
WBAP (475.9m-630ke)	Grapevine fiddle band.		
9	8	7	6
WDAF (365.6m-820ke)	Ivanhoe band.		
WEO (526m-570ke)	Fort Dodge Municipal band.		
WTAG (268m-1120ke)	Robin Hood hour of music.		
10	9	8	7
KPRC (296.9m-1010ke)	Municipal orchestra.		
11	10	9	8
WSAI (325.9m-920ke)	Cincinnati community program.		
WTIC (475.9m-630ke)	Symphonic ensemble.		

Monday silent night for: CNRA, CNRC, CNRE, CNRM, CNRO, CNRR, CNRT, CNRV, CNRY, KFAU, KFD, KFEQ, KFMX, KFWA, KHJ, KLDS, KUOA, KYW, WBBM, WBCN, WCAD, WCB, WEAO, WEBB, WEBJ, WEBW, WENR, WGBS, WGES, WGN, WHAS, WHT, WMO, WIP, WJAZ, WJJD, WKAQ, WLBB, WLS, WMAQ, WMBB, WOAI, WOC, WOK, WORD, WQJ, WRC, WREO.

Eastern Time Stations

CFOA, Toronto, Can. (356.9m-840ke), 6:45-7:45 p. m., concert, Conger Coal orchestra.

CKNC, Toronto, Can. (356.9m-840ke), 8-10 p. m., chamber music hour; Toronto Conservatory instrumental trio; Frank Blachford, violinist; Leo Smith, cellist; Alberto Guerrero, pianist.

KDKA, Pittsburgh, Pa. (309.1m-970ke), 12:30 p. m., Trinity church Lenten service; 6:30, dinner concert; 9, light opera hour.

WAHG, Richmond Hill, N. Y. (315.6m-950ke), 12 noon, Grebe matinee trio; 7:30 p. m., Walter A. Iooss, pianist; Boy Scout program; 8, synchrophase hour; 9:15, John De Bueris, clarinetist; 9:45, Florence Ward, mezzo-contralto; 10, Walter and Sidney Sellers, vocal duets; 10:15, dance music; 12 midnight, Queens Melody boys; Bob McDonald, ukulele.

WGCP, New York, N. Y. (252m-1190ke), 8:30 p. m., program; 9:15, program; 10, China Royal orchestra; 10:30, Strickland's orchestra.

WGHP, Detroit, Mich. (270m-1110ke), 6-7 p. m., Hotel Tuller dinner concert; 8-10, Little Symphony orchestra; Joseph Mosbach, bassoon; Jean Courtois, violinist; T. Stanley Perry, tenor; Leona E. Mitchell, soprano; 12-1 a. m., Gerald Marks and his orchestra.

WGY, Schenectady, N. Y. (379.5m-790ke), 6:30 p. m., Hotel Van Curler orchestra; 7:45, American trio; 8:15, WGY orchestra.

WHAR, Atlantic City, N. J. (275.1m-1090ke), 8 p. m., Seaside hotel trio; 11, Polles Bergere dance orchestra.

WHN, New York, N. Y. (361.2m-830ke), 6:05-7 p. m., Mirror People's hour; 7-7:30, Twin Oaks orchestra; 7:30-8, Metropolitan organ recital; 8:05-8:35, Roseland dance orchestra; 8:40-9, Perry and Russell, one-man act; 9-9:30, Loew's theater orchestra; Eva Rothenberg, pianist; 11-11:30, Cotton club orchestra; 11:30-12 midnight, Silver Slipper orchestra; 12-12:30 a. m., Parody club orchestra.

WIP, Philadelphia, Pa. (508.2m-590ke), 1 p. m., Gimbel tea room orchestra; 3, artist recital, Fairman school of music; 6:05, Benjamin Franklin concert orchestra; 7, Uncle Wip's bedtime stories; dancing lessons, Miller Conservatory of Dancing.

WJR, Pontiac, Mich. (516.9m-580ke), 7 p. m., Jean Goldkette's symphony orchestra; soloists; 11:30, "The Merry Old Chief."

WJZ, New York, N. Y. (454.3m-660ke), 1 p. m., Meyer Davis' Park Lane orchestra; 4:30, Sherry's Fifth Avenue trio; 7, Hotel Commodore dinner concert; Astor Coffee orchestra; 9, Henry Hadley and his Philharmonic orchestra; 10:30, Keith McLeod, pianist; Milton J. Cross, tenor; 10:45, George Olsen's Hotel Pennsylvania grill orchestra.

WLIT, Philadelphia, Pa. (394.5m-760ke), 12:02 p. m., date, Almanac; Stanley theater organ recital; Arcadia cafe concert orchestra; 2, Arcadia cafe concert orchestra; 4:30, Alice Wightman, pianist; 7:30, Dream Daddy's bedtime stories; 8:15, concert from Camden Radio show; 9, Stanley theater hour; 10, Arcadia cafe dance orchestra; 10:30, Fay's vaudeville features; 10:45, Benjamin Franklin hotel dance orchestra.

WLWL, New York, N. Y. (288.3m-1040ke), 9:15 p. m.,

BOSTON SYMPHONY THROUGH WEEI;

POPULAR CONCERTS INDEX

Saturday, March 6

Eastern	Central	Mountain	Pacific
7:30 p. m.	6:30 p. m.	5:30 p. m.	4:30 p. m.
WAAA.	7	6	5
WAMD, WLS.	8	7	6
9	8	7	6
WBBM, WDAF, WENR, WGBS, WLS, WMAQ, WNYC.	9	8	7
10	9	8	7
KFAB, KPRC, WBBM, WEBH, WENR, WGN, WLS, WMBB, WREO.	11	10	9
12	11	10	9
10	9	8	7
KFVE, KFVB, KNX, KTHS, WBBM, WMBB, WOK, WQJ, WRC.	11	10	9
12	11	10	9
10	9	8	7
KNX, KOIL, KPO, KPRC, WBBM, WEBH, WLS, WOAW, WOK, WQJ.	11	10	9
1 a. m.	12 m.	11	10
KFWB, WDAF, WBBM, WEBH, WENR, WOK, WQJ, WSAI.	2	1 a. m.	12 m.
2	1 a. m.	12 m.	11
KNX, WBBM, WEBH, WENR, WQJ.			

Sunday, March 7

Eastern	Central	Mountain	Pacific
9 p. m.	8 p. m.	7 p. m.	6 p. m.
WBBM.	9	8	7
10	9	8	7
WBBM, WMBB.	10	9	8
11	10	9	8
WMBB.	11	10	9
12	11	10	9
KNX, KTHS.	12 m.	11 p. m.	10
1 a. m.	12 m.	11 p. m.	10
KFWB, WBBM.	2	1 a. m.	12 m.
2	1 a. m.	12 m.	11
KFWB.			

Monday, March 8

Eastern	Central	Mountain	Pacific
7 p. m.	6 p. m.	5 p. m.	4 p. m.
WBBM, WFAA, WOAW.	7	6	5
8	7	6	5
WGBS.	8	7	6
9	8	7	6
WCAU, WFAF, WGR, WKRC, WOK.	10	9	8
10	9	8	7
KFAB, WEBH, WGR, WKRC, WMCA, WOAW, WOK, WSOE.	11	10	9
11	10	9	8
KFAB, KFVE, WOK.	12	11	10
12	11	10	9
10	9	8	7
KLX, KNX, KOIL, WAMD, WEBH, WHO, WOK.	11	10	9
1 a. m.	12 m.	11	10
KFWB, KLX, WAHG, WDAF, WHT, WKRC, WOK.	2	1 a. m.	12 m.
2	1 a. m.	12 m.	11
KFWB.			

Tuesday, March 9

Eastern	Central	Mountain	Pacific
7 p. m.	6 p. m.	5 p. m.	4 p. m.
WMA, WOAW.	8	7	6
8	7	6	5
WBBM, WEAR.	9	8	7
10	9	8	7
WBBM, WEAR, WBZ, WSB.	10	9	8
10 p. m.	9 p. m.	8 p. m.	7 p. m.
WBBM, WEBH, WMBB, WOAW.			

Monday, March 8

songs; 10, music; 10:15, study club; 10:30, entertainment.

WMAK, Buffalo, N. Y. (266m-1130ke), 7:30-8:30 p. m., Murray Whiteman and his Serenaders; 8:30-9, musical program; 9-10, musical program; 10-11, musical program.

WMAA, New York, N. Y. (340.7m-890ke), 6 p. m., Olcott Vail and his Hotel McAlpin string ensemble; 6:30, Ernie Golden and his Hotel McAlpin orchestra; 7:30, Kurtz Carnival Kings; 8, Terminal musical hour; 10:15, Woodmansten Inn orchestra; 11:30, Jack Denny's orchestra.

WNYC, New York, N. Y. (526m-570ke), 6:20 p. m., songs; 7:50, song recital; 8, concert program; 9:30, violin recital, songs; 10:35, Richmond Versatile orchestra.

WOO, Philadelphia, Pa. (508.2m-590ke), 11 a. m., organ recital; 12:02 p. m., Crystal tea room orchestra; 4:45, organ recital; 7:30, Rita Carlton concert orchestra; 8, Pop concert; 9, A. and P. Gypsies; 10, Grand opera from WEAF; 11, Adelphi dance orchestra.

WOR, Newark, N. J. (405.2m-740ke), 2:30 p. m., Orchestre's Queensland orchestra; 6:30, Jacques Jacob's Hotel Shelton ensemble; 7:30, Katinka orchestra; 8:30, Al Reid's hour; 9:30, Helen Schafmeister, pianist; 9:45, Susanne Richmond, violinist; 10, Helen Schafmeister, pianist; 10:15, Susanne Richmond, violinist; 11-12, midnight, Hofbrau Haus orchestra.

WPG, Atlantic City, N. J. (299.8m-1000ke), 4:30 p. m., Chalfonte-Haddon Hall tea music; 6:45, organ recital, Arthur Brook; 7, Hotel Morton dinner music; 8, children's hour; 8:40, piano recital; 9, Hotel Ambassador concert orchestra; 10, vocal recital, Ethel Dobson, coloratura soprano; 10:15, Golden Hall trio; Phyllis Herbine, violinist; Adine Barozzi, cellist; Vera Chadsey, pianist; 11, Silver Slipper Supper club, Eddie McKnight's dance orchestra.

WRC, Washington, D. C. (468.5m-640ke), 12 noon, organ recital, Henri Smith-Gregory; 12:30 p. m., Lenten services; 1, Shoreham hotel orchestra; 4:30, musical program.

WRVA, Richmond, Va. (256m-1170ke), 8:10 p. m., organ recital, F. Plaxington Harker; 9, Dr. Douglas Freeman in "Old Virginia Folk Lore"; 9:45, Harold Lawrence, blind musician, and his orchestra; 11, Carry Me Back to Old Virginia.

WTAG, Worcester, Mass. (266m-1120ke), 10:30 a. m., musical program; 12:05-2 p. m., noon-day luncheon music; 7:15, "Twilight Scouts"; 9-10, Robin Hood hour of music; 10-11, WEAF.

WTAM, Cleveland, Ohio (389.5m-770ke), 12:15-1:30 p. m., Austin Wylie's Vocalion Recording orchestra; 6-7, Carl Rupp and his Hotel Hollenden orchestra; 8-11, symphony orchestra, Women's Exposition; excerpts from Grand Opera, Mr. and Mrs. Wheeler, Doris Howe, John Pierce; 11-12, Austin Wylie's Vocalion Recording orchestra; 12-1 a. m., Guy Lombardo and his Royal Canadians.

WTIC, Hartford, Conn. (475.9m-630ke), 11:25 a. m., violin solos, Beatrice Torgan; 12:05 p. m., Travelers club orchestra; 9, John Conlon, baritone; Irene Paul, soprano; 9:30, Emil Heimberger's Hotel Bond orchestra; 10, grand opera; 11, Travelers symphonic ensemble; Amy Wheelock.

WWJ, Detroit, Mich. (352.7m-850ke), 12:05 p. m., Jules Klein's Hotel Statler orchestra; 3, Detroit News orchestra; 6, dinner concert; 8, Detroit News orchestra; 9, WEAF program.

Central Time Stations

KFAB, Lincoln, Nebr. (340.7m-880ke), 9-9:30 p. m., dinner concert; 8:30-10:30, Ed Ellingson, original songbird; Harriet Cruise, oriole of the air; Gloomy Gus, Mike Kopac, pianist; Belsbaw's orchestra, Cowbell Boys.

KFH, Wichita, Kans. (268m-1120ke), 10-11 p. m., en-

Eastern	Central	Mountain	Pacific
11 p. m.	10 p. m.	9 p. m.	8 p. m.
KFVE, KFVB, KNX, WBBM, WHT, WMBB, WOK, WQJ.	12 m.	11	10
12 m.	11	10	9
KNX, KOIL, KPO, WAMD, WBBM, WEBH, WEBH, WKRC, WMC, WOK, WQJ.	1 a. m.	12 m.	11
1 a. m.	12 m.	11	10
KFWB, KNX, WFAA, WHT, WOAW, WOK, WQJ.	2	1	12 m.
2	1	12 m.	11
KFWB, WQJ.			

Wednesday, March 10

Eastern	Central	Mountain	Pacific
8 p. m.	7 p. m.	6 p. m.	5 p. m.
KFNE, WAHG, WEBJ, WEEL, WMCA.	9	8	7
10	9	8	7
WBBM, WEBJ, WGCP, WNYC.	10	9	8
11	10	9	8
KFAB, KPRC, WBBM, WEBH, WGCP, WHO, WMBB.	11	10	9
12	11	10	9
KFAB, KFVE, KGW, KPO, KWSC, KYW, WBBM, WHN, WMBB, WOK, WQJ.	12 m.	11	10
1 a. m.	12 m.	11	10
KFWB, WDAF, WBBM, WEBH, WENR, WOK, WQJ, WSAI.	2	1 a. m.	12 m.
2	1 a. m.	12 m.	11
KFWB, KNX, WBBM, WOK, WQJ.			

Thursday, March 11

Eastern	Central	Mountain	Pacific
8 p. m.	7 p. m.	6 p. m.	5 p. m.
WCAE, WEAF, WJAR, WMC, WOC, WSAI.	9	8	7
10	9	8	7
WBBM, WHAD.	10	9	8
11	10	9	8
KMA, WBBM, WEBH, WEEL, WHAD, WHN, WMBB, WMC, WNYC, WOAW, WSOE.	12	11	10
1 a. m.	12 m.	11	10
KHJ, KMA, KYW, WBBM, WMBB, WOK, WQJ.	2	1 a. m.	12 m.
2	1 a. m.	12 m.	11
12 m.	11	10	9
KHJ, KTAB, KOIL, WBBM, WDAF, WEBH, WFAA, WKRC, WOC, WOK, WQJ.	1 a. m.	12 m.	11
1 a. m.	12 m.	11	10
KFWB, KHJ, WHT, WOK, WQJ.	2	1 a. m.	12 m.
2	1 a. m.	12 m.	11
KNX, WQJ.			

Friday, March 12

Eastern	Central	Mountain	Pacific
8 p. m.	7 p. m.	6 p. m.	5 p. m.
WGCP, WJR.	9	8	7
10	9	8	7
WAMD, WBBM, WGR, WLS.	10	9	8
11	10	9	8
KFAB, WBBM, WEBH, WMC, WDAF, WHAD, WMBB, WOAW, WSOE.	12	11	10
1 a. m.	12 m.	11	10
KFVE, KFVA, KHJ, KLX, KYW, WMBB, WOK, WQJ.	2	1 a. m.	12 m.
2	1 a. m.	12 m.	11
KFWB, KHJ, KNX, KOIL, WAMD, WEBH, WMC, WOK, WQJ.			
1 a. m.	12 m.	11	10
KFWB, KHJ, WDAF, WHT, WOK, WQJ.	2	1 a. m.	12 m.
2	1 a. m.	12 m.	11
KNX, WQJ.			

tertainers; 12:15-1:15 a. m., Harry Hunts' Imperial orchestra.

KFRU, Columbia, Mo. (499.7m-600ke), 4:30 p. m., Bella Vista Quadrangle orchestra; 6:15, dinner music.

KMA, Shenandoah, Iowa (252m-1190ke), 11:30-12:30 p. m., noonday rural program; 6-7, popular music; 9-11, Farnham trio; How-Do-You-Do Boys.

KPRC, Houston, Tex. (296.9m-1010ke), 12 noon, Frank Titton, blind wonder boy pianist; 7:30 p. m., Record's Rumbler's dance orchestra; 8:30, concert; 9, Houston Municipal orchestra.

KSD, St. Louis, Mo. (545.1m-550ke), 7 p. m., Rader instrumental quartet; 9, Nu Psi Epsilon concert.

KSO, Clarinda, Iowa (241.8m-1240ke), 7-7:30 p. m., music; 7:30-9:30, old-time music, Wes Miller; Hay Mow Five concert.

KTHS, Hot Springs National Park, Ark. (374.8m-800ke), 9-9:40 p. m., New Arlington string trio; 9:40-9:55, Southland classics; 10-11, Pooley hour frolic.

KUOA, Fayetteville, Ark. (299.8m-1000ke), 8 p. m., Epworth league male quartet.

KYW, Chicago, Ill. (535.4m-560ke), 12:05-1 p. m., noonday concert; 1-2, luncheon concert; 6-7, dinner musical.

WAND, Minneapolis, Minn. (244m-1230ke), 6:15 p. m., string orchestra; 7:01, Garrick symphony orchestra; 11, George Osborn and his orchestra.

WBAP, Fort Worth, Tex. (475.9m-630ke), 6-6:30 p. m., Texas hotel orchestra; 7:30-8:30, Grapevine fiddle band, 9:30-11, Ward's Trail Blazers; 11-12, Majestic theater.

WBBM, Chicago, Ill. (226m-1330ke), 4-6 p. m., Harry Soskin; Irene Beasley; Joe McManus; pianist; Floyd Palmer; Court Banks; Jack Pennewell and Freddy Ballard, harpist; 6-7, Beulah Mowers, pianist; Two Stars; Charlie Garland; Barber Shop Three; Floyd Falch; Fair and Warner, two pianos; Dave Handler, violinist.

WCAL, Northfield, Minn. (336.9m-890ke), 8:30 p. m., musical program, college quartet; girls' sextet; Bernice O'Hara, violinist.

WCAR, San Antonio, Tex. (263m-1140ke), 8-10 p. m., musicale.

WCCO, Minneapolis-St. Paul, Minn. (416.4m-720ke), 12 noon, concert, Donaldson's orchestra; 2:30 p. m., afternoon concert; 6:30, dinner concert, Gordon Cooke ensemble, Meta Aspin, soprano; Louise Lupien Jenkins, accompanist; 8, University of Minnesota opera program; 9, classical concert, Fred Albrecht's Osman Temple band.

WDAF, Kansas City, Mo. (365.6m-820ke), 6-7 p. m., Trioan ensemble; 8-9:30, program, Ivanhoe band; Al Cossetta, tenor; Mrs. R. O. Sniely, soprano; Mrs. Virginia Sowers, accompanist; 11:45-1 a. m., Ted Weems' Victor Recording orchestra.

WFAA, Dallas, Tex. (475.9m-630ke), 12:30-1 p. m., Paul D. Ray, pianist; 4:30-5, Cyrus Barcus, cornetist; 6:30-7:30, Honey Boys' orchestra; 8:30-9:30, Sears-Robuck Agricultural program.

WHAS, Louisville, Ky. (399.8m-750ke), 1-2 p. m., concert, Royal Peacock orchestra; 3-3:30, Mrs. Myrtle Fuls Zahn, Jr., organist; 4-5, concert, Music Box Extension studio.

WHB, Kansas City, Mo. (365.6m-820ke), 2-3 p. m., ladies' hour; 7-8, Sweeney Radio orchestra; May Nelson, popular songs; Theima Crespo, pianist.

WHO, Des Moines, Iowa (526m-570ke), 2:15 p. m., Jack Little; 7:30-8, Paul Stoye, pianist; 8-9, Fort Dodge WHT, Chicago, Ill. (399.8m-750ke), 10 a. m., Helen Municipal band; 11-12, L. Carlos Meier, organist, Raub, pianist; 12 noon, Al Carney's organ recital.

WKAF, Milwaukee, Wis. (261m-1150ke), 10-11 p. m., Ethel Brenk, soprano; Lucille Meister, violinist; Robert Hall, baritone.

WKRC, Cincinnati, Ohio (325.9m-920ke), 6 p. m., dinner program, Alvin Reher's orchestra; 8, popular song program; 9, musical program; 12, Kodol midnight frolic, popular music; 12:30 a. m., Wesley Helvey's Troubadours.

WLS, Chicago, Ill. (344.6m-870ke), 6 p. m., studio trio.

WLW, Cincinnati, Ohio (422.3m-710ke), 4 p. m., student recital, pupils of Leo Stoffregen; 7, dinner concert, Hotel Gibson orchestra; 7:20, theatrical feature;



"Radio Sunshine Girl" is the title given Ni afternoons. Miss Smiley has attained co-sings her own songs. Hawaiian music file Guyman, below, invade the studio of WSOE not always wear a ruff. He appeared in operatic role at WCCO, recently. Mr. G.

8, Cincinnati Times-Star orchestra, William Kopp, director.

WMAQ, Chicago, Ill. (447.5m-670ke), 4:35 p. m., pupils, Glenn Dillard Gunn school of music; 5, games for the home, Glenn D. Adams; 6, Chicago theater organ recital; 6:30, Hotel La Salle orchestra.

WMAZ, Macon, Ga. (261m-1150ke), 9 p. m., Georgia Sirens orchestra; 10-11, Wesleyan college student night.

WOAW, Omaha, Nebr. (526m-570ke), 6:20 p. m., Frank Peterson, tenor; Helen Higgins, pianist; 6:50, Royal Fontenelle orchestra; 9, classical.

WOI, Ames, Iowa (270m-1110ke), 7:50 p. m., Alumni program.

WSAI, Cincinnati, Ohio (325.9m-920ke), 10 p. m., Cincinnati community program.

WSB, Atlanta, Ga. (428.3m-700ke), 8 p. m., entertainment; 10:45, Vick Myers orchestra.

WSM, Nashville, Tenn. (282.8m-1060ke), 6:30 p. m., concert, Francis Craig's orchestra; 8, program, Margaret Pittman and associate artists; 10, program, Vito Pelletieri's orchestra.

WSMO, New Orleans, La. (319m-940ke), 9:30 p. m., St. Charles theater orchestra; Dixola Novelty orchestra; Strand theater orchestra; Fuzzy Wuzzy Twins.

WSUI, Iowa City, Iowa (483.6m-620ke), 12:30 p. m., Mrs. Dorothy Spencer, soprano; 7:30, Ohio-Iowa basketball game; 8:50, musical concert.

Mountain Time Stations

KFXF, Colorado Springs, Colo. (250m-1200ke), 8:30-10:30 p. m., soprano solos, Mrs. Kingsley Ballou.

KOA, Denver, Colo. (322.4m-930ke), 12:15 p. m., Marjorie Nash, organist; 6:30, Brown Palace string orchestra; 8, Spanish, Prof. A. L. Knecht; 8:30, KOA orchestra; 9:30, KOA orchestra.

KSL, Salt Lake City, Utah (299.8m-1000ke), 8 p. m., program, Crawford Furniture company; 9, Royal Baking company.

Pacific Time Stations

KFI, Los Angeles, Calif. (467m-642ke), 5:30-6 p. m., Owen Fallon's Californians; 6, highly dolans; 6:15, Seeing California; 6:30, vest pocket program; 6:45, Radiatorial period; 7-8, Eleanor Woodford, soprano; 8-9, Louise Kros trio, violin, cello and harp; 9-10, program, Walter M. Murphy Motors company, KPO; Mische Gagna string orchestra, Thoma Manchini, concert violinist; 10-11, popular program arranged by Medlejohn Brothers.

KFOA, Seattle, Wash. (454.3m-660ke), 12:30-1:30 p. m., Lions' club luncheon program; 7-8:15, Sherman Clay and company program; 8:30-10, Times program.

KFON, Long Beach, Calif. (336.9m-1290ke), 6-6:30 p. m., Brayton's theater organ; 7-8, Investors' hour with orchestra; 8-9, Press-Telegram studio; 9-11, the Venetians dance orchestra.

KFWB, Hollywood, Calif. (252m-1190ke), 6-7 p. m., dinner music, Fitzgerald Music company; 7:30-8, program, Dr. Ralph Mitchell and Friendly Dentists' orchestra; 8-9, Bill Hatch's Oakmont Country club dance orchestra; 9-10, program, Star Motor company, featuring Million Dollar Four orchestra; Tom Brennan, baritone; Sol Hoopii's Hawaiians; 10-11, Warner Brothers' frolic.

KGO, Oakland, Calif. (361.2m-830ke), 3-4 p. m., Eva F. Hicks, soprano; Louise Polos, pianist; Mitchell Landis, baritone; 6-6:55, Knickerbocker trio; 8, Arion trio; 9-15, Arion trio.

KLX, Oakland, Calif. (508.2m-590ke), 6:30-7 p. m., Athens Athletic club orchestra; 9-10:30, Lake Merritt Ducks.

KMTR, Hollywood, Calif. (238m-1260ke), 7:15 p. m., Y. M. C. A. musical hour; 8-10, KMTR concert orchestra, Loren Powell, director; 10-11, Starr Piano company studio.

KNX, Hollywood, Calif. (336.9m-890ke), 5-5:30 p. m., Sunny Jim's talk; 5:30, Leighton's cafeteria orchestra; 6, Town Tattler; 6:15, travel talk, W. F. Alder; 6:30-7, Atwater Kent concert orchestra; 7-7:30, Mutual Motors mirth contest; 7:30-8, program, Overall's Furniture company; 8-9, program, L. W. Stockwell company; 9-10, KNX feature program; 10-11, Goodrich Silvertown Cord dance orchestra; Lilyan May Challenger, contralto; 11-12 midnight Coconut Grove dance orchestra from Ambassador.

KPO, San Francisco, Calif. (428.3m-700ke), 1-2 p. m., Rudy Seiger's Fairmont hotel orchestra; 2:30-3:30, matinee program; 6:40-7, Waldemar Lind and the States Restaurant orchestra; 7-7:30, Rudy Seiger's Fairmont hotel orchestra; 8-9, Uda Waldrop, organist; 10-11, Cabiria cafe dance orchestra.

KTAB, Oakland, Calif. (240m-1250ke), 12-1 p. m., luncheon concert; 8-10, program.

KWSC, Pullman, Wash. (348.6m-860ke), 7:30-9 p. m., special program, Colfax Chamber of Commerce.

Tuesday, March 9

Headliners Today

Eastern	Central	Mountain	Pacific
3:15 p. m.	2:15 p. m.	1:15 p. m.	12:15 p. m.
WHEI (596m-570ke) Jack Little.			

Eastern	Central	Mountain	Pacific
9 p. m.	8 p. m.	7 p. m.	6 p. m.
WHEI (526m-570ke) Jack Little.			
WLW (422.3m-710ke) Old-time review.			
WSB (428.3m-700ke) Kimo Kohohis Moonlight Five.			
10	9	8	7
WBAL (246m-1220ke) "Cavalleria Rusticana," grand opera.			
10:05	9:05	8:05	7:05
WIP (508.2m-590ke) Motion picture stars.			
10:30	9:30	8:30	7:30
KTHS (374.8m-800ke) Mill male quartet.			
WBAP (475.9m-630ke) Rodeo.			
11	10	9	8
KTHS (374.8m-800ke) Folk music of Pueblo and			

HIRED HAND WILL DESCRIBE RODEO

Tuesday, March 9

WFAA, Dallas, Tex. (475.9m-630ke), 12:30-1 p. m., Edmund F. Boettcher, tenor; Violet Cassidy, pianist; 4:30-5, MacDowell Sisters; 6:30-7:30, Jimmy's Jests; 8:30-9:30, Southern Methodist university; 11-12, Harry Hassall, cellist.

WGN, Chicago, Ill. (302.8m-990ke), 11-11:30 a. m., morning organ concert, Chicago theater, Dean Fossler; 12:40-2:30 p. m., luncheon concert music; 2:30-3, Lyon and Healy artists' recital; 3:25, Port o' Missing Men; 3:30-4:15, tea time music; 4:30-5, organ recital, Edward Benedict; 5:30-5:57, Skeezix time; 6:30-6:45, dinner concert music; 6:45-7, old-time favorite songs; 9-10, Jacques Gordon, violinist; 10-10:10, play shop; 10:10-10:15, old-time favorite songs; 10:15-11, dance music; songs, Correll and Goshen, Freda Leonard and Jewell Barnett.

WHAS, Louisville, Ky. (399.8m-750ke), 1-2 p. m., concert, Benson trio; 3-3:30, Mrs. Myrtle Pulks Zahn, Jr., organist; 4-5, concert, Music Box Extension studio; 7:30-9, concert, Eddie Ross and his orchestra; Eddie Ross, drums; Katherine Ross, pianist; Robert Seaton, saxophonist, clarinetist; Raymond Lawrence, saxophonist; Roy Lawrence, trombonist; John Minor, trumpeter; Walter Phillips, sousaphonist; Lawrence Leis, banjoist.

WHB, Kansas City, Mo. (365.6m-820ke), 7-7:30 p. m., Morrill Moore, organist; 8-9, 9-10, artists' concert, Henry Strawbridge.

WHO, Des Moines, Iowa (526m-570ke), 7:30-8 p. m., Raleigh quintet; 8-9, Jack Little; 11-12, Bankers Life "Corn Sugar" orchestra.

WHT, Chicago, Ill. (399.8m-750ke), 11 a. m., studio features; 12 noon, Al Carney's organ recital; 6 p. m., dinner organ recital, Al Carney; 6:40, Grayling's string trio; 6:50, Diamond Quartet Loftis; 9:15, studio features; Cinderella cafe orchestra; 9:35, Kitchen Klezner entertainers; 9:50, Howard Sershan, tenor; Al Carney, organist; Jack Marshall, pianist; 10:10, U. S. L. dance music.

WIBO, Chicago, Ill. (220m-1330ke), 2-4 p. m., program for shut-ins concert, American ballads, Walter Preston; WIBO string trio; 3, Bernice Taylor, soprano; Charlotte Edwards, contralto; Eugene Wallenius, tenor; Ruth Goll, pianist; 12, midnight jamboree; Dan Russo, violinist; Ted Florito, pianist; Wayne Meyers, reader; Marie Tully, soprano; Harry Davis.

WJAZ, Chicago, Ill. (322.4m-930ke), 9-1 a. m., diversified and dance program, Chez Pierre.

WJJD, Mooseheart, Ill. (370.2m-810ke), 12-1 p. m., Palmer House symphonic players; Palmer House trio; 2-3, Howard L. Peterson, organist; 4-5, music, Mooseheart children; 5:30-7, Jack Nelson; Palmer House symphonic players; Palmer House Victorians; Howard L. Peterson, organist; 8-9, children; 10-11, Carrol studio; Rushmore ensemble singers; Palmer House Victorians; 12:30 a. m., Knights of the Burning Candle.

WKRC, Cincinnati, Ohio (325.9m-920ke), 10 p. m., dance program, Alvin Boehr's orchestra; 10:30, Eugene Perazzo, organist; 11, Doc Howard's entertainers; orchestra and quartet.

WLIB, Chicago, Ill. (302.8m-990ke), 11-1 a. m., dance W. A. Sheaffer Pen company; 11, program, Public Service company.

WLS, Chicago, Ill. (344.6m-870ke), 6 p. m., Ford and Glenn; 7:15, Ralph Emerson, organist; 7, Ford and Glenn; 7:45, staff artists.

WLW, Cincinnati, Ohio (422.3m-710ke), 7:30 p. m., piano memorials, Mary Louise Wozoszek; 8, old-time repertoire, Crosley Burnt Corkers; "The Musicone male quartet"; 9, Formica orchestra.

WMAQ, Chicago, Ill. (447.5m-670ke), 4:15 p. m., pupils, Rose Hanapel; 4:30, Chicago high school teachers' council; 6, Chicago theater organ; 6:30, Hotel LaSalle orchestra; 8:40, musicale; 9:55, chimes.

WMBB, Chicago, Ill. (250m-1200ke), 7-8 p. m., Trianon duo; Genevieve Barry Burnham, operatic soprano; Hubert Melone, operatic tenor; 9-11, Trianon orchestra; Woodlawn theater orchestra; Eddie Matts and Billie Donovan; Oxford Girls; Harmony duo; Joe Warner, character songs.

WOAW, Omaha, Neb. (526m-570ke), 6 p. m., Hugo G. Heyn, xylophonist; Emil B. Hoffman, pianist; 6:50, orchestra; 9, de Luxe; 10:30, Herb Peierman's orchestra; 12, Risito alarm.

WOK, Chicago, Ill. (217.3m-1380ke), 4:30-7 p. m., Capitol theater organ; program; Carl Lorraine's Pershing Palace orchestra; Husk O'Hare's Coconut Grove orchestra; Capitol theater program; program.

WORD, Batavia, Ill. (275m-1090ke), 7 p. m., program; 9, program, W. A. Sheaffer Pen company; 10, musical program.

WQJ, Chicago, Ill. (447.5m-670ke), 7-8 p. m., Jack Chapman and his Rainbo Gardens orchestra; Pontelia trio; Kenneth Sterling, baritone; Leo Miller, violinist; Milton Sherman, pianist; 10-11 a. m., Jack Chapman and his Rainbo Skyline; Jerry Sullivan, Rose Vanderbosch; Hal Lansing and his wife; Everett George Opie, character reader; Merrill Carder, baritone; Ila Shannabrook, soprano; Will Rossiter; Romo Vincent, boy baritone; Johnny Poats and Harold Olson, baritones; artists; 1-2, Ginger hour.

WSAI, Cincinnati, Ohio (325.9m-920ke), 5:30 p. m., twilight musical; 7, Mabley and Carew orchestra; 8, WEAF program; 9:30, musical program, featuring Hawaiian guitars; 12, Freda Sanker's orchestra.

WSB, Atlanta, Ga. (428.3m-700ke), 8 p. m., Kimo Kahohis Moonlight Five; 10:45, Loew's Grand theater artists.

WSM, Nashville, Tenn. (282.8m-1060ke), 10 p. m., frolic, Beasley Smith's orchestra.

WSUI, Iowa City, Iowa (483.6m-620ke), 12:30 p. m., Mrs. Geraldine Ristine, pianist.

Mountain Time Stations

KFAU, Boise, Idaho (280.2m-1070ke), 8:10 p. m., Mrs. Mabel Grubb, Host Cooper.

KFXF, Colorado Springs, Colo. (250m-1200ke), 8:30-10:30 p. m., musical.

KOA, Denver, Colo. (322.4m-930ke), 12:15 p. m., Marjorie Nash, organist; 6:30, Brown Palace string orchestra.

KSL, Salt Lake City, Utah (299.8m-1000ke), 8 p. m., Columbian Optical company; 9, Gibson Boys orchestra.

Pacific Time Stations

KFI, Los Angeles, Calif. (467m-642ke), 5:30-6 p. m., Charles Beauchamp, tenor; 6, nightly doings; 6:15, Seeing California; 6:30, vest pocket program; 6:45, Radiolator period; 7-8, varied program of classics; 8-9, screen artists' instrumental quartet; 9-10, Al Wesson's dance orchestra; 10-11, Packard Ballad hour with usual favorites featuring popular songs.

KFOA, Seattle, Wash. (454.3m-660ke), 12:30-1:30 p. m., Kiwanis club luncheon program; 6-6:30, Atwater Kent boys; 8:30-10, Rhodes department store; 10-11 Jackie Souder's Club Lido serenaders.

KFON, Long Beach, Calif. (336.9m-1290ke), 6-6:30 p. m., Brayton's theater organ; 7-8, Investors' hour; 8-9, Press-Telegram studio; 9-11, Long Beach Aero club program.

KFWB, Hollywood, Calif. (252m-1190ke), 6-7 p. m., dinner music, Fitzgerald Music company; 8-9, Jack Smith's dance orchestra; 9-10, Mosley Brothers' banjo duets; Bill Blake, tenor; Alice Harvey, soprano; Peggy Mathews, blues singer; 10-11, Warner Brothers' frolic.

KGO, Oakland, Calif. (361.2m-830ke), 4-5:30 p. m., concert orchestra; 6-6:55, Knickerbocker trio; 8-9, Eveready program, Metropolitan male singers; Elsa Behow Trautner, soprano; 9:10-9:30, Italian dialect poems, T. A. Daly; Carl Anderson, tenor; 9:30, bridge; 10-12, Girvin-Deuel's California Collegians.

KHJ, Los Angeles, Calif. (405.2m-740ke), 6-7:30 p. m., children's hour with weekly visit of Queen Titania and her Sandman; Uncle John, Chas. Leslie Hill, readings; Lenore Killian, contralto; 8-10, program, Builders' Finance association.

KMTR, Hollywood, Calif. (238m-1260ke), 5-6 p. m., Citizenship hour with Mammy Simmons, Boy Scouts and Campfire Girls; 6-7, Starr Piano company, studio; 8-10, KMTR concert orchestra, Loren Powell, director.

KNX, Hollywood, Calif. (336.9m-890ke), 5:30 p. m., Leighton's cafeteria orchestra; 6:30-7, Atwater Kent concert orchestra; 7-7:45, program, Roy L. Donley Company, Inc.; 7:45, health talk, Dr. Robert T. Williams; 8-9, program, Globe Ice Cream and Weber Bread; 9-10, program, Western Auto Supply company, with Jack Cronshaw's orchestra; 10-12 midnight, movie night at the Ambassador with the Coconut Grove dance orchestra.

KPO, San Francisco, Calif. (428.3m-700ke), 1-2 p. m., and her Sandman; Uncle John, Chas. Leslie Hill, readings; Lenore Killian, contralto; 8-10, program, Builders' Finance association.

WGPC, WGST, WHAR, WHAZ, WIP, WJAD, WJAZ, WLWL, WMC, WOAI, WOAW, WOI, WPG, WRC, WREO.

Eastern Time Stations

CFCA, Toronto, Can. (356.9m-840ke), 8:30 p. m., musical program; Hawaiian quartet; soprano solos; Edythe Law, pianist, accompanied by Winnifred French; string quartet; selections, R. T. S. dance orchestra; 11, Gilbert Watson and his orchestra.

KDKA, Pittsburgh, Pa. (309.1m-870ke), 12:30 p. m., Trinity church Lenten services; 6:30, dinner concert; 9, concert, mixed quartet; Marjorie Lieberman, pianist.

WAHG, Richmond Hill, N. Y. (315.6m-950ke), 12 noon, musical; 7:30 p. m., Margie Make-Believe; 7:45,

pianist; 8:15, Novelty quartet; 6:30, Bellevue Stratford concert orchestra; 7, Bellevue Stratford dance orchestra.

WBS, New York, N. Y. (315.6m-950ke), 1:30 p. m., Albertina Bass, soprano; 3, program, children, Roslyn schools; 6:30, Jersey Collegians.

WGCP, New York, N. Y. (252m-1190ke), 3 p. m., Eva Rothenberg, pianist; 3:30, Bobby Gray, songs; 4, program; 4:15, Alfred Hall, baritone; 4:30, Jeanne A'Dair, composer; 4:45, Tracey and Mohr, entertainers; 7, program; 7:15, Charles Coleman, pianist; 7:30, program; 8, program.

WGHP, Detroit, Mich. (270m-1110ke), 6-7 p. m., Hotel Tuller's dinner concert; 8-10, Little Symphony orchestra; Marius Fossenkemper, clarinetist; Julius Sturm, cellist; quartet; Mme. Gizl Szanto, pianist.

WGY, Schenectady, N. Y. (379.5m-790ke), 7 p. m., Eastman theater orchestra; 8, "The Moral Obligation To Be Intelligent," Dr. John Erskine.

WHN, New York, N. Y. (361.2m-830ke), 6 p. m., people's hour; 7, Parody club orchestra; 8, Vogue entertainers; 9, Loew's New York orchestra; 10, Rose-land dance orchestra; 10:30, Anatol Friedland; 11, Silver Slipper orchestra; 11:30, Melody club orchestra; 12, Cotton club orchestra.

WIP, Philadelphia, Pa. (508.2m-590ke), 1 p. m., Gimbels tea room orchestra; 4, musical program, direct from Greater Camden Radio show; 6:05, Benjamin Franklin hotel concert orchestra; 7, Uncle Wip's bedtime stories; songs, Theodore Spector.

WJR, Pontiac, Mich. (516.9m-580ke), 7 p. m., Jean Goldkette's symphony orchestra; soloists; 9, Winter Haven Radio hour; 11:30, "The Merry Old Chief."

WJZ, New York, N. Y. (454.3m-660ke), 1 p. m., Hotel Madison concert and dance orchestra; 4:30, Waldorf-Astoria tea music; 7, Hotel Commodore concert orchestra; 8:30, Lewisohn free chamber music concert.

WLIT, Philadelphia, Pa. (394.5m-760ke), 12:02 p. m., daily almanac; Stanley theater organ recital; Arcadia cafe concert orchestra; 2, Arcadia cafe concert orchestra; 4:30, Liberty concert orchestra; 7:30, Dream Daddy's bedtime stories; 8:15, features from Camden Radio show; 10, Arcadia cafe dance orchestra.

WLWL, New York, N. Y. (288.3m-1040ke), 9:15 p. m., entertainers; 9:45, McEvay concert; 10:15, talk; 10:30, songs.

WMAK, Buffalo, N. Y. (266m-1130ke), 7:30-8:30 p. m., musical program; 8:30-9:30, musical.

WMCA, New York, N. Y. (340.7m-880ke), 6 p. m., Olcott Vail and his Hotel McAlpin string ensemble; 6:30, Ernie Golden and his Hotel McAlpin orchestra; 7:45, Woodmansten Inn orchestra; 11, Hofbrau Haus entertainers; 11:30, Jack Denny's orchestra.

WNYC, New York, N. Y. (526m-570ke), 6:20 p. m., songs; 7:35, dance program; 8:15, Radio Love Birds; 8:30, Viennese Elite trio; 9, song recitals.

WO, Philadelphia, Pa. (508.2m-590ke), 11 a. m., organ recital; 12:02 p. m., crystal tea room orchestra; 4:45, organ recital; 7:30, Sylvania hotel dance orchestra; 8:30, Davis Saxophone octet; 9:25, address, Rev. Forest Daggar; 10, Fox theater studio program; 10:30, Ritz Carlton dance orchestra.

WOR, Newark, N. J. (405.2m-740ke), 8:30 p. m., Mildred Delman, soprano; 9, Mildred Delman; 9:30, Ballin and Race, piano duo; 10, Ballin and Race.

WRC, Washington, D. C. (468.5m-640ke), 12 noon, Gertrude Smallwood, organist; 12:30 p. m., Lenten services; 1, Lee house trio; 4:15, Le Paradis band; 5, musical program.

WTAG, Worcester, Mass. (268m-1120ke), 10:30 a. m., musical program; 12:05-2 p. m., noon-day luncheon music; 3-5, Tea Room, musical; 8-8:30, WEAF program; 8:30-9, WEAF program; 9-10, program; 10-11, WEAF program.

WTAM, Cleveland, Ohio (389.5m-770ke), 12:15-1:30 p. m., Austin Wylie's Vocalion Recording orchestra; 6-7, Carl Rupp and his Hotel Hollenden orchestra; 8-11, public auditorium program; 11-1, Guy Lombardo and his Royal Canadians.

WTIC, Hartford, Conn. (475.9m-630ke), 6:30 p. m., Hotel Bond trio; 8, Westminster school glee club; 8:30, Juliet Grave Wolfe, pianist; 9:15, Laura C. Gaudet; 9:30, organ recital; 10, Roxey and his Gang.

WWJ, Detroit, Mich. (352.7m-850ke), 12:05 p. m., Jules Klein's Hotel Statler orchestra; 3, Detroit News orchestra; 6, dinner concert; 8, News orchestra and soloists; 9, dance program; 10, WEAF program.

Central Time Stations

CNRW, Winnipeg, Can. (384.4m-780ke), 7:50 p. m., Fort Garry hotel orchestra; 9, Hart House string quartet; 10:30, Fort Garry hotel orchestra.

KFAB, Lincoln, Neb. (340.7m-880ke), 8:30-10:30 p. m., Olive Fletcher, Ruby Teater, pianists; Geraldine Schmidt, blues singer; Harmony Boys; Belshaw's orchestra; Cowbell Boys.

KFH, Wichita, Kan. (268m-1120ke), 10-11 p. m., Menotholatum company concert orchestra; 12:15-1:15 a. m., Harry Hunt's Imperial orchestra.

KFDN, Beaumont, Tex. (315.6m-950ke), 12:30-1 p. m., Refinery band concert; 8-10, Refinery band concert.

KFRU, Columbia, Mo. (499.7m-600ke), 4:30 p. m., Bella Vista Quadrangle orchestra; 9-11, musical program, Kemper Military academy.

KMA, Shenandoah, Iowa (252m-1190ke), 11:30-12:30 p. m., noonday rural program; banjo solos, Charles Skinner; 9-11, songs and clog dancing, Bob and Babe Riddle; Willy Cunningham, farmer Scotchman; Vagabond orchestra.

KPRC, Houston, Tex. (296.9m-1010ke), 12 noon, Lions' club luncheon program; 7:30 p. m., Jack Willich's orchestra; Virginia Willich, piano accordionist; 8:30, concert; 11, Paul B. Holcomb, baritone; Mrs. J. R. Cox, pianist.

KSD, St. Louis, Mo. (545.1m-550ke), 7 p. m., Mystery Merry Makers; 7:30, fur hour, Hotel Statler orchestra; 8, WEAF program.

KSO, Clarinda, Iowa (241.8m-1240ke), 7-7:30 p. m., music; 7:30-9:30, vocal and instrumental.

KTHS, Hot Springs National Park, Ark. (374.8m-800ke), 9-9:30 p. m., First Presbyterian church; 9:30-10, New Arlington grand ensemble; 10-10:45, Southern Majestic hotel orchestra.

KYW, Chicago, Ill. (535.4m-560ke), 12:05-1 p. m., noonday concert; 1-2, luncheon concert, Congress hotel; 6-7, dinner music; 7:30, music; 8-10, musical program, Congress hotel; 10-12:30 a. m., midnight revue; Paul Ash and his orchestra; 1, Insomnia club.

WAMD, Minneapolis, Minn. (244m-1230ke), 12:01 p. m., classical concert; 11, George Osburn and his orchestra.

WBAP, Fort Worth, Tex. (475.9m-630ke), 12:05-12:30 p. m., Fred Cahoon's orchestra; 6-8:30, Texas hotel orchestra.

WBBM, Chicago, Ill. (226m-1330ke), 4-6 p. m., Harry and Sandy; Edna Wheeler Ballard, harpist; Harold Morava, tenor; Johnny Black; Court Banks; Ralph Bothof; 8-10, Barber Shop Three; Jack Crawford's Aleutic orchestra; Verdi mixed quartet; Sy Berg and Bob Witt; Philip Nilles, tenor; Rudy Winter; Floyd Falch; 12-2 a. m., Jack Crawford's orchestra; Charlie Garland; Two Jays; Harold Anderson, accordionist; Spencer, Lavergne and Shayne, xylophone; Floyd Falch; Ariston trio.

WCAR, San Antonio, Tex. (263m-1140ke), 8-10 p. m., studio program.

WCCO, Minneapolis-St. Paul, Minn. (416.4m-720ke), 2:30 p. m., afternoon concert; 6, midweek church service; 7, WEAF program; 8, WEAF program; 9, musical program, Nash-Finch concert orchestra; 10:05, dance program, Marigold Garden orchestra; 11:30, Eddie Dunstetter, organist.

WDAF, Kansas City, Mo. (365.6m-820ke), 6-7 p. m., Trianon ensemble; 8-10, music concert program; 11:45-1 a. m., program.

WEAO, Columbus, Ohio (293.9m-1020ke), 8:15 p. m., music; 8:45, music; Dorothy Stevens Humphreys, soprano; Louise Ackerman, pianist.

WEBH, Chicago, Ill. (370.2m-810ke), 7 p. m., Florence Behrend; Oriole orchestra; Oriole string trio; Frank Greif, tenor; 9, Oriole orchestra; 9:45, Frank Bordner; Trombone duo; Florence Behrend; 11, Oriole orchestra; 12:30, Irene Beasley; Florence Behrend.

CLASSICAL CONCERTS INDEX

Saturday, March 6			
Eastern 6 p. m.	Central 5 p. m.	Mountain 4 p. m.	Pacific 3 p. m.
WCX, WEAF, WMCA, WREO.			
KGO, KYW, WEAR, WENR, WMAQ, WNYC, WOAW, WOK, WRC.			
KDKA, KFNF, KOIL, KSD, KYW, WBBR, WGN, WBBB, WNYC, WOAW, WQJ.			
KFOA, KPRC, KHJ, KYW, WHAS, WIP, WLW, WORD, WSAI, WSOE.			
KNX, KYW, WEAF, WMAQ, WMC, WOAW, WOC, WORD.			
KGO.			
WOAW.			

Sunday, March 7			
Eastern 6 p. m.	Central 5 p. m.	Mountain 4 p. m.	Pacific 3 p. m.
WCAU.			
7:20	6:20	5:20	4:20
WCAB, WCAU, WEAF, WEAR, WEEL, WJAR, WTAG, WWJ.			
KYW, WAMD, WBZ, WEAR, WGBS, WGPC, WKAQ, WLS, WORD.			
KFDM, KPRC, KSD, WBZ, WCAU, WCBD, WCO, WEAR, WGY, WHAR, WHT, WNYC, WQJ.			
9:15	8:15	7:15	6:15
WEEL, WJAR, WTAG.			
KHJ, KNX, KTHS, KYW, WCCO, WFAA, WNYC, WOC, WQJ, WSOE.			
KFVE, KHJ, KNX, KPO, KTHS, KYW, WHN, WKRC, WOC.			
KHJ, KNX, WOC.			
12 m.	12 m.	11	10
1 a. m.	12 m.	11	10
KNX.			

Monday, March 8			
Eastern 6 p. m.	Central 5 p. m.	Mountain 4 p. m.	Pacific 3 p. m.
KGO, WCX, WEAF, WMCA, WREO, WWJ.			
7	6	5	4
KMA, WCO, WEAF, WEAR, WHAD, WJR, WOAW, WOK.			
8	7	6	5
KFNF, KSD, WBBR, WBZ, WCAU, WCX, WHAR, WHT, WJAR, WLW, WMBB, WTAG, WTIC.			
9	8	7	6
KFOA, KGO, KHJ, KPRC, WBBB, WCO, WBZ, WCAE, WEEL, WHAD, WHO, WJAR, WLW, WORD, WOS.			
10	9	8	7
KMA, KPO, KPRC, KSD, KTHS, WAMD, WCO, WEAF, WHAD, WJAR, WOAW, WSUI, WTAG.			
11	10	9	8
KGW, KHJ, KMA, KSD, KTHS, KWSC, WHN, WLW.			
12	11	10	9
1 a. m.	12 m.	11	10
KHJ.			

Tuesday, March 9			
Eastern 6 p. m.	Central 5 p. m.	Mountain 4 p. m.	Pacific 3 p. m.
WBZ, WCX, WEAF, WMCA, WREO, WWJ.			
7	6	5	4
KGO, KMA, WEAR, WEEL, WGBS, WHAD, WJR, WMAQ, WOAW, WOK, WOB, WTIC, WWJ.			
8	7	6	5
KFNF, KSD, KYW, WEAF, WCAE, WCAU, WCX, WEAR, WEEL, WGR, WHAR, WHT, WLS, WMBB, WQJ, WRC, WTIC.			

Wednesday, March 10			
Eastern 3:15 p. m.	Central 2:15 p. m.	Mountain 1:15 p. m.	Pacific 12:15 p. m.
WHO (526m-570ke) Jack Little.			
8	6	5	4
WBZ (333.1m-900ke) Springfield string ensemble.			
8:15	7:15	6:15	5:15
WTIC (475.9m-630ke) East Hartford community night.			
8:30	7:30	6:30	5:30
WHAS (399.8m-750ke) Kentucky Night Owls.			
9	8	7	6
WLW (422.3m-710ke) Syrian Temple Shrine band.			
9:15	8:15	7:15	6:15
WHO (526m-570ke) Jack Little, "The Larks."			
9:30	8:30	7:30	6:30
WSMB (319m-940ke) Optimist club.			
10	9	8	7
KPRC (296.9m-1010ke) Gibson Plectral club.			
10:15	9:15	8:15	7:15
KOA (322.4m-930ke) Service saxophone band.			
10:30	9:30	8:30	7:30
CNRE (516.9m-580ke) Hart House string quartet.			
WSMB (319m-940ke) Optimist club.			

Headliners Today

Rudy Seliger's Fairmont hotel orchestra; 2:30-3:30, matinee program; 3:30-4:30, Cyrus Trobbe's Palace hotel orchestra; 6:40-7, Waldemar Lind and the States Restaurant orchestra; 7-7:30, Rudy Seliger's Fairmont hotel orchestra; 8-9, program, sextet; 9-10, Gypsy and Marta, harmony team; 10-11, Palace hotel orchestra.

KPSN, Pasadena, Calif. (315.6m-950ke), 8-9 p. m., Star-News concert; Adolf Tandler instrumental group.

KTAB, Oakland, Calif. (240m-1250ke), 12-1 p. m., luncheon concert; 8-10, program.

songs; 8, Michael Lambert, cellist; 8:30, Judith

NEW ORLEANS OPTIMISTS AT WSMB

Wednesday, March 10

WFAA, Dallas, Tex. (475.9m-630kc), 2:30-3 p. m., Jimmy's Joys.

WGN, Chicago, Ill. (302.8m-990kc), 11-11:30 a. m., organ concert; Chicago theater, Dean Fessler; 12:30-1:30 p. m., noon-hour entertainment for children; 12:40-2:30, luncheon concert music; 2:30-3, Lyon and Healy artists' recital; 3:25, Port o' Missing Men; 3:30-4:15, tea time music; 4:30-5, organ; 6:30-6:45, dinner concert music; 6:45-7, old-time favorite songs; 8-9, Evanston Men's chorus; 10-10:10, Radio comic strip; 10:10-10:30, play show; 10:30-10:45, old-time songs; 10:45-11, songs, Correll and Gosden, Freda Leonard and Jewell Barnett; Hawaiian guitar music, Langdon Brothers.

WHAS, Louisville, Ky. (399.8m-750kc), 1-2 p. m., concert, Barney Rapp's orchestra; 3-3:30, Mrs. Myrtle Pulks Zahn, Jr., organist; 4-5, concert, Music Box Extension studio; 7:30-9, concert, Jake Seligman and his Kentucky Night Owls.

WHB, Kansas City, Mo. (365.6m-820kc), 7-8 p. m., Milo Finley's trio; Mrs. Emily Foley, contralto; Aileen Pemberton, soprano; Otil Swartz, violinist.

WHO, Des Moines, Iowa (526m-570kc), 6-7 p. m., Bankers Life Little Symphony orchestra; 7:15-8:15, Irene Doran's Little Symphony orchestra; 8:15-9, Jack Little, baritone; 9-12, dance program.

WHT, Chicago, Ill. (399.8m-750kc), 12 noon, Al Carney's organ recital; 7:30 p. m., Genevieve B. Burnham, soprano; Peter Porstner; Howard Will, tenor; Grayling's string trio; Helen Raub, pianist; 9-15, musical features, Cinderella orchestra; 10:05, Ray-O-Vac concert; 11:15, Cinderella cafe orchestra.

WIBO, Chicago, Ill. (226m-1330kc), 2-4 p. m., program for shut-ins; 6-8, dinner concert; old-fashioned songs, Walter Preston; WIBO string trio; Dorothy Rae, soprano; Florence Osterman, contralto; Joe North, baritone; Earl Bigelow, pianist; 10-12, popular program; open request night; Prof. Black, cryptologist; Marie Tully, soprano; Hicky and Johnson; William Molnair, tenor; Erwin Cornelius, uke soloist; Lenore Friedman, soprano; Pearl Holzman, pianist; Irene Beasley, The Jordans.

WIAZ, Chicago, Ill. (322.4m-930kc), 9-1 a. m., continuous dance program.

WJJD, Moseheart, Ill. (370.2m-810kc), 2-3 p. m., Howard L. Peterson, organist; 4-5, music, children; 5:30-7, Jack Nelson; Palmer House symphonic players; Howard L. Peterson, organist; Palmer House Victorians; 8-9, music, children; 10-11, R. V. Thomas; John Norton; Palmer House Victorians; 12:30 a. m., "Settin' Up" hour.

WKAF, Milwaukee, Wis. (261m-1150kc), 10-11 p. m., Campus Skylarks; Harmony Girls; Isabel Renee, Anne Bauman.

WKRC, Cincinnati, Ohio (325.9m-920kc), 6 p. m., dinner program, Alvin Roeh's orchestra; 8:15, tenor solos, Oliver Plunkett; 9, concert orchestra; 9:40, orchestra music.

WLIB, Chicago, Ill. (302.8m-990kc), 7:30-8 p. m., "Auld Sandy"; 7:40-8, music; 11-1 a. m., dance music, songs, Correll and Gosden; Hawaiian guitar music, Langdon Brothers.

WLS, Chicago, Ill. (344.6m-870kc), 6:40 p. m., Ralph Emerson, organist; 7, Ford and Glenn; 7:15, "Dances of the Eighteenth Century," WLS trio; 7:45, H. D. Saddler production; 8, "Midnight," third prize-winning play; 8:30, George Geforth band; 9, Piedmont quartet; 9:30, Little Symphony of Chicago; 10:30, "French Songs and Salads," Ford and Glenn; 11-2 a. m., WLS circus.

WLW, Cincinnati, Ohio (422.3m-710kc), 7 p. m., Hotel Gibson orchestra; 8, Syrian Temple Shrine band; 10:30, Crosby male quartet; 11, organ, Johanna Grosse; 11:30, dance program, Castle Farm.

WMAQ, Chicago, Ill. (447.5m-670kc), 4:45 p. m., pupils, Cosmopolitan School of Music; 6, Chicago theater organ; 6:30, Hotel La Salle orchestra; 8:25, Agnes Pillsbury, pianist; Nesta Smith, violinist; 9, WMAQ players; 9:55, chimes.

WMAZ, Macon, Ga. (261m-1150kc), 10-11 p. m., Lanier high school mandolin club; 11-12, Marvin Pharr, Pi Kappa Phi fraternity.

WMBB, Chicago, Ill. (250m-1200kc), 7-8 p. m., Trio-ton duo; Adele Hart, soprano; Edvin House, bass-baritone; Preston Graves, pianist; 9-11, Trio-ton orchestra; Woodlawn theater orchestra; Cecil and Esther Ward, Hawaiian guitar artists; Billie Allen Hoff, blues baby; Bob Bennett, pianist.

WOK, Chicago, Ill. (217.3m-1380kc), 4:30-7 p. m., Capitol theater organ; program; 10-1:30 a. m., Tearney's Town club orchestra; Carl Lorraine's Pershing Palace orchestra; Husk O'Hare's Coconut Grove orchestra; Capitol theater program; program.

WORD, Batavia, Ill. (275m-1090kc), 7-7:45 p. m., program; 9, Webster hotel trio; 11-12 midnight, program.

WQJ, Chicago, Ill. (447.5m-670kc), 3-4 p. m., Lavina Price, pianist; 7-8, dinner concert, Jack Chapman and his Rainbow Gardens orchestra; Carl Pfau, tenor; Helen Holman, soprano; Prof. Ascan Kittner, pianist, baritone; 10-1 a. m., Jack Chapman and his Rainbo Skylarks; Melodians; Clarence Theiders; Joe Warner, character songs; Oxford Girls, harmony singers; artists; 1-2, Ginger hour, Jack Chapman and Little Skylarks.

WSAI, Cincinnati, Ohio (325.9m-920kc), 7 p. m., WEAJ program; 7:30, Davis saxophone octet; 10:15, musical program, Congress Playing Card string quartet.

WSB, Atlanta, Ga. (428.3m-700kc), 10:45 p. m., Billmore hotel orchestra.

WSM, Nashville, Tenn. (282.8m-1060kc), 6:30 p. m., concert, Francis Craig's orchestra; 8, program, Kiwanis club; 10, program, Negro spirituals.

WSMB, New Orleans, La. (319m-940kc), 9:30 p. m., Optimist club.

WSUI, Iowa City, Iowa (483.6m-620kc), 9 a. m., Mrs. F. Whinery, harpist.

Mountain Time Stations

CNRE, Edmonton, Can. (516.9m-580kc), 8:30 p. m., Hart House string quartet.

KOA, Denver, Colo. (322.4m-930kc), 12:15 p. m., Marjorie Nash, organist; 6:30, Brown Palace string orchestra; 8, Scheuerman's Colorado orchestra; 8:15, Mile High trio; KOA orchestra; June King, contralto; saxophone band; Elwin Smith, tenor; Stewart Housman, novelties; 10-12, Broadmore Rhythm Rustlers.

KSL, Salt Lake City, Utah (299.8m-1090kc), 8 p. m., Salt Lake Chamber of Commerce; 9, Harmony Night Hawks.

Pacific Time Stations

KFI, Los Angeles, Calif. (467m-642kc), 5:30-6 p. m., Jim, Jack and Jean; 6, nightly doings; 6:15, Seeling California; 6:30, vest pocket program; 6:45, Radiatorial period; 7-7:30, program, A. H. Grebe and company, Synchronphase string ensemble; 7:30-8, Nick Harris' detective story; 8-9, program, California Petroleum corporation, Ventura orchestra and others; 9-10, program, Chevrolet Motor company of California; 10-11, Patrick-Marsh dance orchestra, Betty Patrick, soloist.

KFOA, Seattle, Wash. (454.3m-660kc), 12:30-1:30 p. m., Rotary club luncheon program; 7-8:15, Hopper Kelly company program.

KFON, Long Beach, Calif. (232.4m-1290kc), 6-6:30 p. m., Brayton's theater organ; 6:30-7, amusement information; 7-8, investors' hour; 8-9, Press-Telegram studio; 9-10, program, Sam Abrams, the tailor; 10-11, Oriole dance orchestra.

KFWB, Hollywood, Calif. (252m-1190kc), 6-7 p. m., dinner music, Fitzgerald Music company; 8-9, California serenaders; Sol Hoopii's Hawaiians, Esther White, popular songs; 9-10, Bill Hatch's Oakmont Country club orchestra; Mutual Motors mirth contest; 10-11, Warner Brothers frolic.

KGO, Oakland, Calif. (361.2m-830kc), 3-4 p. m., Ralph

L. Cavanagh, baritone; Anna D. Bacon, mezzo-soprano; John T. Evans, whistler; 4-5:30, concert orchestra.

KHJ, Los Angeles, Calif. (405.2m-740kc), 8-10 p. m., program, United Church Brotherhood.

KLX, Oakland, Calif. (508.2m-590kc), 8-9:45 p. m., studio program; 9:45-10:30, Athens Athletic club.

KMTR, Hollywood, Calif. (238m-1260kc), 8-10 p. m., KMTR concert orchestra, Loren Powell, director; 10-11, Starr Piano company studio.

KNX, Hollywood, Calif. (336.9m-890kc), 5-5:30 p. m., Sunny Jim's talk; 5:30, Leighton's cafeteria orchestra; 6, Town Tattler; 6:15, travel talk, W. F. Alder; 6:30-7, Atwater Kent concert orchestra; 7-8, feature program; 8-9, program, Reeve-Gartzmann, Inc.; 9-10, program, Joe Daley's 165 Grocery Stores; 10-11, dance

WOOD, WEAQ, WEBJ, WEBW, WHAD, WHAZ, WJJD, WOR, WOS, WSM, WSUI, WTAM.

Eastern Time Stations

KDKA, Pittsburgh, Pa. (309.1m-970kc), 12:30 p. m., Trinity church Lenten services; 6:30, dinner concert; 9, concert, Vincent Kroen, tenor; 11, Pittsburgh Post midnight revue.

WAHG, Richmond Hill, N. Y. (315.6m-950kc), 12 noon, Grebe matinee trio.

WBAL, Baltimore, Md. (246m-1220kc), 6:30-7:30 p. m., WBAL dinner orchestra; 7:30-8, recital, Frederick D. Weaver, organist; 8-10, Josephine McLaughlin, soprano; Hazel Fox, contralto; Katherine Simmerman, pianist; Evelyn Upp, violinist; Frederick H. Gottlieb,

NEWS BULLETINS

Daily Except Sunday

Eastern	Central	Mountain	Pacific
9:45 a. m.	8:45 a. m.	7:45 a. m.	6:45 a. m.
KDKA (309.1m-970kc)			
10	8	7	
WGN (302.8m-990kc)			
10:35	9:35	8:35	7:35
WCCO (416.4m-720kc)			
11	10	9	8
WOAI (394.5m-760kc)			
12 n.	11	10	9
CFCA (356.9m-840kc); KDKA (309.1m-970kc); KPRC (296.9m-1010kc)			
12:30 p. m.	11:30	10:30	9:30
WCAE (461.3m-650kc)			
1	12 n.	11	10
KGW (491.5m-610kc); KNX (336.9m-890kc)			
1:15	12:15 p. m.	11:15	10:15
WOAI (394.5m-760kc)			
3:45	2:45	1:45 p. m.	12:45 p. m.
WIAS (399.8m-750kc)			
4	3	2	1
WCX (516.9m-580kc)			
4:30	3:30	2:30	1:30
WCAE (461.3m-650kc); WFAA (475.9m-630kc)			
6	5	4	3
CFCA (356.9m-840kc)			
6:30	5:30	4:30	3:30
WPG (299.8m-1000kc)			
7	6	5	4
KOIL (278m-1080kc); WOC (483.6m-620kc)			
7:15	6:15	5:15	4:15
WMAK (265.6m-1130kc); WOAI (394.5m-760kc)			
8	7	6	5
WMBF (384.4m-780kc); WMCA (340.7m-880kc)			
9	8	7	6
WVAI (325.9m-920kc)			
9:30	8:30	7:30	6:30
KPO (428.3m-700kc)			
10	9	8	7
KLX (508.2m-590kc)			
10:45	9:45	8:45	7:45
WEBH (370.2m-810kc)			

Sunday

Eastern	Central	Mountain	Pacific
8 p. m.	7 p. m.	6 p. m.	5 p. m.
WMAK (265.6m-1130kc)			
8:15	7:15	6:15	5:15
WEBH (370.2m-810kc)			
9	8	7	6
WPG (299.8m-1000kc)			
12	11	10	9
KFWB (252m-1190kc)			

KYW, "The World Crier," broadcasts news every half hour from 8 a. m. to 2 a. m.



KNX is the gathering place for the lovely Wampas stars of 1926. Among the favorite radio artists is Marceline Day, above. Her attractive personality endears her even to her invisible audience.

music; 11-12, Coconut Grove dance orchestra from the Ambassador.

KPO, San Francisco, Calif. (428.3m-700kc), 1-2 p. m., Rudy Seiger's Fairmont hotel orchestra; 2:30-3:30, matinee program; 6:40-7, Waldemar Lind and the States Restaurant orchestra; 7-7:30, Rudy Seiger's Fairmont hotel orchestra; 8-9, WEAJ program; 9-10, program, dance music; 10-11, Waldemar Lind.

KTAB, Oakland, Calif. (240m-1250kc), 12-1 p. m., luncheon concert.

KWSC, Pullman, Wash. (348.6m-860kc), 7:30-9 p. m., Margery McIntosh, pianist; Catherine Robinson, violinist; David Lombard, saxophonist.

Thursday, March 11

Headliners Today

Eastern	Central	Mountain	Pacific
3:15 p. m.	2:15 p. m.	1:15 p. m.	12:15 p. m.
WHO (526m-570kc) Jack Little			
8:30	7:30	6:30	5:30
WTAM (389.4m-770kc) American folk songs			
9	8	7	6
WCAR (263m-1140kc) Elephants.			
9:50	8:50	7:50	6:50
WMAQ (447.5m-630kc) Chicago Kent vs. Iowa State debate.			
10	9	8	7
KPO (428.3m-700kc) "El Toroso," operetta.			
WHB (365.6m-820kc) Missouri Pacific band.			
WJAZ (322.4m-930kc) Classical program.			
10:30	9:30	8:30	7:30
WBAP (475.9m-630kc) Band concert.			
11	10	9	8
KGO (361.2m-830kc) "Kathleen Mavourneen," Irish drama.			

Thursday, silent night for: CHIC, CKNC, CNRA, CNRE, CNRO, CNRR, CNRT, CNRV, CNRW, KFAB, KFAU, KFDM, KFEG, KFMY, KFOA, KFIO, KFV, KFWA, KGW, KLX, KMOX, KOA, KOAC, KOB, KWSC, PWX, WABQ, WAFD, WAHG, WCAP, WCEE,

flutist; 9-10, WBAL string trio; John Wilbourn, tenor.

WBZ, Springfield, Mass. (333.1m-900kc), 6:30 p. m., Hotel Kimball orchestra; 7, Hotel Lenox ensemble; 7:30, Mrs. Irene Simpson Remmel, pianist; 8, musical program; 9:30, concert.

WCAE, Pittsburgh, Pa. (461.3m-650kc), 6:30 p. m., dinner concert, William Penn hotel; 8, WEAJ program; 8:30, WEAJ program; 9, WEAJ program; 10, WEAJ program.

WCAU, Philadelphia, Pa. (277.6m-1080kc), 6:30 p. m., Cathay Tea Garden dance orchestra; 7:30, Snellenburg symphony orchestra; 8, Mitchell Gondolier; 8:15, Elizabeth Lapetina, coloratura soprano; Michael Fonticoli, operatic tenor; Letitia Radcliff, pianist; 8:45, Kandy Kids; 9, Barry O'Moore, Irish tenor; 9:30, Musical Chets; 9:45, Professor Doolittle's Radio Mail; 10, Sesqui-centennial hour; 11, Parodians dance orchestra; 12, Club Cadix revue.

WCX, Detroit, Mich. (516.9m-580kc), 6-7 p. m., dinner program; Goldkette ensemble; 8-9, studio program.

WDBO, Winter Park, Fla. (239.9m-1250kc), 8-10:30 p. m., entertainment; City of Sanford, program.

WEAF, New York, N. Y. (491.5m-610kc), 4 p. m., Rev. Michael Magidon, tenor; Margaret Mack, soprano; 5-6, Vincent Lopez and orchestra; 6-7, dinner music, Rose Room of Hotel Waldorf-Astoria; 7, mid-week hymn singing; 7:30, the Smith Brothers; 8, the Larkinotes, WEAF, WEEL, WGR, WWJ, WFL, WTAG, WOC, WCCO, KSD, WCAE, WEAR; 8:30, Hire's Harvesters, WEAF, WEEL, WFL, WCAE, WLWB, WSAI, WWJ; 9, Cliequot Club Eskimos, WEAF, WEEL, WJAR, WTAG, WFL, WCAE, WSAI, WEAR, WGR, WWJ, WOC, WCCO, KSD, WGN; 11-12, Vincent Lopez and orchestra from Casa Lopez.

WEAR, Cleveland, Ohio (389.4m-770kc), 7 p. m., Hotel Statler concert orchestra; 8, WEAJ program; 8:30, program; 9, WEAJ program; Workrite Radio artists; 10, Vincent Percy, organist.

WEEI, Boston, Mass. (348.6m-860kc), 1 p. m., assembly luncheon; 3:05, Lou Klayman and his orchestra; 4:50, Waltham senior high school glee club; 5:30, Harry Marshad and his orchestra; 6:05, Harry Marshad and his orchestra; 7, musical; 7:30, J. A. Edkins, bass; Henry Flynn, accompanist; 8, WEAJ program; 8:30, Hire's Voyagers; 9-10, WEAJ program.

WFL, Philadelphia, Pa. (394.5m-760kc), 1 p. m., Tea Room ensemble; 3, Women's club of Ridley Park; 6:30, Bellevue-Stratford concert orchestra; 7, Bel-

levue-Stratford dance orchestra; 8, Larkinotes; 8:30, Hire's Harvesters; 9, Cliequot Club Eskimos; 10, Silvertown Cord orchestra.

WGBS, New York, N. Y. (315.6m-950kc), 1:35 p. m., Teresa Santoro, soprano; 6:30, Perner-Stark orchestra; 9, Crystal Palace orchestra; 9:30, Old-time Minstrels; 10:30, Vanderbilt hotel orchestra.

WGCP, New York, N. Y. (252m-1190kc), 10:30 p. m., Irving Firstenberg, pianist; 10:45, Piotti and Val, songs; 11, program; 11:30, Strickland's orchestra; 12 midnight, frolic.

WGHP, Detroit, Mich. (270m-1110kc), 6-7 p. m., dinner concert, Hotel Tuller; 10-11, Skylark dance band; Harry Hayes, soloist; saxophone quartet; 11-12, frolicers; 12-1 a. m., Gerald Marks and his orchestra.

WGY, Schenectady, N. Y. (379.5m-790kc), 6:30 p. m., Hotel Ten Eyck trio; 7:45, WFBL program; 8:20, Rochester Philharmonic symphony orchestra; Sander Vas, pianist; 10, WGY orchestra; Mrs. Winslow Webb Lillie, soprano; "Chinese Language," Chang Chen; 11:30, Stephen E. Boisclair, organist.

WHAR, Atlantic City, N. J. (275.1m-1090kc), 8 p. m., Seaside hotel trio; 9, concert; 11, Polles Bergere dance orchestra.

WHN, New York, N. Y. (361.2m-830kc), 12:30-1 p. m., Lexington organ recital; 3:15-4, Lexington orchestra; 6:30, people's hour; 7, Iceland orchestra; 7:30, Loew's organ; 8, Will Oakland's Chateau Shanley; 9, Loew's New York Roof orchestra; 9:30, musical program; 10, Al Raymo's entertainers; 10:30, musical program; 11:30, Everglades orchestra; 12, Parody club orchestra.

WIP, Philadelphia, Pa. (508.2m-590kc), 1 p. m., Gimbel Tea Room orchestra; 3, Belov saxophone sextet; 6:05, Pagoda cafe orchestra; 8:15, The Etude hour; 9, Ben Stad and his WIP Little Symphony orchestra; 10:05, real estate talk; 10:15, Nelson Maples and his S.S. Leviathan orchestra.

WJR, Pontiac, Mich. (516.9m-580kc), 7 p. m., Jean Goldkette's symphony orchestra; soloists; 9, Jean Goldkette's orchestra; 10, Jean Goldkette's Victor Recording orchestra.

WJZ, New York, N. Y. (454.3m-660kc), 1 p. m., Hotel Pennsylvania concert orchestra; 7:20, Hotel Vanderbilt concert orchestra; 9, Royal Typewriter salon orchestra; 10:45, Freddie Rich and his Hotel Astor orchestra.

WLT, Philadelphia, Pa. (394.5m-760kc), 12:02 p. m., daily almanac; Stanley theater organ recital; Arcadia cafe concert orchestra; 2, Arcadia cafe concert orchestra; 4:30, Margaret McDonald, contralto; Marie Dougherty, soprano; 7:30, Dream Daddy's bedtime stories.

WLWL, New York, N. Y. (288.3m-1040kc), 9 p. m., talk; 9:15, music; 9:30, question box; 10:15, talk; 10:30, songs.

WMAK, Buffalo, N. Y. (266m-1130kc), 6:15-7:15 p. m., dinner music.

WMCA, New York, N. Y. (340.7m-880kc), 6 p. m., Oleot Vail and his Hotel McAlpin orchestra; 6:30, Woodmansten Inn orchestra; 7, Jack Denny's orchestra; 10:30, Tango Palace orchestra; 11, Ernie Golden and his Hotel McAlpin orchestra.

WNYC, New York, N. Y. (526m-570kc), 7:10 p. m., song recital; 8, Raymond Maber, baritone; 8:15, Margaret Zeidler-Stiefel, soprano; 8:45, piano recital; 9:15, dance program.

WOO, Philadelphia, Pa. (508.2m-590kc), 11 a. m., organ recital; 12:02 p. m., Crystal Tea Room orchestra; 4:45, organ recital; 7:30, Adelphia hotel dance orchestra.

WOR, Newark, N. J. (405.2m-740kc), 6:30 p. m., Jacques Jacobs' Hotel Shelton ensemble.

WPG, Atlantic City, N. J. (299.8m-1000kc), 6:45 p. m., organ recital, Arthur Brook; 7, Hotel Morton dinner music; 8:15, concert, Neapolitan trio; Helen Hittner, soprano; Alice Wightman, accompanist; 10, Atlantic City Estates dance orchestra; 11, Silver Slipper Supper club, Eddie McKnight's orchestra.

WRC, Washington, D. C. (468.5m-640kc), 12 noon, organ recital; 12:30 p. m., Lenten services; 1, Hotel Mayflower orchestra; 7, New Willard hotel orchestra; 8:30, WJZ joint program; 9, Royal Salon orchestra; 10:45, Meyer Davis' Le Paradis band.

WTAG, Worcester, Mass. (268m-120kc), 10:30 a. m., musical program; 12:05-2 p. m., noon-day luncheon music; 4:30, entertainment; 8-8:30, WEAJ program; 9-10, WEAJ program; 10-11, WEAJ program.

WTAM, Cleveland, Ohio (389.5m-770kc), 12:15-1:30 p. m., Guy Lombardo and his Royal Canadians; 6-7, Austin Wylie's Vocalion Recording orchestra.

WTIC, Hartford, Conn. (475.9m-630kc), 6:30 p. m., twenty minutes in happyland; 6:50, Hotel Bond trio; 8, American Legion orchestra.

WWJ, Detroit, Mich. (352.7m-850kc), 12:05 p. m., Jules Klef'n's Hotel Statler orchestra; 3, Detroit News orchestra; 6, dinner concert; 8, WEAJ.

KPO GIVES OPERETTA "EL TOROSO"

Thursday, March 11

Central Time Stations

KFH, Wichita, Kan. (268m-1120kc), 10-11 p. m., American Legion quartet.

KFRU, Columbia, Mo. (499.7m-600kc), 4:30 p. m., Bella Vista Quadrangle orchestra; 6:15, dinner music.

KLDS, Independence, Mo. (441m-680kc), 8 p. m., music appreciation series, Arthur Mills; 8:15, musical program, William Jewell college.

KMA, Shenandoah, Iowa (252m-1190kc), 11:30-12:30 p. m., noonday rural program; Farnham trio; 9-11, Delmonico Dreggers' dance orchestra.

KPRC, Houston, Texas (296.9m-1010kc), 12 noon, Optimist's club luncheon program; 7:30 p. m., C. A. Blanchard and his orchestra; 8:30, concert.

KSD, St. Louis, Mo. (545.1m-550kc), 7 p. m., WEAJ program; 7:30, Esmeralda Berry Mayes, pianist; 8, WBAJ program; 9, WBAJ program.

KSO, Clarinda, Iowa (241.8m-1240kc), 7-8 p. m., music, Baker and Anderson; 8-9:30, college band.

KTSS, Hot Springs National Park, Ark. (374.8m-800kc), 9-9:30 p. m., Lawson Reid, organist; 9:30-10, operatic gems, Eastman Hotel Eight; 10-10:45, Harding College male quartet; 10:45-11:30, New Arlington hotel orchestra.

KYW, Chicago, Ill. (535.4m-560kc), 12:05-1 p. m., noonday concert; 1-2, luncheon concert, Congress hotel; 2:35-4, afternoon frolic; 6-7, dinner music; 8, musical program, Congress hotel; 9, music hour; 10, evening at home; 1 a. m., insomnia club.

WAMD, Minneapolis, Minn. (244m-1230kc), 6:15 p. m., George Osborn and his orchestra.

WBAP, Fort Worth, Tex. (475.9m-630kc), 12:05-12:30 p. m., Fred Cahoon's orchestra; 6-6:30, Texas hotel orchestra; 7:30-8:30, Lorena Walcott Barker, soprano; Carter Haynes, baritone; 9:30-11, A. and M. college; 11, Pantages theater.

WBBM, Chicago, Ill. (226m-1330kc), 4-6 p. m., Sandy and Harry; William Dalton, baritone; Irene Beasley; Sidney Nireman; Russell Meyers; Jack Pennewell and Freddy Palmer; 8-10, Barber Shop Three; Jack Crawford's orchestra; Ziegler Sisters; Two Jays; Charlie Garland; Maurice Silverman; Pauline Stiffler; Harry and Sandy; Moulton Rouge; Harry Brailford, mandolinist; Pearl Jarret; pianologues; Fred Jacobson; stars, Moulin Rouge cafe.

WCAL, Northfield, Minn. (336.9m-890kc), 7 p. m., program, Norwegian Lutheran church.

WCAR, San Antonio, Tex. (263m-1140kc), 8-9 p. m., Elephants; 9-10, Don Peacock and his orchestra.

WCBD, Zion, Ill. (344.6m-870kc), 8 p. m., mixed quartet, violin quartet, school chorus; Chester Bagg, baritone; Daniel Mason, trombonist; Gerald Mason, cornetist; Ruth Pihl, Mrs. Lucille Bird, duettists; Wiedman Sisters, double duets; Lois Wiedman, reader; Bessie Schaefer, pianist.

WCCO, Minneapolis, St. Paul, Minn. (416.4m-720kc), 12 noon, noon concert, Donaldson's orchestra; 2 p. m., among the musicians; 7, WEAJ program; 7:30, musical program; 8, WEAJ program; 10:20, Dick Long's Nankin cafe orchestra.

WDAF, Kansas City, Mo. (365.6m-820kc), 3:30-4:30 p. m., Star's string orchestra; 6-7, Trianon ensemble; 11:45-1 a. m., Ted Weem's Victor Recording orchestra.

WEAO, Columbus, Ohio (293.9m-1020kc), 1:30 p. m., request program; Robert Coleman, pianist; Mrs. Robert Cole, soprano; 8:15, music.

WEBB, Chicago, Ill. (370.2m-810kc), 9 p. m., Oriole orchestra; 9:45, Ruth Buhl Fieck, reader; Oriole saxophone quintet; Howard Neumiller, pianist; 11, Oriole orchestra; 12:30 a. m., Rita McFawn, Mary Bieber; Oriole string trio.

WFAB, Dallas, Tex. (475.9m-630kc), 12:30-1 p. m., Frank Reedy, traveler; 4:30-5, Noel Shaw, Eudoxia Butler; 6:30-7:30, Baker hotel orchestra; 8:30-9:30, Anna Majer Rapley, pianist.

WGN, Chicago, Ill. (302.8m-990kc), 11-11:30 a. m., morning organ concert, Chicago theater, Dean Fossler; 12:01-12:30 p. m., noon-hour entertainment for children; 12:40-2:30, luncheon concert music; 2:30-3, Lyon and Healy artists' recital; 3:25, Port o' Missing Men; 3:30-4:15, tea time music; 4:30-5, organ recital, Edward Benedict; 6:45, dinner concert music; 6:45-7, old-time favorite songs; 10-10:10, Sam 'n' Henry, Radio comic strip; 10:10-10:30, play shop; 10:30-10:45, old-time songs; 10:45, dance music; songs, Correll and Gosden, Freda Leonard and Jewell Barnett.

WHAS, Louisville, Ky. (399.8m-750kc), 1-2 p. m., concert, Benson trio; 3-3:30, organ recital, Mrs. Myrtle Fulks Zahn; 4-5, concert, Music Box Extension studio; 7:30-9, mixed vocal and instrumental concert; International Sunday school lesson.

WHB, Kansas City, Mo. (365.6m-820kc), 7-7:30 p. m., Morrill Moore, organist; 8-9, Hans C. Fell, organist; mixed quartet; 9-10, Missouri Pacific band.

WHO, Des Moines, Iowa (526m-570kc), 7:30-8 p. m., Raleigh quintet; 8-9, Bankers Life trio; 11-12, Bankers Life "Corn Sugar" orchestra.

WHT, Chicago, Ill. (399.8m-750kc), 10:15 a. m., Eva Ray, soprano; Amanda Burhop, pianist; 12 noon, Al Carney, organist; 6 p. m., dinner organ recital, Al Carney; 6:50, Hugh Aspinwall, tenor; Grayling's string trio; 6:45, Swedish program; 9:15, Cinderella cafe orchestra; 9:30, Kitchin Klentz Klässies; 9:50, Jack Turner, popular singer; Jack Marshall, pianist; 10:10, U. S. L. entertainers' quartet.

WIBO, Chicago, Ill. (226m-1330kc), 2-4 p. m., program for shut-ins; 6-8, dinner concert; songs made famous by John McCormack, Walter Preston; Helen Snyder, soprano; Harriet Hebert, contralto; William Molmaire, tenor; string trio; Chester Newman, baritone; Swedish program; 12, midnight jamboree; Ted Fiorito, pianist; Dan Russo, violinist; Marie Tully, soprano; Wayne Meyers, reader; Henry Davis; Erwin Cornelius, uke soloist; Jack Goodman.

WJAZ, Chicago, Ill. (322.4m-930kc), 9-12 p. m., Lucille Sweetser and Alice Regina Johnson, pianists; Hazel Folsom, soprano; Elaine Fine, mezzo-soprano; Ruth Ford, contralto; George Gramma, Smith, baritone; Louis Victor Sarr, pianist and composer; Hans Muenzer, violinist; Arvesta Parrish, contralto; chimes.

WJJD, Mooseheart, Ill. (370.2m-810kc), 2-3 p. m., Howard L. Peterson, organist; 4-5, music, children; 5:30-7, Jack Nelson; Palmer House symphonic players; Howard L. Peterson, organist; Palmer House Victorians; 8-9, music, children; 10-11, Palmer House Victorians; 12:30 a. m., Palmer House Victorians; Jack Nelson.

WKAJ, Milwaukee, Wis. (261m-1150kc), 8:30-10 p. m., Tricie Ann Toy and her Royal Hawaiians; Harmony Girls; Isabel Renee, Anne Bauman.

WKRC, Cincinnati, Ohio (325.9m-920kc), 10 p. m., Eugene Perazzo, organist; 10:30, Swiss Garden program; 11, popular song recital; 11:15, Marion McKay and his orchestra.

WLIB, Chicago, Ill. (302.8m-990kc), 7-7:30 p. m., musical program; 7:30-8, Hirs' Harvesters; 11-1 a. m., dance music, songs, Correll and Gosden; Hawaiian guitar music, Langdon Brothers.

WLS, Chicago, Ill. (344.6m-870kc), 6 p. m., WLS trio; 6:40, Ralph Emerson, organist; 7, Ford and Glenn; 7:15, staff artists.

WLW, Cincinnati, Ohio (422.3m-710kc), 12:40 p. m., songs, Russell Green, lyric tenor; 4, piano recital, Adelaide Aptel; 6:15, musical handshakes, Bob Groenke, Jim Mischler, the original Crosley Hello Boys; 7, dinner concert, Hotel Gibson orchestra; 8, musical Delta Omicron sorority, Eta chapter, College of Music; 8:30, Lee's concert band; 9:30, Uncle Jake Rutz and his Punkin Vine orchestra; 10:03, concert, Doherty Melody Boys; 11, Billy Huber, baritone; Pet Trimbur, pianist; 11:15, Castle Farm; 12:15 a. m., Night Howls with Crosley Pups.

WMAQ, Chicago, Ill. (447.5m-670kc), 6 p. m., Chi-

ago theater organ; 6:30, Hotel La Salle orchestra; 8:30, Chicago Kent vs. Iowa State debate.

WMBB, Chicago, Ill. (250m-1200kc), 7-8 p. m., Trianon duo; 9-11, Trianon orchestra; Woodlawn theater orchestra; Lucile O'Hara, soprano; Bob Duffy, baritone; Ed Wallace, tenor; Clinton Keithley, composer.

WOAW, Omaha, Nebr. (526m-570kc), 4:15 p. m., Adams' orchestra; 6, Dorothy Chenoweth Lowden, harpist; E. M. Mills, trumpeter; 6:30, Manna Kea trio; 6:50, Randall's Royal Fontenella orchestra; 10:30, Herb Felerman's orchestra; 12, Roseland Radio frolic.

WOI, Ames, Iowa (270m-1110kc), 8 p. m., musical program, orchestra, First M. E. church.

6:15, Seeing California; 6:30, vest pocket program; 6:45, Radiatorial period; 7-8, program, students, University of Southern California; 8-9, dance music; 9-10, program by remote control from Chickering Hall; 10-11, varied program of classics and semi-classics.

KFOA, Seattle, Wash. (454.3m-660kc), 4-5:15 p. m., Times program.

KFON, Long Beach, Calif. (232.4m-1290kc), 6-6:30 p. m., Brayton's theater organ; 6:30-7, amusement information; 7-7:30, studio program; 7:30-8, Long Beach Municipal band; 8, book chat; 8:15-9, Municipal band; 9-11, Lake club dance orchestra.

KFWB, Hollywood, Calif. (252m-1190kc), 8-9 p. m.,

Eastern	Central	Mountain	Pacific
6 WCAP (468.5m-640kc) Mozart string quintet.	5 KSD (545.1m-550kc) Scandinavian program.	4 WBZ (333.1m-900kc) North Atlantic fiddlers.	3 WCAE (461.3m-650kc) Kenyon Troubadours.
8:30 WJO (526m-570kc) Jack Little.	7:30 WAMD (244m-680kc) Reception Five.	6:30 WDAF (365.6m-820kc) Opera, "The Mikado."	5:30 KTSS (374.8m-800kc) Italian Neapolitan folk music.
9 KOA (322.4m-930kc) Welsh male chorus.	8 KTHS (374.8m-800kc) Italian Neapolitan folk music.	7:15 KOA (322.4m-930kc) Welsh male chorus.	6:30 KOA (322.4m-930kc) Welsh male chorus.

EDUCATIONAL FEATURES

Saturday, March 6

Eastern	Central	Mountain	Pacific
7:30 p. m. WHAR (275m-1090kc) Lecture period	6:30 p. m. KOIL (278m-1080kc) Educational period, University of Omaha.	5:30 p. m. WMAQ (447.5m-670kc) "Constantinople," Capt. Joel I. Connolly.	4:30 p. m.

Eastern	Central	Mountain	Pacific
7:40 p. m. WTAG (268m-1120kc) Spanish lesson, Mrs. John de la Parra.	6:40 p. m. WBAO (293.9m-1020kc) "Illumination," Prof. F. C. Caldwell.	5:40 p. m. WMCA (340.7m-880kc) Talk on securities.	4:40 p. m.

Monday, March 8

Eastern	Central	Mountain	Pacific
1:30 p. m. WSUI (483.6m-620kc) Address, Prof. Fleming.	11:30 p. m. WNYC (526m-570kc) German lesson.	10:30 p. m. WYEF (491.5m-610kc) Columbia university lecture.	9:30 p. m.

Eastern	Central	Mountain	Pacific
8:30 WMAQ (447.5m-670kc) lecture, Northwestern university.	7:30 WYEF (491.5m-610kc) Columbia university lecture.	6:30 KSL (299.8m-1000kc) "History of Mining."	5:30

Tuesday, March 9

Eastern	Central	Mountain	Pacific
1 p. m. KPRC (296.9m-1010kc) Educational program.	11 a. m. WYEF (491.5m-610kc) Columbia university lecture.	10 a. m. WNYC (526m-570kc) Advanced German lesson.	9 a. m.

Eastern	Central	Mountain	Pacific
8 WYEF (491.5m-610kc) Columbia university lecture.	7:30 WYEF (491.5m-610kc) Columbia university lecture.	6:30 WYEF (491.5m-610kc) Columbia university lecture.	5:30

Wednesday, March 10

Eastern	Central	Mountain	Pacific
8 p. m. KGO (361.2m-830kc) Speaker from Williams institute.	7 p. m. WNYC (526m-570kc) Spanish lesson, V. H. Berltz.	6 p. m. WNYC (526m-570kc) Advanced Spanish lesson.	5 p. m.

Thursday, March 11

Eastern	Central	Mountain	Pacific
7:30 p. m. KSAC (340.7m-880kc) Music, educational psychology.	6:30 p. m. WYEF (491.5m-610kc) French course.	5:30 p. m. WMAQ (447.5m-670kc) lecture, University of Chicago.	4:30 p. m.

Friday, March 12

Eastern	Central	Mountain	Pacific
4 p. m. KFAB (340.7m-880kc) Science lectures.	3 p. m. KSAC (340.7m-880kc) Lessons in color and design.	2 p. m. WNYC (526m-570kc) French lesson.	1 p. m.

Eastern	Central	Mountain	Pacific
5:30 KSAC (340.7m-880kc) Lessons in color and design.	4:30 WNYC (526m-570kc) French lesson.	3:30 WNYC (526m-570kc) Advanced French.	2:30

Saturday, March 13

Eastern	Central	Mountain	Pacific
8:15 WCAU (277.6m-1080kc) chiropractic talk.	7:15 KSL (299.8m-1000kc) History of Civil Engineering.	6:15 WMAQ (447.5m-670kc) lecture, University of Chicago.	5:15

Eastern	Central	Mountain	Pacific
9:35 KSL (299.8m-1000kc) History of Civil Engineering.	8:35 WMAQ (447.5m-670kc) lecture, University of Chicago.	7:35 WNYC (526m-570kc) Board of Education.	6:35

Sunday, March 14

Eastern	Central	Mountain	Pacific
8:15 WCAU (277.6m-1080kc) chiropractic talk.	7:15 KSL (299.8m-1000kc) History of Civil Engineering.	6:15 WMAQ (447.5m-670kc) lecture, University of Chicago.	5:15

Eastern	Central	Mountain	Pacific
9:35 KSL (299.8m-1000kc) History of Civil Engineering.	8:35 WMAQ (447.5m-670kc) lecture, University of Chicago.	7:35 WNYC (526m-570kc) Board of Education.	6:35

Monday, March 15

Eastern	Central	Mountain	Pacific
8:15 WCAU (277.6m-1080kc) chiropractic talk.	7:15 KSL (299.8m-1000kc) History of Civil Engineering.	6:15 WMAQ (447.5m-670kc) lecture, University of Chicago.	5:15

Eastern	Central	Mountain	Pacific
9:35 KSL (299.8m-1000kc) History of Civil Engineering.	8:35 WMAQ (447.5m-670kc) lecture, University of Chicago.	7:35 WNYC (526m-570kc) Board of Education.	6:35

Tuesday, March 16

Eastern	Central	Mountain	Pacific
8:15 WCAU (277.6m-1080kc) chiropractic talk.	7:15 KSL (299.8m-1000kc) History of Civil Engineering.	6:15 WMAQ (447.5m-670kc) lecture, University of Chicago.	5:15

Eastern	Central	Mountain	Pacific
9:35 KSL (299.8m-1000kc) History of Civil Engineering.	8:35 WMAQ (447.5m-670kc) lecture, University of Chicago.	7:35 WNYC (526m-570kc) Board of Education.	6:35

Wednesday, March 17

Eastern	Central	Mountain	Pacific
8:15 WCAU (277.6m-1080kc) chiropractic talk.	7:15 KSL (299.8m-1000kc) History of Civil Engineering.	6:15 WMAQ (447.5m-670kc) lecture, University of Chicago.	5:15

Eastern	Central	Mountain	Pacific
9:35 KSL (299.8m-1000kc) History of Civil Engineering.	8:35 WMAQ (447.5m-670kc) lecture, University of Chicago.	7:35 WNYC (526m-570kc) Board of Education.	6:35

Thursday, March 18

Eastern	Central	Mountain	Pacific
8:15 WCAU (277.6m-1080kc) chiropractic talk.	7:15 KSL (299.8m-1000kc) History of Civil Engineering.	6:15 WMAQ (447.5m-670kc) lecture, University of Chicago.	5:15

Eastern	Central	Mountain	Pacific
9:35 KSL (299.8m-1000kc) History of Civil Engineering.	8:35 WMAQ (447.5m-670kc) lecture, University of Chicago.	7:35 WNYC (526m-570kc) Board of Education.	6:35

Friday, March 19

Eastern	Central	Mountain	Pacific
8:15 WCAU (277.6m-1080kc) chiropractic talk.	7:15 KSL (299.8m-1000kc) History of Civil Engineering.	6:15 WMAQ (447.5m-670kc) lecture, University of Chicago.	5:15

Eastern	Central	Mountain	Pacific
9:35 KSL (299.8m-1000kc) History of Civil Engineering.	8:35 WMAQ (447.5m-670kc) lecture, University of Chicago.	7:35 WNYC (526m-570kc) Board of Education.	6:35

Saturday, March 20

Eastern	Central	Mountain	Pacific
8:15 WCAU (277.6m-1080kc) chiropractic talk.	7:15 KSL (299.8m-1000kc) History of Civil Engineering.	6:15 WMAQ (447.5m-670kc) lecture, University of Chicago.	5:15

Eastern	Central	Mountain	Pacific
9:35 KSL (299.8m-1000kc) History of Civil Engineering.	8:35 WMAQ (447.5m-670kc) lecture, University of Chicago.	7:35 WNYC (526m-570kc) Board of Education.	6:35

Friday, silent night for: CFAC, CHIC, CKNC, CKY, CNRC, CNRM, CNRO, CNRR, CNRW, KFAU, KFEJ, KFKU, KFWA, KFXF, KGO, KFAU, KLDS, KPRC, KUOA, KUOM, PWX, WBBR, WCAE, WCBD, WEAQ, WEBW, WGBS, WGST, WHAZ, WIP, WJAZ, WKRC, WLW, WLWL, WMAK, WNAD, WRC, WREO, WRVA, WSAI, WSMB, WSUI, WTAM.

Eastern Time Stations

CNRT, Toronto, Can. (356.9m-640kc), 6:30 p. m., King Edward hotel concert orchestra; 7:30, Florence M. Benjamin, mezzo-soprano; Hazel Collins, accompanist; 9, Music Makers; 11, King Edward hotel dance orchestra.

KDKA, Pittsburgh, Pa. (309.1m-970kc), 6:30 p. m., dinner concert; 9, concert; 10:10, Teaberry time.

WAHG, Richmond Hill, N. Y. (315.6m-950kc), 12 noon, musical; 7:45 p. m., Estelle Mayer, violinist; 8, Skinner organ recital; 9, Fred Gerrold, baritone; 9:15, Shell Beach trio; 9:40, John Von Aspe, tenor; 10, songs; 10:15, dance orchestra.

WBAL, Baltimore, Md. (246m-1220kc), 6:30-7:30 p. m., WBAL dinner orchestra; 7:30-8, WBAL male quartet; 8-9, Mary Knox Fitz, pianist; John Mealy, whistler.

WBZ, Springfield, Mass. (333.1m-900kc), 6:30 p. m., Hotel Kimball orchestra; 7, Helen S. Leavitt, organist; 8, concert, Edwin J. McEnelly and his orchestra; 8:30, fiddlers' contest.

WCAE, Pittsburgh, Pa. (461.3m-650kc), 6:30 p. m., dinner concert, William Penn hotel; 6:30 p. m., Kenyon Troubadours; 10:30, Brunswick orchestra.

WCAP, Washington, D. C. (468.5m-640kc), 6 p. m.-12:30 a. m., Mozart string quintet; Little orchestra; WEAJ program.

WCAU, Philadelphia, Pa. (277.6m-1080kc), 6:45 p. m., Hotel Pennsylvania orchestra; 7:30, Snellenburg instrumental trio; 8, recital; 8:15, chiropractic talk; 8:30, Singing Groundhog; 8:45, Bryan Gray; 9:15, Dwight Strickland, "poetician"; 9:30, Sea Gulls dance orchestra; 10, songs; 10:30, Myers' Musical Architects.

WCX, Detroit, Mich. (516.9m-580kc), 6-7 p. m., dinner program, Goldkette's ensemble; 8-9, program; 9-10, dance music, Jean Goldkette's Breeze Blowers.

WDBO, Winter Park, Fla. (239.9m-1250kc), 9-10:30 p. m., entertainment; Sandals harmonizers.

WEAF, New York, N. Y. (491.5m-610kc), 4 p. m., Francine Vye, coloratura soprano; 4:15, Celia Ngan, pianist; 4:30, Leo Bartanovic, baritone; 5, Vincent Lopez and his orchestra; 6, dinner music; 7, Carroll Cooney's orchestra; 7:30, "Sir Hobgoblin Has a Bit of News," WOO, WCAP, WCAE, WGR, WJAR, WEAR, WTAG, WOC; 7:45, Rudolph Joskowitz, concert violinist; 8, Happiness Candy Boys; 8:30, Eagle Neurodyne trio; 9, Cities Service quartet and orchestra; WEEL, WOO, WEAR, WGN, KSD; 9:30, The Vikings, WJAR, WGR, WTAG, WCAE, WOC, WWJ, KSD, WEAR, WCAP; 10, Whitall Anglo Perstans, WCAP, WEEL, WJAR, WOO, WGR, WTAG, WCAE, WOC, WCCO, WWJ, KSD, WEAR, WGN; 10:30, chamber music; 11-12, Ben Bernie and his orchestra.

WEAR, Cleveland, Ohio (389.4m-770kc), 7 p. m., Worman's Singing Synopators; 7:30, WEAJ program; 8, Wingofoot quartet; 9, WEAJ program; 9:30, WEAJ program; 10, WEAJ program; 10:30, Worman's Singing Synopators.

WEBB, New York, N. Y. (272.6m-1100kc), 7 p. m., Ritz theater ensemble; 7:45, W. C. Haffel, entertainer; 8, Ben Rutz, Michael Savino, Hawaiian guitar duets; 8:15, Richard Franklin, pianist; 8:30, Paradise Melodians.

WEEL, Boston, Mass. (348.6m-860kc), 5 p. m., Frankie Ward and his orchestra; 6:15, Joe Rines and his Hunters' Cabin orchestra; 6:45, Big Brother club; 7:30, Whiting's Milk company program; 8, musical; 8:30, Neapolitan Ice Cream company program; 9, WEAJ program; 9:30, Carter's Inca; 10-10:30, WEAJ program.

WFI, Philadelphia, Pa. (394.5m-760kc), 1 p. m., Tea Room ensemble; 3, Sesqui-centennial program; 6:30, Bellevue-Stratford concert orchestra; 7, Bellevue-Stratford dance orchestra.

WGBS, New York, N. Y. (315.6m-950kc), 1:35 p. m., Juliet Strahl, soprano; 2, school children's program; 3:10, Anna Winner, contralto; 6:30, Anzell's orchestra.

WGCP, New York, N. Y. (252m-1190kc), 3 p. m., Elvira Rosa Geiger, pianist; 3:30, Marie Kalla, soprano; 3:45, Sherman and Neal, songs; 4:15, Hugo Angelo, tenor; 4:45, Rubey Congo, songs; 5:10, Clarence Profit, pianist; 7, China Ross, orchestra; 7:30, Billy Infield, pianist and singer; 8:15, program.

WGHP, Detroit, Mich. (270m-1110kc), 6-7 p. m., dinner concert, Hotel Tuller; 10-11, entertainers; 11-12, Skylark dance band; T. Stanley Perry, tenor; 12-1 a. m., Gerald Marks and his orchestra.

WGY, Schenectady, N. Y. (379.5m-790kc), 2:30 p. m., WGY matinee players; 7, Eastman theater orchestra; 8:15, "Border Lines," WGY players; 10:30, Rice string quartet; Carl Jester, tenor.

WHAR, Atlantic City, N. J. (275.1m-1090kc), 8 p. m., Seaside hotel trio.

WHN, New York, N. Y. (361.2m-830kc), 2:15-4 p. m., musical program announced; 6, people's hour; 7, Harry Richman and his entertainers; 7:30, Melody club orchestra; 8, Loew's vaudeville hour; 9, Loew's theater orchestra; 10, Roseland dance orchestra; 10:30, Anatol Friedland; 11, Twin Oaks orchestra; 12, Silver Slipper orchestra; 12:30 a. m., Avalon club orchestra.

WIP, Philadelphia, Pa. (508.2m-590kc), 1 p. m., Gimbel Tea Room orchestra; 6:05, Benjamin Franklin concert orchestra; 7, Uncle Wip's bedtime stories; Alberta Fuchs, songs.

WJR, Pontiac, Mich. (516.9m-580kc), 7 p. m., Jean Goldkette's symphony orchestra; soloists; 9, Mulkey Celebrities.

NORTH-ATLANTIC FIDDLERS AT WBZ



The Community programs at WSAI, Cincinnati, have been featuring many prominent American musicians. This week Francis MacMillen, famous violinist, is the soloist.

Friday, March 12

tra; 4:45, organ recital; 7:30, Ritz-Carlton dance orchestra; 9:25, Fox theater symphony orchestra; 10:15, organ recital, Mary E. Vogt; 10:30, Sylvania dance orchestra.

WOR, Newark, N. J. (405.2m-740kc), 8:30 p. m., Jacques Jacobs' Hotel Shelton ensemble; 7, Copenhagen quartet.

WPG, Atlantic City, N. J. (299.8m-1000kc), 1:30 p. m., Hotel Morton music; 4:30, organ recital, Arthur Brook; 7, Hotel Morton dinner music; 8:15, Sol Kendis and Chick Leonard, entertainers; 8:30, studio concert; 9, Hotel Traymore concert orchestra; 9:30, Hotel Traymore dance orchestra; 11, organ recital, popular selections, Jean Wiener, organist.

WRC, Washington, D. C. (468.5m-640kc), 12 noon, Otto F. Beck, organist; 12:30 p. m., Lenten services; 1, Meyer Davis' New Willard hotel orchestra; 3:30, concert, U. S. Marine band orchestra; 5, W. Spencer Tuppman's Hotel Mayflower orchestra.

WTAG, Worcester, Mass. (268m-1120kc), 10:30 a. m., musical program; 12:05-2 p. m., noon-day luncheon music; 3-5, Tea Dansant music; 8:15-9:30, concert program; 9:30-10, WEAF program; 10:30-10:30, WEAF program.

WTAM, Cleveland, Ohio (389.5m-770kc), 12:15-1:30 p. m., Guy Lombardo and his Royal Canadians; 6-7, Hotel Hollenden orchestra.

WTIC, Hartford, Conn. (475.9m-630kc), 11:25 a. m., Laura C. Gaudet, pianist; 12:05 p. m., Travelers club orchestra; 6:30, Hub trio.

WWJ, Detroit, Mich. (352.7m-850kc), 12:05 p. m., Jules Klein's Hotel Statler orchestra; 6, dinner concert; 8, Elks; 9:30, WEAF; 10:30, dance program.

Central Time Stations

KFAB, Lincoln, Nebr. (340.7m-880kc), 5:30-6:30 p. m., dinner concert; 8:30-10:30, program, C. B. & Q.

KFH, Wichita, Kan. (268m-1120kc), 10-11 p. m., Lambert Crystal Radio program.

KFRU, Columbia, Mo. (499.7m-600kc), 4:30 p. m., Bella Vista Quadrangle orchestra; 6:15, dinner music; 12-1 a. m., musical program, Stephens college faculty of music; 1-2, Bella Vista Quadrangle orchestra.

KMA, Shenandoah, Iowa (252m-1190kc), 11:30-12:30 p. m., noonday rural program; piano solos, Walter Nixon; 6-7, How-do-you-do boys; 9-11, musical program.

KPRC, Houston, Texas (296.9m-1010kc), 12 noon, Frank Tilton, blind wonder boy, pianist.

KSD, St. Louis, Mo. (545.1m-550kc), 7 p. m., Scandinavian program, Gumborg Aspen, soprano; 8, WEAF program; 8:30, WEAF program; 9, WEAF program.

KSO, Clarinda, Iowa (241.6m-1240kc), 7-7:30 p. m., music; 7:30-9:30, mixed program, orchestra.

KTHS, Hot Springs National Park, Ark. (374.8m-800kc), 9-9:30 p. m., Italian Neapolitan folk music; 9:30-10:30, Jack-o'-Lantern Night club; 10:30-11:15, artists' presentation.

KYW, Chicago, Ill. (535.4m-560kc), 12:05-1 p. m., noonday concert; 1-2, luncheon concert, Congress hotel 6-7, dinner music; 9, music hour; 10-12:30 a. m., midnight revue; Henri A. Keates, McVickers organ; 1, Insomnia club.

WAMD, Minneapolis, Minn. (244m-1230kc), 7:10 p. m., Schiller school program; 8, Reception Five program; 11, George Osborn and his orchestra.

WBAP, Fort Worth, Tex. (475.9m-630kc), 12:05-12:30 p. m., Fred Cahoon's orchestra; 6-6:30, Texas hotel orchestra; 7:30-8:30, Mineral Wells Lodge No. 212, K. of P.; 9:30-11, A. & M. orchestra.

WBBM, Chicago, Ill. (226m-1330kc), 4-6 p. m., Harry and Sandy; Harold Morava, lyric tenor; William Dalton, baritone; Joe McManus; Ralph Bothof; 8-10, Moutin Rouge orchestra; Two Jays; Jack Crawford's orchestra; Barber Shop Three; Verdi trio; Dave Handler, violinist; Floyd Falch.

WCAF, San Antonio, Tex. (263m-1140kc), 8-10 p. m., musicale.

WCCO, Minneapolis-St. Paul, Minn. (416.4m-720kc), 6:15 p. m., dinner concert; Bilex's St. Paul hotel concert orchestra; 8, Watkins Minstrels; 9, WEAF program; 10:05, Emmet Long's Golden Pheasant orchestra.

WDAF, Kansas City, Mo. (365.6m-820kc), 6-7 p. m., Trianon ensemble; 11:45-1 a. m., Ted Weem's Victor Recording orchestra.

WEBH, Chicago, Ill. (370.2m-810kc), 7 p. m., Oriole orchestra; 8, Pauline Sachs, soprano; Eleanor Kaplan, violinist; 9:45, WEBH light opera company; 11, Oriole orchestra; 12:30 a. m., Irene Beasley; Oriole matimba band.

WFAA, Dallas, Tex. (475.9m-630kc), 4:30-5 p. m., MacDowell Sisters; 6:30-7:30, Hauulea School of Hawaiian Music; 8:30-9:30, Mrs. Robert Parks Bennett.

WGN, Chicago, Ill. (302.3m-990kc), 12:40-2:30 p. m., luncheon concert music; 2:30-3, Lyon and Healy artists' recital; 3:25, Port of Missing Men; 3:30-4:15, tea time music; 4:30-5, organ recital, Edward Benedict; 5:30-5:57, Skeezix time for children; 6:30-6:45, dinner concert music; 6:45-7, old-time favorite songs; 8-8:30,

Cities Service quartet; 10-10:10, Sam 'n' Henry, Radio comic strip; 10:10-10:30, play shop; 10:45-11, dance music; songs, Correll and Gosden, Freda Leonard and Jewell Barnett; Hawaiian guitar music, Langdon Brothers.

WHAS, Louisville, Ky. (399.8m-750kc), 1-2 p. m., concert, Royal Peacock orchestra; 3-3:30, organ recital, Mrs. Myrtle Fuiks Zahn, Jr.; 4-5, concert, Music Box Extension studio; 7:30-9, concert, Louisville Music and Radio company.

WHB, Kansas City, Mo. (365.6m-820kc), 7-8 p. m., Sweeney Radio orchestra; Bert Bender, Zelma Maddock, pianist.

9, Young American artists' series; 9:30, WLS concert company; 10, Police octet; 11-2 a. m., dance program.

WMAQ, Chicago, Ill. (447.5m-670kc), 6 p. m., Chicago theater organ; 9:55, chimes.

WMAZ, Mason, Ia. (261m-1150kc), 9-10 p. m., music club; 10-11, Mason Rotary club.

WMBB, Chicago, Ill. (250m-1200kc), 7-8 p. m., Trianon duo; Vella Cook, contralto; Frank Bordner, baritone; Frank Chaplin; 9-11, Trianon orchestra; Woodlawn theater orchestra; Scotty Welsh and Madison Sisters; Joe Warner, character songs; Eddie Matts and Billie Donovan; Earl Smith, "double voiced".

concert, Francis Craig's orchestra; 8, program, Mrs. W. V. Clarke, soprano; 10, program, Kiwanis club.

WSUI, Iowa City, Iowa (483.6m-920kc), 12:30 p. m., piano recital, Dr. Jacob Kwassler.

Mountain Time Stations

KOA, Denver, Colo. (322.4m-930kc), 12:15 p. m., Marjorie Nash, organist; 3:30, Mrs. Max Grimes, soprano; Mrs. Carol Stone, pianist; 6:30, Brown Palace string orchestra; 8, Scheurman's Colorado orchestra; 8:15, Ralph Scott, baritone; KOA orchestra; sketches, Oscar W. Low; A. G. Durham, saw soloist; Welsh male chorus; Henry Zarlengo, accordionist.

KSL, Salt Lake City, Utah (299.8m-1000kc), 8 p. m., Porter Walton company; 9, Radio Hardware company.

Pacific Time Stations

KFI, Los Angeles, Calif. (467m-642kc), 5:30-6 p. m., Kenneth Morse and his orchestra; 6, nightly doings; 6:15, Seeing California; 6:30, vest pocket program; 6:45, Radiatorial period; 7-8, Spanish music hour, Felipe Delgado; 8-9, Dan L. McFarland, organist; 9-9:30, popular music; 9:30-10, Mutual Motors joke contest; 10-11, vocal program by pupils of Myra Belle Vickers.

KFOA, Seattle, Wash. (454.3m-660kc), 12:30-1:30 p. m., Chamber of Commerce program; 6-6:30, Atwater Kent Boys; 7-8:15, Sherman Clay and company program; 8:30-10, Times program; 10-11, Jackie Souder's Club Lido serenaders.

KFON, Long Beach, Calif. (232.4m-1290kc), 6-6:30 p. m., Brayton's theater organ; 6:30-7, amusement information; 7-8, program, Dalton and Hoagland; 8-9, Press-Telegram studio; 9-10, Nichols and Warriner hour; 10-12, Long Beach Elks Lodge No. 888 frolic.

KFWB, Hollywood, Calif. (252m-1190kc), 8-9 p. m., program, John Wright, The Right Tailor with Raquel Nieto, coloratura soprano in operatic numbers; Esther White, popular songs; Bill Blake, tenor; 9-10, Len Nash and his original Country Boys; 10-11, Warner Brothers' frolic.

KGO, Oakland, Calif. (361.2m-830kc), 3-4 p. m., Maybelle Morrison, violinist; Louise Killilea, soprano; Harriette Murton, contralto; Anna Lucchesi, pianist; 4-5:30, concert orchestra; 6-6:55, Knickerbocker trio.

KHJ, Los Angeles, Calif. (405.2m-740kc), 8-10 p. m., program, Western Auto Supply company.

KMTR, Hollywood, Calif. (238m-1260kc), 8-10 p. m., KMTR concert orchestra, Loren Powell, director; 10-11, Starr Piano company, studio.

KNX, Hollywood, Calif. (336.9m-890kc), 5:30 p. m., Leighton's cafeteria orchestra; 6:30-7, Atwater Kent concert orchestra; 7-8, program, Jell-X-Cell company; 8-9, KNX feature program; 9-10, Order of Optimistic Donuts; 10-11, studio program; 11-12 midnight, Coconut Grove dance orchestra from the Ambassador.

KOAC, Corvallis, Ore. (280.2m-1070kc), 7:20 p. m., Arthur Kirkham, tenor; 8-9, musical program.

KPO, San Francisco, Calif. (428.3m-700kc), 1:30-2 p. m., Rudy Seiger's Fairmont hotel orchestra; 6:30-7, Waldemar Lind's orchestra; 8-9, program, Aeolian string quartet; 9-10, Palace hotel dance orchestra; 10-11, Waldemar Lind's orchestra.

KTAB, Oakland, Calif. (240m-1250kc), 12-1 p. m., luncheon concert; 8-10, program.

KWSC, Pullman, Wash. (348.6m-860kc), 7:30-9 p. m., Orpheus Music club, vocal trio, Pep orchestra; Faye Erwin, vocalist; Rev. Barrett, Jessie Plaskett, pianists; classical orchestra; Danae Livesay, pianist; saxophone and mouth organ duo, Otto Johnson, Ed Chittenden.

BROADCASTER BRIEFS

(Continued from page 2)

at WOR, Newark. History of the drama, talks on scene designing, lighting and costumes, and stage makeup will make these afternoons valuable to directors of little theater groups.

The new Alemitic orchestra, directed by Jack Crawford, will appear shortly at WBBM, Chicago. This famous orchestra has been appearing in the East.

"Sam 'n' Henry," laughable characters in WGN's Radio "comic strip," who are heard each evening at 10 o'clock Central time, have been the recipients of many gifts since they started their hilarious series of adventures, but none more appropriate than one which reached them recently. At the conclusion of one of their episodes, Sam announced to Henry that he was hungry, and the next day a fine packet of ham sandwiches reached him, the gift of some unknown listener.

The famous "Sir Hobgoblin" stories for children are being brought from WEAF, New York city, to WOC, Davenport, by long distance telephone lines every Friday evening. The regular WOC Sandman story teller, L. Emery Wass, will continue with his children's stories on other evenings during the week.

The demand for the Crosley Burnt Corkers has been so great that it has been decided to make this unique minstrel act a regular feature of the Tuesday evening programs. These minstrels will be held for half-an-hour beginning at 8 p. m. central time.

The talks entitled "Current Topics," given from WOR Monday evenings, are broadcast by a man well qualified to condense the world's news, H. V. Kaltenborn, associate editor of the Brooklyn Daily Eagle. Mr. Kaltenborn is a linguist of unusual skill and is equally at home speaking French, German or Spanish. When he served his paper as special observer in Europe before and after the

The Coal Miners trio, recently added as a feature of the Monday evening programs of WEAF, will be heard again in a typical program of diversity and novelty emphasizing the vocalization of popular songs. Two of the members of this trio, Frank Bessinger and Frank Wright, are popularly known as "The Radio Franks" and have been heard often at WEAF.

GENERAL TALKS AND SPEECHES

Saturday, March 6			
Eastern 8 p. m.	Central 7 p. m.	Mountain 6 p. m.	Pacific 5 p. m.
WCCO (416.4m-720kc) "Fireside Philosophies," Rev. Roy L. Smith.			
WEAF (491.5m-610kc) "Making Use of the Museum," Homer St. Gaudens.			
8:05	7:05	6:05	5:05
WAMD (244m-1230kc) Talk, "What Prominent Outsiders Think of Minneapolis and the Great Northwest."			
8:15	7:15	6:15	5:15
WOR (405.2m-740kc) Saturday review of literature.			
8:45	7:45	6:45	5:45
WRC (468.5m-640kc) Zoo talk.			
8:30	7:30		6:30
WMAQ (447.5m-670kc) "Constantinople," Capt. Joel I. Connolly.			
WCAL (336.9m-890kc) "With the Great Masters," Dr. C. A. Melby.			
9:45	8:45	7:45	6:45
KHJ (405.2m-740kc) History story, Prof. Hertzog.			
10:10	9:10	8:10	7:10
WNXC (526m-570kc) Travel talk.			

Monday, March 8			
Eastern 5 p. m.	Central 4 p. m.	Mountain 3 p. m.	Pacific 2 p. m.
WCCO (416.4m-720kc) Readers' club, Mrs. Walter Stevens.			
6	5	4	
WBZ (933.1m-900kc) "Theatrical Gossip," Sam Wren.			
WCCO (416.4m-720kc) Talk, M. M. Oppgaard.			
WRC (468.5m-640kc) "Show Shopping," Leonard Hall.			
WTAG (268m-1120kc) Science talk, Fred D. Aldrich.			
7:40	6:40	5:40	4:40
WOAW (526m-570kc) Insurance talk.			
8:30	7:30	6:30	5:30
WPG (299.8m-1000kc) Health talk.			
8:45	7:45	6:45	5:45
WEAF (491.5m-610kc) Tower health talk.			
9	8	7	6
WBAL (246m-1220kc) Talk, Dr. David M. Robinson.			
9:30	8:30	7:30	6:30
KUOA (299.8m-1000kc) Better home talks.			
11:25	10:25	9:25	8:25
KGO (361.2m-830kc) "Chats About New Books," Joseph Henry Jackson.			

Tuesday, March 9			
Eastern 3 p. m.	Central 2 p. m.	Mountain 1 p. m.	Pacific 12 n.
KMA (252m-1190kc) Travelogue, G. H. Van Houten.			
3:30	2:30	1:30	12:30
WCCO (416.4m-720kc) "The World of Books," H. A. Bellows.			
6:30	5:30	4:30	3:30
WBZ (333.1m-900kc) "Great Italian Cities," A. O. Osborne.			
7	6	5	4
CRAC (410.7m-730kc) Safety league talks.			
WCCO (416.4m-720kc) Talk on Gorgas Memorial," Dr. H. D. Lees.			
7:45	6:45	5:45	4:45
WMAQ (365.6m-820kc) Road talk.			
8:45	7:45	6:45	5:45
WMAQ (340.7m-880kc) Tyrrell's health talk.			
WTAG (268m-1120kc) "Detours for Radio Waves," Herbert H. Newell.			
8:50	7:50	6:50	5:50
WLW (422.3m-710kc) Dogs.			
9	8	7	6
WJJD (370.2m-810kc) Talk, Matthew P. Adams.			
WMAQ (447.5m-670kc) Book talk, Harry Hansen.			
WTIC (475.9m-630kc) "Crisis in Federal Reserve System," Prof. K. M. Williamson.			
9:15	8:15	7:15	6:15
KNX (336.9m-890kc) Travel talk, W. F. Alder.			
WMAQ (447.5m-670kc) Travel talk.			
9:45	8:45	7:45	6:45
KHJ (405.2m-740kc) History story, Prof. Hertzog.			
WMAQ (447.5m-670kc) University of Chicago lecture.			
10:30	9:30	8:30	7:30
WCCO (416.4m-720kc) "Outdoors in Minnesota,"			
11	10	9	8
KGW (491.5m-610kc) Book review; word-cartoon on styles.			
12	11	10	9
KGO (361.2m-830kc) "Wonders of the Sky," Henry M. Hyde.			

Wednesday, March 10			
Eastern 4:45 p. m.	Central 3:45 p. m.	Mountain 2:45 p. m.	Pacific 1:45 p. m.
WEAF (491.5m-610kc) "Modern European Fiction," Dorothy Brewster.			
5	4	3	2
WCCO (416.4m-720kc) Readers' club.			
7 p. m.	6 p. m.	5 p. m.	4 p. m.
WDAF (365.6m-820kc) Health talk; meat talk.			
WHB (365.6m-820kc) Automotive extension lesson, John Burns.			
WMAQ (447.5m-670kc) Lecture, Northwestern university.			
9	8	7	6
WLWL (288.3m-1040kc) "Accountancy," K. of C.			

Thursday, March 11			
Eastern 4:45 p. m.	Central 3:45 p. m.	Mountain 2:45 p. m.	Pacific 1:45 p. m.
WEAF (491.5m-610kc) "Homes of Our Presidents," Henry Humphrey.			
5	4	3	2
KMA (252m-1190kc) Travelogue, G. H. Van Houten.			
WCCO (416.4m-720kc) Readers' club.			
7	6	5	4
WDAF (365.6m-820kc) Book talk, Louis Mecker.			
WGY (379.5m-790kc) WGY book chat, William F. Jacob.			
7:45	6:45	5:45	4:45
WMCA (340.7m-880kc) Health talk.			
8	7	6	5
WIP (508.2m-590kc) "The Sesqui-Centennial," Hon. Harry A. Mackey.			
WRC (468.5m-640kc) Smithsonian talk.			
8:30	7:30	6:30	5:30
WGBS (315.6m-950kc) "Footlight and Lamplight," Oliver Saylor.			
WLW (422.3m-710kc) "The Eyes Have It," Dr. H. Kaufman.			
WTAG (268m-1120kc) Travel talk.			
9	8	7	6
KUOA (299.8m-1000kc) "Arkansas Rural Electric Lines," W. B. Stelzner.			
KYW (535.4m-560kc) "Twenty Minutes of Good Reading," Rev. C. J. Perrin.			
9:15	8:15	7:15	6:15
WLWL (288.3m-1040kc) Review of books.			
9:30	8:30	7:30	6:30
KNX (336.9m-890kc) Travel talk, W. F. Alder.			
WMAQ (447.5m-670kc) Talk, Chicago Association of Commerce; lecture, University of Chicago.			
9:45	8:45	7:45	6:45
KHJ (405.2m-740kc) History talk.			
10	9	8	7
WRC (468.5m-640kc) Political situation, Frederick W. Wile.			
WMAQ (447.5m-670kc) Lecture, University of Chicago.			
10:30	9:30	8:30	7:30
KHJ (405.2m-740kc) Health talk.			
10:45	9:45	8:45	7:45
KHJ (405.2m-740kc) Health talk, Dr. Phillip M. Lovell.			
11:05	10:05	9:05	8:05
WCCO (416.4m-720kc) Traffic safety talk.			

Friday, March 12			
Eastern 3 p. m.	Central 2 p. m.	Mountain 1 p. m.	Pacific 12 n.
KMA (252m-1190kc) Travelogue, G. H. Van Houten.			
5	4	3	2
WCCO (416.4m-720kc) Readers' club.			
7	6	5	4
WOAW (526m-570kc) Music review, Hester Bronson Cooper.			
7:30	6:30	5:30	4:30
WBZ (333.1m-900kc) "Appreciation of Music," Prof. John A. O'Shea.			
7:45	6:45	5:45	4:45
WTIC (475.9m-630kc) "The Investor's Problem," Wilbur Sherwood.			
WMAQ (447.5m-670kc) "What We Hear in Music," Mr. and Mrs. M. E. Oberndorfer.			
8	7	6	5
CNRT (356.9m-840kc) Address, C. R. Moore.			
WCAL (336.9m-890kc) "Wives," Dr. George Weida Spohn.			
WTIC (475.9m-630kc) "Up in the Air," Harry D. Copeland.			
8:15	7:15		

Radio Digest

Illustrated

Reg. U. S. Pat. Off. & Dom. of Canada

Published by the
RADIO DIGEST PUBLISHING CO.,
(Incorporated)510 North Dearborn Street
Chicago, Illinois

Telephones: Superior 7323, 7324, 7325, 7326, 7327

E. C. RAYNER, Publisher

Eastern Office, Park-Lexington Building, 247 Park Ave.,
New York. Telephones: Ashland, 8144, 8145, 8146

Member of the Audit Bureau of Circulations

241
PUBLISHED WEEKLY

SUBSCRIPTION RATES

Yearly in U. S. and Possessions and Canada, \$5.00
Foreign postage, \$1.00 additional. Single copies, 10 cents.

Vol. XVI

Saturday, March 6, 1926

No. 9

A "Step" On the Air

THE PRESENTATION of the especially written story, "A Step On the Stairs," as a weekly serial Radio play, concurrent with its appearance as a serial mystery story exclusively in Radio Digest, marks a new step in the development of broadcast entertainment. Fifteen of the country's leading broadcasting stations from coast to coast are giving their listeners the broadcast dramatization.

This project enables Radio receiver owners not only to listen to a play prepared by a recognized Radio playwright from a story written especially for Radio dramatization by a famous author who understands the problems of the broadcast play, but to read that author's story simultaneously with or just previous to its performance over the air.

By this ingenious device listeners are able to visualize to perfection the action taking place in the various episodes of the serial Radio play. And, unlike many motion picture scenarios, written from magazine stories or novels, which are often difficult for the motion picture audience to even remotely associate with the original stories or novels, the Radario of "A Step On the Stairs" will follow very closely the installments as they appear in Radio Digest.

We are quite sure our readers will appreciate this excellent effort of Robert J. Casey, the author, and will also thank Fred Smith, in whose hands the Radio dramatization is placed, for his good work. Radio Digest hopes, by this initial project, to make popular a new form of broadcast entertainment, and begs that this publication receive comments from listeners and readers who read and tune in "A Step On the Stairs."

Better DX Is Assured

DURING the last part of January and the first few weeks of February, Radio reception has suffered from a "magnetic blanket," as it has been termed by the bureau of standards. We all know that distance, or DX, reception has been very poor for about a month. We are glad to know, however, that the "blanket" has lifted.

As mysteriously as when the "blanket" first made its appearance, nature has removed this atmospheric phenomenon. No one knows whence it came. No one knows whither it has gone.

The bureau of standards experts report that similar magnetic blankets have occurred before. The government scientists are attempting to learn exactly of what the phenomenon consists, and to prescribe a remedy if such is possible. Little progress was made during the last occasion, but it is hoped that before another "blanket" makes itself felt, more will be known about the cause.

With the cause of such extraordinarily poor reception removed, listeners may count on excellent Radio weather during March and April.

Telephone Is Fifty Years Old

JUST fifty years ago, on March 10, 1876, Alexander Graham Bell had his first successful telephone conversation. He was speaking to his laboratory assistant. The technical aide reported that he understood perfectly what had been said.

Just fifty years ago!

In that brief span of years the telephone has become an essential part of modern business and society. Imagine doing without it.

Remember—this remarkable fifty-year transition has turned a slow-moving, letter-writing, message-sending world, into one in which snap judgments, instant cross-continent conversations and hurry are the order of the day.

What is more wonderful, the Radio telephone has been perfected to its present state in practically the last eleven years. With Radio telegraphy and the wire telephone invented and developed almost together, it was the work of Lee De Forest which made possible the combination of the two—and gave Radio telephony.

Let all loyal Radio listeners pause for a moment on March 10 in honor of the invention of Alexander Graham Bell.

RADIO INDI-GEST

The Spirit of the Radio

Four walls encompass me about
My door is locked within;
I vainly try to shut without
The world's dischordant din.

But silence presses.
One can't long endure
The murmur of insistent longings
That surge within, thronging
With human stresses.

The dial—Eagerly I reach it;
Turn it. A lilting song
Comes to my ears. A bird-like flute.
Gone are my fears of that silence
That has made men mad.

Music fills my room making it an enchanted place
Of Sun-lit gardens, fragrant with June roses
And vibrant with the soft murmur of the honey-bee
As it flits busily through sweet-scented space.

Again, a haunting melody fashions anew
My vagrant fancy and I wander 'neath dripping trees,
While rain-washed fronds of tender ferns
Make lush my heart with ecstasies.

Walls may encompass me about,
And one may lock one's soul;
But walls, nor locks, can't keep without
The Spirit of the Radio.

GENE BROWN

No Can Do. Hari Kari More Better

Hon. Indi-Gest: You make column by week, 10 sens, which read good. Soonly I buy big set, many tube, cost plenty. Hear nice talk-talk. Make Jap boy feel good, feel thanks. Some tell whoziz. That fine. Some play-play—talk-talk—never tell what place. What suchly make by thus? Seemly got sense, No?

Hon. Indi you say get DX. That good too, but many time get only one DF. In Jap land those fool get head cut off. Why no here? I ASKU

Did You Use Spaghetti Coil?

Deer Meester In Da Chest: Lassa wik I tuna a stajzion wat sounda lik mi Italia. De maka da selekt O Sol Mio ana Sos Ole Man. Tha bambino watta singa dis song sounda just lika mi leetle Rosee wat liv in Milano. Mi broter Tone he sitta besida me wile I tun de Radjo ana he can verifizeca dis announcere say WOP. Kinlie in futurish In Da Chest letta mi no if thees realla wuz WOP. I finem betweena da hors tenna tirty ana tenna forta fi. Hava yur peepel sen me certifiat of verifacaze so can hang em up in parlo. So can sho freens dat donna belevee I got. Mucha blige. RADJO JO

Speak Up, Chile

I'se got a kick a-comin, udders say I'se right;
I gits so awful mad, I jus a-wants to fight.
I tunes in a stashun, I hears a good ol' song;
De name uv de stashun, I hopes to hear fo' long.
De song am dun over, de banjo, it now play;
De name of de stashun I ain't a-heard him say.
But gee, dey starts a-playin annuder tune I hear
De man wot call de stashun dun a-sleep in his chair.
Guess he think it funny ter hold us in suspense,
Or maybe he is thinkin his voice will give offense.
I hopes de guy will listen to dis plea from all,
An when the musick stops, give us de stashun call.
ZED

Without a Leak

THIS WEEK'S NOMINATION FOR MEMBERSHIP IN THE "FAMOUS FANS" CLUB IS NOAH, BECAUSE HIS "ARK" COULD HANDLE ANY WAVE LENGTH.

Hurrah! Hurrah! Gonna Have a Band

Fairice, Alaska.

Editor Indi-Gest: I would have written this letter with a fountain pen but as the ink is froze I will half to use a pencil. I want to let you know that the Third Trombone Plair has not got a thing on me when it comes to using a musikal instrement. I sling a wicked Kittle Drum myself. The last time I played was before the King of Siam and he said that he never wanted to here any other Kittle Drum as long as he lived. LAST night while nine Eskimos were listening to WJAX the annownser got so het up telling abowt the wether down there that the Eskimos got all up a swet and took cold with newmonya. Always as ever,
KITTLE DRUMMER

Some Say He Is Ambitious

Dear Indi: Fame will come to the great. I just couldn't help it. Now I can no longer be a quiet, unobtrusive soul; nor can the things that please the common people be publicly accepted as entertaining to me. Did you see where the winner of the prize Radio drama contest sponsored by WLS called his play. "The Night Herd?" It isn't about me, but a lot of my ardent admirers will go on thinking it is just the same.
THE NIGHT HERD

Looking Ahead

In a Near Issue We Will Explain Our Call Router. A microphone placed in the Union depot, picks up the spiel of the train caller and the Call Router broadcasts it so that the names of the different cities will go out and tag on the end of programs from those cities. In this way it will be impossible for announcers to keep their identity a secret.

The Mystery Is Solved

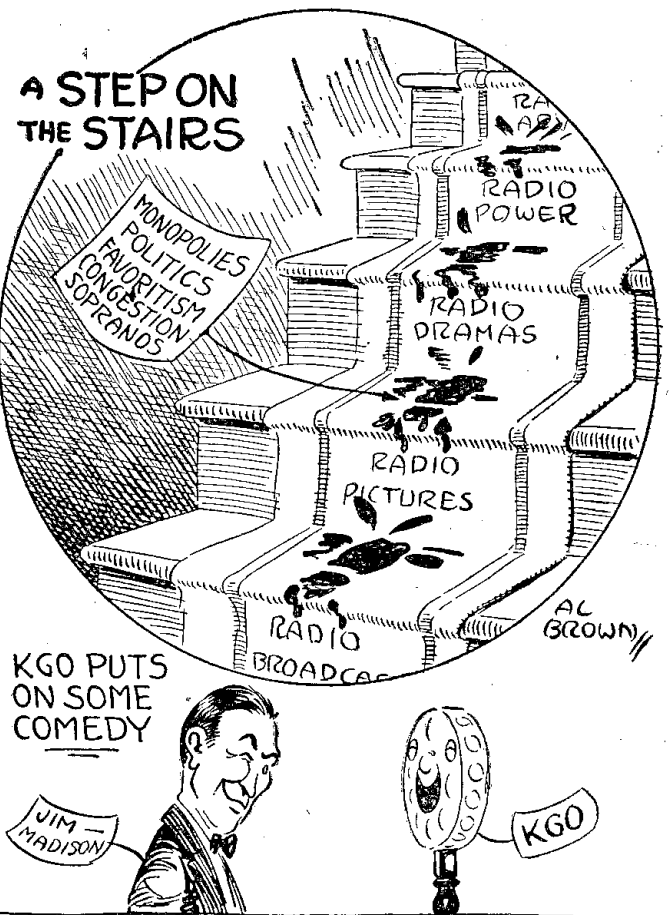

Condensed

BY DIELECTRIC

Sopranos are redeemed for Radio—at least if they can charm as did Miss Marion Talley, whose debut as a 19-year-old grand opera star at the Metropolitan, New York, was followed two days later by a Radio debut on the Victor hour of music over WJZ. Miss Talley is an American product and the proud daughter of Kansas City. Her success on the air was even more marvelous than her success before the critical Knickerbocker audience. She sang first "Caro Nome" from "Rigoletto," the aria which brought her twenty curtain calls in the old Metropolitan. There were three other numbers. Her whole range of tone to the highest trills was pure, sweet and practically faultless. Radio fans on all sides have concurred with the critics in praising the achievement of this slip of a girl. Much credit, however, is due to the engineers at WJZ for the excellent control and modulation. It may be the operators, after all, will find the real ultimate redemption of the sopranos for Radio.

One attribute every musical entertainer should develop is variation. Variation in phrasing, tempo (tempo rubato), tone coloring and character of song, each of these is essential to maintaining interest. While listening to a male quartet singing before the mike in the studio of WWJ, Detroit, one or more of these "essentials" were absent. The voices were good individually and the quartet harmonized, yet they became rather tiresome for the sole reason that this variation was not in evidence.

To us provincials who have never been outside our native hamlet, a travelogue bears much of interest. It helps us to know what folks do and what their buildings and streets look like without spending cold cash to see first hand these distant lands. I'm all in favor of the travel talks as given from a number of our broadcasters, though some tour leaders are more entertaining and informing than others—naturally. Where the music accompanying these travelogues is taken from native compositions, it no doubt creates something of an atmosphere. WOC, Davenport, presented a very interesting travelogue a short time ago.

If you suffer an overdose of heavy features from any of the broadcasters just turn to WSBC, the World Battery station, Chicago, and let them give you an evening of lively fun. Andy sang the other night. I don't know the gentleman's last name, unless its Caruso. He had a wonderful time of it, so much so that it became infectious among his auditors.

Did you ever notice how the balmy air of southern climes tends to incite to slow, dreamy dance melodies? The other night I moved about from station to station while dance music was flourishing to see how they differed, if at all. While remaining among the northern stations most of the numbers were moving along at a fair rate of speed, but as the southern stations came in, particularly WMBF, Miami Beach, the effect noted above was apparent.

Probably the only way in which we Americans can listen to the broadcasting of foreign stations, at least for some time to come, is by the aid of our own powerful broadcasting stations picking up the signals and rebroadcasting them. The main drawback to those attempts made in the past has been lack of advance notice. We never knew when to expect such a feature. The other night, while tuned to Station WJZ, New York, the announcement suddenly came through the air that we would be permitted to listen to a rebroadcast from England.

ABC Radio Fundamentals for Everybody

Chapter IX—Radio Receiving Circuits

By Milo Gurney

RADIO receivers, if one is to believe the tons of type describing them, consist of some hundreds of circuits—yet, if you prefer to believe me, I can assure you that the entire number which I have seen described, are possible of duplication through using the fundamentals of some six circuits.

Putting a wire here which was there, does not constitute a new circuit nor does it employ a new principle. I only desire to caution the purchaser of a Radio receiver to lend an attentive ear to him who

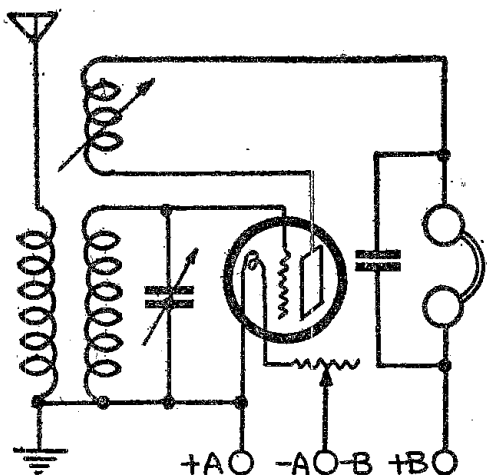

Figure 21

points out new refinements, rather than to him who insists that the receiver employs a new circuit.

Possibly the most efficient Radio circuit, tube for tube, is that known as the regenerative. It also easily steps into first place as the most persistent squealing offender, to make the night air home-like for the screech owl. In fairness, it should be stated that, when handled or tuned by one who understands its viciousness, it will not bother anyone. The great fault lies in the public's determination not to be taught how to tune and lack of consideration for neighbors. One perfectly good oscillating regenerative receiver can

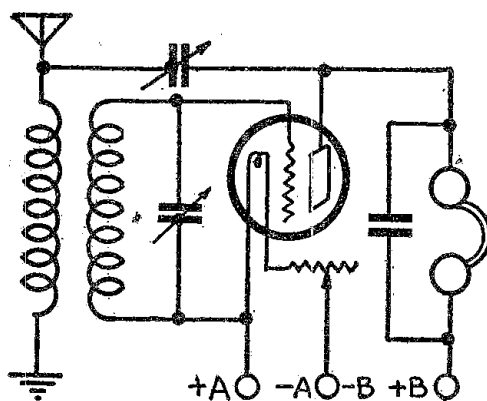

Figure 22

spoil reception for more neighbors per square mile, when improperly handled, than a flock of others which I might mention, yet to omit the description of one or two types of powerful distance getting regenerative receivers from this series would be unfair to its completeness.

Value Not Increased

In order to better understand what is meant by regeneration, as intentionally applied to a receiving circuit, please recall, if you will, my earlier explanation

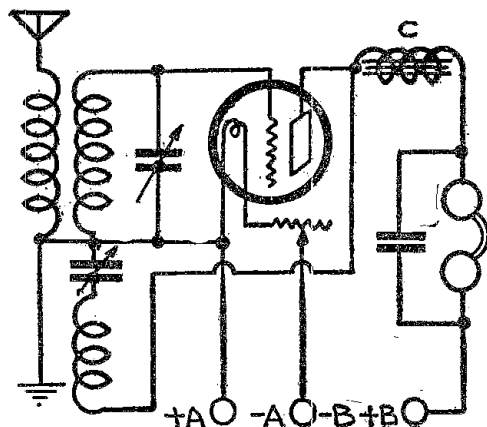

Figure 23

as to how a vacuum tube functioned. In a simple vacuum tube detector circuit, only the audio frequency pulsations of the space charge were made to actuate the head telephones or loud speaker, entirely eliminating the use of the radio frequency pulsations. In a regenerative receiver, advantage is taken of the radio frequency current, through feeding it back from the plate circuit onto the grid or input circuit. This, in effect, reinforces or strengthens the incoming signal which is applied upon the grid, and in a most practical though perhaps little understood manner. In reality, it cannot increase the received

signal which reaches the tube, as such signal is of a definite value and unchangeable after reaching the detector. You who are of Radio experience read very carefully from here on. Whatever the original value of the signal impressed upon the secondary of the detector, it cannot be increased except in one manner or method, and that is through lowering the resistance of such secondary. Ohms law steps in and says "No," and the Noes have it. Therefore, the effect of regeneration does not in any manner increase the value placed upon the secondary, as many writers have contended, but does tend to lower the resistance of the secondary in order that the full value of the impressed voltage may reach the grid.

This point is well worth remembering, because it is maddening to hear and read so often that regeneration is but additive; and the answer is, or rather the question is, "additive to what?"

Three Ways of Feeding Back

This feeding back may be accomplished in several ways, all using but two prin-

ciples, which are capacitive or inductive feed back, or their combination.

Figure 21 indicates a standard regenerative receiving circuit using the tickler or inductive method of regeneration. Figure 22 shows a like circuit using capacitive feed back, while figure 23 pictures a combination of the two. Of the three methods shown, the writer is of the opinion that figure 23 represents not only the most efficient method to employ, but also the one which permits of the greatest flexibility and fineness of control.

To those of you who have built either the tickler feed back circuit, or the combination capacity and tickler circuit, a word of advice may be of material help. This covers the construction of the tickler coil, which in no case should exceed one-half the diameter of the secondary. By this I mean that if your secondary is wound upon a three-inch form, then the tickler should be wound upon a one and one-half inch form. Put this hunch in your mental note book. It's well worth remembering.

The circuit shown in figure 23 and which I favor above all is the result of the work of one of Radio's most prolific inventors, Mr. Roy Weagant, and was introduced some years ago under the name of the Weagant X circuit. Properly constructed, it has the advantage of not changing the tuning of the secondary as the tickler is rotated, while the variation of its capacity element offers absolute control of regeneration over the total wave length range. The coil shown at "C" in the drawing, in no way affects the operation of the circuit but is a most desirable method to employ for the keeping out of the radio frequency currents from the telephone circuit.

It is of unusual interest to those who are becoming enthusiastic over the possibilities of reception at extremely short waves, of the order from 40 to 130 meters, that the Weagant circuit is favored by most constructors in this field. In fact, Radio Digest in its present series of "How to build" articles, covering short (Continued on page 24)

Genuine Fansteel Balkite Battery Charger

Only \$1.00 Down

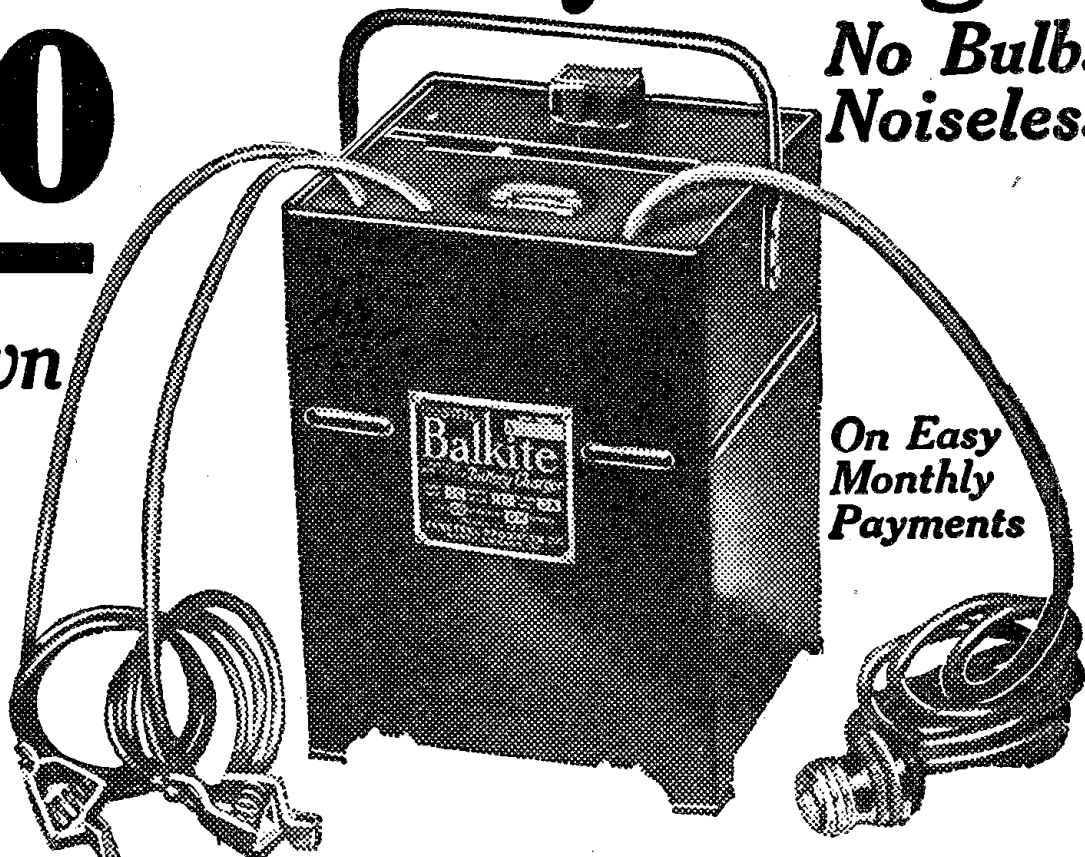

No Bulbs
Noiseless

On Easy
Monthly
Payments

Radio Fans! Auto Owners, too! You may now own a Genuine Fansteel Balkite Battery Charger on a most amazing, easy payment offer. The famous Balkite is acknowledged the most efficient, the most fool-proof and trouble proof storage battery charger on the market. No tubes, no bulbs and no noise. Will charge your battery while using your radio. To get the most efficiency and greatest enjoyment out of your radio, you need the Balkite Battery Charger in your home. And, on this offer, we'll send it to you for only \$1.00 with the coupon on

30 Days Trial

The Balkite comes to you completely wired, ready to attach to your light socket and battery. No extras to buy. Use it whenever necessary for 30 days. See how much it adds to the convenience and enjoyment of your radio. See how much it saves in battery charging cost. See how simple and easy to use. After 30 days trial, if you're not convinced that you need the Balkite Battery Charger, send it back at our expense and we'll refund your \$1 plus transportation charges.

\$2.50 a Month

If you decide to keep the charger, start making the small payments of only \$2.50 a month until you've paid the total price of only \$19.50. That's the price others ask for spot cash. We give you the lowest cash price on easy monthly payments you'll never feel. The money you save in charging your battery at home will almost take care of the payments on this offer.

For Radio and Automobile Batteries

The Balkite Battery Charger is based on a new principle, the use of "Balkite" a rare metal developed for this purpose. It will charge the ordinary 6 volt radio "A" battery or automobile battery from 110-120 AC, 60-cycle current. It will also charge radio "B" batteries of the lead type without added attachments in multiples of 6 cells.

No Bulbs—Noiseless The "Balkite" metal changes the AC current, commonly used for lighting, to the DC current necessary for charging batteries, without the use of fragile bulbs or vibrators. This makes operation practically devoid of any disturbing hum or noise of any sort.

Easy to Operate The Balkite delivers a taper charge and cannot damage the battery by overcharging. Cannot discharge or short circuit the battery. It will charge even a completely discharged battery. It cannot fail to operate when properly connected to the battery and line current. Is unaffected by temperature or fluctuations in the line current. It is simple, efficient and indestructible. Has no contact points, bulbs, vibrators or moving parts. Cannot deteriorate through use or disuse. Requires no attention other than filling with distilled water. Has nothing to adjust, break or get out of order.

Operates While Using Radio The Balkite can be used while the radio set is in use without affecting the set or its operation and without disturbing noises. Its operation does not create disturbances either in your set or your neighbor's.

Charger comes completely wired, ready to attach to your electric light socket and battery. No extras to buy—no fuss, no delay. Measures 8 inches high, 6 inches wide, 6 1/2 inches deep. Shipping weight about 22 lbs.

Order by No. Y8306NA, \$1.00 with coupon; \$2.50 a month; total price, \$19.50

Send Coupon NOW

Don't miss this opportunity to get the famous Balkite Battery Charger at the rock bottom cash price on small monthly payments. Send only \$1.00 with the coupon now, while this offer lasts. No risk. No obligation; 30 days' trial, then decide. And you are always protected with Straus and Schram's money-back guarantee of satisfaction. Send now.

Straus & Schram, Dept. R4413 Chicago

STRAUS & SCHRAM, Dept. R4413 Chicago

Enclosed find \$1.00. Ship special advertised Balkite Battery Charger. I am to have 30 days free trial. If I keep the charger, I will pay you \$2.50 monthly. If not satisfied, I am to return the charger within 30 days and you are to refund my money and any express charges I paid.

Balkite Battery Charger, No. Y8306NA, \$19.50.

Name _____

Street, R.F.D. or Box No. _____

Shipping Point _____

Post Office _____ State _____

ABC'S OF RADIO SETS

(Continued from page 23)

wave receivers, uses this circuit, modified only in the value of the inductances and capacities used.

In succeeding articles, each type of receiving circuit, not excepting the super-heterodyne, will be discussed and explained. However, in concluding this article, it seems essential that I again repeat my oft-written statement that, "Regeneration cannot precede, but must always follow amplification."

All Sets Regenerate

It must follow this formula and no other. If you accept this contention, which can be supported by positive proof, it is then but obvious that all Radio receivers, irrespective of type, style, name, make or kind which use vacuum tubes capable of oscillating are regenerative. They of necessity must be, and it is absolutely impossible to construct a Radio receiver which does not, or is not capable of regenerating, so long as the tube can oscillate.

This statement is made with force, be-

cause many believe that their particular receiver does not regenerate. But, in truth, those which do not—just hain't made. Devices are available and receivers are constructed which reduce such interference to a point where, with careful tuning, little disturbance is caused. Again, the market is now offering receivers which practically block such oscillations from reaching the antenna, but they are few and far between, as is evidenced by those who listened for Europe recently.

Each of you should learn how to tune properly, so that your receivers will not break into oscillation. I made a careful count of squealers during the recent transatlantic tests—or whistle competition, but gave up in disgust after counting to a million.

Verily, verily, I say unto you, "Please learn 'How to Tune.'"

(In the next issue Milo Gurney takes the reader into a discussion of radio frequency amplification, both tuned and untuned. The untuned variety came first, was displaced by tuned radio frequency and now we have them separately and in combination.—Editor's Note.)

HILL BILLIES AT WRC

(Continued from page 5)

Last summer the gang picked up another Hill Billy who has greatly increased the prestige and power of this combination orchestra-choral society. Charles Bowman, known all over the South as "Fox-Hunt Charlie," happened to hit Mountain City, Tenn., for a fiddlin' contest, at the same time the Hill Billy bunch struck town. Charlie lives in a log cabin back in the hills, ten miles from Mountain City, and he just came down to town for the purpose of snatching a few loose prizes in the exhibitions of old-time fiddlers. The Hill Billies grabbed him at the first showing, and he grabbed the Hill Billies. They all talked the same language, played the same tunes, and no rehearsals were needed to break in the new trouper. Charlie plays any ding-busted stringed instrument that is or can be, with the possible exception of an Irish harp, which hasn't sufficient volume to interest him. He does mean things with a banjo; a guitar is more easy meal to his grist, while the fiddle—he actually makes a fiddle sit up and bark. His piece de resistance, from which his nick-name is derived, consists in imitation of two houn' dogs chasing a red fox through the Tennessee hills. Charlie also fiddles his way through a barnyard selection, introducing the cacklings of the fowl, from turkey gobbler to bantam hen.

When they aren't on the road, the Hill Billies melt into the ordinary industrial lives of their communities like the snows in spring. Albert and Joe Hopkins are salesmen; John and Elmer are first-class mechanics. Alderman is a motion picture camera man. Bowman paints barns and houses or what-have-you. All of them are highly intelligent, excellent appearing young men.

They can pull the innards from an automobile, build a Radio set, or grace a drawing room. They can sing a negro spiritual to suit the longest-faced deacon, or they can turn it into a "can't-keep-still-your-foot" country dance. They can wield a double-bit ax or pick a pianissimo. Al rumbles a deep bass lead in "Get Away, Jordan," and jumps to a Tyrolean yodel in "Sleep, Baby, Sleep." If John gets tired of singing baritone in the quartet he just grabs Elmer's second tenor part, and Elmer can shift to baritone or get out of the race. Bowman and Alexander present a stunt in which each bows the other's fiddle and fingers his own.

Some evil day one of the boys is going to pick up a loose saxophone, take ten or fifteen minutes to learn to play it, and the party will be ruined. Heaven postpone that day, for when the sax supplants the mouth harp and the trap drummer drowns the banjo (one string at a time, if you please) America will lose an organization that represents all that is best in the music of its hills—the real simon-pure "leider" of our country.

EXOTIC CHARM OF PWX

(Continued from page 4)

development of Cuba, by arousing greater interest in the island abroad, and by educating other parts of the world in the cultural and economic progress of that corner of Spanish-America. A telephone company represents national progress, and should contribute whatever it can toward that end. The commercial welfare of any community is important to the telephone system serving it.

Another result of the broadcasting of PWX is to familiarize the audiences with personal communication over long distances even into foreign lands. It stimulates the imagination of the public to contemplate the many possibilities that lie in the science of projecting the human voice through vast space and over long stretches of wire. Thousands of miles mean little today in the art of conversing between persons. It helps to drive home the fact that the telephone, in its present

state of development, is capable of reproducing the most delicate tones and inflections of the voice, be it a wired or wireless telephone, and that it can serve as the Magic Carpet in bringing a person across seas and continents to the side of those who would talk with him.

But, primarily, PWX was established because of the desire to investigate and study this new means of voice transmission without the aid of wires, and to learn what its usefulness might be in the art of telephonic communication. It has possibilities for usefulness where it is not economical or practical to string wires or submarine cables, and for maintaining communication between moving stations. In the study of this problem, PWX has been useful not only to the company owning it, but to the science as a whole.

PWX has played a part in several notable feats of Radio and telephony. At one end of a telephone circuit more than 5,000 miles long, the station participated in the world's first demonstration of a trans-continental conversation being broadcast by Radio so that persons all over North America might hear the words passing over the copper wires that stretch from Havana, below the tips of Florida to San Francisco, California. General J. J. Carty, vice-president of the American Telephone and Telegraph company, from the banquet hall of a Chicago hotel on February 8, 1924, called the roll of twenty cities along the circuit from Havana to the Pacific coast, and as each city answered on the telephone circuit, the response was heard not only by the banqueters but also by the millions who were tuned in to any one of seven Radio stations, along the route, connected with the telephone line. F. T. Caldwell, chief engineer of the Cuban Telephone company and Henry G. Bates, general commercial manager of the Pacific Telephone and Telegraph company, held a conversation from Havana to San Francisco, and musical selections were exchanged between the two cities separated by the United States while PWX and the other Radio stations let Cuba and America listen in.

When President Machado of Cuba visited New York in April, 1925, at the time he was president-elect, he was banqueted at the Hotel Astor by American business men. In order that his countrymen might hear his speech and the reception accorded him in America, a telephone circuit linked the banquet hall with PWX at Havana. Every word of the president-elect's speech and the thunderous applause accorded it could be heard by the Radio audience in Cuba. Station WOR of Newark also sent the president's remarks out on the air for Americans. Many letters of appreciation and thanks were written by Cubans to PWX for that evening's broadcasting of a New York banquet address.

Spaniards everywhere celebrate the birthday of His Majesty King Alfonso of Spain. Each year the Spanish Casino in Havana is the scene of such a jubilee. The Radio fans of Cuba and North, Central and South America are able to share in the birthday party through PWX, connected with the Casino by underground cables. The homes of Spaniards in a dozen nations have been added to the Casino party this way, so that they joined the audience hearing the music and speeches of the Spanish colony in the Cuban capital.

That the broadcasting and cooperation of PWX is appreciated by the Cuban government has been shown many times by official correspondence between the presidential palace and the Cuban Telephone company. One instance occurred sometime ago when a general strike tied up business in Havana. The president of the Republic issued a manifesto on the subject to the people of the nation. In order to give it quick and wide circulation, the Cuban Telephone company broadcast the proclamation from PWX.

The full amplifying efficiency of the tubes is never realized in a reflex circuit.

Big Price Reduction FULTONE LOUD SPEAKER FOR YOUR PHONOGRAPH

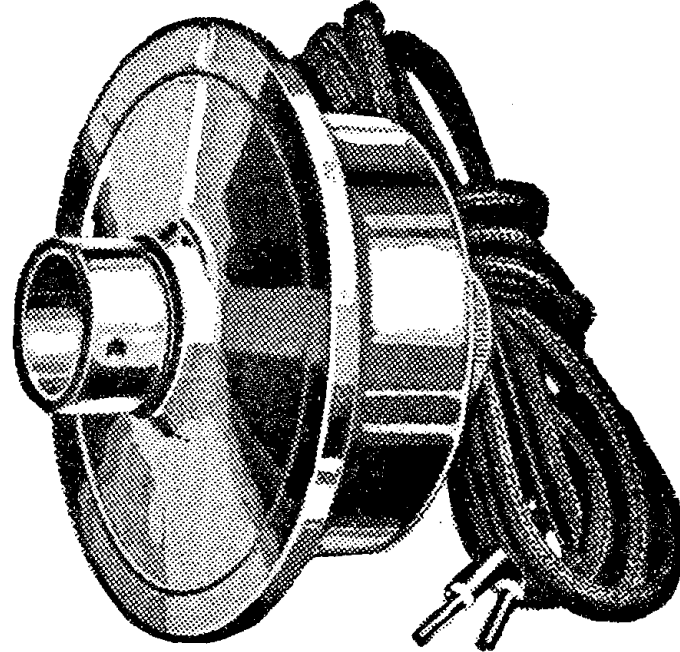

*Fits
Any
Make
Now
Only
\$3.00*

Fultone
Trade Mark
LOUD SPEAKER UNIT
\$3.00

The unit will be shipped on a satisfaction or money back basis on receipt of price in money order or currency.

This unit is the secret behind the unparalleled success of Fultone Speaker. Its large diaphragm and bobbins of fine wire are protected from injury by a heavy nickel-plated case through the back of which adjustment is made by means of a special key. The pole pieces are not made from a solid piece of iron but are assembled from 15 laminations of carefully chosen steel.

Use on Your Phonograph

- Edison Adapter 25c
- Columbia or Pathe 20c
- Brunswick 30c

Fultone
Trade Mark
THE FORD of LOUD SPEAKERS
\$6.50

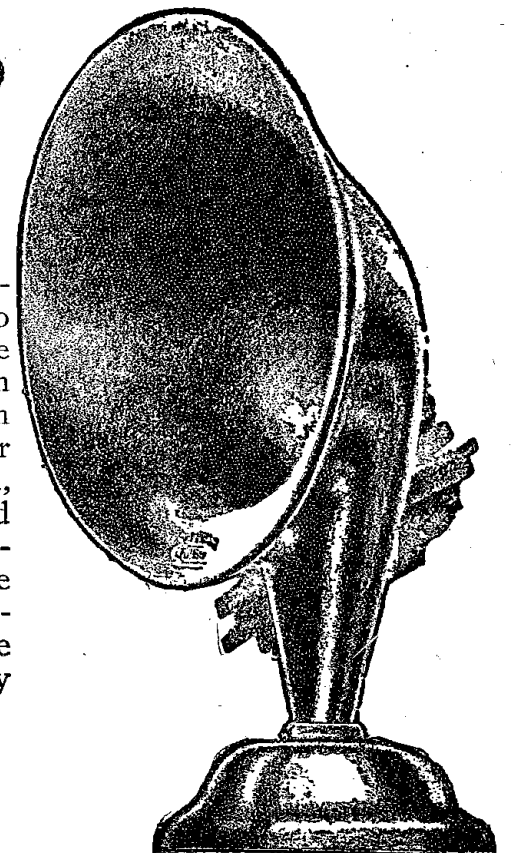

Fultone Loud Speaker has conclusively proven to the radio world that a reproducer could be made and sold at \$6.50 which would handle music or speech in volume as perfectly as any speaker at any price. The horn is solid, non-ringing and wide-throated enough to handle the powerful reproduction from super-heterodyne or reflex. The adjustable diaphragm permits matching Fultone to any receiver and "B" battery voltage.

HALL & WELLS, Inc.
4600 Lincoln Ave. Chicago, Ill.

Tear Off, Fill in, Mail Now

HALL & WELLS, Inc. 4600 Lincoln Avenue, CHICAGO, ILL.

Enclosed is \$..... for which ship me () Fultone Speaker
.....() Fultone Unit at once, my money to be refunded if I am not satisfied and return this merchandise within 5 days.

NAME
ADDRESS
CITY AND STATE.....

How to Stop Blooping and Man-Made Static

Part IV—Construction of the Penetrola

By the Technical Staff

IT WAS promised in earlier chapters of this series that the construction of a unit to be placed between the antenna and the set for the prevention of blooping would be given. Now this unit is unusual in that, in addition to preventing your radiation, it will reward you for its installation with increased selectivity, range and volume. There has long been a demand for such a unit and many have appeared on the market from time to time but none of them completely and satisfactorily solved the problem. In many cases, the use of such devices necessitated changes in the original receiver; in others, they merely added to the present difficulties in operating the receiver because they made it unstable.

Can Be Used on Any Set

Penetrola is built around the Isosfarad circuit which is one of the balanced bridge arrangements shown last summer by Milo Gurney in his series on radio frequency improvements. It is made in such a way that it can be used with any receiver; non-regenerative, regenerative, tuned radio frequency, neutrodyne or super-heterodyne. It will increase the selectivity of any receiver and make it possible to tune in distant stations loudly and clearly in spite of local interference. It will stabilize a set and make a ticklish one easier to handle. It is presented in this series, however, because it acts as a uni-directional or one-way repeater, allowing energy from the antenna circuit to be applied to the set proper, but not permitting energy from the circuit to be radiated in the form of squeals over a wide area.

The front view is shown here as figure 6 and the front panel measures 7 inches by 10 inches. It is the same height as your receiver panel and adds to, rather than detracts from, the set's appearance. The circuit is shown in figure 7. The input coupler consists of two special coils wound on insulating tubing with proper regard for spacing of turns and separation of primary and secondary. When a

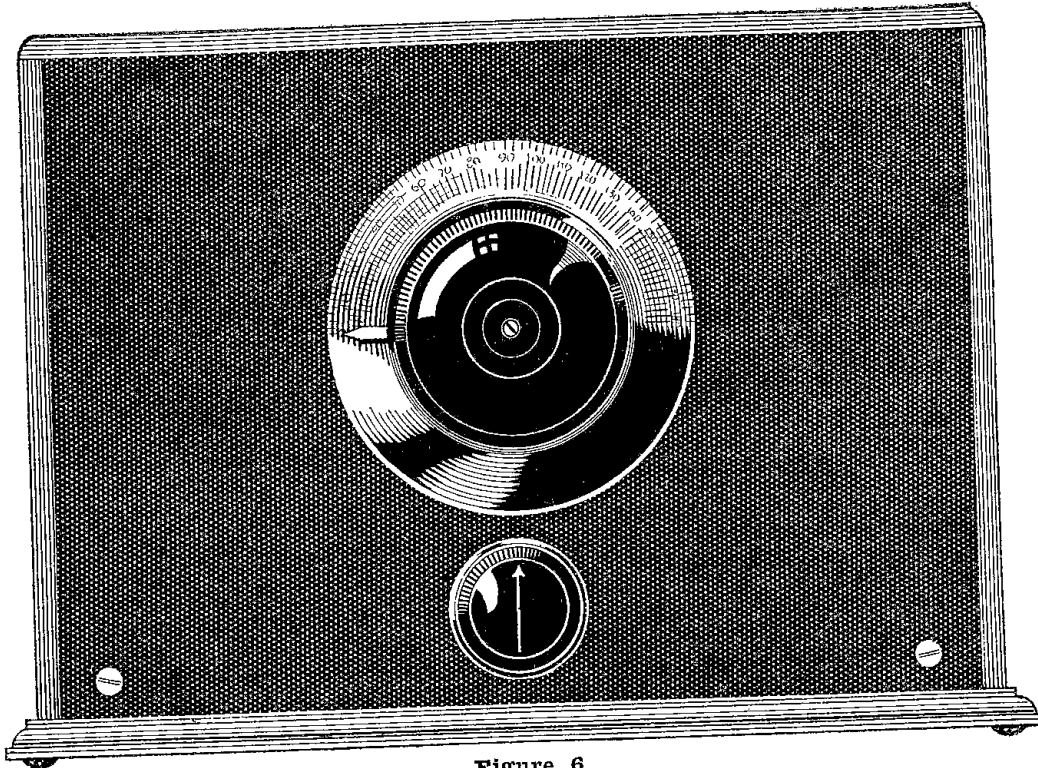

Figure 6

long aerial is used, it is to be connected to the tap on the primary, while, if a short antenna has been erected it goes to the end terminal of the coil. The two coils are contained in a copper can with the result that they have all the power of solenoid type coils and the non-spraying qualities of the toroid type coils.

Gives Equal Amplification

It will be noticed that a special type of tandem condenser is used across the secondary of this input transformer. The two rotors and stators are not identical in size. One has more plates than the other. This feature gives the entire unit equal amplification over the wave length range, rather than a falling off on the upper end of the scale, as is usually the

case in a stage of tuned radio frequency. Unbalancing of the circuit, once the small balancing condenser has been set on some wave length, is also prevented. The output circuit contains a tuned radio frequency choke which diverts the radio frequency energy through the condenser and to the upper output terminal rather than permit its flow through the B battery to get back to filament. That condenser at the upper output post is to keep the voltage of the B battery off the grid of the succeeding tube. Negative B connection is made automatically through the A and B battery connections to the set.

The essential parts for this unit are

sold as a kit which contains the twin condenser, the canned coil, the output choke, the balancing condenser, the socket, brackets and a vernier dial. Full size drilling templates accompany this kit and it is only necessary to place the templates on the panel and sub panel, center punch with punch and hammer, and drill. You will need a 1/2-inch, 3/8-inch and number 18 drill; also a countersink. It is important that parts be mounted in the proper order as otherwise some parts will cover up the mounting holes for other parts. The brackets are first attached to the sub panel.

Installation of Unit

The supporting screw at rear edge is put on next, so that the underside of the sub panel is 3/8-inch from lower end of screw. The socket follows, care being

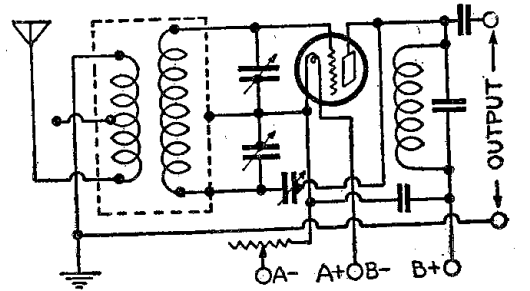
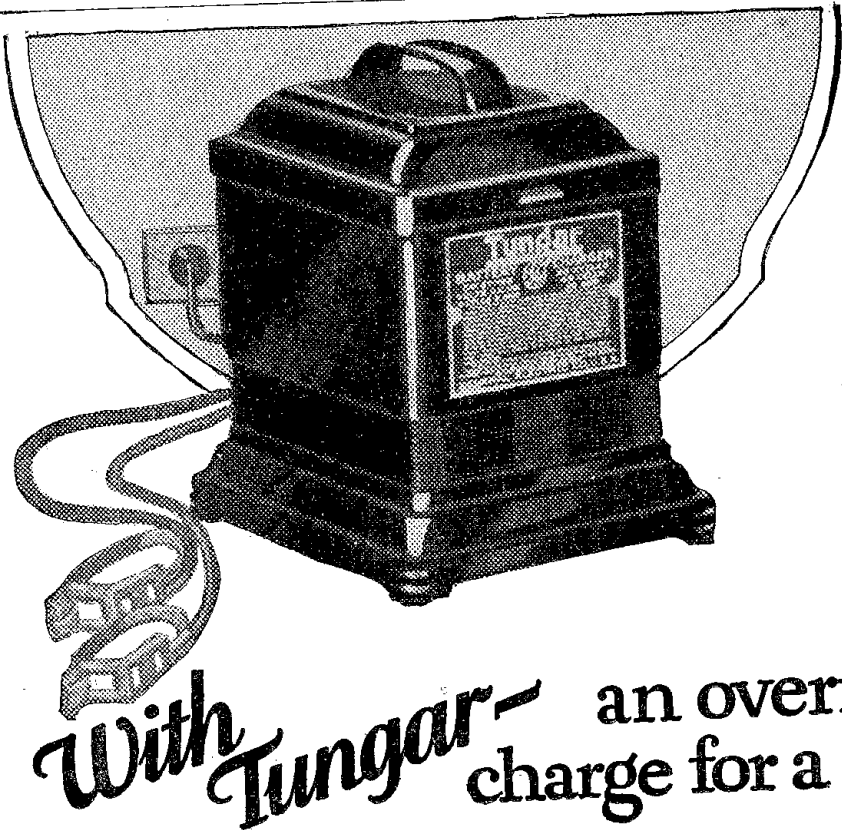

Figure 5

taken to get the terminals placed as shown. The output choke and the output blocking condenser follow. The order of assembly for the rest of the parts does not matter.

The wiring in picture form is shown in figure 8, which comprises a top and bottom view with wiring in place. Holes in the sub panel through which wires are run to connect terminals above the sub panel with those below have been lettered and it is easy to find the wire on either the upper or lower side.

(Continued on page 26)



With Tungar— an overnight charge for a dime!



It can't blow out Radiotrons if left hooked to set while charging.

Does not disturb radio reception in neighborhood.

It is complete—charges 2-4 volt "A" or 6-12 volt auto batteries, or 24-96 volt "B" batteries in series.

Especially adaptable to permanent installation in cabinet with switch control.

East of Rockies)
Five ampere size \$28.00
Two ampere size \$18.00
60 cycles - 110 volts

Merchandise Department
General Electric Company
Bridgeport, Connecticut

Two clips for your battery and a plug for your house current—that's all. And the steady, quiet Tungar charges your batteries overnight.

Just about a dime's worth of current and two minutes of work. So simple!

It's the no-fuss, easy-to-use charger—for all batteries.

Tungar

REG. U.S. PAT. OFF.
BATTERY CHARGER

Tungar—a registered trademark—is found only on the genuine. Look for it on the name plate.

GENERAL ELECTRIC



CHELSEA

Super-Five \$50

Genuine Tone Quality

THERE are no false notes in Chelsea. Regardless of price, the vivid, living tone quality of the new Super-Five is equalled by few receivers. Even sets costing two or three times as much fail to give you the clarity, naturalness and mellowness of tone that so distinguishes this remarkable set.

Hear the Chelsea Super-Five at Your Dealer's or write us for his name.

CHELSEA RADIO COMPANY
Chelsea, Mass.

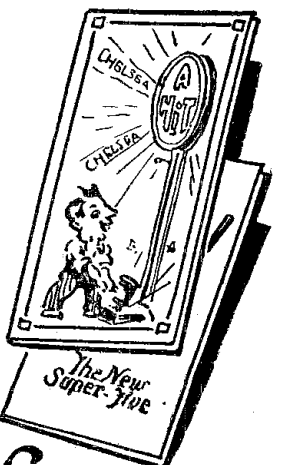

Send for these
Circulars

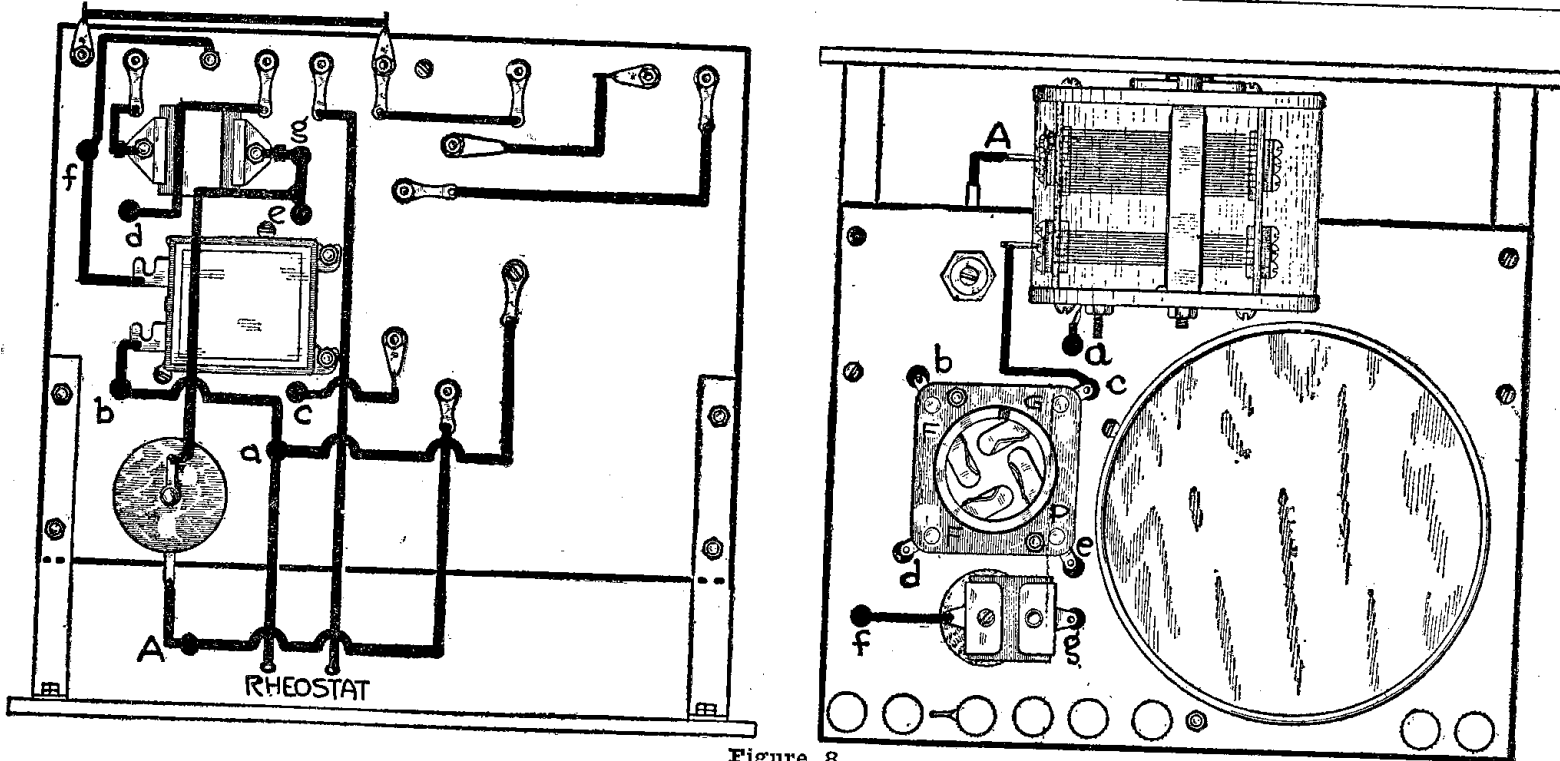

Figure 8

HELP STOP BLOPING

(Continued from page 25)

Although no connection has been shown in figure 8, between the metal shield around the input coil and the ground, it is important that the shield and one of the A battery leads be grounded. The reason that no connection has been shown is due to the fact that in most receivers one of the A battery leads is already grounded and the shield would automatically be grounded through its connection with the negative filament lead as shown. In some receivers the negative lead is grounded while in others the positive lead is the one that is grounded, so that grounding the shield directly, in this unit, might short circuit the A battery.

Grounding Penetrola

If your set is of the type in which the A battery is already connected with the ground post in your set, the grounding of the Penetrola A battery leads will take care of itself. If, however, your circuit

post in rear left corner. Balancing of the small condenser is carefully explained in the directions which accompany it and one cannot go wrong.

Will Prevent Blopping

There are probably many of our readers

who are not inclined to the construction of apparatus and we are glad to be able to advise that the Penetrola can be purchased completely assembled and wired, ready to use, from the makers of the kit, who are located at 937 Wrightwood ave-

nue, Chicago. The price is \$35.00 and it can be had in either black crystalline or wood finish. Penetrola, whether home-assembled or purchased complete, is positive insurance against blopping. In closing this chapter we must advise that the Penetrola, as described here is primarily for use on those receivers designed to operate from outside aerials. If your receiver is of the loop type, this device may be adapted to use with it through the use of an antenna coupler, the primary of which will contain 6 to 10 turns and the secondary 40 to 60 turns with the correct inductance value to work with the variable condenser intended to tune the loop. As a rule this condenser is of .0005 mfd. capacity and an Uncle Sam or Ambassador tuner is suitable.

Connect the output of Penetrola to the primary and use the secondary in place of the loop. Where three terminals are provided for a tapped loop, tap at the middle of the secondary of this coupler.

(Penetrola is about the only well-known commercial device to stop blopping. Next week this series will be continued with further devices for this purpose.—Editor's Note).

Enough electricity to illuminate ten 5-room homes is required, it is said, in operating a forty-foot electric sign at KOA, Denver, which represents the station's call letters. The sign itself is mounted on one of the two towers and is more than 100 feet above the ground. The letters are nearly ten feet high.

LIST OF PARTS

- 1 Penetrola Kit of Essential Parts
Walbert Mfg. Co., Chicago, Ill. \$15.00
- 1 Formica Panel, 7"x10"x3/16"
Formica Insulation Co., Cincinnati 2.40
- 1 Formica Panel, 7"x9 3/4"x3/16"
Formica Insulation Co., Cincinnati 2.00
- 1 Carter Imp Rheostat, 25-ohm
Carter Radio Co., Chicago 1.00
- 8 Eby Ensign Binding Posts
H. H. Eby Mfg. Co., Philadelphia 1.20
- 1 Cabinet, 7"x10"x9"
Walbert Mfg. Co., Chicago, Ill. 4.00
- 1 Dubilier, type 640, .01 mfd. Cond.
Dubilier Radio & Cond. Co., New York 1.00
- 1 Dubilier, type 656, 0.5 mfd. Cond.
Dubilier Radio & Cond. Co., New York .90

Note: Panel and sub panel may be purchased drilled from Walbert Mfg. Co., at price shown. Of the B binding posts, 2 are "Gnd," 3 are "Ant," and 1 each of "B Amp+," "A Bat+," and "A Bat-."

is of the type in which neither A battery lead is grounded to the ground post, you will have to take care of this as follows. Turn on your set so that all the tubes light up; take all the tubes out of your receiver. Attach one terminal of a voltmeter (do not use phones) to the ground terminal of the set and touch the other terminal first to the positive A battery binding post of the set and then to the negative A battery post. If there is no deflection of the needle in either direction when either of the A battery terminals are touched, then you know that neither A battery circuit is grounded. In that case, the two binding posts just to the right of the supporting screw at rear edge of sub panel are to be connected together.

If you do get a deflection in either direction, when one or the other of the A battery terminals is touched, then use the Penetrola wired as shown in figure 8, without connecting the posts mentioned.

It is a very simple matter to connect the unit with any receiver and operate the whole arrangement. The right end binding post connects to the ground binding post of your set. The next to it connects to the antenna post of set. The third post from right goes to plus 67 1/2 or plus 90 of the B battery. The next post goes to plus A and the fifth to minus A, of your filament battery. Connect your ground to the sixth post from right and the antenna to either binding



IPANA TROUBADOURS

Size Eleven by Fourteen Inches

Select Your Favorite from the Gallery of Radio Stars

- 1 Wendell Hall, king of ukulele ditties
- 2 Graham McNamee, 1925 Gold Cup announcer
- 3 Jack Little, popular wandering balladist
- 4 Paul Small, who won fame through Radio
- 5 Con-Sanders' "Nighthawks" at KYW
- 6 George Hay, 1924 Gold Cup announcer
- 7 Harmony Girls, Edith Carpenter, Grace Ingram
- 8 Ferd and Glenn, Lullaby Boys of WLS
- 9 "Roxy" Rothafel of WEAF chain fame
- 10 The Hired Hand, famous "Substitute Announcer" of WBAP
- 11 Britt and Finch, popular songsters
- 12 Bob Emery, Big Brother of WEEL
- 13 "Bill" W. G. Hay, ex-KFEX, now of WLIB
- 14 Happiness Boys, jovial singers of WEAF
- 15 Lambda Kay, "Little Colonel" of WSB
- 16 Leo Fitzpatrick, "Merry Old Chief," WTR
- 17 Henry Field, 1925 Gold Cup runner-up
- 18 Al Carney, organ favorite at WHT
- 19 Aunt Jane, ladies' adviser at WOC
- 20 Vincent Lopez, No. 1 Pennsylvania orchestra
- 21 E. L. Tyson, pleasing voice at WWJ
- 22 S. W. Barnett, ex-WOC, now at WBAL
- 23 Art Gillham, "The Whispering Pianist"
- 24 Paul Greene, announcer at WSAI, "bridge voice"
- 25 Harry Ehrhart, "Dream Daddy" of WLIT
- 26 Correll and Gosden of "Kinky Kids Parade" fame, at WEBB and other stations
- 27 Norman Brokenshire, popular at WRC, WJZ
- 28 Indiana Male Quartet, popular at WEBB
- 29 Jane Novak, Blues Singer of Twin Cities, WOCO
- 30 Jean Sargent, the original, now at WHT
- 31 Ralph Emerson, popular organist at WLS
- 32 Edna Adams, "Sweetheart of the Air" at KPRC
- 33 Pat Barnes, vaudeville announcer at WHT
- 34 R. V. Haller of KGW Hoot Owls fame
- 35 Henry L. Dixon, ukulele wizard of KYW
- 36 Quin Ryan, WGN's Uncle Walt and sports announcer
- 37 "Willie the Weeper," Ernest Rogers, WSB
- 38 Walter Wilson, "Uncle Bob" of KYW
- 39 Jack Chapman of Drake hotel Repute
- 40 Ray-o-Vac Twins, known country-wide
- 41 Art Linick, KYW's Mrs. Schlangenbauer
- 42 Fred Hamm of WTAS, now WLIB fame
- 43 Meyer Davis' Le Paradis orchestra of WRC
- 44 "Senator Schultz," WLW's illiterate comic
- 45 "Uncle John" Dagget of KHJ
- 46 D. R. P. Coats, 1925 Silver Cup announcer
- 47 Gene Rouse, WOAW's popular announcer
- 48 Freda Sanker, WKRC jazz orchestra director
- 49 Iris Ruth Pavey, KOA's invisible stage beauty
- 50 Quech Titania, star of KHJ Fairyland
- 51 Ipana Troubadours, on the WEAF Chain

If your favorites are not in this list, send in a request to have them included in the Gallery of Radio Stars.

Photogravures of Your Favorite Artists GALLERY OF RADIO STARS

Suitable for Framing or Placing in Your Album

By special arrangement, Radio Digest is able to offer its readers a great opportunity to secure fine photogravures of their favorite Radio stars at practically no cost.

Radio fans will be able now, by this very special offer, to have pictures of their favorite artists and announcers before them when they listen in.

All that is necessary to secure photogravures from the Gallery of Radio Stars is to send the coupon published each week in Radio Digest, accompanied by ten cents to cover the cost of mailing and postage. Where a series of three photogravures is desired, it will only be necessary to send twenty-five cents and three consecutively numbered coupons clipped from Radio Digest. Remittance must accompany each coupon. Cash at your risk. Add 5 cents to personal checks for exchange.

WITH COUPONS Only 10c Each—3 for 25c For cost of mailing and postage

COUPON NO. 11

This coupon entitles the holder to one photogravure selected from the Radio Digest Gallery of Radio Stars when accompanied by ten cents to pay the cost of mailing and postage.

Three consecutively numbered coupons entitle the holder to three photogravures when accompanied by 25 cents. Remittance must accompany the coupon. Cash at your risk. Add 5 cents to personal checks for exchange.

Order by Number.....
RADIO DIGEST PUBLISHING CO.
510 N. Dearborn St., Chicago

Radiophone Broadcasting Stations

Corrected Every Week—Part V

State	City	Call	State	City	Call	State	City	Call	State	City	Call	State	City	Call
Alabama:	Auburn, WAPI		Illinois (Continued)	WKBG, WLBB, WLS, WLTS, WMAQ, WMBB, WOK, WPCC, WQJ, WSBC, WWSW		Massachusetts (Continued)	Webster, WKBE		New York (Continued)	Flushing, W1BI		Pennsylvania (Continued)	Reading, WRAW	
Birmingham, WBRC			Decatur, WBAO, WJBL			Worcester, WCUW, WTAG		Ithaca, WEAI		Scranton, WGBL, WQAN		State College, WPSC		Wilkes-Barre, WBAX, WBRE
Mobile, WEBM			Evansville, WEHS		Michigan:		Bay City, WSKC		Kingston, WDBZ					
Montgomery, WBZ			Galesburg, WFBZ, WRAM		Berrien Springs, WEMC		Dearborn, WWI		Lockport, WMAK					
Arizona:	Flagstaff, KFNX		Harrisburg, WEBQ		Detroit, WCX, WGHP, WJR		Detroit, WCX, WGHP, WJR		New York, WBBR, WBNP					
Phoenix, KFAD, KFPC			Joliet, WCLS, WJBA, WKBB		WMBG, WWJ		East Lansing, WKAR		WEAF, WEBC, WFBI, WFRL, WGBS, WGCP, WHAP, WHN, WJY, WJZ, WLWL, WMCA, WNYC, WO K O, WQAO, WRMU, WRNY, WSDA					
Arkansas:	Fayetteville, KFMQ		La Salle, WJBC		Flint, WFDF		Grand Rapids, WEDC, WOOD		Richmond Hill, WAHG, WBOQ					
Hot Springs National Park, KTHS			Mooseheart, WJJD		Grand Rapids, WEDC, WOOD		Houghton, KFMW, WVAO		Rochester, WABO, WHAM, WHEC					
California:	Alma, KFQU		Oak Park, WGES		Lansing, WREG		Lansing, WREG		Schenectady, WGY					
Avalon, KFVO			Plainsfield, WVAE		Mt. Clemens, WABX		Owosso, WSMH		Syracuse, WFRL					
Bakersfield, KOZB			Rock Island, WBBF		Owosso, WSMH		Port Huron, WAFD		Tarrytown, WRW					
Bear Lake, KFNB			Streator, WTAX		Port Huron, WAFD		Royal Oak, WAGM		Toni, WOKN					
Berkeley, KRE			Sycamore, WJBN		Royal Oak, WAGM		Ypsilanti, WJBC		Troy, WHAZ					
Burlingame, KFOB			Tuscola, WDJ		Ypsilanti, WJBC				Utica, WIBX					
Chico, KFWH			Urbana, WRM											
Fresno, KNJ			Zion, WCBH											
Hollywood, KFQZ, KFVB, KNX			Indiana:	Anderson, WEED, WHBU		Minnesota:	Collegeville, WEFJ		North Carolina:	Asheville, WABC				
Long Beach, KFOV			Culver, WHBH		Minneapolis, KFZD, WAMD, WCO, WHAT, WHDI, WRHM, Northfield, KFMC, WCAL		Charlotte, WPT, WJBG		Bismarck, KFYR					
Los Angeles, KFI, KFPR, KFSG, KHJ, KMFR, KNRC, KTHI			Evansville, WGBF		Kokomo, WIAK		Fort Bragg, AT9		Devils Lake, KDLR					
Oakland, KFUS, KFUV, KFWM, KGO, KLS, KLL, KFAB, KZM			Kokomo, WIAK		Indianapolis, WFBM		Raleigh, WRCO		Fargo, WDAY, WPAK					
Oxnard, KFYP			Lafayette, WRAF		Lafayette, WRAF				Grand Forks, KFJM					
Pasadena, KPCC, KPSN			Logansport, WHBL, WIBW		Logansport, WHBL, WIBW									
Sacramento, KFBK			South Bend, WSBT		South Bend, WSBT									
San Diego, KFBC, KFVV			Seymour, WFBE		Seymour, WFBE									
San Francisco, KFRC, KGTT, KJBS, KPO, KUO			Valparaiso, WRBC		Valparaiso, WRBC									
San Jose, KFAF, KQW			West Lafayette, WBAA		West Lafayette, WBAA									
San Pedro, KFDV														
Santa Barbara, KFBJ														
Santa Maria, KFNC														
South San Francisco, KFVI														
Stockton, KXG														
San Bernardino, KFVC														
Colorado:	Boulder, KFAJ													
Colorado Springs, KFXP														
Denver, KFEL, KFXY, KFUP, KFVR, KLZ, KOA														
Greeley, KFCA														
Gunnison, KFBA														
Trinidad, KFBS														
Connecticut:	Hartford, WHIC													
New Haven, WDRB														
Storrs, WCAC														
Delaware:	Wilmington, WHAV													
District of Columbia:	Washington, WCAP, WMAL, WRC, WRHF													
Florida:	Clearwater, WGHB													
Fulford-by-the-Sea, WGBU														
Jacksonville, WJAX														
Miami, WQAM														
Miami Beach, WIOD, WMBF														
Pensacola, WCOA														
St. Petersburg, WHBN, WJBB														
Tampa, WDAE														
Winter Park, WDBO														
Georgia:	Atlanta, WDBE, WGST, WSB, Macon, WMAZ													
Savannah, WEBZ														
Idaho:	Boise, KFAU, KFDD													
Kellogg, KFEY														
Illinois:	Batavia, WORD													
Cambridge, WTPA														
Carthage, WPAD														
Chicago, KYW, WAAF, WBBM, WBBZ, WBCN, WBBH, WBBW, WPKB, WGN, WBBM, WHT, WIBS, WIBM, WIBO, WJAZ														

STATION SCHEDULES

(Continued from last week)

CKCD, Vancouver, B. C., Can. 410.7m-730kc. 750 watts. Vancouver Daily Province. Announcer, William Rose. Slogan, "Canada's Western Gateway." Daily ex Sun, 8:30-9:30 pm, music, news, entertainment. Pacific.

CKCK, Regina, Sask., Can. 312.3m-960kc. 500 watts. Leader Pub. Co. Announcer, A. W. Hooper. "The Queen City of the West." Daily ex Sat, Sun, Tues, 9:45-10:30 am; 1-1:45 pm; 7:30-8:15 pm, music, markets. Tues, 9:45-10:30 am; 1-1:45 pm; (CNRR) 8-10 pm. Sat, 9:45-10:30 am; 1-1:45 pm. Sun, 9 pm. service. Mountain.

CKCL, Toronto, Can. 356.9m-840kc. 500 watts. The Dominion Battery Co., Ltd. Daily ex Sat, Sun, 10:30 am; 3-4:30 pm. Daily ex Sat, 11 am, time. Mon, Wed, Fri, 7 am, 7:15, 7:45, exercises. Tues, 7-11:30 pm. Alternate Thurs, 7-8 pm, Sat, 7-8 pm. Sun, 3-4:30 pm. Eastern.

CKCO, Ottawa, Ont., Can. 434.5m-690kc. 100 watts. Dr. G. M. Geldert (Ottawa Radio Assn.) Announcer, Dr. O. K. Gibson. Slogans, "Ottawa's Radio Voice." "The Community Voice of Canada's Capital." Tues, 8-10 pm. Sun, 7 pm, services; 9, sacred concert. Eastern.

CKCW, Burketon Junction, Ont., Can. 329.5m-910kc. 500 watts. Canadian Broadcasting Corp. Announcer, B. C. C. Can. 410.7m-730kc. 50 watts. First Congregational church.

CKNC, Toronto, Ont., Can. 356.9m-840kc. 900 watts. Canadian National Carbon Co., Ltd. Mon, 8-12 mid. Sat, 4-5 pm; 8-10. Eastern.

CKOC, Hamilton, Ont., Can. 340.7m-880kc. 50 watts. Wentworth Radio Supply Co., Ltd. Announcer, F. May. Slogan, "In the Garden of Canada." Mon, Sat, 6:15-7:15 pm, organ. Tues, Wed, Thurs, 5-30, 6:30 pm. Fri, 6-7 pm. Sat, 4:30-5:30 pm. Sun, 2-3 pm. Eastern.

CKY, Winnipeg, Man., Can. 384.4m-780kc. 500 watts. Manitoba Tel. System. Announcer, D. R. P. Coats. Slogan, "Manitoba's Own Station." Daily ex Sun, 10:50-11 am, time, weather; 12:30-1:30 pm, music, lectures, livestock; 2:15 pm, grain markets; 4-5, news, kiddies story. Mon, Thurs, Sat, 8 pm, lecture; 8:30, music. Wed, 7:30 pm, CNRW program. Sun, 7 pm. Central.

CNRA, Moncton, N. B., Can. 291.1m-1030kc. 500 watts. Canadian National Railways. Announcer, W. V. George. Slogan, "Voice of the Maritimes." Daily ex Sun, 2:45-3:45 pm. Tues, 7:30 pm. Fri, 9 pm. Atlantic.

CNRC, Calgary, Alta., Can. 435.8m-688kc. 750 watts. Canadian National Railways. Thurs, 7 pm, bedtime story; 9-11. Mountain.

CNRE, Edmonton, Alta., Can. 516.9m-580kc. 500 watts. Canadian National Railways. Fri, 7:30-8 pm, 8:30-10:30. Mountain.

CNRM, Montreal, Que., Can. 410.7m-730kc. 1,000-1,650 watts. Canadian National Railways. Announcer, J. S. McArthur. Thurs, 8:30 pm. Eastern.

CNRO, Ottawa, Can. 434.5m-690kc. 500 watts. Canadian National Railways. Announcer, A. W. Ryan. Wed, Sat, 7:30 pm, markets, bedtime story; 8, 9, 10:30, dance program. Eastern.

CNRB, Regina, Sask., Can. 475.9m-630kc. 500 watts. Canadian National Railways. Tues, 8-10 pm. Mountain.

Cuba

PWX, Havana, Cuba. 400m-750kc. 500 watts. Cuban Telephone Co. International Tel. & Teleg. Corp. Mon, Tues, Fri, Sat, 8:30-11 pm. Wed, Sun, 8-10 pm, music. Eastern.

Q2LC, Havana, Cuba. 250m-1200kc. 50 watts. Luis Casas. IAZ, Havana, Cuba. 275m-1090kc. 5 watts. Antonio Sarasola.

2AB, Havana, Cuba. 235m-1277kc. 10 watts. Alberto S. Bustamante.

2BB, Havana, Cuba. 255m-1176kc. 15 watts. Bernardo Barrie.

2BY, Havana, Cuba. 315m-952kc. 100 watts. Electrical Equipment Co. of Cuba. Mon, Thurs, 7-8 pm. Eastern.

2CG, Havana, Cuba. 350m-857kc. 15 watts. Humberto Giquel.

2CX, Havana, Cuba. 320m-937kc. 10 watts. F. W. Barton.

2EP, Havana, Cuba. 355m-845kc. 400 watts. El Pais.

2HP, Havana, Cuba. 295m-1016kc. 100 watts. Credito y Construcciones Co.

2JL, Havana, Cuba. 275m-1090kc. 5 watts. Jose Leiro.

2JP, Havana, Cuba. 270m-1110kc. 20 watts. Julio Power.

2LR, Havana, Cuba. 235m-1277kc. 10 watts. Jose Lara.

2MG, Havana, Cuba. 280m-1070kc. 20 watts. Manuel Y. Guillermo Salas Music Store. Announcer, Roger Morales. Daily, 3-4 pm, music. One day each week, 8-11 pm. Eastern.

2MK, Havana, Cuba. 85m-3528kc. 20 watts. R. V. Waters.

2OK, Havana, Cuba. 360m-833kc. 100 watts. Mario Garcia Velez.

2OL, Havana, Cuba. 300m-1000kc. 100 watts. Columbus Cycle Radio Co.

2PK, Havana, Cuba. 195m-1583kc. 10 watts. George A. Lindeux.

2RK, Havana, Cuba. 310m-967kc. 100 watts. Raoul Karman. Casa De La Porte.

2RM, Havana, Cuba. 210m-1490kc. 10 watts. Rogelio Morales.

2RY, Havana, Cuba. 170m-1764kc. 5 watts. Salvador de la Torre.

2SZ, Havana, Cuba. 180m-1777kc. 10 watts. Homero Sanchez.

2TW, Havana, Cuba. 230m-1304kc. 20 watts. Roberto E. Ramirez.

2UF, Havana, Cuba. 265m-1132kc. 10 watts. Roberto E. Ramirez.

2XX, Havana, Cuba. 150 meters. 5 watts. Antonio A. Giarard.

5AZ, Matanzas, Cuba. 200m-1500kc. 20 watts. Ernesto Figueroa.

5BY, Matanzas, Cuba. 190m-1580kc. 10 watts. Leon Gonzalez Velez.

5EV, Colon, Cuba. 360m-833kc. 10 watts. Leopoldo V. Figueroa. Sun, 9-11 pm. Eastern.

6BY, Santa Clara, Cuba. 260m-1153kc. 200 watts. Jose Gandux.

6DW, Santa Clara, Cuba. 225m-1333kc. 10 watts. Eduardo Terry.

6EV, Santa Clara, Cuba. 250m-1200kc. 100 watts. Maria Josefa Alvarez. Daily, 10:30 pm.

6GR, Santa Clara, Cuba. 250m-1200kc. 10 watts. Luis del Castillo.

6GT, Santa Clara, Cuba. 190m-1580kc. 5 watts. Juan Pablo Ros.

6HS, Santa Clara, Cuba. 200m-1500kc. 10 watts. Santiago Ventura.

6JQ, Santa Clara, Cuba. 250m-1200kc. 10 watts. Eligio Cabelo Ramirez.

6KW, Tuinucu, Cuba. 338m-890kc. 4,000 watts. Frank H. Jones. Slogan, "If You Hear the Koo of the Cuckoo You Are in Tune with Tuinucu." Daily 11:30-12:15 am. Eastern.

6KJ, Tuinucu, Cuba. 275m-1090kc. 100 watts. Frank H. Jones.

6YR, Camaguey, Cuba. 200m-1500kc. 20 watts. Diego Iborra.

7AZ, Camaguey, Cuba. 225m-1333kc. 10 watts. Pedro Nogueras.

7BY, Camaguey, Cuba. 235m-1277kc. 20 watts. Eduardo V. Figueroa.

7CX, Camaguey, Cuba. 85m-3528kc. 10 watts. Leonard B. Fox.

7DW, Camaguey, Cuba. 90m-3333kc. 10 watts. M. L. Quintana.

7SR, Camaguey, Cuba. 300m-1000kc. 500 watts. Salvador C. Rionda. Slogan, "Cuba, the Land of Sunshine, Sugar and Tobacco." Mon, Tues, Thurs, 8:30 pm. Eastern.

8AZ, Santiago, Cuba. 240m-1250kc. 20 watts. Alfredo Brooks.

8BY, Santiago, Cuba. 250m-1200kc. 100 watts. Alberto Ravelo.

8FU, Santiago, Cuba. 225m-1333kc. 15 watts. Andres Vinent.

8IR, Santiago, Cuba. 190m-1580kc. 20 watts. Ceferino Ramos.

8JQ, Santiago, Cuba. 275m-1090kc. 20 watts. Jose Fernandez Heredia.

France

FPTT, Paris, France. 458 meters. 450 watts. Superior School P. T. Announcer, M. Chanton.

YN, Lyons-La-Doua, France. 340 meters. French Government. Lyons, Radio-Lyon, 284 meters. 600 watts. Paris, Le Petit Parisien. 345 meters. 450 watts.

Great Britain

2BD, Aberdeen, Scot. 495 meters. 1,500 watts. British Broadcasting Co. Announcer, H. M. Fitch.

2BE, Belfast, Ireland. 438 meters. British Broadcasting Co., Ltd. Announcer, W. T. Guthrie. Commander, A. Pelham.

2DE, Dundee, Scot. 330.5 meters. British Broadcasting Co.

2EH, Edinburgh, Scot. 324.5 meters. British Broadcasting Co.

2LO, London, Eng. 365 meters. 3,000 watts. British Broadcasting Co., Ltd.

2LS, Leeds and Bradford, Eng. 342 and 308 meters. British Broadcasting Co., Ltd.

2ZY, Manchester, Eng. 377.5 meters. British Broadcasting Co.

5IT, Birmingham, Eng. 477.5 meters. British Broadcasting Co.

5NG, Nottingham, Eng. 326 meters. British Broadcasting Co.

5NO, Newcastle, England. 403.5 meters. British Broadcasting Co.

5PY, Plymouth, Eng. 338 meters. 200 watts. British Broadcasting Co., Ltd. Announcer C. C. N. Wallich.

5SC, Glasgow, Scot. 422 meters. British Broadcasting Co.

5XX, Daventry, Eng. 558 meters. British Broadcasting Co.

5WA, Cardiff, Wales. 353 meters. British Broadcasting Co.

6BM, Bournemouth, Eng. 388 meters. British Broadcasting Co.

6FL, Sheffield, Eng. 301 meters. British Broadcasting Co.

6KH, Hull, Eng. 334.5 meters. British Broadcasting Co.

6LV, Liverpool, Eng. 311.5 meters. British Broadcasting Co.

6ST, Stoke-on-Trent, Eng. 304.5 meters. British Broadcasting Co.

Mexico

CYA, Mexico City, Mex. 265m-1130kc. 500 watts. Mon, Fri, 6:45-8 pm. Sun, 4-6 pm. Partido Liberal Avanzado. Mexican.

CYB, Mexico City, Mex. 270m-1110kc. 500 watts. El Buen Tono. Tues, Thurs, Sat, 7:30-9 pm, concert. Mexican.

CYF, Oaxaca, Oax., Mex. 260m-1153kc. Federico Zorrilla. "The Voice from South of Mexico." Tues, Thurs, 7-8 pm. Sun, 8:30-10 pm. Mexican.

CYG, Mexico City, Mex. 300m-1000kc. 1,000 watts. Secretaria de Guerra y Marina.

CYH, Mexico City, Mex. 325m-923kc. 100 watts. High Life. Slogan, "Los Proveedores del Caballero Que Viste Bien." Announcer, Jorge Chulia Mallet. Fri, 8:30-10 pm. Mexican.

CYL, Mexico City, Mex. 480m-625kc. 500 watts. La Casa del Radio. Announcer, George Marron. Slogan, "The Land of Eternal Summer." Daily ex Sun, 1:30-2 pm, weather, financial reports, music. Tues, Fri, 8-9:30 pm. Sun, 8-9:30 pm, church. Mexican.

CYR, Mazatlan, Sin., Mex. Rosseter Y Cia.

CYS, Monterrey, Mexico. 408m-6029kc. 250 watts. Tarnava & Cia. Slogan, "The Industrial Center of the Mexican Republic." Daily and Sun, 7:55-8:05 pm. Mon, 8-9:30 pm. Mountain.

CYX, Mexico City, Mex. 333m-900kc. 500 watts. Excelsior & Cia. Parker. Announcer, Rafael Hernandez dez Dominguez. Slogan, "Land of the Aztecs." Mon, 8-9:30 pm. Fri, 8:30-9:30 pm. Mexican.

CYZ, Mexico City, Mex. 400m-750kc. Liga Central Mexicana de Radio. Mexican.

CZA, Mexico City, Mex. 70-500-1,070 meters. Aviation Dept., War Ministry. Announcer, Ricardo S. Bravo. Daily, 12:30-1 pm, time, weather, news; 6:30-7:30, time, markets, music. Mexican.

CZE, Mexico City, Mex. 350 meters. 500 watts. Secretary Public Education. Daily ex Sun, 8 pm. Mexican.

CZF, Chihuahua City, Mexico. 310m-967kc. 250 meters. Announcer, C. A. Nieto. Slogan, "United by Radio." Tues, 8-9:30 pm. Mountain.

XDA, Mexico City, Mexico. Variable wave. 4,000 watts. Government station. Slogan, "Radio Chapultepec." Mexican.

RADIO 'RITHMETIC

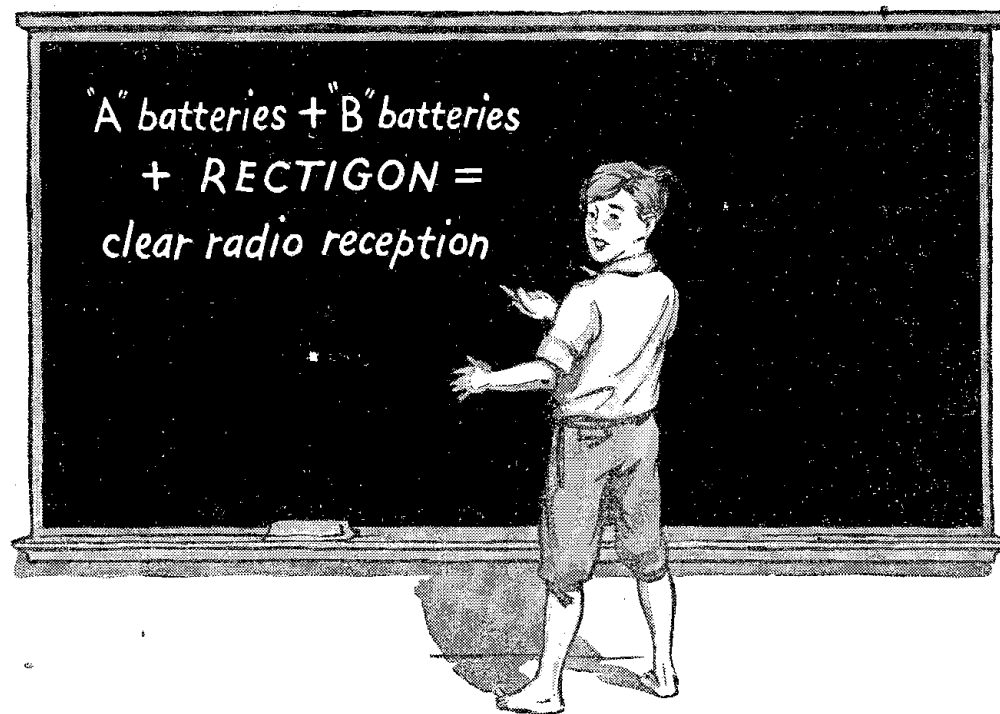

Multiply distance by adding a *RECTIGON*

A SIMPLE solution for so big a result! Want band music? Try KDKA. Jazz? Theatricals? Maybe you'll find it at WBZ, KYW or KFKX. What your local stations won't provide can be obtained easily from somewhere else.

How well you receive radio entertainment depends upon the condition of your batteries—and that's up to you. With a Westinghouse

Rectigon on the job both your "A" and "B" batteries can be kept fully alive to the greatest possibilities of your set.

And it's easy as can be. Just snap on the cords and turn on the current. There's no muss or fuss; no acids; no chemicals, and no noise. The Rectigon more than pays for itself within a short time.

WESTINGHOUSE ELECTRIC & MANUFACTURING CO.
SOUTH BEND, INDIANA

The Westinghouse Rectigon Battery Charger

© 1926.
W. E. & M. Co.

No storage-battery
radio is complete
without a
RECTIGON.

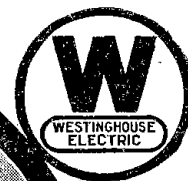
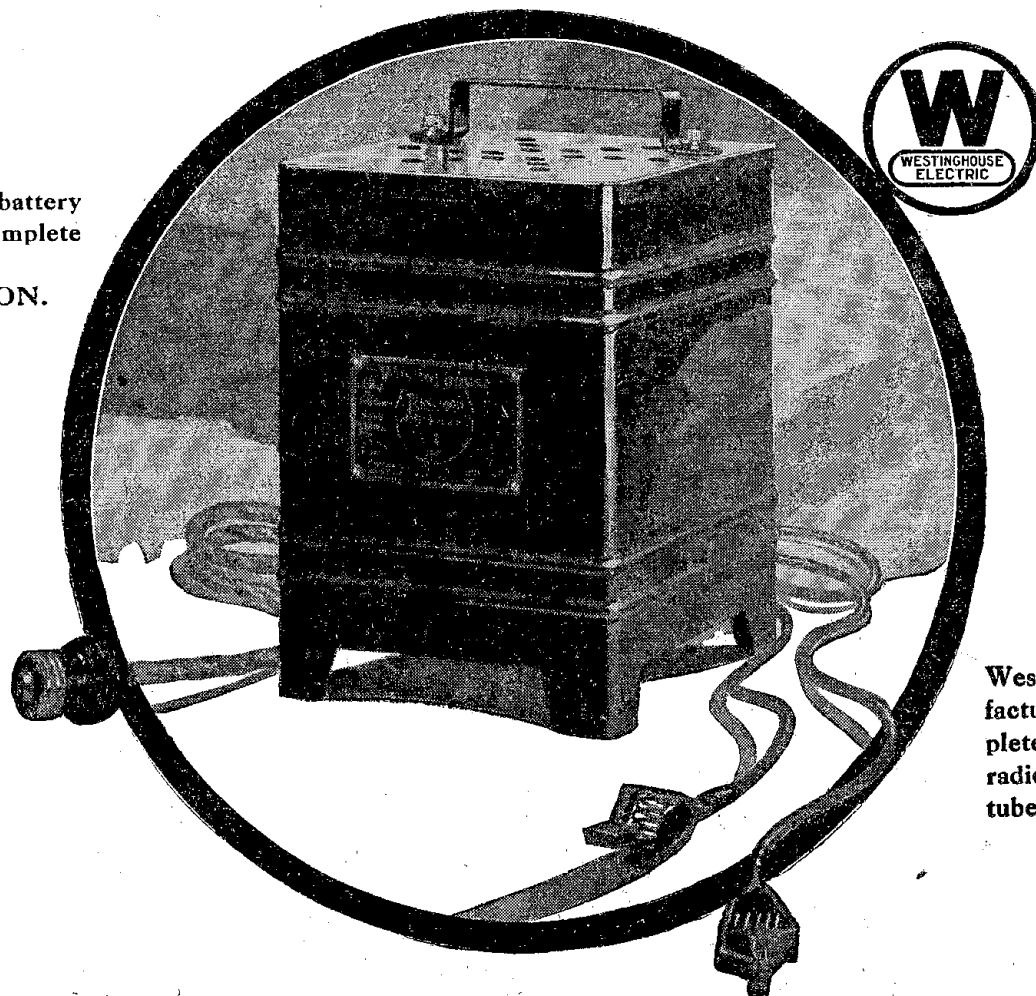

Westinghouse manufactures, also, a complete line of Micarta radio panels, Micarta tubes and instruments.

Two-Tube Short Wave 15-130 Meter Receiver

Part IV—Adjusting and Operating

By John G. Ryan

IN ALL probability the experienced set builders following this series of articles now have this receiver all hooked up and working more or less efficiently, but since many will also tackle it who are not so advanced, the connections will be gone over quickly and the adjustment will then be taken up.

First of all, you have probably noticed that no antenna and ground posts were provided on the sub base. These were deemed unnecessary as they are provided on the coil mounting at the right end, and the lead-in and ground can be brought in directly, through holes at the rear of the cabinet, to these posts. As to the batteries, those for lighting the filaments will depend upon the tubes used. If 201-A type tubes with either UV or UX bases are your choice, a six volt storage battery serves, while, if UX-199 type tubes are used, three dry cells or a Philco four volt storage battery will do. In either case, connect the negative terminal to the binding post at the left end and the plus terminal to the second post from the left.

Two B batteries of 45 volts each are needed and these may be either medium or large in size since only two tubes are drawing current. The negative of one is connected to the second post from the left, or the plus post on the filament battery, and the plus of that same B unit is connected to the negative of the other and also to the third binding post on the set. This leaves the plus of the second B unit which is to be connected to the fourth binding post.

Can Use Switching Arrangement

If it is desired to operate this set from the same batteries used for your broadcast range receiver, some sort of six pole double throw switching arrangement must be used to throw the four battery leads and the antenna and ground to one set or the other. This can be either one switch, two triple pole D. T. switches or three double pole D. T. switches such as Carter or Yaxley jack switches. It is not a good plan to leave these wires connected to both sets and merely turn on the filament switch of one or the other. The six wires mentioned above would go to center lugs while there would be six short leads going to right to the broadcast set, with six other short leads going to the left to the short wave set.

In the original list of parts included with Part I, an Amperite 1-A was listed, on the presumption that 201-A tubes would be used. If the UX-199 tubes are to be operated this Amperite should be 4V-199. The Bradleystat is universal in its uses and is suitable for any tubes. For those to whom the insertion of the C battery, as described last week, may not have been clear, figure 9 is presented with this chapter with the exact placing of this battery and the flexible wires leading to it, clearly shown. No directions on the insertion of the radio frequency choke were given. This coil is both light and small and we found it could quite readily be supported on the bus bar wiring, one

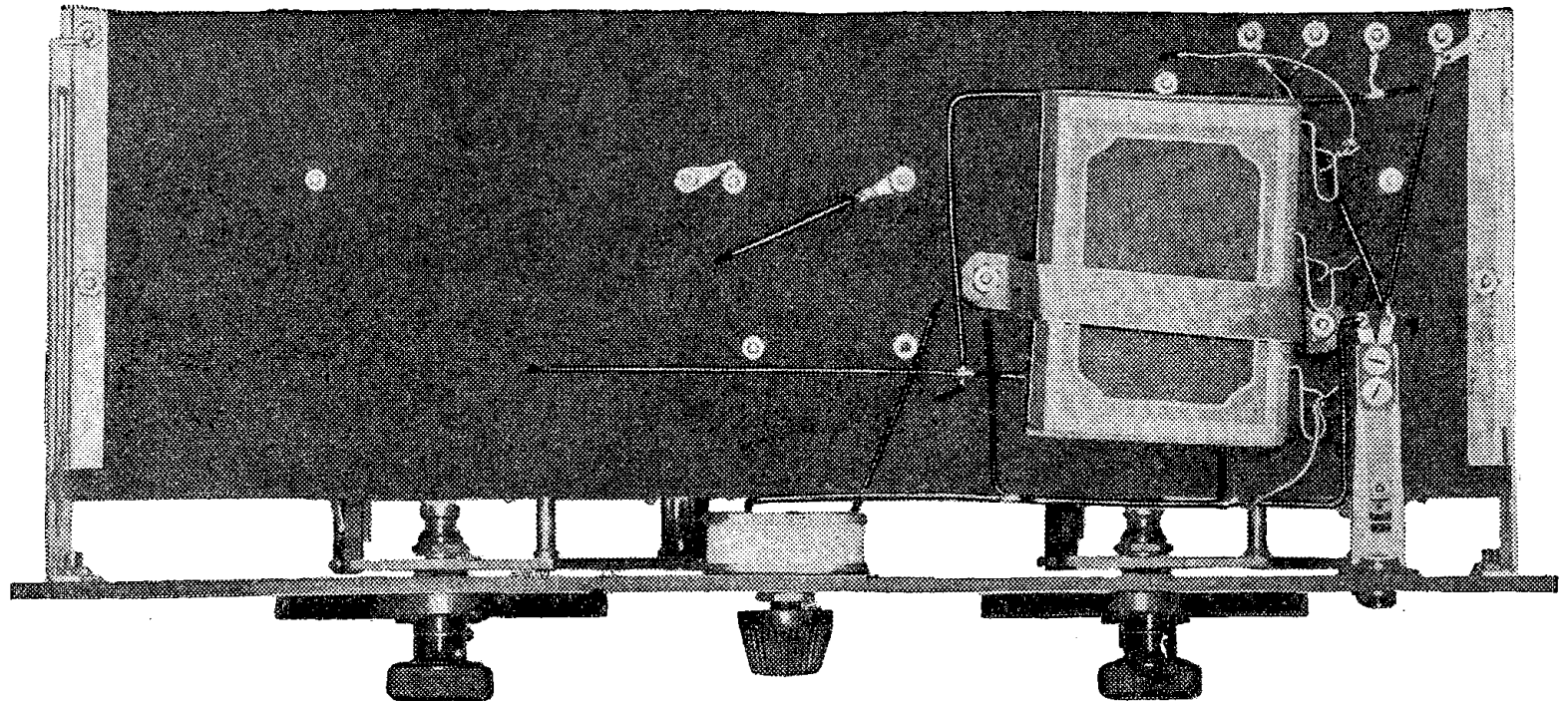

Figure 9

end being attached to the wire from the P terminal on the Karas transformer and the other to the wire which comes up from condenser-coil connector.

Experimentation Needed

The ticklish part of this whole outfit is the matter of grid bias of the detector tube. The set will work, to some extent, without a great deal of care in the matter of adjustment, but that gradual approach to oscillation that is the secret of range, will be obtained only if some experimenting with the grid leak, grid condenser and grid return is done. You probably noticed in the schematic diagram shown with Part I that the grid return was shown dotted to both the plus and minus filament leads. This can go to either the plus, the negative between rheostat and filament or the negative below rheostat. You will most likely find plus filament the best spot for this but try them all. If you have an assortment of grid leak cartridges and small fixed condensers around from previous work (and every true experimenter has), take out the Leakandenser cartridge and connect a .0001 mfd. or .00015 mfd. fixed condenser across the mounting screws for the clips on the under side.

Various resistance cartridges should then be tried, with the different grid return connections mentioned until a slow approach to oscillation, through regeneration, is possible. If no combination gives you this, the radio frequency choke is essential and its use will force all of the radio frequency component in the detector plate circuit, through the feedback coil and condenser and keep this component out of the audio frequency part of the set.

In the schematic diagram of figure 2, a possible connection between the filament circuit and the ground binding post is shown. It is usually preferable to omit

this connection since it is likely to bring in a lot of undesirable noises and will not help the selectivity a bit. Put it in only if for some reason you are bothered with hand capacity.

While making any of the adjustments outlined, the three coils should be inserted one after another to be sure that, with any combination, it is possible to secure oscillation over the whole wave length range. These tests should be made with the antenna and ground disconnected and the antenna coil swung back away from the secondary coil. Thus you can be sure there are no "dead spots" created within the set itself. With a satisfactory arrangement in the matter of grid bias, the antenna and ground connections can

be put back on and the tuning tried over the whole scale.

Now, due to characteristics of your individual antenna installation, it is highly probable that a dead spot or two will be found due to harmonics of the antenna circuit itself. At these harmonics it will absorb energy from the grid circuit surprisingly fast. Most of these spots can be eliminated by loosening the coupling of the primary to the secondary but it may prove necessary to shift the natural period of the antenna circuit by inserting either a loading coil to raise it or a series condenser to lower it. Although we did not find dead spots due to harmonics of the radio frequency choke, we understand (Continued on page 28)

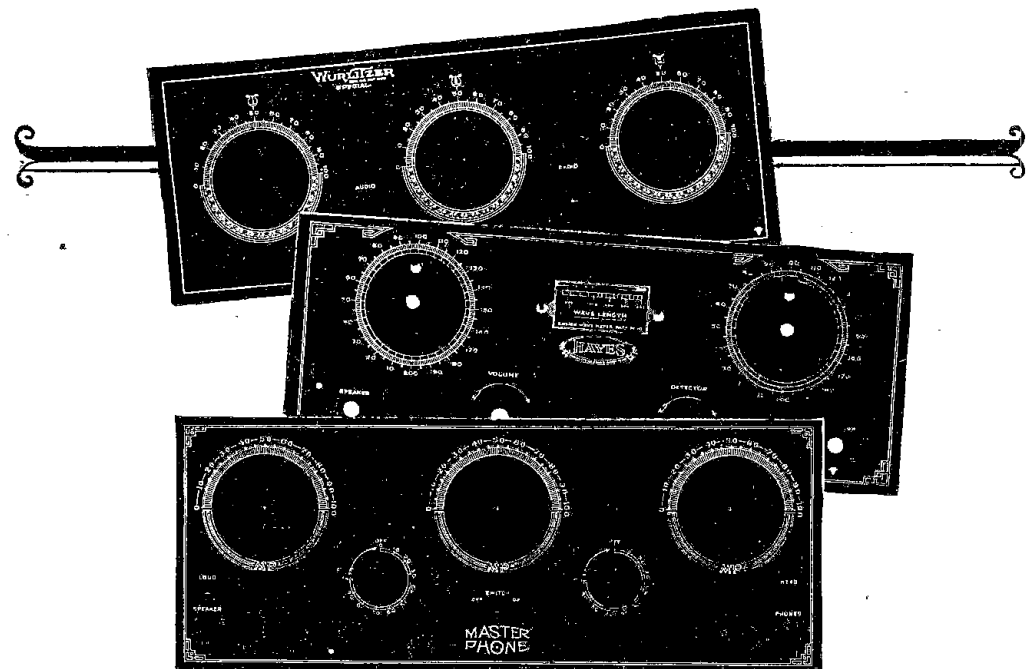

Veri Chrome and Formica Provide the Finest Radio Panel

THE great variety and beauty of the decorations for radio panels that are possible with Veri Chrome, and the remarkable permanence of a Formica panel so decorated have made sets with Veri Chromed panels very popular.

Bremer-Tully No. 1; Bremer-Tully Counterphase; Bremer-Tully Nameless; two sizes of Best's Superheterodyne put out by Remler; and the Browning-Drake receiver offered by the National company, the four tube Marco Browning-Drake and the General Radio Universal Receiver, are kits for which Veri Chromed panels are now available—see your dealer or jobber or write us direct.

To give kit buyers who assemble their own sets a chance to purchase Veri Chrome decorated panels we have prepared panels for some of the better known kits.

Panels of all standard sizes are packed in neat individual envelopes and sold by dealers to home set builders.

Write for booklet "What Formica Is"

THE FORMICA INSULATION COMPANY
4667 Spring Grove Avenue Cincinnati, Ohio

FORMICA

Made from Anhydrous Bakelite Resins
SHEETS TUBES RODS



Fred W. Stein.

Steinite Low Loss Interference Eliminator

No Radio Set Complete Without It

Select stations at will. With music and voices crowding the air the average set fails to bring in the desired stations properly. The **Steinite Interference Eliminator** shuts out local and other interference. You get one station at a time, the one you want, and tune in loud and clear. Operates on any set—attach to aerial wire and to set—no changes—no extra tubes or batteries. Greatest Dollar Value in Radio Today. **OVER 300,000 SOLD**

Improved Results With Tube or Crystal Try entirely at my risk the wonderful improvement this inexpensive little device will make in the reception of your set. Improves results on both crystal and tube sets that use any kind of aerial except loop antenna. Clears up reception wonderfully, increases volume, and partially absorbs static. **MONEY-BACK GUARANTEE.**

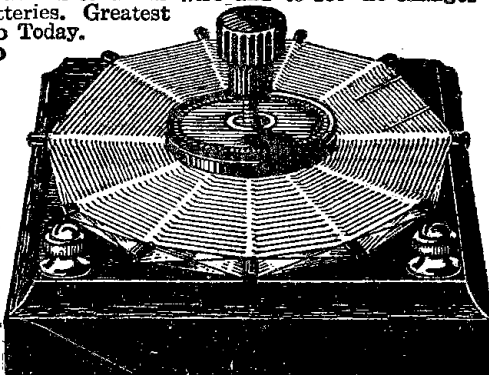

Mrs. Famous 1,500 Mi. Steinite 1-Tube Set, \$6; Long Distance Crystal Set, \$6; Steinite Crystal 50%—3 for \$1
STEINITE 5-Tube Set—\$29.75
FREE Descriptive Literature on request.

Put this interference eliminator on your set and note amazing improvement. No tools needed—install in a moments time. Connect with set and follow simple instructions. Money back promptly if not delighted. \$1.00 postpaid anywhere in U. S. when cash with order.

\$1 Postpaid If you are not delighted with results you get your dollar back

References: Exchange National Bank, Atchison Savings Bank. Order today—a dollar bill will do.
STEINITE LABORATORIES, 161 Radio Bldg., ATCHISON, KANSAS

SHORT WAVE RECEIVER
(Continued from page 27)

from Marco that these are also a possible source of such areas. Alteration of this choke either by adding turns, cutting them down, using a smaller core or a slightly larger one will shift these harmonics out of range.

It may seem to builders of this outfit that there are a great many "ifs," "ands" and "buts" to this outfit but it must be understood that factors which are not important in the broadcast range of wave lengths, are magnified tremendously in importance when one is working between 15 and 130 meters. In the first case, the frequencies are 500,000 to 1,500,000 per second, while, in this latter work, the frequencies involved are from 2,300,000 to 20,000,000 per second. Patience and willingness to experiment, however, will give the builder satisfaction well worth the effort and a valuable education in Radio.

A STEP ON THE STAIRS
(Continued from page 7)

scraped and flamed almost instantly in the hallway.

"The candle is there under the table near the Sahib's foot," the Indian reported. "If one of the Sahibs will pick it up . . . There it is."

"This time I had matches in readiness . . . What is the matter with the Sahib's hand?"

Ardwyn was standing as he had been standing before the mishap to the candlestick but he was holding his right wrist with his left hand and his face was contorted with pain.

"She bit me," he said. "I know it was a woman. I felt her hair . . ." The three women of the company leaned forward in their chairs and looked at one another appraisingly.

"I'm so sorry," murmured Mary Williams contritely. "It is really my fault. If I hadn't jolted the table and upset the candlestick this horrible thing could never have happened."

"It's nothing to be upset about," said Ardwyn. "I can fix it. I have been chewed by wild animals before."

"No," put in Tolliver, "please don't get all agitated. I ain't even surprised at Ardwyn gettin' all chewed. Nothin' surprises me in this menagerie. I ain't even

STRAIGHT-8 ON THE WEST COAST



I made was in the number of turns on the grid coil of the oscillator which I reduced 4 turns from the specifications. I trust this may be of some interest to Messrs Christen and Fournier.—J. B. Fox, Exeter, Calif.

(Editor's Note—Letters such as this are most encouraging to the technical staff. Few readers take the trouble to advise us when Radio Digest sets work well; they seem to take it for granted they should. "Grief" letters are also welcome, however, as they show us where we might improve our descriptions of receiver construction).

I HAVE built or rather changed over my super to the Straight-8 as published by you so thought you might like to know how it is working. I got no European stations during the test, but my attached list includes 90 stations logged between January 13 and February 5. You will note this includes the East coast with 6KW, WSB and WGY, Mexico with CZE and CZE, Canada with CFCT, CNRV, CKCD, CFCN and CFAC and all those worth talking about in between.

You know we have to get our Eastern stations at a time when all our local stations are also on and I have, within 200 miles of me, 10 of 500 watts, 2 of 5,000 watts, 1 of 750 watts and 2 of 1,000 watts with many of lesser power. Also you know WLW is 2,000 miles from me and 10 kilocycles from KPO, WHT is 1,800 miles from here and 10 kilocycles from KHJ, WDAF is 1,400 miles distant and 10 kilocycles from KGO while WBAP, also 1,400 miles away, is only 10 kilocycles off of KFT's 5,000 watts, but I get them and use an aerial 150 feet long; so you can guess what I think of the Straight-8.

I was using an ultradyne, so simply took out the coils, made the new one and put them in the right places. Have Amperites on all tubes in place of rheostats and think they are the only thing. The only change they are the only thing. The only change they are the only thing. The only change they are the only thing.

surprised when they put on the lights and I see you there in your chair."

"What do you mean?" demanded Mary Williams.

"Oh nothin' at all," explained Tolliver with an exaggerated penitence. "Nothin' at all except when I saw you goin' dizzy I thought you might fall an' miss the chair. And Mr. Ardwyn . . . Maybe you didn't notice . . . But that letter . . . It's gone."

Who bit Lawyer Ardwyn on the wrist and stole the letter taken from the motorcycle cop? Who shot the engineer at FYX? Why did

sweet Mary Williams faint—if she really did faint? What became of the bearded pirate? The next installment will offer new clues and present new complications for those who are hoping to get some of that \$500 in gold to be awarded by Radio Digest for the correct solution at the finish. Be sure to read the next installment!

Piano virtuosos are so hard on the two pianos in WSAI's studios that it is necessary to have them tuned weekly. The pianos are used 20 to 30 hours a week.

Phone Cord Tip Jack
The attached sketch shows an easily constructed phone cord tip jack I devised. A short piece of brass strip, one-quarter to one-half inch wide and a short

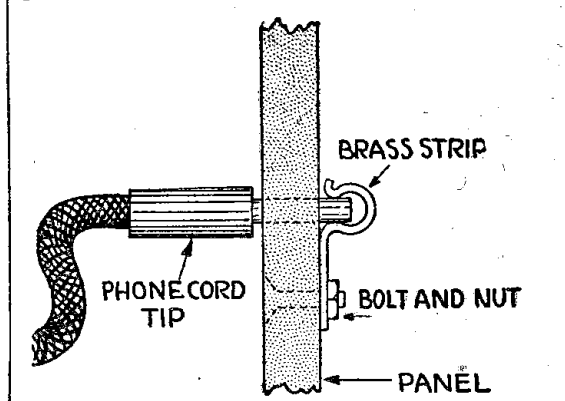

machine screw are all that is necessary. The machine screw can, of course, be either round or flat head.—Eugene Wilson, Jr., Bentonville, Ark.

Cabinet Corner Pad
A thick round corn pad, moistened, will adhere readily to the foot of any receiver. This will not only prevent scratching of the table but will remove

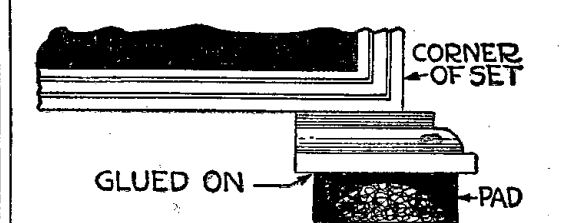

many of the microphonic noises.—William Fischer, 1193 Twenty-ninth street, Milwaukee, Wis.

WHT Has Frequency Indicator
CHICAGO.—If you want to determine exactly what is 400 meters on your receiving set, tune in on WHT, Chicago. A frequency indicator has been installed on the transmitter and the wave will not vary to less than 399.99 or more than 400.01 meters.

Norwegian fishermen at Stavanger are now using a microphone with telephone attachment to listen for the movement of shoals of fish. Airplanes are used for "spotting."

Look into each real record of International Test Week, and quite likely you will find a Penetrola behind it. Never was the stage so perfectly set to prove that *Penetrola plus almost any set* surpasses the very costliest set alone. Europe, brought in like local broadcasting, confirms the audibility meter tests in which Penetrola multiplied signal strength 188 times!—ahead of the detector! Penetrola results, based on exclusive, perfected Walbert principles, are the reason for the radio industry's intense interest today in the Walbert Isofarad circuit.

WALBERT MANUFACTURING COMPANY
929 Wrightwood Avenue Chicago

PENETROLA

The New Radio Book
HOW TO
Operate Sets
Construct Parts
Improve Reception
Understand Radio
Assemble Circuits

The greatest assemblage of facts and hints, from actual everyday practice, ever gotten together. Edited by the technical staff of Radio Digest, it supplies the demand for a book covering every phase of Radio. Starts at the beginning with simple explanation of Radio reception, with technical explanations of the different parts and leads right on to the more advanced instruction. A complete handbook serving as a ready reference in the Radio field. It gives suggestions on parts and sets which will prove to be a money saver. Blue prints and diagrams are essentially an important part of this book. Special chapter is devoted on "How to Operate," which gives detailed information on the operation of many well known sets.

A general information is vital to the knowledge of anyone interested in Radio. It gives a complete list of all broadcasting stations with a colored map showing their location. The workshop kinks will save you time and money. Now is the time to take advantage of this exceptional offer. **Mail coupon today!**

RADIO DIGEST,
510 N. Dearborn Street,
Chicago, Illinois.

Enclosed find \$5.00 for one year's subscription to Radio Digest. The new Radio Book, "Radio Receivers," will be mailed FREE, postage prepaid. This offer only good on subscriptions sent directly to this office, not through agents or agencies.

Name

Address

City State

3-6-26

Microphone Voice Is Deceiving to Those Who Would Describe Speaker

DENVER.—Attempts at sizing up Radio announcers by their microphone voice have come to be the newest of pastimes among listeners, judging from dozens of speculative letters being received here at KOA, Rocky mountain broadcasting station of the General Electric company.

Just because an announcer speaks with a deep bass voice is no indication he is "tall and thin," or that he sings bass or baritone, has gray hair or is of light complexion.

Experience shows that the microphone voice is most deceiving, a careful check of KOA fan correspondence proving that Radio voice speculators miss their mark no less than nine times out of ten.

MYSTERY SERIAL IS HIT

(Continued from page 3)

only glad to have a share in the development of this new branch of literature but are hoping that one of our listeners captures the grand prize."

This was the tenor of the replies of most of those who were asked to join in the presentation of the air drama.

Following is the list of stations which will broadcast the weekly episodes of "A Step On the Stairs" with their own dramatic artists:

- WOR, Newark, N. J., (405.2m-740kc);
- WHAR, Atlantic City, N. J., (275m-1090kc);
- WGY, Schenectady, N. Y., (379.5m-790kc);
- WEAN, Providence, R. I., (270.1m-1110kc);
- WNAC, Boston, Mass., (280.2m-1070kc);
- WSB, Atlanta, Ga., (475.9m-630kc);
- WRC, Washington, D. C., (468.5m-640kc);
- WMAQ, Chicago, Ill., (447.5m-670kc);
- WCCO, Minneapolis-St. Paul, (416.4m-720kc);
- WOC, Davenport, Ia., (483.6m-620kc);
- WLW, Cincinnati, O., (422.3m-710kc);
- WHO, Des Moines, Ia., (526m-570kc);
- WBAP, Ft. Worth, Tex., (475.9m-630kc);
- KTHS, Hot Springs, Ark., (375.8m-800kc);
- WOAW, Omaha, Neb., (526m-570kc);
- KOA, Denver, Colo., (322.4m-930kc);
- KGO, Oakland, Calif., (361.2m-830kc);
- KGW, Portland, Ore., (491.5m-610kc).

Time schedules for the broadcasting, so far as they have been received are published on the program pages.

CLASSIFIED ADVERTISEMENTS

Classified advertisements in Radio Digest produce results. Have you a receiving set to sell? Do you want to buy a Radio? A classified advertisement in this column will sell your set.

Rates are twenty cents a word for each insertion, five per cent discount for four insertions, ten per cent for thirteen insertions, fifteen per cent for twenty-six insertions, twenty per cent for fifty-two insertions, at above rate. Cash should accompany order. Minimum of ten words.

Objectionable and misleading advertisements not accepted. Forms close three weeks prior to date of publication, which is Saturday.

BLUE PRINTS

Super-Het, Ryan's Simplest Possible 7-Tube Set. Complete instructions, actual size template. How to make a loop. All for 50 cents. Book Dept., Radio Digest, 510 North Dearborn Street, Chicago.

BUSINESS OPPORTUNITIES

Start Real Mail Order Business. Booklet tells how. Sample plan 25c. Outfit furnished free. Evans, Dept. 3, 702 W. 16th St., Los Angeles, Calif.

FOR SALE

For Sale—Sixty dollar Thermodyne, speaker, table, new, \$35. R. E. Haesly, Winona, Minn.

For Sale—New N.R.6 Freed-Eisemann, \$55. R. E. Haesly, Winona, Minn.

MISCELLANEOUS

Photos of Your Favorite Radio Stars. Ten cents and coupon appearing on another page of this issue will entitle you to one of the photos from Radio Digest gallery of stars. Radio Digest, 510 North Dearborn Street, Chicago.

SALESMEN WANTED

WANTED—Manufacturer's representative for concern manufacturing a high grade Radio vacuum tube. Address your letters to Wm. C. Davis, Newton Falls, Ohio.

TELEGRAPHY

Telegraphy—Both Morse and Wireless taught thoroughly. Big salaries. Wonderful opportunities. Expenses low; chance to earn part. School established fifty years. Catalog free. Dodge's Institute, Sixth St., Valparaiso, Ind.

So far as KOA's audience is concerned, unusual interest appears to be centered on R. F. (Ralph Freese). Contrary to the theories of listeners, who have endeavored to figure him out, he is a lyric tenor and not a basso; he is of medium build and average height and not "tall and thin" and has fair skin instead of dark.

He Comes From Kansas

Born in Kansas, Freese, as a youth, spent his vacations working on a wheat farm and around his father's flour mill. On completing high school, he engaged in newspaper work and subsequently attended the Cincinnati Conservatory of Music and the University of Cincinnati. After school hours he engaged in social settlement work.

In 1921 Freese undertook to walk from Cincinnati to Hutchinson, Kan., a distance of approximately 1,000 miles, the outcome of a wager with his old classmates in college that autoists are not generous.

Gets Many Lifts

"Our wager stipulated that I was to hike across the country along the main traveled roads and was not to ask a single motorist for a 'lift,'" Freese says in describing his experience. "The trip took less than a month and I don't recall walking more than 100 miles altogether. In fact, offers from autoists to 'jump in' were so numerous that walking became a pleasant diversion."

Big Money in Radio

Demand for high pay radio men is so great that a big Kansas City wholesale concern is now fitting men free to get into the radio business for themselves and make \$60 to \$200 a week without any capital invested. Select territory open. Send today for free catalog and amazing offer. Write direct to Mr. H. J. Saizow, Standard Radio Co., 1440 Walnut St., Kansas City, Mo.

GET THIS BIG RADIO CATALOG FREE

Simply send name TODAY for big 64-page book explaining liberal proposition paying agents \$60 to \$100 a week, and how to make money from latest radio goods. Live dealers and agents wanted.

Standard Radio Co., 1442 Walnut St., Kansas City, Mo.

Applause Cards 1/2 Price

Thank You

Name and Address Printed Free. Stations gladly put on numbers you request. We print special cards that get ATTENTION. Applaud your favorites. Quality cards and printing.

FREE LOG with 1st order

All the Rage. Individual cards at special prices: 100—\$1.45; 200—\$1.95; 300—\$2.45. Money refunded if not delighted. Just pay postman when you get cards.

Send No Money and FREE Log. Order today—NOW.

Radio Printers, Dept. 4413, Marengo, Ill.

Yale GROUND HOG

DOUBLES POWER AND DISTANCE

Marvelous newly-invented ground gives 100% improved reception. Doubles power and distance. Stops leakage. Reduces static. Stops jangling even in mid-summer. Results never before equalled, users say. Satisfaction Guaranteed.

Proven absolutely essential to clear, powerful distance reception. Draws and holds moisture indefinitely. Highly sensitive to radio energy.

SEND NO MONEY—To introduce, we offer to those who act at once, regular \$5.00 size for only \$2.00. Send name today and pay \$2.00 plus 17c postage on delivery. Or send only \$2.00 with order and save postage. **FREE**—Full description of Ground Hog and big money making agent's offer on request—write today.

Yale Specialty Supply Co.
1805 Grand Ave., Kansas City, Mo.

ELIMINATE STATIC!

Enjoy perfect reception regardless of weather conditions. The Static Eliminator—the newest and most starting thing in Radio—cuts out practically all static without loss of volume! And in addition it will help increase selectivity, tune out local stations, sharpen signals, remove noises, lessen interference and prevent re-radiation!

Use it with any receiving set—simply hook up according to our simple instructions and enjoy perfect reception unmarred by static. Satisfaction absolutely guaranteed—Money back if Eliminator is returned within 5 days.

Mail your order today.

\$1.00 Postpaid

THE STATIC ELIMINATOR COMPANY
United Bank Bldg., Cincinnati, O.

STATION SUED FOR LEASEE'S REMARK

For First Time in History, Broadcaster Is Made Defendant in Personal Libel Suit

OKLAHOMA CITY, Okla.—For the first time in the history of broadcasting, a Radio station has been made defendant in a personal libel suit. Action has been taken against KFJF, here, for \$20,000 for alleged libelous statements made by Rev. Lincoln McConnell while the station was leased by him.

Rev. McConnell was for many years an evangelist prior to occupying a regular pulpit and his talks still have the fire of evangelistic flavor. Recently he gave a widely-advertised talk on "The Octopus," which is the general term he applied to the liquor industry. The atmosphere was favorable for reception and the sermon spread far and wide. During his talk he mentioned certain matters regarding the official conduct of Undersheriff Friss of Oklahoma county, to which Mr. Friss took exception and the following day filed suit against Rev. McConnell for \$75,000, and against KFJF as the disseminator for \$20,000.

Experience and a little study of the art of tuning are necessary for the successful operation of any Radio receiver.

Don't Tune by Guess

- KNOW the wave length your set is tuned to
- KNOW your dial numbers for each station in America
- KNOW whom you are receiving without announcement

You can do it all with RADEX

At most good Radio Shops **25c** or sent postpaid RADEX, Box 143-N Cleveland, O.

New Revisable LOG

Loose Leaves—Large Colored Radio Map FREE

New 62 page log. Corrected sheets published as changes in calls, wave lengths, owners, addresses, watts, etc., occur. 468 stations. 4 dial settings, remarks, etc. Tuning suggestions. Station lists by wave lengths—by states, etc. Trouble aids. Dictionary Radio Terms, Repair Hints, Trouble Preventers. Chart showing dial setting for each wave length. Ideal Aerial. Other valuable information. So convenient. Worth many times small cost. Only \$1. Pay postman after log and large FREE map arrive. Postpaid if pay with order. Money refunded if not delighted. Order today—now. Postal will do.

Radio Printers, Dept. 9413M, Marengo, Ill.

ARE YOU THE MAN

to be first in your town to sell and demonstrate POWEROLA, the famous 5 tube NO-BATTERY ELECTRIC LIGHT SOCKET RADIO RECEIVER (not an attachment), universal for D.C. or A.C. (100-115 v., 40-60 cycle), now sold and demonstrated thru THE NEW YORK EDISON CO., public utility companies and radio, electric and music dealers everywhere. Absolutely dependable, fully guaranteed, powerful, practical, perfect in performance.

Are You the Man Who Sees Opportunities Ahead for Real Money Making?

Write for literature, terms and prices at once.

You, Too, Can Make Powerola

Send \$1.00 for wiring diagrams showing parts used and how to make any set or circuit (one to eight tubes) operate satisfactorily from A.C. or D.C. current.

POWEROLA RADIO CORP.
Dept. R.D., 1845 Broadway New York

Nightingale

6-tube Set with Integral Loud Speaker \$75

A wonderful, sharp tuning set of beautiful tone, made complete in our own factory. Five tube assembly suffices for most stations, but volume can be tripled by using 6 tube terminal. No wasteful neutralizing condensers but perfect balance of parts. See Nightingale dealer or write to THE GUTHRIE CO., GRAFTON, OHIO. Makers of the famous Songbird Line

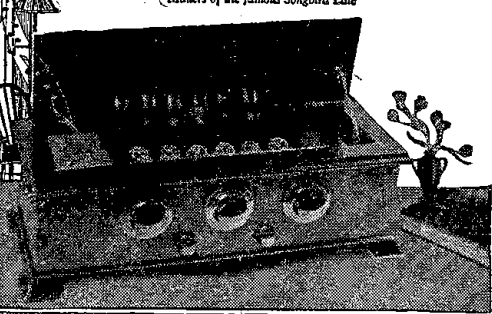

HARRY LOSES TRAIN BUT SAVES SHILLING

LONDON.—When Sir Harry Lauder, the world's famous Scottish comedian, came here to broadcast from 2LO recently, he promised his wife that he would be back in Glasgow the next night, leaving London by the 10 a. m. train.

About 10:01 a. m., he dashed into the depot, breathless, followed by a bellboy carrying a bulky grip.

"Why didna ye hold it up a minute?" he despondently asked a porter. "This is the first time in my life I have ever lost a train."

In his transmission from 2LO Sir Harry included a message to Lady Lauder, listening in Glasgow, thereby saving a shilling on a telegram.

"I am always saving," he explained, with a whimsical smile.

The heart of the vacuum tube is the filament.

For better reception **SHIELD your RADIO**

Perfect shielding materials, write for prices.

Stage Bros. Mfg. Co., Lincoln, Nebr.

\$1.50 for Your Old Radio Tubes

regardless make or condition, toward purchase of each new standard \$2.50 tube. (WD11 or WD12 tubes not accepted). Positively guaranteed. We do not sell re-built or bootleg tubes. Agents wanted.

Super-Service Laboratories, Dept. 56 Room 57, 39 West Adams, Chicago, Ill.

Long Distance Radio

Only \$2.95



200,000 SATISFIED OWNERS

—Getting stations 600 miles away on Lambert Radios. No batteries or tubes required. A real Radio—not a toy or attachment. One to four can listen at once. No howling or screeching noises. Hear local stations on bedsprings, light sockets or telephone. Fully guaranteed. Set, \$2.95—Phones, \$2.95—Aerial, \$1.00. Mail orders filled same day. We pay postage.

LEON LAMBERT RADIO CO.
212 So. Market St., Wichita, Kansas

6-Volt Storage Radio "A" Battery

\$5.00 C.O.D.

Most amazing battery value ever offered! A genuine World 6-Volt Radio "A" Battery with 20 ampere capacity for only \$5.00! Just the thing for Trickle Charger. Famous World Quality assured. Equipped with Solid Rubber Case

an assurance against acid and leakage. Order Now. We ship same day—by express C. O. D. subject to your examination on arrival. Extra Offer: 5% discount for cash in full with order. **ACT TODAY!**

World BATTERY CO.
Dept. 148,
STORAGE BATTERIES 12195 Wabash Ave., Chicago

KDKA—WEAF—WGN—WJS—KHJ—KGO—KFAP—WJY—KOP

22 1/2 Volt un-acid everlasting rechargeable "B" STORAGE BATTERY \$2.95

Includes Chemical



45 volts, \$5.25; 90 volts, \$10.00; 112 1/2 volts, \$12.50; 135 volts, \$14.75; 157 1/2 volts, \$16.80. Truly the biggest buy today. Easily charged on any current including 32-volt systems. Any special detector plate voltage had. Tested and approved by leading authorities such as Popular Radio Laboratories. Over 3 years sold on a non-red tape 30-day trial offer with complete refund if not thoroughly satisfied. Further guaranteed 2 years. Knock-down kits at great savings. Complete "Hawley" "B" battery charger, \$2.75. Sample cell, 35c. Order direct—send no money—simply pay the expressman cost on delivery. Or write for my free literature, testimonials and guarantee. Same Day shipments. B. Hawley Smith, 817 Washington Ave., Danbury, Conn.