

Solve \$500 Mystery Story on Page 6

Radio Digest

EVERY
WEEK

ILLUSTRATED

TEN
CENTS

Vol. XVI No. 10 Copyright 1926 by Radio Digest Publishing Co.

Title Reg. U. S.
Pat. Off. &
Dom. of Canada

MARCH 13, 1926



Indian Chants Basis of American Music; Opportunity Brings WMBB Owner Millions; 1926 Model Four-Filter Super; Women's Programs; Eighteen Stations Give S O S Play

I WON'T BLOOP CLUB IS GETTING RESULTS

LEARN TO OPERATE SET AND HELP CLEAR AIR

Stacks of Pledge Cards Evidence Co-operation of Stations, Clubs, Newspapers and Listeners

As the I WON'T BLOOP CLUB was organized as a medium through which Radio listeners in could receive education in the operation of receivers and through the appliance of the education received and by cooperation reduce preventable interference, immediate results were hardly expected. It will take some time before the air will be cleared of the blooper pest, but the response to the campaign of the Radio Digest for unified action by the listeners themselves has been a revelation. The movement has not only been welcomed but has been enthusiastically received by the fans of both the United States and Canada.

On the Pacific coast, where the word "bloop" has never been used to any extent to specify the dial interference, the campaign has acquainted the section with the name and is uniting the listeners in an endeavor to eliminate that form of interference. A meeting of the Radio Trades Association of Southern California is to be given over to the discussion of ways and means the dealer can use to help eliminate the blooper.

Broadcasting stations, newspapers and listeners' clubs with charters in the I Won't Bloop club are mailing stacks of pledge cards to the Radio Digest each day and, along with scores of individuals, offering suggestions as to methods and helpful hints in limiting interference. A great many demands have been received for the complete series of articles being run in the Radio Digest on "How to Eliminate Blooming and Man-Made Static." Altogether, the cooperation is well organized and it remains for the members of the club to apply the knowledge in operation gained and fulfill the pledges made as applications for membership in the club.

Have You Done Your Part?

Are you willing to cooperate with your neighbor for your mutual advantage? Are you willing to learn the correct operation of your type of receiver? Do you know whether or not you are causing interference? Have you filled out the pledge card printed at the top of this page? If you have not applied for membership in the I Won't Bloop club, do so today. Get your friend and have him join with you. Study the anti-bloop articles appearing in this magazine; learn the causes of blooming and operate your set to prevent it. Then you will be doing your part toward clearing the air for better Radio reception.

Test Your Set

H. J. K. suggests that owners of Radio receivers make the following test to determine if their sets bloop. Tune in some station and then turn up your rheostat or manipulate your regenerative control until the tube is in oscillation and the set starts to howl. Then shut off the set and get in touch with some friend and ask him to tune in the same station while you tune. If he gets a squeal you can be assured that your set is blooming. If you are, correct it.

Be a regular fellow and do your share.

Broadcast River Stages

CINCINNATI.—Reports of the stages of the Ohio river will be broadcast from Crosley WLW here at 10:00 every morning except Sunday when it will be given at 10:30 a. m. Central time.

DUNCAN SISTERS ON THIS WEEK'S COVER

THREE guesses as to the individuals who compose our "Study in Black and White" on the Radio Digest cover this week.

Hush! Wait a minute! You are all correct, the whole million of you!

Of course, one guess was enough, it could have been none other than those inimitable darlings, the Duncan sisters, Vivian and Rosetta.

They are regaling Philadelphia audiences with their big musical hit, "Topsy and Eva." Sometimes they sing to the Radio audiences of WLIT, which furnished the picture on the cover. Rosetta says the microphone always gives her a thrill. She likes to announce as well as do her regular stuff. Rosetta takes the piano to give the regular accompanist a rest when they are guests of the studio. Other members of their cast also have participated in the WLIT programs. You probably know that Vivian plays "Eva" and Rosetta "Topsy."

PLEDGE CARD

Radio Digest

I WON'T BLOOP CLUB

PROGRAMS Illustrated

Reg. U. S. Pat. Off. & Dom. of Canada

I pledge myself to operate my Radio set to reduce radiation or blooming. If I am unable to make my present set operate properly, I further pledge myself to replace it with a receiver that will create less interference.

Make of my set:	Signature
Number of tubes is:	Address
	City and State.....

I am cooperating in this campaign with Station.....
Upon mailing this pledge to Radio Digest, "I Won't Bloop Club" membership card suitable for wallet or framing will be issued.

Broadcast Experiences of Deep-Sea Divers in Sydney

SYDNEY, Australia.—A recent novelty, so far as Australia was concerned, was the broadcasting of the experiences of a couple of divers on the bed of Middle Harbor, Sydney, seventy feet under water. One of the divers was a professional and the other a member of the Royalty society who took the dive in the interests of scientific knowledge.

Milwaukee Elks' Minstrel Show Broadcast by WSOE

MILWAUKEE, Wis.—WSOE, the school of engineering station, recently broadcast by remote control the annual minstrel show of the Benevolent Order of Elks held at their club house. A three-hour performance was held, with choristers, end men and Chauncey Yockey, interlocutor. The show was arranged by the Wisconsin News.

CONTENTS

Radio Digest, Illustrated, Volume XVI, Number 10, published Chicago, Illinois March 13, 1926. Published weekly by Radio Digest Publishing Co. (Incorporated), 510 N. Dearborn Street, Chicago, Illinois. Subscription rates yearly, Five Dollars; Foreign Postage One Dollar additional; single copies Ten Cents. Entered as second class matter at the post office at Chicago, Illinois, under the Act of March 3, 1879. Title Reg. U. S. Patent Office and Dominion of Canada. Copyright 1926 by Radio Digest Publishing Co. All rights reserved.

All the Live News of Radio.....	1 to 11
Indian Chants are Basis of Motif in American Music.....	4
Land of Opportunity Brings Millions to Owner of WMBB.....	5
"A Step On the Stairs," Radio Digest Prize Mystery Story, Third Installment, by Robert J. Casey.....	6
Women's Page; Index to Women's Programs.....	11
An Evening at Home with the Listener In; A Chart in Central Time, showing when to listen in for stations.....	12
Advance Programs for the Week.....	13 to 21
Editorials, Indi-Gest and Condensed by Dielectric.....	22
A B C Radio Fundamentals for Everybody, Part X—Radio Receiver Circuits (Continued), by Milo Gurney.....	23
1926 Model Four-Filter Super-Heterodyne, Part I—The Original and the Improvements, by the Technical Editor.....	25
How to Stop Blooming and Man-Made Static, Part V—A DeForest Device and a New Super Input, by the Technical Staff.....	27
Directory of Radiophone Broadcasting Stations, Part VI. (Revised).....	31

Looking Ahead

Radio Apparatus Manufacturers Estimate That There Are Now 20,000,000 people in the United States who may be listed as regular listeners in. There are about 550 broadcasting stations. Uncle Sam has to keep a ministrative eye over the common rights and welfare of this large population and has delegated the job to Secretary Hoover. Read about Hoover here next week.

Hard Working Housewives Who Have Little Time to Visit beauty parlors and sanatoriums, but still desire to appear lovely to the eye of the man of the house, are finding much comfort and a measure of practical advice through a series of triweekly matinees with experts at the microphone of KOA, Denver. Read how it is worked out in the next issue of Radio Digest.

Radio Stations Now Broadcasting the Dramatization of the Radio Digest especially written serial, "A Step On the Stairs," comprise the strongest league of American stations ever brought together to handle a single feature. The story grows. Situations are becoming more and more complex and mystifying. Don't fail to read the fourth installment next week.

The Second Article on the Four-Filter Super which appears in next week's issue, goes into the laying out and drilling of the panel, sub base and shields. The alterations necessary in some of the parts to adapt them perfectly to this outfit, which is the technical editor's own set, are gone into also.

The Campaign Against Blooming and Man-Made Static, of which the series running in current issues is the backbone, has now covered blooming from all angles and reaches the locating and eliminating of electrical interference as evidenced by hums, clicks, buzzes and hisses. If bothered by some such unknown trouble, these coming articles will enable you to help receiving conditions in your neighborhood a great deal.

Newsstands Don't Always Have One Left

WHEN YOU WANT

Radio Digest

YOU WANT IT!

BE SURE OF YOUR WEEKLY COPY BY SUBSCRIBING NOW

SEND IN THE BLANK TODAY

Publisher Radio Digest,
510 N. Dearborn St.,
Chicago, Illinois.

Please find enclosed check M. O. for Five Dollars (Six, Foreign) for One Year's Subscription to Radio Digest, Illustrated.

Name

Address

City..... State.....

NEWS BRIEFS FROM THE BROADCASTERS

GAY MUSIC OF "PINK LADY" KGO DRAMATIC EVENT

Rotary Boys Band at WTIC—WRC Chooses Champion Fiddler—French Songs at WJZ

The famous musical comedy success, "The Pink Lady," the story of which is based on the French farce, "The Satyr," will be produced over KGO, Saturday night, March 20, at 8 p. m. Pacific time. Carl Anderson, of the KGO staff, will direct the production before the microphones.

WTIC will offer a program by the Rotary Boys band of fifty pieces at 8:30 p. m., Saturday, March 13. This band is sponsored by the Hartford Rotary club and is under the leadership of William Tasillo, director of the Cinderella Ballroom orchestra.

Through contests at WRC, Washington, D. C., the champion fiddler of the Middle Atlantic states has been chosen. "Uncle Am" Stuart of Bristol, Virginia, is ready to match his honors against all comers.

One of the bright spots in WJZ's program last week was the recital of French songs by the internationally known soprano, Madame Adele Bliss.

"An Hour in the Shadow of the Shamrock" is the title under which the WLW instrumental trio and the Crosley male quartet will present a program through WLW, Cincinnati, Wednesday, March 17, at 10 p. m. Central time. Another St. Patrick's Day celebration to be broadcast through WLW will be the entertainment features of the Irish Fellowship club, which will be picked up from the Hotel Gibson roof garden from 6 to 10. Johanna Grosse, studio organist of the WLW staff will also provide a program of Irish melodies during her concert which begins at 11 p. m.

A replica of a musical program broadcast through Station WL of Oslo, Norway, will be sent into the air through WLW, Cincinnati, Tuesday evening, March 16, by the Formica concert orchestra, under the direction of William C. Stoess.

Jazz specialties, trick songs, blues, fox-trot ballads and a liberal sprinkling of old-fashioned waltz numbers are now being given the ethereal right-of-way in a late dance program at KOA every Wednesday evening, featuring Eber Grubb's Broadmoor Rhythm Rustlers.

Frances G. Weller, whose name became well known through her work at Station KQV, Pittsburgh, has given up her Radio work for the time being. She will write critical articles for the Musical Forecast.

Songs of the South interspersed with the very latest popular dance tunes are put into the air nightly by WSM, Nashville, Tennessee, when Francis Craig and his orchestra open the regular evening broadcasting period with their dinner concert from Hotel Hermitage.

An outstanding feature among the Radio programs of Chicago broadcasting stations is the new Chicago theater concert ensemble, heard every Sunday over WGN, during the Chicago theater Sunday noon musical hour.

The little golf bug is beginning to bite. Many Radio devotees will want to hear Archie Simpson, professional of the Clovernook Country club and instructor in the Business Men's club, Cincinnati, tell how to play the game. He will give fifteen-minute talks every Thursday evening at 6 p. m. Central time, through WLW.

Harry Jenson's Night Hawks, known in southern Connecticut as the Palais Royal orchestra, now broadcasts Friday evenings at WTIC, from 11 p. m. to midnight. This orchestra needs little or no introduction to Connecticut fans.

WJAZ, Chicago, is varying its program to please all listeners by devoting two nights a week, Wednesdays and Saturdays, to continuous dance music from the Opera club.

The famous Hindoo poet, philosopher and lecturer, Dhan Gopal Mukerji, gave a dramatic talk at WMC, Memphis, last week. "The Spirit of the Jungle," was the subject of the lecture. Mr. Mukerji, whose home is in Calcutta, is a graduate of several universities.

WILL FORECAST RADIO RECEPTION

DOES BROADCASTING HURT BOX OFFICES?

MANAGERS OF THEATERS ANSWER PRO AND CON

Shubert Interests Defend Broadcasting As Aid in Increasing Receipts Of Productions

NEW YORK.—Does broadcasting a play hurt the box office receipts? That is the question that theatrical managers have been asking themselves for some time. Their answers have been both pro and con. Now the Shubert interests have come out in the defense of broadcasting.

Early in October, Lee and Jake Shubert permitted WJZ to broadcast their play "The Student Prince." The week following the broadcasting of the play, the receipts fell off, but, it did the same at the other theaters, so it was not traceable to broadcasting. However, after two weeks, the advance sale of seats began to jump until the house was sold out each week.

Try It on "Princess Flavia"

The road companies of the show did a tremendous business, all of which was traceable to the fact that the Student Prince was broadcast and people throughout the country heard it.

Now, after four months, the Shubert brothers have again broadcast another of their plays. This time it was the show "Princess Flavia," starring in the leading role Evelyn Herbert, daughter of the late Victor Herbert, who was known for his music in numerous musical comedy and operetta scores.

The play was broadcast through WJZ here on March 7, from the studio of WJZ. At the present time, the mail received indicates, the box office receipts will increase instead of falling down. Perhaps after all this success on the air, other skeptical theatrical managers will permit their shows to be broadcast.

222,000 TELEGRAMS GREET KFNF PARTY

Anniversary Celebration Features Continuous Program Lasting Thirty-Four Hours

SHENANDOAH, Ia.—If telegrams are an indication of popularity, then KFNF, the Henry Field Seed Company station here, must be one of the most popular stations in the country, for on its recent anniversary celebration, featuring a continuous program lasting thirty-four hours, over 222,000 telegrams were received.

And they are still coming in! In addition, the letters have been keeping the Shenandoah post office busy, and no effort has been made to count them.

The anniversary program began at noon one day and continued through to 10 p. m. the next night. Over ten thousand people visited the KFNF studios during the two days.

Transportation Clause Threatening Radio Bill

Believe Commerce Restrictions May Prove Stumbling Block

WASHINGTON.—Considerable talk and speculation has resulted from the amendments to the White Radio bill by the merchant marine and fisheries committee among members of the house and officials of the government connected with Radio activities.

The prevailing opinion is that Section 4, which prevents the transportation in interstate commerce of Radio apparatus or tubes upon which restrictions are placed, may be the cause of considerable discussion and perhaps be a serious stumbling block in the way of passage of the bill.

The White bill has been placed on the house calendar where it would take its turn among a large number of other bills. It is the hope of Representative White that a special rule may be obtained for the immediate consideration of the Radio bill.

Karolus Cell Trials Held

BERLIN.—Trials of the Karolus cell process of telephoto-transmission are being made at present between Berlin and Leipzig, daily.

BLIND PIANIST GETS REPERTOIRE BY AIR

PHILLIPSBURG, Kansas.—Although George Newell is totally blind, he is able to keep abreast of the musical times and satisfactorily fill the difficult position of pianist in a motion picture theater, here. Through long practice, he is able to memorize a composition at one hearing, and he writes that each evening after the show is over, he goes home and listens to Station KFI. By this method he keeps his repertoire up to date.

GOVERNMENT IS WORKING ON PLANS TO GIVE OUT REPORTS

Station WCAJ Pioneering in Effort and Bureau of Standards Experimenting to Make Information as Reliable as Weather Reports

By Thomas Stevenson

WASHINGTON.—Forecasts of Radio reception conditions by the government, somewhat along the lines of dialy weather reports, is a development anticipated for the near future.

Such a daily service to the millions of Radio fans has been considered by several government agencies at Washington. Experimental work has been done by the bureau of standards to establish the connection between the weather and Radio reception.

Officials of the bureau of standards are none too well pleased with the progress of these experiments, but they are confident the time will come when they will know more about it.

WCAJ Already Doing It

Weather bureau experts do not believe the experimental work has yet progressed to a point where it would be safe to forecast whether it might be possible in the near future to prepare daily Radio reception forecasts.

Washington officials have been watching with particular interest the experiment of the Nebraska Wesleyan university in preparing daily Radio forecasts.

For the past several months, J. C. Jensen, of the department of physics of the Nebraska Wesleyan university, has prepared a daily Radio reception forecast which is broadcast through Station WCAJ at 4:30 p. m. Central time.

"As a result of years of study and investigation," says Mr. Jensen, "the United States has come to be depended upon as a reliable source of information concerning weather conditions. Farmers cut their hay when fair weather is predicted, and city folks delay their automobile picnics over unpaved roads when the forecaster says 'Thunder storms probable.'

Many People Dependent on Conditions

"With so many people now depending largely on Radio for their entertainment, and with the quality of that entertainment varying so much from night to night, any plan by which receiving conditions may be predicted with reasonable accuracy should be of general interest. If the Radio fan can be forewarned that static will be unusually bad, he can change his plan for a Radio party, and do something else.

"If he knows beforehand that signals will be weak from the southeast but good to the north and west, he can save time by tuning directly for Los Angeles, or Denver, or Minneapolis, instead of saying 'Why can't I get Havana tonight?' after a prolonged effort. That this very thing may soon come about as a regular feature of weather forecasting is not at all improbable.

Progress of Studies to Date

"Many studies have already been made in this field. Among them may be mentioned the researches of Dr. L. W. Austin of the naval laboratory at Washington, Dr. G. W. Pickard of Boston, Professor Van Cleef of Ohio State university, the American Radio Relay league, and the bureau of standards.

"It is well known that heavy static is worst in the southeast quadrant of a low barometer area, and that the cloudy to clear days following the passage of a storm are favorable for Radio work. It is also known that signals are stronger at night than in the daytime, and that fading is much less troublesome in daylight.

How WCAJ Reports Are Made

"In the Radio laboratory at Nebraska Wesleyan university the measurement of signal audibilities and the recording of fading curves has received considerable attention. A paper on the relation of Radio audibilities to weather conditions, by M. P. Brunig, was published three years ago in the Monthly Weather Review. Being located in the center of the United States with broadcasting stations in every direction, this laboratory has unusual opportunities for plotting fading curves from the four points of the compass, and hence from regions of different

(Continued on page 10)

RADIO FIRST TO INTRODUCE STAR



Radio scored a decided "scoop" over moving pictures recently when, two nights after she had created a sensation with the Metropolitan Opera at New York, Miss Marion Talley, 19-year-old Kansas City girl, was introduced and "shown" to the Radio audiences through WJZ and a number of other stations throughout the country.

DONATE RECEIVERS TO HOMES FOR DISABLED

Listeners to Station WGCP Asked to Name Institutions

NEWARK, N. J.—The Splitdorf Electrical company of this city has announced its intention of donating ten complete Radio installations to ten deserving institutions for disabled aged or sick, the presentations to be made on April 15.

In order that these ten sets might go to the most deserving homes, the Splitdorf company is asking listeners of Station WGCP to pick the institutions which will benefit most from the use of the sets.

Spokane Fights Interference

SPOKANE, Wash.—The Radio Listeners association here is planing a series of conferences with Spokane's wholesale and retail Radio dealers for the purpose of obtaining their cooperation in the association's campaign for elimination of interference, according to an announcement by Dr. C. Hale Kimble, president.

Judge Has "Revenge" On Radio Announcer

Broadcaster of Time Signals Finds No Judicial Leniency

WASHINGTON, D. C.—Revenge is sweet, especially when it can be brought about in a perfectly legally constituted manner.

This is the opinion of Judge John P. McMahon, ardent Radio enthusiast, who was presiding over traffic court when Walter C. Myers, broadcaster of the Arlington time signals from NAA, was brought before him to answer to charges of speeding.

Myers admitted exceeding the speed limit, but stated that he was hurrying to the broadcasting station to start the ten o'clock signals.

Judge McMahon told the defendant that many people would not care if he never got there to interrupt the political and musical programs that are on the air at that hour. Thereupon the magistrate imposed a fine of \$15.

Indians Originate Our Motif



NOTED Composer Holds That Typically American Music Is Derived from Chants and Songs of Love and War by Noble Red Man



THANKS to the loud speakers and the head phones we laymen are learning more about the finer things in music. It comes to us in profusion. There are so many kinds sometimes we are a little confused. A twist of the wrist and a bubbling streamlet comes purling into the room from one direction. We bathe in it until the idea occurs to us that we would like something different. Another turn of the dial and another stream fountains into the room with a different character of music. We discover that different nations produce their characteristic melodies. The Russians have their "Volga Boat Song"; the Italians their high-keyed arias; the Germans their thunderous harmonies; there are the plaintive strains of the Orient; the vivacious and rippling cadences of the Spanish themes. The French, English, Scotch and Irish all have their peculiarities.

But what is the characteristic American motif?

Here we are, a melting pot of all the nations, with original American stock running back not more than four hundred years and that stock coming from the other side of the world. Out of the conglomeration of human breeds have we developed a distinctive type of music?

"Yes, indeed, we have," responds Thurlow Lieurance from the Sears-Roebuck station, WLS, Chicago. "Our purely American musical strain ante-dates the arrival of Columbus. It is voiced by the aboriginal American—the red man of the forest, the lake, mountains and plains.

"It breathes the moaning and sighing of the trees, the laugh of splashing waterfalls, radiance of the flowers, the murmur of the deep flowing rivers, the trill of the birds, the cry of the untamed creatures of the forest—each a living voice in the heart of the Indian as he weaves them into the song for the lover, worship of the unseen spirits, praise of the warrior, voice of the hunt and accompaniments for his many dances."

And Mr. Lieurance should know for he has made the study of Indian music his life work. He has transcribed the primitive refrains into modern scores, which, in turn, have been translated into all the civilized languages of the world. No-where else is there a North American (Continued on page 24)



ONLY the American Indian is entitled to credit for a distinctive and typical theme for American music, according to Thurlow Lieurance, well-known pianist and composer who presented a recital recently over WLS, Chicago. His famous song "By the Waters of Minnetonka," was inspired while visiting a Sioux village in South Dakota where he heard the Indians sing the legend of the lovers of opposite clans in their own tribe who ran away and submerged themselves with their canoe beneath the waters of Minnetonka.

Morning Cloud, (above), sweet singer of the Sioux singing the Minnetonka legend into the WGY microphone at Schenectady. Below are other members of the Sioux warriors who visited the WGY studio with Col. Miller (seated, center) and old Ezra Meeker of Oregon trail, seated at left.



Thurlow Lieurance, composer of "By the Waters of Minnetonka," calls Indian music American motif.

Below are members of the Onondagas who broadcast their idea of typical American music from the WGY studio. It had a faint resemblance to Swiss yodeling, critics said.



WMBB Owner Believes in U. S.

ANDREW KARZAS Proves "America Is Land of Opportunity." Makes Millions in Few Years Building Theaters and Ballroom Palaces in Chicago and Its Suburbs.

By HAROLD P. BROWN

SOMETIMES good citizens weary of the phrase "America is the land of opportunity." They think it is trite, merely obvious, just something to say when one has mentioned the weather and the state of one's health. Ponderous orators work it to death during the month of June when they stand up before the graduating classes and proclaim impressively that "America is the land of opportunity."

But I know a man who takes it seriously, always did take it seriously and made millions because he did. His name is Andrew Karzas and he is the power behind the generators of the WMBB broadcasting station located on the Trianon, "the world's most beautiful ballroom, Chicago."

He's a terribly shy man for a pusher and a get-there. He loves dignity and abhors blatancy. He won't thank me at all for this story because I have so much to say about him. He would rather that I utilize this space to describe the alluring charms of the truly remarkable ballroom. But I believe Radio listeners will be more interested in this personality who believes in American opportunity and who made WMBB possible.

ANDREW Karzas came to America from Athens because somebody over there told him that opportunity was here. He is of good parentage, has uncles and cousins who are up in the government and army over there but that was not the kind of opportunity Andrew wanted. It was not the kind of opportunity he pictured for himself in America. The family purse did not afford him any special advantages in getting his start. But he had a head and a sturdy body and he went into business immediately.

Pennies, nickels and dimes became dollars and dollars became opportunity. He took another step on the ladder and I first knew him when he moved into a little stall on Sixty-third street, east of Cottage Grove avenue, lately abandoned as a shoe store. He called it the "De Luxe Theater." His younger brother, William, joined him and the two of them put in long, arduous and industrious hours. I don't believe the place would seat 200 people but every seat was doing its share. A year or two of that and Andrew moved into the Drexel, which was the real de luxe theater in the next block.

He took a great interest in Woodlawn and the neighborhood affairs. School children were given special entertainments, sometimes with all the profits going to a local cause. But everybody took a liking to Karzas. The mothers felt kindly toward him and the fact that he was a Greek made not the slightest difference to the rather exclusive Woodlawn Business Men's association.

Director J. B. Lampe (standing) in the WMBB studio in the Trianon ballroom (below).

When she is not engaged in musical drama, Miss Lola Schofield (above) has helped make the WMBB programs pleasant with her dramatic soprano voice, while lively dance music may always be depended upon from Dell Lampe's Syncopators (below). They finish by singing "W-M-B-B Chi-ca-go".



Andrew Karzas (above) who found American opportunity no idle saying.

IN FACT the community was proud of him. He certainly was showing the rest of us around there that America is the land of opportunity. It was not hard for him to have an ordinance passed the next year condemning an alley in the block across the street. It was of no use to anyone but himself, anyway, as he owned all the property to the point where it connected with an adjoining alley. A row of stores went down under the sledges of a wrecking company and in their place there sprang up a picture theater that was declared at the time by the trade papers to be the most beautiful picture theater in America—"The Woodlawn."

It was a tremendous success. At every performance people stood in long lines waiting to get in. It made big money. Andrew had an office in the basement. He still has his office there. Then came the first realization of his most ambitious dreams. He went to Europe and looked around for an exact crystallization of his ideas, came back and built the Trianon (Continued on page 8)

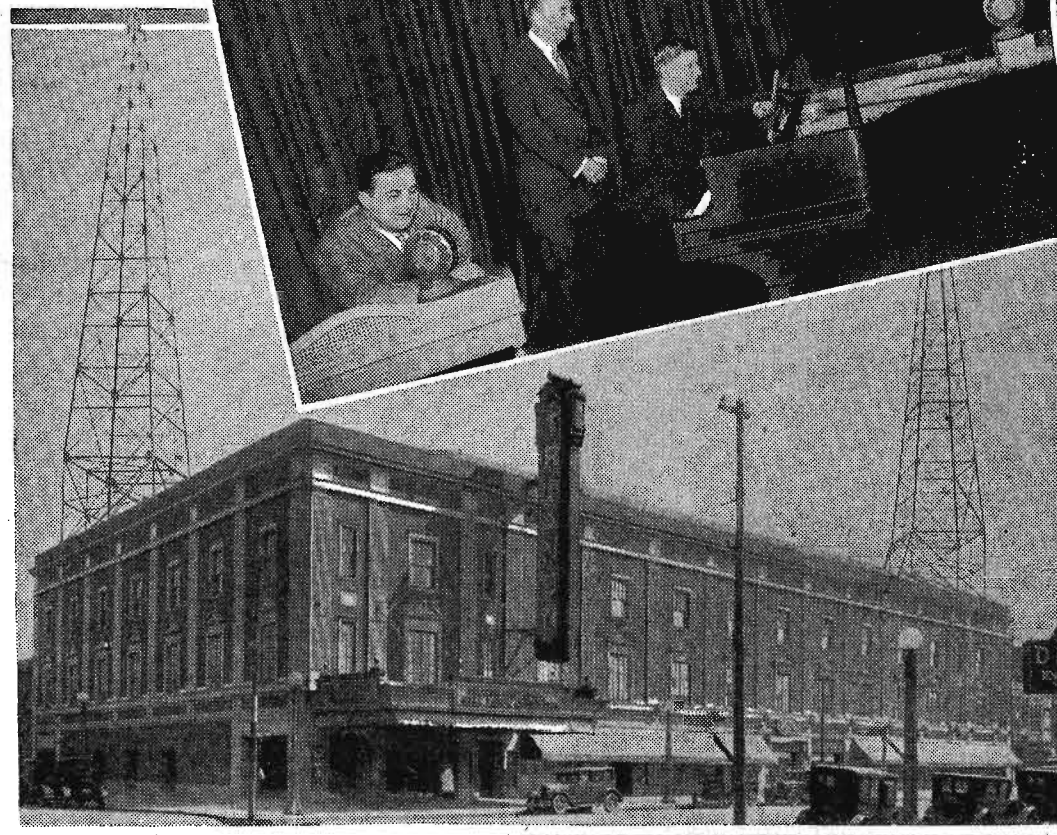

a STEP ON ^{the} STAIRS

By **ROBERT J. CASEY**

Radio Dramatization by **FRED SMITH**

Illustrations by **HILMER C. OLSON**

Synopsis of Preceding Chapters

GRAM and ghostly mystery settled down on the old manor house of the Turners on Pelican Bay shortly before events chronicled in this story. The manse had come down through one hundred and fifty years of sea-faring Turners and then Jeremiah Turner was found dead with a bullet in his head on the hearth of the gun-room floor. They carried his body out the door reserved exclusively for the removal of the dead masters of the house. Soon after, the body of Peleg Turner, a brother, followed the same course. He seemed to have died from natural causes.

Lawyer Ardwyn, his executor, summoned the relatives for a weird seance in the deep shadowed hunt-room, lighted only by a candleabra. A letter left with the attorney had stated that the departed Peleg would attempt to communicate his discoveries beyond the grave through the Radio. The story opens with the party assembled. Only John Carton, a favorite nephew, is missing. He had been suspected of the crime. Henry Millis, the caretaker, had been startled by the arrival of a man in a gray overcoat from the stormy waters of the bay. The man said he had been called to the meeting, but Hari Singh reported later to Henry that he had never arrived at the house.

The clock struck twelve. There was a scratching sound in the receiver. A few syllables were uttered. Then followed an interruption. The voice of the announcer at F.Y.X., a nearby broadcasting station, called for help and a shot was fired. The listeners who were sitting in absolute darkness rushed for the locked exits in confusion. They already had heard ghostly sounds on the stairs and a mysterious tapping similar to an SOS signal. Finally, when a bit of candle was lighted, it was found that Milford Jones, one of the guests, was missing.

Tolliver, another guest, was appointed to investigate the F.Y.X. shooting. He found that a stranger had broken into the broadcasting station, shot the engineer and escaped unidentified. The wounded man was taken to a hospital but Tolliver discovered a trail of blood and picked up a letter which he handed to Ardwyn at the table. Just as the lawyer was about to open it Mary Williams, a friend of Carton, and sought in marriage by another cousin, Henry Graves, accidentally knocked the only candle to the floor.

In the darkness that followed Ardwyn felt the hair of a woman brush his hand and his wrist was caught in a savage bite. Another candle was lighted. The letter had disappeared.

THE STORY CONTINUES.

Mary Williams accepted the bit of jewelry from Ardwyn's bandaged hand and looked at it complacently. If the lawyer, watching her from beneath lowering eyelids, had wished to test her, he received no satisfaction.

CHAPTER FIVE

Trail of a Tigress

A SENSE of guilt sat heavily on the harried occupants of the hunt room. Men and women moved restlessly in their chairs and eyed one another appraisingly the while they kept up that brave show of nonchalance which is man's instinctive armor against fancied suspicion. Ardwyn, intent upon his bleeding wrist, gave no sign that he noticed what was going on about him. The clock struck one. Aunt Helen sighed, and in doing so acted for virtually all of the eleven who had braved the terrors of Peleg Turner's house.

"Only one o'clock," came a voice from the shadows. "Only an hour and it has seemed like three worthless lifetimes." Hari Singh, calm as always, came forward to inspect the lawyer's wound.

"I can dress it, Sahib," he said. "The

cut is only superficial. But of course such things are dangerous unless we attend to them at once."

"I suppose so, Hari Singh," replied Ardwyn. "But I can speak only through hearsay. I cannot remember ever having been chewed up by a woman before."

"I think, ladies and gentlemen, that it might be well for us to interrupt this session. It was Mr. Turner's wish that we continue this effort to communicate with him as long as it might be humanly possible to do so. But some of us might not be able to stand a continuation of this experience without a recess. You have coffee, have you not, Hari Singh?"

"Yes, Sahib, there is plenty of coffee in the kitchen and there are sandwiches in the ice box. I can attend to that in a moment after I bandage Sahib Ardwyn's hand."

Aunt Helen, who had been sitting fanning herself distractedly, was suddenly brought back to her normal self.

"Mr. Ardwyn," she called. "Mr. Ardwyn. Couldn't I make the coffee? I'd be very willing to—and I could serve the sandwiches, too, if we all could go into the library where we'd have some light."

"That might be a good plan, Mrs. Holmes," agreed the lawyer. "Naturally I should like to have my hand attended to and I do not know how long it will take Hari Singh. At one-thirty we shall make another attempt to hear the message of Peleg Turner over the Radio. Until that time you may go wherever you please, ladies and gentlemen, although I must ask that you do not leave the house whatever the provocation."

Instant approval from all quarters of the shadowy room greeted the suggestion, and almost before the lawyer had finished speaking most of the guests were on their feet—

trooping toward the door after Aunt Helen. Ardwyn had started to follow them when he noticed a slim figure in the gloom at the end of the table.

"Aren't you going, too, Miss Williams?" he inquired.

Mary Williams shook her head.

"No, Mr. Ardwyn," she said. "I feel too weak to walk even as far as the library. I think it may quiet my nerves a bit just to sit here and rest."

"You are sure you will not mind being left alone here in this room?"

"I shan't mind it at all, Mr. Ardwyn. There can be nothing wrong with the room, once the people have gone out of it."

The lawyer coughed queerly.

"That candle won't last long," he said. "And it will be dark in here when it goes out. Strange things happen here in the dark, Miss Williams."

"I feel that they might happen just as easily anywhere else in this house," she replied.

"Yes," he admitted with no hint of a double meaning in his tone. "Anywhere you might be it would not be at all illogical to expect trouble. Come, Hari Singh, let us get this job done."

MARY WILLIAMS settled back into the chair as their voices blurred in the outer hallway. The shadows seemed to settle down about her and she was scarcely discernible in the wavering candle light. She sat with her eyes half closed but she was very alert and tense and she was on her feet instantly when the door creaked slightly and a man stepped out of the hall into the halo of the candle.

"Henry Graves," she breathed half to herself. "What are you doing here?"

"I might ask the same of you," he answered easily.

"I stayed here because I wished to be alone," she told him. "I don't think I need to tell you that."

"And I came back here because I wished to be with you," he stated, mocking her tone and manner. "And I hardly think I need tell you that."

"Don't be foolish, Henry," she admonished him. "This is neither the time nor the place for one of your usual scenes."

"Ho hum," he said. "You do not know how beautiful you are Mary. There is never a place where I shall be able to look at you without loving you and there is never a time when I shall be discouraged from asking you to marry me."

"I have told you repeatedly that I don't wish to have anything to do with you."

"I know that, Mary, but I have not given up hope. There may be a time when you will need me . . . And I am not entirely convinced that tonight isn't the night."

"Just what are you talking about?"

"We understand each other, Mary. You are intelligent and I don't think lengthy explanations are necessary at all. I have asked you to marry me as a sort of personal favor many, many times. You know that."

"Yes, please don't bother to enumerate. Go away, Henry, and leave me alone."

He looked at her for a moment unperturbed.

"**I'M NOT** going to go, Mary, until I have said what I came to say," he declared. "When I have finished you can decide what you intend to do. I have talked of love for love's sake long enough. Now I am going to go at this matter from a business standpoint."

"What?"

"I know it is a bald way to put it, but my meaning is clear. You have gotten yourself all tangled up in a nasty mess tonight, Mary. You've gone one step too far and you'll never get out of it by your own wits. You need help. That's what I am offering."

"Mr. Graves, I haven't the slightest idea what you are talking about. You may be crazy or intoxicated. But in either event you are insulting."

"I am offering to marry you, Mary. I am offering to keep your secret and get you out of here so that nobody will dare breathe a suspicion against you. But I am candidly offering my aid on condition that we leave here at once and go to the minister's house in Portsmouth."



HEAR This as a Play from Your Favorite Station. The Schedule Appears on Page 13.

Even in the candlelight the increasing whiteness of the girl's face gave unmistakable evidence of her anger.

"Henry Graves," she said. "I hate you. I have always hated you. I could see in you just the oily scoundrel that you are showing yourself to be. What have I to conceal? What secret have I that needs the protection of a man like you? Get out of here before I call Mr. Ardwyn and have you thrown out."

"I said I should stay here until I told you what I came to tell," retorted Graves calmly. "And I shall do that, Mary. I don't think you will care to call for help from anyone but me. I may state the case:

"Hari Singh has told me that he saw you near this house on the night Jeremiah Turner was shot. You were out late on the night when Peleg Turner died. A moment ago some person—some woman—bit Frederick Ardwyn on the hand. Your chair was empty. I wondered what you were up to and I made sure. You're a queer girl, Mary, but I don't mind that. I'll take care of you if you give me the chance."

When Mary Williams replied, her voice was hoarse but otherwise perfectly controlled and she clipped her words with icy precision.

"Are you insinuating," she asked, "that I killed Jeremiah Turner?"

He sighed as if in slight patience with such trivialities.

"I don't care whether you did or not, Mary," he said. "I love you. I—" He stopped suddenly and both sat upright.

"THE step on the stairs again," whispered Mary. "Someone is coming down the stairs"—and then she breathed audibly in relief as the figure of Ardwyn came into silhouette momentarily against the light that filtered from the library.

"It's Mr. Ardwyn," she whispered. "You had better be going."

"Your answer is no, then," he asked harshly.

"It will always be no," she stated. "And I warn you that if you cross me in any fashion I shall scratch your eyes out."

"Very well, Mary," he said as he arose. "I can guarantee that you will get the opportunity. If Ardwyn weren't coming in here the chance might come sooner than you had expected."

"Going out, Mr. Graves?" came Ardwyn's voice. "Well, no matter, I shall keep Miss Williams company myself." Graves did not reply as he stalked out.

"The evening seems to have gotten onto the young man's nerves," observed the lawyer.

"Yes," admitted Mary. "He seemed displeased when I told him that I wished to be alone."

Ardwyn laughed. "And I suppose you are suggesting that other company might not be any more welcome," he said. "Well, I came purely as a matter of business. I had something to say to you that I thought had best not be said before the others. This is your brooch, isn't it?" He held a trinket under the candle light where she might see it plainly.

"Yes," she said. "It is mine. I didn't even know that I had lost it."

"That is natural enough, considering the excitement of the last hour. There is nothing significant in the loss of a brooch or in failure to notice its loss. But what I wanted to tell you is that it has been in queer company. The woman who bit my wrist a moment ago when the candle was overturned and the letter was taken from the table there, was wearing this brooch. It got tangled in my watch chain when I tried to catch her . . ."

CHAPTER SIX

A Door Opens

MARY TURNER accepted the bit of jewelry from Ardwyn's bandaged hand and looked at it complacently. If the lawyer, watching her from beneath lowering eyelids had wished to test her, he received no satisfaction. Her manner was

quite as it might have been had he found the bauble in the street and returned it to her in the full light of day instead of here in the most malign room of an accursed house.

She laughed, a bit nervously, perhaps, but without effort.

"It would be easy to convict me on this evidence," she admitted. "I should have left the brooch at home. Someone may have dropped it there just to direct attention toward me. That is possible of course."

"The woman who chewed my wrist was wearing the brooch, Miss Williams. It is hardly possible that she could have foreseen she might get it entangled with my watch chain."

"It is very puzzling," the girl agreed. "And I have no brains for puzzles. I don't like to think. It makes my head ache."

Ardwyn made a gruff noise in his throat.

"On that point, Miss Williams, I respect you very much indeed," he told her. "You need not try to mask yourself from me. You would be a dangerous foe."

"I'm not at all dangerous," denied Mary Williams. "But I am upset about all this. Mr. Ardwyn, tell me the truth. Why are we here?"

"I have already told you everything I know about it. Peleg Turner's last letter was self explanatory."

"Bosh," she said with some heat. "There is something more to it than a crazy seance with a Radio set. I have

admitted that I am simple, but I am not that simple.

"Something has been going on in this room that cannot be ascribed merely to the panic of the weird crew that you have assembled here. I have felt that all along."

"I have felt it, too, Miss Williams. I shall admit that to you. And I shall admit something more. I know instinctively that the murderer of Jeremiah Turner is in this house at this moment." He paused significantly.

"You are looking at me, Mr. Ardwyn," Mary Williams replied with odd composure. "Am I to take it that you, too, suspect me of having been implicated in that?"

"SOMEONE else has suggested it?" "Henry Graves suggested it. He wished me to marry him as the price of his silence. And now you . . ."

"I have not gone so far as to make such a suggestion, Miss Williams," Ardwyn broke in, "but I can say candidly that I do not fathom you. I should like to know, for instance, why you chose to stay here alone in this room after the others had left."

The girl murmured impatiently. "I shall have to tell you that because there is no getting rid of you," she told him. "I stayed here because I expected somebody to come in through that front door and I couldn't trust anybody else in the place—not even you—to keep the vigil."

"Through the front door," the lawyer

scoffed. "That is silly. I pointed out once before, tonight, that the door is locked and barred."

"I know that," the girl admitted. "I can't explain it any more than I can explain how a stage magician takes rabbits out of a hat. But I know this: the door was open once before while we were locked in here. One man of this company went out through it."

"Jones probably got out some other way."

"Any other exit was as closely locked as the front door, Mr. Ardwyn. One gets nowhere by substituting one mystery for another."

"When the door opened I felt the draft before Aunt Helen did," Mary continued. "Somebody brushed past me in the dark—somebody came in—and then somebody went out again."

"If legend is worth anything the one who went out probably will be a corpse by this time, but the one who came in first will be back again and the time won't be long now."

"I have a light," came the voice of Hari Singh. . . "Why it's Mr. Ardwyn with blood all over his face. . . And Miss Williams. . . Stand back, please. She's not dead. . . What's this in her hand?"



The lawyer looked at her in frank amazement.

"You seem to be very confident about this matter," he observed.

"I have every reason to be," she said. She leaned over the arm of her chair and picked up a pair of shoes.

"LOOK at these," she said, "extending them toward him—shoes—men's shoes. They are damp from melted snow—that shows that whoever wore them has been out in the storm since we came in here."

"On the other hand whoever wore them was suddenly frightened away and left in his stocking feet. It is natural to suppose that nobody could long wander about there through the drifts in his bare feet. Our intruder will be back here looking for his shoes."

"Why should he have taken his shoes off?" demanded Ardwyn, still skeptical.

"Whatever his purpose was in this room, he did not wish to be detected," the girl said. "Whoever it was came for some sinister purpose, not to listen to the Radio. I know that you don't trust me, Mr. Ardwyn. But I am asking you to stay here, now that you know what I know, and see for yourself what happens."

For a moment the lawyer was silent. "Very well, Miss Williams," he said at length. "I shall stay here and I shall see what I shall see. But I may say in advance that once I find out

(Continued on page 29)

CLAIMS RADIO WILL LIMIT NEWSPAPERS

EDITOR DECLARES PRESS
WILL BE SUPERSEDED

Predicts Papers Will Be Greatly Improved by Becoming Purveyors of Public Intelligence

LONDON.—Hamilton Fyfe, famous journalist and editor of the London "Daily Herald," the leading organ of the English labor party, has declared in evidence before the broadcasting investigation committee, that the daily newspaper as it exists today is destined to be superseded by radio.

Mr. Fyfe expects no such change for a long time, but says the press should meet it ungrudgingly, and not put artificial obstructions in its way, as such a development will be advantageous both to the public and to journalists.

"Radio in the future," said Mr. Fyfe, "will be fitted not only in all houses, but to all trains, street cars, busses, and in all public places. In a short time we shall all carry ear phones about with us and be able to pick up messages wherever we are.

Describes Future Newspaper

"This will change newspapers from collections of entertaining scraps to organs of opinions, purveyors of intelligence for those who study world events. Those who regard papers simply as a help to passing time will find radio news enough for them.

"Those who want full information, competent criticism, market details and prices, sport, literature, and art articles, or any other special line, will continue to read newspapers. The benefit to such people and to journalists will be great. Circulations will be smaller, prices higher, advertisements less important. Journalism will become once more a serious profession. Important news will not be sacrificed to snappy, spicy items, divorce case and murder trial reports.

'Sunshine Man' in Chicago with Joy

Billy B. Van, "Gay Paree" Star, Affiliates with WJJD to Organize Sunshine Club Chapter

CHICAGO.—Billy B. Van, "The Sunshine Man" and comedian extraordinary, whose work was prominently featured recently in Radio Digest, has come to Chicago. As a result, rays of sunshine are already radiating from the Moose station, WJJD, at Mooseheart, with studios in the Palmer House here.

When Billy came to this city he took steps immediately to form a new chapter of his Sunshine club. WJJD was elected and he began his work there for a month, starting March 1. He can be heard every Monday, Wednesday and Friday at 8:40 p. m. Central time. Tune in this stage philosopher and tune out all gloom and sorrows.

His work at propagating sunshine will long be remembered in Boston and New York. "Just going to spread a little sunshine in the Middle West," said Billy Van when interviewed, "so I'm working over WJJD."

Maybe you think that's all he has to do. No, Billy is a busy man. His main business in Chicago is manufacturing laughs as leading comedian in "Gay Paree," a musical comedy full of pep and merriment, and with much in its favor. It's showing at the Apollo theater here. Then he is a business man, too. He invented the formula for Pine Tree soap, the only soap that contains pine oil as a blended constituent and that will lather in salt water.

But then, you would expect Billy to invent soap—something to brighten up the dark corners.

Yes, while here he will run a Sunshine limerick contest, as he did in the East. The one held in Boston was won by a little blind girl, who received an expensive radio receiver as first prize. The judges didn't know she was blind until after the prize had been awarded, but how well it all turned out!

Just smile away your troubles and everything will always turn out right, says Billy.

Program Aids War Vets

SPOKANE, Wash.—A Radio musical program held here recently netted \$700 for the fund for disabled veterans of the World war, according to Mrs. H. B. Graybill, of the State Federation of Women's clubs, whose auspices it was under.

WEAF ANNOUNCERS CAUSE FAMILY ROW

NEW YORK.—A great controversy has raged for some weeks past in a New Jersey household, according to a letter received by WEAF. It all started over the announcing of WEAF causing disagreements among members of the family as to who was announcing. One member of the family would insist with positiveness that it was Graham McNamee. Another was equally certain that it was Phillips Carlin. The third, and youngest, argued that it could be none other than James Haupt. In order to preserve the peace in this home, WEAF has sent an announcing schedule which is adhered to.

BODY ACROSS WIRES BURNS OUT STATION

MONTREAL, Canada.—A charred body lying across several wires gave mute evidence as to the cause of the short-circuiting of the entire system of Station CKAC, La Presse, here, recently. The electrocution put the station out of commission and brought a loss of approximately \$5,000, besides the inconvenience and embarrassment of having the program stopped. But no mourners of the dead victim have been located, as it happened to be just an ordinary little brown mouse. Every one of the fourteen rectifying, oscillating and modulating tubes, were destroyed.

J. B. LAMPE TAUGHT LOPEZ TRICKS

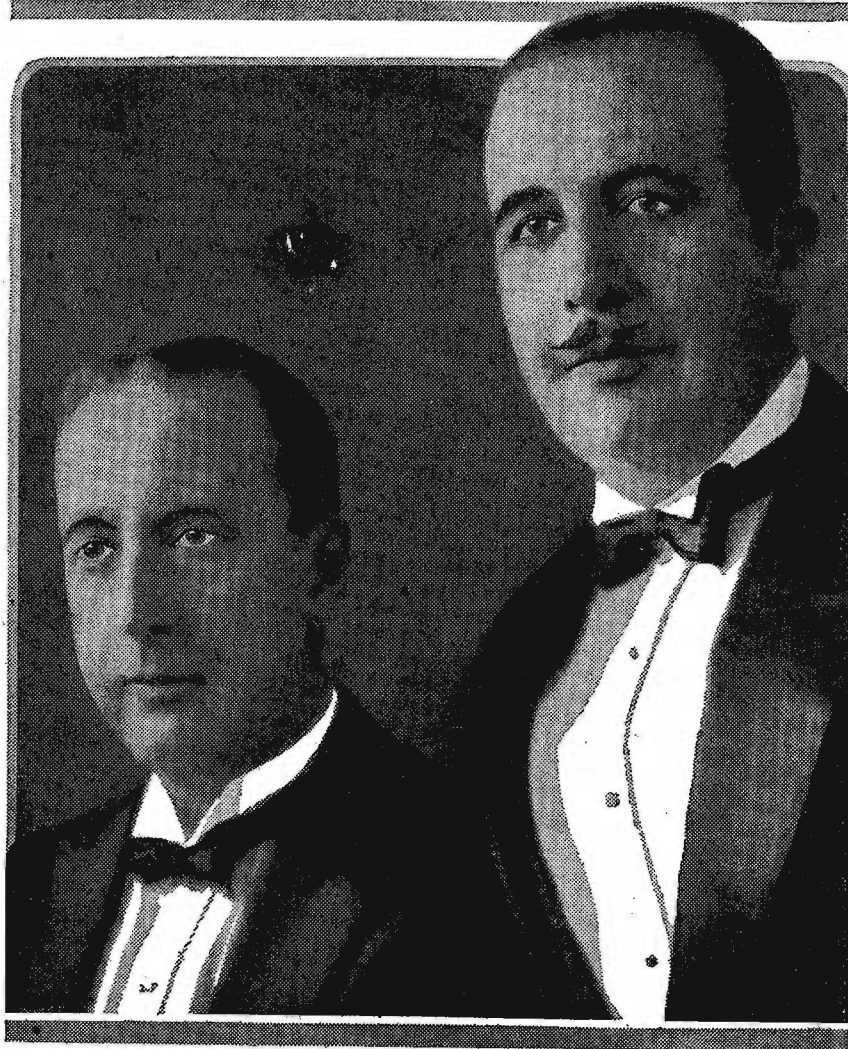

Among the bright lights of the many brilliant features of Station WMBB, Chicago, are the Lampes. J. Bodewalt Lampe (left) is the general director of the music at the Trianon ballroom. His son, Dell, (right) directs the Dell Lampe orchestra and the Syncopators. The father taught Vincent Lopez much of what he knows.

WMBB BELIEVES IN U. S.

(Continued from page 5)

ballroom—the "WMBB—World's Most Beautiful Ballroom." The real society of Chicago—first families and all that—opened it for him. They simply overwhelmed him with congratulations. It was his first million-dollar enterprise.

The American Bond and Mortgage company found Andrew Karzas could be trusted with money as far as he wanted to go. He borrowed and paid his obligations when they were due. So other enterprises soon blossomed. East, west, north and south Karzas spread out. His judgment was unerring. Half a dozen theaters, some of them with investments running as high as \$5,000,000, were under way. From Hammond, Indiana, where the Calumet steel development shot values skylarking in the course of a few months, he had the foundations of one of the finest picture theaters in the country under way. He bought a big corner at Cottage Grove avenue and Seventy-ninth street, in the heart of another big real estate boom. He recently opened his Northcenter theater, another palatial house. In June, the Woodlawn, the theater which put him in the millionaire class, will be torn down and a whole block of store buildings will go down with it for the square on four streets. It will be the location for his greatest and grandest—the most wonderful moving picture theater in the world.

On the roof of the Trianon spangles the antenna of the broadcasting station. It has been on the air for two years now. All of the beauty and charm, however,

are within the four walls. The ballroom is an elliptical area, with a system of specially designed indirect lighting. It is adorned with gorgeous draperies, boxes, balconies, colonnades and a floor that is the ultimate of the engineer's skill.

J. Bodewalt Lampe and his son, Dell, were brought from New York to take charge of the music and it is the Lampe orchestra which furnishes the supreme delight of WMBB programs. Miss Lola Schofield, dramatic soprano, has been identified with the station since its beginning. The present announcer is "Colonel" Edwin House. The "colonel" derives his name through his reputation as a singer during the war in the army camps in France. He has traveled over the country as the leader of a cowboy band and is well known to vaudeville. The studio music is under the direction of Preston Graves who also serves as accompanist. The senior Lampe is nationally known as a composer and often writes the Trianon orchestrations. He writes special music for special occasions.

Is America the land of opportunity?
Ask Andrew Karzas.

KGW in New Studios

PORTLAND.—Station KGW, here, recently dedicated the new duplex studios which have been under construction for the past two months. Both offices and studios are now on the eighth floor of the Oregonian building. The suite consists of two offices, a reception room, two studios and an announcer's booth and control room. A new 1,000-watt transmitter is being installed and will be on the air in April.

SEND THREE SOLOS AS TRIO BROADCAST

PLAYERS KEEP TIME BY
USE OF EARPHONES

Organ, Cello and Violin Parts Picked Up at Different Points and Broadcast As One

MINNEAPOLIS.—WCCO, the St. Paul-Minneapolis Gold Medal station, presented a unique program recently when three soloists, located at points from 10 to 20 miles apart, played a trio which was sent out through the studio transmitter. In three different cities the artists played their parts into microphones and kept in time with the other two through means of earphones. The three parts were collected by the "fader" panel and so controlled and modulated that they went out on the air as one number.

The participants in the test were: E. J. Dunstedter, who played the organ in the State theater, Minneapolis; Oscar Baum, violinist, who played at the St. Paul studio of the station; and Lionel Bilton, cellist, who played before a specially installed microphone at the transmitting station eighteen miles northwest of Minneapolis and St. Paul.

Those who heard the broadcast said that it was impossible to detect from the results that the musicians were not all playing in the same room.

Hero of Sea Tells of Antioch Rescue

Captain Fried Welcomed on Arrival and Program Is Broadcast from Salon of Steamer

NEW YORK.—Another milestone in the progress of radio looms. Broadcasting stations are now trying to get a scoop over other stations in broadcasting nationally-known figures. When Captain George C. Fried and the heroic crew of the S.S. Roosevelt returned to this country, all the stations wanted to be the first to broadcast his homecoming address.

To Station WOR, in cooperation with J. Spencer Smith, president of the New Jersey board of commerce and navigation, goes the distinction of having arranged the first official welcome to be accorded in the United States to Captain Fried, on the arrival of the S.S. Roosevelt at Hoboken, N. J.

Program from Ship

Promptly at noon, Monday, February 15, the ceremonies were broadcast through WOR direct from the main salon of the S.S. Roosevelt and consisted of music and speeches of welcome and homage to Captain Fried and his crew. The ceremonies were opened with a speech by Thomas H. Rossbottom, general manager of the United States lines, presenting J. Spencer Smith, who in turn introduced Governor A. Harry Moore of New Jersey. Engineer-Commander A. Knothe reiterated the sentiment expressed in London recently to Captain Fried by His Majesty King George.

Captain Fried then broadcast his emotions on his safe return to the United States and included his experiences in assisting the stricken crew of the S.S. Antioch. The U. S. A. Sixteenth Infantry band was ordered by Major-General Charles P. Summerall to attend the function throughout the ceremonies.

Given Police Escort

The function was given the approval of the state of New Jersey by the passage of a resolution in the state assembly recently. An embossed copy of the resolution was presented to the captain and crew of the S.S. Roosevelt by Senator J. Henry Harrison. A police escort preceded the party to the dock at which the ship tied up.

During the ceremonies Captain Fried was so overwhelmed by the speeches made that in the middle of the presentation of the copy of the resolutions he broke down and had to leave the salon of the ship and go to his rooms. Upon his return he was cheered by the crowds gathered for the event.

Dedicate New Broadcaster— Birmingham, Alabama Tech

BIRMINGHAM, Ala.—WAPI, the Victor Hanson broadcasting station of the Alabama Polytechnic institute at Auburn, Ala., was dedicated recently with a special program of music and speeches.

This new station is capable of sending with 1,000 watts of power, but it is probable the full capacity will not be used for some time. The station is of the latest design. It has a wave length of 248 meters, the same as WBER of Birmingham, Ala., and WIOD of Miami, Fla.

BUREAU STRIVING TO FIND SERVICE AREAS

KNOWLEDGE WILL HELP IN GIVING WAVE LENGTHS

Zone of Real Effectiveness Covered by Broadcaster Is Much Smaller Than Expected

WASHINGTON.—What is the "complete service area" of a broadcasting station, and how far can absolutely reliable reception be obtained with a Radio receiving set? These are questions which the bureau of standards is attempting to solve.

According to Dr. J. H. Dellinger, chief of the bureau of standards Radio laboratory, "if we set up the most rigid standard of say complete service in adverse atmospheric conditions at all times of the day and night and year for the average crystal set, then the actual intensity measurements would seem to indicate that the radius of the circle served by a 500-watt station will not exceed ten miles; that a 5,000-watt station will cover about thirty miles, and a 50,000-watt station will not cover much over 100 miles."

Real Service Zone Is Small

More sensitive receiving sets and better atmospheric conditions, Dr. Dellinger says, greatly extend these distances.

"Actual operation of high-powered stations has proved advantageous," Dr. Dellinger adds, "in broadening the complete service area, but this area is much more limited than many expected. Subjected to the test of positive and reliable service at all times and all weathers, it will be found that the real effectiveness of a station falls within a comparatively small zone."

"For some reason or other, the area is not always a circle, and it varies in different parts of the country for the same power. The department of commerce is undertaking the important task of determining these service areas. This will give information on which to base more efficient allocation of wave lengths."

Fans Give Contributions To Old Contest Fiddler

Word Picture by Announcer Brings Gifts from Listeners

HARTFORD, Conn.—A number of Radio fans were so moved by an announcer's word picture of John Comfort, of Stafford, Connecticut, aged fiddler who took part in the state contest, that they sent contributions to the station and asked that they be passed on to Mr. Comfort.

WTIC's announcer, who sat in the wings, back stage of the theater, found several of the old gentlemen to be especially interesting characters and from time to time told the Radio audience his impressions. This led him to describe Mr. Comfort, who lives on the Stafford town farm and who had been obliged to sell his violin a number of years ago to pay for operations which, however, were unsuccessful in restoring to him the sight of one eye. He is 84 years old and found it difficult to rise from his chair when it came his time to play.

Radio Hits Japan Movies

WASHINGTON.—Radio interest has resulted in a bad slump in the revenue derived from motion pictures in Japan, according to a report to the department of commerce.

"UNCLE BOB" GIVES FULL TIME TO KIDS

CHICAGO.—Already having mounted the plane of "Radio's Honor Roll" because of a long line of wonderful achievements in his Radio work with the nation's young, "Uncle Bob," the erstwhile Walter Wilson, had nothing left to sacrifice to his chosen vocation than to retire from business life and devote all his time to his Radio activities and "The Curb Is the Limit" club.

That is just what happened. Work was stacking up. A steady stream of Radio letters and one thing after the other demanded more time than one man could give. He soon found that he had to choose between his office and Radio, but reflection upon the thoughts of thousands of his juvenile friends and the enthusiasm with which they sought him as their big friend, led Uncle Bob to step out of business life.

Thus, Uncle Bob is the big uncle of Westinghouse Station KYW, Chicago, where each day he meets his uncounted fireside listeners, and where for more than two years he found the inspiration that enabled him to carry on a noble work among the children.

Now that Uncle Bob has stepped out of the business world, we find him the devoted "Radio Uncle" of KYW, lending cheer and laughter to all and spending his spare time among the less fortunate youngsters in hospitals and occasionally making a personal appearance in nearby cities where he always is greeted by a horde of cheering youngsters.

Firemen Quartet Leader Killed

MILWAUKEE.—Herman Glander, a city fireman and leader of the Milwaukee Firemen's quartet which has been heard every other Tuesday over the Marquette University-Milwaukee Journal station, WHAD, was recently killed instantly when his car skidded onto a railroad crossing in the path of a fast mail train.

Station 6XBR Gallops Over Country Getting Broadcasts for Big Brother

Portable Broadcaster Picks Up Programs on Short Wave and Transmits Them to KFWE to Send Out to Listeners, Eliminating Telephone Connections

By G. L. King

TELEPHONE permits and extensions cut no figure in the young life of Broadcasting Station KFWE, Hollywood, California. KFWE ties in anywhere within automobile distance of its station through its little brother, the short wave portable, Station 6XBR.

For instance, Marion Talley, the brilliant young star of the Metropolitan Opera in New York decides to take a few weeks' vacation in California. Her whim is to go camping up in the hills near Los Angeles. While there she has consented to sing her "Caro Nome"—the song that

brought her instantaneous fame in New York.

There are no phone lines near the camp. But a representative of KFWE wins her permission to broadcast. A little later the word is flashed to headquarters in Hollywood. An order goes out from the executive office. A man in a garage rolls out a machine that resembles an ordinary motorbus except that it has a rack of structural work folded up on the roof like the extension ladders on a fire truck.

The bus glides up to the curb in front of the KFWE studio. The technical staff, accompanists and announcer, waiting there, hop aboard and the bus roars down the street.

Out through the country and up into the hills it speeds away until it comes near to the camp where Miss Talley is enjoying herself. Then it runs into a by-way and the passengers climb out. There is a sound of metal against metal, clicks and snips and the apparatus on the roof of the bus rears itself to a height of 45 feet. There are two towers and between them stretches a four-wire span—obviously an antenna.

Follows then the rhythmic rumble of an engine and hum of generators, all in a subdued tone, scarcely audible twenty-five feet distant. The tubes are warming up. A stretch of cable is carried into the camp. The microphone is properly placed and tested. All is ready. Miss Talley steps to a position indicated by the director. Another artist has a violin. Perhaps there is a cello and flute. They begin to play and the voice of the 19-year-old girl, the wonder of the hour, pours forth the golden notes that so entranced her eastern admirers a short time ago.

There are no wires to the KFWE station—only the short antenna, atop the motorbus beside the road. But those angelic notes, unheard there, are lifted from the shining strands as from the harp chords of heaven and are gathered together again at the station in Hollywood to be rescat-tered far and wide to the very ends of the ether waves for millions to hear.



Frank N. Murphy (above) chief electrical engineer of Station KFWE who designed and built the superportable transmission set 6XBR.

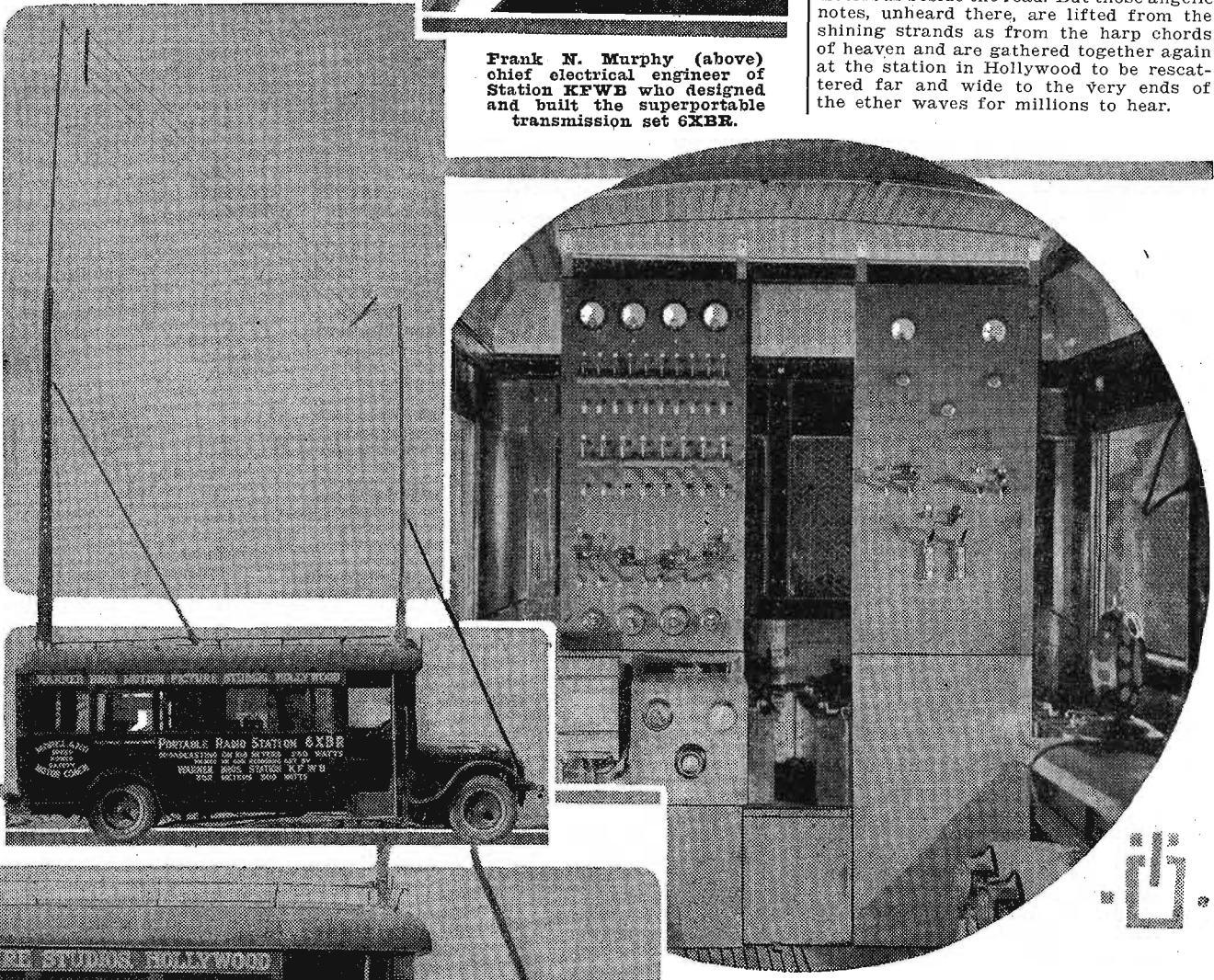

Interior of truck showing battery racks, recharging panel, generators and power panel. Truck rigged ready for action, upper left, rear tower 45 feet, front 25 feet high. At left, closeup of 6XBR station, Charlie Wellman (left), announcer, and Murphy scheming a new stunt to try on the portable. The towers fold and collapse on top of bus like ladders on a fire truck. Bus accommodates 30 passengers besides apparatus and relays programs to KFWE, Hollywood, Calif.



Champ Fiddler Almost Failed to Play In Finals Because Wood Pile Was Low

Uncle Bunt Stephens, After Placing in Preliminaries, Tells Henry Ford He Can't Compete Because He Left Home Without Leaving Enough Fuel Cut Up

NASHVILLE, Tenn. — Uncle Bunt Stephens, world's champion old-time fiddler, who won the blue ribbon at the recent contest held by Henry Ford in Detroit, and who was heard in a special concert from WSM, the National Life and Accident Insurance company's station here, on a recent Monday night, almost didn't win! His story is interesting.

When the contest was first started and the preliminaries were being held, Uncle Bunt didn't know whether he could get away from his little farm or not. He lives in a small cabin near Lynchburg, Tennessee. But he was finally prevailed upon and went forth into the back yard to chop a sufficient supply of kindling to last two or three days. He told his wife he had to go to Nashville and maybe to Louisville in the elimination contest.

He took third prize in Nashville in the first preliminary, just managing to be in the first three that went to Louisville. When he got to Louisville, he was awarded second prize in the second elimination. Upon his arrival in Detroit, he met Mr. Ford and told him very frankly that he couldn't stay for the big party, that he had to get back home.

Mr. Ford inquired as to why he had to get back home and he found out that Mr. Stephens didn't leave enough wood for his wife to last more than three days. The world's richest man caused a wire to be sent to W. K. Parks, his agent in Lynchburg, and told him to stock the house with provisions and anything the little family needed. He won first prize and was entertained in the palatial home

of Henry Ford, located in Highland Park.

Mr. Stephens is a man well past life's meridian, although he couldn't be classed as old. He has simple tastes. His little home sits about a hundred yards back from the road, which is by no means a main highway. Life has been very hard for him in many ways, but he has remained serene.

He has practically no means, or did not have any until the blue ribbon was pinned on his thirty-three-year-old fiddle. But in spite of the fact that he is a poor man as regards this world's goods, he refused an offer of eight thousand dollars for his trusty fiddle, which hangs on a nail above his bed.

STATION WLW GIVES THIRTY-HOUR PARTY

CINCINNATI.—Thirty hours of continuous broadcasting is the station record established by the Crosley Radio corporation's super-power station, WLW, Cincinnati. This program marked the fifth birthday celebration of the station. Thousands of congratulatory messages were received from listeners.

To Investigate Station NAA

WASHINGTON, D. C.—The interdepartmental Radio advisory committee has been requested to take up the problem of interference of NAA, the navy broadcasting station at Arlington, Va., and make some suggestions as to how the trouble can be eliminated.

For months local Radio fans have been complaining of NAA because of harmonics it is apparently quite impossible to tune out.

Station WSWS Is on Air With Program of Features

CHICAGO.—WSWS, formerly WCEE, and now the new commercial station of the Bligh Whittington company with studios in the S. W. Straus company building here, is on the air. Preliminary schedules announced by Director Junkin indicate nearly all day will be occupied by features of interest to women, and entertainment and information for the farming territory of the middle, south and far west.

Add Two Beautiful Studios To Station WIBO Pick-Ups

CHICAGO.—Two beautiful new studios have been added recently to the pick-ups used by WIBO, Nelson Brothers-Russo Florito Orchestral exchange station here. The Uptown Conservatory of Music is the owner of the two studios from which broadcasts will be made over WIBO. Invitations, issued over the air and through the mail, brought several thousand people to attend the opening and dedication of the conservatory studios.

MUSIC TAX CLOSES REMOTE CONTROLS

Two Big Los Angeles Hotels Drape Input Panels and Others Are Just Standing By

LOS ANGELES.—Due to the exorbitant tax demanded by the American Society of Composers, Authors and Publishers for the year 1926, it is not unlikely that every remote control in the city of Los Angeles, as well as Hollywood, will be forced to go off the air.

Two nationally-known hotels, the Los Angeles Biltmore and the Ambassador, have hung dust drapes over their input panels already, and several of the other remote controls are staying on the air temporarily until something definite can be obtained from the society. It is generally understood that a remote control in Los Angeles has to pay a tax of \$12.50 an hour, in addition to a yearly fee, which is also duplicated by the station itself while the remote control is on the air.

One remote control, that of Leighton's cafeteria, released through KHJ, has decided not to use the American society's works for the ensuing year, but the majority of the outlying studios feel that they should have access to all music or else sign off for good. And at present prices the game isn't worth the tax.

FORECAST CONDITIONS

(Continued from page 3)

barometric conditions, in the same evening.

"On the basis of these studies, a daily radio forecast is prepared by myself and broadcast from WCAJ at 4:30 p. m. The following forecast made for December 15, 1925, is typical:

"For eastern Nebraska: A good Radio night; free from static. The best ranges may be expected from the east, northeast, and northwest. Considerable fading is probable from the south."

"While it is freely acknowledged that factors other than weather conditions are involved in fading, and that the predictions are not always 100 per cent accurate, it must be borne in mind that weather forecasts are not unerring, after a century of endeavor. It can at least be said that results thus far obtained are encouraging, and that with continued cooperation on the part of the investigators a satisfactory system of Radio forecasting may be expected in the near future."

School Given Station

CHAMPAIGN, Ill.—Boetius H. Sullivan, who last April made a gift of \$100,000 to the University of Illinois, has made another gift of \$11,500. Both donations are to be used in the construction of a Radio station in honor of Mr. Sullivan's father.

ATWATER KENT RADIO



Let the March winds blow you trade!

Here are five facts for your March calendar:

Fact No. 1

February being the best month in the year for radio reception, the second best is—what would you say? December? January? No, March—with April not far behind. The United States Bureau of Standards so reports after a year of testing.

Fact No. 2

In the face of the belief that radio is a fall and winter sport and September the month of the Great Revival, the public bought more sets and speakers last March than in September. Balm April was as good a sales month as September.

Fact No. 3

Sturdy and reliable Atwater Kent Radio is distinctly year-round Radio.

Fact No. 4

Atwater Kent sales support knows

no slump. Atwater Kent advertising is year round advertising.

Fact No. 5

The Atwater Kent Radio Hour is the weekly concert to which all other radio programs are compared.

* * *

Pretty strong facts? Put them under your hat. Use them on the next customer who tells you he's going to put off his purchase until next season.

Write for illustrated booklet telling the story of Atwater Kent Radio

ATWATER KENT MFG. COMPANY
A. Atwater Kent, President
4708 WISSAHICKON AVE., PHILADELPHIA, PA.

Prices slightly higher from the Rockies west, and in Canada

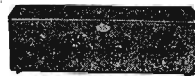

Model 20 Compact, cable attached, \$50



Radio Speaker Model H, \$22

TELLS WOMEN HOW TO MAKE APPLE PIE

BETTY CROCKER GIVES HER RECIPE FOR DESSERT

Although It Was First Made in England, Fruit Pie Is American Dish Through Conquest

Have you heard, and do you regularly listen for Betty Crocker's Radio talks? Miss Crocker is nationally known as a home food specialist who is broadcast- ing from a dozen of the country's largest stations. By special arrangement Radio Digest has secured a series of exclusive articles by Miss Crocker dealing with her current Radio talks. These broadcasts are made through WEEL, WEAJ, WCAE, WGR, WEAJ, WWJ, WDAF, WJAR, WHT, WFL, KSD, KFI, and WCCO, the Gold Medal station at Minneapolis-St. Paul. All of Miss Crocker's recipes and discussions are based upon actual investigations and work of herself and her assistants in model kitchens.—Editor's Note.

By Betty Crocker

FRUIT pies were known as early as the year 1600, and apple pie was probably among the first fruit pies. The pies of those days, spelled "p-y-e-s," were not the same as the luscious two crust pies we enjoy today. They were a sort of tart with one crust, and in other ways were quite different from the present day pie. No doubt the early colonists brought with them the English apple pie which is a deep dish pie with a top crust, but no lower crust. Henry C. Finck contends that even though apple pies were brought to us from England they are truly American "by right of conquest, improvement, and countrywide use," and I believe most of us agree with him.

Much to Be Considered

In discussing the preparation of apple pie, there are many things to be considered. It will be easier to take up the different steps in pie making, if we have our recipe before us. This is the recipe for apple pie: 1½ cups Gold Medal flour, ½ teaspoon salt, 1 cup shortening, ice water—5 tablespoons, 6 medium apples, ½ cup sugar, 1 teaspoon cinnamon, 1 tablespoon butter.

Method: Sift flour once before measur-

(Continued on page 12)

CONSTANT CARE IS SECRET OF BEAUTY



CAN the years really make us look younger? "Yes," answers Madame Polly, who lectures over WJLN, New York, every Monday afternoon at 5 o'clock, "if the years are not allowed to bury us in an accumulated pile of powder and rouge, mascara and sophistication, mental disturbances and unnatural living." Madame Polly is sixty-five years young. She possesses a figure that a woman of thirty would be proud of. Her hair is pure white and it frames the youngest looking face imaginable. She is a professional woman whose business for years has been making other women beautiful, and who practices what she preaches. For fourteen years, she tells, she at-

NUTTY CLUB TO GIVE ADVICE TO LOVESICK

THE Radio listeners have had their characters read, have been taught bridge and chess, have been taught to cook, and what not, by Radio, but WBBM, Chicago, is, we believe, the first to broadcast advice to the lovesick.

Miss Sally Chickenroost of WBBM, Chicago, each Sunday evening from 12 midnight on, when the famous Nutty club of WBBM is in session, answers all questions of the heart. If the "Mrs." doesn't love you because you stay up till 4 a. m. listening to the Nutty club, Sally will fix you up. If the dog takes all of papa's affection, write to Sally and she will answer your question from WBBM through the Nutty club.

tended Miss Lillian Russell in the work of her beauty upkeep.

Polly's greatest claim to beauty fame is the texture of her skin. Women who have attained fifty years as a rule have complexions that lack a certain oil luster that the young invariably possess, the shine which indicates a healthy gland action. Youth can afford to powder it off. But age, Mme. Polly asserts, "makes a big mistake in doing this."

"I never use powder—never!" she said. "I'll just show you what it does." She powdered her face. Gone was that freshness. She wiped it off and again proved the truth of what she said.

"Rouge? Yes, I rouge," she added. "But delicately, of course. Powder, never! The powder settles upon the folds in the skin and exaggerates them frightfully. It does everything to age the face and nothing to freshen it."

"I never have used hot water on my face. For years I have cleansed my face with a good cream, and have used cold water on it every single day, but never hot."

Madame Polly's hair is of a most exquisite texture, beautifully white and live looking, which she attributes to the rinse in camomile tea, made by steeping camomile flowers to the color of weak tea. Even hair can be kept young.

SHORT WAVES

By Marcella

"Bobby" (Robert W.) Griffin's personal description is requested by two ladies—Biddy and Thelma. Isn't it great to be a popular Radio announcer? Bobby is assistant announcer at WHO, Bankers Life, Des Moines, and here's the data: Age, 26; height, 5 feet 6¾ inches; weight, 150 pounds; eyes, blue; hair, brown. Married? Read the report from WHO, as follows:

"Bobby was born in the 'Show Me' state; went to grade school, high school and college in Kansas City, Mo., Des Moines, Albia, Ia., and St. Louis; went to war before the rest of us knew there was one on; trundled an ambulance there and in so doing he gathered in a souvenir that entitles him to membership in the most exclusive organization in existence—the Disabled American Veterans.

"To one young lady who craves a comparison of Bobby's voice and appearance, we are glad to inform her that her fondest hopes would surely be realized were she to have the opportunity of meeting him. We sincerely wish she could drop into the studio some afternoon, when he is ensconced behind his desk in the control booth, with the late afternoon sun casting an auroral glow about his handsome head—forming a sort of halo—and his genial smile working overtime. We fear she would fall—hard! And now for the best news of all. Bobby is without marital affiliation, either past, present or contemplated."

Marcella is indebted to a Station WHO friend for this colorful description, and we wish to take off our hat to the gentleman. The two paragraphs are just what my readers like to know.

Paul Ash famous jazz band leader appearing at McVickers theater, Chicago, and broadcasting over KYW, may have a street named after him, "Paul Ash Lane." It was a section of alley extending by the stage door of McVickers before several thousand high school girl Ash fiends were inspired with the idea of petitioning the city council to name it. Yes, the irresistible, auburn-haired Paul is married.

In response to "S.H." the "Old Timer," (Continued on page 12)

WOMEN'S PROGRAMS INDEX

Saturday, March 13

Eastern	Central	Mountain	Pacific
9:30 a. m.	8:30 a. m.	7:30 a. m.	6:30 a. m.
WWJ (352.7m-850kc)	Tonight's dinner.		
11	9	8	
WEAR (389.4m-770kc)	Home service talk.		
WHT (399.8m-750kc)	Women's club, Jean Sargent.		
12 n.	11	10	9
WGN (302.8m-990kc)	Household hints.		
WQJ (447.5m-670kc)	Home Economics program; character readings.		
12:30 p. m.	11:30	10:30	9:30
WGN (302.8m-990kc)	Discussion of fashions.		
12:35	11:35	10:35	9:35
KYW (535.4m-560kc)	Table talk.		
1	12 n.	11	10
KGW (491.5m-610kc)	Household helps, shopping guide.		
KMA (252m-1190kc)	Domestic science topics.		
3 p. m.	2 p. m.	1 p. m.	
KJR (384.4m-780kc)	Tonight's dinner.		

Monday, March 15

Eastern	Central	Mountain	Pacific
9:30 a. m.	8:30 a. m.	7:30 a. m.	6:30 a. m.
WWJ (352.7m-850kc)	Tonight's dinner.		
10	9	8	7
WJZ (454.3m-660kc)	Women's hour.		
WRC (468.5m-640kc)	Women's hour.		
10:45	9:45	8:45	7:45
WEAF (491.5m-610kc)	WFI (491.5m-610kc)		
Home service talk, Betty Crocker.			
WTAG (268m-1120kc)	Talk, Marjorie Woodman, nurse.		
10:50	9:50	8:50	7:50
WMC (499.7m-600kc)	Home economics discussion, Miss Killy.		
11	10	9	8
WEAR (389.4m-770kc)	Home service talk.		
WHT (399.8m-750kc)	Women's club, Jean Sargent.		
WNYS (526m-570kc)	Women's program.		
WTIC (475.9m-630kc)	"Women in Industry," Anne Gorman.		
11:15	10:15	9:15	8:15
WTIC (475.9m-630kc)	"Reducing Mileage in the Kitchen," Olea Sands.		
11:30	10:30	9:30	8:30
KFAB (370.7m-880kc)	"Dressing for Comfort," Helen Roche.		
WTIC (475.9m-630kc)	Housewife's forum.		
11:45	10:45	9:45	8:45
WCCO (416.4m-720kc)	"Breakfast Breads," Betty Crocker.		
WDAF (365.6m-820kc)	WHT (399.8m-750kc)		
Home service talk, Betty Crocker.			
12	11	10	9
WGN (302.8m-990kc)	Household hints.		
WQJ (447.5m-670kc)	Home Economics program.		
"Let's Go Orchid Hunting," Maud Jacobs.			
12:15 p. m.	11:15	10:15	9:15
KYW (535.4m-560kc)	Meat talk.		
12:30	11:30	10:30	9:30
WEBH (370.2m-810kc)	Fashion and household talks.		
12:35	11:35	10:35	9:35
KYW (535.4m-560kc)	Table talk.		
2:30	1:30 p. m.	12:30 p. m.	11:30
KFNP (263m-1140kc)	Mothers' hour.		
3	2	1	12 n.
WCCO (416.4m-720kc)	Women's hour.		
WSOE (248m-1220kc)	Cooking chats.		
4	3	2	1 p. m.
WIP (508.2m-590kc)	Market hints for housewives.		
WOC (483.6m-620kc)	Home management schedule, Aunt Jane.		
WQJ (447.5m-670kc)	"Appetizing Fish Dishes," Helen Downing.		
"The History of Permanent Waving," W. Bivans.			
5	4	3	2
KJR (384.4m-780kc)	Home helps.		
7:30	6:30	5:30	4:30
WKAR (285.5m-1000kc)	"Building the Blood," Dr. Marie Dye.		

Eastern	Central	Mountain	Pacific
7:45 p. m.	6:45 p. m.	5:45 p. m.	4:45 p. m.
WKAR (285.5m-1000kc)	"Selecting a Spring Hat," Mary Shellenberger.		
8:30	7:30	6:30	5:30
KUOA (299.8m-1000kc)	"Remodeling Garments," Ella Posey.		
"Planning the Vegetable Garden to Meet the Food Needs of the Family," Gertrude Conant.			

Tuesday, March 16

Eastern	Central	Mountain	Pacific
9:30 a. m.	8:30 a. m.	7:30 a. m.	6:30 a. m.
WWJ (352.7m-850kc)	Tonight's dinner.		
10	9	8	7
KDKA (309.1m-970kc)	Domestic Science.		
Arts for the Housewife.			
WIP (508.2m-590kc)	Menu, Anna Scott.		
WJZ (454.3m-660kc)	Women's hour.		
WRC (468.5m-640kc)	Women's hour.		
10:45	9:45	8:45	7:45
WTAG (268m-1120kc)	Talks to Mothers, Rosebelle Jacobus.		
11	10	9	8
WEAR (389.4m-770kc)	Home service talk.		
WHT (399.8m-750kc)	Women's club, Jean Sargent.		
WMCA (340.7m-880kc)	Home makers' hour.		
12 n.	11	10	9
WGN (302.8m-990kc)	Household hints.		
WQJ (447.5m-670kc)	"Easter Hats," Lillian Russell.		
12:15 p. m.	11:15	10:15	9:15
WQJ (447.5m-670kc)	"What Mothers Should Know About Baby Teeth," Roy Wilson.		
12:30	11:30	10:30	9:30
WEBH (370.2m-810kc)	Fashion and household talks.		
1	12 n.	11	10
KPO (428.3m-700kc)	Domestic science talk.		
1:30	12:30 p. m.	11:30	10:30
WSUI (483.6m-620kc)	"Why Children Need Other Children," Dr. Katharine Graves.		
1	12 n.	11	
WY (379.5m-790kc)	Talks.		
3:15	2:15	1:15 p. m.	12:15 p. m.
WHO (526m-570kc)	Recipes, household hints.		
4	3	2	1
WIP (508.2m-590kc)	Menu talk.		
WOC (483.6m-620kc)	Home management schedule.		
WQJ (447.5m-670kc)	"Spring Cleaning," Helen Downing.		
4:30	3:30	2:30	1:30
WLIT (394.5m-760kc)	Household helps and hints.		
5	4	3	2
KJR (384.4m-780kc)	Home helps.		
5:30	4:30	3:30	2:30
KOA (322.4m-930kc)	Housewives matinee.		
6	5	4	3
KOA (322.4m-930kc)	Culinary hints, Clara Hoover.		
6:15	5:15	4:15	3:15
KOA (322.4m-930kc)	Fashion review, Sally Dec.		
7	6	5	4
KFOA (454.3m-660kc)	Today's recipe.		
8	7	6	5
WPG (299.8m-1000kc)	Fashion Flashes.		
8:30	7:30	6:30	5:30
KGO (361.2m-830kc)	As a Woman Thinketh.		

Wednesday, March 17

Eastern	Central	Mountain	Pacific
9:30 a. m.	8:30 a. m.	7:30 a. m.	6:30 a. m.
WWJ (352.7m-850kc)	Tonight's dinner.		
10	9	8	7
WIP (508.2m-590kc)	Menu.		
WJZ (454.3m-660kc)	Women's hour.		
WRC (468.5m-640kc)	Women's hour.		
10:45	9:45	8:45	7:45
WEAF (491.5m-610kc)	Home service talk, Betty Crocker.		
WFI (394.5m-760kc)	Gold Medal Service talk, Betty Crocker.		
WTAG (268m-1120kc)	Talk to Housewives, Mrs. Lydia Flanders.		

Eastern	Central	Mountain	Pacific
11 a. m.	10 a. m.	9 a. m.	8 a. m.
WHT (399.8m-750kc)	Women's club, Jean Sargent.		
WNYS (526m-570kc)	Women's program.		
11:30	10:30	9:30	8:30
KFAB (340.7m-880kc)	"The Arrangement of Furnishings in a Home," Edna Benson.		
11:45	10:45	9:45	8:45
WCCO (416.4m-720kc)	"Pots and Pans and Little Blue Bows," Betty Crocker.		
WDAF (365.6m-820kc)	WHT (399.8m-750kc)		
Home service talk, Betty Crocker.			
12 n.	11	10	9
WGN (302.8m-990kc)	Household hints.		
WQJ (447.5m-670kc)	Home Economics program.		
"Child Welfare," "Unique Salads," E. Ransom.			
12:30 p. m.	11:30	10:30	9:30
WEBH (370.2m-810kc)	Fashion and household talks.		
12:35	11:35	10:35	9:35
WGN (302.8m-990kc)	Discussion of fashions.		
12:35	11:35	10:35	9:35
KYW (535.4m-560kc)	Table talk.		
1	12 n.	11	10
KPO (428.3m-700kc)	Sewing talk.		
3	2 p. m.	1 p. m.	12 n.
WCCO (416.4m-720kc)	Woman's hour.		
4	3	2	1 p. m.
WLW (422.3m-710kc)	Cooking school.		
WOC (483.6m-620kc)	Home management schedule, Aunt Jane.		
WQJ (447.5m-670kc)	"Planning For a Company Dinner," Helen Downing.		
"Couldn't Reach," Jean Rich.			
5	4	3	2
WMAQ (447.5m-670kc)	Recipes.		
6	5	4	
KFOA (454.3m-660kc)	Today's recipes.		
KLX (508.2m-590kc)	Woman's hour.		
KMA (252m-1190kc)	Domestic science talk.		
10:45	9:45	8:45	7:45
KOAC (280.2m-1070kc)	"The Magic House—How It Is Protected," Jessamine Williams.		

Eastern	Central	Mountain	Pacific
9:30 a. m.	8:30 a. m.	7:30 a. m.	6:30 a. m.
WWJ (352.7m-850kc)	Tonight's dinner.		
10	9	8	7
WIP (508.2m-590kc)	Menu talk.		
WOC (483.6m-620kc)	Home management schedule.		
WQJ (447.5m-670kc)	"Spring Cleaning," Helen Downing.		
4:30	3:30	2:30	1:30
WLIT (394.5m-760kc)	Household helps and hints.		
5	4	3	2
KJR (384.4m-780kc)	Home helps.		
5:30	4:30	3:30	2:30
KOA (322.4m-930kc)	Housewives matinee.		
6	5	4	3
KOA (322.4m-930kc)	Culinary hints, Clara Hoover.		
6:15	5:15	4:15	3:15
KOA (322.4m-930kc)	Fashion review, Sally Dec.		
7	6	5	4
KFOA (454.3m-660kc)	Today's recipe.		
8	7	6	5
WPG (299.8m-1000kc)	Fashion Flashes.		
8:30	7:30	6:30	5:30
KGO (361.2m-830kc)	As a Woman Thinketh.		

Eastern	Central	Mountain	Pacific
9:30 a. m.	8:30 a. m.	7:30 a. m.	6:30 a. m.
WWJ (352.7m-850kc)	Tonight's dinner.		
10			

AN EVENING AT HOME WITH THE LISTENER IN CENTRAL TIME

Table listing radio stations by location and time slot. Columns include Call, Location, Met., Saturday, Sunday, Monday, Tuesday, Wednesday, Thursday, Friday.

Table listing radio stations by location and time slot. Columns include Call, Location, Met., Saturday, Sunday, Monday, Tuesday, Wednesday, Thursday, Friday.

STATIONS IN ORDER OF WAVE LENGTHS

Table listing radio stations in order of wave lengths. Columns include Meters, Call, Meters, Call, Meters, Call, Meters, Call, Meters, Call, Meters, Call.

RECIPE FOR APPLE PIE

(Continued from page 11)

ing. Sift flour and salt together. Cut in the shortening. Add enough ice water to make a stiff dough. Turn out on a board and divide the dough in halves. Roll out one crust to fit the pie tin. Fit the crust into the pan lightly. Do not stretch the dough. Fill the crust with apples which have been mixed with sugar and cinnamon. Dot with the butter. Moisten the edge of the undercrust. Fold top crust in half, making several cuts through which the steam may escape. Cover the pie with the top crust. Press the two edges together with a fork. Trim off edges of crust. Bake 40 minutes. Have the oven very hot for the first 5 or 7 minutes, 500 degrees Fahrenheit. When the crust begins to brown, reduce the heat. Finish baking in a moderate oven, 380 degrees Fahrenheit. This amount will make a pie nine inches in diameter or six good servings.

If you wish a rich flaky top crust on the pie, dot it with one tablespoon of butter after the crust is rolled out. Fold several times and roll to fit the pie tin.

Keep Materials Cold

In making pie crust, if all of the materials and utensils are cold, the dough is easier to handle and you will have better results.

The directions say to cut in the fat. We use two knives or a chopping knife for that purpose. The fat should be very hard and cold. If you work it in with the fingers, your fingers warm it and press it into the flour. The pastry is much better if the fat is cut or chopped in until it has the appearance of corn meal. You may do this with a chopping knife or with two knives cutting across each other like a pair of scissors.

Cover Board with Canvas

Use just enough water to make a paste that will hold together. Good pastry should be so cold and dry that practically no flour is needed on the board. That means that the paste should not be at all sticky. If you add too much water, you must work in more flour, and kneading pastry makes it tough. In this recipe made with Gold Medal flour, 5 tablespoons of water is the correct amount, but add that amount very gradually. Any pie paste, and particularly a rich flaky paste may be handled more easily if a canvas covering is placed over the bread board. Any fine canvas or firm toweling will answer the purpose. To cover the rolling pin, a child's white stocking with the foot cut off is very satisfactory. Fasten the ends of the canvas firmly on to the board, and rub flour into it before rolling the paste.

It is always better to allow the finished dough to stand for some time before using it. Roll half of the dough at a time, rolling it in the shape of the pan. Ease the crust into the pan. Do not stretch it as it will shrink a little during baking. Some cooks trim the bottom crust as soon as it is in the pan, but I think you can secure a better edge, especially for juicy pies, if the crust is not trimmed until the

top crust is on and the edges fitted together. The edge of the undercrust should always be moistened before the top crust is put on, in order to make the edges stick together better.

When cutting holes in the top crust, be careful to keep the holes near the center. If they are too close to the edge, the juice will run out.

Keep from Running Over

It is quite a problem to keep an apple pie from running over. Having the edges firmly pressed together and the holes near the center will help some. Many cooks like to place a small paper funnel in the center of the pie so that the juice will bubble up in the funnel rather than running over on the stove.

There is one more item that would be added if this pie were made in my kitchen, and that is, "serve with cheese," but no doubt many of you are not as fond of cheese as I am.

SHORT WAVES

By Marcella

(Continued from page 11)

who has charge of KYW's afternoon frolics, Tuesday, Thursday and Saturday, is "Sen" (A. W.) Kaney. Yes, he's also married.

Val McLaughlin ex-WOC Sandman and later at WOAW, is now in Chicago, according to reports, but we do not believe she has made a definite connection with any of the stations. Will try to learn more, "Jayhawker," to answer your inquiry.

Ted Lewis of WHN fame is NOT the former prize fighter and champ, "L.L." Who wrote the "Prisoner's Song"? Well, Guy Mussey holds the copyright, although there is a serious controversy on. I don't believe Morrel Moore of WHB is related to Al Carney of WHT. Jack Little is touring in advance where he is going to be next. Tommy Malie has been lost. Haven't heard from him for a long time. Paul Small is reported to be working for some St. Louis music house. Sammy Stept is in New York and often heard over WJZ. The "Silver Masked Tenor" prefers to remain, and is, a mystery. Even I do not know who he is.

Bonnie Ann would know more of L. P. or Lester Palmer of WOAW, Woodmen of the World station at Omaha. Well, Lester is 25 years old, American born of Swedish extraction, member of the English Lutheran church, and belongs to the Tangier Temple Shrine. He is studying law and in June will hang out his shingle. Not only is he program director and announcer, but he writes songs. "Truly I Do" and "Won't You Believe in Me?" are two of his recent hits. Sounds suspicious, doesn't it, even if he is single?

What deep secret would you like to know about your favorite broadcast star? Drop me a note, girls and boys, and I'll do my best to answer here. MARCELLA.

ADVANCE PROGRAMS FOR THE WEEK

Saturday, March 13

Headliners Today

Eastern	Central	Mountain	Pacific
8:15 p. m.	7:15 p. m.	6:15 p. m.	5:15 p. m.
WJZ (454.3m-680kc), Leidenkrantz concert.	WGQ (379.5m-790kc), Leidenkrantz concert.		
8:30	7:30	6:30	5:30
WEAF (491.5m-610kc) "Getting the Best out of the Sculpture," Prof. John Shapely.			
WTIC (475.9m-630kc) Rotary Boys' band.			
8	7	6	
WLW (422.3m-710kc) "A Day on the Farm," musicale.			
9:30	8:30	7:30	6:30
WGBS (315.8m-950kc) Russian trio.			
WMC (499.7m-600kc) Pullman Porters' concert.			
9:45	8:45	7:45	6:45
WTIC (475.9m-630kc) Heublein trio.			
10:30	9:30	8:30	7:30
WBAP (475.9m-630kc) Hired Hand's Little symphony.			
11	10	9	8
KELJ (405.2m-740kc) Band concert.			
11:45	10:45	9:45	8:45
WSB (428.3m-700kc) Roger's Red Head club.			
12	11	10	9
KPRC (296.9m-1010kc) Serenade.			
KFL (467m-640kc) Hollywood String quartet.			
12:30 a. m.	11:30	10:30	9:30
KYW (535.4m-560kc) Congress Carnival.			

Saturday, silent night for: CFAC, CFCA, CNRA, CNRC, CNRE, CNRR, CNRT, CNRV, CNRW, KFDL, KFKX, KFMX, KFRU, KFUD, KFXE, KKLX, KMA, KOAC, KOB, KQP, KSCA, KSO, KTAB, KUOA, KWSC, WABQ, WBAL, WCX, WDD, WEAB, WEBJ, WEBW, WEMC, WGPC, WGHP, WGR, WGST, WHAD, WHAZ, WHN, WHO, WIP, WJAR, WJAZ, WKAR, WKAR, WLIT, WLWL, WMAZ, WOAI, WOS, WRVA, WTAG, WTIC, WWI.

Eastern Time Stations

CHIC, Toronto, Can. (358.9m-840kc), 10:30 p. m., Al Linton's orchestra.

CKCL, Toronto, Canada (356.9m-840kc), 7-8 p. m., dinner concert; Lowe Brothers, concert orchestra; The Scotch comedian.

CKNC, Toronto, Can. (356.9m-840kc), 4 p. m., CKNC instrumental quintet; Lawrence DeLoe, tenor; 8, Charles H. Leslie, baritone; Jessie Butt, contralto; Alfred Atkinson, tenor; Dwight Wilson, baritone; Gerard J. Kelly, tenor; Charles E. Bodley and his dance orchestra.

CNRO, Ottawa, Can. (484.5m-690kc), 8 p. m., Chateau Laurier concert orchestra; 9, comic opera, "Merrie England," Orpheus Amateur operatic society; Chateau Laurier dance orchestra.

KDKA, Pittsburgh, Pa. (309.1m-970kc), 6:30 p. m., dinner concert; 9:30, concert, Westinghouse employees' band.

WADC, Akron, Ohio (258.5m-1160kc), 11 a. m., organ recital, Allen theater; 6:30 p. m., dinner concert, Carnes Richards Hotel Portage quintet.

WAHG, Richmond Hill, N. Y. (315.6m-950kc), 12 noon, Joe Zimmerman, pianist; 12 midnight, midnight novelty program.

WBRR, New York, N. Y. (272.3m-1100kc), 8 p. m., Prof. Charles Rohner, violinist; 8:20, L. Marion Brown, soprano; 8:45, L. Marion Brown, soprano; 8:50, Prof. Charles Rohner, violinist.

WBZ, Springfield, Mass. (333.1m-900kc), 6:30 p. m., Hotel Lenox ensemble; 7:45, Repertory theater concert orchestra; 8:15, concert.

WCAE, Pittsburgh, Pa. (461.3m-650kc), 1 p. m., Florida's orchestra; 3, music, Nixon cafe; 6:30, dinner concert, William Penn hotel; 7:30, Sunshine girl; 8:15, Youngstown artists.

WCX, Detroit, Mich. (516.9m-560kc), 6 p. m., dinner program, Goldkette ensemble.

WDBO, Winter Park, Fla. (239.9m-1250kc), 7:45-9:30 p. m., Winter Park City band.

WEAF, New York, N. Y. (491.5m-610kc), 4-4:45 p. m., Eddie Worth and his County Fair orchestra; 4:45-5, Alan Harris, singer; 5-6, Vincent Lopez and orchestra from Ritz-Carlton hotel; 6-7, dinner music, Hotel Waldorf-Astoria; 7, John Quine, baritone; 7:10, Richard Franklin, pianist; 7:25, John Quine, baritone; 7:35, Marianne Kneifel string quartet; 8:15, prelude to Shakespearean hour; 8:30, Shakespearean hour, "Twelfth Night"; 9:30, WEAF musical comedy troupe; 10, Ross Gorman and orchestra; 11-12, Vincent Lopez and orchestra.

WEAR, Cleveland, Ohio (389.4m-770kc), 7 p. m., Hotel Statler concert orchestra.

WEEI, Boston, Mass. (348.6m-860kc), 7:10 p. m., D. and L. Slade company musical.

WFI, Philadelphia, Pa. (394.5m-760kc), 1 p. m., Tea room ensemble; 3, Columbia dance orchestra; 4, trio, First Methodist Episcopal church of Vineland; Lowell Burnett, boy soprano; Mrs. Paul Swope, pianist; 6:30, Bellevue Stratford concert orchestra; 7, Bellevue Stratford dance orchestra; 8, debate from Lebanon Valley college; 9, concert from Greater Camden Radio show.

WGBS, New York, N. Y. (315.6m-950kc), 3 p. m., Bud Fisher's players; 6:30, Vincent Storey trio; 7:30, Vanderbilt hotel orchestra; 8:30, Clifford Chesley, philosopher; 9:30, Russian trio; 10:15, Carmine Coppola, flutist; 10:30, Arrowhead Inn orchestra.

WGPC, New York, N. Y. (252m-1190kc), 3 p. m., orchestra; 3:30, Andy Razaf and Paul Denrick; 4, Ona Welsh, pianist; 4:15, Joe Furkel, tenor; 4:30, orchestra; 8:30, Strickland's orchestra; 9, Bob McDonald, ukulele player; 9:20, June Lee, singing vagabond; 9:45, Totman and Gallant, banjo duo boys; 10:30, Strickland's orchestra.

WGHB, Clearwater, Fla. (266m-1150kc), 6:30-7:30 p. m., dinner music; 8:30-9:30, Luther E. Ohls, ukulele player; Marian Hoffman, pianist; 11:45-1, midnight frolic.

WGR, Buffalo, N. Y. (319m-940kc), 2:30 p. m., WGR's afternoon program.

WGY, Schenectady, N. Y. (379.5m-790kc), 6:30 p. m., Onondaga hotel orchestra; 8:15, Leidenkrantz concert; 10:30, dance program.

WHAR, Atlantic City, N. J. (275m-1090kc), 2 p. m., Seaside hotel trio; 8, Seaside hotel trio.

WIP, Philadelphia, Pa. (508.2m-590kc), 1 p. m., organ recital; 5, Dal Buch and his Arcadians; 6:05, Benjamin Franklin hotel concert orchestra; 7, Uncle Wip's bedtime stories; piano solo, Ethel, Helen and Russell Pritz; 8, WIP mixed quartette; 10:15, Benjamin Franklin El Patio dance orchestra; 11:05 organ recital.

WJR, Pontiac, Mich. (516.9m-580kc), 7 p. m., Jean Goldkette's Petite symphony orchestra; soloists; 9, Jean Goldkette's serenaders; soloists; 10, Jean Goldkette's Victor Recording orchestra; 11:30, "The Merry Old Chief" and his "Jewett Radio Jesters."

WJZ, New York, N. Y. (454.3m-660kc), 1 p. m., Knickerbocker Grill orchestra; 4:30, Hotel Lorraine Grill orchestra; 7, Hotel Commodore concert orchestra; 8:15, Leidenkrantz concert; 10:30, Harry Leonard's Waldorf Astoria dance orchestra.

WLIT, Philadelphia, Pa. (394.5m-760kc), 12:02 p. m., Stanley theater organ recital; Arcadia cafe concert orchestra; 2, dance orchestra; 4:30, Bobby Lee's Cotton Pickers; 7:30, Benjamin Franklin hotel concert orchestra.

WMAK, Buffalo, N. Y. (266m-1130kc), 6:15-7:15 p. m., dinner music; 7:45-8:30, musical; 8:30-9, musical program; 9-10:30, musical program; 10:30-11, musical program.

WMCA, New York, N. Y. (340.7m-880kc), 6 p. m., Olcott Vail and his Hotel McAlpin string ensemble;

Schedule for

"a Step On the Stairs" Broadcast as a Play

GREETED with an ovation everywhere it has been presented as a Radio play, this thrilling mystery story by Robert J. Casey, appearing exclusively in Radio Digest, is making Radio history. "Something new," "Destined to have a big future" and "Keep it up" are but a few phrases heard in its praise. "A Step On the Stairs," dramatized by Fred Smith, pioneer in this field and managing director of the United States Radio society, is being presented weekly from the following eighteen leading broadcasting stations.

WHERE AND WHEN TO DIAL

WOC, Davenport, Palmer School of Chiropractic. Third episode at 10:30 p. m., Central time, on Friday, March 12. Fourth episode same time March 19. Dial 483.6 meters or 620 kilocycles.

WOAW, Omaha, Woodmen of the World. Third episode at 7 p. m., Central time, on Saturday, March 13. Dial 526 meters or 570 kilocycles.

KGO, Oakland, Calif., General Electric company. Third episode at 9:45 p. m., Pacific time, on Saturday, March 13. Dial 361.2 meters or 830 kilocycles.

KOA, Denver, General Electric company. Third episode at 9:40 p. m., Mountain time, on Monday, March 15. Dial 322.4 meters or 930 kilocycles.

WCCO, Minneapolis-St. Paul, Gold Medal station. Third episode at 10:05 p. m., Central time, on Tuesday, March 16. Dial 416.4 meters or 720 kilocycles.

WGY, Schenectady, General Electric company. Second episode at 8:15 p. m., Eastern time, on Friday, March 12. Third episode same time March 19. Dial 379.5 meters or 790 kilocycles.

WMAQ, Chicago, Chicago Daily News. First and second episodes at 9 p. m., Central time, on Wednesday, March 10. Third episode same time March 17. Dial 447.5 meters or 670 kilocycles.

WNAC, Boston, Shepard Stores. Third episode at 7 p. m., Eastern time, on Thursday, March 11. Fourth episode at same time March 18. Dial 280.2 meters or 1070 kilocycles.

WEAN, Providence, R. I., Shepard Stores. Play broadcast by direct wire from WNAC, Boston, on same schedule as WNAC therefore. Dial 270.1 meters or 1110 kilocycles.

WHO, Des Moines, Bankers Life Insurance company. Third episode at 2:30 p. m., Central time, on Monday, March 15. Dial 526 meters or 570 kilocycles.

WRC, Washington, Radio Corporation of America. Second episode at 8:15 p. m., Eastern time, on Friday, March 12. Third episode same time March 19. Dial 468.5 meters or 640 kilocycles.

WLW, Cincinnati, Crosley Radio corporation. Third episode at 8:30 p. m., Central time, on Saturday, March 13. Dial 422.3 meters or 710 kilocycles.

WOR, Newark, N. J., L. Bamberger & Co. Third episode at 10:30 p. m., Eastern time, on Saturday, March 13. Dial 405.2 meters or 740 kilocycles.

WSB, Atlanta, the Atlanta Journal. Dial 428.3 meters or 700 kilocycles. Schedule to be announced over air.

WHAR, Atlantic City, N. J. The Seaside House. Dial 275 meters or 1090 kilocycles. Schedule to be announced over air.

KGW, Portland, Ore., the Portland Oregonian. Dial 491.5 meters or 610 kilocycles. Schedule to be announced over air.

KTHS, Hot Springs National Park, Ark., the New Arlington hotel. Dial 374.8 meters or 800 kilocycles. Schedule to be announced over air.

WBAP, Fort Worth, Texas, the Star-Telegram. Dial 475.9 meters or 630 kilocycles. Beginning in April. Schedule to be announced.

EPISODE THREE

THE SETTING

EPISODE Three continues in the high-beamed hunt-room, the room that has been the scene of strange and mysterious crimes, of the Turner manse. The guests who had gathered there to hear a message from Peleg Turner, have waited patiently until Tolliver returns from the Radio stations to report that murderous deeds have been afoot there, too. Just as he displays a letter he has stolen from the motorcycle cop at the station, Mary Williams seemingly faints, throwing out her hand and upsetting the candle. In the resultant darkness, Ardwyn, the lawyer, lays hands on a strange person, but is bitten viciously on the wrist and he lets go. He cries out, Hari Singh comes with a light, order is restored, and the letter has disappeared.

We now discover our group, still in the dim light of a candle, anxiously bidding Mr. Ardwyn have his wound dressed without delay.

THE CAST

Frederick Ardwyn.....Peleg Turner's lawyer
Aunt Helen Holmes.....A relative
Henry Graves.....A mysterious man Mary had known formerly
Hari Singh.....Indian servant of Peleg Turner
Mary Williams.....A youthful guest

6:30, Parody club orchestra; 7, Jack Denny's orchestra; 10:30, Norman Pearce, readings; 11, Ernie Golden and his Hotel McAlpin orchestra.

WNAC, Boston, Mass. (280.2m-1070kc), 6, The Smilers, Clyde McArdle; 8:30, Shepard Colonial music; Billy Losse; 8, Knickerbocker club and assisting artists; 9, varied program, De Vry entertainment service; 10, Lambert Brother's orchestra and "The Plunkerters"; 11, music, Copley Plaza hotel; Copley Plaza orchestra; vocal selections, Jack Fey, Rose Goldberg, accompanist.

WNYC, New York, N. Y. (526m-570kc), 2 p. m., Saturday forum, Democratic club; 7, Hotel St. George society orchestra; 8, Ann Emily Harford; 8:15-9:15, Avery concert; 9:30, instrumental feature.

WOO, Philadelphia, Pa. (508.2m-590kc), 12:02 p. m., Golden's crystal tea room orchestra; 4:45, organ recital; 7:30, Adolphia concert orchestra.

WOR, Newark, N. J. (405.2m-740kc), 3:15-4 p. m., Zit's Central Park Casino tea music; 6:30-7:15, Jacques Jacobs' Hotel Shelton ensemble; 7:30-7:45, Van's Collegians; 9:15-9:45, La Forge-Berumen Saturday evening musicale; 10, Two Blue Boys; 10:45-11:45, Katinka orchestra.

WPG, Atlantic City, N. J. (299.8m-1000kc), 1:30 p. m., Hotel Morton luncheon music; 6:45, organ recital, Arthur Scott Brook; 7, Hotel Morton dinner music; 8:15, program; 9, Hotel Ambassador concert orchestra; 10, Nick Nichols' dance orchestra; 11, dance orchestra.

WRC, Washington, D. C. (468.5m-640kc), 12 m., organ recital; 1, Hamilton hotel orchestra; 7, Hotel Washington orchestra; 9, musical program; 10:30, Meyer Davis' Swane synchoppers.

WTAG, Worcester, Mass. (268m-1120kc), 10:30 a. m., musical selections; 12:05-2 p. m., luncheon music; 3-5, tea dansant music.

WTAM, Cleveland, Ohio (389.4m-770kc), 12:15-1:30

p. m., lunch hour music, Austin Wylie's Vocalion Recording orchestra; 6-7, dinner hour music, Guy Lombardo and his Royal Canadians; 8-9, Hollenden hour, Carl Kupp and his Hotel Hollenden orchestra; 9-12, novelty program, Ev. Jones and his gang, assisted by entertainers.

WTIC, Hartford, Conn. (475.9m-630kc), 6:30 p. m., "Twenty Minutes in Happyland"; 6:50, Hotel Bond trio; 8, American Legion orchestra.

WVJ, Detroit, Mich. (352.7m-850kc), 12:05 p. m., Jules Klein's Hotel Statler orchestra; 5, Detroit News orchestra.

Central Time Stations

KFAB, Lincoln, Nebr. (340.7m-880kc), 5:30-6:30 p. m., dinner concert; 8:30-10:30, variety program; 12-2 a. m., orchestra entertainment.

KFMX, Northfield, Minn. (336.9m-890kc), 10-11 p. m., organ recital.

KFRU, Columbia, Mo. (499.7m-600kc), 4:30 p. m., Bella Vista Quadrangle orchestra.

KFVE, University City, Mo. (240m-1190kc), 9:15 p. m., dramatic readings, Romanus Fielding; the Lincoln entertainers; organist, Solon Nealey; harmonic duo.

KLDS, Independence, Mo. (441m-680kc), E. N. Brinkman, baritone; Mrs. N. Brinkman, contralto; Mrs. Richard Keller, pianist; George Howerton, organist; Louis Mason, soprano.

KMA, Shenandoah, Iowa (252m-1190kc), 11:30-12:30 a. m., music; Grady and Doc; 6-7 p. m., music; 9-11, pipe organ recital, William Howie.

KMOX, St. Louis, Mo. (280.2m-1070kc), 12:30 p. m., Arthur L. Utt, organist; 3, string ensemble music; Mrs. David Mournoy, soloist; 5, Arthur L. Utt, organist; 6:30, Mrs. Jacques Landree, organist; 7, orchestra; "The Little Red School House"; "The Golden Voiced Tenor," in song recital; 8, orchestra; Clifford Worland, baritone; 9, orchestra; "Colonel 6121"; E. D.

Browner, baritone; Banjo quartet; 10, orchestra; 10:30, orchestra.

KPRC, Houston, Texas (296.9m-1010kc), 8 p. m., Edith Brown, organist; 8:30, Frank Tilton, pianist; 11, Sky-line studio.

KSD, St. Louis, Mo. (545.1m-550kc), 7 p. m., orchestral program and stage specialties; 8:30, St. Louis symphony orchestra.

KTHS, Hot Springs National Park, Ark. (374.8m-800kc), 12:30-1:30 p. m., Bible class; 9-10:30, Harlin H. Smith and his old-time fiddlers; 10:30-10:45, Louis Davis, baritone; 10:45-11, dance selections, New Arlington hotel orchestra; 11-11:45, artists presentation.

KWVG, Brownsville, Tex. (278m-1080kc), 6 p. m., Sunshine Girl.

KYWH, Chicago, Ill. (538m-560kc), 12:05-1 p. m., noon-day concert; 1-2, luncheon concert, Congress hotel; 4, Saturday frolic; 6-7, dinner music; 7:30, home-lovers' hour; 11:30, Congress classic, Congress hotel; 11:30-1, Congress carnival; 1, Insomnia club.

WAMD, Minneapolis, Minn. (244m-1230kc), 12:01 p. m., popular musicale; Original Gold Derbyes trio; Carl Litzberg, tenor; 6:15, dinner concert, George Osborn and his orchestra; 7:10, Harmony Twins, Fred and Bob; orchestra; 11:30, organ recital.

WBAP, Ft. Worth, Tex. (475.9m-630kc), 12:05-12:30 p. m., Fred Cahoon's orchestra; 6-6:30, dinner music; 7:30-8:30, musical numbers; 9:30-11, Hired Hand's Little symphony.

WBBM, Chicago, Ill. (226m-1330kc), 4-6 p. m., Harry and Sandy; Court Banks; Johnny Black; Russell Meyers; Jack Pennewell and Freddy Palmieri; 8-9:30, Jack Crawford's Aleutic orchestra; Barber Shop Three; 9:30-11, Sandy and Harry; Moulton Rouge orchestra; William E. Anderson, steel guitarist; Sy Berg; Fred Jacobson, 11-2 a. m. Sunset quartet; Two Jays; Charlie Garland; Spencer, Lavergne and Shayne, xylophonists; Barber Shop Three; Jack Crawford's Aleutic orchestra; Claire Matthews; Floyd Patch; Ariston trio.

WCCO, Minneapolis-St. Paul, Minn. (416.4m-720kc), 12:30 p. m., Emmet Long's Golden Pheasant orchestra; 2:30, afternoon concert; 6:15, dinner concert, Wesley Barlow's Nicollet hotel orchestra; 8:15, musical program; 10:05, Walle Erickson's Coliseum orchestra.

WDAF, Kansas City, Mo. (365.6m-820kc), 3:30-4:30 p. m., The Star's string trio; 6-7, organ music; Trianon ensemble; 11:45-1 a. m., special frolic, President hotel.

WEBB, Chicago, Ill. (370.2m-810kc), 3-4 p. m., special features; 7, Oriole orchestra; 8, Dorothy Herman Blum, soprano; 9, Oriole orchestra; 9:45, James Murray, tenor; Oriole marimba band; 11, Oriole orchestra; 12, James Murray, tenor; 1 a. m., Pat Ward, songs; 2, Frank Greif, songs.

WFAA, Dallas, Texas (475.9m-630kc), 3:30-4 p. m., Ewen Hall, tenor; 4:30-5, Ligon Smith, Howard Hill, vocal duets; 6:30-7:30, Jimmy's Joys; 8:30-9:30, Mrs. H. S. Stavelly, soprano; Fred J. Wilcox, pianist; 11-12, Jack Gardner's orchestra.

WGES, Oak Park, Ill. (250m-1200kc), 5-7 p. m., organ, bass, tenor; 8-9, orchestra; 11-1 a. m., Uke girl, organ, orchestra.

WGN, Chicago, Ill. (302.8m-990kc), 12:40-2:30 p. m., Drake concert ensemble, Blackstone string quintet; 2:30-3, Lyon and Healy artists; 3:30-4:15, Teal time music, Marshall Field's tea room orchestra; 4:30-5, organ recital, Edward Benedict; 6:30-7, dinner concert, Drake concert ensemble, Blackstone string quintet, old-time favorites; 8-9, studio program; 9-10, popular program, Freda Leonard, Jewel Barnette, Correll and Gosden; 10:10-10:20, old-time favorites; 10:20-10:40, the playshop.

WHAD, Milwaukee, Wis. (275m-1090kc), 4 p. m., orchestra, vocal selections; 6, Wisconsin theater organs.

WHAS, Louisville, Ky. (389.8m-750kc), 1-2 p. m., concert, Benson trio; 3-9:30, organ recital, Mrs. Myrtle Fuiks Zahn, Jr.; 4-5, concert; 7:30-8, concert, Royal Peacock orchestra.

WJJD, Mooseheart, Ill. (370.2m-810kc), 12-1 p. m., Palmer House symphonic players; Palmer House trio; 2-3, Howard L. Peterson, organist; 4-5, Palmer House quintet; 5:30-7, dinner hour; 8-9, Palmer House Victorians; 10-11, Palmer House Victorians; 12-1 a. m., Palmer House Victorians; Jack Nelson.

WKAF, Milwaukee, Wis. (261m-1150kc), 10-11 p. m., Trixie Ann Troy and her Royal Hawaiians; El Coleman's dance orchestra.

WKRC, Cincinnati, Ohio (325.9m-920kc), 10 p. m., Marion McKay and his orchestra; 11, Marie Turner, blues singer; 11:15, Marion McKay and his orchestra.

WLJB, Chicago, Ill. (302.8m-990kc), 7:20-8 p. m., Uncle Walt's Punch and Judy show; 7:20-7:30, Correll and Gosden; 7:30-8, studio program; 11-11:20, Correll and Gosden; 11:20-1, dance music; Correll and Gosden.

WLS, Chicago, Ill. (344.6m-870kc), 12 m., Doris Wittich, pianist; 7, Ford and Glenn; 7:20-12, national barn dance and revue.

WLW, Cincinnati, Ohio (422.3m-710kc), 7:40 p. m., meeting of the Seekatory Hawkins Radio club; 8, "A Day on the Farm"; Donald Bain, whistling and imitations of fowls and musical instruments; old fiddlers, Kimmon's band; Walter Kimmon, violinist; 9:30, Castle farm.

WMAQ, Chicago, Ill. (447.5m-670kc), 5:15 p. m., Topsy Turvy time; 6, Chicago theater organ; 6:30, program, Junior Association of Commerce; 8, Daw and Pratt; 9, Balaban and Katz Chicago theater Radio revue.

WMBB, Chicago, Ill. (250m-1200kc), 7-8 p. m., Edith Stonehouse, soprano; Rosalind Wallach, violinist; Edwin House, bass; Preston Graves, pianist; 9-11, Trianon orchestra; Woodlawn theater orchestra; Walter Kip; Harnes Brothers; Ted Graham, baritone.

WMO, Memphis, Tenn. (499.7m-600kc), 8:30 p. m., Pullman Porters' concert.

WOA, Omaha, Nebr. (526m-570kc), 5:30 p. m., Manna Kea trio; 6, Kallio kids; 6:15, Herb Ferguson and his orchestra; 9, de luxe; 10:30, Frank Hodock and his Nightingale orchestra; 11, Arthur Hays, organist.

WOC, Davenport, Ia. (483.6m-620kc), 5:45-6 p. m., chimes concert; 9-10, musical program; Mrs. Edward R. Kennedy, contralto; Frank Webster, tenor; 11-12, orchestra program, LeClaire hotel orchestra.

WOI, Ames, Ia. (270m-1110kc), 12:30 p. m., college chimes.

WOK, Chicago, Ill. (217.3m-1300kc), 4:30-7 p. m., Capitol theater organ; Howard Will, tenor; 10-1, Tearney's Town Club orchestra; Carl Lorraine's Pershing Palace orchestra; Husk O'Hare's Coconut Grove orchestra; Capitol theater program; program.

WORD, Batavia, Ill. (275m-1090kc), 7 p. m., Webster hotel trio; 9-10, program.

WQJ, Chicago, Ill. (447.5m-670kc), 3-4 p. m., Koffee Klatsch, Jerry Sullivan; Rose Vanderbosch, soprano and pianist; Hal Lansing and his uke; 7-8, dinner concert, Jack Chapman and his Rainbo Gardens orchestra; Katherine Parrish, pianist; Kane McDuffee, whistler; Joseph Parsons, bass; 10-3 a. m., Jack Chapman and his Rainbo Skylarks; Jerry Sullivan and Rose Vanderbosch, soprano and pianist; Hal Lansing and his uke; Everett George Opi, character reader; Clarence Theders, tenor; Joe Warner, character songs; Oxford girls, Harmony singers; Gall Bandell, Sunshine Girl; Rita McFawn and Mary Bieber, harmony duo; West Brothers, Hawaiian guitarists; artists.

WSAI, Cincinnati, Ohio (325.9m-920kc), 7:50, chime concert, Robert Badgley; 8:15, Bicycle Playing Card sextet; 12, Freda Sancker's orchestra.

WSB, Atlanta, Ga. (428.3m-700kc), 6 p. m., Sunday school lesson; 8, Atlanta Atwater Kent hour; 10:45, Rogers Red Head club.

WSM, Nashville, Tenn. (282.8m-1060kc), 6:30 p. m., concert, Francis Craig's orchestra; 8, barn dance program, features.

WSMB, New Orleans, La. (319m-940kc), 9:30 p. m., Cotton Pickin' twins, Strand theater orchestra; Ray McNamara, pianist.

WSOE, Milwaukee, Wis. (246m-1220kc), 8:30 p. m., Sunday school lesson; 9, Lakefront studio program.

WSUI, Iowa City Iowa (483.6m-620kc), 7:30 p. m., Celeste Fuhrmann, soprano; Zita Fuhrmann, pianist.

BARNYARD SOUNDS THROUGH WLW



A daily feature at two stations is Dean Fossler, organist at the Chicago theater. His playing of this mighty organ may be heard from WGN during the noon program and on WMAQ's dinner concert. To the right is Martha Rowland Brown, studio accompanist and bedtime story lady at WSM. Brown photo, Schumacher studio.



KJR, Seattle, Wash. (384.4m-780kc), 8:30-10 p. m., studio program, artists.
KMTR, Hollywood, Calif. (238m-1260kc), 6-7 p. m., Starr Piano company studio; 8-10, KMTR concert orchestra, Edmund Foerster, guest conductor.
KNX, Hollywood, Calif. (336.9m-890kc), 5:30 p. m., Leighton's orchestra; 6:30-7, Atwater Kent orchestra; 7:30-10, KNX feature program; 10-11, Ambassador hotel dance orchestra; 11-3 a. m., Filmland frolic.
KPO, San Francisco, Calif. (428.3m-700kc), 1-2 p. m., Rudy Seiger's Fairmont hotel orchestra; 2:30-3:30, matinee program of popular music; 3:30-5:30, Cyrus Trobber's Palace hotel concert orchestra; 6:35-7:30, Waldemar Lind and the States Restaurant orchestra; 8-12, Fairmont hotel dance orchestra; Maurice Gunsky, tenor; Merton Borice, pianist; intermission solos.
KPSN, Pasadena, Calif. (315.6m-950kc), 8-9 p. m., Star-News concert; 9-10, dance orchestra.
KTAB, Oakland, Calif. (249m-1250kc), 9-9:30 a. m., prayer service; 12-1, luncheon concert.

WCAD, WCAR, WDAF, WDBO, WEAQ, WEBJ, WEBW, WFI, WGES, WGHZ, WGHF, WGST, WHAD, WHAS, WHAZ, WIP, WJAZ, WJJD, WJR, WKAF, WKAG, WKAR, WMAQ, WMAZ, WMC, WNYC, WOI, WRC, WRVA, WSB, WTAM.

Eastern Time Stations

CFCA, Toronto, Can. (356.9m-840kc), 11 a. m., St. Enoch's United church; 7 p. m., St. Paul's Anglican church.
CKCL, Toronto, Canada (356.9m-840kc), 3-4:15 p. m., Parkdale United Sunday school orchestra, assisted C. K. C. L. quartet; 4:15-4:55, service for men; Bishop Willard Brewing.
KDKA, Pittsburgh, Pa. (308.1m-970kc), 11 a. m., church services; 4 p. m., organ recital, Dr. Charles Heimroth; 4:45, Shady-side Presbyterian church; 6:30, dinner concert; 7-13, chimos, Calvary Episcopal church; 7:45, church service.
WBAL, Baltimore, Md. (246m-1220kc), 8:30-7:30 p. m., twilight program; WBAL concert orchestra.
WBBR, New York, N. Y. (272.6m-1100kc), 10 a. m., L. Marlon Brown, soprano; I. B. S. A. choral singers; Bible lecture, Judge Rutherford; 2 p. m., Watchtower orchestra; Carl Pierzchatsky, trombonist; L. Marion Brown, soprano; Bible lecture, F. W. Franz; 9, instrumental duets.
WBZ, Springfield, Mass. (333.1m-900kc), 10:45 a. m., services, Trinity church; 6 p. m., Golden Rule hour of music; Ary Duffer, violinist; Alexander Blackman, viola; George Brown, cellist; Hans Ebell, pianist; soloists; 7, dinner concert, Copley Plaza orchestra.
WCAE, Pittsburgh, Pa. (461.3m-850kc), 4 p. m., Dr. S. P. Cadman; 6:30, dinner concert; 7:20, Capitol theater Gang; 9:15, Atwater Kent.
WCAP, Washington, D. C. (468.5m-640kc), 11 a. m., services, Luther Place Memorial church; 4 p. m., services, Bethlehem chapel; 6:20-7:20, chamber music; Vesper string ensemble; 7:20-9:15, WEAF; 9:15-10:15, WEAF.
WCAU, Philadelphia, Pa. (277.6m-1080kc), 7:30, concert, N. Snellenburg and company; 8, Carolyn Thomas, soprano, Ella Jacquete Kratz, pianist; 8:30, the Hood Boys; 9, Malis' Mercy minstrels; 9:30, Sugar Cane orchestra; 10, Arline K. Smith, soprano; 10:30, Parolians dance orchestra.
WCX, Detroit, Mich. (516.9m-580kc), 7:15 p. m., Central Methodist Episcopal church; Guy C. Filkins, organist.
WDBO, Winter Park, Fla. (239.9-1250kc), 11 a. m., church service; 5-6 p. m., vesper service; 8, church service.
WEAF, New York, N. Y. (491.5m-610kc), 2-3 p. m., Sunday Radio services, Greater New York Federation of Churches; 3-4, young people's conference, auspices of Greater New York Federation of Churches; 4-5:30, men's conference, Bedford branch, Y. M. C. A., Brooklyn, N. Y., WEEL, WTAG, WCAE, WSAI; 5:30-6, musical program; 6-7, George Barrere's Little Symphony orchestra, WEAF, WJAR, WFI; 7-7:20, chamber musicale, WJAR, WFI; 7:20-9:15, Capitol theater, WEEL, WCAP, WJAR, WTAG, WWJ, WCAE; 9:15-10:15, Atwater Kent Radio hour, WEEL, WCAP, WJAR, WGR, WCAE, WSAI, WWJ, WOC, WCCO, WGN, WEAR, KSD, WTAG, WFI.
WEAR, Cleveland, Ohio (389.4m-770kc), 3:30 p. m., Goodyear concert orchestra; 7, Lowe's theater orchestra; 7:45, fireside hour; 8:30, Vincent Percy, organist; 9:15, WEAF.
WEEL, Boston, Mass. (348.6m-860kc), 2 p. m., Sager's hour of hospitality; 3, organ recital; 5:30, Ecker concert group; 7:20, World Radio corporation sextet, soloists and string trio; 7:50, WEAF; 9:15, WEAF.
WFI, Philadelphia, Pa. (394.5m-760kc), 6 p. m., George Barrere and his symphony orchestra.
WGBS, New York, N. Y. (315.6m-950kc), 3 p. m., Arrowhead Inn tea dance; 3:30, Crystal Palace orchestra; 9:30, grand opera.
WGCP, New York, N. Y. (252m-1190kc), 3 p. m., Olympic orchestra; 3:30, Milton Yokeman, tenor soloist; 3:45, Rita Redboard, soprano; 4:45, Alfred Hall, baritone.
WGR, Buffalo, N. Y. (319m-940kc), 10:45 a. m., Westminster Presbyterian church; 7:45 p. m., Central Presbyterian church; 9:15, jointly with WEAF, Atwater Kent program.
WGY, Schenectady, N. Y. (379.5m-790kc), 10:30 a. m., First Baptist church; 12:30 p. m., WJZ; 3, WFBL; 5, organ, Dr. Frank Sill Rogers; Giovanni Trombini, cellist; 7:30, First Baptist church, Gordon H. Baker; 9, WJZ.
WHAR, Atlantic City, N. J. (275m-1090kc), 10:45 a. m., services, Chelsea Baptist church; 2:15 p. m., sacred recital, Seaside hotel trio; 2:45, sermon; 7:50, services, Chelsea Baptist church; 9, an hour with the classics, Seaside hotel quartet.
WHN, New York, N. Y. (361.2m-830kc), 11:30 a. m., Calvary morning services; 12:30 p. m., Lexington organ recital; 2, Queens County Christian Endeavor program; 3, Radio Bible class; 5, Roseland dance orchestra; 6, people's hour; 7:30, Calvary evening services; 10:15, Anatol Friedland; 10:45, Janssen's Hofbrau Haus orchestra; 11:30, Twin Oaks orchestra; 12, Harry Richman and his entertainers.
WIP, Philadelphia, Pa. (508.2m-590kc), 7:15 Holy Trinity church; 10, grand opera, Germantown theater; Ben Stad and his WIP Symphony orchestra.
WIZ, New York, N. Y. (454.3m-660kc), 12:30 p. m., Sunday Symphonic society; 8, Bakelite hour; 9, Commodore concert orchestra.
WLIT, Philadelphia, Pa. (394.5m-760kc), 2:15 p. m., Arcadia cafe concert orchestra; 7, organ recital; 7:30, Benjamin Franklin concert orchestra.
WLW, New York, N. Y. (288.3m-1040kc), 8 p. m., Paulist choristers, sermon, Rev. Lewis J. O'Hara.
WMAK, Buffalo, N. Y. (266m-1130kc), 10:25 a. m., services, First Presbyterian church, Rev. Stewart Robinson, pastor; 7:30 p. m., evening services, Churchhill tabernacle.
WMCA, New York, N. Y. (340.7m-880kc), 3 p. m., Minot Simons, D.D., "What To Think in Religion," All Souls church; 3:30, Donald Flamm's frolicers; 5:45, Halpert and Fryxell's entertainers; 6, Roemer's Homers; 7, Ernie Golden and his Hotel McAlpin orchestra; 7:30, Olcott Vail and his Hotel McAlpin string ensemble; 8:45, Mayolians; 9:30, Parody club orchestra; 10:30, Twin Oaks orchestra; 10:45, Arthur West's girls; 11, Jack Denny's orchestra.
WOO, Philadelphia, Pa. (508.2m-590kc), 10:30 a. m., services, Bethany Presbyterian church; 2:30, musical exercises, Bethany Sunday school; 6, organ recital.
WPG, Atlantic City, N. J. (299.8m-1000kc), 3:15 p. m., Arthur Scott Brook, organist; L. Powell Evans, baritone; 4:15, vocal and instrumental recital; 9:15, Hotel Traymore concert orchestra; 10, Arthur Scott Brook, organist.
WTAG, Worcester, Mass. (266m-1120kc), 3-4 p. m., sermon and songs; 4-5:30, music, Gloria Trumpeters; George Betts, chime soloist; Mr. and Mrs. Howard Kinsey, baritone and accompanist; 7:20-9:15, musical program; 9:15-10:15, WEAF.
WTIC, Hartford, Conn. (475.9m-630kc), 9 p. m., an evening of opera, A. Y. Cornell opera group.
WWJ, Detroit, Mich. (352.7m-850kc), 11 a. m., St. Paul's Episcopal cathedral; 2, Detroit News orchestra; 4, organ recital; 7:20, WEAF; 9:15, operatic stars.

Sunday, March 14

Headliners Today

Eastern 6 p. m.	Central 5 p. m.	Mountain 4 p. m.	Pacific 3 p. m.
WBAP (475.9m-630kc) Sacred concert.	8	7	5
WJZ (454.3m-660kc) Bakelite hour.	8	7	6
WTIC (475.9m-630kc) An Evening of opera.	9:15	8:15	7:15
WEAF (491.5m-610kc), WREI, WCAP, WOO, WJAR, WGR, WCAE, WSAI, WWJ, WOC, WCCO, WGN, WEAR, KSD, WTAG, Atwater Kent program.	10	9	7
WIP (508.2m-590kc) Grand opera.	10:30	9:30	7:30
KPRC (296.9m-1010kc) El Tex Temple band.	12	11	10
WAMD (244m-1230kc) Harmony hurricane.	12	11	10
KFWB (252m-1190kc) Movie frolic.			
WFAA (475.9m-630kc) MacDowell Sisters.			

Sunday, silent night for: CFAC, CHIC, CKNC, CNRA, CNRC, CNRE, CNRM, CNRO, CNRR, CNRT, CNRV, CNRW, KFAU, KFAU, KFKX, KFRU, KFOA, KFVE, KFWA, KFXF, KLX, KMA, KMTR, KOAC, KOB, KOWW, KSAC, KSD, KWSC, PWX, WABQ, WAHG.

Saturday, March 13

Mountain Time Stations

KFAU, Boise, Idaho (280.2m-1070kc), 8 p. m., musical program.
KFXF, Colorado Springs, Colo. (250m-1200kc), 8:30 p. m., Rosemary Gardens music.
KOA, Denver, Colo. (322.4m-930kc), 12:15 p. m., Rialto theater organ recital, Marjorie Nash; 9, dance program, Harmony Peerless orchestra; 10:30, dance program, Scheuerman's Colorado orchestra.
KFWA, Ogden, Utah (261m-1150kc), 4-5 p. m., organ recital; 5-6, Ogden Radio dealers program; 9-10:30, music, Paramount theater; 10:30-12, dance music, Olive Reeves and his orchestra.

Pacific Time Stations

KFI, Los Angeles, Calif. (467m-640kc), 5:30-6 p. m., Harmony duo; 6, nightly doings; 6:30, vest pocket program; 6:45, Radiatorial period; 7-8, Al Wesson's dance orchestra; 8-9, Robert Hurd, tenor; 9-10, Hollywood string quartet; 10-11, Packard Radio club; 11-3 a. m., KFI midnight frolic.
KFOA, Seattle, Wash. (454.3m-660kc), 9:30-11 p. m., Rhodes Department store program, Jackie Souder's Club Lido serenaders.
KFON, Long Beach, Calif. (232.4m-1280kc), 6-6:30 p. m., Brayton's theater organ; 7-7:30, studio program; 7:30-9, Long Beach Municipal band; 9-11, KFON artists' frolic.
KFWB, Hollywood, Calif. (252m-1190kc), 6-7 p. m., Fitzgerald Music company dinner hour; 8-9, Lyrio string trio; Eunice Wynn, ballads; Dan Gridley, Irish tenor; 9-11, program, Reeve-Gartzmann, Inc.; Oakland Six dance orchestra.
KFWL, San Francisco, Calif. (226m-1330kc), 1:30-3:30 a. m., pajama party, featuring Clem Kennedy's dance band and Dick Giblin, Eddie Scott, Sadio Woodside, Baron Keyes.
KGO, Oakland, Calif. (361.2m-830kc), 11:30-1 p. m., luncheon music; 4-5:30, Hotel St. Francis concert orchestra; 8:10, Leo J. Meyberg company program; instrumental selections; 10-12, Girvin-Deuel's California Collegians.
KGW, Portland, Ore. (491.5m-610kc), 12:30-1:30 p. m., concert; 6-7, concert, Olds, Wortman and Klog company; 9-12, dance music; intermission piano solos, Curt Kremer.
KHJ, Los Angeles, Calif. (405.2m-740kc), 8-10 p. m., program, Motor Transit company, San Diego Army and Navy academy band; 10-11, Don Clark's Baltimore hotel dance orchestra.

Atwater Kent Program, March 14, over WEAF and Chain*

Artists will be, Edward Johnson, tenor, and Joan Ruth, soprano.

- I.
- Aria: "Celeste Aida" from "Aida".....Verdi
Edward Johnson with Orchestra
- II.
- Straussiana.....Arranged by Estelle Liebling
Joan Ruth with Orchestra
- III.
- Aria: Flower Song from "Carmen".....Bizet
Edward Johnson with Orchestra
- IV.
- (a) Danny Boy.....Old Irish
- (b) Lass With the Delicate Air.....Old Irish
- (c) Estrellita.....Mexican Folk Song
- (d) En Cuba.....Spanish Folk Song
- Joan Ruth
- V.
- (a) Drink To Me Only With Thine Eyes.....Old English
- (b) Run On Home.....Strickland
- (c) Sunrise and You.....Arthur Penn
- Edward Johnson
- VI.
- Aria: "Vesti la giubba" from "Pagliacci".....Leoncavallo
Edward Johnson with Orchestra
- VII.
- Duet: "Eil sol dell' anima" from "Rigoletto".....Verdi
Edward Johnson and Joan Ruth

*The WEAF chain for the Atwater Kent hour (9:15 p. m. Eastern, 8:15 p. m. Central time) includes WEAF, WFI, WGR, WCAE, WCAP, WJAR, WTAG, WGN, KSD, WCCO, WOC, WSAI, WEAR, WEEL, WWJ.

Central Time Stations

KFAB, Lincoln, Nebr. (340.7m-880kc), 4-5 p. m., vesper service; 9-11, Sunday evening musical.
KFDM, Beaumont, Texas (315.6m-950kc), 11 a. m. and 7:30 p. m., First Baptist church of Beaumont.
KFMX, Northfield, Minn. (336.9m-890kc), 7-8 p. m., vesper service.
KFRU, Columbia, Mo. (499.7m-600kc), 7:30 a. m., services; 9:30, Burrall Bible class; 7:30 p. m., student service, Columbia Baptist church.
KFUO, St. Louis, Mo. (545.1m-550kc), 4 p. m., musical program, mixed choir, Immanuel Lutheran church; "God is Love," Rev. Niedner; 9:15, "Pilate," Rev. John

FAVORITE SCREEN STARS AT KFWB

High Lights of the Week

HEAR the cows lowing, the cocks crowing, the pigs squealing and other sounds familiar to the farm during the 8 o'clock program Saturday from WLW. Whether these sounds will be reproductions or the real thing is not known. Better tune in and find out who the artists really are.

The Sunday classical programs given over the WEAJ chain have charmed the ear with more than one famous artist. This Sunday's programs will be given by Edward Johnson, tenor and Joan Ruth, contralto. A motion picture frolic winds up the evening introducing Warner Brother stars at KFWB.

Let the Severino mandolin quintet serenade you early in the evening Monday at WGY. This quintet can play all the old romantic tunes which breathe of moonlit nights and fair señoritas. The fresh young voices of Camp Fire Girls will enhance the microphone of WSB.

Mishel Piastro, concert master of the San Francisco Symphony orchestra, and one of the greatest living artists of the violin, will give a recital over KGO, Tuesday evening, March 16, assisted by Lev Shorr, Russian pianist. Piastro will be on the air

between 8 and 9 p. m. Pacific time, and will play five solo numbers.

No blues on the air Wednesday. Tune in at any station anywhere on your dial and Irish songs will float in through the loud speaker for this is St. Patrick's Day and all the stations are celebrating. The Dennis Sisters have returned to WEBH and promise a real auld Erin program on this night. The Four Musketeers will invade WHO this same evening with appropriate songs.

Thursday marks the opening of a new vaudeville feature at KGW, Portland. It will not be necessary now for Portland fans to patronize the two-a-day. This station plans to bring the best talent to them. A new feature is also introduced at WGY which shows that spring is on the way. "Fly Fishing on a Canadian Lake," is the title of the first fish talk given by Dick Shaw.

"Elijah," a tremendous oratorio seldom given by any musical organization, will be produced Friday by the Apollo club at WLS, Chicago. A distinctive musical feature will also go on the air at WBAL when typical Negro music will be broadcast by the choral club of Morgan college.



WBZ's pleasing programs are due to the delightful lady to the left, Miss Emily W. Sturtevant, who not only plans them, but often visits over the microphone with her invisible friends. Vincent Lopez, above, as he looks announcing his orchestra numbers Tuesdays over WEAJ chain.

Sunday, March 14

Fritz; musical program, artists, Grace Lutheran church, KLDs, Independence, Mo. (441m-680ke), 11 a. m., Stone church service; Robert Miller, organist; 3 p. m., Watson Memorial M. E. church; Watson Memorial M. E. choir; Hazel Cook, organist; Rev. W. E. Brown, sermon; 6:30 vesper service; Walnut Park quartet; U. W. Greene, sermon; 8:15, Albert Braekembury, baritone; Pauline Becker Etzenhauser, organist; Lillian Green, violinist; Dr. Frederick M. Smith, sermon.

KMA, Shenandoah, Iowa (252m-1190ke), 12:15-1:15 p. m., sacred song service, Mrs. Earl May; 4, church choir music; 5, Bible class, G. H. Van Houten.

KPRC, Houston, Texas (296.9m-1010ke), 10:30 a. m., chimes; 10:50, St. Paul Methodist church; 7:30, First Methodist church; 9:30, D. O. K. K. band.

KSD, St. Louis, Mo. (545.1m-550ke), 6:15 p. m., Post-Dispatch concert orchestra; 8:15, WEAJ.

KTHS, Hot Springs, National Park, Ark. (374.8m-800ke), 11 a. m., Saint Luke's Episcopal church; 9:10, concert, New Arlington hotel grand ensemble and soloists; Moyer Davis orchestra; 10-11:30, musical train crew; 11:30-12:30, midnight organ classic.

KYW, Chicago, Ill. (536m-560ke), 11 a. m., Central church; 2:30, studio chapel; 4:30, studio concert; 7, Chicago Sunday evening club; 9:30, classical concert, Commonwealth Edison company.

WAMD, Minneapolis, Minn. (244m-1230ke), 10:30 a. m., First Unitarian church services; 8 p. m., band concert, Pillsbury band; 6:15, dinner concert, George Osborn and his orchestra; 6:45, Arthur Faust, Leone Faust and Radio Stock company; 9:30, Gayle Wood, harmony hurricane.

WAP, Ft. Worth, Tex. (475.9m-630ke), 11 a. m., First Presbyterian church; 5-6, sacred concert, Glenwood Church of Christ; 9:30-11, dance music, Chief Gonzales' Texas hotel orchestra.

WBBM, Chicago, Ill. (226m-1330ke), 12:30-2 p. m., classical program: William P. Zimmer, tenor; Harold Morava, lyric tenor; Kantor A. Kritiz; Sandy Meek and Harry Sosnik; Edna Wheeler Ballard, harpist; Little Caruso and the Moulou Rouge operatic quartet; 4-6, Tip trio; Jack Crawford's Alomite orchestra; Barber Shop Three; Ziegler Sisters; Two Jays; Harold Anderson; Charlie Garland; Rudy Winter; Floyd Falch; 8-10, Jack Crawford's orchestra; quartet; Maurice Silverman; Pauline Stiffler Atlas, violinist; Rudy Winter; Floyd Falch; Hazel McBroom; 12-2 a. m., Nutty club.

WCAL, Northfield, Minn. (336.9m-890ke), 8:30 a. m., Norwegian church services; 9:15, evening services.

WCBD, Zion, Ill. (344.6m-870ke), 8 p. m., mixed quartet, brass quartet, organ selections; Ralph Bull, tenor; Erna Reynolds, soprano; Edith Carey, contralto; E. B. Paxton, baritone; P. Newcomer, cornetist; George Beem and Carl Newcomer, marimba soloists; Mrs. Hester Robinson, reader.

WCCO, Minneapolis-St. Paul, Minn. (416.4m-720ke), 10:50 a. m., Plymouth Congregational church; 3, Bible study; 4:10, House of Hope Presbyterian church; 6:20, Sacred Church of Christ; 8:15, WEAJ.

WDAF, Kansas City, Mo. (365.6m-820ke), 8-4 p. m., Negro spirituals; 4-4:45, WDAF's Sabbath vespers.

WEBH, Chicago, Ill. (370.2m-810ke), 10:40-12 noon, Seventh Church of Christ, Scientist; 5-6 p. m., twilight musical; 7-9, selected artists' program.

WEMC, Berrien Springs, Mich. (285.5m-1050ke), 11 a. m., Jeanette Richardson, soprano; Hoosier male quartet; 11:45, sermon, Pastor W. French; 12 noon, Ellis Maas, baritone; 8:15 p. m., Trinity studio choir; reading, Mrs. Mabel Curtis-Butterfield; 8:50, sermon; 9:05, Maitland Alfred, tenor; Victor Sterrett, violinist.

WFAA, Dallas, Texas (475.9m-630ke), 6-7 p. m., Bible class; 7:30-8:30, City temple; 8:30-9:30, Leland Johnson, pianist; 11-12, MacDowell Sisters.

WGES, Oak Park, Ill. (250m-1200ke), 10:15 a. m., Austin M. E. church; 5-7:40 p. m., Moody Bible Institute; 11-12, organ.

WGN, Chicago, Ill. (302.8m-990ke), 11:45-1 p. m., Chicago theater organ recital; 1-2, Chicago theater performance; 2-3, Lyon and Healy organ recital, soloists; 3-4, Chicago Philharmonic orchestra; 4-5, Chicago Musical college concert; 8:15-9:15, WEAJ; 9:15-10, popular program; 10-10:10, Sam 'n' Henry; 10:10-10:20, old-time favorites; 10:20-11, popular program.

WHAD, Milwaukee, Wis. (275m-1090ke), 8:15 p. m., Milwaukee Turnverein symphony orchestra.

WHAS, Louisville, Ky. (399.8m-750ke), 9:57 a. m., organ prelude; 10, Broadway Baptist church; H. U. Goodwin, organist; Mrs. O. W. Edinger, soprano; Angeline McCrocklin, contralto; Charles H. Barnes, Jr., tenor; William Cornwall, baritone; 4:30-5:30, Evensong choral service; Ernest Simon, organist.

WHB, Kansas City, Mo. (365.6m-820ke), 9:40-10:45 a. m., services, Linwood Boulevard Christian church; Mrs. F. Bishop, organist; Nora Moss, contralto; 11:15-12:30 p. m., services; Hans Fell, organist; 8-9:15, services, Westport Methodist church; 11:15-1 a. m., Linwood theater feature, Morrill Moore, organist; Don Anchors, poet.

WHO, Des Moines, Iowa (526m-570ke), 11 a. m., services, St. Ambrose cathedral; 7:30-8 p. m., Bankers

Lifo trio, Helen Birmingham, director; Myrtle Williams, soprano; Stewart Watson, baritone; 11-12, Bankers Life Little symphonic orchestra, Leon Dashoff, director.

WJJD, Mooseheart, Ill. (370.2m-810ke), 7:45 a. m., Catholic services; 9:40-10:30, Protestant services; 8-4 p. m., Mooseheart Sunday concert.

WKAF, Milwaukee, Wis. (261m-1150ke), 4-6 p. m., Jean Hammond and her Tune Tinklers; Kurt Geibel, German folk songs; E. G. Vallier, baritone.

WKRC, Cincinnati, Ohio (325.9m-920ke), 6:45 p. m., Walnut Hills Christian church; 10, classical program; 11:15, Marion McKay and his orchestra.

WLIB, Chicago, Ill. (302.8m-990ke), 5-6 p. m., chamber musical program.

WLS, Chicago, Ill. (344.6m-870ke), 6 p. m., prelude; 6:30-7:55, Little Brown church in the vale; Ralph Emerson, organist; WLS trio.

WLW, Cincinnati, Ohio (422.3m-710ke), 9:50 a. m., school, editorial staff of Sunday School publications; 11, morning worship, Seventh Presbyterian church; 3 p. m., negro civic welfare singers, James H. Robinson, director; 4, organ recital, Mrs. Lillian Arkell Rixford; 7:30, services, Emmaus Lutheran Evangelical church, P. L. Dannenfeldt, pastor; 8:30, concert, auspices H. & S. Pogue Co. orchestra; Glover Davis, tenor.

WMAZ, Macon, Ga. (261m-1150ke), 3-5 p. m., music, Philharmonic society.

WMBB, Chicago, Ill. (250m-1200ke), 3-5 p. m., Trianon orchestra; Woodlawn theater orchestra; Nina Smiley, soprano; Bob Duffy, baritone; 7:40-9, Fifth Church of Christ Scientist; 9-11, Trianon orchestra; Woodlawn theater orchestra; Walter Kip; Scotty Welsh, Madison Sisters; Golden Harmony trio.

WMC, Memphis, Tenn. (499.7m-600ke), 11 a. m., St. Mary's Episcopal cathedral.

WQAI, San Antonio, Texas (394.5m-760ke), 11 a. m., First Presbyterian church; 7:30 p. m., Central Christian church; 9:30, Super-Heterodyne hour of music.

WOAW, Omaha, Nebr. (526m-570ke), 9 a. m., chapel service; 1:30 p. m., matinee program; 6, Bible study period, Mrs. Carl R. Gray; 9, chapel service.

WOC, Davenport, Iowa (483.6m-820ke), 1-2:30 p. m., orchestra concert, The Palmer Little Symphony; Paul J. Vipperman, tenor vocalist; 8:15-9:15, musical processions, WEAJ.

WOI, Ames, Ia. (270m-1110ke), 10:45 a. m., college chimes; 11, chapel service.

WOK, Chicago, Ill. (217.5m-1300ke), 1-2 a. m., Tearney's Town Club orchestra; Carl Lorraine's Pershing Palace orchestra; Husk O'Hare's Coconut Grove orchestra; program; 6 p. m.-1 a. m., Tearney's Town Club orchestra; Carl Lorraine's Pershing Palace orchestra; Husk O'Hare's Coconut Grove orchestra; Capitol theater musical program; program.

WORD, Batavia, Ill. (275m-1090ke), 10-11 a. m., services; 2:30 p. m., program, Chicago Rapid Transit company; 3:30, Bible lecture, C. W. Apgar; 7, Webster hotel trio; 9, Webster trio, I. B. S. A. choral singers.

WOS, Jefferson City, Mo. (440.9m-680ke), 9:30 a. m., Christian church; 5, vesper services Christian church; 7:30, First Presbyterian church.

WQJ, Chicago, Ill. (447.5m-670ke), 9:30-11 a. m., sermon, services, People's church, Dr. Preston Bradley; Clarence Eddy, organist; choir; 3-4 p. m., Sophie Lobel, concert pianist, Chopin program; Grace Wallace, soprano; 8-10, Jack Chapman and his Rainbo Gardens orchestra; Herman Techtentine, baritone; Lorena Anderson, soprano; Pierson Thal, concert pianist; Otis Jester, soprano; Mary Thrash House, pianist; Shepherd Levine, tenor; Joseph Parsons, basso.

WSA, Cincinnati, Ohio (325.9m-920ke), 3-4:30 p. m., Central Congregational church; Gloria Trumpeters; George Betts, chimer; Howard W. Kinsey, baritone; Mrs. Kinsey, accompanist; 7:45, chime concert, Robert Badgley; 8, sermonette; 8:15, Joan Ruth, soprano; Edward Johnson, tenor.

WSB, Atlanta, Ga. (428.3m-700ke), 5 p. m., Grant Park Methodist church choir; 7:30, Ponce de Leon Baptist church.

WSM, Nashville, Tenn. (262.8m-1060ke), 3-5 p. m., Nashville symphony orchestra concert; 7:30, services.

WSU, Iowa City, Iowa (483.6m-820ke), 9:15 p. m., Mrs. Lottie Volkmer, contralto.

Mountain Time Stations

CFAC, Calgary, Canada (435.8m-688ke), 11 a. m., First Church of Christ, Scientist.
KFKF, Colorado Springs, Colo. (250m-1200ke), 11 a. m., First Presbyterian church; 7:30 p. m., First Methodist church.

Pacific Time Stations

KFI, Los Angeles, Calif. (467m-640ke), 4-5 p. m., vesper service; 6:30, nightly doings; 7-7:30, program, A. H. Grebe and company, Synchrophase string ensemble; 7:30-8, Robert Eurd, tenor; Clara Belle Patten Wallace, contralto; 8-9, Dan L. McFarland, organist; 9-10, Harry Kelper's Mowlend dance orchestra; 10-11, Packard Six dance orchestra.

KFON, Long Beach, Calif. (232.4m-1280ke), 2:30-4 p. m., Long Beach Municipal band; 7:45-9, service, First Church of Christ, Scientist; 9-10, Bert Pedersen's dance orchestra.

KFWB, Hollywood, Calif. (252m-1190ke), 9-11 p. m., Sunday night movie frolic, Jack Smith's dance orchestra.

KGO, Oakland, Calif. (361.2m-830ke), 11 a. m., First Baptist church; Eileen Alstead Piggott, soprano soloist; Esta Marvin Pomeroy, organist; 3:30, concert, Little Symphony orchestra; 7:45, First Baptist church; Philip Ashcraft, tenor; Fred Wilkins, flute; Esta Marvin Pomeroy.

KGW, Portland, Ore. (491.5m-610ke), 10:25-12 a. m., the First Presbyterian church; 6-7 p. m., Aladdin hour of familiar melodies; 7:30-9, East Side Baptist church; 9-10, Chevrolet Symphony orchestra.

KHJ, Los Angeles, Calif. (405.2m-740ke), 4-5 p. m., Masonic service; 7-8, First Methodist Episcopal church; 8-10, program, Martin Music company; Ruth Pitts, soprano; John Martin, concert pianist.

KIR, Seattle, Wash. (384.4m-780ke), 11-12:30 p. m., services, First M. E. church; 5-6, Renfro-Wadenslein program, Spargur string quartet; 7:15-7:30, organ recital, Mrs. Montgomery Lynch; 7:30-9, services, First M. E. church; 9-10, Puget Sound Savings and Loan association orchestra.

KM, Hollywood, Calif. (336.8m-890ke), 12:45-1:45 p. m., program, Howard N. Martin and company, Paul Finstein's concert orchestra; 2-4, City Park Board program from Westlake Park; 6:30-7, Unitarian church service; 8-9, First Presbyterian Church of Hollywood; 9-10:30, program, Beverly Hills Nurseries; Russian string quartet.

KPSN, Pasadena, Calif. (315.6m-950ke), 8:45-9:45 p. m., Maryland artists ensemble.

KTAB, Oakland, Calif. (240m-1250ke), 9:45-10:45 a. m., Bible lecture; 11-12:30, church service; 7:45-8:15 p. m., church service; 9:30-11, after-service concert.

WEAF TO INTRODUCE EDWARD JOHNSON

POPULAR CONCERTS INDEX

Saturday, March 13

Eastern	Central	Mountain	Pacific
7:30 p. m.	6:30 p. m.	5:30 p. m.	4:30 p. m.
WFAA	7	6	5
WAMD, WLS	8	7	6
WBBM, WEAF, WENR, WGBS, WLS, WMAQ, WNYC	9	8	7
10	9	8	7
KFAB, KPRC, WBBM, WEBB, WENR, WGN, WLS, WMBB, WREO	10	9	8
11	10	9	8
KFVE, KFVB, KNX, KTHS, WBBM, WMBB, WOK, WQJ, WRC	11	10	9
12	11	10	9
KNX, KOIL, KPO, KPRC, WBBM, WEBB, WLS, WOA, WOK, WQJ	12	11	10
1 a. m.	12 m.	11	10
KFWB, WDAF, WBBM, WEBB, WENR, WOK, WQJ, WSAI	1	12 m.	11
2	1 a. m.	12 m.	11
KNX, WBBM, WEBB, WENR, WQJ			

Sunday, March 14

Eastern	Central	Mountain	Pacific
9 p. m.	8 p. m.	7 p. m.	6 p. m.
WBBM	9	8	7
10	9	8	7
WBBM, WMBB	10	9	8
11	10	9	8
WMBB	11	10	9
12	11	10	9
KNX, KTHS	12	11	10
1 a. m.	12 m.	11 p. m.	10
KFWB, WBBM	1	12 m.	11
2	1 a. m.	12 m.	11
KFWB			

Monday, March 15

Eastern	Central	Mountain	Pacific
7 p. m.	6 p. m.	5 p. m.	4 p. m.
WBBM, WFAA, WOA, W	7	6	5
WGBS	8	7	6
9	8	7	6
WCAU, WEAF, WGR, WKRC, WOK	9	8	7
10	9	8	7
KFAB, WEBB, WGR, WKRC, WMAQ, WOA, WOK, WSOE	10	9	8
11	10	9	8
KFAB, KFVE, WOK	11	10	9
12	11	10	9
ELX, KNX, KOIL, WAMD, WEBB, WHO, WOK	12	11	10
1 a. m.	12 m.	11	10
KFWB, KLX, WAHG, WDAF, WHT, WKRC, WOK	1	12 m.	11
2	1 a. m.	12 m.	11
KFWB			

Tuesday, March 16

Eastern	Central	Mountain	Pacific
7 p. m.	6 p. m.	5 p. m.	4 p. m.
WMAQ, WOA, W	7	6	5
WBBM, WEAF	8	7	6
9	8	7	6
WBBM, WEAF, WBZ, WSB	9	8	7
10	9	8	7
10 p. m.	9 p. m.	8 p. m.	7 p. m.
WBBM, WEBB, WMBB, WOA, W			

Monday, March 15

Headliners Today

Eastern	Central	Mountain	Pacific
7:45 p. m.	6:45 p. m.	5:45 p. m.	4:45 p. m.
WGY (379.5m-790kc) Severino mandolin quintet, 8:15	8:15	7:15	6:15
WGY (379.5m-790kc) "A Step On The Stairs," mystery play, 9:30	9:30	8:30	7:30
WEMC (285.5m-1050kc) Lighthouse Music Makers, 8:30	7:30	6:30	5:30
WDAF (475.9m-630kc) R. O. T. C. band, 9:30	8:30	7:30	6:30
WGR (319m-940kc) Imhof trio, 9	8	7	6
WBZ (333.1m-900kc) Shriners' band, 9:30	8:30	7:30	6:30
WCAU (277.6m-1080kc) Merry Minstrels, 9:30	8:30	7:30	6:30
WLAZ (379.5m-790kc) St. Patrick's concert, 9:30	8:30	7:30	6:30
WFB (428.3m-700kc) Camp Fire Girls, 9:30	8:30	7:30	6:30
KFAB (310.7m-880kc) Old Time night, 9:30	8:30	7:30	6:30
KPRC (294.9m-1010kc) Edna Adams, 9:30	8:30	7:30	6:30
WCAU (336.9m-890kc) Viking quartet, 10:15	9:15	8:15	7:15
WPG (289.8m-1000kc) Galen Hall trio, 10:30	9:30	8:30	7:30
WTIC (475.9m-630kc) Travelers' symphonic ensemble, 12	11	10	9
KFI (467m-640kc) Misha Gogna orchestra, 12	11	10	9

Monday, silent night for: CNRA, CNRC, CNRE, CNRM, CNRO, CNRR, CNRT, CNRV, CNRW, KFAU, KFDM, KFEG, KFMC, KFMA, KHI, KIDS, KUOA, KYW, WBBM, WBCN, WCAD, WCBD, WCAO, WEBB, WEBJ, WEBW, WENR, WGBS, WGES, WGN, WHAS, WHT, WIBO, WIF, WJAZ, WJLD, WKAQ, WLBB, WLS, WMAQ, WMBB, WMAI, WOC, WOK, WORD, WQJ, WRC, WREO.

Eastern Time Stations

CKNC, Toronto, Can. (356.9m-840kc), 8-10 p. m., Little Symphony orchestra; Arthur VanderVoort, bass; Hazel Hall-VanderVoort, soprano; Charles Shearer, baritone. KDKA, Pittsburgh, Pa. (309.1m-970kc), 12:30 p. m., Trinity church Lenten service; 6:30, dinner concert; 9, Raud light opera. WAHG, Richmond Hill, N. Y. (315.6m-950kc), 12 noon, Lenten services; 12:35 p. m., Grebe matinee trio; 7:45, Walter Isona, novelty pianist; 8, Synchronphase hour; 9:15, William Helfenstein, baritone; 9:30, Sidney Raphael, pianist; 9:45, William Helfenstein, baritone; 10, Trainmen's trio; 10:30, Joe Zimmerman's orchestra; 12, Queens Melody Boys. WBAL, Baltimore, Md. (246m-1220kc), 6:30-7:30 p. m., dinner program; WBAL orchestra; 7:30-8, Frederick D. Weaver, organist; 8-9, musical program, Emma Slagle, soprano soloist; Elmer Burgess, pianist; 9:10-10, musical program; George Kelly, contralto; Clarence Elhn, tenor; Clyde McKay, baritone. WBZ, Springfield, Mass. (333.1m-900kc), 6:30 p. m., Hotel Kimball dance orchestra; 7:30, organ recital, Rene Dagenais; 8, Capitol theater orchestra; 8:30, Walter Francis Vreeland and Irene Cooper, harjo, uke and guitar selections; 9, Aleppo Drum Corps or Shriners' band; 9:30, organ recital; 10:05, government interference tests; 10:45, Movie club, vaudeville attractions. WCAE, Pittsburgh, Pa. (461.3m-650kc), 6:30 p. m., dinner concert, William Ponn hotel; 7:30, Sunshine Girl; 8, studio concert; 9, concert; 10, grand opera; 11, Ralph Harrison's Midnight Sons. WCAP, Washington, D. C. (468.5m-640kc), 7-11 p. m., WEAF. WGX, Detroit, Mich. (516.9m-580kc), 6-7 p. m., dinner program, Goldkette ensemble; 8-9, program.

Eastern	Central	Mountain	Pacific
11 p. m.	10 p. m.	9 p. m.	8 p. m.
KFVE, KFVB, KNX, WBBM, WHT, WMBB, WOK, WQJ	11	10	9
12	11	10	9
KNX, KOIL, KPO, WAMD, WBBM, WEBB, WEBH, WERC, WMC, WOK, WQJ	12	11	10
1 a. m.	12 m.	11	10
KFWB, KNX, WFAA, WHT, WOA, WOK, WQJ	1	12 m.	11
2	1	12 m.	11
KFWB, WQJ			

Wednesday, March 17

Eastern	Central	Mountain	Pacific
8 p. m.	7 p. m.	6 p. m.	5 p. m.
KFNE, WAHG, WEBB, WEBE, WMAQ	8	7	6
9	8	7	6
WBBM, WEBJ, WGCP, WNYC	9	8	7
10	9	8	7
KFAB, KPRC, WBBM, WEBB, WGCP, WHO, WMBB	10	9	8
11	10	9	8
KFAB, KFVE, KGW, KPO, KWSC, KYW, WBBM, WHN, WMBB, WOK, WQJ	11	10	9
12	11	10	9
KFWA, KFVB, KNX, KYW, WAMD, WEBB, WOK, WQJ, WSAI	12	11	10
1 a. m.	12 m.	11	10
KNX, KYW, WBBM, WHT, WOK, WQJ	1	12 m.	11
2	1 a. m.	12 m.	11
KFWB, KNX, WBBM, WOK, WQJ			

Thursday, March 18

Eastern	Central	Mountain	Pacific
8 p. m.	7 p. m.	6 p. m.	5 p. m.
WCAE, WEAF, WJAR, WMC, WOC, WSAI	8	7	6
9	8	7	6
WBBM, WEAF	9	8	7
10	9	8	7
KMA, WBBM, WEBB, WEBE, WHAD, WHN, WMBB, WMC, WNYC, WOA, WSOE	10	9	8
11	10	9	8
KHJ, KMA, KYW, WBBM, WMBB, WOK, WQJ	11	10	9
12	11	10	9
KHJ, KTAB, KOIL, WEBB, WDAF, WEBB, WFAA, WKRC, WOC, WOK, WQJ	12	11	10
1 a. m.	12 m.	11	10
KFWB, KHJ, WHT, WOK, WQJ	1	12 m.	11
2	1 a. m.	12 m.	11
KNX, WQJ			

Friday, March 19

Eastern	Central	Mountain	Pacific
8 p. m.	7 p. m.	6 p. m.	5 p. m.
WGCP, WJR	8	7	6
9	8	7	6
WAMD, WBBM, WGB, WLS	9	8	7
10	9	8	7
KFAB, WBBM, WEBB, WMC, WDAF, WHAD, WMBB, WOA, WSOE	10	9	8
11	10	9	8
KFVE, KFVA, KHJ, KLX, KYW, WMBB, WOK, WQJ	11	10	9
12	11	10	9
KFWB, KHJ, KNX, KOIL, WAMD, WEBB, WMC, WOK, WQJ	12	11	10
1 a. m.	12 m.	11	10
KFWB, KHJ, WDAF, WHT, WOK, WQJ	1	12 m.	11
2	1 a. m.	12 m.	11
KNX, WQJ			

WEAF, New York, N. Y. (491.5m-610kc), 5-6 p. m., Vincent Lopez's orchestra; 6-7, dinner music, Waldorf Astoria hotel; 7:30, Lullaby Lady; 8, popular concert; 9, A. and P. Gypsies, WEBE, WJAR, WOC, WCAP, WCAE, WWJ; 10, WEAF grand opera, "The Bohemian Girl," WOC, WCAP, WJAR, WTAG, WCAE; 11-12, Ben Bernie and Hotel Roosevelt orchestra. WEAR, Cleveland, Ohio (389.4m-770kc), 7 p. m., Allen theater orchestra. WEEI, Boston, Mass. (348.6m-860kc), 6:45 a. m., Tower Health; 12:15, Lenten services, B. F. Keith's theater; 5 p. m., Rainbow Ramblers; 6:13, Joe Rines and his Hunter's Cabin orchestra; 7:30, Black Iron Shiners; 8:15, Central Automobile Tire company, program; 8:45, WEAF; 9, WEAF; 10, Scotty Holmes and his orchestra; Imperial Marlba band. WTIC, Philadelphia, Pa. (394.5m-790kc), 1 p. m., Tea Room ensemble; 3, Lester Drucker, violinist; Hazel Loughlin, pianist; Catharine M. Daley, contralto; 6:30, Bellevue Stratford concert orchestra; 7, Bellevue Stratford dance orchestra. WGBS, New York, N. Y. (315.6m-950kc), 1:35 p. m., Monica Irwin, soprano; 1:50, Manhattan string trio; 3:10, Marguerite Stearns, soprano; 3:30, Marguerite Stearns, soprano; 3:40, League of Women Voters' program; 3:50, Marguerite Stearns, soprano; 6, Uncle Geebee; 6:30, Little Bear Balalaika orchestra. WGPC, New York, N. Y. (252m-1190kc), 3 p. m., program; 4:15, Uncle Robert's pals; 8:30, Strickland's orchestra; 9:30, program; 10, Strickland's orchestra; 10:30, China Royal Restaurant music. WGH, Philadelphia, Pa. (266m-1130kc), 6:30-7:30 p. m., dinner music, Lakewood terrace orchestra; 8:30-10, Sebring Florida program; 11:30-1, midnight ramble. WGHF, Detroit, Mich. (270m-1100kc), 6-7 p. m., dinner concert, Hotel Tullier; 8-10, Little Symphony orchestra; John Wummer, flute; Victor Polant, violinist; Florian Witman, viola; T. Stanley Perry, tenor; Leona E. Mitchell, soprano; 12-1 a. m., Gerald Marks and his orchestra. WGR, Buffalo, N. Y. (319m-940kc), 2:30 p. m., WGR's afternoon program; 6:30, Charleston Shufflers orchestra; 8, vocal program featuring W. Frederick Root; 8:30, Imhof trio's popular program, Wheat's Ice Cream division of the General Ice Cream company; 10, popular program, Buffalo Arts club; 11, Vincent Lopez Hotel Statler dance orchestra, Harold Gieser, director; John F. Gunderman, Jr., at the organ. WGY, Schenectady, N. Y. (379.5m-790kc), 2 p. m., Asia Restaurant; 6:30, Porter E. Potts Hotel Van Curler orchestra; 7:45, Severino Mandolin quintet; Emeline Bates, soprano. WHAR, Atlantic City, N. J. (275m-1090kc), 2 p. m., Seaside hotel trio; 8, Seaside hotel trio; 11, Follies Bergere dance orchestra. WHAZ, Troy, N. Y. (379.5m-790kc), 9 p. m., St. Patrick's concert; 10:30, dance orchestra. WHN, New York, N. Y. (361.2m-830kc), 6 p. m., people's hour; 7, Twin Oaks orchestra; 7:30, Joe Ward's Swane entertainers; 8:05, Roseland dance orchestra; 10:30, Creole Follies; 11, Cotton club orchestra; 11:30, Silver Slipper orchestra; 12, Van and Schenck from the Parody club. WIP, Philadelphia, Pa. (508.2m-590kc), 1 p. m., Gimbel tea room orchestra; 3, artist recital, Philadelphia Conservatory of Music, Anna Speck, soprano; Flora Ripka, pianist; 6:05, Benjamin Franklin concert orchestra; 6, Uncle Wip's bedtime stories; dancing lessons, Miller Conservatory of Dancing. WJR, Pontiac, Mich. (516.9m-580kc), 7 p. m., Jean Goldkette's symphony orchestra; soloists; 11:30, "The Merry Old Chief." WJZ, New York, N. Y. (454.3m-660kc), 7:55 p. m., John B. Kennedy; 8, B. Fisher and company's Astor coffee orchestra; 9, Henry Hadley and his Philharmonic orchestra. WLIT, Philadelphia, Pa. (394.5m-780kc), 12:02 p. m., Stanley theater organ recital; Arcadia cafe concert orchestra; 2, Arcadia cafe concert orchestra; 4:30, Alice Wightman, pianist; 7:30, Dream Daddy's bedtime stories; 8, Short Aggro Waves; 9, Stanley theater hour; 10, Arcadia cafe concert orchestra; 10:30, vaudeville features, Knickerbocker theater; 10:45, El Patio dance orchestra. WLWL, New York, N. Y. (288.3m-1040kc), 9:15 p. m., songs; 10, musicale; 10:15, study club; 10:30, entertainment. WMAK, Buffalo, N. Y. (266m-1130kc), 7:30-8:30 p. m., Murray Whitman and his serenaders; 8:30-9, musical program; 9-10, musical program; 10-11, musicale. WMCA, New York, N. Y. (340.7m-880kc), 6 p. m., Oleott Vail and his Hotel McAlpin string ensemble; 6:30, Ernie Golden and his Hotel McAlpin orchestra; 7:30, Kurtz Karnival Kings; 8, Terminal music hour; 10:15, McAlpin news editor; 10:30, Parody club orchestra; 10:45, Van and Schenck; 11:30, Jack Denny's orchestra; 12, McAlpin entertainers. WNYC, New York, N. Y. (526m-570kc), 6:20 p. m., piano selections; 7:35, piano selections; 8, concert program; 9:20, song recitals; 10, Richmond Versatile orchestra; 10:35, Richmond Versatile orchestra. WOO, Philadelphia, Pa. (508.2m-590kc), 11 a. m., organ recital; 12:02 p. m., Golden crystal tea room orchestra; 4:45, organ recital; 7:30, Carlton concert orchestra; 8, pop concert; 9, WEAF; 10, WEAF; 11, Adelphia hotel dance orchestra. WOR, Newark, N. J. (405.2m-740kc), 2:30-2:45 p. m., Orreste's Queensland orchestra; 6:30-7:15, Jacques Jacobs' Hotel Shelton ensemble; 7:30-7:45, Ziti's Central Park Casino orchestra; 8:30-9:30, Al Reid's hour; 11-12, Hofbrau Haus orchestra. WPG, Atlantic City, N. Y. (299.8m-1000kc), 4:45 p. m., Chalfonte-Haddon hall tea music; 6:45, organ recital.



The mammoth organ recently installed in the concert Music at Baltimore, by the munificent bequest of the late Mrs. Frederick D. Weaver, sits instrument, has been chosen official organist. A we Charlotte Warren Anderson, left. Her soprano voice station. The Atwater Kent program this Sunday will Johnson, right, and Joan Ruth. This program me

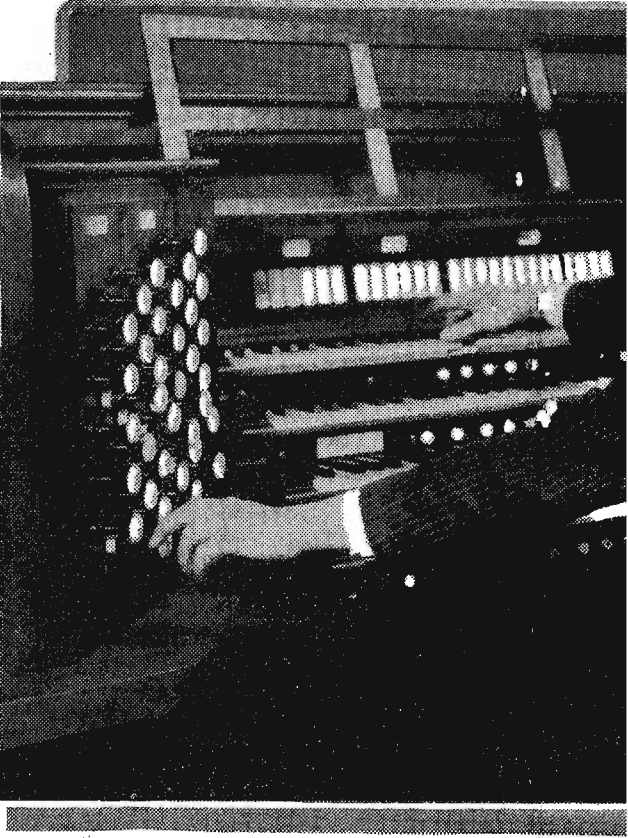

The mammoth organ recently installed in the concert Music at Baltimore, by the munificent bequest of the late Mrs. Frederick D. Weaver, sits instrument, has been chosen official organist. A we Charlotte Warren Anderson, left. Her soprano voice station. The Atwater Kent program this Sunday will Johnson, right, and Joan Ruth. This program me

Gonzales Texas hotel orchestra; 7:30-8:30, R. O. T. C. band; 9:30-11, Ward's "Trail Blazers"; varied entertainment. WBBM, Chicago, Ill. (226m-1330kc), 4-6 p. m., Harry Susnik; Sandy Meek; Irene Beasley, Jack Pennewell and Freddy Palmiter; Court Banks; Joe McManus; Edna Wheeler Ballard, harpist; 6-7, Beulah Mowers, concert pianist; Two Jays; Charlie Garland; Barber Shop Three; Floyd Falch; Pair and Warner, pianists; Dave Bandler, violinist. WCAL, Northfield, Minn. (336.9m-890kc), 8:30 p. m., Viking quartet; WCAL orchestra; Charles Johnson, reader. WCCO, Minneapolis-St. Paul, Minn. (416.4m-720kc), 12 noon, noon concert, Donaldson's orchestra; 2:30, afternoon concert; 4, Reader's club; 6:30, dinner concert, Gordon Cooke ensemble; 8, University of Minnesota program; 9, classical program. WDAF, Kansas City, Mo. (365.6m-820kc), 11:45-1 a. m., Ted Weems' Victor Recording orchestra; Ben Bernie's orchestra; Ted Mey, organist. WEMC, Berrien Springs, Mich. (285.5m-1050kc), 8:15 p. m., Radio Lighthouse Music Makers; varied selections. WFAA, Dallas, Texas (475.9m-630kc), 12:30-1 p. m., Edmund F. Botcher, tenor; Viola Cassidy, pianist; 4:30-5, Cyrus Barcus, cornetist; 6:30-7:30, Honey Boys orchestra; 8:30-9:30, agricultural program. WGES, Oak Park, Ill. (250m-1200kc), Coyne serenaders. WGN, Chicago, Ill. (302.8m-990kc), 12:40-2:30 p. m., concert, Drake concert ensemble; Blackstone string quintet; 2:30-3, Lyon and Healy artists; 3:30-4:15, tea time music, Marshall Field's tea room orchestra; 4:30-5, organ recital, Edward Benedict. WGST, Atlanta, Ga. (270m-1110kc), 9-10 p. m., program, Pi Kappa Alpha fraternity. WHAD, Milwaukee, Wis. (275m-1090kc), 6:15-7 p. m., Bill Benning's Milwaukee Athletic club orchestra; 8:30-10, Wisconsin theater revue; dance music, talent. WHAS, Louisville, Ky. (399.8m-750kc), 1-2 p. m., concert, Royal Peacock orchestra; 3:30-4, special music; 4-5, concert, Irene Rigby, soprano solos, accompanied by Thelma Day. WHB, Kansas City, Mo. (365.6m-820kc), 2-3 p. m., Sweeney instrumental trio; 7-8, popular musical program, Sweeney orchestra; Glenn Durrell, pianist; Palmer Lowry, saxophonist; Kam Wallace, saxophonist; Glenn Francis, trumpet soloist; Jack Gallett, trombonist; Don Van Horn, sousaphonist; O. M. Smith, banjoist. WHO, Des Moines, Iowa (526m-570kc), 7:30-9 p. m., Prof. Paul Stove, pianist and composer; Prof. Joseph Gifford, reader; Mrs. Robert Evans, soprano; Mrs. Stewart Wimer, pianist; 11-12, dance programs. WHT, Chicago, Ill. (399.8m-750kc), 12 p. m., Al Carney complimentary organ recital; 6, Pat Barnes and Al Carney. WJLD, Meeseheart, Ill. (370.2m-810kc), 12-1 p. m., Palmer House symphony players; Palmer House trio; 2-3, Howard L. Peterson, organist; 4-5, children; 5:30, dinner hour; 6:40, Billy Van. WKAF, Milwaukee, Wis. (261m-1150kc), 10-11 p. m., Alvin Morris, pianist; Olga Christianson, mezzo-soprano; Anne Bauman, contralto. WKRC, Cincinnati, Ohio (325.9m-920kc), 6 p. m., Alvin Roehr and his Hotel Alms orchestra; 8, popular song hour; 9, American Legion; 12, frolic; 12:30 a. m., Wesley Helvey's Troubadours. WLS, Chicago, Ill. (344.6m-870kc), 12 m., WLS trio, 6, WLS trio; Ralph Emerson, organist. WLW, Cincinnati, Ohio (422.3m-710kc), 7 p. m., dinner concert, Hotel Gibson orchestra; 7:30, theatrical feature; 8, concert, the Cincinnati Times-Star orchestra, William Kopp, director; Howard Hafford, tenor. WMAQ, Chicago, Ill. (447.5m-670kc), 12:20 p. m., Junior Association of Commerce; 2, program for shut-ins; 4:35, pupils, Glenn Dillard Gunn School of Music; 5, games for the home, Glenn D. Adams; 6, Chicago theater organ recital; 6:30, Hotel La Salle orchestra; 6:40, Family Altar league. WMC, Memphis, Tenn. (499.7m-600kc), 8:45 p. m., Cortese ensemble.

DANCING

Central Time
Saturday, March 13
8:30, Wra, Wnye, W
9, Webb, Weel, Wm
Wny, Wro, 9:10, K
Wip, 9:30, Kths, W
Wor, Wrg, 10, K
Kfwa, Koa, Kpo, W
Wgn, Wjr, Wkr, W
Wny, Wwr, Wqj, W
Wtam, 10:05, W
10:30, Wad, 10
Wls, 11, Kfpe, K
Kfwb, Kpo, Web, W
Wbu, Who, Woc, 11
Kfoa, 11:45, Wdaf,
Kfva, Kgo, Kgw, K
Wgbu, Wjld.
Monday, March 15:
Wgcp, 9, Weel, W
Wjar, Wor, 9:15, W
10, Kths, Wgbo, W
Wgr, Wny, Wog, 10
Wor, 10:30, Kfoa, W
Whg, 11, Kgw, K
Wfo, Wrcp, Wgr, W
Wht, 11:45, Wdaf,
Kno, 11:45, Wdaf,
Knx, Kpo.
Tuesday, March 16:
9, Webb, Wgbu, Wm
9:30, Wcau, Wgs, W
Wip, 9:35, Wnye,
Kfve, Wbbm, W
Webb, Wgbu, Wgn, W
Wma, Wny, Wrg, 10
Kths, 10:30, Kths, W
10:45, Wsb, 11, K
Koll, Wgbu, Wnn, 11
Kfoa

DHINSON AND JOAN RUTH OVER CHAIN



stalled in the concert hall of the Peabody Conservatory of recent request of the late James Leakin may now be enjoyed... Her soprano voice has graced many programs at this... This program may be heard over the WBAF chain.

gram, L. W. Stockwell company; 9-10, KNX feature program; 10-11, Goodrich Silvertown Cord dance orchestra; 11-12, Ray West's Coconut Grove dance orchestra from Ambassador hotel. KOAC, Corvallis, Ore. (280.2m-1070kc), 6:50 p. m., musical selections. KOWW, Walla Walla, Wash. (256m-1170kc), 8-10 p. m., program, Bob Fletcher and family of Cowboy and Cowgirl entertainers; 10-12, dance music. KTAB, Oakland, Calif. (240m-1250kc), 9-9:30 a. m., prayer service; 12-1, luncheon concert; 8-10, program. KWSC, Pullman, Wash. (348.6m-860kc), 7:30 p. m., Louise Kelsey, piano soloist; special numbers, Marimba trio; Mrs. Margarita Beneke Benner, vocal soloist.

Tuesday, March 16

Headliners Today			
Eastern	Central	Mountain	Pacific
7:30 p. m.	6:30 p. m.	5:30 p. m.	4:30 p. m.
WRC (468.5m-640kc)	U. S. Marine band.		
8	7	6	5
WGHP (270m-1110kc)	Funsters.		
8:20	7:20	6:20	5:20
WIP (508.2m-590kc)	"Vision," silent drama.		

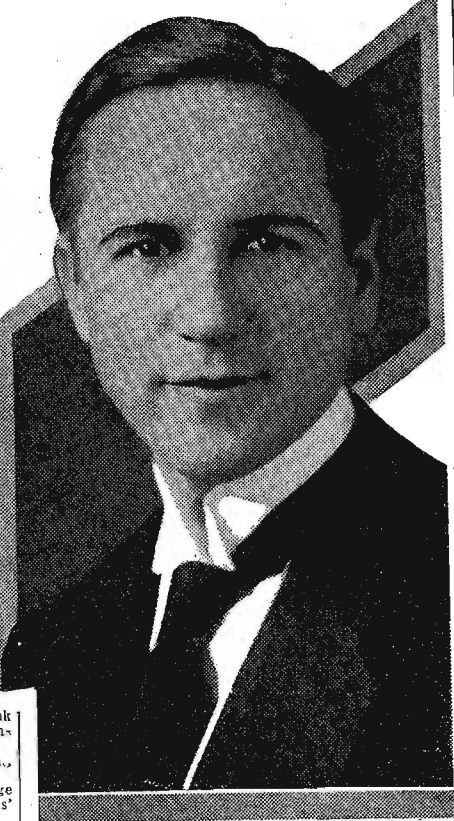

Eastern	Central	Mountain	Pacific
8:30 p. m.	7:30 p. m.	6:30 p. m.	5:30 p. m.
WHAS (309.8m-750kc)	Zueller's Melodists.		
WFO (526m-570kc)	Herring Motor band.		
WHB (365.8m-820kc)	Violin choir.		
11	10	9	8
KGO (361.2m-830kc)	Mishel Piastro.		
KPO (428.3m-700kc)	Aeolian trio.		
11:05	10:05	9:05	8:05
WCCO (416.4m-720kc)	"A Step On the Stairs," drama.		

Tuesday, silent night for: CFCA, CHIC, CKNC, CKY, CNRC, CNRE, CNRM, CNRO, CNRW, CNRT, KFKX, KFKU, KUOA, KFUD, KFWA, KYX, KOA, KOAC, KOB, KOWW, KUOM, KWSC, WABQ, WAHG, WAMD, WBBR, WCAD, WCAL, WCAP, WEMC, WGGP, WGST, WHAD, WHAZ, WJAD, WJAZ, WKAF, WKAG, WLWL, WOI, WOS, WRVA, WSMB, WSUI, WTAM, WTIC.

Eastern Time Stations
 CNRA, Moncton, Can. (291.1m-1030kc), 7 p. m., Juvenile program; 8, CNRA orchestra, mixed quartet.
 KDKA, Pittsburgh, Pa. (309.1m-970kc), 12:20 p. m., Trinity church lenten services; 8:30, dinner concert; 8:30, sacred songs; 9, musical lenten program; 11:35, concert, Grand theater.
 WAHG, Richmond Hill, N. Y. (315.6m-850kc), 12 noon, midday lenten services; 12:35 p. m., studio program.
 WBAL, Baltimore, Md. (246m-1220kc), 6:30-7:30 p. m., dinner program; WBAL dinner orchestra; 7:30-8, WBAL quartet; 8-9, musical program; Abraham Robofsky, violinist; George Bolek, pianist; James Wilkinson, baritone; 9-10, WBAL string trio; Philip Jeffreys, pianist.
 WBZ, Springfield, Mass. (333.1m-900kc), 6:30 p. m., Hotel Lenox ensemble; 8, professional hockey game, Boston Bruins vs. Montreal.
 WCAE, Pittsburgh, Pa. (461.3m-630kc), 4:30 p. m., Sunshine Girl; 6:30, dinner concert, William Penn hotel; 8, WEAF; 8:30, WEAF; 9, WEAF; 10, moment's music; 11, Kenyon theater.
 WCAU, Philadelphia, Pa. (277.6m-1080kc), 7:30, Snell-eburg instrumental trio; 8:10, The Three Brothers; 8:25, theater digest, Abe Lischutz; 8:35, playlet; 9, Robert Frazer, blind Gospel singer, Elizabeth Holtz, pianist; 9:30, The Sea Gulls; 10, Sam Gold, the murmuring baritone; 10:30, Cathay Tea Gardens dance orchestra.
 WCX, Detroit, Mich. (516.9m-580kc), 6-7 p. m., dinner program, Goldkette ensemble; 10-2 a. m., Red Apple club.
 WEAF, New York, N. Y. (491.5m-610kc), 4 p. m., "Conserving Nature," Katherine Dolbar; 4:10, Osborne Sisters, vocal duets; 5, Vincent Lopez and tea room orchestra; 6, dinner music, Hotel Waldorf-Astoria; 7, Vivian Sherwood, contralto; 7:30, American composers program; 8, Blue Ribbon male quartet, WEEL, WFLI, KSD, WCAE, WJW, WGR, WCCO, WOC; 8:30, Gold Dust Twins, WEEL, WFLI, WCAE, WGR, WJW, WOC, WJAR, WCCO, WLWB, WEAR, KSD; 9, Eveready hour, WEEL, WFLI, WCAE, WGR, WJW, WOC, KSD, WJAR, WCCO, WTAG, WGN, WEAR, WSAI; 10, Radio auction bridge game, WEEL, WFLI, WGR, WCCO, WSAI, WOC, WJW; 10:30, Vincent Lopez and his orchestra, WEEL, WFLI, WJW, WGR, KSD, WCAE, WEAR, WTAG; 11-12, Ross Gorman and his orchestra.
 WEAO, Columbus, Ohio (293.9m-1020kc), 7 p. m., chimes, Allen McManigal; 7:45, music.

FARMERS' PROGRAMS INDEX

Farmer Dinner Concerts			
Daily Except Sunday			
CENTRAL TIME			
KFNF, 12:15-1:35 p. m.			
KMA, 11:30-12:30			
KSO, 12:30-1:30 p. m.			
WLS, 12 noon.			
Saturday, March 13			
Eastern	Central	Mountain	Pacific
12 noon	11 a. m.	10 a. m.	9 a. m.
KPRC (296.9m-1010kc)	Farmers' educational and musical program.		
1:45	12:45 p. m.	11:45	10:45
WOI (270m-1110kc)	Soils, questions and answers.		
8	7	6 p. m.	5 p. m.
KDKA (309.1m-970kc)	Farm program.		
9:05	8:05	7:05	6:05
KFAB (340.7m-880kc)	"Cost of Producing Corn in Nebraska," A. Medlar.		
9:30	8:30	7:30	6:30
KFAU (280.2m-1070kc)	Agricultural talk, question box.		
Sunday, March 14			
Eastern	Central	Mountain	Pacific
3:30 p. m.	2:30 p. m.	1:30 p. m.	12:30 p. m.
WFAA (475.9m-630kc)	Sunday hour for farmers.		
Monday, March 15			
Eastern	Central	Mountain	Pacific
12 noon	11 a. m.	10 a. m.	9 a. m.
WRC (468.5m-640kc)	Fifty Farm flashes.		
1:15 p. m.	12:15 p. m.	11:15	10:15
WOC (483.6m-620kc)	"Saving a Maximum of New Born Pigs," John Evvard.		
WBAO (293.9m-1020kc)	Timely Economic Information for the Farmer, C. J. West.		
1:35	12:35	11:35	10:35
KSAC (340.7m-880kc)	"Fruit Varieties to Plant in Kansas," L. Williams. "Pastures," R. Kiser.		
1:45	12:45	11:45	10:45
WOI (270m-1110kc)	"Suggestions for Conditioning Work Animals," Dr. H. Bemis.		
WMAQ (447.5m-670kc)	Radio farm school.		
5	4 p. m.		
WGY (379.5m-790kc)	Agricultural program.		
7:45	6:45	5:45	4:45
WSOE (246m-1220kc)	Hog Raising.		
8:15	7:15	6:15	5:15
KSAC (340.7m-880kc)	"Feeding the Ewe Flock," H. Reed. "Pulling Through the First Three Weeks," H. Steup.		
8:30	7:30	6:30	5:30
KUOA (299.8m-1000kc)	"Farm Philosophy," Cy Adams. "Sheep for Arkansas," M. Alexander. "Dairying in the Delta," E. Dargan. "Slilage," W. Woodley. "Poultry Development in Grant County," W. Vinzant.		
KOB (348.6m-860kc)	"Care of the Sow at Parturition Time," W. Dickson. "Incubation," L. Berry.		
8:45	7:45	6:45	5:45
WCCO (416.4m-720kc)	Farm lecture.		
WOI (270m-1110kc)	"Pruning Grape Vines," B. Pickett.		
WTIC (475.9m-630kc)	"Growing Healthy Chickens," Ron Southwick. "Anthony Spuler." "Fertilizers and Their Uses," Leonard Hegnauer.		
9:05	8:05	7:05	6:05
KFAB (340.7m-880kc)	"Seed Corn," P. Stewart. "The Spray Program," E. Coe.		
10	9	8	7
KOAC (280.2m-1070kc)	Agricultural question box. "Brooder Management," A. Lunn.		
10:30	9:30	8:30	7:30
KOAC (280.2m-1070kc)	"Keeping the Work Horse's Shoulders in Good Condition," B. Rosenwald.		
KWSC (318.6m-860kc)	"Influence of Rearing on Egg Production," W. Buchanan. "Contribution of Science to the Dairy Industry," "The Relation of Bacteriology to Clean Milk," E. Ellington.		
10:45	9:45	8:45	7:45
KOAC (280.2m-1070kc)	"Oregon's Agricultural Situation," R. S. Bessie.		
11:05	10:05	9:05	8:05
KGO (361.2m-830kc)	Farm program.		

Markets and Weather

Daily Except Sunday			
Eastern	Central	Mountain	Pacific
9:30 a. m.	8:30 a. m.	7:30 a. m.	6:30 a. m.
WOAW (526m-570kc)	Markets.		
9:45	8:45	7:45	6:45
KDKA (309.1m-970kc)	Livestock, grain.		
10	9	8	7
WLS (344.6m-870kc)	Livestock, markets, fruit.		
WOS (449.9m-680kc)	Hogs.		
10:30	9:30	8:30	7:30
WFAA (475.9m-630kc)	Markets.		
10:45	9:45	8:45	7:45
WCCO (416.4m-720kc)	Markets.		
WMC (499.7m-600kc)	Weather, markets.		
11	10	9	8
WOS (449.9m-680kc)	Weather, hogs.		
11:15	10:15	9:15	8:15
WTAG (268m-1120kc)	Markets, weather.		
11:30	10:30	9:30	8:30
KFKX (288.3m-1040kc)	Weather, Chicago Board of Trade, livestock, Chicago and New York butter and egg market, local produce.		
WCCO (416.4m-720kc)	Markets.		
WEAR (389.4m-770kc)	Markets, weather.		
11:45	10:45	9:45	8:45
WAAW (384.4m-780kc)	Livestock, butter, eggs.		
12	11	10	9
KDKA (309.1m-970kc)	Weather, livestock, grain.		
WBAP (475.9m-630kc)	Weather, cattle, grain.		
WLS (344.6m-870kc)	Poultry, dairy, hogs, sheep.		
WOS (449.9m-680kc)	Livestock, poultry, eggs.		
12:30 p. m.	11:30	10:30	9:30
KFKX (288.3m-1040kc)	Livestock, fruit, vegetables, dairy.		
WEAR (389.4m-770kc)	Markets, weather.		
WFAA (475.9m-630kc)	Markets.		
1	12 n.	11	10
WBAP (475.9m-630kc)	Markets.		
WOS (449.9m-680kc)	Livestock, weather.		
1:30	12:30 p. m.	11:30	10:30
KTHS (374.8m-800kc)	Markets, weather.		
1:45	12:45	11:45	10:45
KOA (322.4m-930kc)	Weather, roads, livestock, poultry.		
2	1	12 n.	11
WOC (483.6m-620kc)	Weather, grain, livestock, dairy.		
2:15	1:15	12:15 p. m.	11:15
WAAW (384.4m-780kc)	Grain markets.		
WFAA (475.9m-630kc)	Markets.		
3	2	1	12 n.
WLS (344.6m-870kc)	Livestock, grain, dairy, fruit, vegetables.		
3:30	2:30	1:30	12:30 p. m.
WFAA (475.9m-630kc)	Markets.		
WMC (499.7m-600kc)	Markets, weather.		
3:50	2:50	1:50	12:50
WWJ (352.7m-570kc)	Weather, markets.		
4	3	2	1
WCCO (416.4m-720kc)	Markets.		
WFAA (475.9m-630kc)	Markets.		
5:50	4:50	3:50	2:50
WHAS (399.8m-750kc)	Markets.		
6:30	5:30	4:30	3:30
KSAC (340.7m-880kc)	Markets.		
6:45	5:45	4:45	3:45
WIP (508.2m-590kc)	Livestock, markets.		
KSAC (340.7m-880kc)	Market review.		
KFVA (261m-1150kc)	Market reports.		
7	6	5	4
KOA (322.4m-930kc)	Sheep, markets, livestock, poultry.		
11	10	9	8
WCCO (416.4m-720kc)	Weather, grain.		

DANCING

Central Time
 Saturday, March 13:
 8, Wjr, Wnyc, Wps;
 8:30, Wfag, 8:35, Wxy;
 9, Wob, Weel, Wmbb,
 Wnyc, Wro; 9:10, Kths,
 Wip; 9:30, Kths, Wgbs,
 Wpr; 10, Kive,
 Kiva, Koa, Kpo, Weaf,
 Wgn, Wjr, Wkrc, Wmca,
 Wnyc, Wro; 10:05, Wcco;
 10:30, Wamd; 10:45,
 Wls; 11, Kfvg, Kfwa,
 Kfwb, Kpo, Webb, Wfaa,
 Wgbu, Wjo, Woc; 11:30,
 Kfoa; 11:45, Wdaf; 12,
 Kwa, Kgo, Kgw, Knx,
 Wgub, Wjld.

Monday, March 15:
 8, Wgcp, 9, Weel, Wgub,
 Wjar, Wjr; 9:15, Wahg;
 10, Kths, Wgub, Wgcp,
 Wgr, Wnyc, Wps; 10:15,
 Wpr; 10:30, Kfoa, Wgen,
 Wnp; El, Kgw, Koll,
 Wgub, Wgcp, Wgr, Wnyc,
 Wjld; 11:45, Wdaf; 12,
 Knx, Kpo.

Tuesday, March 16:
 9, Webb, Wgub, Wmbb;
 9:30, Wcau, Wgbs, Wgy,
 Wip; 9:35, Wnyc; 10,
 Kfve, Wbbm, Weaf,
 Webb, Wgub, Wgn, Wnyc,
 Wnyc, Wnyc; 10:15,
 Kths; 10:30, Kths, Wnyc,
 Koll, Wgub, Wjld, Kgw,
 Kfoa; 11:45, Wdaf; 12,
 Kgw, Khj, Knx, Kpo,
 Wdaf; 1, Wjld.

Wednesday, March 17:
 9, Webb, Wgub, Wnyc,
 Wgcp, Wnyc, Wnyc,
 Wmbb, Wmca, Wnyc;
 9:15, Wahg; 9:30, Wbap,
 Wno, Wro; 10, Kfve,
 Wbap, Weaf, Wgub, Wgcp,
 Wjld; 10:05, Wcco;
 10:30, Wbap, Wnyc; 11,
 Koll, Kpo, Webb, Wgub,
 Wgub, Wgub, Wnyc, Woc;
 11:45, Wdaf; 12, Kfwa, Knx,
 Kpo, Wjld.

Thursday, March 18:
 8, Wjr; 9, Webb, Weel,
 Weel, Wnyc, Wnyc,
 Wmbb, Wsai, Wtag; 9:05,
 Wbz, Wip; 9:30, Wgbs,
 Wgy, Wnyc; 9:35, Wnyc;
 10, Kths, Wbbm, Weaf,
 Wgub, Wnyc, Wmca, Wps,
 Wjld; 10:30, Kths, Wnyc,
 Wgub, Wgub, Wnyc, Woc;
 11:45, Wdaf; 12, Kgo,
 Khj, Knx, Kpo, Wjld.

Friday, March 19:
 9, Wex, Webb,
 Weel, Wgub, Wgcp,
 Wmbb; 9:15, Wahg, 9:30,
 Wcau, Wnyc; 10, Kfve,
 Kpo, Kths, Wgub, Wgcp,
 Wnyc, Wnyc, Wjld; 10:05,
 Wcco; 10:30, Wgcp, Wnyc;
 11, Kfwb, Knx, Kpo.

Mountain Time Stations

CFAC, Calgary, Canada (435.8m-688kc), 9 p. m., ladies concert trio.
 KFVA, Ogden, Utah (261m-150kc), 4-5 p. m., organ recital, Paramount theater; 5-6, Radio dealers program.
 KFXF, Colorado Springs, Colo. (250m-1200kc), 8:30 p. m., Mrs. Henry L. Newman, Jr., contralto; Temple quartet.
 KOA, Denver, Colo. (322.4m-930kc), 12:15 p. m., Rialto theater organ recital, Marjorie Nash; 6:30, dinner concert, Brown Palace string orchestra; 8:30, miscellaneous music; 9:30, miscellaneous music; 9:40, Radio mystery serial, "A Step on the Stairs."
 KUOM, Missoula, Montana (244m-1230kc), 8 p. m., music.

Pacific Time Stations

KFI, Los Angeles, Calif. (467m-640kc), 5:30-6 p. m., Owen Fallon's Californians; 6, nightly doings; 6:15, travel guide; 6:30, vest pocket program; 6:45, Radio-logical period; 7-8, old-time New England barn dance; 8-9, Packard Eight dance orchestra; 9-10, program, Walter M. Murphy Motors company, Misha Gagna orchestra; 10-11, program, Melikjohn Brothers.
 KFOA, Seattle, Wash. (454.3m-660kc), 12:30-1:30 p. m., luncheon program; 7-8:15, Sherman Clay and company studio program; 8:30-10, Times studio program.
 KFON, Long Beach, Calif. (232.4m-1280kc), 6-6:30 p. m., Brayton's theater organ; 6:30-7, amusement information; 7-8, investor's hour, with music; 8-9, Press-Telegram studio; 9-11, KFON studio program.
 KFWE, Hollywood, Calif. (252m-1190kc), 6-7 p. m., dinner music, Fitzgerald Music company; 7:30-8, program, Dr. Ralph Mitchell and associated dentists; "Friendly Dentists" orchestra; 8-9, Bill Hatch's Oakmont Country club orchestra; 9-10, program, Star Motor Car company, Million-Dollar Four orchestra; Tom Breneman, baritone; Sol Hooft's Hawaiians; 10-11, Warner Brothers' frolic.
 KGO, Oakland, Calif. (361.2m-830kc), 11:30-1 p. m., luncheon concert; 6-6:35, Brokaw and orchestra; 8:50, slumber song; 9:30, Arion trio.
 KGW, Portland, Ore. (491.5m-610kc), 12:30-1:30 p. m., the First National bank and the Security Savings and Trust company; 6-7, dinner concert, Olds, Wortman and King company; 8-9, concert, vocal and instrumental, Henry Jennings and Sons.
 KIR, Seattle, Wash. (389.4m-780kc), 7-8 p. m., Sears Roebuck and company studio program, Mendelssohn trio; 8:30-10, Post Intelligence studio program.
 KLX, Oakland, Calif. (508.2m-590kc), 6:30-7 p. m., Athens Athletic club orchestra; 8-9, program; 9-10:30, Late Merritt Ducks.
 KMTR, Hollywood, Calif. (238m-1260kc), 7:15 p. m., Y. M. C. A. musical program; 8-10, KMTR concert orchestra, Loren Powell, director; 10-11, Starr Piano company studio.
 KNX, Hollywood, Calif. (336.9m-890kc), 5:30 p. m., Leighton's cafeteria orchestra; 6:30-7, Atwater Kent orchestra; 7-7:30, Mutual Motors mirth contest; 7:30-8, program, Overall's Furniture company; 8-9, program, L. W. Stockwell company; 9-10, KNX feature program; 10-11, Goodrich Silvertown Cord dance orchestra; 11-12, Ray West's Coconut Grove dance orchestra from Ambassador hotel.

CAMP FIRE GIRLS REPORT TO WSB

Tuesday, March 16

WEAR, Cleveland, Ohio (389.4m-770kc), 7 p. m., State theater vaudeville and music; 8:30, WEAF; 9, WEAF; 10, ensemble; 10:30, Vincent Lopez orchestra; 11, Wornack's Singing Syncopters.

WEBI, New York, N. Y. (272.6m-1100kc), 7-7:30 p. m., Kenwood Klub orchestra; 7:45, A. B. Jacobson, baritone; 8:15, Gordon Beresford, entertainer; 8:30-9, New York Collegians orchestra.

WEET, Boston, Mass. (348.6m-860kc), 12:15 a. m., Lenten services, B. F. Keith's theater; 3:05 p. m., Eugene's singing orchestra; 4, Crimson Ramblers; 5, Joe Herlihy's Collegians, Music Box; 6:05, George Joy and Neil Cantor, popular songs; 7:30, R. V. Pettinello company, program; 8-10:30, WEAF.

WFL, Philadelphia, Pa. (394.5m-760kc), 1 p. m., Tea Room ensemble; 3, George C. Young, pianist, John Grady, violinist; 6:30, Bellevue Stratford concert orchestra; 7, Bellevue Stratford dance orchestra; 7:15, banking talk; 8, WEAF; 8:30, WEAF; 10, WEAF; 10:30, WEAF.

WGBS, New York, N. Y. (315.6m-850kc), 10:10 a. m., Frances Delaney, soprano; 10:30, Frances Delaney, soprano; 10:50, Frances Delaney, soprano; 6 p. m., Uncle Goebe; 7, Arrowhead Inn orchestra; 8, Y. M. H. A. vocational forum; 8:30, "Threshold players" production; 9, Crystal Palace orchestra; 10:30, Arrowhead Inn orchestra.

WGP, New York, N. Y. (252m-1190kc), 3 p. m., Ona Welsh, pianist; 3:15, Max Felt, violinist; 3:30, Isabelle Henderson, soprano; 3:45, 20th century entertainer; 4:10, Leslie McLeod, tenor; 4:30, Katherine Adolph, soprano; ukulele, Bob McDonald.

WGHB, Clearwater, Fla. (266m-1130kc), 6:30-7:30 p. m., dinner music; 7:30-7:45, Giles W. Quarles, "The Monkey Man"; 8:30-9:30, Homer Moore singers of Tampa; 11:45-1, midnight ramble, dance music.

WGHP, Detroit, Mich. (270m-1110kc), 6-7 p. m., dinner concert; 8-10, WGHP Funsters, with Skylark dance band; 12-1 a. m., Gerald Marks and his orchestra.

WGR, Buffalo, N. Y. (319m-940kc), 2:30 p. m., WGR's afternoon program; 6:30, Vincent Lopez Hotel Statler dance orchestra, Harold Gieser, director; 8, jointly with WEAF, Gold Dust Twins, Auction Bridge, Eveready hour, Vincent Lopez and his Casa Lopez orchestra.

WGY, Schenectady, N. Y. (379.5m-790kc), 2 p. m., music; organ recital, Stephen E. Boisclair; 6:30, Porter E. Potts Hotel Van Curler orchestra; 7:45, WRC; 8:30, WJZ; 9:30, harp selections.

WHAR, Atlantic City, N. J. (275m-1090kc), 2 p. m., Seaside hotel trio; 8, Seaside hotel trio; 9, St. Patrick's Day program.

WHN, New York, N. Y. (361.2m-830kc), 12:30 p. m., Lexington organ recital; 2, overture and vaudeville; Loew's State, N. Y.; 3:15, Lexington theater orchestra; 6, Treasureland Neighbors; 6:30, Everglades orchestra; 7, Iceland orchestra; 7:30, Will Oakland's chateau; 8, people's hour; 9, Loew's New York Roof orchestra; 11, Avalon club orchestra; 11:30, Al Raymo's entertainers; 12, Harry Richman and his entertainers.

WIP, Philadelphia, Pa. (508.2m-590kc), 1 p. m., organ recital; 3, Carolyn Schimminger, soprano; Elizabeth Gear, pianist; Babette Gerhab, contralto; Flora Ripka, accompanist; 6:05, Monte Cross, "old-timer"; 6:15, Nelson Maples and his S. S. Leviathan orchestra; 7, Uncle Wip's bedtime stories; choir of St. Edmund's Home; 8:20, "Vision," Lenten drama, students of Villa Nova college; 10:30, Pagoda cafe orchestra.

WJR, Pontiac, Mich. (516.9m-580kc), 7 p. m., Glover-Watson square dance orchestra; 8, Jean Goldkette's orchestra.

WJZ, New York, N. Y. (454.3m-660kc), 7 p. m., "Boston Terriers"; 7:30, U. S. Marine band.

WLIT, Philadelphia, Pa. (394.5m-760kc), 11 a. m., organ recital; 12:02 p. m., daily almanac, Stanley theater organ recital; Arcadia cafe concert orchestra; 2, Arcadia cafe concert orchestra; 2:30, Household helps and hints; 7:30, Dream Daddy's bedtime stories; 7:50, dramatic review, Allyn C. Sauer.

WMAK, Buffalo, N. Y. (266m-1130kc), 6:15-7:15 p. m., dinner music.

WMCA, New York, N. Y. (340.7m-880kc), 12 noon., Jack Cohen, pianist; 6 p. m., Olcott Vall and his Hotel McAlpin string ensemble; 6:30, Parody club orchestra; 7, Jack Denny's orchestra; 7:30, Twin Oaks orchestra; 7:45, Arthur West's Strons; 8, Landay Revellers; 9, Peace institute program; 9:15, Palmer Pen lesson; 9:30, Harry Business club; 10:15, McAlpin news editor; 10:30, Tango Garden orchestra; 11, Ernie Golden and his Hotel McAlpin orchestra; 12, McAlpin entertainers.

WNYS, New York, N. Y. (526m-570kc), 7:10 p. m., The Canadians; 7:35, The Canamans; 8, male quartet; 8:15, Straub and Lambrecht, Hawaiian guitarists; 8:30, male quartet; 8:45, Straub and Lambrecht, Hawaiian guitarists.

WOO, Philadelphia, Pa. (508.2m-590kc), 11 a. m., organ recital; 12:02 p. m., Golden's crystal tea room orchestra; 4:45, organ recital; 7:30, Sesqui Centennial program.

WOR, Newark, N. J. (405.2m-740kc), 6:40 p. m., studio program; 7, Copenhagen quartet.

WPG, Atlantic City, N. J. (299.8m-1000kc), 6:45 p. m., Arthur Scott Brook, organist; 7, Hotel Morton dinner music; 8:15, Plaza hotel artists, Cecile Steiner, violinist; Margaret Irwin, pianist; Horace M. Burke, baritone; 9, Chalfonte-Haddon ball dual trio; 10, concert, Allegro club; 10:30, Karl Bonawitz, popular and classical pianist; 11, Silver Slipper supper club orchestra.

WRC, Washington, D. C. (468.5m-640kc), 12:30 p. m., Lenten services; 1, Hotel Washington orchestra; 7:30, concert, United States Marine band orchestra; 10:30, W. Spencer Tupman and his Hotel Mayflower orchestra; 11:30, organ recital, Otto F. Beck.

WTAG, Worcester, Mass. (268m-1120kc), 10:30 a. m., musical selections; 12:05-2 p. m., noonday luncheon music; 8-9, concert program; 9-10, WEAF; 10:30-11, Vincent Lopez and his orchestra.

WWT, Detroit, Mich. (352.7m-850kc), 12:05 p. m., Jules Klein's Hotel Statler orchestra; 8, Detroit News orchestra; 6, dinner concert; 8, WEAF.

KUOA, Fayetteville, Ark. (299.8m-1000kc), 8 p. m., musical program, pupils of Henry Tovey.

KWVG, Brownsville, Tex. (278m-1090kc), 6 p. m., "Irish Melodies," Ted Toothman.

KYW, Chicago, Ill. (536m-560kc), 12:05-1 p. m., noon-day concert, Commonwealth Edison company; 1-2, luncheon concert, Congress hotel; 4, afternoon frolic; 6-7, dinner music; 8-9, musical program; Eulalie Kober Stade, pianist; Henrietta Nolan, violinist; Barney Weber, tenor; "Banjo Bill" Haid; melody quartet; 9, music hour; 10-12, evening at home; 1-2 a. m., Indiana club.

WBAP, Ft. Worth, Tex. (475.9m-630kc), 12:05-12:30 p. m., Ward's "Trail Blazers"; 6-8:30, dinner music; 7:30-8:30, concert; 9:30-11, Carolyn Bell McFarland, presenting violinist, vocalist and pianist.

WHAS, Louisville, Ky. (399.8m-750kc), 1-2 p. m., concert, Benson trio; 3:30-4, special music; 4-4, Campus Cracks; Wallace Wilson, saxophonist; Walter Haynes, baritone; Charles O'Connell, pianist; concert; 7:30-9, concert, Carl Zoeller's Melodists.

WHB, Kansas City, Mo. (365.6m-820kc), 7-7:30 p. m., organ music, Morrill Moore; 8, William Topliker's violin choir, twenty violinists; Harry Lane and his uke.

WHO, Des Moines, Iowa (526m-570kc), 7:30-8 p. m., Raleigh quintet; 8-9, Herring Motor band; 11-12 noon, Bankers Life Corn Sugar orchestra.

WHT, Chicago, Ill. (399.8m-750kc), 12 m., Al Carney's complimentary organ recital; 6, dinner organ recital, Al Carney; 6:40, Grayling's string trio; 6:50, Diamond quartet Loftis; 9:15, Cinderella cafe orchestra; 9:35, Kitchen Klezmer entertainers; 9:50, Howard Serphon,

Ribbon Quartet"; 7:30-8, WEAF; 8-9, WEAF; 10:30-11:30, Greer's orchestra; Roland Klump, flutist.

WOI, Ames, Ia. (270m-1100kc), 12:30 p. m., college chimes.

WOK, Chicago, Ill. (217.3m-1300kc), 4:30-7 p. m., Capitol theater organ; program; 10:1-10:30, Tearney's town club orchestra; Carl Lorraine's Pershing Palace orchestra; Husk O'Hare's Coconut Grove orchestra; Capitol theater program; program.

WORD, Batavia, Ill. (275m-1090kc), 7 p. m., program; 9, musical program; 11, program.

WQJ, Chicago, Ill. (447.5m-670kc), 7-8 p. m., dinner concert, Jack Chapman and his Rainbo Gardens orchestra; Kenneth Sterling, baritone; Leo Miller, violinist; Milton Sherman, pianist; 10-1 a. m., Jack Chapman and his Rainbo Skylarks; Jerry Sullivan, Rose Vandebosch, soprano, pianist; Hal Lansing and his uke; Merril Carder, baritone; Hal Lamabrook, soprano; Will Rossiter; Homo Vincent, boy baritone; Johnny Foats, baritone; Harold Olson, baritone; artists; 1-2, Ginger hour, Jack Chapman, Ginger Man and Little Skylarks.

WSAI, Cincinnati, Ohio (325.9m-920kc), 5:30 p. m., twilight musicale; 7, Mabley and Carew orchestra; 8, WEAF; 9:30, musical program, featuring Hawaiian guitars; 12, Freda Sanker's orchestra.

WSB, Atlanta, Ga. (428.3m-700kc), 8 p. m., Lyon and King de luxe concert; 10:45, artists, Loew's Grand theater.

WSM, Nashville, Tenn. (282.8m-1060kc), 10 p. m., frolic, Beasley Smith's orchestra.

CLASSICAL CONCERTS INDEX

Saturday, March 13			
Eastern 6 p. m.	Central 5 p. m.	Mountain 4 p. m.	Pacific 3 p. m.
WCX, WEAF, WMCA, WREO.			
7	6	5	4
KGO, KYW, WEAR, WENR, WMAQ, WNYC, WOAW, WOK, WRC.			
8	7	6	5
KDKA, KFNH, KOIL, KSD, KYW, WBWB, WGN, WMBB, WNYC, WOAW, WQJ.			
9	8	7	6
KFOA, KPRC, KHJ, KYW, WHAS, WIP, WLW, WORD, WSAI, WSOE.			
10	9	8	7
KNX, KYW, WEAF, WMAQ, WMC, WOAW, WOC, WORD.			
11	10	9	8
KGO.			
12 m	11	10	9
WOAW.			

Sunday, March 14			
Eastern 6 p. m.	Central 5 p. m.	Mountain 4 p. m.	Pacific 3 p. m.
WCAU.			
7:20	6:20	5:20	4:20
WCAB, WCAU, WEAF, WEAB, WEEL, WJAR, WTAG, WWJ.			
8	7	6	5
KYW, WAMD, WBZ, WEAR, WGBS, WGCP, WKAQ, WLS, WORD.			
9	8	7	6
KFDM, KPRC, KSD, WBZ, WCAU, WCOB, WCOO, WEAR, WGY, WHAR, WHT, WNYC, WQJ.			
9:15	8:15	7:15	6:15
WEEL, WJAR, WTAG.			
10	9	8	7
KHJ, KNX, KTHS, KYW, WCOO, WFAA, WNYC, WOC, WQJ, WSOE.			
11	10	9	8
KFVE, KHJ, KNX, KPO, KTHS, KYW, WHN, WKRC, WOC.			
12 m	11	10	9
KHJ, KNX, WOC.			
1 a. m.	12 m	11	10
KNX.			

Monday, March 15			
Eastern 6 p. m.	Central 5 p. m.	Mountain 4 p. m.	Pacific 3 p. m.
KGO, WCO, WEAF, WMCA, WREO, WWJ.			
7	6	5	4
KMA, WCO, WEAF, WEAR, WHAD, WJR, WOAW, WOK.			
8	7	6	5
KFNE, KSD, WBWB, WBZ, WCAU, WCX, WHAR, WHT, WJAR, WLW, WMBB, WTAG, WVIC.			
9	8	7	6
KFOA, KGO, KHJ, KPRC, WBWB, WCOO, WBZ, WCAE, WEEL, WHAD, WHO, WJAR, WLW, WORD, WOS.			
10	9	8	7
KMA, KPO, KPRC, KSD, KTHS, WAMD, WCOO, WEAF, WHAD, WJAR, WOAW, WSUL, WTAG.			
11	10	9	8
KGW, KHJ, KMA, KSD, KTHS, KWSC, WHN, WSAL.			
12 m	11	10	9
KGW, WBAP, WSAL.			
1 a. m.	12 m	11	10
KHJ.			

Tuesday, March 16			
Eastern 6 p. m.	Central 5 p. m.	Mountain 4 p. m.	Pacific 3 p. m.
WBZ, WCX, WEAF, WMCA, WREO, WWJ.			
7	6	5	4
KGO, KMA, WEAR, WEEL, WGBS, WHAD, WJR, WMAQ, WOAW, WOK, WOR, WVIC, WWJ.			
8	7	6	5
KFNE, KSD, KYW, WBZ, WCAE, WCAU, WCX, WEAR, WEEL, WGR, WHAB, WHT, WLS, WMBB, WQJ, WRC, WVIC.			

Wednesday, March 17			
Eastern 6 p. m.	Central 5 p. m.	Mountain 4 p. m.	Pacific 3 p. m.
WCK, WEAF, WMCA, WRO, WWJ.			
7	6	5	4
KGW, WEAR, WHAD, WJR, WMAQ, WOK, WVIC.			
8	7	6	5
KFNE, KPRC, KSD, KYW, WAMD, WBZ, WCX, WCAE, WEEL, WHT, WLW, WMBB, WMCA, WQJ, WTAG, WWJ.			
9	8	7	6
KFOA, KGO, KPRC, KSD, KYW, WBZ, WCOO, WDAF, WEEL, WGR, WHAD, WHAS, WJAR, WMAQ, WOR, WOS, WORD.			
10	9	8	7
KFMX, KMA, KNX, KTHS, WAMD, WCOO, WEAF, WEEL, WGR, WHAD, WJAR, WLS, WMAQ, WNYC, WOC, WSOE.			
11	10	9	8
KGW, KGW, KMA, KPO, KTHS, WCAE, WLS, WLW, WOC, WSAL.			
12 m	11	10	9
KGW, KPO, WHAD, WLW.			
1 a. m.	12 m	11	10
WLW.			

Thursday, March 18			
Eastern 6 p. m.	Central 5 p. m.	Mountain 4 p. m.	Pacific 3 p. m.
WBZ, WCX, WEAF, WIP, WMCA, WREO, WWJ.			
7	6	5	4
KGO, KSD, WEAF, WEAR, WGBS, WHAD, WJR, WMAQ, WOAW, WOK, WWJ.			
8	7	6	5
KYW, WMBB, WBZ, WCAU, WCOO, WCX, WEAR, WEEL, WGR, WGY, WHAR, WHT, WLS, WLW, WMBB, WOAW, WQJ, WTAG, WVIC.			
9	8	7	6
KHJ, KIDS, WBAP, WCAE, WCAU, WCOB, WCOO, WEAF, WEEL, WGR, WHAR, WHAS, WJAR, WNYC, WOC, WORD, WRC, WSAI, WSB, WTAG.			
10	9	8	7
KNX, KPRC, KTHS, KYW, WAMD, WGR, WGY, WHAD, WMC, WOAW, WOC, WSAL.			
11	10	9	8
KGO, KPO, KTHS, WBAP, WKRC.			
12 m	11	10	9
KGW, KPO, WHO, WKIC.			

Friday, March 19			
Eastern 6 p. m.	Central 5 p. m.	Mountain 4 p. m.	Pacific 3 p. m.
WGO, WCX, WMCA, WREO, WWJ.			
7	6	5	4
KGW, WEEL, WGY, WHAD, WJR, WMAQ, WOAW, WOK, WOR, WVIC.			
8	7	6	5
KYW, WAHG, WAMD, WBZ, WCAU, WCX, WEEL, WEEL, WLS, WQJ, WWJ.			
9	8	7	6
KFDM, KFNH, KFOA, KGO, KHJ, KSD, KYW, WBAP, WEAF, WCAU, WDAF, WEEL, WHAD, WJAR, WMAQ, WMCA, WSAL.			
10	9	8	7
KFAB, KFDM, KOA, WCOO, WHAD, WMAQ.			
11	10	9	8
KFMX, KHJ, KNX, KPO.			
12 m	11	10	9
KPO.			

WBBM, Chicago, Ill. (226m-1330kc), 4-6 p. m., Sandy and Harry; Arnold Stephenson; Sidney Nireman, pianist; Harold Morava, tenor; Russel Myers; 8-9, Sandy and Harry; Moulin Rouge orchestra; Phil Flemming, tenor; Jean St. Anne, French baritone; Christian A. Grimm, composer-pianist; Bob York, tenor; 9-12, Jack Crawford's orchestra; Arston trio; Barber Shop Three; Pete Kules; Ziegler Sisters; Vorris Worthley, tenor; Two Jays; Charlie Garland; Floyd Falch; Vivian Sheffer, contralto.

WCCB, Zion, Ill. (344.6m-870kc), 8 p. m., Mandolin and guitar club; double trio, mixed quartet; Mr. and Mrs. R. Steel, duets; Mrs. Beam and Mrs. Crow, duets; Richard Hlre, violinist; Miriam Hollinghead, flutist; Arthur Rendall, clarinetist.

WCCO, Minneapolis-St. Paul, Minn. (416.4m-720kc), 2:30 p. m., Dick Long's trio; 6:15, dinner concert, Biley's St. Paul hotel concert orchestra; 7:30, WEAF; 10:05, Radio drama, "A Step On The Stairs."

WDAF, Kansas City, Mo. (365.6m-820kc), 3:30-4:30 p. m., The Star's string orchestra; 6-7, music, Trianon ensemble; 11:45-1 a. m., Ted Weems' Victor Recording orchestra; Ben Bernie's orchestra.

WEBH, Chicago, Ill. (370.2m-810kc), 3-4 p. m., special features; 7, Oriole concert orchestra; 8, Oriole marimba band, special numbers; Kathryn Forbes, soprano; 9-9:45, musical hits, Balaban and Katz's Uptown theater; 11, Oriole orchestra, dance music; 12:30 a. m., Bernard Weber, tenor; Oriole trombone duo; Mark Fisher, songster.

WFAA, Dallas, Texas (475.9m-630kc), 12:30-1 p. m., Jeff J. Sandell, pianist; 4:30-5, MacDowell Sisters; 6:30-7:30, Baker hotel orchestra; 8:30-9:30, Southern Methodist university school of music; 11-12 midnight, Majestic theater orchestra.

WGES, Oak Park, Ill. (250m-1200kc), 5-7 p. m., flute; 8-9, entertainment; 11-1 a. m., popular features.

WGN, Chicago, Ill. (302.8m-990kc), 12:40-2:30 p. m., concert, Drake concert ensemble, Blackstone string quintet; 2:30-3, Lyon and Healy artists; 3-3:30, Bridge luncheon; 3:30-4:15, Tea Time music, Marshall Fields tea room orchestra; 4:30-5, organ recital, Edward Benedict; 6:30-8:45, Drake concert ensemble, Blackstone string quintet; 6:45-7, old-time favorites; 8-9, WEAF; 9-10, popular program; 10-10:10, Sam N. Henry; 10:10-10:20, old-time favorites; 10:20-10:40, the Playshop; 10:40-11, popular program.

WHAD, Milwaukee, Wis. (275m-1090kc), 6:15-10 p. m., Wisconsin artists' series.

tenor; Al Carney, organist; Jack Marshall, pianist; 10:10, dance music; 12, Pat Barnes and Al Carney.

WJJD, Meoschart, Ill. (370.2m-810kc), 12-1 p. m., Palmer House symphonic players; Palmer House trio; 2-3, Howard L. Peterson, organist; 4-5, music, Mooseheart children; 5:30-7, Jack Nelson, Palmer House symphonic players; Palmer House Victorians; Howard L. Peterson, organist; 8-9, children; 10-11, Garrod studio; Rushmore ensemble singers; Palmer House Victorians; 12:30 a. m., Knights of the Burning Candle.

WKRC, Cincinnati, Ohio (325.9m-920kc), 10 p. m., Alvin Roehr and his Hotel Alton orchestra; 10:30, Eugene Perazzo, organist; 11, Doc Howard's Cuvier—WKRC entertainers.

WLJB, Chicago, Ill. (302.8m-990kc), 7-7:20 p. m., Uncle Wall's Punch and Judy show; 7:20-7:30, Correll and Gosden; 7:30-8, WEAF; 11-11:20, Correll and Gosden; 11:20-1 a. m., dance music; Currell and Gosden.

WLS, Chicago, Ill. (344.6m-870kc), 12 m., Ford and Glenn; 6, Ford and Glenn; 6:40, Ralph Emerson, organist; 7, Ford and Glenn; 7:15, Genevieve Brin-tuall, soprano; Allan Schirmer, baritone; Adele Gooden, pianist.

WLW, Cincinnati, Ohio (422.3m-710kc), 7:30 p. m., piano memories, Mary Louise Wozczek; 8, old-time review, Crosley Burnt Corkers; 9, concert program, Formica orchestra, William Stoss, director.

WMAQ, Chicago, Ill. (447.5m-670kc), 2 p. m., program for shut-ins; 4:15, pupils, Harriet Waxman; 4:30, Chicago High School Teachers' council; 4:30, pupils, Columbia school; 6, Chicago theater organ; 6:30, Hotel La Salle orchestra; 8:40, musical program, V. Gullotta; 9:10, St. Francis church choir; 9:55, chimes, Mitchell tower.

WMBB, Chicago, Ill. (250m-1200kc), 7-8 p. m., Trianon duo; Grand opera trio; 9-11, Woodlawn theater orchestra; Trianon orchestra; Walter Kip; Oxford Girls; Joe Warner; Bob Duffy, baritone; Lou Sievers.

WMC, Memphis, Tenn. (499.7m-600kc), 8:30 p. m., concert, Mrs. O. H. Muehler; 11, frolic, Britling's cafeteria novelty orchestra.

WOAI, San Antonio, Texas (394.5m-760kc), 8:30 p. m., Gebhardt, Mexican players.

WOAW, Omaha, Neb. (526m-570kc), 6 p. m., Hugo G. Heyn, xylophonist; 6:50, orchestra; 9, de luxe; 10:10, Radio review; 10:30, Herbe Feierman and his orchestra; 12, Rialto alarm.

WOC, Davenport, Iowa (483.6m-620kc), 5:45-6 p. m., chimes concert; 7-7:30, musical program, "The Blue

Mountain Time Stations
CFAC, Calgary, Canada (435.8m-685kc), 8 p. m., studio program, Y. M. C. A.
CNRR, Regina, Can. (476m-640kc), 8 p. m., concert program.
KFAU, Boise, Idaho (280.2m-1070kc), 8:10 p. m., program, Boise high school expression department, Helen Mayer, Helga Sjaastad, directors.
KFWA, Ogden, Utah (261m-1150kc), 4-5 p. m., organ recital, Paramount theater; 5-6, Radio dealers program.
KFFF, Colorado Springs, Colo. (250m-1200kc), 8:30 p. m., Benjamin Johnson, pianist; Dorothy Allen, violinist; Gertrude Bieker, contralto; John Otten, tenor.
KOA, Denver, Colo. (322.4m-930kc), 12:15 p. m., Marjorie Nash, organist; 6:30, dinner concert, Brown Palace string orchestra.

Pacific Time Stations
CNRV, Vancouver, Can. (291.1m-1030kc), 8:30 p. m., studio program, St. Giles' church choir; ladies trio; Velma Carnwath, pianist; Scotch song, Jean Carrick; Jean Robertson, soloist; Christy Madsen, pianist; 10:30, Cabaret Belmont orchestra, Bebe Mullar, soprano.
KFI, Los Angeles, Calif. (467m-640kc), 5:30-6 p. m., Charles Beauchamp, tenor; 6, nightly doings; 6:30, vest pocket program; 6:45, Radiator period; 7-8, dance music; 8-9, Screen Artists' instrumental quartet; Virginia Flohri, soloist; 9-10, Louise Kios trio; harp, cello and violin; 10-11, Packard ballad hour of popular song hits.
KFOA, Seattle, Wash. (454.3m-660kc), 12:30-1:30 p. m., Klwanis club luncheon program; 6-6:30, Atwater Kent Boys; 7-8:15, program; 8:30-10, Rhodes Department store; 10-11, Jackie Souder's Club Lido serenaders.
KFON, Long Beach, Calif. (232.4m-1280kc), 6-6:30 p. m., Brayton's theater organ; 6:30-7, amusement bulletin; 7-8, studio program; 8-9, Press-Telegram studio; 9-11, Long Beach Aero club frolic.
KFWB, Hollywood, Calif. (252m-1190kc), 6-7 p. m., dinner music, Fitzgerald Music company; 8-9, Patrick Marsh dance orchestra; 9-10, program, Alexandria Tailors; Dave Ward and his band; Alexandria Tailors' orchestra; 10-11, Warner Brothers frolic.
KGO, Oakland, Calif. (381.2m-850kc), 11:30-1 p. m., luncheon concert; 4-5:30, concert orchestra; 6-6:05, Bfokaw and orchestra; 8-9, Eveready program; Michel Piastro, violinist, assisted by Lev Shorr, pianist; 9:10-9:30, Albert Peek Bates, bass; Joseph McIntyre, accompanist; 10-12, dance music, Girvin-Deuel's California Collegians.
KGW, Portland, Ore. (491.5m-610kc), 12:30-1:30 p. m., concert, First National bank and the Security Savings and Trust company; 6-7, dinner concert, Olds, Wortman and King company; 8-10, McElroy quartet; 10-12, music, Multnomah hotel.

MANY STATIONS HONOR ST. PATRICK

Wednesday, March 17

violinist; A. Schell, contralto; quartets; W. Stephenson, baritone.

CNRO, Ottawa, Can. (434.5m-690kc), 8 p. m., Chateau Laurier concert orchestra; 9, Canadian National Railways orchestra; artists; Irish music; dance orchestra.

KDKA, Pittsburgh, Pa. (309.1m-970kc), 12:20 p. m., Trinity church Lenten services; 6:30, dinner concert; 9, concert.

WAHG, Richmond Hill, N. Y. (315.6m-950kc), 12 noon., Lenten services; 12:35 p. m., studio program; 7:30, St. Patrick's Day program; 8:15, Brandfield trio; 8:45, Raymond Maher, baritone; 9, Jimmy Smith, banjo king; 9:15, Old-Fashioned quartet; 10:02, Four Gondoliers.

WBZ, Springfield, Mass. (333.1m-900kc), 6:30 p. m., Hotel Kimball orchestra; 7, program, Lincolnton Supply company; Mme. Luisa Tosi, prima donna soprano; Philharmonic trio; Gaetano Misterly, violinist; Gustave LaZazzera, cellist; Mrs. Eleanor LaZazzera, accompanist; 7:30, Nature league; 8, Holyoke hour, Falco band; Giles Haggerty, baritone; 9, WBZ concert company, Irish music.

WCAE, Pittsburgh, Pa. (461.3m-650kc), 6:30 p. m., dinner concert, William Penn hotel; 8, Mystery Merry Makers; 8:30, Davis saxophone octet; 9, concert; 10, Kramer's orchestra.

WCAP, Washington, D. C. (468.5m-640kc), 7-11 p. m., U. S. Navy band orchestra; WEA.

WCAU, Philadelphia, Pa. (277.6m-1080kc), 8:45 p. m., Parodians dance orchestra; 7:30, recital, N. Snellenburg and company; 8:10, Kane's musical adventures; 9, Rigo's Royal Gypsy band; 9:30, Jones' Jolly Four; 10:30, Carl Zochers and Lou Herscher, songs; 10:45, Frank Cook, old-time songs; 11, Artie Bitteng's Cheer-up club.

WCX, Detroit, Mich. (516.9m-580kc), 6-7 p. m., dinner program, Goldkette ensemble; 8-9, program.

WEAF, New York, N. Y. (491.5m-610kc), 4 p. m., Ray Nichols Recording orchestra; 4:30, Helen L. Martin, mezzo-soprano; 4:45, reading from Irish poets, John Murphy; 5, Vincent Lopez and orchestra from Blitz-Cariton hotel; 6, dinner music, Waldorf-Astoria hotel; 7, synogogue services; 7:30, Irish program, Seamus O'Doherty, Irish tenor; 7:45, Patrick Hyde, accordionist; 8, Two in One Man and the Shinola Boys; 8:30, Davis saxophone octet; 9, La Troubadours; 10, Irish program; 11, Hughie Barr and orchestra.

WEAO, Columbus, Ohio (294.9m-1020kc), 8:15 p. m., music; 8:45, Broad Street Synagogue church.

WEAR, Cleveland, Ohio (389.5m-770kc), 7 p. m., Hotel Cleveland orchestra.

WEBJ, New York, N. Y. (272.6m-1100kc), 8-10 p. m., Tuckahoe night, auspices Recreation Commission Town of Eastchester.

WEEI, Boston, Mass. (348.6m-860kc), 12:15 a. m., Lenten services, B. F. Kelly's theater; 3:05 p. m., E. Fayson Jr and his orchestra; 5, Black and White orchestra; 6:13, Joe Rines and his Hunters' Cabin orchestra; 7:30, Henry Volk, violinist; Glandys Posselt, accompanist; 7:45, Peerless tours, Joe Toy; 8:30-10, WEAF.

WFI, Philadelphia, Pa. (394.5m-760kc), 10:30 a. m., Betty Crocker; 1 p. m., Tea Room ensemble; 3, the Tabor Symphony orchestra; 6:30, Bellevue Stratford concert orchestra; 7, Bellevue Stratford dance orchestra.

WGBS, New York, N. Y. (315.6m-950kc), 1:30 p. m., O'Connor and Fiddler, spoken melody; 3, St. Patrick's Day program; 6, Uncle Geebee; 6:30, Jersey collegians.

WGCP, New York, N. Y. (252m-1190kc), 3 p. m., Eva Rothberg, pianist; 3:30, Bobby Grey, singer; 4:10, harp music; 4:30, Jeanne O'Dair, composer; 4:45, Tracey and Mohr; 5:05, Pollack and Dorn; 7, program; 7:30, McDermott-Heagney and Steele; 7:45, Charles Coleman, pianist.

WGHB, Clearwater, Fla. (266m-1130kc), 6:30-7:30 p. m., dinner music; 8:30-9:30, Caroline Lee, "The Virginia Girl," Spanish guitarist; 11:45-1, midnight ramble dance music.

WGHP, Detroit, Mich. (270m-1110kc), 6-7 p. m., dinner concert; 8-10, Little Symphony orchestra; Joseph Mosbach, bassoon soloist; Julius Sturm, cellist; WHP quartet; Mme. Gisl Szanto, pianist; 12-1 a. m., Gerald Marks and his orchestra.

WGR, Buffalo, N. Y. (319m-940kc), 2:30 p. m., WGR's afternoon program; 3:30, Knell's Tokio dance orchestra; 8, Audubon Terrace Meadowlarks; 8:30, WEAF; 10, popular concert, Sidney Carlson of Fredonia; 11, Vincent Lopez Hotel Statler dance orchestra.

WGY, Schenectady, N. Y. (379.5m-790kc), 7 p. m., WHAM; 8:05, music WHAM.

WHN, New York, N. Y. (361.2m-830kc), 6 p. m., People's hour; 7, Van and Schenck of the Parody club; 7:30, music; 8, "Vogue entertainers"; 9, Loew's New York orchestra; 10, Roseland dance orchestra; 10:30, Anatol Friedland; 11, Silver Slipper orchestra; 11:30, Meody club orchestra; 12 midnight, Cotton club orchestra.

WIP, Philadelphia, Pa. (508.2m-590kc), 10, reducing exercises; 1 p. m., Gimbels tea room orchestra; 3, Shapp instrumental trio; 6:05, Benjamin Franklin hotel concert orchestra; 7, Anna Plevinsky, pianist, Bertha Plevinsky, violinist.

WJR, Pontiac, Mich. (516.9m-580kc), 7 p. m., Jean Goldkette's symphony orchestra; soloists; 9, Winter Haven Radio hour; 11:30, "The Merry Old Chime"; 12:30, WIZ, New York, N. Y. (454.5m-690kc), 12 p. m., Trinity Lenten service; 8:30, Lewisohn free chamber music concert.

WKAR, East Lansing, Mich. (285.5m-1050kc), 8-9 p. m., musical program.

WLIT, Philadelphia, Pa. (394.5m-760kc), 12:02 p. m., Stanley theater organ recital; Arcadia cafe concert orchestra; 2, Arcadia cafe concert orchestra; 7:30, Dream Daddy's bedtime stories; 8:15, recital; 10, Arcadia cafe dance orchestra.

WLWL, New York, N. Y. (288.3m-1040kc), 8 p. m., James Byrne, bass; 8:15, Edmund Tucker, bagpipe soloist; 8:30 recitation; 8:45, music; 9:15, Trick Airs, International trio; 9:30, Rhea Leddy, Wm. Pluck, duets; 9:45, Sara Dunn, mezzo-soprano; 10, Henry Condon, tenor; 10:05, musicals; 10:15, WLWL male quartet, Nell O'Brien, soprano; 10:40, International trio; 11, WLWL male quartet; 11:15, violin solo; 11:35, Pedro de Cordoba, reader; 11:45, organ recital.

WMAK, Buffalo, N. Y. (266m-1130kc), 7:30-9 p. m., musical program; 9-10, Chicagoans orchestra.

WMCA, New York, N. Y. (340.7m-880kc), 6 p. m., Olcott Vail and his Hotel McAlpin string ensemble; 6:30, Ernie Golden and his Hotel McAlpin orchestra; 8:30, American School association; 9, Coughlan and company, musical program; 10:30, Parody club orchestra; 10:45, Van and Schenck; 11, Hofbrau Haus entertainers; 11:30, Jack Denny's orchestra; 12 midnight, McAlpin entertainers.

WNYC, New York, N. Y. (526m-570kc), 5:45 p. m., Agnes Vernon's juveniles; 6:20, piano selections; 7:35, Chris Mehan, tenor; 7:50, Original Black Diamond serenaders; 8:45, concert program.

WOR, Newark, N. J. (405.2m-740kc), 6:30-7:15 p. m., Jacques Jacobs' Hotel Shelton ensemble; 7:30-7:45, Zil's Central Park Casino orchestra; 8:30-9, Arthur Lange, composer.

WRC, Washington, D. C. (468.5m-640kc), 12:30 p. m., Lenten services; 1, Lee House trio; 4:15, Meyer Davis' Le Paradis band; 5, organ recital.

WTAG, Worcester, Mass. (268m-1120kc), 10:30 a. m., musical selections; 12:05-2 p. m., noonday luncheon music; 8-8:30, WEAF; 9-10, St. Patrick's program; 10-11, WEAF.

WTIC, Hartford, Conn. (475.9m-630kc), 6:30 p. m., Hotel Bond trio; 8, Hartford Hospital Training school glee club; 8:30, W. Van Maasdyk, violinist; 9:15, Laura Gaudet, pianist; 9:30, organ recital.

WWJ, Detroit, Mich. (352.7m-850kc), 12:05 p. m., Jules Klein's Hotel Statler orchestra; 3, Detroit News orchestra; 6, dinner concert; 8, News orchestra and soloists; 9, dance program; 10, Roxy and his gang.

Central Time Stations

CNRW, Winnipeg, Can. (384.4m-780kc), 7:30 p. m., musical program, Ft. Garry hotel orchestra; 9, special broadcast, Hart House string quartet; 10:30, dance program, Ft. Garry hotel orchestra.

KFAB, Lincoln, Neb. (340.7m-880kc), 5:30-6:30 p. m., dinner concert; 8:30-10:30, Gloomy Gus, entertainer; Slick Moriam, pianist; Harriet Cruse, Oriole of the Air; Cowbell Boys and Belshaw's.

KFMX, Northfield, Minn. (336.9m-890kc), 9-10 p. m., musicale.

WCCO, Minneapolis-St. Paul, Minn. (416.4m-720kc), 2:30 p. m., afternoon concert; 6, midweek church service, Woodland Park Baptist church; 7, WEAF; 8, WEAF; 9, Nash-Finch concert orchestra; 10:05, dance program, Dick Long's Nankin Cafe orchestra; 11:30, Eddie Dunstetter, organist.

WDAF, Kansas City, Mo. (365.6m-820kc), 6-7 p. m., Trianon ensemble; 8-8:30, play, WDAF players; 8:30-9, Negro spirituals; 9-10, classical program; The Star's Radio string orchestra; Nadine Suesse, pianist; 11:45-1 a. m., program, WDAF's Plantation Grill studio.

WEBH, Chicago, Ill. (370.2m-810kc), 3-4 p. m., special features; 7, Oriole concert orchestra; 8, Florence Behrend, songster; Oriole string trio; 9-10, Dennis Sisters, Oriole orchestra; Frank Bordner; Oriole Marimba.



The sprightly songs of Lorena Walcott Barker, above, are well liked by fans tuning in for WEAF, Fort Worth. This southern beauty boasts of many charming southern melodies in her repertoire.

KFRU, Columbia, Mo. (499.7m-600kc), 9-11 p. m., musical program, students and faculty.

KFUO, St. Louis, Mo. (545.1m-550kc), 9:15 p. m., musical program, senior choir, Zion Lutheran church.

KMA, Shomosh, Iowa (252m-1190kc), 6-7 p. m., Farnham trio; 11:30-12:30, banjo solos, Charles Skinner; 6-7 p. m., music; 9-11, songs and clog dancing, Bob and Babe Riddle, Willy Cunningham, the farmer Scotchman; Tarkio college.

KMOX, St. Louis, Mo. (280.2m-1070kc), 12:30 p. m., Arthur L. Utt, organist; 3, String ensemble; opera-logue, "Barber of Seville"; Mrs. Thaddeus Smith, reader; Emerson Brown, tenor; Helen McFarland, coloratura soprano; 6, Arthur L. Utt, organist; 6:30, Mrs. Jacques Landree, organist; 7, David Bittner, orchestra; St. Patrick's program, Mrs. Clara Thoms; 8, orchestra; readings and songs; 9, orchestra; song cycle, Harriett Robinson in Negro songs; 10, orchestra.

KPRC, Houston, Texas (296.9m-1010kc), 7:30 p. m., Jack Willrich's orchestra; Virginia Willrich, piano-accordionist; Eddie Quinn, banjoist; 8:30, Temple Beth Israel choir; 11, Queen theater orchestra.

KSD, St. Louis, Mo. (545.1m-550kc), 7 p. m., WEAF; 7:30, Hotel Statler concert orchestra; 8, WEAF.

KSO, Clarinda, Iowa (241.8m-1240kc), 7-7:15 p. m., music; 7:30-9:30, Seiland's orchestra.

KTHS, Hot Springs National Park, Ark. (374.8m-800kc), 9-9:30 p. m., Irish favorites; Lon Chassy, violinist; 9:30-9:50, Irish ballads, Arthur Platz, tenor; Elizabeth Bove, pianist; 9:50-10, Lawson Reid, organist; 10-10:45, Southerners dance orchestra.

KWWG, Brownsville, Texas (278m-1080kc), 6 p. m., Texas theater orchestra.

KYW, Chicago, Ill. (535.4m-560kc), 12:05-1 p. m., noon-day concert; 1-2, luncheon concert; 6-7, dinner music; 7:30, music; 8, musical program, Congress hotel; 10-12:30, midnight revue; Paul Ash; Coon-Sanders Original Nightwalkers; Henri A. Keates, organologue; 1-2, Insomnia club.

WAMP, Minneapolis, Minn. (244m-1230kc), 12:01 p. m., classical program; 7:10, classical program; 11, Skyrocket frolic, George Osborn and his orchestra.

WBAP, Ft. Worth, Texas (475.9m-630kc), 12:05-12:30 p. m., musical program; 6-6:30, dinner music.

WBBM, Chicago, Ill. (226m-1330kc), 4-6 p. m., Harry and Sandy; Edna Wheeler Ballard, harpist; Harold Morava, lyric tenor; Johnny Black; Court Banks; Ralph Bothof; 8-10, Barber Shop three; Jack Crawford's orchestra; Verdi mixed quartet; Sy Berg and Bob Witt; Phillip Nilles, tenor; Rudy Winter; Floyd Faeh; 12-2 a. m., Jack Crawford's orchestra; Charlie Garland; Two Jays; Harold Anderson, accordionist; Floyd Faeh; Arlston trio.

band; 11-12:30 a. m., Oriole dance orchestra; songs, Irene Beasley; songs, Florence Behrend; Dennis Sisters; Oriole dance orchestra.

WEMC, Borrien Springs, Mich. (285.5m-1050kc), 8:15 p. m., program in French and English.

WFAA, Dallas, Texas (475.9m-630kc), 2:30-3 p. m., Mrs. W. C. Barrickman and the Campfire girls.

WGES, Oak Park, Ill. (250m-1200kc), 5-7 p. m., twilight concert; 8-9, classical program; 11-1 a. m., Coyne serenaders.

WGN, Chicago, Ill. (302.8m-990kc), 12:40-2:30 p. m., concert, Drake ensemble, Blackstone string quintet; 2:30-3, Lyon and Healy artists; 3-3:30, Auction Bridge game; 3:30-4:15, Tea Time music, Marshall Field tea room orchestra; 4:30-5, organ recital, Edward Benedict; 6:30-7, Drake concert ensemble, Blackstone string quintet, old-time favorites; 8-9, studio program; 9-10, WEAF; 10-10:10, Sam 'n' Henry; 10:10-10:20, old-time favorites; the Playshop; 10:40-11, popular program.

WHAD, Milwaukee, Wis. (275m-1090kc), 6:15-7 p. m., organ recital, Arthur Richter; 10:30-11:30, dance hits, Wisconsin Roof orchestra; 11:30-12:30 a. m., request organ recital, Edmund Fitch, organist.

WHAS, Louisville, Ky. (399.8m-750kc), 1-2 p. m., concert, Barney Rapp's orchestra; 3:30-4, music; 4-5, Six Collegians; Evelyn Bush Pence, Maryland Calvert, Madonna Talladay, Mildred Goethe, Katherine Altes, Caroline Hubbard; concert; 7:30-9, concert, Optimist club.

WHB, Kansas City, Mo. (365.6m-820kc), 2-3 p. m., Morrill Moore, organist; Don Anchors, poet; 7-8, Milo Pinley trio; mandolin, guitar duets; popular songs.

WHO, Des Moines, Iowa (526m-570kc), 2:15 p. m., Camp Fire Girls' credo; 6-7, Bankers Life Little symphonic orchestra; 7:15-8:15, Irene Dorans Little symphony orchestra; 8:15-9, Agnes Flannery, pianist; Four Musketiers; 9-12 midnight, dance programs.

WHT, Chicago, Ill. (399.8m-750kc), 12 m., Al Carney's complimentary organ recital; 6-7:30, Genovieve B. Burnham, soprano; Peter Porstner; Howard Will, tenor; Grayling's string trio; Helen Raub, pianist; 7:45-9:15, Cinderella Cafe orchestra; 9:30, Al Carney and Pat Barnes; 10:05, Ray-O-Vac concert; 11:15, Cinderella Cafe orchestra; 11:30, Pat Barnes and Al Carney; 12, Pat Barnes and Al Carney.

WJDD, Mooseheart, Ill. (370.2m-810kc), 2-3 p. m., Howard L. Peterson, organist; 4-5, music, children; 5:30, Jack Nelson; Palmer House symphonic players; Howard L. Peterson, organist; Palmer House Victorians; 6:40, Billy Van; 8-9, music, children; 10-11, R. V. Thomas; John Norton; Palmer House Victorians; 12:30 a. m., "Settin' Up" hour.

WKAF, Milwaukee, Wis. (261m-1150kc), 10-11 p. m.,

NEWS BULLETINS

Daily Except Sunday

Eastern	Central	Mountain	Pacific
9:45 a. m.	8:45 a. m.	7:45 a. m.	6:45 a. m.
KDKA (309.1m-970kc)			
10:35		8	7
WGN (302.8m-990kc)			
10:35		8:35	7:35
WCCO (416.4m-720kc)			
11		9	8
WOAI (394.5m-760kc)			
12 n.		10	9
CFCA (356.9m-840kc)		KDKA (309.1m-970kc)	
KPRC (296.9m-1010kc)		12:30 p. m.	11:30
12:30 p. m.	11:30	10:30	9:30
WCAE (461.3m-650kc)			
1		11	10
KGW (491.5m-610kc)		KNX (386.9m-890kc)	
1:15	12:15 p. m.	11:15	10:15
WOAI (394.5m-760kc)			
3:45	2:45	1:45 p. m.	12:45 p. m.
WELAS (399.8m-750kc)			
4		2	1
WCX (516.9m-580kc)			
4:30	3:30	2:30	1:30
WCAE (461.3m-650kc)		WFSA (475.9m-630kc)	
6	5	4	3
CFCA (356.9m-840kc)			
6:30	5:30	4:30	3:30
WPG (299.8m-1000kc)			
7	6	5	4
KOLL (278m-1080kc)		WOC (483.6m-620kc)	
7:15	6:15	5:15	4:15
WMAK (265.6m-1130kc)		WOAI (394.5m-760kc)	
8	7	6	5
WMBF (384.4m-780kc)		WMCA (340.7m-880kc)	
9	8	7	6
WSAI (325.9m-920kc)		7:30	6:30
9:30	8:30		
KPO (428.8m-700kc)		8	7
10	9		
KLX (508.2m-590kc)		8:45	7:45
10:45	9:45		
WEBH (370.2m-810kc)			

Sunday

Eastern	Central	Mountain	Pacific
8 p. m.	7 p. m.	6 p. m.	5 p. m.
WMAK (265.6m-1130kc)			
8:15	7:15	6:15	5:15
WEBH (370.2m-810kc)			
9	8	7	6
WPG (299.8m-1000kc)			
12	11	10	9
KFWB (252m-1190kc)			

KYW, "The World Crier," broadcasts news every half hour from 8 a. m. to 2 a. m.

Campus Skylarks; Dammann ladies' trio; Michael Flynn, Irish melodies.

WKRC, Cincinnati, Ohio (325.9m-920kc), 6 p. m., Alvin Roehr and his Hotel Alms orchestra; 8:15, Oliver Plunkett, tenor; 9, concert orchestra; 9:40, orchestra music.

WLIB, Chicago, Ill. (302.8m-990kc), 7-7:30 p. m., Uncle Walt's Punch and Judy show; 7:20-7:30, Aud Sully; 7:30-8, WEAF; 11-11:20, Correll and Gosden; 11:20-1, dance music; Correll and Gosden.

WLS, Chicago, Ill. (344.6m-870kc), 12 m., Ford and Glenn; 6 p. m., Ford and Glenn; 6:40, Ralph Emerson, organist; 7, Ford and Glenn; 7:15, WLS trio, "Songs of Ireland," Olive O'Neil, soprano; 7:45, Grace and Ralph; 8, "Home Fires," WLS Radio play contest; 8:30, George Goforth band production; 9, Chicago concert company; 9:40, Alice LeClarte, pianist; Tony Corcoran, baritone; 10, Ford and Glenn; 11-2 a. m., WLS circus with George Goforth band.

WLW, Cincinnati, Ohio (422.3m-710kc), 6-10 p. m., St. Patrick's Day celebration, banquet of the Irish Fellowship club, Hotel Gibson Roof Garden; 10, an hour in the shadow of the Shamrock, musical program featuring WLW instrumental trio; 10:30, tenor solos, Ed. Lush; 11, organ recital, Johanna Grasse; 11:15, Maids of Melody, Grace Donaldson and Hortense Rhodes; 11:30, Don Bestors orchestra; 11:45, Johanna Grasse.

WMAQ, Chicago, Ill. (447.5m-670kc), 1 p. m., Chicago association of commerce luncheon; 2, Shut-in program; 4:45, pupils, Starlet school; 5:15, Georgene Faulkner, the story lady; 6, Chicago theater organ; 6:30, Hotel LaSalle orchestra; 8:25, program; Mr. and Mrs. Trengillus; 8:55, WMAQ players; 9:55, chimes.

WMBB, Chicago, Ill. (250m-1200kc), 7-8 p. m., Eleanor Kaplan, violinist; Veronica Krebs, contralto; Edwin House, bass; Preston Graves, pianist; 9-11, Trianon orchestra; Woodlawn theater orchestra; Walter Kip, Billie Allen Hoff; Ted Graham, baritone; Bob Bennett, pianist.

WOAI, San Antonio, Texas (394.5m-760kc), 3 p. m., Radio Trades association, concert; 8:30, Army night.

WOC, Davenport, Ia. (483.6m-620kc), 4-4:15 p. m., musical program; Paul Vipperman, tenor; Frances Armil, pianist; John Drier, zither harpist; 5:45-6, chimes concert; 7-7:30, musical program, WEAF; 9-9:30, Erwin Swindell, organist; 9:30-10:30, musical program.

WOI, Ames, Iowa (270m-1110kc), 12:30 p. m., college chimes; 7:30, quartet.

WOK, Chicago, Ill. (217.3m-1300kc), 4:30-7 p. m., Capitol theater organ; program; 10-1:30, Tearney's town club orchestra; Carl Lorraine's Pershing Palace orchestra; Husk O'Hare's Loranet Grove orchestra; Capitol theater program; program.

WOO, Philadelphia, Pa. (508.2m-590kc), 11 a. m., organ recital; 12:02 p. m., Golden's crystal tea room orchestra; 4:45, organ recital; 7:30, Sylvania dance orchestra; 8:30, Davis' Saxophone octet; 10, Fox theater studio program; 10:30, Ritz Carlton dance orchestra.

WORD, Batavia, Ill. (275m-1090kc), 7 p. m., program; 9, Webster trio; I. B. S. A. choral singers; 11, program.

WOS, Jefferson City, Mo. (440.9m-680kc), 8:15-10 p. m., program, Clara Holtschneider; LeRoy H. Kelsey, original poems.

WOJ, Chicago, Ill. (447.5m-670kc), 7-8 p. m., dinner concert, Jack Chapman and his Rainbo Gardens orchestra; Christian Grimm, pianist; Jean St. Anne, baritone; Jessie Pringle, soprano; Agnes Pringle, violinist; 10-1 a. m., Jack Chapman and his Rainbo Skylarks; Melodians; Clarence Theaders, tenor; Joe Warner, character songs; Oxford Girls, Harmony singers; Gail Bandell, Sunshine Girl; 1-2, Ginger hour, Jack Chapman, Ginger Man and Little Skylarks.

WSAI, Cincinnati, Ohio (325.9m-920kc), 7 p. m., WEAF; 7:30, WEAF; 10:15, musical program, Playing Card string quartet.

WSB, Atlanta, Ga. (428.3m-700kc), 10:45 p. m., Biltmore hotel orchestra.

WSM, Nashville, Tenn. (282.8m-1060kc), 6:30 p. m., concert, Francis Craig's orchestra; 8, Mrs. Barton Brown, contralto and artists; 10, Boston serenaders.

Mountain Time Stations

KFWA, Ogden, Utah (261m-1150kc), 4-5 p. m., organ recital, Paramount theater; 5-6, Radio dealers program; 9-10:30, music, Paramount theater; 10:30-12, Olie Reeves and his orchestra, Berthana Ball room.

KOA, Denver, Colo. (322.4m-930kc), 12:15 p. m., Marjorie Nash, organist; 6:30, dinner concert, Brown Palace string orchestra; 8, instrumental program; 8:15, studio program; 10, dance program, Broadmoor Rhythm Rustlers.

KGW BEGINS VAUDEVILLE FEATURE

Wednesday, March 17

Pacific Time Stations
KFI, Los Angeles, Calif. (467m-540kc), 5:30-6 p. m., Jim, Jack and Jean Trio; 6:30-7, Nightly Delights; 6:30, vest pocket program; 6:45, Radiatorial period; 7-7:30, program, A. H. Grebe and company, Synchronapha string ensemble; 7:30-8, Nick Harris' detective story; 8-9, program, Ventura Refining company; 9-10, popular program, Chevrolet Motor company; 10-11, Owen Fallon's Californians; Jackie Lucas, soloist.
KFOA, Seattle, Wash. (454.3m-660kc), 12:30-1:30 p. m., luncheon program; 7-8:15, Hopper Kelly company studio program; 8:30-10, Times program.
KFON, Long Beach, Calif. (232.4m-1290kc), 6-6:30 p. m., Brayton's theater organ; 6:30-7, amusement information; 7-8, investor's hour with entertainment; 8-9, Press-Telegram studio; 9-10, program, Sam Abrams, the tailor; 10-11, Oriole dance orchestra.
KFWB, Hollywood, Calif. (252m-190kc), 5-6 p. m., Big Brother's children's hour; 6-7, dinner music, Fitzgerald Music company; 8-9:30, Bill Hatch's Oakland Country club dance orchestra; 9:30-10, Mutual Motors joke contest; 10-11, Warner Brothers' frolic.
KGO, Oakland, Calif. (361.2m-830kc), 11:30-1 p. m., luncheon concert; 4-5:30, Hotel St. Francis concert orchestra; 6-6:35, Brokaw and orchestra.
KGW, Portland, Ore. (491.5m-610kc), 12:30-1:30 p. m., concert, First National bank and the Security Savings and Trust company; 6-7, concert, Olds, Wortman & Kings company; 8-9, 7th United States Infantry band; 9-10, vocal and instrumental music; 10-11, concert, Sherman, Clay & Company Duo art-studio.
KHJ, Los Angeles, Calif. (405.2m-740kc), 8:15-10:30 p. m., program, Southern California Edison company; Mildred Ware, contralto; Nicholas Hearne, Jr., pianist; Optimist male quartet; Frederick Mac Murray, viola; Carolyn Le Fevre, violinist; Monrovia trio; 10:30-11:30, Don Clark's Biltmore hotel dance orchestra.
KJR, Seattle, Wash. (389.4m-780kc), 7-8:30 p. m., Sears-Roebuck and company program; Bob's Lady orchestra; 8:30-10, Post Intelligence studio program.
KLX, Oakland, Calif. (508.2m-590kc), 9-9:45 p. m., studio program; 9:45-10:30, Athens Athletic club orchestra.
KMTR, Hollywood, Calif. (238m-1260kc), 8-10 p. m., KMTR concert orchestra, Loren Powell, director; Dan Gridley, tenor; 10-11, Starr Piano company studio.
KNX, Hollywood, Calif. (336.9m-890kc), 5:30 p. m., Leighton's cafeteria orchestra; 8-9:30, program, Security Trust and Savings bank; 9-10, program, Joe Dalay's 165 grocery stores; 10-11, dance music; 11-12 midnight, Ambassador hotel dance orchestra.
KOAC, Corvallis, Ore. (280.2m-1070kc), 7:30 p. m., musical selections.
KTAB, Oakland, Calif. (240m-1250kc), 9-9:30 a. m., prayer service; 12-1 p. m., luncheon concert; 8-10, program, Western States Life Insurance company.
KWSC, Pullman, Wash. (348.6m-860kc), 7:30 p. m., Oakesdale special program.

7:30, Marcia West Whitten, mezzo contralto; Marion Goodrich, accompanist; 8-10, WEAF.
WFIL, Philadelphia, Pa. (394.5m-760kc), 1 p. m., Tea Room ensemble; 6:30, Bellevue Stratford concert orchestra; 7, Bellevue Stratford dance orchestra; 8, Larkinites; 8:30, Hires' Harvesters; 9, Cliequot Club Eskimos; 10, Silvertown Cord orchestra.
WGBS, New York, N. Y. (315.6m-950kc), 6 p. m., Uncle Geebee; 9, Crystal Palace orchestra; 10:10, Mac and Lemmi, songs; 10:30, Vanderbilt hotel orchestra.
WGCP, New York, N. Y. (252m-1190kc), 3 p. m., Norman Secor, pianist; 3:30-5:30, studio program;

orchestra; 2, Arcadia cafe concert orchestra; 4:30, recital; 7:30, Dream Daddy's bedtime stories.
WLWL, New York, N. Y. (288.3m-1040kc), 9:15 p. m., songs; 10, music; 10:15, study club; 10:30, entertainment.
WMAK, Buffalo, N. Y. (266m-1130kc), 6:15-7:15 p. m., dinner music.
WMCA, New York, N. Y. (340.7m-880kc), 6 p. m., Olet Vail and his Hotel McAlpin string ensemble; 6:30, Parody orchestra; 7, Jack Denny's orchestra; 7:30, Twin Oaks orchestra; 7:45, Arthur West Sirens; 8, Snedden Weir, baritone; 10:15, McAlpin News Editor; 10:30, Tango Palace orchestra; 11, Erule

Blanchard's dance orchestra; 8:30 Top O'Houston concert.
KSD, St. Louis, Mo. (545.1m-550kc), 7 p. m., WEAF; 7:30, Esmeralda Berry Mayes, pianist; 8, WEAF; 9, WEAF.
KSO, Clarinda, Iowa (241.9m-1240kc), 7-8 p. m., Baker and Anderson; 8-9:30, J. D. Mosbarger, Grant City, Mo.
KTHS, Hot Springs National Park, Ark. (374.8m-800kc), 9-9:30 p. m., classical concert, Eastman hotel orchestra; 9:30-10, sacred program, Central Methodist church; 10-10:30, New Arlington hotel dance orchestra.
KWWG, Brownsville, Texas (278m-1080kc), 6 p. m., Roy Garcia, violinist; 8:30, Choral club, Texas State Teachers college.
KYW, Chicago, Ill. (535.4m-560kc), 12:05-1 p. m., noon-day concert, Commonwealth Edison company; 1-2, luncheon concert, Congress hotel; 4, afternoon frolic; 6-7, dinner music; 8, music hour; 10-12, evening at home; Coon-Sanders Original Night Hawks; 1-2 a. m., Insomnia club.

WAMD, Minneapolis, Minn. (244m-1230kc), 12:15 p. m., Twin City Hoo-Hoo club banquet and luncheon; 6:15, dinner concert, George Osborn and his orchestra; 7:10, special musical program.
WBAP, Ft. Worth, Texas (475.9m-630kc), 12:05-12:30 p. m., Ward's "Trail Blazers"; 6-6:30, dinner music; 7:30-8:30, concert of vocal and piano numbers; 9:30-11, Henslee and Simons, popular tunes; Sybil Wray, accompanist; 11, varied program.
WBBM, Chicago, Ill. (226m-1330kc), 4-6 p. m., Sandy and Harry, William Dalton, baritone; Irene Beasley; Sidney Neman; Russell Moore; Jack Penewell and Freddy Palmier; 8-10, Barber Shop, Jack Crawford's orchestra; Ziegler sisters; Arlston; Two Jays; Charlie Garland; Maurice Silverman; Pauline Stiffler Atlas, violinist; Floyd Falch; 10-12 midnight, Harry and Sandy; Moulton Rouge orchestra; Harry Brailford, mandolinist; Pearl Jarret, pianologue; Fred Jacobson; stars, Moulton Rouge cafe.
WCAL, Northfield, Minn. (336.9m-890kc), 7 p. m., Norwegian Lutheran church.
WCBD, Zion, Ill. (344.6m-870kc), 8 p. m., Zion orchestra, male quartet; Florence Hill, soprano; Mildred Donovan, contralto; Robin Bull and E. Paxton, duettists; John Thomas, baritone.
WCCO, Minneapolis-St. Paul, Minn. (416.4m-720kc), 12 noon, concert, Donaldson's orchestra; 2 p. m., among the musicians; 7, WEAF; 7:30, musical program; 8, WEAF; 10:20, Marigold Gardens dance orchestra.
WDAF, Kansas City, Mo. (365.6m-820kc), 3:30-4:30 p. m., The Star's string orchestra; 6-7, Trianon ensemble; 11:45-1 a. m., Ted Weem's Victor Recording orchestra; Ted Meyn, pianist; Billy Adair's orchestra.
WDBH, Chicago, Ill. (322.2m-810kc), 3-4 p. m., musical hits, Uptown theater; 7-8, special recital; 9-9:45, Oriole dance orchestra; 12-12:30 a. m., Oriole dance orchestra, artists.

WFAA, Dallas, Texas (475.5m-630kc), 4:30-5 p. m., MacDowell Sisters; 6:30-7:30, Baker hotel orchestra; 8:30-9:30, Mrs. LaRue Nelson.
WGES, Oak Park, Ill. (250m-1200kc), 5-7 p. m., twilight concert; 8-9, orchestra; 11-1, Evans Lloyd, composer.
WGN, Chicago, Ill. (302.8m-990kc), 12:40-2:30 p. m., Drake concert ensemble, Blackstone string quintet; 2:30-3, Lyon and Healy artists; 3:30-4:15, Tea Time music, Marshall Field's ten room orchestra; 4:30-5, organ recital, Edward Benedict; 6:30-6:45, Drake concert ensemble, Blackstone string quintet; 6:45-7, old-time favorites; 8-9, WEAF; 9-10, WEAF; 10-10:10, Sam 'n' Henry; 10:20-10:40, the playshop; 10:40-11, popular program.
WGST, Atlanta, Ga. (270m-1110kc), 7-8 p. m., Mrs. G. E. Cooper, contralto.
WHAD, Milwaukee, Wis. (275m-1090kc), 6:15-7 p. m., Bill Benning's Milwaukee Athletic club orchestra; 10:30, popular orchestra selections.
WHAS, Louisville, Ky. (399.8m-750kc), 1-2 p. m., concert, Benson trio; 3:30-4, special music; 4-5, concert; 7:30-9, concert.
WHB, Kansas City, Mo. (365.6m-820kc), 7-7:30 p. m., dinner hour, organ concert, Morrill Moore; 8-9, R. C. Hopkins, contralto; Louis Downey, tenor; Gaily King, soprano; Josephine and Louise Maxwell, cornetists; "College Days," musical playlet; 9-9:30, quartet; 9:30-10, ukulele songsters, Harry Taylor and Sam Martin.
WHO, Des Moines, Iowa (526m-570kc), 7:30-8 p. m., Raleigh quintet; 8-9, Bankers Life trio; 11-12 noon, Bankers Life Corn Sugar orchestra.
WHT, Chicago, Ill. (389.6m-750kc), 12 m., Al Carney's complimentary organ recital; 6, dinner organ recital, Al Carney; 6:30, Hugh Ashpwall, tenor; Grayling's string trio; 6:45, Swedish program; 9:15, Cinderella Cafe orchestra; 9:30, Kitcher, Klenzer-Kidder; 9:30, Jack Turner, singer; Jack Marshall, pianist; 10:10, U. S. L. entertainers; male quartet; 11:30, Pat Barnes and Al Carney; 12, Pat Barnes and Al Carney.
WIJD, Mooseheart, Ill. (370.2m-810kc), 2-3 p. m., Howard L. Peterson, organist; 4-5, music, children; 5:30-7, Jack Nelson; Palmer House symphonic players; Howard L. Peterson, organist; Palmer House Victrolans; Salvation Army band; 12:30 a. m., Palmer House Victrolans; Jack Nelson.
WKAF, Milwaukee, Wis. (261m-1150kc), 8:30-10 p. m., Trilzie Ann Troy and her Royal Hawaiians; Arthur Herschel, Italian character study.
WKRC, Cincinnati, Ohio (325.9m-920kc), 10 p. m., Eugene Perazzo, organist; 10:30, Swiss Garden program; 11, popular songs; 11:15, Marlon McKay and his orchestra.
WLIB, Chicago, Ill. (302.8m-990kc), 7-7:20 p. m., Uncle Walt's Punch and Judy show; 7:20-7:30, Correll and Gosden; 7:30-8, WEAF; 11-11:20, Correll and Gosden; 11:20-11, dance music; Correll and Gosden.
WLS, Chicago, Ill. (344.6m-800kc), 6 p. m., WLS trio; 6:40, Ralph Emerson, organist; 7, Ford and Glenn; 7:15, WLS staff concert; 7:55, Kobay and Sirlinsky, violinist; Goldie Gross, cellist; Doris Wittich, pianist.
WLW, Cincinnati, Ohio (422.3m-710kc), 4 p. m., piano recital, Adelaide Apfel; 6:15, musical handshakes, Bob Groenke and Jim Mischler, the original Crosby Hello Boys; 7, Hotel Gibson orchestra; 9, Ohio high school band; 9:45, songs, Marguerite Bentall, contralto; 10:05, popular concert, Doherty Melody boys; 11, "The Boys from Home," Ray West and Gordon Buchanan; 11:30, Don Bestors dance orchestra; 12:15 midnight, Night Howls, Crosby Sky Terriers.
WMAQ, Chicago, Ill. (447.5m-670kc), 2 p. m., Shut-in program; 4:45, pupils, Maclean college; 6, Chicago theater organ; 6:30, Hotel La Salle orchestra; 9:30, Mrs. Clara Scheville, soprano.
WMBB, Chicago, Ill. (250m-1200kc), 7-8 p. m., Hungarian music; 9-11, Trianon orchestra; Woodlawn theater orchestra; Scotty Welsh, Madison Sisters; Golden Harmony trio; Lucille O'Hara, soprano; Tommie Hughes, baritone.
WMC, Memphis, Tenn. (499.7m-600kc), 8:45 p. m., Cortese ensemble.
WQAI, San Antonio, Texas (394.5m-760kc), 8:30 p. m., Mistletoe Melody Mads.
WOAW, Omaha, Nebr. (526m-570kc), 12:45 p. m., Gilbert Jaffy and his orchestra; 4:15, Adams' orchestra; 6, Dorothy Chenoweth Lowden, harpist; E. M. Mills, trumpeter; 6:20, Manna Kea trio; 6:50, Randall's Royal Fontenelle orchestra; 12 midnight, Roseland Radio Frolic.
WOC, Davenport, Iowa (483.6m-620kc), 5:45-6 p. m., chimes concert; 7-7:30, musical program, WEAF; 7:30-8, musical program; "The Moline Plow Boys"; 8-9, WEAF; 9-10, WEAF; 11-12, orchestra program, Le Claire hotel orchestra; Peter MacArthur, baritone.
WOL, Ames, Iowa (270m-1110kc), 12:30 p. m., college chimes; 7:50, Ames high school orchestra.
WOK, Chicago, Ill. (217.3m-1300kc), 4:30-7 p. m., Capitol theater organ; program; 10-10:30, Tearful town club orchestra; Carl Lorraine's Pershing Palace orchestra; Husk O'Hare's Coccanut Grove orchestra; Capitol theater program.
WORD, Batavia, Ill. (275m-1090kc), 8 p. m., Webster hotel concert trio; 8:30, Cosmopolitan school of music program.
WQI, Chicago, Ill. (447.5m-670kc), 7-8 p. m., Boston

EDUCATIONAL FEATURES

Saturday, March 13

Eastern	Central	Mountain	Pacific
7:30 p. m.	6:30 p. m.	5:30 p. m.	4:30 p. m.
WEAR (275m-1090kc) Lecture period			
8:15	7:15	6:15	5:15
KOIL (278m-1080kc) Educational period, University of Omaha.			
10:10	9:10	8:10	7:10
WNYC (526m-570kc) Board of Education talk.			

Monday, March 15

Eastern	Central	Mountain	Pacific
6:30 p. m.	5:30 p. m.	4:30 p. m.	3:30 p. m.
WNYC (526m-570kc) German lesson.			
6	5	4	3
WEAF (491.5m-610kc) Columbia university lecture.			
WNYC (526m-570kc) Advanced German lesson.			
7:30	6:30	5:30	4:30
WEAO (293.9m-1020kc) "Mining Engineering," Prof. H. E. Nold.			
8	7	6	5
KFKU (275m-1090kc) "Capital Savings in 1925," Prof. J. W. Strenberg.			
8:15	7:15	6:15	5:15
KDKA (309.1m-970kc) University of Pittsburgh address.			
WSUI (483.6m-620kc) College of the Air.			
8:40	7:40	6:40	5:40
KFKU (275m-1090kc) "How Earth History is Recorded," Dr. R. C. Moore.			
9:30	8:30	7:30	6:30
WHAZ (379.5m-790kc) Address, Dr. Matthew A. Hunter.			
9:35	8:35	7:35	6:35
KSL (299.8m-1000kc) Mineralogy and Metallurgy.			
10	9	8	7
KOA (322.4m-930kc) Spanish lesson.			
10:30	9:30	8:30	7:30
KWSC (348.6m-860kc) Chemistry in the Service of Man, Prof. J. L. Culbertson.			
11	10	9	8
KOA (322.4m-930kc) Voice culture.			
11:50	10:50	9:50	8:50
KGO (361.2m-830kc) "Better English," Wilda Wilson Church; "The New and Old in the Reconstruction," Dr. Willard Smith.			
12:15	11:15	10:15	9:15
KGO (361m-830kc) Character training in the home.			

Tuesday, March 16

Eastern	Central	Mountain	Pacific
5 p. m.	4 p. m.	3 p. m.	2 p. m.
WLW (422.3m-710kc) French Lesson, Madame Ida Telpmidis.			
6	5	4	3
WKAR (285.5m-1050kc) Nature study.			
WLW (422.3m-710kc) Historical appreciation of music, Eteka Evans.			
7:10	6:10	5:10	4:10
WEAF (491.5m-610kc) French course.			
WRC (468.5m-640kc) Radio school of international relations.			
7:30	6:30	5:30	4:30
KSAC (340.7m-880kc) Better speech, etiquette, economics.			
WEAF (491.5m-610kc) Educational Course, Edw. E. Whitting.			
WGY (379.5m-790kc) "Organic Evolution," Prof. James W. Mayor.			
7:45	6:45	5:45	4:45
WTAG (268m-1120kc) Worcester Tech's Professor.			
8:15	7:15	6:15	5:15
KDKA (309.1m-970kc) "How the School Affects Character," Prof. Albert J. Murphy.			
8:20	7:20	6:20	5:20
WLW (422.3m-710kc) Crosley science lecture, George Parker.			
9:15	8:15	7:15	6:15
WMCA (340.7m-880kc) Palmer pen lesson.			
10	9	8	7
KPAU (280m-1070kc) Public speaking lesson, Rev. Cunningham.			
WMAQ (447.5m-670kc) lecture, University of Chicago.			
WOC (483.6m-620kc) Travel lecture, "Around the World in Eight Months in Eight Nights," B. J. Palmer.			

Thursday, March 18

Eastern	Central	Mountain	Pacific
7 p. m.	6 p. m.	5 p. m.	4 p. m.
WKAB (285.5m-1050kc) Nature Study series.			
7:30	6:30	5:30	4:30
KSAC (340.7m-880kc) Music, educational psychology.			
8	7	6	5
WEAO (293.9m-1020kc) "Color and Color Problems," Prof. Howard D. Minchin.			
WRC (468.5m-640kc) Smithsonian talk.			
WGST (270m-1110kc) "What Does Ceramics Mean to Georgia," Prof. W. H. Vaughan.			
8:30	7:30	6:30	5:30
WEAO (293.9m-1020kc) "Illumination," Prof. F. C. Caldwell.			
WLW (422.3m-710kc) Zoo talks.			
8:45	7:45	6:45	5:45
KLDS (441m-680kc) Music appreciation, Prof. Arthur Mills.			
KUOA (299.8m-1000kc) lectures, University Extension.			
10	9	8	7
WMAQ (447.5m-670kc) lecture, University of Chicago.			
11	10	9	8
WSAI (325.9m-920kc) University of Cincinnati.			

Friday, March 19

Eastern	Central	Mountain	Pacific
4 p. m.	3 p. m.	2 p. m.	1 p. m.
KFAB (340.7m-880kc) Science lectures.			
5:30	4:30	3:30	2:30
KSAC (340.7m-880kc) Lessons in color and design.			
WCAP (468.5m-640kc) Science talk.			
6:30	5:30	4:30	3:30
WNYC (526m-570kc) French lesson.			
7	6	5	4
WKAR (285.5m-1050kc) Nature study series.			
WNYC (526m-570kc) Advanced French.			
7:30	6:30	5:30	4:30
WEAF (491.5m-610kc) "Recent Development in Economics," Prof. Thomas N. Carver.			
KSAC (340.7m-880kc) Travelogue.			
7:45	6:45	5:45	4:45
WJZ (454.3m-660kc) New York university.			
8	7	6	5
WPG (299.8m-1000kc) Educational series.			
KDKA (309.1m-970kc) University of Pittsburgh address.			
8:15	7:15	6:15	5:15
WCAU (277.6m-1080kc) chiropractic talk.			
9	8	7	6
WMAQ (447.5m-670kc) lecture, University of Chicago.			
10:10	9:10	8:10	7:10
WNYC (526m-570kc) Board of Education.			
10:15	9:15	8:15	7:15
WOC (483.6m-620kc) Travel lecture.			
10:45	9:45	8:45	7:45
KOAC (280.2m-1070kc) "Earth's Place in the Universe," D. C. Livingston.			

Saturday, March 20

Eastern	Central	Mountain	Pacific
6 p. m.	5 p. m.	4 p. m.	3 p. m.
KGO (361.2m-830kc) Speaker from Williams institute.			

Sunday, March 21

Eastern	Central	Mountain	Pacific
10:30	9:30	8:30	7:30
Irving Firstenberg; 10:45, Katherine Adolph; 11, Piotti and Val, vocalists; 11:15, Frankie Meadows; 11:30, Strickland's orchestra; 12:2 a. m., midnight frolic.			

Monday, March 22

Eastern	Central	Mountain	Pacific
7:30	6:30	5:30	4:30
WGHB, Clearwater, Fla. (266m-1130kc), 6:30-7:30 p. m., dinner music; 8:30-9:30, Bill Ewin and L. W. Joy, piano and vocal team; 11:45-1, midnight ramble.			
WGHP, Detroit, Mich. (270m-1110kc), 6-7 p. m., dinner concert; 10-11, Skylark dance band; Harry Hayes, banjoist; Dick Quinlan, saxophonist; 11-12, WGHF frolicers; 12-1 a. m., Gerald Marks and his orchestra.			
WGR, Buffalo, N. Y. (319m-940kc), 2:30 p. m., WGR's afternoon program; 6:30, Vincent Lopez Hotel Statler dance orchestra, Harold Gleser, director; 8, WEAF; 9, WEAF.			
WGY, Schenectady, N. Y. (379.5m-790kc), 2 p. m., music; 6:30, Ten Eyck trio; 9, Royal Salon orchestra; WJZ; 10, orchestra; 11:30, organ recital, Stephen E. Boisclair.			

Tuesday, March 23

Eastern	Central	Mountain	Pacific
7:30	6:30	5:30	4:30
WHAR, Atlantic City, N. J. (275m-1090kc), 2 p. m., Seaside hotel trio; 8, Seaside hotel trio; 9, studio concert; 11, Follies Bergere dance orchestra.			
WHN, New York, N. Y. (361.2m-830kc), 12:30 p. m., Lexington organ recital; 1, Loew's Metropolitan theater orchestra; 3:15, Lexington orchestra; 6, Treasureland Neighbors; 6:30, People's hour; 7, Iceland orchestra; 7:30, Creole Follies; 8, Will Oakland's Chateau; 9, Loew's New York Roof orchestra; 11, Joe Ward's Swane entertainers; 11:30, Everglades orchestra; 12 midnight, Van and Schenck from the Parody club.			

Wednesday, March 24

Eastern	Central	Mountain	Pacific
1 p. m.	12:30 p. m.	11:30 a. m.	10:30 a. m.
WIP, Philadelphia, Pa. (508.2m-590kc), 1 p. m., Gimbal Tea Room orchestra; 3, artist recital, Combs Conservatory of Music; 6:05, Pagoda cafe orchestra; 7, songs by Eleanor Taylor; 8:15, American Legion night, Howard McCall Trio; 10:05, Nelson Maples and his S. S. Levitahian dance orchestra.			
WJR, Pontiac, Mich. (526.9m-580kc), 7 p. m., Jean Goldkette's symphony orchestra; soloists; 9, Jean Goldkette's orchestra; 10, Jean Goldkette's Victor Recording orchestra.			
WJZ, New York, N. Y. (454.3m-660kc), 9 p. m., Royal Typewriter salon orchestra; 10:15, A. Bernard, Frank Kamplian, Sammy Stept, the Record boys.			
WLIT, Philadelphia, Pa. (394.5m-760kc), 12:02 p. m., Stanley theater organ recital; Arcadia cafe concert			

Thursday, March 25

Eastern	Central	Mountain	Pacific
10:30	9:30	8:30	7:30
Golden and his Hotel McAlpin orchestra; 12 midnight, McAlpin entertainers.			
WNYC, New York, N. Y. (526m-570kc), 7:10 p. m., piano selections; 8 p. m., piano duets; 8:30, violin recital; 9, song recital; 9:30, banjo duets; 10, songs.			
WOO, Philadelphia, Pa. (508.2m-590kc), 11 a. m., organ recital; 12:02 p. m., Golden's crystal tea room orchestra; 4:45, organ recital; 7:30, Adelphia dinner dance orchestra.			
WOR, Newark, N. J. (405.2m-740kc), 6			

ORATORIO BY APOLLO CLUB AT WLS

Thursday, March 18

store hour; concert trio, violin, cello and piano; Ray McKay, baritone; 10-11 a. m., Jack Chapman and his Rainbo Skylarks; Jerry Sullivan; Rose Vanderbosch, soprano, pianist; Hal Lansing and his uke; Lew Butler, Bert Davis; Marie Pollitt, Anne Keim, mezzo-soprano; artists; 1-2, Goller hour, Jack Chapman the Ginger Man and Little Skylarks.

WSAI, Cincinnati, Ohio (325.9m-920kc), 7 p. m., musical program; 7:30, Hires Harvesters; 8, Cliequot Club Eskimos; 9, Silvertown Cord orchestra.

WSB, Atlanta, Ga. (428.3m-700kc), 8 p. m., Rich's glee and mandolin club; 10:45, Charles Sheldon Junior organ recital.

Mountain Time Stations

CFAC, Calgary, Canada (435.8m-688kc), 9-11 p. m., Canadian National railways program; C. N. R. orchestra, assisted by Gerald Fitzgerald, tenor.

CNRC, Calgary, Can. (435.8m-688kc), 9 p. m., studio program, Canadian National Railways orchestra; Gerald Fitzgerald, tenor.

KFAU, Boise, Idaho (280.2m-1070kc), 8 p. m., Kelly club entertainers.

KXFF, Colorado Springs, Colo. (250m-1200kc), Bertram T. Wheatley, pianist; Mrs. Bertram T. Wheatley, soprano; Fritz Funk, violinist.

KFWA, Ogden, Utah (261m-1150kc), 4-5 p. m., organ recital, Paramount theater; 5-6, Radio dealers program.

KOA, Denver, Colo. (322.4m-930kc), 12:15 p. m., Marjorie Nash, organist; 6:30, dinner concert, Brown Palace string orchestra.

KUOM, Missoula, Montana (244m-1230kc), 8 p. m., Irish music, Mrs. Kathleen Walford.

Pacific Time Stations

KFI, Los Angeles, Calif. (467m-640kc), 5:30-6 p. m., Paekard Six dance orchestra; 6, Nightly Doings; 6:30, vest pocket program; 6:45, Radiatorial period; 7-8, program, students University of Southern California; 8-9, Clara Belle Patton Wallace, contralto; 9-10, program, Chickering hall; 10-11, Jose Arias and his Mexican orchestra.

KFON, Long Beach, Calif. (232.4m-1280kc), 6-6:30 p. m., Barton's theater organ; 6:30-7, amusement information; 7-7:30, Spanish lesson; 7:30-8, municipal band concert; 8, book chat; 8:15-9, Long Beach municipal band; 9-10, studio program.

KFWB, Hollywood, Calif. (252m-1190kc), 6-7 p. m., dinner music, Fitzgerald Music company; 8-9, program, Corduroy Tire company; Corduroy Tire orchestra; Albert Kegivich, violinist; Estelle Shake, blues singer; 9-10, program, Don P. Smith, Inc., Diana-Moon orchestra, Sol Hoopii's Hawaiians and Ashley Sisters, vocal duets; 10-11, Warner Brothers' frolic.

KGO, Oakland, Calif. (361.2m-830kc), 11:30-1 p. m., luncheon concert; 4-5:30, concert orchestra; 8, Oakland studio, four one-act plays; 10-11 a. m., dance music, Brokaw orchestra.

KGW, Portland, Ore. (491.5m-610kc), 12:30-1:30 p. m., concert, First National bank and the Security Savings and Trust Co.; 6-7, concert, Olds, Wortman and King company; 8-9, concert, vocal and instrumental; 9-10, vaudeville hour.

KHJ, Los Angeles, Calif. (405.2m-740kc), 8-10 p. m., program, Jell Well Desart company; 10-11, Don Clark's Biltmore hotel dance orchestra.

KJR, Seattle, Wash. (389.4m-780kc), 7-8:30 p. m., Eureka mixed quartet; 8:30-10, Pugeset Sound Savings and Loan association orchestra; 10:30-12, Post Intelligence meeting of the "Keep Joy Radiating Order of Bats."

KMTR, Hollywood, Calif. (238m-1260kc), 6-7 p. m., Starr Piano company studio; 8-10, KMTR concert orchestra, Loren Powell, director.

KNX, Hollywood, Calif. (336.9m-890kc), 5:30 p. m., Leighton's cafeteria orchestra; 6:30-7, Atwater Kent orchestra; 7-8, program, H. L. Crockett company; 8-9, program, Willys-Overland dealers; 9-10, KNX feature program; 10-11, Frazier's Mountain Park's program; 11-12, Ambassador hotel dance orchestra.

KPSN, Pasadena, Calif. (315.6m-950kc), 8-9 p. m., Pasadena Chamber of Commerce orchestra.

KTAB, Oakland, Calif. (240m-1250kc), 9-9:30 a. m., prayer service; 12-1, luncheon concert; 8-10, program.

Friday, March 19

Headliners Today

Eastern	Central	Mountain	Pacific
7:30 p. m.	6:30 p. m.	5:30 p. m.	4:30 p. m.
WBAP (475.9m-630kc)	Ford's Texas Trumpeters.		
WAHG (315.6m-950kc)	Harold Gleason, organist.		
WBAL (246m-1220kc)	Traditional Negro music.		
WAMD (244m-1230kc)	Two operettas.		
WHO (526m-570kc)	Garber Family entertainers.		
WSB (428.3m-700kc)	Merry Makers orchestra.		
WLS (344.6m-870kc)	"Elijah."		
WEBH (370.2m-810kc)	Dennis Sisters.		
WEAB (389.4m-770kc)	Welsh program.		
WTIC (475.9m-630kc)	Entertainers, Black and White revue.		
11	9	8	
KPO (428.3m-700kc)	Metropolitan quartet.		
11:30	10:30	9:30	8:30
WOC (483.6m-620kc)	"A Step On the Stairs," Radio drama.		
12	11	10	9
KFWB (252m-1190kc)	Original Country Boys.		

Friday, silent night for: CFAC, CHIC, CKNC, CKY, CNRC, CNRM, CNRO, CNRR, CNRW, KFAU, KFEQ, KFKU, KFWA, KXFF, KGO, KFAU, KLDK, KPRC, KUOA, KUOM, PWX, WBBR, WCAD, WCBW, WEOA, WEBW, WGBS, WGST, WHAZ, WIP, WIJZ, WKRC, WLW, WLWL, WMAK, WNAW, WRC, WREO, WRVA, WSAI, WSMB, WSUI, WTAM.

Eastern Time Stations

CNRA, Moncton, Can. (291.1m-1030kc), 8 a. m., studio program, St. John artists; Bernice Sponey, soprano; Vida Waterbury, baritone; J. Harold Gillis, baritone; Felix McMullin, bass; Maunsel O'Neill, violinist; Dr. O. Comeau, pianist; 10, orchestra.

CNRT, Toronto, Can. (356.9m-840kc), 6:30 p. m., dinner concert, Luigi Romanelli and his King Edward hotel concert orchestra; 9, choir and organ recital; Trinity choir; 11, dance program, Luigi Romanelli and his King Edward hotel dance orchestra.

KDKA, Pittsburgh, Pa. (309.1m-970kc), 12:20 p. m., Sunday School lesson; 6:30, dinner concert; 9, concert; 10:10, Teaberry time.

WAHG, Richmond Hill, N. Y. (315.6m-950kc), 12 noon, Lenten services; 8 p. m., Harold Gleason, organist; 9, Royal H. Whitmyer, tenor; 9:15, Mischa B. Tulin, pianist; 9:40, Royal H. Whitmyer, tenor; 10, Richard Donzino, violinist; 10:30, Southland dance orchestra.

WBAL, Baltimore, Md. (246m-1220kc), 6:30-7:30 p. m., WBAL dinner orchestra; 7:30-8, male quartet; 8-9, musical program; concert, Negro music by mixed chorus; 9-10, WBAL string trio; John Wilbourn, tenor.

WBZ, Springfield, Mass. (333.1m-900kc), 8:30 p. m., Hotel Kimball orchestra; 8, musical program; 8:30,

GENERAL TALKS AND SPEECHES

Saturday, March 13

Eastern	Central	Mountain	Pacific
1:45 p. m.	12:45 p. m.	11:45 a. m.	10:45 a. m.
WHAR (275m-1090kc)	Lenten talk.		
2:30	1:30	12:30	11:30
WOR (405.2m-740kc)	"George Meredith," B. P. Adams.		
7	6	5	4
WDAE (365.5m-820kc)	"Military Engineering," Col. E. M. Stayton.		
7:55	6:55	5:55	4:55
WFAA (475.9m-630kc)	"Coins and Coinage," W. A. Philpott.		
8	7	6	5
WEAF (491.5m-610kc)	"Getting the Best Out of Sculpture," Prof. John Shapley.		
8:30	7:30	6:30	5:30
WGBS (315.6m-950kc)	Clifford Chesley, philosopher.		
WCCO (416.4m-720kc)	"Fireside Philosophies," Rev. Roy L. Smith.		
9:30	8:30	7:30	6:30
WCAL (336.9m-890kc)	"With the Great Masters," Dr. C. A. Mellby.		
9:45	8:45	7:45	6:45
KHJ (405.2m-740kc)	History story, Prof. Hertzog.		
10:10	9:10	8:10	7:10
WNYC (526m-570kc)	Travel talk.		
10:30	9:30	8:30	7:30
WMCA (340.7m-880kc)	Readings, Norunan Pearce.		

Monday, March 15

Eastern	Central	Mountain	Pacific
1:45 p. m.	12:45 p. m.	11:45 p. m.	10:45 p. m.
WHAR (275m-1090kc)	Lenten talk, Rev. James Lord.		
5	4	3	2
WCCO (416.4m-720kc)	Reader's club, Mrs. Walter Stevens.		
7	6	5	4
WBZ (333.1m-900kc)	"Theatrical Gossip," Sam Wren.		
WDAE (365.5m-820kc)	Address, Edgar A. Linton.		
WRC (468.5m-640kc)	"Show Shopping," Leonard Hall.		
WTAG (268m-1120kc)	Science talk, Fred D. Aldrich.		
7:30	6:30	5:30	4:30
KSAC (340.7m-880kc)	opportunity talks.		
WAHG (315.6m-950kc)	"The Romance of Picture Taking," Harry Baker.		
7:40	6:40	5:40	4:40
WOAW (526m-570kc)	Insurance talk.		
WOR (405.2m-740kc)	"Current Topics," H. V. Kaltenborn.		
8:30	7:30	6:30	5:30
WPG (299.8m-1000kc)	Health talk.		
8:40	7:40	6:40	5:40
WPC (299.8m-1000kc)	"Birds and Their Habits," Alice Yardley.		
8:45	7:45	6:45	5:45
WEAF (491.5m-610kc)	Tower health talk.		
8	7	6	5
WAHG (315.6m-950kc)	talk, Major Dent Atkinson.		
WBAL (246m-1220kc)	Talk, Dr. David M. Robinson.		
WMCA (340.7m-880kc)	Christian Science Lecture, Gavin W. Allan.		
9:30	8:30	7:30	6:30
KUOA (299.8m-1000kc)	Better home talks.		
10:30	9:30	8:30	7:30
KXFF (250m-1200kc)	"Colorado's Sunshine and High Altitude for Invalids," Gilbert McClurg.		
10:45	9:45	8:45	7:45
KRHS (374.8m-800kc)	"Hot Springs," F. Leslie Body.		
11:25	10:25	9:25	8:25
KGO (361.2m-830kc)	"Chats About New Books," Joseph Henry Jackson.		

Tuesday, March 16

Eastern	Central	Mountain	Pacific
1:45 p. m.	12:45 p. m.	11:45 a. m.	10:45 a. m.
WHAR (275m-1090kc)	Lenten talk, Rev. Henry M. Mellen.		
2:30	1:30	12:30 p. m.	11:30
WHAR (275m-1090kc)	"Glimpes Through the Stage Door," Mort Eiseeman.		
3	2	1	
KMA (252m-1190kc)	Travelogue, G. H. Van Houten.		
4:30	3:30	2:30	1:30 p. m.
WCCO (416.4m-720kc)	"The World of Books," H. A. Bellows.		
6:30	5:30	4:30	3:30
WEI (348.6m-860kc)	Talk, C. S. BIRD.		
6	5	4	
WDAE (365.5m-820kc)	Road talk.		
WDAW (526m-570kc)	Sports talk, Ivan L. Gaddis.		
7:50	6:50	5:50	4:50
WGHP (270m-1110kc)	Band talk, Raymond H. Berry.		
8	7	6	5
WHAR (275m-1090kc)	"Glimpses Through the Stage Door," Mort Eiseeman.		
8:15	7:15	6:15	5:15
WIP (508.2m-590kc)	"Mother's Day Movement," Anna Jarvis.		
8:30	7:30	6:30	5:30
WHAS (399.8m-750kc)	Thrill talk, Prof. George E. Ragsdale.		
8:50	7:50	6:50	5:50
WLW (422.3m-710kc)	"Why Go to College?" Dean Frank W. Chandler.		
9	8	7	6
WJJD (370.2m-810kc)	Talk, Matthew P. Adams.		
WMAQ (447.5m-670kc)	Book talk, Harry Hansen.		
9:15	8:15	7:15	6:15
KNX (336.9m-890kc)	Travel talk, W. F. Alder.		
9:20	8:20	7:20	6:20
WMAQ (447.5m-670kc)	Travel talk.		
9:35	8:35	7:35	6:35
KJR (384.4m-730kc)	"Motorlogues," Motor Service Co.		
9:45	8:45	7:45	6:45
KHJ (405.2m-740kc)	History story, Prof. Hertzog.		
10:30	9:30	8:30	7:30
CNRY (291.9m-1030kc)	Health talk, Dr. O. S. Parrett.		
KXFF (250m-1200kc)	"Colorado's Sunshine and High Altitude," Gilbert McClurg.		
WCCO (416.4m-720kc)	"Outdoors in Minnesota,"		
10	9	8	7
KGW (491.5m-610kc)	Book review; word-cartoon on styles.		
12	11	10	9
KGO (361.2m-830kc)	"Wonders of the Sky," Henry M. Hyda.		

Wednesday, March 17

Eastern	Central	Mountain	Pacific
5 p. m.	4 p. m.	3 p. m.	2 p. m.
WCCO (416.4m-720kc)	Readers' club.		
6	5	4	
WCAP (468.5m-640kc)	"Matters Before the House," Congress discussion.		
WDAE (365.5m-820kc)	Health talk; meat talk.		
WEI (348.6m-860kc)	Automotive extension lesson, John Burns.		
6	5	4	
ESO (241.8m-1240kc)	Health talk, Dr. E. W. Ireland.		
WEOA (295.9m-1020kc)	"Telephone Service," Prof. C. A. Wright.		

Eastern	Central	Mountain	Pacific
8:05 p. m.	7:05 p. m.	6:05 p. m.	5:05 p. m.
WAMD (244m-1230kc)	"What Prominent Outsiders Think of Minneapolis and the Great Northwest."		
8:15	7:15	6:15	5:15
WJZ (454.3m-600kc)	Zoological society series.		
8:30	7:30	6:30	5:30
CNRM (410.7m-730kc)	"Sidelights on St. Patrick's," E. J. Millaly.		
WBAO (293.9m-1020kc)	"Collection Practice and Correspondence," Prof. Felix Hold.		
WHAS (389.8m-750kc)	Talk, Joseph Burge.		
9	8	7	6
WLWL (288.3m-1040kc)	Talk, K. of C.		
9:30	8:30	7:30	6:30
KGO (361m-830kc)	The Workman's Education.		
WMAQ (447.5m-670kc)	Association of Commerce talk.		
9:45 p. m.	8:45 p. m.	7:45 p. m.	6:45 p. m.
KHJ (405.2m-740kc)	History story, Prof. Hertzog.		
10:30	9:30	8:30	7:30
KOAC (280.2m-1070kc)	"Is Your Daughter Going to College?" Florence Blazer.		
11	10	9	8
KHJ (405.2m-740kc)	Talk on astronomy, Dr. Mars Baungardt.		

Thursday, March 18

Eastern	Central	Mountain	Pacific
1:45 p. m.	12:45 p. m.	11:45 a. m.	10:45 a. m.
WHAR (275m-1090kc)	Lenten talk, Rev. Harold G. Gaunt.		
5	4	3 p. m.	2 p. m.
KMA (252m-1190kc)	Travelogue.		
6:30	5:30	4:30	3:30
WOR (405.2m-740kc)	Sport talk, Bill Wathey.		
7	6	5	4
WDAE (365.5m-820kc)	Book talk, Louis Mecker.		
WLW (422.3m-710kc)	Golf ebals, Archie Simpson.		
7:30	6:30	5:30	4:30
WGY (379.5m-790kc)	WGY book chat, William F. Jacob.		
WHAR (275m-1090kc)	Book chat.		
7:45	6:45	5:45	4:45
WLW (422.3m-710kc)	"The Eyes Have It," C. H. Hoffman.		
WMCA (340.7m-880kc)	Health talk.		
8	7	6	5
KFKU (275m-1090kc)	"Problems of Stream Pollution," Prof. Ernest Bouce.		
WEOA (293.9m-1020kc)	Flowers, Prof. A. C. Hortes.		
WIP (508.2m-590kc)	"The Sesqui-Centennial," Hon. Harry A. Mackey.		
WPG (299.8m-1000kc)	"World Wonder Excursions," Alfred James P. McClure, D.D.		
WRC (468.5m-640kc)	Smithsonian talk.		
8:15	7:15	6:15	5:15
WSAI (335.9m-920kc)	Art club talk.		
8:30	7:30	6:30	5:30
WGBS (315.6m-950kc)	"Footlight and Lamplight," Oliver Saylor.		
WTAG (268m-1120kc)	Travel talk.		
8:40	7:40	6:40	5:40
KPKU (275m-1090kc)	"Benefits of Zoning," Mr. Harold Smith.		
9	8	7	6
KLOA (299.8m-1000kc)	"Arkansas Rural Electric Lines," W. B. Stalzer.		
WHAS (389.8m-750kc)	Civil Service talk, O. A. Beckman.		
WLWL (288.3m-1040kc)	Talk.		
WMAQ (477.5m-670kc)	"What We Hear in Music," Mr. and Mrs. M. E. Oberdorfer.		
9:15	8:15	7:15	6:15
KNX (336.9m-890kc)	Travel talk, W. F. Alder.		
9:45	8:45	7:45	6:45
KHJ (405.2m-740kc)	History talk.		
10	9	8	7
KUOM (244m-1230kc)	"Principles of Economics at Work," Dr. J. H. Underwood.		

Radio Digest

Illustrated

Reg. U. S. Pat. Off. & Dom. of Canada

Published by the

RADIO DIGEST PUBLISHING CO.,

(Incorporated)

510 North Dearborn Street

Chicago, Illinois

Telephones: Superior 7323, 7324, 7325, 7326, 7327

E. C. RAYNER, Publisher

Eastern Office, Park-Lexington Building, 247 Park Ave.,
New York. Telephones: Ashland, 8144, 8145, 8146

Member of the Audit Bureau of Circulations

241

PUBLISHED WEEKLY

SUBSCRIPTION RATES

Yearly in U. S. and Possessions and Canada, \$5.00

Foreign postage, \$1.00 additional. Single copies, 10 cents.

Vol. XVI Saturday, March 13, 1926 No. 10

What Dare Broadcasters Say?

BECAUSE he broadcast a sermon from Station KFJF, Oklahoma City, in which he attacked Under Sheriff C. W. Friss, of that city, the Rev. Lincoln McConnell has caused the station to be sued by the under sheriff for a mere twenty thousand dollars. Mr. Friss charges in his suit that Reverend McConnell's criticism of his law enforcement methods was entirely too vehement and virulent.

This news item brings an interesting point up for discussion. To what extent are broadcasting stations held accountable for slander and libel? It occurs to us that the same rules apply here as apply to newspapers and periodicals.

Grant Milner Hyde, of the department of Journalism, the University of Wisconsin, has made a careful study of libel as it applies to newspapers. He says:

"The exact nature of libel is an indefinite thing, depending as much upon circumstances and the verdict of the jury as the law, and no newspaper can fulfill its office as dispenser of the news without now and then laying itself open to libel action. It is practically impossible to print all the news; at the time when it should be printed, without running into danger of hurting someone's good name to a damageable extent; but for one libelous statement that results in legal action and recovery, ten as serious go by unnoticed.

"A libelous statement is an untruth that hurts someone's private, professional, or business reputation. The old basis, 'the greater the truth, the greater the libel,' no longer holds good; now only an untrue statement is libelous.

"But all untrue statements are not libelous; they must hurt someone to be libelous.

"Just what constitutes damage to one's character is the question concerned. In general, any statement that holds an individual up to public contempt, ridicule, scorn, or shame, if untrue, is libelous—to accuse him of a loathsome disease or suggest lack of morality or integrity in his business or private life. In the case of a professional man, anything that suggests lack of skill or knowledge, or charge incompetency is libelous, but the statement must 'touch him' in his professional capacity. The same applies to business concerns and enterprises.

"Public officials, while open to criticism in their public capacity, cannot be attacked as private citizens or accused of moral or mental unfitness for office. Criticism must be concerned with their official acts.

"But any of these accusations or implications is harmless of libel if the newspaper can prove it true. When it is untrue, and the victim wishes to retaliate, he can do so only by bringing suit and recovering such damages as the jury thinks are equivalent to the injury he has suffered.

"The case is not decided on the basis of the newspaper's intent or innocence of malice, but on the basis of the injury suffered by the victim. This is true except when the statements may be such as to lead to a 'breach of the peace' and the evident motive results in criminal proceedings against the publisher."

It is obvious as public disseminators of news and thought, broadcasting stations fall within the same class as newspapers. The same libel law should apply. Mr. Hyde defines what libel is and how it can be committed.

The question whether or not Station KFJF has committed libel depends on what Rev. McConnell said. If what he said was true—we have no way of knowing inasmuch as the details of his message are not given—and only the public capacity of Under Sheriff Friss was attacked, it would seem that Mr. Friss will recover nothing.

Another thing Mr. Friss will have to prove, is the exact message of Rev. McConnell. Perhaps he will be able to produce in court stenographic copies of the broadcast as received and witnessed by reliable witnesses. This certainly will be necessary before he can hope to prosecute his suit.

The Friss vs. KFJF suit should be watched with interest by broadcasting stations and the public, as the decision reached will seriously affect the future of Radio as a medium for the expression of opinion.

RADIO INDI-GEST

Hay! Hay!! Hay!!!

Gee it used ter be real lonesome livin' down here on the farm,
With no kind of real enjoyment to pass the time away,

Especially in the evenin' after all the chores were done,
And you kinda felt all fagged out from a long and tiresome day.

It wasn't much enjoyment or real entertainin' like
When you had to sit and listen to the common lot of talk

About the crops and weather and threshin' crew and such,

Or how the mule that Pa just bought could only eat and balk.

But, gee, it sure is different now since Pa brought home a set

Of Radio, they call it, and strung around some wires.
Well, gosh, we just sit down now and twist some funny knobs

And we can hear real music from orchestras and choirs.

Gee, it sure is wonderful for we can hear all kinds
Of funny talks and speeches and news and gosh it's fun,

It sure ain't tiresome now to sit around the house
In the evenin' after supper when all the chores are done.

RURAL RUBE

Heard Nothing—Was Flaming Mad

Editor Indi-Gest: One of the Eskimo hot mamas, heer in Fairice, has got me puzzled. Every time she lissens to my loud speaker she terns from her lether compleck-shion to a brite red. After she turned to red six times, I lissened to the speaker and herd nothing. I want to know what she herd to make her tern red. Always as ever,
KITTLE DRUMMER

Well, Kittle Drummer, most hot mamas are puzzling, but the ones we HAVE HEARD ABOUT wouldn't even listen to reason, much less a loud speaker. She must have herd (darn it, you've got us doing it) Jack Little's "Then Everything Will Be All Right."

Get Out Your Black Peas

Last Week we nominated Noah for membership in the FAMOUS FANS club because his Ark could handle any wave length. Now come dissenting voices. Eloise R. says he was not so good because water on his masts caused him to be grounded on Mount Ararat.

We might add that he also had too many regenerative sets aboard and as a FAMOUS FAN he was all wet. Anyway one of the family should be included. We nominate Noah's son—he was the first "HAM." Shall we take both or either into the club?

Alice In Blooper Land

Speak gently to the blooper boy,
And beat him when he squeals;
He may not do it to annoy,
Or know just how it feels.

SANTA FE BALDY

Stop Before It Is Too Late

We had to give up the idea of the Call Router described in last week's issue. We forgot that the trains were never on time and the names of the cities hollered by the train caller couldn't catch up with the programs from the different cities. So we have torn up the device and are now going to arrange the parts so the spiel of the train caller can be used on the chain programs.

And No Prescriptions

WASHINGTON, D. C.—It is understood that the governor of North Carolina is anxious to erect a broadcasting station at Raleigh, the capital of the state, which will be owned and operated by the state. At this time there are no wave lengths available for such a station and the department of commerce has so notified the governor.

Let's see now, What is it the governor of North Carolina wants to say to the governor of South Carolina? Oh, yes,—"Its a long time between wave lengths."

Keep In Readiness Yeggs

Students of crime have the opportunity of keeping in touch with crime in greater Cincinnati through the broadcasting of bulletins supplied by the police department. These broadcasts are given through the Crosley WLW station daily at ten-fifteen and four-thirty o'clock. Emergency bulletins are broadcast immediately upon receipt in the studio.—WLW News Bulletin.

Jimmy Valentine announcing. This will most likely avoid some messy affairs and increase the number of perfect crimes. Cooperation between police and apprentices will be assured and will avoid any chance meetings. The emergency bulletins will rectify any mis-carriage of plans. Diplomas will be issued to those who complete the extension course. Graduates will serve internship in Chicago.

Where Have I Seen You Before?

The Secretary of the I Won't Bloop Club handed us a letter he received from VKY, in which VKY said, "I enclose my pledge card properly filled out and I'm in earnest about it. No strangers, not even my wife, can dial around on my set at night."

We shouldn't put that in the column because there was a little note enclosed for us that kinda put us up-stage. Such nice things were said. The boss should know.

INDI

The Changing World

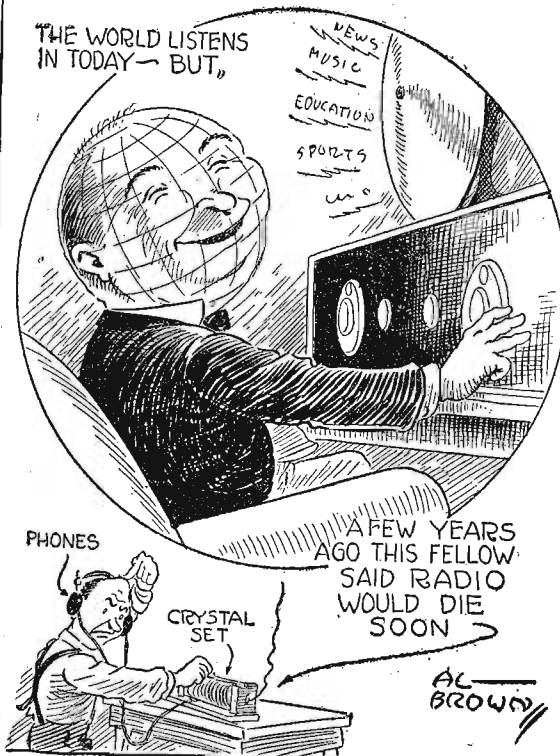

Condensed

BY DIELECTRIC

Another of those attractive feature concerts by the Formica orchestra from the studio of WLW, Cincinnati, brought solace to a discomfited soul seeking escape from the clatter and crashing of static to peaceful musical tones. Some of the selections played were chosen from among the works of Italian composers—assuring melodious music, while later numbers were entirely popular and picked at random from the mass of material at hand supplied by American composers. What matters a mere title, when the magic rhythm of jazz is permeating the silent places to bring to jaded mortals new vim and a chance to move their bodies in contravention to the laws of locomotion. Page the Trombone Player, please.

When you pick out good programs while Old Man Static is spreading himself all over low and high frequencies, you are either on top of the stations broadcasting or mistaking static for snare drums. What I heard the past few nights was static with programs breaking through occasionally. Station WHO, Des Moines, came through with a pleasing program of popular music rendered by the Serenaders, who are familiar to most audiences this station addresses, and erased every vestige of irritation caused in the past—not by these musicians but by other means.

Graham won a cup a few months ago, which the publisher of Radio Digest presented, entitling him to the conviction that he (Graham MacNamee) surpassed all other announcers in the world in most respects. If there is the conviction, there is no evidence of it for he is manifestly striving to improve that perfection in several ways. During the Atwater Kent concert, in which Anna Case sang and Mr. Corliagno pleased with his excellent violin playing, this improvement was noticeable. The interjected remarks were boiled down somewhat, attracting less to himself and more to the artists and their work.

Florida broadcasting stations have been careful to select those slogans which sound the most enticing, for instance, "The Land of Sunshine," by which listeners are introduced to the Jacksonville station, WJAX. The announcer there indulged in that old stall—just a moment please—so vexatious and frequent a short time back. He did it, however, to let his remarks sink in about the superlative attractions of the city. They had a dance orchestra playing, incidentally.

If you never heard Dan Beddoe sing you have missed a musical treat. His tenor voice is most ingratiating and he knows how to use it to touch the heart-strings. He sang the other evening in a program including a very good mixed quartet. The latter attracted at least one high state official, the governor of Pennsylvania, who sent in a request to the station, WSAI, Cincinnati, for them to sing "Abide with Me." Funny I can't seem to find anything to correct in the management of WSAI. Commendation is better.

Among instrumental trios entertaining the Radio public, the Liberty string trio should be given a prominent place. With several other features of interest scheduled for that hour I, for one, stuck to WLW, Chicago, that none of the concert should be missed. All the selections were of a piece—good. Not too heavy, nor yet so sentimental as to be cloying. It is a hard medium to strike, this midway plane. There is nothing to say except pleasantries for the evening's music. Again the announcer comes in for mention.

ABC Radio Fundamentals for Everybody

Chapter X—Radio Receiving Circuits (Cont.)

By Milo Gurney

FOLLOWING Radio's stampede of buying, with the advent of broadcasting, together with the flooding of the market with receivers in which regeneration was intentionally used, came the efforts of several engineers with receiver designs in which intended regeneration was absent, together with arrangements wherein the inherent regeneration within the tubes and their associated wiring was such as to circumvent the regenerative patents.

The earliest efforts along this line were similar to that shown in figure 24. In this circuit, the Radio frequency transformers used were of the untuned type, their design varying from that of the tuned type, in that, in place of having air cores, the design included iron cores. With this method of construction it was quite impossible to tune them to resonance, hence a compromise wave length was selected at which such transformers worked most efficiently, while the broadness of their tuning permitted a fair amplification over the balance of the wave bands then used.

The Oscillation Control

An oscillation control was possible by the employment of a potentiometer across the "A" battery and the connecting of the grid returns to it. At times only the first or input stage was so arranged. With this arrangement it was possible through varying the potentiometer slider to maintain the tube just under its oscillating point, with a resultant gain in selectivity and signal strength.

One or two manufacturers marketed quite acceptable receivers employing this system of radio frequency; however, with the enlargement of the broadcast bands, caused by the release of wave lengths from two hundred to five hundred and fifty meters, untuned radio frequency transformers could not well be designed which would function satisfactorily over the total band. Consequently they lost their popularity. Insofar as the writer can learn, no one at this time is using circuits employing the use of this type of transformer, hence we may pass on to its successor, the air core tuned radio frequency transformer and its associated circuits. They were first exploited and brought to popular demand through the introduction of the neutrodyne circuit as designed by Prof. Hazeltine, of Stevens Institute of Technology.

The Neutrodyne Receiver

The neutrodyne is essentially a tuned radio frequency receiver. By this it should be understood that the radio frequency transformers used in this type of receiver, in place of having iron cores, (as do the untuned type) have windings which are placed upon an air core form and are tuned to resonance with a variable condenser. Another factor which differentiates this type from that of the untuned class is that the control of tube oscillation with the use of a potentiometer is done away with and small adjustable condensers are used. They are so connected to the circuits of the receiver as to neutralize the inherent feedback capacity effects present in the wiring and the plate and grid elements of each tube.

A typical neutrodyne circuit is shown in figure 25, the numerals "a" and "b" indicating the location of the neutralizing condensers in the circuits, while "c" and "d" identify the air core type radio frequency transformers. These transformers differ not only in the use of air cores but also structurally, with reference to other air core transformers, in that their ratio of primary to secondary windings is very high, but also in the placement of the primary relative to the grid end of the secondary winding.

Angle of Transformers

Many Radio Digest readers who are familiar with the arrangement of parts within a neutrodyne receiver, have possibly felt that the peculiar angle at which the radio frequency transformers were mounted—each to the other—was the big secret accountable for the success of this circuit. May I correct this impression by stating that such is not the case? Were the coils individually and properly shielded, then the angle at which they are placed could in no wise affect the circuit's operation. Its total efficiency is accomplished by the design of the radio frequency transformers used and the method employed for the prevention of oscillations created through interstage feedback or coupling.

The angle of placement in the unshielded types of neutrodynes, to the contrary, is quite essential, for the preven-

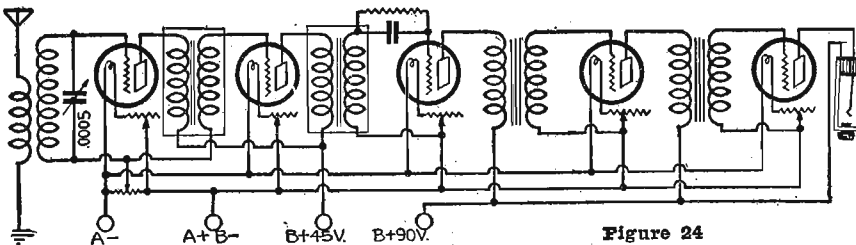

tion of interstage coupling effects. This angle is not fixed, but is entirely dependent upon the size or diameter of the coil, its winding length, and the center-to-center spacing of the coils.

The circuit enjoys a distinct advantage, in that the tuning of one of the variable condensers does not largely affect the associated circuits, hence the setting of the second and third tuning condensers should nearly agree as to dial numerals.

(Continued on page 24)

Radiotone Loud Speaker

Now Only \$19⁹⁵ Was \$25⁰⁰

The BEST Radio Affords

\$1.00 down!



"A Wonder"
says user:—

"The Loud Speaker is a wonder. I never heard anything like it. I put it to a little test a few nights ago and it was heard clear and loud nearly one-half mile from my place through an open window."

Burton W. Cooswell,
Brockton, Masa.



With the Radiotone all the family can enjoy your radio at the same time!

Makes Your Radio Complete

The Radiotone is the last word in sound reproduction and amplification for radio sets. It is super-sensitive. Brings in distant stations with full volume so every one in the room can hear distinctly and easily. Wonderful clearness and absolute purity of tone. No distortion. No crouching in front of the loud speaker to hear announcements.

The Radiotone has a 14-inch horn made of Thorite in one piece without seam or joint, acoustically correct. This eliminates the metallic clang you often hear in other loud speakers. The reproducing unit is entirely enclosed at the base of the horn. The well balanced construction does away with all vibrations. The Radiotone has a graceful shape with a beautiful black florduline finish. It stands 23 inches high and weighs only 15 lbs. No extra batteries needed for the Radiotone—just plug it in as you do your head set. Nothing to wear out or get out of order. Sent complete with cord and plug.

30 Days Trial!

When the Radiotone comes, there's nothing to pay. Use it freely at our risk, on trial for 30 days. See how much more use and fun, you and all the family get from your radio with this loud speaker. See how loud, clear and distinct the Radiotone brings in all stations—better than any other loud speaker you've ever heard, giving you the best that is in your set. After 30 days trial if you think you can get along without the Radiotone, return it to us and we will refund your dollar plus all transportation charges. No red tape. The trial costs you not a cent.

Straus & Schram, Dept. R-9413 Chicago, Ill.

Enclosed find \$1. Ship special advertised Radiotone Loud Speaker. I am to have 30 days free trial. If I keep the Radiotone, I will pay you \$3.00 monthly, total reduced price, \$19.95. The Radiotone is to become my property as soon as you receive the final payment. If not satisfied, I am to return it within 30 days and you are to refund my money and any express charges I paid.

Radiotone Loud Speaker No. Y8728A—\$19.95

My Name.....
(Head of the family must sign this order. If you are not of age, have your parent or guardian order for you.)

My Street Address.....
R.F.D. or Box No.....

My Post Office..... My State.....

My Shipping Point..... I have lived in this Town..... years

And before that I lived in..... Town..... State..... for..... years

Occupation is..... Age..... Married..... or Single.....

Give names of merchants who know you personally

Name..... Town..... State.....

Name..... Town..... State.....

If you have ever bought goods on credit by mail, tell us from whom. If there is anything else you wish to tell us about yourself, write on a piece of paper and enclose it with this coupon. But the coupon alone, fully filled out, ought to do.

That's all we want to know and we're ready to ship the goods at once. No formalities. No C.O.D. We trust rich and poor alike when they merely show us that they are honest.

\$3.00 a Month

But if you decide to keep the Radiotone, pay only \$3.00 a month until you have paid the special reduced price—only \$19.95. See if you can equal this offer anywhere on such amazingly liberal terms. You'll scarcely feel those small monthly payments. Surely, now, you can afford to have the Radiotone—the best loud speaker—and get the most fun out of your radio set for all the family.

Send Coupon NOW!

Seize this opportunity on this special offer. Only \$1.00 with the coupon brings the Radiotone on 30 days' trial, satisfaction guaranteed, your dollar refunded if not satisfied. Send the coupon now while this special offer lasts.

Straus & Schram Dept. R-9413 Chicago, Illinois

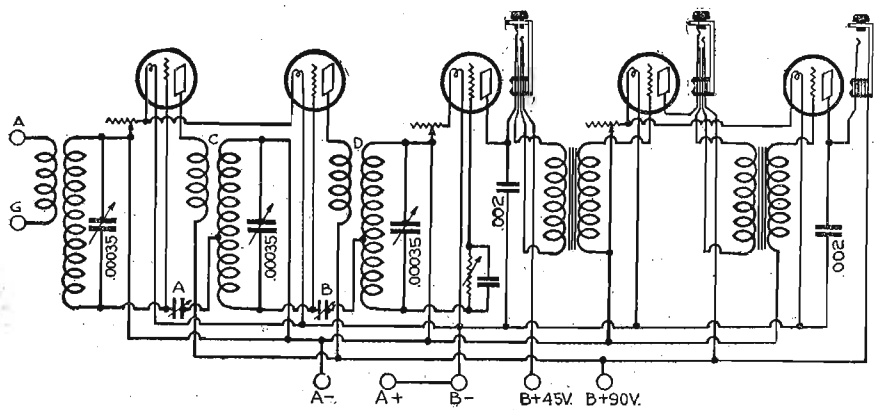

Figure 25

ABC'S OF RADIO SETS

(Continued from page 23)

The first or left condenser, which tunes the first grid circuit, as well as the antenna circuit, may be also caused to "fall in step" with the dial readings of the remaining two condensers, providing the capacity is such as to keep the resonance curve of the input coil common to that of the remaining stages. Therefore, any variance, as far as dial settings are concerned, of the first with relation to the others, may be chargeable to having an aerial whose capacity is too great.

While this circuit's popularity is somewhat over-shadowed by the army of compensated tuned radio frequency circuits now flooding the market, it will ever remain as a distinct forward step in Radio engineering, and the incentive back of the design of compensated types of tuned radio frequency sets.

A word relative to, and of possible assistance to, those owning receivers of this type, is that in general, a single wire aerial of not over seventy-five feet in length, including the lead-ins, is advisable for best operation, while in con-

gested areas one of fifty feet will no doubt serve even better. Long aerials, of necessity, possess a greater resistance than those of medium length, and the writer knows of no greater obstacle to selectivity than resistance contained within an aerial.

If you have wondered why your receiver (irrespective of type) tunes broadly, it is an excellent idea to not only inspect your aerial, but also the ground and try to improve not only the ground connection, but likewise the insulation of the aerial, and look well to the possibility of shortening it. Who is there among you who would cast the first stone, in criticism of added selectivity, and who is there among you who can justly blame the broadcasting station for poor selectivity, who has not looked well toward keeping his own house in order through possessing not only a good aerial, but also a good ground?

(In next week's issue, Mr. Gurney will continue with his explanation of radio frequency type circuits with compensated circuits of this type being featured. Several hook-ups will be given to illustrate this type.—Editor's note.)

INDIANS BEHIND MOTIF

(Continued from page 4)

Indian. Nowhere else is there music as he sings it. Mr. Lieurance believes it is typical. He has made hundreds of phonograph records of these chants and visited practically every tribe on the continent.

Not long ago he spent considerable time with the Sioux Indians on their reservation in South Dakota. There he picked up a melody that has made him world famous. From it he composed the song, "By the Waters of Minnetonka."

To the listeners of WLS Mr. Lieurance told the story of the song. He sang the basic notes as the Indians sing them. Then Mrs. Edna Wooley Lieurance, his wife, sang the song as he had written it. The legend relates that two lovers of the Sun and Moon clans of the Sioux Indians, loving against tribal law, fled to escape torture and sank together in the waters of Lake Minnetonka, located in Minnesota, near Minneapolis. On moonlight nights they return with their phantom canoe and their paddles can be heard dipping in the water as they sing.

That Indians had an understanding of music before the arrival of the white man was said by Mr. Lieurance to be proven by the discovery of flutes carved from bone with holes to permit the sounding of musical scales which were made previous to the time of America's discovery by Columbus. He played "From the Land of the Sky Blue Water" on one of these flutes.

Real Indian music as rendered by the

Indians themselves recently was broadcast by the General Electric station, WGY at Schenectady, N. Y., when it was visited by Sioux warriors and a party of Onondagas. The average listener did not report wild enthusiasm over the esthetic harmonies on this occasion as they were produced in the raw. But the element was there and with the imagination of a good American composer to whip it into a staff chaperoned by a proper cleft it could doubtless have become a typical American song.

Powel Crosley Vacationing

MIAMI, Florida.—Scarcity of living quarters here has failed to mar the pleasure of Powel Crosley, Jr., prominent Radio manufacturer of Cincinnati, who is concluding a month's vacation of rest and recreation aboard his palatial motor-yacht "Muroma," off the coast of Florida. The yacht owned by Mr. Crosley is a beautifully furnished boat, with sleeping quarters for ten guests and with a completely furnished dining room.

To Improve Crystal Detector

WASHINGTON, D. C.—In Radio receiving circuits employing a crystal detector, if the detector is shunted across approximately one-half the inductance coil, the sharpness of tuning and selectivity of the set in broadcast reception will be greatly improved, according to a statement recently issued by E. B. Hudson of the Radio laboratory of the bureau of standards here.

Perhaps you, too, can cut your "B" battery costs in half. Just follow the chart. It gives you the secret of "B" battery economy.

THOUSANDS of people have made the discovery that Eveready "B" Batteries, when used in the proper size and with a "C" battery*, are the most economical and satisfactory source of radio current.

On sets of one to three tubes, Eveready "B" Battery No. 772, used with a "C" battery, will last a year or longer, usually longer. On sets of four and five tubes either of the larger Heavy Duty Eveready Batteries No. 770 or No. 486, used with a "C" battery*, will last eight months or more.

These figures are based on the average use of receivers, which a country-wide survey has shown to be two hours daily throughout the year. If you listen longer, of course, your batteries will have a somewhat shorter life, and if you listen less, they will last just that much longer.

Here is the secret of "B" battery satisfaction and economy:

With sets of from 1 to 3 tubes, use Eveready No. 772.

With sets of 4 or more tubes, use either of the Heavy Duty Batteries, No. 770, or the even longer-lived Eveready Layerbilt No. 486.

Use a "C" battery on all but single tube sets.

Evereadys give you their remarkable service to the full when they are correctly matched in capacity to the demands made upon them by your receiver. It is wasteful to buy batteries that are too small. Follow the chart.

In addition to the batteries

*NOTE: In addition to the increased life which an Eveready "C" Battery gives to your "B" batteries, it will add a quality of reception unobtainable without it.

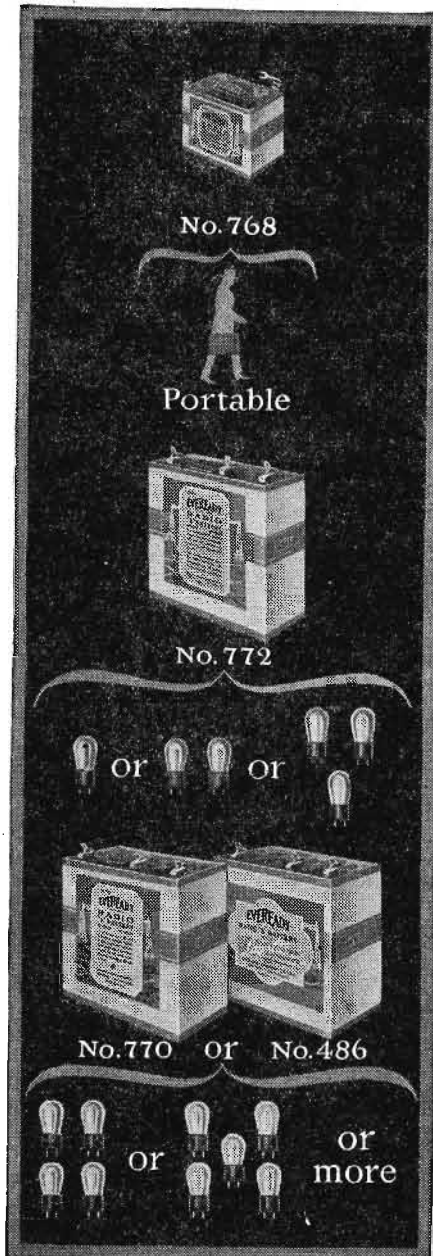

illustrated, which fit practically all of the receivers in use, we also make a number of other types for special purposes. There is an Eveready Radio Battery for every radio use. To learn more about the entire Eveready line, write for the booklet, "Choosing and Using the Right Radio Batteries," which we will be glad to send you on request. This booklet also specifies batteries for the new power tubes. There is an Eveready dealer nearby.

Manufactured and guaranteed by NATIONAL CARBON CO., INC. New York San Francisco Canadian National Carbon Company, Limited Toronto, Ontario

Tuesday night means Eveready Hour—9 P. M., Eastern Standard Time, through the following stations:

- WEAF—New York
- WJAR—Providence
- WEEL—Boston
- WTAG—Worcester
- WFL—Philadelphia
- WGR—Buffalo
- WCAE—Pittsburgh
- WSAI—Cincinnati
- WEAR—Cleveland
- WWJ—Detroit
- WGN—Chicago
- WOC—Davenport
- WCCO—St. Paul
- WCCO—Minneapolis
- KSD—St. Louis

KGO—San Francisco, 8 P. M. Pacific Coast Time

For accuracy, simplicity, and speed in tuning, for clarity and fidelity in tone, for decorative beauty and value—the Crosley 5-tube RFL-75 stands unchallenged and unapproached. Hear it once and no other set will ever quite satisfy you... \$75 without accessories.

Add 10 per cent to all prices west of the Rockies

THE CROSLLEY RADIO CORPORATION, Cincinnati, Ohio

CROSLLEY RADIO

BETTER • COSTS LESS

EVEREADY
Radio Batteries
—they last longer

HOW TO MAKE YOUR TOROID COILS

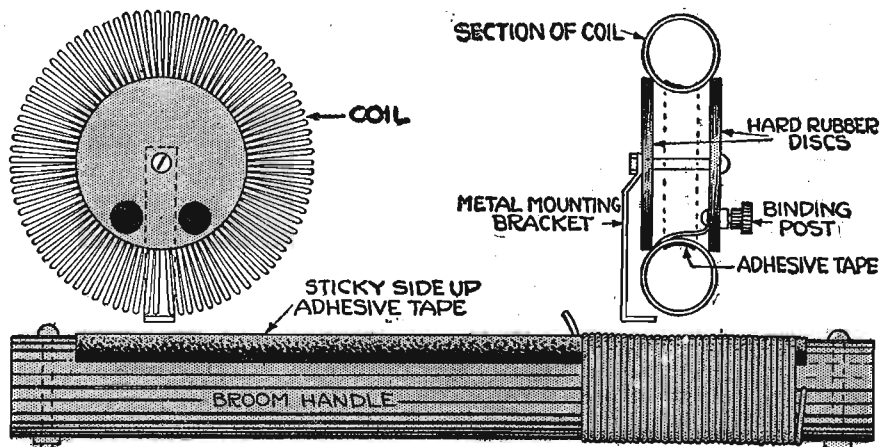

Take a piece of broomhandle about a foot long and split it lengthwise. Bore a hole in each end of both sections about half an inch from the ends so that a nut and bolt may be inserted in each end to hold the sections together. Now lay a piece of adhesive tape over one section as per the illustration; then the desired number of turns, depending on the condensers to be used, may be wound over the tape. Be sure that the tape is laid on sticky side up as it is all that holds the turns of wire together.

After having wound the coil, take out the bolts and slide out one section of the

broomhandle, then the other. The coil is now finished except for providing a suitable mounting for it. I cut two hard rubber disks (or bakelite) about one-quarter inch larger in diameter than the inside diameter of the doughnut and bored a hole through the centers of them. I put one of these on each side of the coil and put a pillar on of such a size that when the nut and bolt is tightened up it just pinches the coil a little and holds it firmly in place. For any further information write to F. W. Clute, 206 East Flower avenue, Watertown, N. Y.

FOUR-FILTER SUPER

(Continued from page 25)

resistance coupled audio frequency amplification for the first time. It was for a long time in the experimental stages and, until the makers of this apparatus got it all straightened out, we hesitated about getting our readers in on something that was not a sure thing. Now, however, the Daven company is marketing a complete three stage unit, assembled ready for use, with special tubes to give maximum results, and this three stage unit has been built right into the set.

It has against it, the fact that three stages are necessary to equal two stages of transformer coupling, in volume. It requires 135 volts of B battery on the plates which is the equivalent of three B units of 45 volts each instead of the 90 volts to which most of us have been accustomed. On the other hand, these three stages draw less milliamperes of current from the three B units and distortion is impossible. Even the makers of the finest audio transformers on the market will admit that a transformer, due to inherent characteristics, will favor certain notes in the musical range covered by the human ear and will not be very responsive to audible frequencies below 200 per second. True, some of the better transformers, such as Karas, Thordarson and Amertran, are well high perfect and few if any, musical critics can detect distortion in good sets using them. The resistance coupling favors no notes over others. One has the choice therefore of three stages, with amplification that cannot distort, or two stages that are nearly perfect but not quite.

Low Loss Condensers

Coming now to condensers, of which two of .0005 mfd. maximum capacity are needed: The X laboratories in New York seem to have spared no expense or design to make a condenser with the lowest possible losses. The stator plates are supported at the sides on bars which are in turn secured to the end plates with Pyrex glass buttons. Nothing better than Pyrex glass at such points is now known. The plates are all of highly polished aluminum, so finished that the surface does not corrode and the edges are rounded and smoothed to prevent leakage. Pigtales are provided so that positive contact to the rotor plates is assured at all times, and the bearing arrangements are good.

The fact that "old style" straight line capacity types are used will cause comment. There is much in favor of the mechanical construction possible in S. L. C. condensers as against that possible in straight line frequency models. To take care of the well-known bunching of stations at the lower end of the scale that would be the case if the usual dials were used, I have put on some very exceptional dials made by Radiall in New York. They are so constructed inside that, when attached to the shafts of S. L. C. condensers, the stations are spread out on the dial scale at every ten divisions just as if S. L. F. condensers were employed. Just at this time our use of these condensers and dials means a saving to you as the manufacturers are selling them below the original price of \$6.00 to make way for their S. L. F. type. You can get .0005 mfd. condensers plain (meaning without attached vernier) for \$2.50 each from X Laboratories, 25 West 45th street, New York city.

Range, Selectivity and Control

As those who follow our technical articles know, we always hesitate about stating that a receiver will accomplish any certain range or will go through in any certain locality because so much depends on local conditions, the workmanship and the operation. So far as this set is concerned, I can state definitely that in the same locality in which we have tested all the other sets, it will do more than any of its predecessors in the way of range, selectivity and tone quality. Stations pop in and out as the dials are turned and, even on a sixty-foot outside aerial, the input condenser is really sharp and must be kept in close resonance with the oscillator condenser to land on stations. Programs pour out of the Amplion speaker, used in all tests, with plenty of volume and a purity of tone that makes listening a pleasure. Reproduction is remarkably free from the well-known super-heterodyne hissing or breathing sound and it is only by watching the "static crackle" that one can keep the dials in resonance.

(Photos of the inside, and the wiring diagram, together with drilling layouts, will follow in the usual sequence used for previous sets.—Editor's Note.)



"That Musical Pal of Mine"

Close Harmony

We hear a great deal about close harmony these days—on the stage, in the movies, over the radio. But in music and sentiment, appreciation and understanding, nothing can equal the close harmony enjoyed by those who play the Hohner Harmonica.

Hohner Harmonicas are a joy to play and a joy to listen to. Played alone, or in conjunction with other musical instruments, they are capable of interpreting all that is best in music, whether it be popular, classical or operatic composition.

Anyone can learn to play a Hohner with the aid of the Free Instruction Book, available at all leading dealers. If your dealer is out of copies, write to M. Hohner, Inc., Dept. 233, 114 East 16th St., New York.



Ask for a Copy! This interesting and helpful instruction book, containing charts, pictures, and musical selections, will enable you to play a Hohner Harmonica with an ease that is most surprising. Ask for a copy!



Photogravures of Your Favorite Artists GALLERY of RADIO STARS

Suitable for Framing or Placing in Your Album

BY SPECIAL arrangement, Radio Digest is able to offer its readers a great opportunity to secure fine photogravures of their favorite Radio stars at practically no cost.

Radio fans will be able now, by this very special offer, to have pictures of their favorite artists and announcers before them when they listen in. All that is necessary to secure photogravures from the Gallery of Radio Stars is to send the coupon published each week in Radio Digest, accompanied by ten cents to cover the cost of mailing and postage. Where a series of three photogravures is desired, it will only be necessary to send twenty-five cents and three consecutively numbered coupons clipped from Radio Digest. Remittance must accompany the coupon. Cash at your risk. Add 5 cents to personal checks for exchange.

WITH COUPONS **Only 10c Each -- 3 for 25c** To cover cost of mailing and postage



Size Eleven by Fourteen Inches

Select Your Favorites from the Gallery of Radio Stars

- | | |
|--|--|
| 1 Wendell Hall, king of ukulele ditties | 23 Art Gillham, "The Whispering Pianist" |
| 2 Graham McNamee, 1925 Gold Cup announcer | 24 Paul Greene, announcer at WSAI, "bridge voice" |
| 3 Jack Little, popular wandering balladist | 25 Harry Ehrhart, "Dream Daddy" of WLIT |
| 5 Coon-Sanders' "Nighthawks" at KYW | 26 Correll and Gosden of "Kinky Kids Parade" fame, at WEBH and other stations. |
| 6 George Hay, 1924 Gold Cup announcer | 27 Norman Brokenshire, popular at WRC, WJZ |
| 7 Harmony Girls, Edith Carpenter, Grace Ingram | 29 Jane Novak, Blues Singer of Twin Cities, WCCO |
| 8 Ford and Glenn, Lullaby Boys of WLS | 30 Jean Sargent, the original, now at WHT |
| 9 "Roxy" Rothafel of WEAJ fame | 31 Ralph Emerson, popular organist at WLS |
| 10 The Hired Hand, famous "Substitute Announcer" of WBAP | 32 Edna Adams, of KPRC |
| 12 Bob Emery, Big Brother of WEEL | 33 Pat Barnes, vaudeville announcer at WHT |
| 13 "Bill" W. G. Hay, ex-KFKX, now of WLIB | 38 Walter Wilson, "Uncle Bob" of KYW |
| 14 Happiness Boys, jovial singers of WEAJ | 40 Ray-O-Vac Twins, known country-wide |
| 15 Lambdin Kay, "Little Colonel" of WSB | 41 Art Linick, KYW's Mrs. Schlagenhauer |
| 16 Leo Fitzpatrick, "Merry Old Chief," WJR | 42 Fred Hamm of WTAS, now WLIB, fame |
| 17 Henry Field, 1925 Gold Cup runner-up | 43 Meyer Davis' Le Paradis orchestra of WRC |
| 18 Al Carney, organ favorite at WHT | 46 D. R. P. Coats, 1925 Silver Cup announcer |
| 20 Vincent Lopez, No. 1 Pennsylvania orchestra | 47 Gene Rouse, WOAW's popular announcer |
| 21 E. L. Tyson, pleasing voice at WWJ | 49 Iris Ruth Pavey, KOA's invisible stage beauty |
| | 51 Ipana Troubadours, on the WEAJ Chain. |

If your favorites are not in this list, send in a request to have them included in the Gallery of Radio Stars.

COUPON NO. 12

This coupon entitles the holder to one photogravure selected from the Radio Digest Gallery of Radio Stars when accompanied by ten cents to pay the cost of mailing and postage.

Three consecutively numbered coupons entitle the holder to three photogravures when accompanied by 25 cents. Remittance must accompany the coupon. Cash at your risk. Add 5 cents to personal checks for exchange.

Order by Number.....
Radio Digest Publishing Co., 510 N. Dearborn St., Chicago

How to Stop Blooming and Man-Made Static

Part V—A DeForest Device and New Super Input

By the Technical Staff

THERE will probably be thousands of fans reading this series who have a sincere desire to cooperate in this movement for a clearer ether but who may not care, for one reason or another to build or buy the Penetrola described last week. Penetrola is not particularly expensive and materially increases both range and volume, but many may not care

ceiver which is either single circuit or three circuit regenerative depending on which pair of dotted line antenna and ground leads are used. If the antenna and ground are hooked onto the coil connected across the variable condenser, and the grid and filament, this circuit classifies as single circuit, while, if they are connected to the primary coil shown at

tube and the variations are then found in the plate circuit. The coil shown as B is a choke insofar as radio frequencies are concerned so that these variations are forced into the condenser A.

Since an efficient fixed condenser offers but little resistance to such currents they now go to the tuned grid circuit of the detector tube, at the left of the diagram.

condensers are not made in the capacity desired which is about .000025 mfd. This value can be obtained with one of the numerous midget condensers on the market such as Chelton, Gleason, Hammarlund and Continental. Some of the newer balancing or neutralizing condensers will do also, it being only necessary that they have a possible maximum of 50 to 75

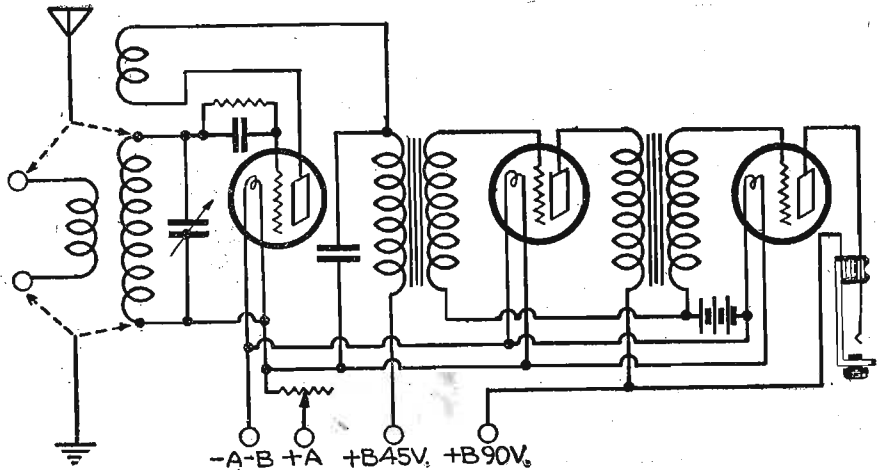

Figure 9

to invest anymore. Therefore, this week, we will describe some slight changes that can be made in a straight Armstrong regenerative hook-up that will eliminate the blooming without the increase in selectivity or range.

About a year ago, Dr. Lee DeForest delved into his seemingly unlimited store of Radio knowledge and, with the valuable cooperation of Roy Weagant on the practical design, presented the Radio world with a low cost little unit to be attached to bloopers. In figure 9 is the schematic diagram of a three tube re-

the left, this hook-up becomes a three circuit installation.

To Prevent Blooming

In figure 10 we have the same apparatus with a couple of slight changes that will prevent blooming. The circuit, as now arranged, works out as follows. The ground, while not shown, connects to the minus A circuit so that the incoming energy sets up a difference of potential, and current, across the grid and filament of the first audio amplifier tube, this current alternating at radio frequencies. Some amplification takes place in this

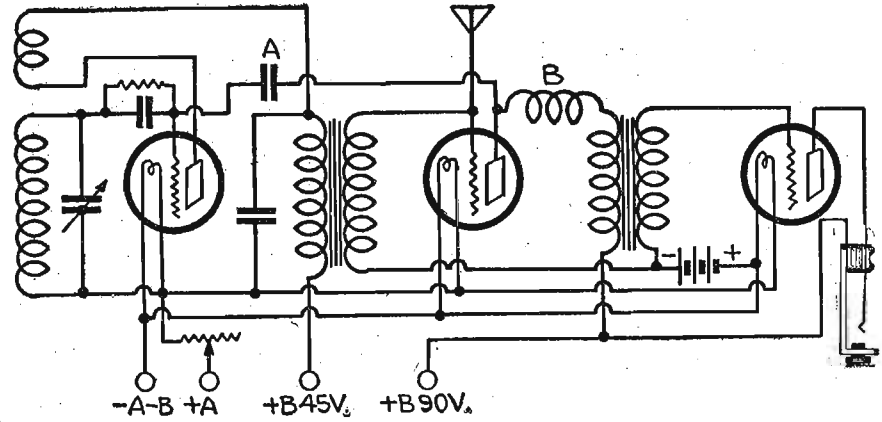

Figure 10

The action from here on is as it was before, the feedback coil giving regenerative amplification and the grid leak and condenser providing rectification and detection. The rectified energy in the form of direct current pulsations is passed into the first audio frequency transformer, into the second tube and then into the second audio transformer and the second amplifier tube.

Have Small Condenser

For satisfactory operation, the condenser A should be very small and fixed

micro-microfarads also known as picofarads and printed, yet again, as .00005 mfd. to .000075 mfd. This will readily pass radio frequency currents yet provides a high resistance to the passage of audio frequencies.

There are small chokes on the market, those by Bremer-Tully and Samson being suggested. The primary of a super-het intermediate transformer would do or such a choke could be made by winding 225 turns of number 36 to 40 silk covered

(Continued on page 28)

Big Price Reduction

FULTONE LOUD SPEAKER FOR YOUR PHONOGRAPH

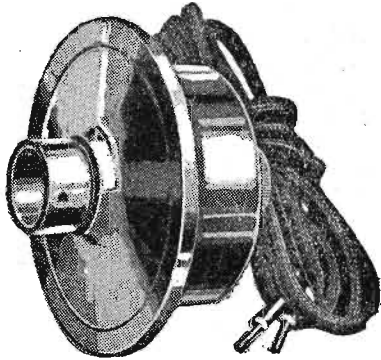

Fits Any Make
Now Only
\$3.00

The unit will be shipped on a satisfaction or money back basis on receipt of price in money order or currency.

Fultone
TRADE MARK
LOUD SPEAKER UNIT
\$3.00

This unit is the secret behind the unparalleled success of Fultone Speaker. Its large diaphragm and bobbins of fine wire are protected from injury by a heavy nickel-plated case through the back of which adjustment is made by means of a special key. The pole pieces are not made from a solid piece of iron but are assembled from 15 laminations of carefully chosen steel.

Use on Your Phonograph

- Edison Adapter.....25c
- Columbia or Pathe.....20c
- Brunswick30c

HALL & WELLS, Inc.
4600 Lincoln Ave. Chicago, Ill.

Tear Off, Fill in, Mail Now

HALL & WELLS, Inc., 4600 Lincoln Avenue, CHICAGO, ILL.

Enclosed is \$..... for which ship me..... () Fultone Unit at once, my money to be refunded if I am not satisfied and return this merchandise within 5 days.

NAME

ADDRESS

CITY AND STATE

Write for Autoformer Hook-Up Bulletin

ZENITH
KENNEDY
RADIO-DYNE
Planstiel
Howard
Thermodyne
OZARKA
Deresnadyne
ADLER-ROYAL
MURDOCK
MU-RAD
Valley
LEICH
Silver-Marshall
GLOBE
ULTRADYNE
Newport
BUCKINGHAM
NUN-LANDON
KUSTOMBLI
and many others

42 fine set builders use

THORDARSON
Super
TRANSFORMERS

Follow the lead of the Leaders

Because leading set builders require the finest tone quality and absolute uniformity in transformers, they use more Thordarsons than all competitive makes combined. Follow their lead — build or replace with Thordarsons. Unconditionally guaranteed. Recommended by best dealers. Audio frequency: 2-1, \$5; 3 1/2-1, \$4; 6-1, \$4.50. Power Amplifying pair: \$13. Interstage Power Amp. \$8. Autoformers, \$5.

THORDARSON ELECTRIC MFG. CO., CHICAGO

It's Easy to Build a Powerful Set

Using the New and Improved FRESHMAN "TRF" Low Loss Kit

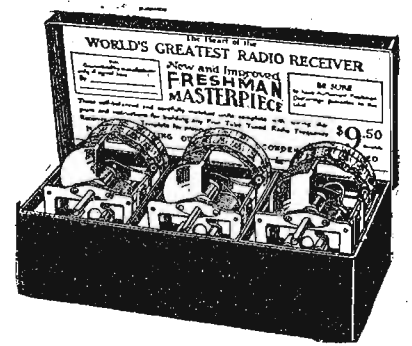

Straight Line Wave Length Condensers With Low Loss Self Balanced Coils . . .

These are the identical units which have made the FRESHMAN MASTERPIECE factory built Receivers the World's Greatest Radio Sets.

\$9.50

Complete instructions for building this powerful five tube receiver, written in plain everyday English, together with actual size schematic wiring diagram, are furnished with every FRESHMAN "TRF" Kit.

Sold by Authorized Freshman Dealers Only!

CHAS. FRESHMAN CO., Inc.
Freshman Building, New York
2426 W. Washington Blvd., Chicago

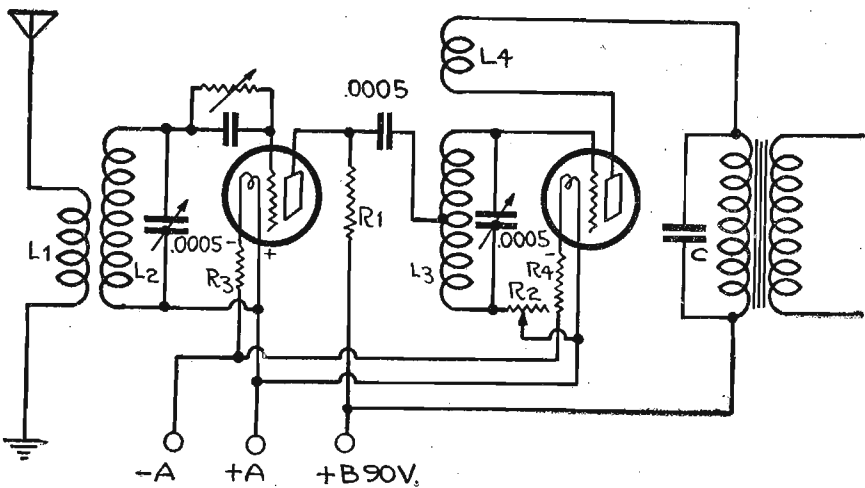

Figure 11

HELP STOP BLOPING

(Continued from page 27)

wire on a small diameter tube, say 5/8 to 3/4 inch. Turns should be wound evenly and side by side. This will effectually block currents at radio frequencies and force them into condenser A but will offer no obstacle to audio frequencies when the program appears on the plate of the first amplifier tube for the second time.

Shield the Cabinet

Lest there be misunderstanding, we want to make it clear that we are not advising the construction of such an outfit with this device built in; this is shown only for those thousands who have receivers of this type already and wish to stop bloping. There are plenty of better circuits to be constructed with few tubes that will not bloop, among them being the circuit of Milo Gurney's in our July 4th issue, that by Skeeters in the August 15th issue and that by Goodrich in the May 23rd issue, all during 1925. So long as a stage of radio frequency amplification is provided that is balanced to make it a one way repeater, there will be no radiation. Such a stage, or a set incorporating one, should preferably be entirely shielded by lining its cabinet with, let us say, number 26 half hard sheet brass.

We also wish to show another method of getting signals off of an antenna and ground circuit into a super-heterodyne in such a way that one way repeater action is obtained and programs can pass into the set without difficulty yet oscillations from the following tubes cannot back up into the antenna and ground system and cause trouble. This came in since the series started from W. Harvey Merwin of Jensen, Fla., and his accompanying letter is reprinted here. The illustration of his circuit which he is discussing is figure 11.

Very Sensitive Arrangement

"Herewith attached" says Mr. Merwin, "is probably the most sensitive arrangement for super-heterodyne there is today. This hook-up has the advantage of not squawking up the neighborhood as it is impossible for oscillation to take place in the first grid circuit, yet there is strong regeneration taking place immediately after leaving the first tube. I would suggest that the antenna coupler shown be wound with half the secondary put on a tube first, then the four turn primary and then the other half of the secondary. Again, you can wind this four turn primary right in beside four turns of the secondary or right over the center of the secondary. This arrangement permits of using only the ground or the aerial where extreme interference is found or terrific electrical device interference (man made static). The ground or aerial may be used alone or, if the super is an exceptionally sensitive one, both may be disconnected and DX accomplished, very often.

"In tuning, the first dial is placed somewhere near the middle of the scale and stations tuned in with the second or oscillator dial, then cleared up with the first. A good strong signal can be heard all over the first dial as a rule but it will be found that unwanted signals and much static can be tuned out with it at certain positions. The first tube is to be a 199 and resistance R3 is a 6V-199 Amperite so this tube can be run from a six volt storage battery. The rest of the tubes are 201-A, although they can be 199s with a 4-volt storage battery and the Amperite would then be a 4V-199.

Tap Secondary Near Center

"Any good tuned radio frequency transformer or tuned radio frequency antenna coupler can be used for the antenna coupler shown, while any good three circuit tuner with the primary removed is used between the first and second tubes and the secondary tapped as near the exact center as possible. The tickler is used as the feedback and generally can be once adjusted and left alone. An important control is resistance R2 in the grid return lead of the second tube and I

have found a Jones variable grid leak ideal for this purpose." (Bradleyleak would probably do also.—Editor's Note.)

Now Mr. Merwin's suggestions are both correct from a theoretical standpoint and easy to put into operation. If you prefer to wind your own coils, the two grid coils for use with variable condensers of .0005 mfd. capacity could consist of 48 turns of number 24 double silk covered wire on a 3-inch tube which will occupy a winding length of 1 1/4 inches. A quarter inch should be allowed at each end and a fraction of an inch for the primary. If you

have variable condensers of .00035 mfd. capacity these grid coils can be 60 turns of number 24 double silk covered wire on a 3-inch tube occupying a winding length of 1 1/2 inches.

The resistance R1 should be a one tenth megohm (100,000 ohms) resistor as made by Daven Resistor Co., at Newark, N. J., preferably mounted in one of their number 50 mountings. Resistance R4 is an Amperite; 4V-199 for the 199 type of tube with 4-volt battery and 1-A for the 201-A tube on six volt battery. The transformer to the right with the fixed condenser across its primary is the tuned filter of the intermediate stages of a super.

(There will be more devices shown for prevention of blooping and several chapters on the locating and prevention of man-made static. If some means of fixing your set has not been shown yet, follow this series closely as all types will be touched on.—Editor's Note.)

Department of Commerce Works with 150 Stations

WASHINGTON. — The department of commerce is now cooperating with nearly 150 broadcasting stations in sending out weather reports and practically all of the United States is within their range. Warnings of cold waves, frosts, floods, heavy snows and other unusual weather conditions are included whenever they are issued. In addition, the department of agriculture is cooperating with a large number of stations in supplying digested agricultural news and special talks.

Legion Notes

March 11, 8:00 p. m. Central time: Station WSE, Atlanta, (428m-700). Georgia Legion department official program: Georgia minstrel, musical numbers, dance orchestra and talk by Colonel Homer B. Watkins, department commander.

March 16, 8:00 to 9:45 p. m. Central time; Station WIAU, Columbus, Ohio, (293.9m-1020kc). Ohio Legion department official program: "Ohio's Legion-Air Birthday Party." Something new in Radio entertainment, musical numbers, and an address by a nationally known person.

Station WDAF, Kansas City, presented an American Legion program on Wednesday, February 17. The Kansas department official program included the Wichita Post quartet, Wyandotte Post Drum and Bugle Corps, a "rare one" by "Doc" Sweeney and talks by the department officials.

Tuesday and Wednesday, February 23 and 24, 8 to 11 p. m., and 12 to 2 a. m., Central time, Station WKAF, Milwaukee, gave the Wisconsin department official program: "The Legion Barrage," featuring the Racine Legion Drum Corps and the Milwaukee Auxiliary band.

A grid leak is essential to the proper operation of the detector tube.

The New Radio Book

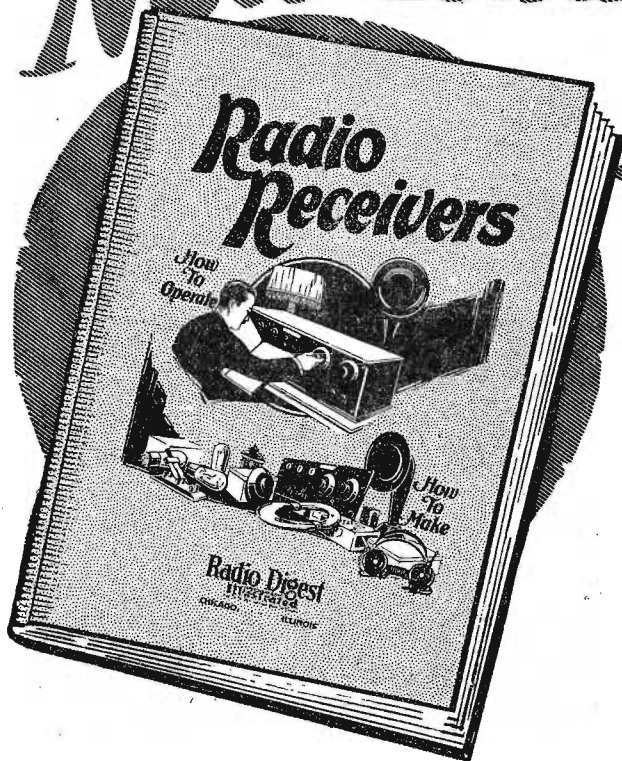

HOW TO

**Operate Sets
Construct Parts
Improve Reception
Understand Radio
Assemble Circuits**

FREE With One Year's Subscription to Radio Digest

THE greatest assemblage of facts and hints, from actual everyday practice, ever gotten together. Edited by the technical staff of Radio Digest it supplies the demand for a book covering every phase of Radio from a simple explanation of Radio reception to a technical explanation of the different parts of a set which leads to the best reception possible. The sections on selecting and making sets develops the different types of sets and circuits with diagrams to explain same. "How to Operate" gives detailed information on the operation of all the well-known sets. The section of general information contains a complete Radio map and schedule and a section of workshop kinks which save time and money. Now is the time to take advantage of the exceptional offer as listed in the coupon for your convenience.

Read what one of our readers has to say:

"This is also to say that I received your treatise on radio (Radio Receivers) and I consider it one of the most remarkable and most valuable books on radio that I have ever seen. You are to be congratulated on this work."

This Handy Radio Reference Book Is Yours Today

Use the Coupon—Mail Today

RADIO DIGEST, 510 N. Dearborn St., Chicago, Ill. 3-13-26

Enclosed find five dollars for one year's subscription to Radio Digest including FREE the New 124 Page Radio Book called "Radio Receivers—How to Operate and How to Make." Not good through subscription agents or agencies.

NAME.....

ADDRESS.....

CITY..... STATE.....

DR. HULLINGER GIVES DESCRIPTION OF SET

BECAUSE he won first prize in the Radio Digest contest for best verified foreign reception during international Radio week, Dr. J. D. Hullinger, 108 The Weston, Clinton, Ia., has been besieged by several hundred Radio fans who want to know what kind of set he used.

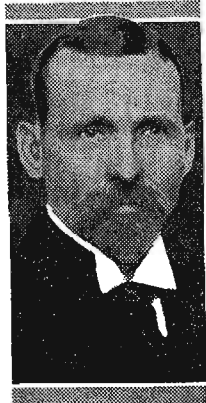

Dr. J. D. Hullinger

His receiver is an outdoor aerial type of super-heterodyne employing what is known as the "Ultra-dyne" circuit. The kit used by Dr. Hullinger in making this set was manufactured by the Phoenix Radio corporation, of New York, N. Y.

Cunningham 301A tubes, together with storage A and B batteries, and a cone type loud speaker, are employed. Plate voltages are 48 on the detector and 120 on the amplifier tubes.

Dr. Hullinger is a graduate in Medicine from the Iowa State university, class of 1893, and his career has included teaching school and, as a pastime, playing the cornet in bands and orchestras. He is sixty-five years old.

It was in November, 1923, that he first became interested in Radio. Since that time he has built and bought many different types of receivers.

In divulging to what he attributes his very successful reception, he lists his large size set, good circuit, keeping his batteries always fully charged, his systematic method of listing and logging stations, careful manipulation of dials, and the fact that he is a regular subscriber to Radio Digest.

He assures all correspondents that he will answer all letters, although there may be considerable time taken in doing this.

A STEP ON THE STAIRS

(Continued from page 7)

what is actually going on in this house I shall show mercy to nobody."

"That is as I would have it Mr. Ardwyn. Draw your chair over closer to the fireplace out of the light from the candle. You need not be afraid of me. I shall be in front of you."

"An excellent arrangement," conceded the lawyer.

So they sat there while the storm whirled at the windows and the mantel clock ticked off the steps on its round toward two o'clock. From across the hall came an occasional voice. But this was not often. The constraint of the situation was not yielding to such amenities as coffee and sandwiches even with the heartening assistance of electric lights.

"I wonder if the candle will last," said the lawyer.

"You may put it out if you wish," suggested Miss Williams.

"It's a question," pondered Ardwyn. "If your supposed visitor sees the light he may hesitate to come in. On the other hand if we have no light and he does come

\$500 in Gold FOR THE SOLUTION OF a Step On the Stairs

WITH the beginning of this exclusive and pioneering effort in coupling a master serial novel-ette with its production as a Radio play at a selected few of the country's best broadcasting stations, Radio Digest wishes to announce that \$500.00 in Gold prizes will be awarded to the persons who can best solve the mystery.

The story, "A Step On the Stairs," is written by Robert J. Casey, an author whose works in the literary world need no introduction. Furthermore he is well versed in the needs of such fiction for Radio presentation. His work, in turn, is being Radio dramatized by Fred Smith, Managing Director of the United States Radio Society, who can be counted among the first few men to write and present Radio plays.

Read the story and hear it played weekly from the selected stations. Don't miss this thriller, whether or not you intend to submit a solution!

The chosen stations, which will broadcast "A Step On the Stairs" in Radio play form, are given on page thirteen. The days and the hours are listed.

THE PRIZES

The prizes are seventeen in number. First prize is \$250; second prize is \$100; third to seventeenth prizes inclusive, are \$10 each. In the event of a tie for any prize offered, a prize identical in all respects with that tied for will be awarded to each tying contestant.

HOW TO WIN A PRIZE

Nine installments of Mr. Casey's story will be published consecutively each week, the first appearing in the February 27 issue. His tenth and final installment will not appear until the prize winning solutions have been selected by the judges. The solution nearest correct, that is, nearest to unravelling the mystery accurately, will win. The method of preparing the solution—its neatness, legibility, etc.—shall be considered in the selection of the winning solution.

RULES OF CONTEST

1. The contest opened with the February 27 issue. All solutions must be received by Radio Digest not later than midnight of Saturday, May 1. The ninth installment of the story will appear in the April 24 issue. The author's intended and final chapter will appear in the May 15 issue of Radio Digest, together with the announcement of the winners' names.

2. The contest is open to everyone except employees of Radio Digest and their families.

3. Contestants pay no fee and need not be subscribers to Radio Digest. Solutions, however, must be written upon but one side of paper, and names and addresses should be written or printed plainly.

4. The decision of the judges, to be named later in the contest, will be final.

in we shall be no better informed than we were before."

"Light or no light I don't think he will stay long out there in the snow," said the girl. "Look—look—the candle. It's going out by itself. . . . It's flickering. . . . It's gone!"

"A devilish weird performance," commented the lawyer uncomfortably

"Quiet," whispered Mary. "I don't think we'll have long to wait now." They sat tensely, paying no heed to a guffaw, probably Tolliver's, that echoed from one end of the manse to the other like a blatant sacrilege.

"I hear a scratching noise," said the girl in an awed tone that was less than a murmur. "There it is—the draft—don't you feel it? The front door is open. . . . Mr. Ardwyn, Mr. Ardwyn, where are you?"

Then silence save for the shrieking of the wind from across the bay, now suddenly audible, a choked curse, a surprised cry and the sounds of a scuffle. A moment later Mary Williams' voice rose in screaming anguish and terror.

"Mr. Ardwyn. . . . Mr. Ardwyn. . . . It's in the room. . . . The 'thing.' I felt it. It's dead cold like a corpse. . . . Oh Mr. Ardwyn, speak to me. . . . I'm. . . . afraid."

Her voice trailed into silence. There followed the crash of a falling body, a groan, the slamming of a door and the noise of many feet dashing across the hall from the library.

"I have a light," came the voice of Hari Singh. . . . "Why it's Mr. Ardwyn with blood all over his face. . . . And Miss Williams. . . . Stand back, please. She's not dead. . . . What's this in her hand?" For the first time his voice betrayed a hint of the panic that had seized upon the company.

"It's part of the grave clothes of Peleg Turner. . . ."

Who, or what, entered the hunt-room as Mary Williams and Lawyer Ardwyn sat watching? New thrills in this Radio mystery story next week. Once more the phantom "Step On the Stairs" echoes through the hall and an unexpected visitor makes appearance.

Strange Requests

CINCINNATI.—Charles Meade, who reads poems and paragraphs over Crosley WLW here, recently received two strange letters from listeners to his work. One asked to have Robert W. Service give a poem before the microphone.

Televocal QUALITY TUBES

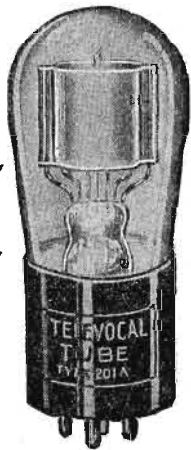

Technical Triumph

Fully Guaranteed

Televocal Corp'n 67 A FIFTH AVE. — New York

Send for this **RADIO BOOK FREE** 1926 Catalog of Everything New in **RADIO** at a Big Saving in Price

The World's Largest Exclusive Radio Mail Order House Will Send You This Wonderful Book FREE

64 illustrated pages containing thousands of bargains in radio sets, semi-finished sets and radio kits of all styles, sizes and approved circuits. Beautiful models of the very latest designs and types. Elaborate console models with loud speakers built right into cabinets of genuine mahogany and walnut. ALL SETS GUARANTEED.

Our line includes all popular sets, such as Superheterodyne, Neutrodyne, Ultra-dyne, Reinartz, Regenerative, Radio Frequency, Browning-Drake, Reflex and all other latest circuits. Kits, sets and parts manufactured by all well known manufacturers, such as: Frost, Howard, Baldwin, Brandes, Western Electric, Columbia and others.

Our Guarantee
Every article exactly as represented. Every article is tested before shipping. Complete satisfaction or money cheerfully refunded.

Don't Buy Anything in Radio Until You Get Our Big Money Saving Catalog
RANDOLPH RADIO CORPORATION
The Largest Exclusive Radio Mail Order House in the World
159 N. Union Ave., Dept. 267, Chicago, Ill.

Our Catalog
Includes complete list of broadcasting stations and general information and facts about our free service division. Our radio engineers will help you solve all your radio problems. Send your name and address on a card or in a letter. We will send catalog FREE.

Sport Broadcasts

Basketball

Saturday March 13

WIP, Philadelphia, Pa. (508.2m-590kc), University of Pennsylvania-Princeton, 9 p. m. Eastern time.

Hockey

Tuesday, March 16

WBZ, Springfield, Mass. (333.1m-900kc), Boston Bruins-Montreal, 8 p. m. Eastern time.

Boxing

Friday, March 19

KNX, Hollywood, Calif. (336.9m-890kc), Hollywood Legion stadium, 10 p. m. Pacific time.

According to Percy W. Harris, editorial manager of the Radio Press, London, WGY was one of three American stations to be heard abroad during the International Week tests. WJAZ and WLW were the other two heard well.

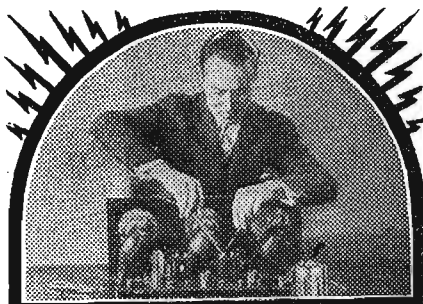

EARN \$50. to \$250. A WEEK

Be a RADIO Expert

Learn Quickly at Home

Get into the great new Big-Pay Industry—Radio. If you're earning a penny less than \$50 a week, clip coupon now. SEND FOR AMAZING FREE BOOK. Be a Radio Expert, and draw down big money for easiest and most fascinating work in the world. Positions everywhere. Every community needs

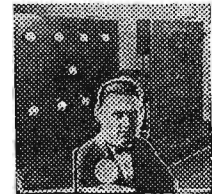

Its Radio experts. Short hours. BIG PAY. Free book gives all the facts. GET IT NOW—CLIP COUPON. Master Radio Engineers will show you the way to qualify for the fine jobs waiting in Radio. You can do it quickly and easily at home.

Thousands of Jobs Now Waiting

Get a fine position like Fetzler did quick with N. R. I. training behind him. Fetzler (picture above) is a successful, high-class man—Chief Operator of WEMC, the Radio Lighthouse. Thousands of openings await the trained men.

Get This FREE Book

Send coupon now for FREE BOOK—"Rich Rewards in Radio." Read for yourself the unequalled opportunities to cash in big as a Radio EXPERT, a trained man in the world's Fastest Moving Industry.

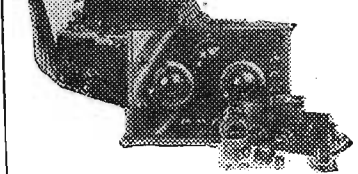

You Get These receiving sets, from simplest kind to thousand mile receiver, given to you without cost with your course. An UNEQUALLED OFFER. Write quick. Clip coupon now for Special Offer, including Receiving Sets.

National Radio Institute Dept. CU9, Washington, D. C.

MAIL COUPON

NATIONAL RADIO INSTITUTE
Dept. CU9, Washington, D. C.
Without obligating me in any way, please send me your free book, "Rich Rewards in Radio." Also complete information on your practical home-study Radio course, with all instruments and short time Special Offer.

Name..... Age.....
Address,
Town..... State.....

The Reader's View

Why Radio Royalty?

I have seen the announcement that Senator Dill is to introduce a bill to tighten the copyright law. As a Radio fan I object to the plan he proposes.

In the first place, the old and new laws only considered the permanency and competition of the copy and that is all that should be considered.

The Radio does not copy but simply amplifies, and does not amplify or copy the copyrighted article but the singers' or speakers' voices, which do not belong to the great Society of Authors and Composers.

The singer bought the right to sing the song when he bought the copyrighted copy and may, or should be able to select his audience. Certain rights go with the purchase of a song—it may be sung correctly or poorly, and the only restriction should be on making a copy which might compete with the author's sale.

I claim that the authors should have been paying the broadcasters all this time, instead of the broadcasters paying the authors.

Instead of being competition, it is really a help in making the composition well known and, no doubt, many a sale has been made by Radio making the song popular. It is not a parallel case with the record people as their records were sold in practically direct competition.

I hope that the broadcasters will wake up and say they will refuse to allow any copyrighted matter to be used by the stations and you will see how quickly the "society" will get busy and make arrangements so that their songs may be broadcast. They know they are hogging matters.

I understand there are only about 5 per cent of the composers in the United States in the society and it is claimed they have banded together to limit production. I think they should be tried under the anti-trust law.—H.B.C., Marion, Ohio.

Plea for Consideration

In reading various articles in this column on the subject of classical and jazz music, I notice the writer usually states his or her preference to either of these types of music. That's all right, everyone is entitled to a preference, but don't you think if all you heard when tuning in was classical music or jazz music continuously it would become boring? The broadcaster can't cater to one particular individual alone, they have to please many thousands, so they are compelled to broadcast a great variety to please them all. And, I think some of these writers must have a set with a small range of tuning for DX, for I can sit down any

night and pick up any type of music I prefer to listen to, on just an ordinary 5-tube set you see advertised everywhere. For myself I can find no complaint to offer about the present day music being broadcast. I have no great preference to either type, although jazz appeals to me more than classical music. I like both. However, old-time music is something I don't like. It strikes me as being coarse and harsh, with many repetitions of refrains. But, if you don't like a program, tune it out and don't start hollering about the faults of the station. They are trying to please their audience.

So, why haggle back and forth over this question "Jazz or Classical Music?" You can get both on an ordinary set with no great difficulty.—A.W., Iowa Falls, Iowa.

ADVANCE PROGRAMS

(Continued from page 21)

- KLDS, Independence, Mo.** (441m-680ke), 6:30 a. m. service.
- KMA, Shenandoah, Iowa** (252m-1190ke), 6-7 a. m. Jack Todd's solos; 11:30-12:30, traveltogue; G. H. Van Houten, piano solos; 6-7 p. m., Grady and Doc; 9-11, Tabor College conservatory.
- KMOX, St. Louis, Mo.** (280.2m-1070ke), 12:30 p. m., Arthur L. Utt, organist; 2, string ensemble, soloists; 6, Arthur L. Utt, organist; 6:30, Mrs. Jacques Landree, organist; 7, orchestra; David Bittner, Jr.; Charlotte with ukulele; Buster Brown quartet; 8, orchestra; 9, orchestra; pianologue, Mrs. Madeline Anderson Mattingly; 10, orchestra.
- KSD, St. Louis, Mo.** (545.1m-550ke), 7:30 p. m., performance of "Carmen"; 8, Mrs. Harry Weil, soprano; 8:30, WEAF; 9, WEAF.
- KSO, Clarinda, Iowa** (241.8m-1240ke), 7-8 p. m., music; 7:15-8, Arthur Sisters.
- KTS, Hot Springs National Park, Ark.** (374.8m-800ke), 9-9:30 p. m., New Arlington hotel orchestra; 9:30-10:25, Phil Baxter and the Jack-o'-Lantern night club; 10:25-10:45, Joe Kuntz and his accordion.
- KWVG, Brownsville, Texas** (278m-1090ke), 6 p. m., Texas theater orchestra.
- KYW, Chicago, Ill.** (535.4m-560ke), 12:05-1 p. m., noon-day concert; 1-2, luncheon concert, Congress hotel; Coon-Sanders Original Nighthawks; 6-7, dinner music; 9, music hour; 10-12, midnight revue; Coon-Sanders Original Nighthawks; 1-2, insomnia club.
- WAMB, Minneapolis, Minn.** (244m-1230ke), 12:01 p. m., classical program; 7:10, Minneapolis school hour, glee club, two operettas; 8, Reception Five musical program; 11, Skyrocket frolic, George Osborn and his orchestra.
- WBAP, Fort Worth, Tex.** (475.9m-630ke), 12:05-12:30 p. m., musical program; 6-8:30, Chief Gonzales' Texas hotel orchestra; 7:30-8:30, School of Music of Texas Christian university; 9:30-11, Maude Wright's orchestra; 11-12, Panther Hawaiian trio.
- WBBM, Chicago, Ill.** (226m-1330ke), 4-6 p. m., Harry and Sandy; Harold Morava, tenor; William Dalton, baritone; Joe McManus; Ralph Botthoff; 8-10, Two Jays; Jack Crawford's orchestra; Barber Shop three; Ziegler stars; Dave Handler, violinist; Floyd Falch.
- WCCO, Minneapolis-St. Paul, Minn.** (416.4m-720ke), 6:15 p. m., dinner concert, Emmet Long's Golden Pheasant orchestra; 8, Watkins family party; 9, WEAF; 10:05, dance program, Emmet Long's Golden Pheasant orchestra.
- WDAF, Kansas City, Mo.** (365.6m-820ke), 6-7 p. m., Trilano ensemble music; 8-9:30, program, Chamber of Commerce; 11:45-1 a. m., Ted Weems' Victor Recording orchestra; Ben Bernie's orchestra.
- WEBB, Chicago, Ill.** (370.2m-810ke), 3-4 p. m., special features; 7-8, Oriole concert orchestra; Pauline Sachs, soprano; Eleanor Kaplan, violinist; 9-9:45, Oriole dance orchestra; Dennis Sisters; Bernard Weber, tenor; 11-12:30 a. m., Oriole dance orchestra; Irene Beasley, Dennis Sisters.
- WEMC, Berrien Springs, Mich.** (285.5m-1050ke), 9 p. m., prelude, Martha Hutchinson; choir; Bible hour study; duet, Prof. and Mrs. H. Edwards.
- WFAA, Dallas, Texas** (475.9m-630ke), 4:30-5 p. m., Ewen Hall, vocalist; 6:30-5, Ford's Texas Trumpeters; 8:30-9:30, Mrs. Gabe Cazell and musicians.
- WGES, Oak Park, Ill.** (250m-1200ke), 5-7 p. m., twilight concert; 8-9, pipe organ; 11-1 a. m., banjo friends; Coyne orchestra; uke girls.
- WGN, Chicago, Ill.** (302.8m-990ke), 12:40-2:30 p. m., luncheon concert, Drake ensemble, Blackstone string quintet; 2:30-3, Lyon and Healy artists; 3:30-4:15, Tea Time music, Marshall Field's tea room orchestra; 4:30-5, organ recital, Edward Benedict; 6:30-7, concert ensemble, Blackstone string quintet, old-time favorites; 8-9, WEAF program; 9-10, WEAF program; 10-10:10, Sam 'n' Henry; 10:10-10:20, old-time favorites; 10:20-10:40, the Playshop; 10:40-11, popular and dance program.
- WHAD, Milwaukee, Wis.** (275m-1090ke), 6:15-7 p. m., organ recital, Arthur Richter; 8:30-10, Marquette university studio program, vocal, string quartet, orchestra.
- WHAS, Louisville, Ky.** (399.8m-750ke), 1-2 p. m., concert, Royal Peacock orchestra; 3:30-4, special music; 4-5, concert; 7:30-8, Concert orchestra; 8-9, concert, Glee club, County children's home.

- WHB, Kansas City, Mo.** (365.6m-820ke), 2-3 p. m., instrumental trio; Dick O'Kane, pianist; Thomas McCluskey, violin and banjoist; Anthony Garero, cellist; 7-8, vocal solos, duets, readings, violin and piano selections.
- WHO, Des Moines, Iowa** (525m-570ke), 7:30-9 p. m., Garber family entertainers; 11-12 midnight, Philbrick and his Younger Brothers orchestra.
- WHT, Chicago, Ill.** (399.8m-750ke), 12 m., Al Carney's complimentary organ recital; 6, classical program; dinner organ recital, Al Carney; Grayling's string trio; Helen Rauh, pianist; Charles Hussey, basso; 9:15, Ray-O-Vac concert; 9:15, musical features; Cinderella Cafe orchestra; 9:30, novelties; 11:30, Pat Barnes and Al Carney; Cinderella Cafe orchestra; 12, Pat Barnes and Al Carney.
- WJJD, Mooseheart, Ill.** (370.2m-810ke), 12-1 p. m., Palmer House symphonic players; 2-3, organ hour, Howard L. Peterson; child artists; assembly of 1,250 children; 5:30, instrumental hour; Palmer House symphonic players; Jack Nelson; Victorians; 6:40, Billy Van; 8-9, children's hour; 10-11, feature hour; Senator Harold C. Kessinger; Palmer House Victorians; Jean St. Anne; 12:30 a. m., Knights of the Burning Candle.
- WKAF, Milwaukee, Wis.** (261m-1150ke), 10-11 p. m., program.
- WLBB, Chicago, Ill.** (302.8m-990ke), 7-7:20 p. m., Uncle Walt's Punch and Judy show; 7:20-7:30, Correll and Gosden; 7:30-8, program; 11-11:20, Correll and Gosden; 11:20-1 a. m., dance music; Correll and Gosden.
- WLS, Chicago, Ill.** (344.6m-870ke), 12 m., Ford and Glenn; 6 p. m., Ford and Glenn; 6:40, Ralph Emerson, organist; 7, Ford and Glenn; 7:15, young American artists series; Federal Whitesley, baritone; Clara Seagle, pianist; 8:30, "Elijah"; Little symphony ensemble; 9:50, WLS staff artists; 10, Ford and Glenn; 11-12, Grace and Ralph.
- WMAQ, Chicago, Ill.** (447.5m-670ke), 2 p. m., Sbut-in program; 6, Chicago theater organ; 6:20, Family Whitney; 9:35, chimes.
- WMBB, Chicago, Ill.** (250m-1200ke), 7-8 p. m., Trilano duo; Vella Cook, contralto; Frank Borden, baritone; Franklin Kidd, tenor; 9-11, Woodlawn theater orchestra; Joe Warner, character songs; Oxford Girls; Harmony duo.
- WMC, Memphis, Tenn.** (499.7m-600ke), 8:30 p. m., musical program; 11, midnight frolic.
- WQAI, San Antonio, Texas** (394.5m-760ke), 3 p. m., Radio Trades association concert; 8:30, San Antonio College of Music.
- WOAW, Omaha, Neb.** (526m-570ke), 1 p. m., Randall's Royal Fontendle orchestra; 4:15, Blah club; 6, music review; 6:20, Francis Potter's banjo orchestra and soloists; 6:50, Gilbert Jaffy, pianist; Nat Young, pianist; 10:30, Frank Hodek and his Nightingale orchestra.
- WOC, Davenport, Iowa** (483.6m-620ke), 4-5 p. m., musical program; 5:45-6, chimes concert; 7:30-8:30, musical program, St. Paul's church choir; 8:30-9, WEAF; 9-9:30, WEAF; 10:30, dramatic presentation, "The Step on the Stairs."
- WOL, Ames, Iowa** (270m-1110ke), 12:30 p. m., college chimes.
- WOK, Chicago, Ill.** (217.3m-1300ke), 4:30-7 p. m., Capitol theater organ; Pat Hostetler, tenor; 10-1:30, Tearnay's town club orchestra; Carl Lorraine's Parading Palace orchestra; Husk O'Hare's Coconut Grove orchestra; Capitol theater program.
- WOS, Jefferson City, Mo.** (440.9m-680ke), 7:45-8 p. m., Bible class; 8:20-10, Ashland community orchestra; 10, Jack Lindley, ukulele songster.
- WORD, Batavia, Ill.** (275m-1090ke), 7 p. m., program, North Shore line; 9, program; 10-11:45, program.
- WQI, Chicago, Ill.** (447.5m-670ke), 7-8 p. m., dinner concert, Jack Chapman and his Rainbo Gardens orchestra; Henrietta Nolan, violinist; Billie Harris, accompanist; Margaret Cade, coloratura soprano; Madeline Ruff, pianist; 10-1 a. m., Jack Chapman and his Rainbo Skylarks; Dr. H. Lucille Long, woman harmonica player; Eleanor Terry, Melodians, Romo Vincent, boy baritone; Merrill Carder; Johnny Potts, Harold Olson, baritone; Clark's Hawaiian trio; artists; 1-2, Ginger hour, Jack Chapman and Little Skylarks.
- WSB, Atlanta, Ga.** (428.3m-700ke), 8 p. m., Merry Makers orchestra; 10:45, Nunnally's miniatures symphony orchestra.
- WSM, Nashville, Tenn.** (282.8m-1060ke), 6:30 p. m., Francis Craig's concert orchestra; 8, Dalsy Sartain, pianist, artists; 10, program, Vanderbilt university.

Mountain Time Stations

CFAC, Calgary, Canada. (435.8m-689ke), 7 p. m., Salon broadcast.

\$1.50 for Your Old Radio Tubes
regardless make or condition, toward purchase of each new standard \$2.50 tube. (WV11 or WV12 tubes not accepted). Positively guaranteed. We do not sell re-built or bootleg tubes. Agents wanted.
Super-Service Laboratories, Dept. 56
Room 58, 39 West Adams, Chicago, Ill.



The wonderful SUPERFLEX radio
NEW CIRCUIT—ONE DIAL (one condenser—pat. pdg.) Not reflex. Volume, Clarity, Distance, Selectivity.
Sample to Rated DEALERS. TEST ONE.
RADIO PRODUCTS CORPORATION, (Inc.)
3816 N. 28th St. Birmingham, Alabama

ELIMINATE STATIC!
Enjoy perfect reception regardless of weather conditions. The Static Eliminator—the newest and most startling thing in Radio—cuts out practically all static without loss of volume! And in addition it will help increase selectivity, tune out local stations, sharpen signals, remove noises, lessen interference and prevent re-radiation!
Use it with any receiving set—simply hook up according to our simple instructions and enjoy perfect reception unmarred by static. Satisfaction absolutely guaranteed—Money back if Eliminator is returned within 5 days. Mail your order today.
\$1.00 Postpaid

- CNRE, Edmonton, Can.** (516.9m-580ke), 8:30-10:30 p. m., studio program; B. E. McQuaig, pianist; Sydney Healey, violinist; E. Holtsman, baritone; Mrs. A. Davidson, soprano; A. Digney, tenor; 11:15-12, Tom Gardner and his Rialto theater orchestra; Mrs. T. Gardner, soprano; Dennis Clayton, pianist; Leslie Hopper, marimbaphonist.
- KFWA, Ogden, Utah** (261m-1150ke), 4-5 p. m., organ recital, Paramount theater; 5-6, Radio dealers program.
- KQA, Denver, Colo.** (322.4m-930ke), 12:15 p. m., Marjorie Nash, organist; 6:30, dinner concert, Brown Palace string orchestra; 8, instrumental program; 8:15, program, minstrel show; incidental music.
- KOB, State College, New Mex.** (348.6m-860ke), 7:30-8:30 p. m., musical concert.

Pacific Time Stations

- CNRV, Vancouver, Can.** (291.1m-1030ke), 8:30 p. m., studio program, Wesley church; choir, musical festival; C. Warren, organist; Kitty Laughlin, soprano; Edith White, soloist; 10:30, Cabaret Belmont orchestra, Bebe Mullar, soprano.
- KFI, Los Angeles, Calif.** (467m-640ke), 5:30-6 p. m., Kenneth Morse's orchestra; 6, Nightly dolings; 6:30, vest pocket program; 6:45, Radiatorial period; 7-8, dance program; 8-9, Dan L. McFarland, organist; 9-10, Paul Roberts, pianist; Mutual Motors mirth contest; 10-11, Packard Ballad hour featuring popular songs.
- KFOA, Seattle, Wash.** (454.4m-660ke), 12:30-1:30 p. m., Seattle Chamber of Commerce program; 7-8:15, Sherman Clay and company studio program; 8:30-10, Times studio program; 10-11, Jackie Souder's Club Lido serenaders.
- KFON, Long Beach, Calif.** (232.4m-1280ke), 6-6:30 p. m., Brayton's theater organ; 6:30-7, amusement information; 7-8, program, Dalton & Hoagland company; 8-9, Press-Telegram studio; 9-11, Long Beach Elks, No. 888, frolic.
- KFWB, Hollywood, Calif.** (252m-1190ke), 6-7 p. m., dinner music, Fitzgerald Music company; 8-9, program, John Wright, The Right Tailor with Bill Hagan's orchestra; Peggy Mathews, blues singer; Bill Blake, tenor; 9-10, Len Nash and his original Country Boys orchestra; 10-11, Warner Brothers frolic.
- KGO, Oakland, Calif.** (361.2m-830ke), 11:30-1 p. m., luncheon music; 3-4, Bertha Gersten, violinist; Clara Anker, accompanist; Marcella Elliott, soprano; Grace Fairlie, contralto; 4-5:30, Hotel St. Francis orchestra; 6-6:55, Brokaw and orchestra.
- KGW, Portland, Ore.** (491.5m-610ke), 12:30-1:30 p. m., concert, First National bank and the Security Savings and Trust company; 6-7, dinner concert, Olds, Wortman & King company; 8-9, concert; 9-10:30, Sherman, Clay and company, Duo-Art studio; 10:30-12, weekly frolic, Hoot Owls.
- KHJ, Los Angeles, Calif.** (405.2m-740ke), 8-10 p. m., program, Western Auto Supply company; 10-11, Don Clark's Billmore hotel dance orchestra.
- KJR, Seattle, Wash.** (389.4m-780ke), 7-8 p. m., Lundquist-Lilly male quartet, old-time songs; 8:30-10, Post Intelligencer studio program.
- KLX, Oakland, Calif.** (508.2m-590ke), 8-9:45 p. m., studio program; 9:45-10:30, Athens Athletic club orchestra.
- KMTB, Hollywood, Calif.** (238m-1260ke), 8-10 p. m., KMTB concert orchestra, Loren Powell, director with Nell Russell as soloist; 10-11, Starr Piano company studio.
- KNX, Hollywood, Calif.** (356.9m-890ke), 5:30, Leighton's cafeteria orchestra; 6:30-7, Atwater Kent orchestra; 7-8, program, Jell-X-Cell company; 8-9, program, John A. Vaughn corp.; 9-10, Order of Optimistic Donuts; 10-11, fights, Hollywood Legion stadium; 11-12, Ambassador hotel dance orchestra.
- KOAC, Corvallis, Ore.** (280.2m-1070ke), 7:20 p. m., Arthur Kirkham, tenor; 8-9, music.
- KTAB, Oakland, Calif.** (240m-1250ke), 9-9:30 a. m., prayer service; 12-1, luncheon concert; 8-10, program, Brema.
- KWSC, Pullman, Wash.** (348.6m-860ke), 7:30 p. m., Norma Sparlin, piano soloist; Evelyn Sparlin, violin soloist; Betty Ransom, vocal soloist.

For better reception
SHIELD your RADIO
Perfect shielding materials, write for prices.
Stage Bros. Mfg. Co., Lincoln, Nebr.

Free 3 Lessons
Buescher Saxophone
You can play the scale in an hour and play Jazz in a week on the
Buescher Saxophone
We give 3 free lessons with each new instrument. They start you. Teach yourself. It's great fun practicing because you learn so quickly. Even though you have failed with some other instrument, you can learn the Buescher Saxophone. And it will make you the most popular person in your set. 5 days' free trial in your own home, any instrument. No obligation. Easy terms if you decide to buy. Send now for beautiful free literature. A postal brings liberal proposition. Address:
Buescher Band Instrument Co. (3)
1224 Buescher Block Elkhart, Indiana

FOR CLEAR, QUIET "B" POWER
RADIO Storage "B" Battery
12 Cells 24 Volts Lasts Indefinitely—Pays for Itself
Economy and performance unheard of before. Recharged at a negligible cost. Delivers unfailing power that is clear, pure and quiet. Approved and listed as Standard by leading Radio Authorities, including Pop. Radio Laboratories, Pop. Sci. Inst. Standards, Radio News Lab., Reflex, Inc., and other important institutions. Equipped with heavy glass jars, an insurance against acid and leakage. Extra heavy glass jars. Heavy rugged plates. Order yours today!
SEND NO MONEY Just state number of batteries wanted and we will ship day order is received. Extra offer: 4 batteries in series (36 volts), \$10.50. Pay expressman after examining batteries. 5 per cent discount for cash with order. Mail your order now!
WORLD BATTERY COMPANY
1219 So. Wabash Ave., Dept. 76 Chicago, Ill.
Makers of the Famous World Radio "A" Storage Battery.
Prices: 6-volt, 100 Amp. \$11.25; 12-volt, 100 Amp. \$14.00. All equipped with Solid Rubber Cases.
World STORAGE BATTERIES Set your Radio Dials at 220 meters for the new 1000 watt World Storage Battery Station, WSB, Chicago. Watch for announcements.
WORLD BATTERY CO. Dept. 143, 1219 S. Wabash Ave., Chicago

CLASSIFIED ADVERTISEMENTS

Classified advertisements in Radio Digest produce results. Have you a receiving set to sell? Do you want to buy a Radio? A classified advertisement in this column will sell your set.

Rates are twenty cents a word for each insertion, five per cent discount for four insertions, ten per cent for thirteen insertions, fifteen per cent for twenty-six insertions, twenty per cent for fifty-two insertions. Name and address to be included at above rate. Cash should accompany order. Minimum of ten words.

Objectionable and misleading advertisements not accepted. Forms close three weeks prior to date of publication, which is Saturday.

BLUE PRINTS

Super-Het, Ryan's Simplest Possible 7-Tube Set. Complete instructions, actual size template. How to make a loop. All for 50 cents. Book Dept., Radio Digest, 510 North Dearborn Street, Chicago.

MISCELLANEOUS

Photos of Your Favorite Radio Stars. Ten cents and coupon appearing on another page of this issue will entitle you to one of the photos from Radio Digest gallery of stars. Radio Digest, 510 North Dearborn Street, Chicago.

PATENT ATTORNEYS

PATENT ATTORNEYS
PATENTS. Booklet free. Highest references. Best results. **WATSON E. COLEMAN, Patent Lawyer,** 644 G Street, Washington, D. C.

RADIO

1,000 Miles on a Crystal Set. Get a Hertzite—the wonderful imported Crystal—the rage of England, \$1.00, post free. V. Lavenstein, 190 N. State St., Chicago, Ill.

SALESMEN WANTED

A PAYING POSITION OPEN to representative of character. Take orders shoes-hosiery direct to wearer. Good income. Permanent. Write now. **Tanners Shoe Mfg. Co., 3-717 C St., Boston, Mass.**

Don't Tune by Guess
KNOW the wave length your set is tuned to
KNOW your dial numbers for each station in America
KNOW whom you are receiving without announcement
You can do it all with RADEX
At most good Radio Shops **25c** or sent postpaid coin or stamps
RADEX, Box 143-N Cleveland, O.

6-Volt Storage Radio "A" Battery
\$5.00 C.O.D.
Most amazing battery value ever offered! A genuine World 6-Volt Radio "A" Battery with 25 ampere capacity for only \$5.00! Just the thing for Trickle Charger. Famous World Quality assured. Equipped with **Solid Rubber Case** an assurance against acid and leakage. Order Now. We ship same day—by express C. O. D. subject to your examination on arrival. Extra Offer: 5% discount for cash in full with order. **ACT TODAY!**
World WORLD BATTERY CO. Dept. 143, **STORAGE BATTERIES** 1219 S. Wabash Ave., Chicago

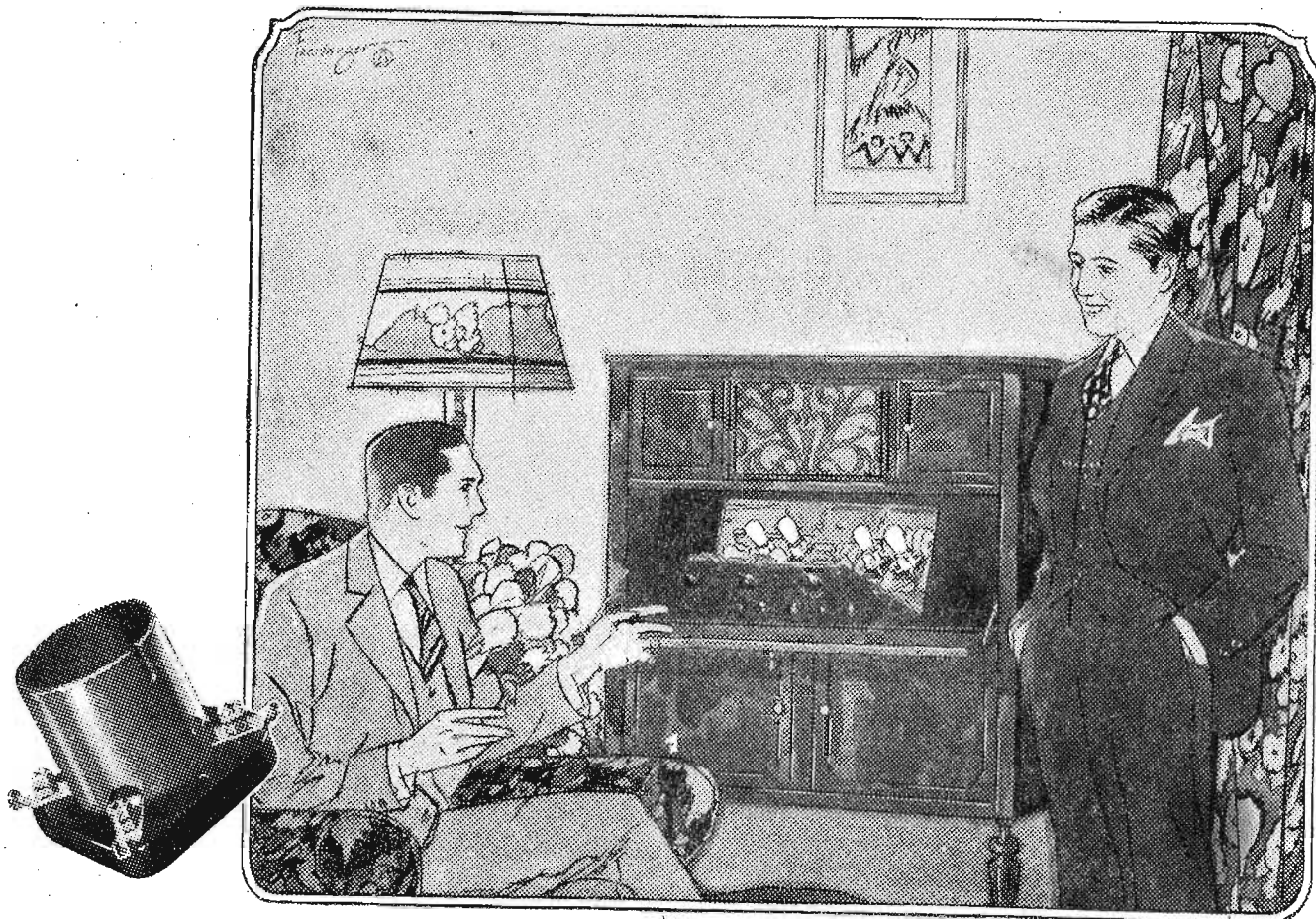

The mark of Quality whether you buy or build. Insist upon C-H radio products for highest efficiency in your new set.

“That’s Not Only a Beautiful Set, Fred; It Has Been Carefully Designed—Those Sockets Prove It!”

A list of some of the prominent radio manufacturers using C-H products

Acme Apparatus Co.
American Bosch Magneto Co.
Astral Radio Corporation
Boissier Radio Corporation
Chelsea Radio Co.
Crosley Radio Corporation
Dayton Fan & Motor Co.
Dictagraph Products Co.
Dubilier Condenser & Radio Corporation
Electrad, Inc.
Freed-Eisemann Radio Corp.
Garod Corporation
Giffillan Bros., Inc.
Allen T. Hamscomb
Harding Mfg. Co.
Howard Radio Co.
The Keyport Laboratories
King Electric Mfg. Co.
Kodel Radio Corporation
LeMor Radio, Inc.
Magnus Electric & Radio Co.
Malone-Lemmon Laboratories
Glenn L. Martin Co.
Wm. J. Murdock
Newport Radio Co.
Phanstiehl Mfg. Co.
Philadelphia Storage Bat. Co.
Radio Master Corp. of America
The Radio Compak Co.
R. B. Radio Co.
Robbins Radio Co.
Signal Electric Co.
Silver-Marshall Co.
Simplex Radio Co.
R. E. Thompson Co., Inc.
J. S. Timmons
Workrite Mfg. Co.
Zenith Radio Co.

“YOU can always tell a carefully designed set by its parts”—any radio set manufacturer will tell you so.

That’s why you find so many sets on the market today with C-H sockets, rheostats and switches. For manufacturers know by careful testing the advantages that hundreds of thousands of radio fans have found in C-H features through years of “building their own.”

C-H Low Loss Sockets, for instance, settle once and for all one of the most annoying of all set troubles—loose contacts at the tube prongs. In C-H sockets each tube prong is firmly held in the one piece, silver-plated, double grip contacts. Jarring of the set or corrosion cannot alter the perfect contact. They are easily wired and give a finished appearance to any set.

So whether you buy or build—look for the C-H trade mark. It is a guarantee of satisfaction.

THE CUTLER-HAMMER MFG. CO.

Member Radio Section, Associated Manufacturers of Electrical Supplies

1207 St. Paul Ave.

MILWAUKEE, WISCONSIN

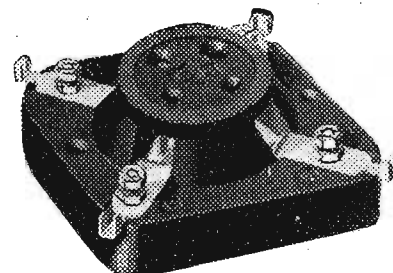

The New C-H UX Socket for the new UX tubes. Same C-H one piece, low loss SILVER plated, double grip contacts as in the C-H original low loss socket with the ORANGE shell. Heat proof Thermoplas body—terminals cannot loosen under heat of soldering iron. Spring washers under binding posts prevent loosening of hex nuts and assure tight connections. The hex nuts are slotted to permit tightening with screw driver or wrench.

The lugs at the end of the contacts are designed for easy soldering and may be bent down for under wiring.

CUTLER-HAMMER

— Radio Parts for Performance —