

Read "A Step On the Stairs" Mystery

Radio Digest

EVERY
WEEK

ILLUSTRATED PROGRAMS

TEN
CENTS

Vol. XVI No. 12 Copyright 1926 by
Radio Digest Publishing

Title Reg. U. S.
Pat. Off. &
Dom. of Canada

MARCH 27, 1926



Boy Scouts Master Radio Tricks; WCCO Portal Players Make Up for ^{as} _{inside}
Gold Cup Announcer Contest Opens; Fifth Installment SOS Stor _{live in}

No. 1 OFFICIAL BALLOT

Announcers' Contest

RADIO DIGEST THIRD ANNUAL GOLD CUP AWARD

GOLD CUP AWARD Editor, Radio Digest,
510 North Dearborn Street, Chicago, Ill.

Please credit this ballot to:

.....of Station.....
(Announcer's Name) (Call Letters)

Signed.....

Address.....

City..... State.....

3-27-26

NOMINATION CERTIFICATE

Announcers' Contest

Radio Digest Third Annual GOLD CUP AWARD

GOLD CUP AWARD Editor, Radio Digest,
510 North Dearborn Street, Chicago, Ill.

Dear Sir:

I nominate.....

Station.....
(Broadcasting Station)

Signed.....

Address.....

Town..... State.....

Says Radio Has Increased Circulations of Libraries

CHICAGO.—A stimulated interest in an increased circulation of library books have resulted from the universal popularity of Radio, declares the American Library association, after compiling reports from various parts of the country dealing with the influence of Radio.

Once considered to be a new form of amusement which would divert the interest of the American family and discourage reading habits, public libraries have found in Radio an ally for extending the circulation of good books. Cooperation of libraries with Radio stations everywhere has had a salutary effect, according to the library association. There are now more than forty stations which broadcast regular book news.

CLAIMS RADIO WILL CREATE FOLK MUSIC

REAL AMERICAN TUNES TO BE BASED UPON JAZZ

National Authority Says United States Will Develop Individual Type Through Broadcasts

CHICAGO.—Under the withering white glare of the Radio spotlight the average jazz tune curls up and dies six months before its pre-radio allotted time.

Only the virile, the sturdiest of worthwhile compositions of a jazz nature can survive the infinite repetitions within a short space that Radio gives to every new tune. Thus, by the survival of the fittest, America is developing for the first time a genuine lore of folk music, based on jazz.

This is the opinion of Dr. Sigmund Spaeth, author of many volumes on modern music and music trends, and a leading authority on music in all its phases, whose innultrated lectures on the subject over the microphone of WLS, the Sears-Roebuck Agricultural Foundation station, have created a mild sensation and an avalanche of "applause letters."

"There never has been any genuine American music," Dr. Spaeth believes. "For a century and a half we have imitated the European style. We have been insincere in music, posing. Whether we liked the classical or not, we have pretended to do so, to save our faces."

"Jazz is as American as baseball. Jazz is restless, honest, obvious, energetic, vulgar, human, impulsive—a cross section of Yankee human nature in the raw."

"Radio is a refining furnace from which survives the best in jazz music. Gradually a body of music, basically jazz, is being built up that is the first evidence of a truly American folk music."

VIENNA STATION TO INSTALL TELEVISION

BELIN SYSTEM TO BE USED TO TRANSMIT PICTURES

Announcement Has Mixed Reception Because of Invention Selected and Move Thought Premature

By F. M. Delano

VIENNA, Austria.—The new Vienna station looks like being the first broadcasting station in the world to launch out into the broadcasting of pictures by television. It is announced that they have made an agreement with M. Edouard Belin, the French inventor, to adopt his system of television and that M. Belin is coming to Vienna shortly for the purpose of installing the apparatus.

This announcement has had a mixed reception here. While the enterprise of the station is commended, it is pointed out that they may have acted somewhat rashly, as many hold that the Belin system is not at the moment the best. The Karolus method, which has been launched by the Telefunken people, has warm partisans here, while similar claims are made for the invention of a Viennese engineer, Professor Tschorner.

Another line of criticism is that the Kavag, the company which holds the broadcasting monopoly in Austria, would be better advised, pending the evolution of a foolproof television system, to spend what surplus money it may have on improving its programs, which are said not always to be up to the required standard.

428 Applications for New Station Licenses

List Shows Great Publicity Value of Radio Broadcasting

WASHINGTON, D. C.—The department of commerce has just made public for the first time a list of applicants for new broadcasting stations throughout the United States. The list reveals that 428 new broadcasting stations would soon be on the air if there were wave lengths to accommodate them.

According to officials of the department of commerce, the list indicates the great publicity value attached to Radio broadcasting. At the present time there are 536 stations. If licenses could be granted to the new applicants, it would almost double the total number of stations.

Can Keep Clocks Correct

CINCINNATI.—Radio is affording housewives an opportunity to keep their clocks correct. Correct time is broadcast through the Crosley, WLW, station at 11:55 a. m. and whenever the programs are concluded.

BET YOU NOW WISH WE HAD TELEVISION

THE young lady whose picture appears on our cover this issue is Miss Isabel Dawn, one of the new and most interesting stars of the First National Pictures, Inc. Just now she is appearing before the microphone of WJZ, New York, in a series of Radio playlets provided by the film company. She has received a tremendous mail because for her success in the title of "Irene" and when television with Miss Dawn will be the double microphone

WLS Is Teaching Women to Buy Better Quality Fabrics

CHICAGO.—To teach women to know, appreciate and buy the better quality fabrics is the mission of the unique Radio textile school for homemakers, just organized by the Sears-Roebuck Agricultural Foundation over its station here, WLS. Miss Elizabeth Weirick, a noted textile expert, is the director of the new school and will be the principal instructor at its classes, which are held over WLS every Tuesday afternoon from 3 to 4, Central time.

CONTENTS

Radio Digest, Illustrated, Volume XVI, Number 12, published Chicago, Illinois, March 27, 1926. Published weekly by Radio Digest Publishing Co. (Incorporated), 510 N. Dearborn Street, Chicago, Illinois. Subscription rates yearly, Five Dollars; Foreign Postage One Dollar additional; single copies Ten Cents. Entered as second class matter at the post office at Chicago, Illinois, under the Act of March 3, 1879. Title Reg. U. S. Patent Office and Dominion of Canada. Copyright 1926 by Radio Digest Publishing Co. All rights reserved.

All the Live News of Radio.....	1 to 6
Boy Scouts Master Radio Tricks.....	4
Portal Players of WCCO Make Up for Mystery Serial Play.....	5
Women's Page; Index to Women's Programs.....	6
"A Step On the Stairs," Radio Digest Prize Story, Fifth Installment, by Robert J. Casey.....	7
Advance Programs for the Week.....	9 to 16
An Evening at Home with the Listener In; A Chart in Central Time, showing when to listen in for stations.....	17
Editorials, Indi-Gest and Condensed by Dielectric.....	18
1926 Four-Filter Super-Heterodyne, Part III—Assembly and Wiring, by the Technical Editor.....	19
How to Stop Blooping and Man-Made Static, Part VII—51 Types of Interference, by the Technical Staff.....	21
Directory of Radiophone Broadcasting Stations, Part II (Revised).....	23

Looking Ahead

Accused of Piracy, the Veteran Broadcaster, WJAZ, Armed Her Crew to the teeth, hoisted the skull and cross bones and cut her course directly across the air to meet a wandering wave flying the Union Jack. Sulphuric Smith let loose with a triple octave baritone broadside and caught the Hoover bark in a cross-fire. Bloody details in a forthcoming issue of Radio Digest.

It Has to Be Good If It Comes from Milwaukee and that's why the Marquette University-Milwaukee Journal Radio Station WHAD feels obligated to present programs of infinite variety and full entertainment value. Turnverreins and firemen "horn in" to continue the fame of Milwaukee. Read about them, see them in next Radio Digest.

Whose Were the Extra Heads? Who Stepped on Tolliver's Hands? Was someone trying to drug the whole party with ether? Real fireworks begin in the next installment of "A Step On the Stairs." A flashlight throws a weird beam and then strange voices—get new thrills and get your Radio Digest early.

Super-Torrodyn Is An Unusual Super designed by Prof. J. E. Owen of the bureau of tests and measurements at the University of Oklahoma in which the outstanding feature is the use of torroidal coils for the input coupler and the oscillator coupler. The result is no direct pick-up of signals by these units and the only energy traveling the circuits is that which comes in on the antenna. Its construction will be given in the Radio Digest.

Another Raytheon B Power Supply will be presented in the next issue. This uses a compact Jefferson unit combining the transformer, chokes and socket in one case. The wiring is further simplified by the use of a Tobe unit which combines the three filter condensers in one case—wired. Four B voltages of 45, 67, 90 and 135 volts can be obtained.

Newsstands Don't Always Have One Left

WHEN YOU WANT

Radio Digest

YOU WANT IT!

BE SURE OF YOUR WEEKLY COPY BY SUBSCRIBING NOW

SEND IN THE BLANK TODAY

Publisher Radio Digest,
510 N. Dearborn St.,
Chicago, Illinois.

Please find enclosed check M. O. for Five Dollars (Six, Foreign) for One Year's Subscription to Radio Digest, Illustrated.

Name

Address

City..... State.....

KOA Spring Cleaning to Overhaul Antenna

Find Dry Denver Air Keeps Wires from Corroding

DENVER.—Preparatory to the pre-summer broadcasting season, KOA's transmitting equipment and towering antenna system recently were given a rigid spring inspection at the hands of the technical staff members.

"Examination of antenna joints and connections, insulators, etc., are important at this time in anticipation of the usual spring winds," declared C. J. LaGue, chief engineer of the General Electric station.

"We were particularly interested to find a complete absence of corrosion on the antenna wires and down leads," he continued. "This condition, no doubt, is explained by the thin, dry atmosphere at this altitude."

Libel Suit Brought Against Station Dismissed by Court

OKLAHOMA CITY, Okla.—The suit against Station KFJF, here, for \$20,000 for alleged libelous statements made from the station by Rev. McConnell, while the station was leased by him, has been thrown out of court before even being set on the court calendar. The suit was filed by Undersheriff Friss of Oklahoma county, following a widely-advertised talk by Rev. McConnell in which certain matters regarding the official conduct of the officer were mentioned in regard to the liquor industry.

Attorneys for KFJF filed a demurrer, setting up the fact that the station only furnished the equipment under lease; that the Southwestern Bell Telephone company (A. T. & T.) also was a party as their leased wires were involved; also the Oklahoma Gas & Electric company (Billeysby company's subsidiary), as their poles were leased. Following this action, the case was dismissed.

OPEN GOLD CUP AWARD FOR 1926

NEWS BRIEFS FROM THE BROADCASTERS

COOLIDGE TO TRY TO TALK TO SOUTH AMERICA

WHAP Engages New Woodwind Sextette—CKY Invaded by 600 Farmers —Law Series from WEAF

An attempt to transmit the voice of President Coolidge, never before heard outside North America, to the countries of South America will be made April 8, by Stations WRC, Washington, and WJZ, New York, when the president formally welcomes the delegates to the first Pan-American Congress of Journalists to Washington.

The success of the recent series of woodwind concerts given from WHAP has led the studio management to engage the services of a new woodwind sextet, which will be heard for the first time next Friday evening, March 19, at 8:30. This organization, the Philharmonic Woodwind ensemble, is recruited from members of the New York Philharmonic orchestra.

When Winnipeg was "invaded" by more than 600 farmers from North Dakota, recently one of the places surrounded and carried by storm was the CKY studio. The microphone was left open as the visitors passed through the studio and every member of the party—with one or two shy exceptions—said "Hello" to his friends who were listening in at home.

Although but a few minutes in length, one of the most interesting programs broadcast by KFI is the weather forecast of Father Ricard put on the air each Sunday evening at 6:45 p. m. Pacific time. For many years Father Ricard has studied the weather in his little observatory at Santa Clara and has evolved a system of



weather prognostication that has proven to be so accurate that even hardy Californians, usually ready to fight at the drop of a slurring remark about California weather, philosophically resign themselves to their fate when the "Father of the Rains" predicts cloudy weather over KFI for the following week.

A popular series of addresses by leading legal lights of the eastern section of the country will be heard by the listeners of WEAF during the week beginning Monday, April 5. These addresses will deal with the important factors of law and law enforcement and are under the auspices of the American Bar association.

As a result of appearances before the microphones of KPO, Reg. Code, San Francisco orchestra leader, has received an offer to bring his dance group to one of the leading hotels of Shanghai, China.

RULES FOR THIRD GOLD CUP AWARD

BEGINNING with the March 27 issue of Radio Digest, the third annual Radio Digest Gold Cup Award opens. All broadcasting station announcers are eligible for entry, either by themselves or by admirers, the only condition being that use be made of the nomination blank which appears on page 2. The Gold Cup Award is for the purpose of determining the world's most popular broadcasting station

LISTENERS ASKED TO SELECT MOST DESERVING ANNOUNCER

Prepare to Coronate New "King of the Air"—McNamee in 1925 and George Hay in 1924 Were Victors

1924 AND 1925 GOLD CUP WINNERS.



For the third successive year the stage is set for the selection of the world's most popular announcer. Once more the victor will be presented with a solid gold cup, the gift of Radio Digest. The Radio Digest third annual Gold Cup Award is under way, beginning with this issue.

Who will prove to be the 1926 champion announcer? Who is it that has proved himself, this year, dearest to the hearts of most members of the Radio audience?

Listeners who remember the 1924 and 1925 Gold Cup Awards have been wondering and asking when they would be given the opportunity of selecting the 1926 champion. Their questions are answered this week.

The great enthusiasm displayed in last year's Gold Cup Award when Graham McNamee won, and the also warmly contested race of 1924 when George Dewey Hay took the golden trophy, is again expected to be overshadowed by the interest when the balloting starts this year.

Purpose of Award

Radio Digest, realizing the strong contact power of the broadcasting announcer, endeavors with the annual Gold Cup Award to determine by an international vote who is the world's champion master of Radio ceremonies. Listeners in every country of the world are invited to par-

The first two announcers to receive the Radio Digest Gold Cup Award are shown here with the solid gold cup presented last year. Left is George D. Hay, formerly of WMC and WLS, now of WSM, Nashville, who won the first cup in 1924 and was proclaimed world's most popular announcer for that year. Above, Graham McNamee of WEAF, in a pose taken last year just after he had been presented with the 1925 gold cup by Radio Digest. The 1926 cup is shown at the right.



announcer. To him will be presented a solid, 14-carat gold cup, similar to those given the announcer winners of the 1924 and 1925 awards.

The popularity is determined by means of the balloting of readers of Radio Digest using the ballots appearing on page 2 each week during the period of the contest. The winning announcer will be the one polling the largest number of votes.

Contest Rules

1. The contest opens with the March 27 issue when the first ballot appears, and closes with the last ballot in the August 28 issue. No ballots will be received later than midnight, September 4, 1926. These ballots will be numbered consecutively.
2. Anyone may vote with ballots clipped from Radio Digest. Voting consists in filling in the ballots with the name or nickname of the announcer and his station and mailing to the GOLD CUP AWARD EDITOR, Radio Digest, 510 N. Dearborn St., Chicago.

Bonus Votes

3. When sent singly, each ballot counts for one vote. BONUSSES are given your candidate in accordance with the following schedule:

For each four consecutively numbered ballots sent in at one time, a bonus of eight votes will be allowed.

For each eight consecutively numbered ballots, a bonus of twenty votes, etc.

For each twelve consecutively numbered ballots, a bonus of thirty votes, etc.

For a complete series of the consecutively numbered ballots, sent in at one time, a bonus of fifty votes will be allowed.

Prizes Offered

4. The announcer polling the largest number of votes will be declared the world's most popular Radio announcer for 1926 and will be awarded the Radio Digest GOLD CUP. The announcer polling the second largest number of votes will be awarded a beautiful silver loving cup.
5. A beautiful silver loving cup will be awarded to the Canadian announcer receiving the highest vote of all the Cana-

dian announcers entered in the gold cup award contest.

6. In the event of a tie for either of the prizes offered, a prize identical in all respects with that tied for will be awarded to each tying contestant.

7. Any question that may arise during the contest will be decided by the Gold Cup Award Editor, and his decision will be final.

Plan New Cornell Station

ITHACA.—Plans for a 1,000-watt Radio broadcasting station at Cornell university are under way, to rank among the foremost stations in the country. The proposed station will be sponsored by one of the large electric companies, with a gift said to be at least \$15,000 for installatio-

participate in the election of the man or woman to be "king" announcer for 1926 and recipient of the Radio Digest Gold Cup.

The annual competition aims not only to pick the favorite announcers, but to raise even higher the already high standards set for announcing. The past years' awards have proven invaluable in this respect and many Radio performers have shown marked improvement as a result of it. Two insiders of the industry, Mr. J. H. ... and Mr. ... live in ...

Scouts Master Radio Tricks

PRACTICALLY All of 800,000 Boy Members Take Keen Interest in Receiving and Sending Skill—Award Merit Badges

By MARSHAL TAYLOR

ROBINS are back, buds are swelling on the trees, frogs are singing, faint vernal odors tinge the vagrant breezes. Up through vibrant earth mold in the woodlands violets and adder tongues are pushing their tender heads to the warm spring sunshine. Happy hiking days are here, the happiest and most invigorating of all the seasons. And oh for the Boy Scouts with tingling sinews and eager feet tramping on the spongy moss, clambering over the wet stones and skipping through the brooklets of bubbling springs!

Come on, boys, we're off! Hop into the old flivver and away we go to Swallow Cliff and the forest preserve. Let's take supplies for Saturday, Sunday and breakfast on Monday morning at sunrise. What have we? Here is a slab of bacon. Run down to the delicatessen for some weenies—those fat kind—and some buns, hot dogs, Oh Boy! Don't forget to bring half a dozen cans of pork and beans. What else? Ah, the Radio outfits! By all means! What Boy Scout camp is complete these days without Radio—sending and receiving?

Gather around here, Scouts. Which one of you on this trip has an amateur's license? Mickey Meyers—good for you Mickey. Get your stuff together and we'll make a place for it in the back. Too bad you can't get away this time, Bob, but you and Mickey fix it up to signal about six tonight. You will be home from the dentist's by then and we'll tell you what we are doing. What do you say?

Morrell and Allen can bring the big super-het in the other fliv and we'll get the music when the stars are out.

All right! Let's go.

* * * *

"A RECENT questionnaire sent to Boy Scouts throughout the country," writes E. S. Martin, secretary of the editorial board in New York, "revealed that 95 per cent of them either owned Radios or wanted to. The membership is nearly 800,000, a solid unit working together."

"In Boy Scout camps, the use of the Radio and the interest in it are practically universal, and have been for some time; a Boy Scout troop not having a Radio outfit is a rare exception. This is evident even in the winter camps where six hundred Boy Scouts camped during the holidays at Interstate Park of New York and New Jersey. Radio sets were almost as common as snowshoes and skis."

Boy Scouts of the Brooklyn Edison company (right) assembled a Radio set while at camp near Lincoln Park, N. J., and spent the evening listening in on broadcast programs. Below are two New York Scouts in their week-end camp near Swallow Cliff in a forest preserve—a two-hour flivver ride from their home.

Here is what a Boy Scout must do to win one of those badges:

1. Receive and send correctly not less than ten words per minute.
2. (a) Explain how to get in communication with another station.
(b) Explain how to send a message in proper form.
3. Tell in own words the principal laws and regulations regarding Radio communication.
4. Demonstrate at least ten of the radiogram abbreviations (Q signals).
5. (a) Explain the purpose of a detector and adjust a crystal detector, using a buzzer to test its adjustment.
(b) Name two minerals used in crystal detectors.
6. Draw from memory, using correct symbols, a hook-up diagram of a complete vacuum tube transmitting apparatus, including generator or batteries, vacuum tube, condenser, tuning helix key, antenna, ground, and the necessary protective devices. Describe each part of the apparatus and explain its function. Explain how to use a wave meter in connection with this transmitting apparatus to secure the proper wavelength of radiation.

(Continued on page 8)

Scout Fred Clark of Chicago in contact with his home town through a short wave receiving set in Boy Scout camp at Owasippi, Whitehall, Michigan.

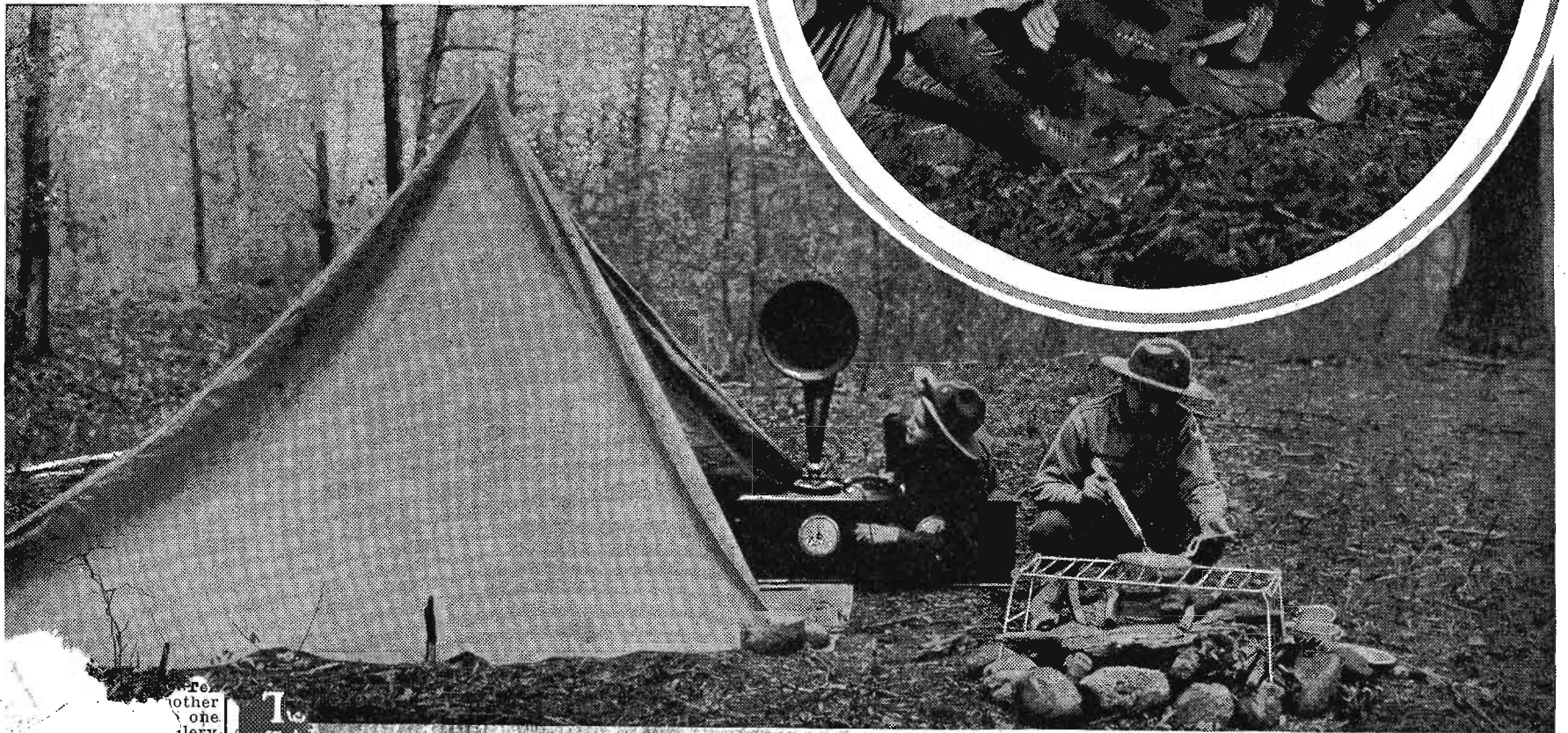

For
other
one
library
Dear-

To
67 A

Twin Cities Thrilled by "SOS"

Portal Players Put Realism in Radio Mystery Drama at Station WCCO. Mythical Station Causes Furore. Many World-Famous Stage Celebrities Make Debut in Minnesota

By HAROLD P. BROWN

WHEN Longfellow wrote the classic legend of Hiawatha and Minnehaha, he left out one of the most ancient and honorable pleasantries about the Twin Cities, both of which seem to have a reasonable claim to Minnehaha Falls. The famous poet forgot to remember that it was said of old when these two cities grow until they merge into one they shall take the name of "Minnehaha" with Minneapolis taking the "Minne" and St. Paul taking the

Have a care there, Hari Singh! I did not say it! Stand back, I tell you! I saw the cruel glitter in your eye as you thrust your head from behind that curtain across the page. What is that clenched in your hand behind those velvet folds—Ah! Ha!



But Hari Singh does not move. Nor should he. He is one of the famous Portal Players of the Gold Medal Station WCCO, and little cares he for such moss-grown crudities as this mirthless jibe. Hari Singh as he crouches there, motionless, is doubtless listening to a tap-tap-tap in the hallway of the old Turner manse where Lawyer Ardwyn has arranged for the late Peleg Turner to try to speak to his relatives from his grave through a Radio loudspeaker.

These are the WCCO players in the characters of the first great Radio mystery serial, "A Step On the Stairs."

THEY are typical of the brilliance and capability of this big broadcasting station of the Northwest. If ever the twain shall meet—St. Paul and Minneapolis—at a common municipal council, Gold Medal Station WCCO will deserve its share of credit for the unity. Never before was there such a powerful bond between them. Figuratively the station towers stand respectively in the two separate cities, one on the Union station in St. Paul and the other on the Nicollet Hotel in Minneapolis. And from the long span of this theoretical antenna WCCO speaks as one to the whole world. Its motto is "Service to the Northwest."

There is a world of energy and purpose in this station. The staff immediately seized upon the new idea "A Step On the Stairs" as an important phase of Radio entertainment. Going about the business at once of making the most of the opportunity, Mr. H. A. Bellows, manager of the station, and Miss Helen R. Fish, director of the players, arranged for a dress rehearsal and a stage setting to correspond as nearly as possible with the scene described in the story. Each character was chosen because of his or her special talents and understanding of the theme. Each one studied his part seriously and attentively to get over to the unseen audience the utmost intended by the author.

* * *

HOW well the ensemble succeeded is told in a letter by E. H. Gammons, publicity manager of the station. He wrote as follows:

"After listening to two rehearsals of the first episode of 'A Step On the Stairs' last night, I am a trifle shaky today. Although I was entirely familiar with the script, knowing it almost line for line, I must admit that when I sat in the reception room and listened to them monitor the play last night, the cold shivers ran up and down my spine in a way that they haven't for many years, not even during the coldest Minnesota weather. I don't believe Crawford, our colored porter, who listened in with me, will ever be the same color again. We go on at 10:05 tonight, and, unless I am badly mistaken, we have a knockout."

That speaks well for both the WCCO Portal Players, their interpretation, and the scheme of the play. Apparently the presentation fulfilled his entire expectations for the next day he wrote again. There were the usual letters and telephone calls of appreciation but—

"The most amusing thing in connection with the broadcast," said Mr. Gammons, "was that hardly had we completed it when telephone calls began to come in complaining that some station, FYY, had come on the air right on our wave length at the critical moment of the play and blanketed us. In fact one St. Paul listener was so excited about it that he didn't get the call letters and accused one of the small 50-watt stations in the neighborhood of having come on the air" (Continued on page 16)



Sinister and brooding are the eyes of Hari Singh, portrayed by Vernon C. Miller (above) at WCCO. Joseph LeVander (right) is the ghost of Peleg Turner and speaks with sepulchral tones.

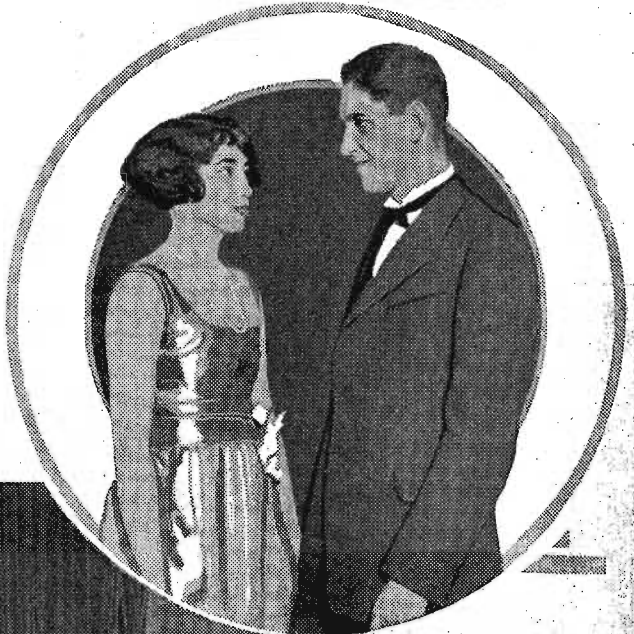

By careful rehearsing Helen R. Fish (top), director, made "A Step On the Stairs" seem real to WCCO listeners. Cousin William (J. C. Nelson) and Aunt Helen (Katherine Jefferies) above. Portal Players, listening (right).



"I love you, marry me," insisted Henry Graves, a mysterious guest in the haunted home of the Turners, as he whispered to Mary Williams. Graves is played by Paul Thur (above) and Mary Williams is played by Florence Murphy.

SECRETS OF SALAD BY BETTY CROCKER

MANY COMBINATIONS GIVE LIMITLESS VARIETY

Numerous Tasty Dishes May Be Made by Blending of Different Colors and Flavors

Have you heard, and do you regularly listen for Betty Crocker's Radio talks? Miss Crocker is nationally known as a home food specialist who is broadcasting from a dozen of the country's largest stations. By special arrangement Radio Digest has secured a series of exclusive articles by Miss Crocker dealing with her current Radio talks. These broadcasts are made through WEEL, WEAJ, WCAE, WGR, WEAJ, WJW, WDAF, WJAR, WHT, WFI, KSD, KFI, and WCCO, the Gold Medal station at Minneapolis-St. Paul. All of Miss Crocker's recipes and discussions are based upon actual investigations and work of herself and her assistants in model kitchens.—Editor's Note.

By Betty Crocker

I AM sure that our lesson today is a popular one. In fact, I do not believe there is a more popular subject in the whole realm of cookery than salad. We are always looking for new salads, and the nice part of it is, we usually find them, because the number of possible combinations is practically limitless. Since we make salads of fruits, vegetables, meats, nuts, cheese, eggs and gelatine, it should be easy to have practically a different salad every day of the year. However, that is unnecessary as we prefer to serve our favorite salads over and over again.

Blend Colors and Flavors

I sometimes think we have gone too far in working out new salad combinations, as some of them are rather weird. Often they present a beautiful appearance and yet are unappetizing. Food should be attractive to the eye, and yet by no means should it offend the stomach. An over-decorated salad looks fussy and stuffy, just like an over-decorated room or an over-dressed woman. If you are a real artist, you can combine colors and flavors in a salad as an artist combines colors on a canvas. The different parts of the salad should blend together as tones of music to make one harmonious whole. Be careful that you do not allow a false note

INDIVIDUALIZING THE FASHIONS HER WORK



"Georgette"

she is heard every Monday and Thursday at 11:30 a. m. Central time. "Georgette" is a style dictator, specializing in presenting original fashions for all the different types of figures and at the Chicago office, over 400 letters a day asking "what to wear" are answered personally by Miss George.

to creep in, either as to color or flavor. Salad material should always be crisp and fresh. A wilted salad presents a most discouraged appearance, and is decidedly unappetizing.

Food Values Vary

The food value of a salad varies greatly, according to the ingredients used. A substantial salad may serve as the main dish for lunch or supper. The more simple salads although not so substantial are equally valuable for the acids, minerals, and vitamins they supply to the body. At this time of the year, it is especially important that we serve salads if we would avoid bitter spring tonics later on. Fruit and vegetables are most important in our winter diet. During the cold months, it is not always easy or even possible to get fresh green salad foods, but there are so many possibilities for winter (Continued on page 17)

SHORT WAVES

By Marcella

Miss Blarney and another, indeed, several others, want full details about Gayle V. Grubb, or "Gloomy Gus," of Nebraska Buick's KFAB at Lincoln, Nebr. Only knowing that the fraternity pin he happens to be wearing is Sigma Phi Epsilon, I dropped him a note. He answered so well, I shall not retouch his letter:

"Now to begin with your old man here, 'Gloomy Gus,' likes the girls, especially the little girls, and I have quite a correspondence with little kids all over the country. I might tell you that my eyes are blue except when my wife hits me, and then they are black. What hair I have left is sort of a mahogany brown. After a heavy meal I weigh about 150 pounds and I stick up in the air about 5 feet, 11 inches.

"As you can gain by the foregoing, I am married, have one child—a girl—going to enter her at Atlantic City in about 15 years. I am not a bit ashamed to tell you my age is a good ripe 30.

"As to what I like and dislike, I am a hand for poetry. I spend most of my spare time writing little foolish songs which are one feature of this station. With Wendell Hall, you know, I wrote 'I Don't Think So,' and my little song on 'Etiquette' will be published next week.

"Regarding my dislikes, I hate persimmons and alum. That's all but in the event you would like to know something about my clothes, I might say that next week the suit I have on is mine, having squared up with the tailor. Also have my own teeth and wear size 10 shoes."

I regret to have sad news for "Pearl" and "F.T.M." who inquired about Frank Morris, formerly one of the "Boss' Own" entertainers at WTAS, Elgin, now WLIB. Frank died about a year ago from a chronic illness.

Saw Phillips Carlin of WEAJ and he admits that he is happily married. "Phil" is about 5 feet, 7 inches tall and of generous proportions which total 192 pounds ringside. His hair is black; eyes, brown. He likes fishing and golf. Invite him out some time. His dislikes are many. For instance, a number of people call him "cute," that always goes against

New Women's Program Is Feature of WHAD

Milwaukee Station Adds Home Service to Aid Housewives

MILWAUKEE.—In line with the increasing popularity of Radio among women, WHAD has recently added a new service. Planning a dinner, serving a new salad for supper, or arranging a party menu is an easy matter when all the housewife need do is tune in and take notes on the suggestions that Mrs. Ella Liner Lambert broadcasts on Thursday mornings.

Her talks include such subjects as "Better Breakfasts," "A Valentine Luncheon," "Meatless Menus," "Cakes Without Shortening," "Dinners from Left Overs," "Ways of Cooking Inexpensive Cuts of Meat," "Sunday Night Suppers," and other information useful to housewives in the preparation of daily and party menus.

The recipes are given slowly enough so that all of the listeners may jot them down. Mrs. Lambert also answers questions which Radio listeners ask by mail.

his grain. Another thing he abhors is going into a place and having someone say: "Oh, is he the announcer?" He has even been accused of being the Silver Masked Tenor—a distinction that he cannot claim. No children. He is exceptionally good looking.

The "Silver Masked Tenor" is of average height, about 5 feet, 6 inches tall and weighs in the neighborhood of 180 pounds. His hair is black and his eyes are—well, look at them behind the mask, they're, oh, girls, they're a baby blue! And the mask certainly does show them off to good advantage. Someone accused him of being with the Royal Typewriter orchestra. He isn't! He is very much married and has the cutest little boy eight months old. He dislikes people talking about the Silver Masked Tenor in his presence. He is quite a song writer, and recently finished a song that he dedicated to his wife. It's called "Maureen Mavoreen," and it has a nice air to it—one that you would like him to sing.

(Continued on page 17)

WOMEN'S PROGRAMS INDEX

Saturday, March 27				Tuesday, March 30				Friday, April 2			
Eastern	Central	Mountain	Pacific	Eastern	Central	Mountain	Pacific	Eastern	Central	Mountain	Pacific
9:30 a. m.	8:30 a. m.	7:30 a. m.	6:30 a. m.	9:30 a. m.	8:30 a. m.	7:30 a. m.	6:30 a. m.	9:30 a. m.	8:30 a. m.	7:30 a. m.	6:30 a. m.
WWJ (352.7m-850kc) Tonight's dinner.				WWJ (352.7m-850kc) Tonight's dinner.				WWJ (352.7m-850kc) Tonight's dinner.			
11	10	9	8	11	10	9	8	11	10	9	8
WEAR (389.4m-770kc) Home service talk.				WJZ (454.3m-640kc) Women's hour.				WJZ (454.3m-640kc) Women's hour.			
WHT (399.8m-750kc) Women's club, Jean Sargent.				WRC (468.5m-640kc) Women's hour.				WRC (468.5m-640kc) Women's hour.			
12 n.	11	10	9	12 n.	11	10	9	12 n.	11	10	9
WGN (302.8m-990kc) Household hints.				WGN (302.8m-990kc) Household hints.				WGN (302.8m-990kc) Household hints.			
WQJ (447.5m-670kc) Home Economics program; "Stories about Famous Pictures," Margery Curroy.				WQJ (447.5m-670kc) Home Economics program; "Stories about Famous Pictures," Margery Curroy.				WQJ (447.5m-670kc) Home Economics program; "Stories about Famous Pictures," Margery Curroy.			
12:30 p. m.	11:30	10:30	9:30	12:30 p. m.	11:30	10:30	9:30	12:30 p. m.	11:30	10:30	9:30
WGN (302.8m-990kc) Discussion of fashions.				WGN (302.8m-990kc) Discussion of fashions.				WGN (302.8m-990kc) Discussion of fashions.			
12:35	11:35	10:35	9:35	12:35	11:35	10:35	9:35	12:35	11:35	10:35	9:35
KYW (535.4m-560kc) Table talk.				KYW (535.4m-560kc) Table talk.				KYW (535.4m-560kc) Table talk.			
1	12 n.	11	10	1	12 n.	11	10	1	12 n.	11	10
KGW (491.5m-610kc) Household helps, shopping guide.				KGW (491.5m-610kc) Household helps, shopping guide.				KGW (491.5m-610kc) Household helps, shopping guide.			
KMA (252m-1190kc) Domestic science topics.				KMA (252m-1190kc) Domestic science topics.				KMA (252m-1190kc) Domestic science topics.			
4	3 p. m.	2 p. m.	1 p. m.	4	3 p. m.	2 p. m.	1 p. m.	4	3 p. m.	2 p. m.	1 p. m.
KJR (384.4m-780kc) Tonight's dinner.				KJR (384.4m-780kc) Tonight's dinner.				KJR (384.4m-780kc) Tonight's dinner.			
6:30	5:30	4:30	3:30	6:30	5:30	4:30	3:30	6:30	5:30	4:30	3:30
CNRV (291.1m-1080kc) Women's talks.				CNRV (291.1m-1080kc) Women's talks.				CNRV (291.1m-1080kc) Women's talks.			
Monday, March 29				Wednesday, March 31				Thursday, April 1			
Eastern	Central	Mountain	Pacific	Eastern	Central	Mountain	Pacific	Eastern	Central	Mountain	Pacific
9:30 a. m.	8:30 a. m.	7:30 a. m.	6:30 a. m.	9:30 a. m.	8:30 a. m.	7:30 a. m.	6:30 a. m.	9:30 a. m.	8:30 a. m.	7:30 a. m.	6:30 a. m.
WWJ (352.7m-850kc) Tonight's dinner.				WWJ (352.7m-850kc) Tonight's dinner.				WWJ (352.7m-850kc) Tonight's dinner.			
10	9	8	7	10	9	8	7	10	9	8	7
WJZ (454.3m-640kc) Women's hour.				WJZ (454.3m-640kc) Women's hour.				WJZ (454.3m-640kc) Women's hour.			
WRC (468.5m-640kc) Women's hour.				WRC (468.5m-640kc) Women's hour.				WRC (468.5m-640kc) Women's hour.			
WTAG (268m-1120kc) Talk, Marjorie Woodman, nurse.				WTAG (268m-1120kc) Talk, Marjorie Woodman, nurse.				WTAG (268m-1120kc) Talk, Marjorie Woodman, nurse.			
10:50	9:50	8:50	7:50	10:50	9:50	8:50	7:50	10:50	9:50	8:50	7:50
WMC (499.7m-600kc) Home economics discussion, Miss Kitty.				WMC (499.7m-600kc) Home economics discussion, Miss Kitty.				WMC (499.7m-600kc) Home economics discussion, Miss Kitty.			
11	10	9	8	11	10	9	8	11	10	9	8
WEAR (389.4m-770kc) Home service talk.				WEAR (389.4m-770kc) Home service talk.				WEAR (389.4m-770kc) Home service talk.			
WHT (399.8m-750kc) Women's club, Jean Sargent.				WHT (399.8m-750kc) Women's club, Jean Sargent.				WHT (399.8m-750kc) Women's club, Jean Sargent.			
WNVC (526m-570kc) Women's program.				WNVC (526m-570kc) Women's program.				WNVC (526m-570kc) Women's program.			
WTIC (475.9m-630kc) "Professional Candy-Making," Dorit Weigert.				WTIC (475.9m-630kc) "Professional Candy-Making," Dorit Weigert.				WTIC (475.9m-630kc) "Professional Candy-Making," Dorit Weigert.			
11:15	10:15	9:15	8:15	11:15	10:15	9:15	8:15	11:15	10:15	9:15	8:15
WTIC (475.9m-630kc) "Canning—Why—What and How," Olea M. Sands.				WTIC (475.9m-630kc) "Canning—Why—What and How," Olea M. Sands.				WTIC (475.9m-630kc) "Canning—Why—What and How," Olea M. Sands.			
11:30	10:45	9:30	8:30	11:30	10:45	9:30	8:30	11:30	10:45	9:30	8:30
KFAB (370.7m-880kc) "Difference in Dresses," WTIC (475.9m-630kc) Housewife's forum.				KFAB (370.7m-880kc) "Difference in Dresses," WTIC (475.9m-630kc) Housewife's forum.				KFAB (370.7m-880kc) "Difference in Dresses," WTIC (475.9m-630kc) Housewife's forum.			
11:45	10:45	9:45	8:45	11:45	10:45	9:45	8:45	11:45	10:45	9:45	8:45
WDAF (365.6m-880kc), WHT (399.8m-750kc), WJAR (305.9m-930kc) Home service talk, Betty Crocker.				WDAF (365.6m-880kc), WHT (399.8m-750kc), WJAR (305.9m-930kc) Home service talk, Betty Crocker.				WDAF (365.6m-880kc), WHT (399.8m-750kc), WJAR (305.9m-930kc) Home service talk, Betty Crocker.			
12	11	10	9	12	11	10	9	12	11	10	9
WGN (302.8m-990kc) Household hints.				WGN (302.8m-990kc) Household hints.				WGN (302.8m-990kc) Household hints.			
WQJ (447.5m-670kc) Home Economics program. "Dried and Canned Tropical Fruits," Maud Jacobs. "Specialty Baking Talk," Clove Carney.				WQJ (447.5m-670kc) Home Economics program. "Dried and Canned Tropical Fruits," Maud Jacobs. "Specialty Baking Talk," Clove Carney.				WQJ (447.5m-670kc) Home Economics program. "Dried and Canned Tropical Fruits," Maud Jacobs. "Specialty Baking Talk," Clove Carney.			
12:15 p. m.	11:15	10:15	9:15	12:15 p. m.	11:15	10:15	9:15	12:15 p. m.	11:15	10:15	9:15
KYW (535.4m-560kc) Meat talk.				KYW (535.4m-560kc) Meat talk.				KYW (535.4m-560kc) Meat talk.			
12:30	11:30	10:30	9:30	12:30	11:30	10:30	9:30	12:30	11:30	10:30	9:30
WEBH (370.2m-810kc) Fashion and household talks.				WEBH (370.2m-810kc) Fashion and household talks.				WEBH (370.2m-810kc) Fashion and household talks.			
12:35	11:35	10:35	9:35	12:35	11:35	10:35	9:35	12:35	11:35	10:35	9:35
KYW (535.4m-560kc) Table talk.				KYW (535.4m-560kc) Table talk.				KYW (535.4m-560kc) Table talk.			
2:30	1:30 p. m.	12:30 p. m.	11:30	2:30	1:30 p. m.	12:30 p. m.	11:30	2:30	1:30 p. m.	12:30 p. m.	11:30
KFNH (263m-1140kc) Mothers' hour.				KFNH (263m-1140kc) Mothers' hour.				KFNH (263m-1140kc) Mothers' hour.			
WGY (379.5m-730kc) Cooking lesson, Jessie Lane. "The Trend of Spring Hats," Charlotte Weiss.				WGY (379.5m-730kc) Cooking lesson, Jessie Lane. "The Trend of Spring Hats," Charlotte Weiss.				WGY (379.5m-730kc) Cooking lesson, Jessie Lane. "The Trend of Spring Hats," Charlotte Weiss.			
3	2	1	12 n.	3	2	1	12 n.	3	2	1	12 n.
WCCO (416.4m-720kc) Women's hour.				WCCO (416.4m-720kc) Women's hour.				WCCO (416.4m-720kc) Women's hour.			
Put on WSOE (246m-1220kc) Cooking chats.				Put on WSOE (246m-1220kc) Cooking chats.				Put on WSOE (246m-1220kc) Cooking chats.			
amazing	3	2	1 p. m.	amazing	3	2	1 p. m.	amazing	3	2	1 p. m.
moments (508.2m-500kc) Market hints for housewives.				moments (508.2m-500kc) Market hints for housewives.				moments (508.2m-500kc) Market hints for housewives.			
instruc (483.6m-620kc) Home management schedule, \$1.00				instruc (483.6m-620kc) Home management schedule, \$1.00				instruc (483.6m-620kc) Home management schedule, \$1.00			
1	12 n.	11	10	1	12 n.	11	10	1	12 n.	11	10
WFAA (475.9m-630kc) Homemakers program.				WFAA (475.9m-630kc) Homemakers program.				WFAA (475.9m-630kc) Homemakers program.			
WMAQ (447.5m-670kc) Foibles of the Moment.				WMAQ (447.5m-670kc) Foibles of the Moment.				WMAQ (447.5m-670kc) Foibles of the Moment.			
5	4	3	2	5	4	3	2	5	4	3	2
KJR (384.4m-780kc) Home helps.				KJR (384.4m-780kc) Home helps.				KJR (384.4m-780kc) Home helps.			
KYW (535.4m-560kc) Woman's hour.				KYW (535.4m-560kc) Woman's hour.				KYW (535.4m-560kc) Woman's hour.			
5:15	4:15	3:15	2:15	5:15	4:15	3:15	2:15	5:15	4:15	3:15	2:15
WMAQ (447.5m-670kc)				WMAQ (447.5m-670kc)				WMAQ (447.5m-670kc)			
5:30	4:30	3:30	2:30	5:30	4:30	3:30	2:30	5:30	4:30	3:30	2:30
KOA (322.4m-930kc) Housewives matinee.				KOA (322.4m-930kc) Housewives matinee.				KOA (322.4m-930kc) Housewives matinee.			
6	5	4	3	6	5	4	3	6	5	4	3
KOA (322.4m-930kc) Culinary hints, Clara Hoover.				KOA (322.4m-930kc) Culinary hints, Clara Hoover.				KOA (322.4m-930kc) Culinary hints, Clara Hoover.			
6:15	5:15	4:15	3:15	6:15	5:15	4:15	3:15	6:15	5:15	4:15	3:15
KOA (322.4m-930kc) Fashion review, Sally Dee.				KOA (322.4m-930kc) Fashion review, Sally Dee.				KOA (322.4m-930kc) Fashion review, Sally Dee.			
7	6	5	4	7	6	5	4	7	6	5	4</

a STEP ON the STAIRS

By ROBERT J. CASEY

Radio Dramatization by FRED SMITH

Illustrations by HILMER C. OLSON

Synopsis of Preceding Chapters

IN THE first place, who killed Jeremiah Turner? Here is a chronicle of the weird and mysterious event that led up to the present installment of "A Step On the Stairs."

Jeremiah Turner was found dead, a bullet hole through his head, in the old Turner manse. His body was carried through the front door, sealed except in time of death. His brother, Peleg, sought solution of crime. Peleg's body soon afterward followed through the door of death, a tradition maintained in the old manse for one hundred years. Relatives were summoned by Peleg's will to midnight seance in room where Jeremiah was killed. Mysterious stranger arrives from bay and disappears on way to house where he told caretaker he had been summoned. John Carton, a favorite nephew known to have been in the vicinity the night of the murder, is missing. He had been seen by Mary Williams, his sweetheart and distant cousin, talking to Hazel Stanton, another relative, outside the house at the time of the murder. Guests, admitted by Hari Singh, East Indian servant, sit in darkened hall-room waiting for Peleg's voice from the grave, through loud speaker. At the critical moment Station F.Y.X. interferes. A scream and pistol shot are heard from the station. One of the engineers is found to have been shot according to report of Tolliver, one of the cousins who had been sent to investigate.

Ardwyn is about to read a letter Tolliver brought from the shooting affray and which he said had been dropped by the gun man. Mary Williams sighs, faints, knocks candle from table, plunging room in darkness. Ardwyn exclaims and says some woman bit him on the wrist. When lights are restored, Mary is still in faint, but letter is gone. Milford Jones, "the bearded pirate" is also found missing and Aunt Helen and Cousin William insist the front door—the door of death—has been opened. All had heard the mysterious steps on the

stairs, coming and going and an SOS distress signal. Ardwyn advises all to leave room for refreshments. Mary remains. Henry Graves returns to talk to her, urges his suit for her hand. She repulses him. He insinuates she has a guilty knowledge and was not in her seat when room was in darkness and letter disappeared. He leaves and Ardwyn enters. He shows her locket tangled on his chain when woman bit him. She admits ownership, but says some other person must have used it to divert suspicion.

Mary convinces Ardwyn of her sincerity when she points to shoes left by a strange intruder and suggests that he will return for them. Ardwyn remains with her. The light flickers out. The door opens. Mary screams that she felt a corpse. Ardwyn rushes to the floor, a gash in his head. Hari Singh identifies scarf seized from "corpse" by Miss Williams as one he had put on Peleg Turner at time of his burial.

Hazel Stanton helps bring Mary back to consciousness and Ardwyn recovers from his daze. Suggesting that Mary needs air and quiet, he advises the others to return to the other room. Then he leaves to find her a stimulant. Mary hears a step on the stairs. A man enters the room. It is John Carton, her fiancé. She is amazed, as he is supposed to be in hiding. He tells her he is there to prevent another murder planned for the occasion. He denies that he knows Hazel Stanton. Voices are heard. He thinks he is trapped. Hari Singh enters and secretly lets him out of side door. Before he can return, others are in the room and ask about the voices heard talking with Mary Williams. Hari Singh himself answers, calling for help. He is dragging a body into the house from without. Whose was the body? Read about it in the following installment. Radio Digest will supply reprints of the past four installments for twenty-five cents on application to the Mystery Story Editor.

THE STORY CONTINUES

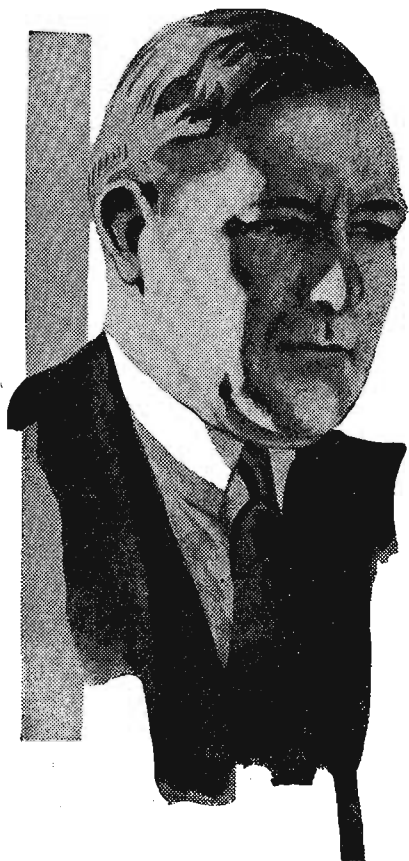

"I have a suggestion," snarled Henry Graves who was waiting at the hall door to help Hari Singh remove the unconscious man to an upper room.

CHAPTER NINE

The War Council

"**W**HO is it?" wailed Aunt Helen Holmes. "Won't somebody please look . . . won't somebody?"

There were other whimpered queries from the crowd whose terror was fast becoming voiceless. And then, suddenly, boomed the jarring announcement of Henry Graves.

"Why, it's the bearded pirate," he shouted almost joyously. "Our friend, Milford Jones, who left us so suddenly."

"Yes, that's his name, Milford Jones, I remember now," contributed Hari Singh.

"The man who went out through the front door," continued Hari Singh. "And his skull seems to be crushed."

No one was paying any attention to Mary Williams. Henry Grave's cry had stopped her in the midst of an eerie laugh. Now she stood staring through the crowd at the still figure on the floor of the hall.

"Milford Jones," she repeated as if attempting to convince herself. . . . "Oh, thank God. Thank God!"

They carried the body of Milford Jones into the hallway and laid him out on a rug where the light from the library fell across his face.

"He is not dead," diagnosed Hari Singh. "But he is very far gone. Would the Sahib Ardwyn suggest that I telephone for a doctor?"

"Yes," agreed Ardwyn. "Unfortunately it will take a long time for a doctor to get here. What makes you think his skull is crushed?"

"Look here," Hari Singh suggested. "There is a deep ragged gash in his forehead—no bullet or knife ever caused that."

"Telephone for the state police while you're about it, then. . . . And get Jones upstairs to bed and under covers. He must be frozen in addition to everything else."

"And now, all of you ladies and gentlemen, be seated once more and we shall see if we can get to the bottom of this."

"I don't want to go into that room again," wailed Aunt Helen from the hallway. "There's death in it and you can't see it."

"I am free to accept suggestions for a better council chamber, Mrs. Holmes," Ardwyn told her. "We can't get out of the house until daylight anyway and so

long as we're in here one spot is quite as safe as another."

The woman sighed throatily. "Oh very well," she said. "It's not that I'm afraid of anything. My conscience is clear."

"**P**LEASE be seated, everybody," advised Ardwyn. "The state of our consciences will not excuse us from the work we have at hand." The guests moved reluctantly to their chairs and huddled back in silence.

"Now then," began Ardwyn from his old place at the head of the table. "We shall make some arrangements for our own protection. . . ." He paused as the voice of Hari Singh, telephoning to the police filtered across the hall.

"No . . . Not dead . . . Dying . . . Beaten on the head . . . Yes, come at once and bring a doctor . . . Bring . . . Hello . . . Hello." And then in a louder more irritable tone . . . "They have cut us off. I think the wire has been blown down."

"We shall be largely on our own resources here until morning," Ardwyn went on, "and it might be well for us to do what should have been done earlier in the evening—learn more about one another . . . Does anybody in this room or in sound of my voice know what happened to Milford Jones?"

"I have a suggestion," snarled Henry Graves who was waiting at the hall door to help Hari Singh remove the unconscious man to an upper room.

"Yes, Mr. Graves," prompted Ardwyn.

"I think you might make a good beginning and save some time if you were to ask Miss Williams just where she fits in this picture. I heard her talking to someone in this room a moment ago when the rest of us were in the library. I don't think she was talking to herself."

"I heard her, too," declared Aunt Helen. "I heard her voice and I was sure I heard a man's voice . . . They were very low but I have good ears."

The company, seemingly glad of a target, any target, turned its combined attention on the girl. She paled perceptibly.

"I-I don't remember," she said. "I stayed here because my nerves were too upset for me to move . . . But I don't remember any conversation . . . Maybe you heard me talking with Mr. Ardwyn."

"Mr. Ardwyn was in the kitchen looking for something," pursued Aunt Helen. "There was no trouble at all making out his voice."

The situation was tense for Mary Williams and she showed plainly that she felt it.

"I—really I—" she stopped helplessly and then a new factor entered the scene. A tall figure brushed by Henry Graves and took attention away from the girl with a single word.

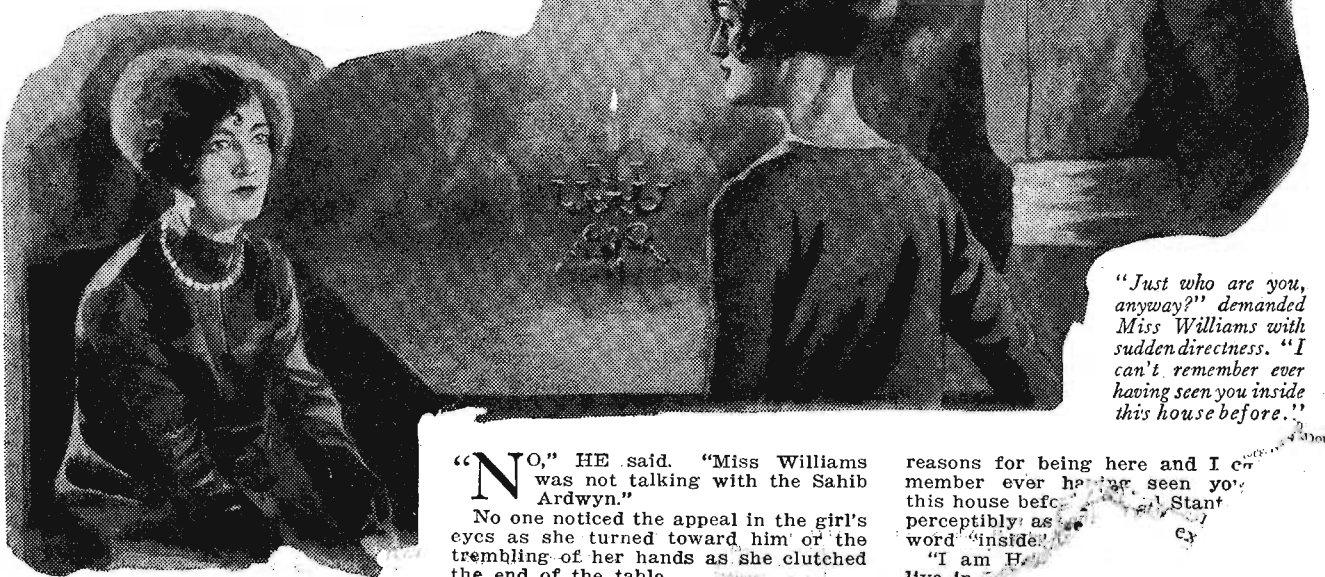

"Just who are you, anyway?" demanded Miss Williams with sudden directness. "I can't remember ever having seen you inside this house before."

"**N**O," HE said. "Miss Williams was not talking with the Sahib Ardwyn."

No one noticed the appeal in the girl's eyes as she turned toward him or the trembling of her hands as she clutched the end of the table.

"God help us," she prayed. But that too went unnoticed for her voice was only a thin echo.

"The Sitt was not talking with the Sahib Ardwyn," repeated Hari Singh with much emphasis. "She was talking to me, Hari Singh. She told me she felt a draft and thought that the side door might have blown open. I went there and tried the door. It was closed but unlocked. I opened it and looked out and so found Mr. Jones."

"There's something very unusual about that," declared Aunt Helen. "I heard that voice and it certainly didn't sound like yours."

"I am sorry, Madame," apologized the Indian. "I tried so hard to make it sound like my own and if it sounded like anything else I shall be desolated."

"One moment, Hari Singh," came an unexpected interruption. The eyes of the crowd shifted back once more toward Mary Williams who once more had risen in her place. She was still pale, still nervous, but her voice had a sharp, vibrant quality in it that showed she was no longer afraid.

"Yes, Miss Williams," replied Hari Singh respectfully. "You wish to speak to me?"

"Not to you, Hari Singh," the girl said evenly. "I wish to speak to Aunt Helen Holmes. I should like to know by what right and for what purpose she has been casting innuendoes at me ever since we sat down to dinner. Mr. Ardwyn has suggested that the time has come for explanations. I can see no better place to begin them than right here and no better person to start them than Mrs. Holmes."

"I never heard such impertinence," declared Aunt Helen. "Do I understand you to be accusing me of—well what is it you're accusin' me of?"

"Nothing," stated Mary Williams evenly. "I'm not speaking to you any more than to the rest. All of you have fixed on me to be the butt of your charges. I want to know why."

"It's only that you're so aloof, my dear," broke in Hazel Stanton with poisonous sweetness. "It is only natural that a crowd with nerves jaded as ours have been should look with suspicion on the outsider. . . . You know you did knock over the candle, and you did stay here when we went into the library, and you were talking with someone in here—even if it was Hari Singh as he so gallantly confesses."

"**J**UST who are you, anyway?" demanded Miss Williams with sudden directness. "If we are going to get to the bottom of this affair we might find out first something of our

reasons for being here and I can't remember ever having seen you inside this house before. . . . Stanton perceptibly as the word 'inside' . . . "I am H. . . . Uve in . . ."

of a second cousin of Peleg Turner. And I do not concede your right to cross examine me."

"What are you doing in this house?" pursued Miss Williams relentlessly.

"I came here for the same purpose you did," declared Miss Stanton, flushing and paling by turns. "I was invited here."

"Were you invited here the night Jeremiah Turner was murdered?"

"Mr. Ardwyn," appealed the harrassed Hazel, "I demand your protection. This woman has no right to question me, she has no right to cloud the issue by directing suspicion toward others merely because it has been directed toward her. Everyone here tonight—Miss Williams excepted—has remained with the company."

"No, Miss Stanton," came the calm voice of Hari Singh. "The Sitt forgets one other who left the company. We need not count Sahib Jones for he is beyond explanation. The Sitt, if I may remind her, was also away from the others for a brief time. . . . When she left the house to take the air in the blizzard. She will recall no doubt that it was she who opened the side door and that it was she who brushed back almost unnoticed into the house when I was picking up the body of Sahib Jones."

CHAPTER TEN

Hark! From the Tomb

MISS STANTON parted her red lips to speak but was silent. Her pallid skin was deathlike in the glow of the candle and her eyes, wide open now and frightened, burned angrily in shadowy recesses.

"What if I did go outside?" she demanded. "Is it likely that I could ever be a match physically for a man of the stature and strength of Milford Jones?"

"That is beside the point," broke in Ardwyn. "Let us be fair in this thing. We were accusing Miss Williams of something—we do not seem to be agreed on the matter of the indictment—and we were basing our accusations on the fact that she did not display social instincts. What is sauce for the goose. . . ." He paused.

"That is different," the Stanton girl countered warmly. "Everyone knows that I was in the library until just a moment before we came in here. What if I did wander out onto the front porch? I was not gone long enough to bite anyone's wrist or fracture anyone's skull. Perhaps I went out there merely in an attempt to find out why Hari Singh's voice had seemed so different when he was talking with Miss Williams. . . . You, as a lawyer, should know, Mr. Ardwyn, that there is no shred of evidence by which I can possibly be suspected of anything except monumental foolishness in coming here at all."

"We shall come to no purpose in arguing about it, Miss Stanton," the lawyer said. "I think it is plain that none of us could have had a hand in the assault on Mr. Jones."

"The police will be here some time before morning and they may have the task of finding out just who is guilty of what. In the meantime we are losing sight of the mission that brought us here."

"We couldn't well help it, you know," broke in Cousin William. "We were a bit distracted. Yes! Yes!"

"I shall admit that, Mr. Caryl. I shall admit that the causes for distraction are not yet removed. But I cannot forget that as Mr. Turner's representative on this earth I called you here tonight for something more serious than bickering about voices in the dark. Compose yourselves, ladies and gentlemen, and at least until the police come, let us try to remember that we are Mr. Turner's guests, just as if he were alive."

"I don't enjoy bein' a dead man's guest," declared Aunt Helen Holmes. "My poor husband, dead and gone these twenty years, would never have permitted me to stay here this long compromisin' my reputation with men that disappear out of locked rooms and get their skulls crushed."

"IT IS not too much to hope that the trouble has ceased for the night," Ardwyn answered her imperturbably. "At any rate, we cannot sit around doing nothing and there is still a chance that Peleg Turner may be able to bring to us the help that he hoped to bring when he was dying. But I shall leave it entirely to your own judgment, ladies and gentlemen. Shall we go on with this experiment?"

"Suits me," voted Tolliver affably. "I'm immune. My hair is standing up so straight now that nothing can make it any straighter and I've heard so many shrieks in the night that a few more wouldn't make me bat an eye. . . . Me, I'm all for goin' on with the show."

"I agree with Mr. Tolliver," put in Henry Graves. "I don't think anything will come of it. But I believe that we can force some of our friends here out into the open if we go ahead. Somebody was going a way to stop this affair and I'd like to know how."

"Thank you are stating the case a little better," commented Ardwyn. "But at any rate, or perhaps I may, of continuing the rules and gentle."

\$500 in Gold FOR THE SOLUTION OF "a Step On the Stairs"

REPRINTS NOW AVAILABLE

SO MANY people are attempting to win part of the \$500 in Gold prizes which are being offered for solutions to "A Step On the Stairs," a reprint of the first four installments has been printed and may be had for the nominal charge of twenty-five cents, in coin or stamps, to cover the cost of handling. Address your order to the Mystery Story Editor, care of Radio Digest.

The chosen stations, which will broadcast "A Step On the Stairs," in Radio play form, are given on page nine. The days and the hours are listed.

THE PRIZES

The prizes are seventeen in number. First prize is \$250; second prize is \$100; third to seventeenth prizes inclusive, are \$10 each. In the event of a tie for any prize offered, a prize identical in all respects with that tied for will be awarded to each tying contestant.

HOW TO WIN A PRIZE

Nine installments of Mr. Casey's story will be published consecutively

each week. The first appeared in the February 27 issue. His tenth and final installment will not appear until the prize winning solutions have been selected by the judges. The solution nearest correct, that is, nearest to unraveling the mystery accurately, will win. The method of preparing the solution—its neatness, legibility, etc.—shall be considered.

RULES OF CONTEST

- 1. Solutions must be received not later than midnight of Saturday, May 1. The ninth installment of the story will appear in the April 24 issue. The author's intended and final chapter will appear in the May 15 issue, together with the announcement of the winners' names.
2. The contest is open to everyone except employes of Radio Digest and their families.
3. Contestants pay no fee and need not be subscribers to Radio Digest. Solutions, however, must be written upon one side of paper.
4. The decision of the judges, to be named later, will be final.

A grumbled assent that seemed virtually unanimous greeted his query.

"Very well, then," he decided. "We shall renew our attempt to communicate with Mr. Turner. Let us begin by fixing in our minds the cause of his strange request that we come here:

"Jeremiah Turner was murdered in this very room. John Carton, favorite nephew of the Turners, disappeared at the time. "Peleg Turner came home here to take charge of his property and died almost immediately under circumstances that all of us who were close to him have believed to be peculiar, if not mysterious.

"We gathered here in this room at his invitation as expressed in the letter that he wrote to me just before his death to listen as he attempted to communicate with us over the Radio.

"Now I should like to call to your attention that nothing that has happened tonight has changed the original situation. Someone opened the barred front door that has never been used except to provide an exit for the coffins of the lords of the manor in death. Someone precipitated a riot in the broadcasting station to which our Radio receiver was tuned at midnight. Someone dropped a letter, presumably incriminating, on the floor of the Station F.Y.X. power house. Someone, presumably interested in that letter, bit my hand in the dark and stole the evidence. Milford Jones got out of this room through locked doors and barred windows and was found with his skull crushed. But these events, nerve racking in themselves, have contributed nothing to the solution of the mystery that brought the curse on this house. It is my suggestion that we put out the light, and sit here as we sat before, holding hands if necessary to prevent our nerves playing tricks on us, and listen for the promised word from Peleg Turner"

A WAIL that seemed to come from nowhere made itself heard over the minor noises of the storm.

"What was that?" queried Aunt Helen tremulously.

"I have seen from an upstairs window," came a call from Hari Singh. "There is a boat out on the bay—a steamship. She seems to be in trouble. . . . Her lights have gone out."

"Sit quiet, everybody," commanded Ardwyn. "There is nothing we can do. If the boat has put into the bay there is a coast guard station near her."

There was a murmur of dissension. "The Sahib speaks true," stated Hari Singh. "Her lights have gone out. We could not see her if we wished."

"We have a duty to perform right here," repeated Ardwyn. "A duty to the man whose dying wish brought us here. And it is bitter cold out there in the storm. . . ."

"Suits me," acquiesced Tolliver.

"Put out the light, then," ordered Ardwyn. "Hari Singh will lock the hall door."

"Going out anyway," said Tolliver, clapping the fluttering wick between his palms. "There it's out—and, oh boy, how I miss it."

"Be quiet now," suggested Ardwyn. "I have switched on the Radio."

From the outer distance came another wail of the ship's siren. The ensuing silence was awesome by contrast—terrible in its completeness.

"Why can't we have a light?" wailed Aunt Helen. "It's all just as it was before."

Something terrible is going to happen."

"Quiet," muttered Ardwyn. "There is a voice on the Radio. I can hear the generators at F.Y.X."

"I hear something else," moaned a woman. "Listen. . . . We heard it before. . . . The step on the stairs. . . ."

It was plainly audible as the frightened men and women sat breathless in the dark—the creaking of stairs and the tapping sound—three short taps—three widely spaced taps—three short taps.

"What can that be?" came the awed voice of Mary Williams. "Who is it walks up and down those stairs?"

"THIS is Station F.Y.X.," boomed the Radio announcer in startling incongruity. "Miss Miriam Hartley will next sing Tosti's 'Good Bye.'" And in spite of themselves, the eleven listened though the creaking of the stairs

BOY SCOUTS AND RADIO (Continued from page 4)

- 7. Draw from memory, using correct symbols, a hook-up diagram of a complete receiving apparatus, using a vacuum tube detector, including antenna, two-circuit tuner, detector, fixed and variable condensers, resistances, batteries, phones and ground. Describe each part of the apparatus and explain its functions.
8. Describe a vacuum tube and explain its three principal uses, namely as detector, amplifier and oscillator.
9. Explain the differences between continuous wave, modulated or interrupted continuous wave and spark signals. Explain how each kind of a signal is produced and how each kind is received.
10. Construct with your own hand a practical working receiving set and demonstrate its operation for receiving signals from a station 25 miles or more away.
11. Explain how to install an antenna, how to connect it to the sending and receiving set, how to ground it properly and how to protect it against lightning. State the Underwriters' laws for safeguarding Radio apparatus.

Mr. Martin explains how the boys use Radio to carry on their good work:

"Do a Good Turn Daily." Such is one of the mottoes of the Boy Scouts. Radio is helping them to make the motto alive and real for themselves and for the people they aid and befriend.

"Good turns are done daily by the Scouts using Radio receiving apparatus. Concerts and lectures are given in hospitals and similar institutions; invalids, the bed-ridden and the shut-in are cheered up, and in some cases funds are raised and receiving instruments purchased or constructed by troops to be given to those who may need them.

"This is taking place everywhere. The Boy Scouts comprise the picked youth of the country—it is no wonder that in every state they have been quick to realize the advantages of Radio broadcasting not only for themselves but for others, and have acted on their understanding.

"So popular has Radio become with the Scouts that on the staff of Boys' Life, the official Boy Scout magazine, is a Radio expert, whose duty is to answer the numerous inquiries submitted by Radio fans. A department on Radio has been included in the magazine."

Well, here we are on Swallow Cliff. Let's run the aerial across to that big oak on the other side of the ravine. While Mickey is getting the apparatus together the rest of us will gather some dry wood and start a fire for supper. A match! On this side Allen, can't you see where the wind is? Zowie! There's a flame for you—almost took an eyebrow, didn't it! Bring on that grid and the hot dogs!

came as a weird accompaniment to the singer and the wail of the siren broke frequently through the wild organ obbligato of the storm.

. . . "Good bye summer, good bye, good bye. . . ."

The singer broke off in the midst of a phrase and then came the strained tones of the announcer.

"Station F.Y.X. will stand by for a few minutes," he said. "There is a ship in trouble on Pelican Bay."

From the outer hall echoed the creaking stairs and the regularly spaced taps. . . . three dots, three dashes, three dots. . . . SOS . . . an incomprehensible message to be lost in a moment as the Radio set picked up the harmonic of a ship's wireless. . . . "SOS"—a blatant, whining message that brought terror even to those who could not read it.

"SOS," translated the voice of Tolliver.

"SOS," telegraphed the unseen operator aboard the ship out there on the moaning bay.

And then the hellish symphony of the Radio faded out and a man's voice came slowly, clearly, distinctly through the noises of atmospheric disturbance.

"MY FRIENDS, I bring you a message," said the voice, and a shriek answered him.

"Peleg Turner," screamed a woman in a voice that terror had distorted beyond identification. "Peleg Turner!"

"Do not be alarmed," came the hollow tones from the loud speaker as if the scream of fright had been heard beyond the grave. . . . "I am happy here and I wish no harm to any of you except the one who killed by brother. . . ."

A man swore under his breath. The wind howled in the chimney with peculiar malevolence.

"I am speaking to that one," the voice continued. "I could not rest in my grave without attempting to right the wrong that one did. And I am warning that one, that before daylight, the price will be exacted!"

"My friends, my loved ones, the murderer is in this house where you are listening to my voice. And I curse the murderer. . . ."

The voice died away; the whirring noises of the receiver increased in volume and the whining of the code broke in once more. . . . SOS . . . SOS . . .

"My God," shrieked Hazel Stanton, "let me out of here! Let me out of here. . . ."

Who felled Milford Jones? What disconnected the telephone as Hari Singh called for help? What does Hazel Stanton know? Peleg Turner speaks from his tomb—and accuses a person now in the Turner manse. Read the thrilling effect of this message in the next week's Radio Digest.

Hello, what you want, Mickey? Better hurry up the dogs are sizzlin'! What's that? You got Bob already? Say, you're a whiz. Think you ought to have one of those Boy Scout Radio Merit badges. Tell Bob to take a good sniff. This bacon certainly smells good. Bring the key over closer to the fire, Mickey. Atta boy! Where's Morrell? Funny, you never can find that boy when you want him. Music! Hooray! Now we are all set. These are the happy days, what say, boys! Yee-ow-wow-wow!

OPEN GOLD CUP AWARD

(Continued from page 3)

loving cups. One will be given to the second most popular announcer at the end of the 1926 Gold Cup Award, and the other will be presented to the Canadian announcer finishing at the top of the list of Canadian candidates.

Last year D. R. P. Coats, of CKY, Manitoba Telephone System station at Winnipeg, was highest among the Canadian announcers and was presented with a silver loving cup by Radio Digest after the 1925 Gold Cup Award had ended. It was decided to make this an annual feature.

How to Nominate and Vote

On this page the rules regulating the Gold Cup Award are listed. Any one may make nominations, using the nomination blank appearing at the top of page two. Any one may vote, using the ballot blanks as they are published weekly in Radio Digest during the period of the contest which will not close until August 28 issue.

In voting, however, it is emphasized that the ballots, Number 1 of which appears on page two, will count for many more votes if saved in consecutive series, and cast all at one time. The bonus vote schedule is explained in the rules.

Kenneth G. Moffatt Dies

VICTORIA, B. C.—Mr. Kenneth George Moffatt, "Victoria's Radio Genius" succumbed here recently after a lingering illness, his death marking the passing of one of the greatest pioneers and authorities on Radio that the Dominion has produced.

Mr. Moffatt was the first to broadcast by remote control in British Columbia. He was also one of the first to open a broadcasting station in British Columbia. For a number of years he operated Station CHCE.

ADVANCE PROGRAMS FOR THE WEEK

Saturday, March 27

Headliners Today

Eastern 7:30 p. m.	Central 6:30 p. m.	Mountain 5:30 p. m.	Pacific 4:30 p. m.
WEAF (491.5m-610kc) Chambrade trio.			
WBEI (348.6m-860kc) Boston symphony.			
8:25	7:25	6:25	5:25
WJZ (454.3m-660kc), WGY (379.5m-790kc), WRC (468.5m-640kc) Philharmonic orchestra.			
8:30	7:30	6:30	5:30
WIP (508.2m-590kc) Junior boxing meet.			
9	8	7	6
WSM (282.8m-1060kc) Barn dance program.			
10:30	9:30	8:30	7:30
WBP (475.9m-640kc) Hired Hand's Little symphony.			
11	10	9	8
KPO (428.3m-700kc) band concert.			
KPRC (296.9m-1010kc) Silverstring players.			
12:45 a. m.	11:45	10:45	9:45
KGO (361.2m-830kc) "A Step on the Stairs," mystery serial.			
1 a. m.	12	11	
KFI (467m-640kc) Frolic.			

Saturday, silent night for: CFAC, CFCA, CNRA, CNRC, CNRE, CNRM, CNRR, CNRT, CNRV, CNRW, KFDK, KFKX, KFMX, KFRU, KFUD, KFXF, KLM, KMA, KQAC, KOB, KQP, KSCA, KSO, KTAB, KUOA, KWSC, WABQ, WBAL, WCAL, WCX, WDDD, WEOA, WGBJ, WEBW, WEMC, WGBF, WGPC, WHP, WGR, WGST, WHAD, WHAZ, WHN, WHO, WIP, WJAR, WJAZ, WKQA, WKAR, WLIT, WLWL, WMAZ, WDAI, WOS, WRVA, WTAG, WTIC, WWJ.

Eastern Time Stations

CHIC, Toronto, Can. (356.9m-840kc), 10:30 p. m., Al Linton's dance orchestra.

CKNC, Toronto, Can. (356.9m-840kc), 4 p. m., CKNC instrumental quintet; Mrs. Harry Hodgetts, soprano; S. Charles E. Bodley and his dance orchestra.

CNRO, Ottawa, Can. (435.9m-688kc), 8 p. m., Chateau Laurier concert orchestra; 9, Trip to the Gold and Silver Mines of Ontario and Quebec; 10:45, Chateau Laurier dance orchestra.

KDKA, Pittsburgh, Pa. (309.1m-970kc), 6:30 p. m., Westinghouse band; 8:30, Westinghouse band.

PWX, Havana, Cuba (400m-750kc), 8-9 p. m., Ward organ recital; 9-10, Hotel Sevilla-Biltmore orchestra; 11:10-12, Victor Rodriguez orchestra.

WAHG, Richmond Hill, N. Y. (315.6m-954kc), 12 midnight, Club Castle dance orchestra.

WBZ, Springfield, Mass. (333.1m-900kc), 6:45 p. m., Hotel Kimball orchestra; 7, Capitol theater orchestra; 7:30, music; 7:45, Repertory theater orchestra; 8:15, Untly mixed quartet; 9:15, Edward J. McHugh, baritone; C. P. McCarthy, accompanist.

WCAE, Pittsburgh, Pa. (461.3m-650kc), 6:30 p. m., dinner concert; 8:15, Youngstown artists.

WEAF, New York, N. Y. (491.5m-610kc), 6-7 p. m., dinner music, Hotel Waldorf-Astoria; 7-8, Madrigal quartet; Chambrade trio; Evelyn Grief, dulcinea artist; 8:15, Shakespeare hour, "The Tempest"; 9:30, WEAF musical comedy troupe; 10, Ross Gorman and orchestra; 11-12, Vincent Lombardi and orchestra.

WEEI, Boston, Mass. (348.6m-860kc), 7:10 p. m., D. and L. Slade company, musicale; 8, Boston Symphony orchestra.

WIP, Philadelphia, Pa. (394.5m-760kc), 6:30 p. m., Bellevue Stratford concert orchestra; 7, Bellevue Stratford dance orchestra; 8, "The Seven Last Words," choir of Haws Avenue M. E. church; 11, Bellevue Stratford dance orchestra.

WGBS, New York, N. Y. (315.6m-950kc), 6:30 p. m., Vincent Storey trio; 7:30, Hebrew Orphan Asylum Harmonica band; 8, First Bandonian orchestra; 8:30, Clifford Chesley, numereology; 8:40, Herald male quartet; 9, Zitter string trio; 9:40, Carroll Drake, pianist; 10:30, Arrowhead Inn orchestra.

WGCP, New York, N. Y. (252m-1190kc), 8 p. m., orchestra; 8:30, Andy Razaf and Paul Denicker; 4:15, Joe Turkel, tenor; 4:30, orchestra; 5, Harvey Schloemann, songs; 5:15, orchestras; 8:30, Strickland's orchestra; 9, Ukulele Bob McDonald; 9:20, June Lee, singing vagabond; 9:35, Totman and Gallant, banjo duets; 10:10, Yama Yama Boys; 10:30, Strickland's orchestra.

WGHE, Clearwater, Florida (266m-1130kc), 6:30-7:30 p. m., Harold Crocker and his Gater orchestra; 7:30-7:45, Giles W. Quarles, "King of the Mandelalies"; 8:30-9:30, "The Realtrobadores"; 11:45-1 a. m., Harold Crocker and his Gater orchestra.

WGR, Buffalo, N. Y. (319m-940kc), 2:30 p. m., WGR's afternoon program.

WGY, Schenectady, N. Y. (379.5m-790kc), 6:30 p. m., Onondaga hotel program; WPBL; 8:25, WJZ; 10:30, dance program.

WHAR, Atlantic City, N. J. (275m-1090kc), 2 p. m., Seaside hotel trio; 8, Seaside hotel trio.

WIP, Philadelphia, Pa. (394.5m-760kc), 8:15 p. m., song recital, Albert Mahler, tenor; 8:30, Junior National Boxing championships, U. S. A.; 10:05, El Patio dance orchestra; 11:05, organ recital, German-town theater.

WJR, Pontiac, Mich. (516.9m-580kc), 7 p. m., Storm-feltz-Lovely serenaders; 9, music, Jean Goldkette, director; 10, orchestra; 11:30, Jewett Radio Jesters.

WJZ, New York, N. Y. (454.3m-660kc), 7 p. m., Hotel Commodore concert orchestra; 8:25, Philharmonic Society of New York student concert, WRC, WGY.

WLIT, Philadelphia, Pa. (394.5m-760kc), 7:30 p. m., Benjamin Franklin hotel concert orchestra.

WMAK, Buffalo, N. Y. (265.3m-1130kc), 6:15-7:15 p. m., dinner music; 7:30-8:30, musicale; 8:30-9, Wolff's Furniture Store, Inc.; 9-10:30, musicale; 10:30-11, Maltop, Inc., Toddy manufacturers.

WMOA, New York, N. Y. (340.7m-880kc), 6 p. m., Oicott Vail and Hotel McAlpin string ensemble; 6:30, Parody orchestra; 10:30, Creole follies; 11, Ernie Golden and Hotel McAlpin orchestra; 12, McAlpin entertainers.

WNTC, Boston, Mass. (280.2m-1070kc), 6 p. m., "The Smilers"; 6:30, Shepard Colonial orchestra; 8, Knickerbocker club and artists; 9, varied program; 10, Lambert Brothers' orchestra; The Plunkerters; 11, Copley Plaza dance orchestra; Jack Fay, singer.

WNYC, New York, N. Y. (526m-570kc), 7 p. m., song recitals; 7:35, Herman Neuman, pianist; 8-10, Metropolitan Museum of Art symphony concert; 10, songs; 10:10, dramatic readings, Harriette Weems.

WOO, Philadelphia, Pa. (508.2m-590kc), 7:30 p. m., Adelphia French Room orchestra.

WPG, Atlantic City, N. J. (299.8m-1000kc), 6:45 p. m., organ recital, Arthur Scott Brook; 7, Hotel Morton music; 8, dinner program; 9, Hotel Ambassador orchestra; 10, Nick Nichols' orchestra; 11, orchestra; Elks home.

WRC, Washington, D. C. (468.5m-640kc), 7 p. m., Hotel Washington orchestra; 8:25, WRC; 10:30, Meyer Davis' Swane symphony; 11:30-12, Otto F. Beck, organist.

WRO, Lansing, Mich. (283.5m-1050kc), 6-7 p. m., Speed-Wagon serenaders and Gold Standard ensemble; 10-12, serenaders.

WTAM, Cleveland, Ohio (389.4m-770kc), 6-7 p. m., Royal Canadians; 8-9, Hotel Hollenden orchestra; 9-12, Er Jones and gang.

WTIC, Hartford, Conn. (475.9m-630kc), 6:30 p. m., Skinny and his gang; 6:50, Hotel Bond trio; 8:30, Helena Carlene Hines, reader; 8:45, recital; 10:30, Carroll's Palais Royal orchestra.

Central Time Stations

KFAB, Lincoln, Nebr. (340.7m-1000kc), 8:30-10:30 p. m., variety program by staff artists; 12-2 a. m., orchestra entertainment.

KFNH, Shenandoah, Iowa (263m-1140kc), 7 p. m., concert; 11, old-time fiddling.

KLDS, Independence, Mo. (440.9m-680kc), 8 p. m., Temple concert orchestra, First M. E. church choir.

"a Step On the Stairs" Broadcast as a Play

EPISODE FIVE—THE SETTING

WE ARE still in the haunted hunt-room of the old Turner manse. The guests are still waiting for the voice of Peleg Turner to return from the grave through the Radio loud speaker to tell of the mysterious murder of his brother. Suspicions have turned from one to the other of the guests. Lawyer Ardwyn was about to read a letter when the lights went out. In the darkness he gave a cry of pain. Later when the lights had been returned, he said a woman had bitten him on the wrist. The letter had disappeared. Mary Williams repulsed Henry Graves, another guest who asked to marry her. His wooing was interrupted by Ardwyn, the lawyer, who returned to the hunt-room after bandaging his wrist. Ardwyn and Mary are left alone. Ardwyn shows her necklace caught on his watch chain which Mary admitted was her own. The two sit waiting for the door to open. The candle goes out. The front door, supposed to be securely locked and barred, swings open, a figure enters. Mary cried that she has felt the body of a corpse. Ardwyn falls to the floor, a gasp in his hand. The other guests find them there and a scarf from Peleg's shroud is found clutched in her hand. They are revived. They are unable to explain what has happened. Hazel Stanton assists Mary and on advice of Ardwyn she is left alone to recover her senses. John Carton, a nephew, suspected of the murder slips into the hunt-room. He bids Mary to believe in him, that he is there to prevent another murder planned for the night and that he has summoned the police. Mary is surprised and seeks to hide him when other guests are heard approaching. Hari Singh assists him out the side door. Mary is questioned about the voices. Hari Singh calls for help and drags in Milford Jones who had disappeared from the room earlier in the evening.

THE CAST

Frederick Ardwyn.....Peleg Turner's lawyer
Aunt Helen Holmes.....A relative
Henry Graves.....A mysterious man Mary had known formerly
Hari Singh.....Indian servant of Peleg Turner
Mary Williams.....A youthful guest
Maurice Tolliver.....A youth and relative
Hazel Stanton.....A young lady
Cousin William Caryl.....A relative
Miriam Hartley.....A singer

WHERE AND WHEN TO DIAL

WOC, Davenport, Iowa. Fifth episode at 10:30 p. m. Central time, on Friday, March 26. Sixth episode same time, April 2. (483.6m-620kc).

WOAW, Omaha, Neb. Fourth episode at 8 p. m. Central time, Saturday, March 27. (526m-570kc).

KGO, Oakland, Calif. Fifth episode at 9:45 p. m. Pacific time, Saturday, March 27. (361.2m-830kc).

KOA, Denver, Colo. Fifth episode at 8:30 p. m. Mountain time, Tuesday, March 30. (322.4m-930kc).

WCCO, Minneapolis-St. Paul, Minn. Fifth episode at 10:05 p. m. Central time, Tuesday, March 30. (416.4m-720kc).

WGY, Schenectady, N. Y. Fifth episode at 8:15 p. m. Eastern time, Friday, March 26. Sixth episode same time April 2. (379.5m-790kc).

WMAQ, Chicago, Ill. Fifth episode at 9 p. m. Central time, Wednesday, March 24. Sixth episode same time March 31. (447.5m-670kc).

WNAC, Boston, Mass. Fifth episode at 8:30 p. m. Eastern time, Wednesday, March 24.

Sixth episode at same time March 31. (280.2m-1070kc).

WEAN, Providence, R. I. Play broadcast by direct wire from WNAC, Boston, on same schedule as WNAC therefore. (270.1m-1030kc).

WHO, Des Moines, Iowa. Fifth episode at 2:30 p. m. Central time, Monday, March 29. (526m-570kc).

WRC, Washington, D. C. Fifth episode at 8:15 p. m. Eastern time, Friday, March 26. Sixth episode same time April 2. (468.5m-640kc).

WLW, Cincinnati, Ohio. Fifth episode at 8:30 p. m. Central time, Saturday, March 27. (422.3m-710kc).

WOR, Newark, N. J. Fifth episode at 10:30 p. m. Eastern time, Saturday, March 27. (405.2m-740kc).

WBAP, Fort Worth, Texas. (475.9m-630kc). First episode at 11 p. m. Central time, Thursday, April 1.

WSB, Atlanta, Ga. (428.3m-700kc). Schedule will be announced over air.

KRPS, Hot Springs National Park, Ark. (374.8m-800kc). Schedule to be announced over air.

KMA, Shenandoah, Iowa (252m-1190kc), 9-11 p. m., pipe organ recital, William Howie.

KMOX, St. Louis, Mo. (280.2m-1070kc), 6 p. m., Arthur Ull, organist; 6:30, Mrs. Jacques Landree, organist; 7, orchestra; Mary Noble, soprano; English, Scotch and Welsh program; 8, mixed program; 9, James Haley, old-time fiddler; Edward Goessling, baritone; 10, popular program, orchestra.

KPRC, Houston, Tex. (296.9m-1010kc), 8 p. m., pipe organ recital, O. Mueller; 8:30, Frank Tillon, grand pianist; 10, Silverstring players.

KSD, St. Louis, Mo. (545.1m-550kc), 7 p. m., Grand Central theater.

WAMD, Minneapolis, Minn. (244m-1230kc), 6:15 p. m., dinner concert, George Osborn and his orchestra; 7:10, Harmony Twins, Fred Roble, Bob Melcher, orchestra.

WBAP, Fort Worth, Texas (475.9m-630kc), 6-8:30 p. m., Chief Gonzalez' Texas hotel orchestra; 7:30-8:30, music, Mrs. W. D. Smith; 9:30-11, the Hired Hand's Little symphony; 10, Hired Hand's Truth society.

WCCO, Minneapolis-St. Paul, Minn. (416.4m-720kc), 6:15 p. m., St. Paul hotel concert orchestra; 8:15, musicale; 10:05, Nicollet hotel orchestra.

WFAA, Dallas, Texas (475.9m-630kc), 8:30-7:30 p. m., Baker hotel orchestra; 8:30-9:30, Oak Cliff-Dallas Commercial association varied program; 11-12, Jack Gardner's orchestra, Adelphius hotel.

WGES, Oak Park, Ill. (250m-1200kc), 8-9 p. m., orchestra, organ; 11-1 a. m., entertainment.

WGN, Chicago, Ill. (302.8m-990kc), 6:30-6:45 p. m., Drake concert ensemble, Blackstone string quintet; 6:45-6:55, old-time favorites; 6:55-7, "The Million Song"; 8-8:10, Auld Sandy; 8:10-8:30, Drake concert ensemble, Blackstone string quintet; 8:30-9:30, light opera quartet; 9:30-10, Hawaiian music; 10, Sam "n' Henry; 10:10, old-time favorites; 10:20, play shop; 10:40-11, studio ensemble.

WHAD, Milwaukee, Wis. (275m-1090kc), 6 p. m., Wisconsin theater orchestra.

WHAS, Louisville, Ky. (399.8m-750kc), 7:30-9 p. m., Town club, Louisville Conservatory of Music.

WHT, Chicago, Ill. (399.8m-750kc), 10 a. m., Jean Sargent's program; juvenile program and studio features; 11, Mike Rizzo, boy violinist; 12 noon, organ recital, Al Carney; 6 p. m., classical program; Al Carney, organist; Grayling's string trio; W. A. Dyck, man, basso; Leola Aikman, soprano; Hugh Aspinwall, tenor; (238m-1260kc) 7:45-9:15, musical features, Cinderella cafe orchestra; (399.8m-750kc) 9:30, Kitchen Klezmer program; 9:50, symphony; 10:30, Cinderella cafe orchestra; 12, Your Hour league, Pat Barnes and Al Carney.

WIBO, Chicago, Ill. (225.4m-1130kc), 6-8 p. m., dinner concert; Robert Wessling, baritone; vocalists, reader, string trio.

WJAZ, Chicago, Ill. (322.4m-930kc), 9-2 a. m., dance program, Opera club.

WJDD, Mooseheart, Ill. (370.2m-810kc), 12-1 p. m., Palmer House symphonic players; Palmer House trio; 2-3, Howard L. Peterson, organist; 4-5, Palmer House quintet; 5:30-7, dinner hour; 8-9, Palmer House Victorians; 10-11, Palmer House Victorians; 12-1 a. m., Palmer House Victorians; Jack Nelson.

WKAF, Milwaukee, Wis. (261m-1150kc), 8:30-9:45 p. m., Hi Coleman's orchestra; Louis Rabadreau, baritone.

WKRC, Cincinnati, Ohio (325.9m-920kc), 10 p. m., Marion McKay and his orchestra, Swiss Gardens; Marie Turner, blues singer.

WLIB, Chicago, Ill. (302.8m-990kc), 7:30-8 p. m., musical program; 11-11:20, Correll and Gosden; 11:20-1 a. m. studio ensemble, dance music, harmony duos.

WLS, Chicago, Ill. (344.6m-870kc), 7:15-12 p. m., National barn dance and WLS twin wheeze.

WLW, Cincinnati, Ohio (422.3m-710kc), 7 p. m., organ concert, Johann Grosse; 7:40, meeting, Secretary Hawkins club; 8, barnyard symphonies, Uncle Charley Warner and his Coon Dog orchestra; 8:30, "A Step On the Stairs," Robert Casey; 9, Uncle Charlie Warner and his orchestra; 9:30, Castle Farm.

WMAQ, Chicago, Ill. (447.5m-670kc), 6 p. m., Chicago theater organ; 6:30, Mendel Ritley, trombone player; 8, Daw and Pratt; 8, Mendel Ritley, trombone; Capt. Kitroy Harrison; 9, Balaban and Katz Chicago theater Radio revue.

WMBB, Chicago, Ill. (250m-1200kc), 7-8 p. m., This

non ensemble; 9-11, Trianon orchestra; Woodlawn theater orchestra; Alice O'Brian, piano specialties; MeFarwin and Beiber, harmony duo; Clinton Keithley, tenor.

WMC, Memphis, Tenn. (499.7m-600kc), 8:30 p. m., musical program, Walter Moore.

WOAW, Omaha, Neb. (526m-570kc), 6 p. m., Kallco Kids; 6:15, Herb Feilerman and his orchestra; 7, speakers' hour; 9, de luxe program; 10:30, Frank Hodek and his Nightingale orchestra; 11, Arthur Hays and his organ jubilee.

WOC, Davenport, Iowa (483.5m-620kc), 9-10 p. m., Howard A. Carroll, tenor; Fay Parrmann, pianist; Grace Loosely, reader; 11-12, LeClaire hotel orchestra; song numbers, Peter MacArthur, baritone.

WOK, Chicago, Ill. (217.3m-1300kc), 4:30-7 p. m., Howard Will, tenor; 10-1 a. m., dance music; Capitol theater program.

WQI, Chicago, Ill. (447.5m-670kc), 3-4 p. m., Koffee Klatsch; special musical feature; Jerry Sullivan; Rose Vanderbosch, soprano and pianist; artists; 7-8, Jack Chapman and his Rainbo Garden concert orchestra; 10-3 a. m., Jack Chapman's orchestra; Jerry Sullivan; Rose Vanderbosch, pianist and soprano; Everett Opie, reader; Clarence Theders, tenor; Oxford Girls, harmony singers; Rita McKavanaugh, Marie Bieber, harmony duo; West Brothers, guitarists; Gail Bandell, melodiana.

WRF, Dallas, Texas (245.8m-1220kc), 6-7 p. m., Jack Gardner's orchestra; 8-9, Henry A. Magnuson, tenor; 12-1 a. m., pipe organ recital, Melba theater; Lindsey Stephens, baritone.

WSAI, Cincinnati Ohio (325.9m-920kc), 7:50 p. m., WSAI Radio chime concert; 8:15, the Bicycle Playing Card sextet; 12, Frank Sander's orchestra.

WSM, Nashville, Tenn. (282.3m-1060kc), 7:15 p. m., Francis Craig's orchestra; 8, barn dance program.

WSDI, Milwaukee, Wis. (245.8m-1220kc), 9 p. m., Lakefront studio musical program.

WSUI, Iowa City, Iowa (483.6m-820kc), 7:30 p. m., Wm. G. Edmondson, tenor; Mrs. Geraldine Ristline, pianist.

Mountain Time Stations

KFWA, Ogden, Utah (260.7m-1150kc), 9-10 p. m., Ole Reeves and his orchestra; 10-11, Merry Mad music makers, Paramount theater; 11-12, Ole Reeves and his orchestra.

KFXF, Colorado Springs, Colo. (250m-1200kc), 9 p. m., Rosemary Gardens orchestra.

KOAF, Denver, Colo. (322.4m-930kc), 8 p. m., American classics, Phil Mo Alpha; 10:15, Scheuerman's Colorado orchestra.

Pacific Time Stations

KFI, Los Angeles, Calif. (467m-642kc), 5:30 p. m., All-American string quartet; 6:30, vest pocket program; 7-8, Al Wesson and his dance orchestra; 8-9, Robert Hurd, tenor; Virginia Flohr, soprano; Heinrich Tandler, violinist; 9-10, program, associated Packard dealers of California; 10-11, Packard Radio club; 11-3 a. m., frolic.

KFON, Long Beach, Calif. (232.4m-1280kc), 6-6:30 p. m., organ recital, Brayton's; 7-8, studio program; 8-9, Press-Telegram studio; 9-11, KFON artists' frolic.

KFWB, Hollywood, Calif. (252m-1190kc), 8-9 p. m., Lyric string trio; Eunice Wyne, soprano; Jack Goode, tenor; 9-11, program, Reeve-Gartzmann, Inc., feature.

KFWI, San Francisco, Calif. (225.4m-1330kc), 1:30-3:30 a. m., Pajama party, Clem Kennedy's dance orchestra, Eddie Stott, Al Pierce, Sadie Woodside; George Taylor and his uke.

King Oakland Six dance orchestra.

KGO, Oakland, Calif. (361.2m-830kc), 8:10 p. m., old dance revival, old-time music, old songs medley; Carl Anderson, tenor; Robert Sax, tenor; Clarence Oliver, baritone; Albert Gillette, sax; Batt Scanlan and his old-time dance orchestra; 9:45, fifth episode, "A Step On the Stairs," mystery story; 10-12, California Collegians' dance orchestra.

KGW, Portland, Ore. (491.5m-610kc), 6-7 p. m., concert, Olds, Wortman and King company; 9-12, Indian grill.

KHJ, Los Angeles, Calif. (405.2m-740kc), 8-10 p. m., program, Motor Transit company.

KJR, Seattle, Wash. (384.4m-780kc), 8:30-10 p. m., E. O. Warner studio.

KMTR, Hollywood, Calif. (238m-1260kc), 6-7 p. m., Starr Piano company studio; 8-10, KMTR concert orchestra; Neil Russell, baritone.

KNX, Hollywood, Calif. (336.9m-890kc), 5:30 p. m., Leighton's cafeteria orchestra; 6:30-7, Atwater Kent concert orchestra; 7:30-8, program, Roy L. Donley, Inc.; 8-10, KNX feature program; 10-11, Ray West's Coconut Grove dance orchestra; 11-2 a. m., Filmland frolic.

KOWW, Walla Walla, Wash. (256.3m-1170kc), 8-12 midnight, studio program, dance music.

KPO, San Francisco, Calif. (428.3m-1000kc), 6:35-7:30 p. m., States restaurant orchestra; 8-9, Thirtieth U. S. Infantry band; 9-10, music; 10-12, Fairmont hotel orchestra; Maurice Gunsky, tenor; Merton Borjes, pianist.

KPSN, Pasadena, Calif. (315.6m-950kc), 8-9 p. m., Star-News concert hour; 9-10, Maryland hotel dance orchestra.

Sunday, March 28

Headliners Today

Eastern 3:30 p. m.	Central 2:30 p. m.	Mountain 1:30 p. m.	Pacific 12:30 p. m.
WTIC (475.9m-630kc) New Haven orchestra.			
7	6	5	4
WBZ (333.1m-900kc) "The Dancing Princess," Dartmouth players.			
7:30	6:30	5:30	4:30
WBAL (245.8m-1220kc) Artists' series.			
7:45	6:45		4:45
WAMD (243.8m-1230kc) Radio stock company.			
7:20	6:20	5:20	4:20
WEAF (491.5m-610kc), WEEL, WCAP, WJAR, WTAG, WCAE, WVVJ, Capitol family.			
9:15	8:15	7:15	6:15
WEAF (491.5m-610kc), WEEL, WCAP, WWO, WJAR, WGR, WCAE, WSAI, WVVJ, WCCO, WGN, WEAR, KSD, WTAG, Atwater Kent program.			
9:30	8:30	7:30	6:30
WFAA (475.9m-630kc) MacDowell Sisters.			
10	9	8	7
KMOX (280.2m-1070kc) Skouras Sunday night club.			
10:30	9:30	8:30	7:30
KPRC (296.9m-1010kc) Paramount Five.			
KYW (345.1m-560kc) Classical concert.			
11	10	9	8
KHJ (405.2m-740kc) Zoellner string ensemble.			

Sunday, silent night for: CFAC, CHIC, CKNC, CNRA, CNRC, CNRE, CNRM, CNRO, CNRR, CNRT, CNRV, CNRW, KFAB, KFAU, KFKX, KFKE, KFNO, KFVE, KFVA, KFXF, KLM, KMA, KMTR, KOAC, KOB, KOWW, KSAC, KSO, KWSC, PWX, WABQ, WAHG, WCAD, WCAR, WCAU, WDAF, WDBO, WEOA, WEGP, WEBW, WFI, WGBF, WGES, WGHV, WHP, WGST, WHAD, WHAS, WHAZ, WIP, WJAZ, WJDD, WJR, WKAF, WKQA, WKAR, WMAQ, WMAZ, WMC, WNYC, WOI, WRC, WRVA, WSB, WSM, WTAM.

Eastern Time Stations

CHIC, Toronto, Can. (356.9m-840kc), 5 p. m., organ recital, George Graham.

KDKA, Pittsburgh, Pa. (309.1m-970kc), 6:30 p. m., dinner concert; 7:15, chimes; 7:45, church service.

PWX, Havana, Cuba (400m-750kc), 8-9 p. m., Cuban Army band; 9:10-10:10, Cuban Army band; 10:30-12, Lido-Venue revue.

WBAL, Baltimore, Md. (245.8m-1220kc), 6:30-7:30 p. m., twilight program, concert orchestra; artists' recital, Martha Atwood, soprano; Oliver Denton, pianist.

WBBR, New York, N. Y. (272.6m-1100kc), 9 p. m., Watchtower violin choir; 9:10, vocal selections; 10, Watchtower violin choir.

WBZ, Springfield, Mass. (333.1m-900kc), 6 p. m., music; Art Duff, violinist; Alexander Blackman, violist; George Brown, cellist; Hans Ibbel, pianist; 7, "The Dancing Princess," Dartmouth players; 7:30, Copley Plaza orchestra; 8, program.

WCAE, Pittsburgh, Pa. (461.3m-650kc), 6:30 p. m., dinner concert; 7:20, WEAF; 9:15, WEAF.

WCAP, Washington, D. C. (468.5m-640kc), 11 a. m., First Baptist church; 4 p. m., Bethlehem chapel; 6:20-7:20, Vesper string ensemble; 7:20-9:15, WEAF; 9:15-10:15, WEAF.

WEAF, New York, N. Y. (491.5m-610kc), 2-3 p. m., Greater New York Federation of Churches; 3-4, young people's conference; 4-5:30, Bedford Park artists' C. A. WTAG, WEEL, WCAE, WSAI; 5:30-6, Metropolitan male chorus; 6-7, George Barriere's little symphony orchestra, WJAR, WFI; 7-7:20, chamber musicale, WJAR, WFI; 7:20-9:15, Capitol theater; 9:15-10:15, Atwater Kent, WEEL, WCAP, WJAR, WGR, WCAE, WSAI, WVVJ, WCCO, WGN, WEAR, KSD, WTS, WVI.

WEEI, Boston, Mass. (348.6m-860kc), 10:50 a. m., Old South church; 12:30 p. m., St. Mark's church choir; 2, Sager's hour of hospitality; 3, Chamber of Commerce organ recital; 5:30, Ecker concert group; 7:20, WEAF; 9:15, WEAF.

WFI, Philadelphia, Pa. (394.5m-760kc), 4:30 p. m., services from Central Y. M. C. A., Dr. John Dunbar, speaker; 6, George Barriere and his Little Symphony orchestra; 8:15, WEAF.

WGBS, New York, N. Y. (315.6m-950kc), 3 p. m., Arrowhead Inn tea dance; 3:30, Crystal Palace orchestra; 8:30, program.

WGCP, New York, N. Y. (252m-1190kc), 3 p. m., orchestra; 3:30, Isabelle Henderson, soprano; 3:15, Edgar Duffy, baritone; 4, orchestra; 4:30, Leslie McLeod, tenor; 4:45, orchestra.

WGR, Buffalo, N. Y. (319m-940kc), 10:45 a. m., Westminster Presbyterian church; 7:45, Central Presbyterian church; 9:15, WEAF.

WGY, Schenectady, N. Y. (379.5m-790kc), 7:30 p. m., service, First Lutheran church; 9, WJZ; 10, Godfrey Ludlow, violinist.

WHAR, Atlantic City, N. J. (275m-1090kc), 10:45 a. m., Chelsea Baptist church; 1:15 p. m., sacred recital, Seaside hotel ensemble; 7:50, Chelsea Baptist church; 8, classics, Seaside hotel ensemble.

WHN, New York, N. Y. (315.6m-950kc), 7:30-9:45 p. m., Calvary evening services; 10:15-10:45, Anatol Friedland; 10:45-11:15, Janssen's Hofbrau Haus orchestra; 12-12:30 a. m., Harry Richman entertainers.

WIP, Philadelphia, Pa. (394.5m-760kc), 7:15 p. m., services, Holy Trinity church; 9:30, gala concert, Philadelphia and Reading Seashore band.

WJAR, Providence, R. I. (305.9m-600kc), 6 p. m., George Barriere's Little symphony orchestra; 7, moment musical; 7:20

WBAL INTRODUCES NOTED PIANIST



The new soprano at KYW, Chicago, is Kathryn Browne, above. Miss Browne is well-known to Illinois audiences because of her operatic work with the Chicago Civic opera company. "Mercer's King of the Ivorys" is the young man to the right, Ralph Tabor. He is the official pianist of WMAZ, Macon, Ga.

WOK, Chicago, Ill. (217.3m-1300kc), 6-1 a. m., orchestras; Husk O'Hare's orchestra.
 WORD, Batavia, Ill. (275.1m-1090kc), 10 a. m., I. B. S. A. service; 2:30 p. m., program; 6, I. B. S. A. song service; 6:45, trio; 9, service, Webster trio, choral singers.
 WOS, Jefferson City, Mo. (440.9m-680kc), 9:30 a. m., Christian church; 5 p. m., Vesper services; 7:30, First Baptist church.
 WQJ, Chicago, Ill. (447.5m-670kc), 9:30 a. m., Peoples' church of Chicago, choir; Clarence Eddy, organist; 3-4, Saida Ballantine artists; Dell Eastburn, tenor; Elizabeth Greenc, violinist; Marcella Kaltenbach, Esther Chukerman, coloratura sopranos; Joe DuMont, baritone; Irene DuMont, concert pianist; Fannie Fuerst, reader; 8-10, Jack Chapman and his orchestra; Perison Thal, pianist; Grace Wallace, Otis Jester, Lena Auer Kink, sopranos; Roy McKay, baritone; Mary House, pianist; Fontella trio.
 WSAI, Cincinnati, Ohio (325.9m-920kc), 3-4 p. m., WEAF; 7:45, chime concert, Robert Badgley; 8:15, WEAF.
 WSM, Nashville, Tenn. (282.8m-1060kc), 7:30 p. m., First Presbyterian church.
 WSUI, Iowa City, Iowa (483.6m-620kc), 4 p. m., Vesper service; 8:15, Central City quartet.

Mountain Time Stations
 KFXF, Colorado Springs, Colo. (250m-1200kc), 11 a. m., First Presbyterian church; 7:30, First Methodist church; 9:15, "The Culture of India," Prof. S. L. Joshi.
 KOA, Denver, Colo. (322.4m-930kc), 11 a. m., First Congregational church; 3 p. m., music hour; Mary Lee Read, organist; Marjorie Mellow, soprano; Mrs. J. A. Doney, contralto; 7:40, Trinity Methodist Episcopal church.

Pacific Time Stations
 KFI, Los Angeles, Calif. (467m-642kc), 4-5 p. m., vesper hour; 7-7:30, Synchronophase string ensemble; 7:30-8, Jim, Jack and Jean trio; 8-9, Aeolian organ, Dan J. McFarland, organist; 9-10, Harry Keiper's Movieland dance orchestra; 10-11, Packard Six dance orchestra.
 KFON, Long Beach, Calif. (232.4m-1280kc), 6-6:30 p. m., Brayton's theater organ; 7:45-9, service, First Church of Christ Scientist; 9-10, Burt Pedersen's orchestra.

Eastern 10 p. m., Central 9 p. m., Mountain 8 p. m., Pacific 7 p. m.
 KTHS (374.8m-800kc) Scotch folk music.
 WEAF (491.5m-610kc), WOO, WCAE, WJAR.
 WCAP, WTAG, Grand opera, "Lakme."
 WJZ (454.3m-660kc) Manhattan quartet.
 WPG (290.8m-1000kc) Galen Hall trio.
 WPT (290.8m-1000kc) Galen Hall trio.
 KFI (467m-640kc) Special features.
 WAMD (244m-1230kc) Skyrocket frolic.

Monday, silent night for: CNRA, CNRC, CNRE, CNRM, CNRO, CNRR, CNRT, CNRV, CNRW, KFAU, KFDM, KFEQ, KFMX, KFWA, KHJ, KLD, KPSN, KUOA, KYW, WBBM, WBCN, WCAD, WCBB, WEAO, WEBH, WEBI, WEBW, WENR, WGBS, WGES, WGN, WHAS, WHT, WIBO, WIP, WJAZ, WJJD, WKAO, WLIB, WLS, WMAQ, WMBB, WOAI, WOC, WOK, WORD, WQJ, WRC, WRO.

Eastern Time Stations
 CKNC, Toronto, Can. (356.9m-840kc), 8-10 p. m., Little symphony orchestra; Elsie White, soprano; Elsie Addison, contralto; Lawrence DeFoe, tenor.
 KDKA, Pittsburgh, Pa. (309.1m-970kc), 6:30 p. m., dinner concert; 9, Road light opera.
 PWX, Havana, Cuba (400m-750kc), 8:30-9:15 p. m., Westinghouse dance music; 9:15-9:25, for Spanish fans; 9:25-10:10, musical program; 10:20-11, Westinghouse dance music.
 WAHG, Richmond Hill, N. Y. (315.6m-954kc), 7:30 p. m., Walter A. Jooss, novelty pianist; 7:45, Jean Dodds, soprano; 8, Synchronophase hour; 9:25, John DeBueris clarinet trio; Vito Menella, baritone; 10:02, Bartelo Sabatini, Italian operatic baritone; 10:20, Joe Zimmerman's orchestra; 12, Queens Melody Boys.
 WBAL, Baltimore, Md. (245.8m-1220kc), 6:30-7:30 p. m., dinner program; 7:30-8, organ concert, Frederick Weaver, organist; 8-9, Louise Schroeder, soprano; Eva Hipp, pianist; Mildred Penn, pianist; Gordon Phillips, tenor; Abram Moses, violinist; Conner Turner, baritone; 9:10-10, musical program.
 WBB, New York, N. Y. (272.6m-1100kc), 8 p. m., Irene Kleinpeter, soprano; vocal duets, Irene Kleinpeter and Fred Twaroschik.
 WBZ, Springfield, Mass. (333.1m-900kc), 6:30 p. m., Hotel Lenox ensemble; 7:30, organ recital; 8, Capitol theater orchestra; 10:03, Leo Reisman's Hotel Brunswick orchestra.
 WCAE, Pittsburgh, Pa. (461.3m-650kc), 6:30 p. m., dinner concert; 8, studio concert; 9, studio program; 10, WEAF; 11, Ralph Harrison's Midnight Sons.
 WCAP, Washington, D. C. (468.5m-640kc), 7-11 p. m., studio program; WEAF.
 WCAU, Philadelphia, Pa. (277.6m-1080kc), 7:30 p. m., recital, N. Snellenburg and Co.; 8, the Hood Boys; 8:15, recital; 10:30, Parodians dance orchestra from Club Cadix.
 WEA, New York, N. Y. (491.5m-610kc), 6 p. m., Hotel Waldorf-Astoria; 7:20, Leo F. Bartunique, baritone; 8, pop concert, WOO; 9, A. and P. Gypsies; WEEL, WCAP, WWJ, WJAR, WOO; 10, "Lakme"; WEAF grand opera company, WOO, WCAE, WJAR, WCAP, WTAG; 11-12, Ben Bernie and orchestra.
 WEEI, Boston, Mass. (348.6m-860kc), 6:15 p. m., Joe Rines and his Hunters' Cabin orchestra; 7:30, Black Iron Shiners; 8:15, musical; 8:45, WEAF; 9, WEAF.
 WFI, Philadelphia, Pa. (394.5m-760kc), 6:30 p. m., Bellevue Stratford concert orchestra; 7, Bellevue Stratford dance orchestra.
 WGBS, New York, N. Y. (315.6m-950kc), 6 p. m., Uncle Geebee; 6:30, Imperial Russian Balalaika orchestra.
 WGCP, New York, N. Y. (252m-1190kc), 3 p. m., Irving Firstenberg, pianist; 3:45, Leo Roy Montasanto, tenor; 4:15, Uncle Robert's Pals; 5, studio program; 8:30, Mae and Lennie, entertainers; 8:45, studio program; 9:30, studio program; 10, Strickland's orchestra; 10:30, China Royal orchestra.
 WGH, Clearwater, Florida (266m-1130kc), 6:30-7:30 p. m., Lakewood Terraces orchestra; 8:30-10, program, Lakewood Terraces.
 WGR, Buffalo, N. Y. (319m-940kc), 6:30 p. m., Maxine dance orchestra; 8, Clayton Fattley's Roveroff orchestra; 9, program by Wheat's division, General Ice Cream Co.; 10, Shakespearean society; 10:30, Florence Ann Reid, contralto; 11, Vincent Lopez Hotel Statler dance orchestra.
 WGY, Schenectady, N. Y. (379.5m-790kc), 6:30 p. m., Hotel Van Curler orchestra; 7:45, General Electric band.
 WHAR, Atlantic City, N. J. (275m-1090kc), 2 p. m., Seaside hotel trio; 8, concert; 11, Follies Bergere dance orchestra.
 WHAZ, Troy, N. Y. (379.5m-790kc), 9 p. m., Campus serenaders; 10, R. P. I. glee club concert; 11, Students' symphony orchestra.
 WHN, New York, N. Y. (361.2m-380kc), 6 p. m., people's hour; 7, music; 7:30, Joe Ward's Swance entertainers; 8:05, Roseland dance orchestra; 8:30, surprise; 9, Loew's New York orchestra; 10:30, Leroy Smith's orchestra; 11, Cotton club orchestra; 11:30, Silver Slipper orchestra.
 WIP, Philadelphia, Pa. (508.2m-590kc), 6:05 p. m., Benjamin Franklin concert orchestra.
 WJAB, Providence, R. I. (305.9m-500kc), 7:45 p. m., Providence Dairy Grade "A" entertainers; 8:15, musical program; 9, WEAF.
 WJR, Pontiac, Mich. (516.9m-580kc), 7 p. m., Petite symphony orchestra; 7:15, entertainers; 7:45, Goodwill Oakland; 9, Paige and Jewett Sixes; 11:30, Jewett Radio Jesters.
 WJZ, New York, N. Y. (454.3m-660kc), 7 p. m., Hotel Commodore dinner concert; 7:55, John B. Kennedy; 8, Astor Coffee orchestra; 10, Manhattan male quartet; 10:30, musical program.
 WLIT, Philadelphia, Pa. (394.5m-760kc), 8:15 p. m., recital; 9, Stanley theater hour of music; 10, Arcadia cafe dance orchestra; 10:30, vaudeville features, Fay's Knickerbocker theater; 10:45, El Patio dance orchestra.
 WMAK, Buffalo, N. Y. (265.3m-1130kc), 7:30-8:30 p. m., Murray Whiteman and his serenaders; 8:30-9, musical; 9-10, Philco serenaders; 10-11, Beaver Products company.
 WMCA, New York, N. Y. (340.7m-880kc), 6 p. m., Hotel McAlpin string ensemble; 6:30, Hotel McAlpin orchestra; 7:30, Kurtz Karnival Kings; 10:30, Parody orchestra; 11:30, Jack Denny's orchestra; 12, McAlpin entertainers.
 WNYC, New York, N. Y. (526m-570kc), 6:20 p. m., piano selections; 7:35, songs; 8-10, recital talk, Herman Neuman, assisting artists; 10:35, Richmond Versatile orchestra.
 WOO, Philadelphia, Pa. (508.2m-590kc), 7:30 p. m., Sylvania dance orchestra; 8-11, WEAF; 11, Adolphia dance orchestra.
 WOR, Newark, N. J. (405.2m-740kc), 6:30 p. m., Jacques Jacobs' Hotel Shelton ensemble; 7:30, George Tcherbaus' Katinka orchestra; 8:30, Al Reid's hour; 9:45, Spanish program, orchestra; Alganada Becca, Spanish Consul, speaker.
 WPG, Atlantic City, N. J. (299.8m-1000kc), 6:45 p. m., organ recital, Arthur Scott Brook; 7, Hotel Morton dinner music; 8:10, Shore Fast Line male quartet; 9, Hotel Ambassador concert; 9:30, Million Dollar Pier orchestra; 10, band concert, Al-Time Grotto; 10:30, Galen Hall trio; 11, Eddie McKnight's orchestra.
 WRVA, Richmond, Va. (256.3m-1170kc), 8:15 p. m., State Teachers' college glee club; 9:10, State Teachers' college glee club; 9:45, Arion orchestra.
 WTAG, Worcester, Mass. (267.7m-1120kc), 6-7 p. m., dinner music; WTAG orchestra; 8:30-9, "Broad and Long"; 9-10, Robin Hood hour of music; 10-11, WEAF.
 WTAM, Cleveland, Ohio (389.4m-770kc), 6-7 p. m., Hotel Hollenden orchestra; 9-11, "Near a Duchess"; Willard symphony; 11-12, Austin Wylie's Vocalion Recording orchestra; 12-1 a. m., Royal Canadians.
 WVIC, Hartford, Conn. (475.9m-630kc), 6:50 p. m., Hub trio; 8:30, Capitol theater orchestra; 9, Dody Kravitz; 9:15, J. W. Birch and Mildred Zimont; 9:30, Hotel Bond orchestra; 10:30, Travelers symphonic ensemble.
 WWJ, Detroit, Mich. (352.7m-850kc), 6 p. m., dinner concert; 8, Detroit News orchestra; 9, WEAF.



Sunday, March 28

musical exercises, Bethany Sunday school; 6, organ recital, Clarence K. Bawden.
 WPG, Atlantic City, N. J. (299.8m-1000kc), 2 p. m., organ recital, Arthur Scott Brook; 4:15, community vocal and instrumental recital, St. James' Episcopal church; 9:15, Hotel Traymore concert; 9:30, Hotel Ambassador orchestra; 10:15, "The Crucifixion," Willwood Baptist church choir.
 WREO, Lansing, Mich. (283.5m-1050kc), 10 a. m., chimes, Belfry Plymouth Congregational church; 10:30, Plymouth Congregational church; 7 p. m., Central M. E. church; 8:15, St. Mary's church chorus choir.
 WTAG, Worcester, Mass. (267.7m-1120kc), 4-5:30 p. m., WEAF; 7:20-9:15, WEAF; 9:15-10:15, WEAF.
 WWJ, Detroit, Mich. (352.7m-850kc), 10 a. m., First Presbyterian church; 2 p. m., Detroit News orchestra, 4, organ recital; 7:20, Capitol theater family; 9:15, WEAF.

Central Time Stations
 KFAB, Lincoln, Nebr. (340.7m-1000kc), 9-11 p. m., York orchestra.
 KFNF, Shenandoah, Iowa (263m-1140kc), 10:45 a. m., First M. E. church; 2:30 p. m., Golden Rule song service; 3, Swedish Mission church; 6:30, service, Golden Rule circle; 7:30, Christian church service.
 KFRU, Columbia, Mo. (499.7m-600kc), 7:30 a. m., sunrise service; 7:30 p. m., Baptist church services.
 KLDS, Independence, Mo. (440.9m-680kc), 6:30 p. m., quartet; euphonium selections, Philip Turner; James Davis, tenor; 9:15, sacred program; Pauline Etzenhauser, organist; Ada Griffie, violinist; quartet.
 KMA, Shenandoah, Iowa (252m-1190kc), 12:15-1:15 p. m., Sacred song service; 4 p. m., church choir music; 5, Bible class.
 KMOX, St. Louis, Mo. (280.2m-1070kc), 9 p. m., popular entertainment, Skouras Sunday night club.
 KPRC, Houston, Texas (296.9m-1010kc), 9:50 a. m., Trinity Lutheran church; 7:30 p. m., First Christian church; 9:30, Paramount Five, Radio artists.
 KSD, St. Louis, Mo. (545.1m-550kc), 6:15 p. m., WEAF; 8:15, WEAF.
 KTHS, Hot Springs National Park, Ark. (374.8m-800kc), 11 a. m.-12:30 p. m., First Baptist church; 9-10, classic hour, New Arlington and Eastman hotels grand ensembles; 10:05-11:30, Arkansas Traveler Radio special train, Benny Ford and his musical train crew; 11:30-12:30 a. m., organ classic, Lawson Reid.
 KUOA, Fayetteville, Ark. (299.8m-1000kc), 7:30 p. m., Central Methodist church.
 KYW, Chicago, Ill. (536m-560kc), 7 p. m., Chicago Sunday Evening club; 9:30, classical concert.
 WAMD, Minneapolis, Minn. (244m-1230kc), 10:30 a. m., First Unitarian church; 2:30 p. m., popular program, Dixie Radio Hound; 6:15, dinner concert, George Osborn and his orchestra; 6:45, Leome Faust and stock company; 9:30, Gayle Wood.
 WBAF, Fort Worth, Texas (475.9m-630kc), 5-6 p. m., sacred concert; 9:30, Chief Gonzales Texas hotel orchestra.
 WCAL, Northfield, Minn. (336.9m-890kc), 8:30 a. m., Norwegian church services; 9:15 p. m., St. John's Lutheran church.
 WCF, Zion, Ill. (344.6m-870kc), 8 p. m., Zion hand organ quartet.
 WCHM, Lehigh Valley, Pa. (416.4m-720kc), his attorney, Plymouth Congregational church; 4:10, Palmer Little symphony; 6:20, Second Street church choir; 8:15, WEAF.
 WGS, St. Paul, Minn. (416.4m-720kc), 3-4 p. m., Palmer Little symphony; 8:15-9:15, WEAF; 10-11:30, Palmer Little symphony, soloists.

T. H. Madison, violinist; 11:50, Mrs. Lela Beuchell, soprano; 8:15 p. m., Martha Hutchinson, organist; the Lighthouse choir; Prof. H. L. Pearson, reader; Ellen Acton, soprano; 9:10, Ellis Maas, bass.
 WFAA, Dallas, Texas (475.9m-630kc), 6-7 p. m., Radio Bible class, First Presbyterian church; 7:30-8:30, First Church of Christ, Scientist; 8:30-9:30, MacDowell sisters; 11-12, Amphion male quartet.
 WGES, Oak Park, Ill. (250m-1200kc), 5-7:40 p. m., Moody Bible school program; 11-12, frolic.
 WGN, Chicago, Ill. (302.8m-990kc), 6:30-6:45 p. m., musical program; 6:45, old-time favorites; 6:55, "The Million Sing"; 7-8:15, Drake concert ensemble, Blackstone string quintet; 8:15, WEAF; 9:15, old-time music room; 10, Sam 'n' Henry; 10:10, old-time favorites; 10:20-11, musical program, ensemble; Charlie Straight's Rendezvous orchestra.
 WHAD, Milwaukee, Wis. (275m-1090kc), 3:15 p. m., Turnverein symphony orchestra.
 WHAS, Louisville, Ky. (399.8m-750kc), 10 a. m., St. Boniface church; 4:30-5:30, Christ church cathedral.
 WHB, Kansas City, Mo. (365.6m-820kc), 9:40-10:45 a. m., Boulevard Christian church; Mrs. Fred Bishop, organist; Nora LaMarr Moss, contralto; 11:15-12:30 p. m., Independence Blvd. Christian church; Hans Feil, organist; 3-9, Christian Science services; 11:15-11:45 a. m., Linwood theater feature; Morrill Moore, organist; Don Anchors, poet.
 WHO, Des Moines, Iowa (526m-570kc), 11 a. m., St. Paul's Episcopal church; 4 p. m., artists from Adel; 7:30-8:15, the Bankers Life trio; Myrtle Williams, soprano; Stewart Watson, baritone; 11-12, the Bankers Life Little symphonic orchestra.
 WHT, Chicago, Ill. (399.8m-750kc), 12 noon, Sunday dinner sacred concert, vocal and organ; 12:45 p. m., special program for shut-ins and sick; 1:15, shepherd time for the kiddies; 1:30, Aerial Girls program; 1:45, Radio Rangers; 2, fellowship program; 2:30, missionary program; 2:45, orchestra concert and afternoon services, Chicago Gospels tabernacle; 5:30, vesper concert; 6, young women's council; 6:30, concert, tabernacle band and choir; sermon, Paul Rader; 9:30, request program; 10:30, Paul Rader, back home hour.
 WIBO, Chicago, Ill. (225.4m-1130kc), 2-4 p. m., concert, faculty of Uptown Conservatory of music; 6-8, dinner concert, WIBO quartet, trio; 10-12, popular program, songs, ukulele solos, pianist.
 WIJZ, Chicago, Ill. (322.4m-930kc), 7-9 p. m., special musical program.
 WJJD, Mooseheart, Ill. (370.2m-810kc), 7:45 a. m., Catholic services; 9:40-10:30, Protestant services; 3-4 p. m., Mooseheart Sunday concert.
 WKRC, Cincinnati, Ohio (325.9m-920kc), 6:45 p. m., Walnut Hills Christian church; 10, Kodol classical program; 11:15, Marlon McKay and his orchestra, Swiss Gardens.
 WLIB, Chicago, Ill. (302.8m-990kc), 5-6:30 p. m., chamber music.
 WLS, Chicago, Ill. (344.6m-870kc), 6 p. m., prelude; 6:30-7:55, WLS; Little Brown church choir; Central church orchestra; WLS trio; Sol Heller, tenor.
 WLW, Cincinnati, Ohio (422.3m-710kc), 10 a. m., Seventh Presbyterian church; 4 p. m., organ concert; 7:30, First Presbyterian church, Rev. Frederick MacMillan; 8:30, Pogue concert, Ralph Thomas, soloist.
 WMBB, Chicago, Ill. (250m-1200kc), 3-5 p. m., orchestras; K. Lucille O'Hara, soprano; Bob Dury, whispering baritone; Clifford Rail, harmonica novelties; 7:40-9, Fifth Church of Christ Scientist; 9-11, Scotty Welch, Madison Sisters, Billie Allen Hoff, blues singer; Bob Bennett, celeste specialties; Maxwell Trehame, tenor.
 WOAI, San Antonio, Texas (394.5m-760kc), 7:30 p. m., Central Christian church; 9:30, super-heterodyne hour of music.
 WOAW, Omaha, Nebr. (526m-570kc), 9 a. m., Christian and Missionary alliance; 1:30 p. m., matinee program; 6, Bible study; 9, services.
 WOC, Davenport, Iowa (483.6m-620kc), 1-2:30 p. m., Palmer Little symphony; Paul Vipperman, tenor; 6:30-7, Methodist Episcopal church; 8:15-9:15, WEAF; 10-11:30, Palmer Little symphony, soloists.

KFWB, Hollywood, Calif. (252m-1190kc), 9-11 p. m., Warner Brothers Sunday night frolic, Frances St. George, the jazzmania girl of KFWB; Albert Keglovich, violinist; Dan Gridley, tenor; Jack Smith's dance orchestra.
 KGO, Oakland, Calif. (361.2m-830kc), 11 a. m., First Presbyterian church; Otto Fleissner, organist; Theodore Phillips, tenor; 3:30 p. m., concert, KGO Little symphony orchestra; James Gerard, tenor; 7:30, Presbyterian church; Mrs. Harold Olsen, contralto; Otto Fleissner, organist.
 KGW, Portland, Ore. (491.5m-610kc), 7:30-9 p. m., East Side Baptist church; 9-10, concert.
 KHJ, Los Angeles, Calif. (405.2m-740kc), 4-5 p. m., Masonic service; 7-8 p. m., First Methodist Episcopal church; 8-10, Zoelner string ensemble; Orpheus Four male quartet.
 KJR, Seattle, Wash. (384.4m-780kc), 7:15-7:30 p. m., Mrs. Montgomery Lynch, organist; 7:30-9, First M. E. church; 9-10:30, Puget Sound Savings and Loan association orchestra.
 KNX, Hollywood, Calif. (336.9m-890kc), 6:30-7 p. m., Hollywood Unitarian church; 7-8, program, Southern California Edison company; 8-9, First Presbyterian Church of Hollywood; 9-10:30, program, Beverly Hills Nurseries.
 KPO, San Francisco, Calif. (428.3m-1000kc), 9:45-10:45 a. m., service; 5-6 p. m., organ recital, Marshall Gishelman; 6-6:50, States restaurant orchestra; 6:35-8:35, Palace hotel concert orchestra; 8:35-10, Rudy Seiger's Fairmont hotel orchestra; 10-12, Henry Halstead's orchestra.
 KPSN, Pasadena, Calif. (315.6m-950kc), 8:45-9:45 p. m., Maryland Artists' ensemble.
 KTAB, Oakland, Calif. (239.9m-1250kc), 9:45-10:45 a. m., Bible lecture; 11-12:30 p. m., church service; 7:45-8:15 p. m., after-service concert.

Monday, March 29

Headliners Today

Eastern 8 p. m.	Central 7 p. m.	Mountain 6 p. m.	Pacific 5 p. m.
WAHG (315.8m-950kc) Synchronophase hour.	8:30	7:30	6:30
WCOA (222m-1350kc) Coast Artillery band concert.	8	7	6
WDAF (365.6m-820kc) Girls' glee club.	8	7	6
WEAZ (379.5m-790kc) Campus serenaders.	8	7	6
WTAG (267.7m-1120kc) Robin Hood hour.	8	7	6

WTAM, Cleveland, Ohio (389.4m-770kc), 6-7 p. m., Hotel Hollenden orchestra; 9-11, "Near a Duchess"; Willard symphony; 11-12, Austin Wylie's Vocalion Recording orchestra; 12-1 a. m., Royal Canadians.
 WVIC, Hartford, Conn. (475.9m-630kc), 6:50 p. m., Hub trio; 8:30, Capitol theater orchestra; 9, Dody Kravitz; 9:15, J. W. Birch and Mildred Zimont; 9:30, Hotel Bond orchestra; 10:30, Travelers symphonic ensemble.
 WWJ, Detroit, Mich. (352.7m-850kc), 6 p. m., dinner concert; 8, Detroit News orchestra; 9, WEAF.

DARTMOUTH PLAYERS APPEAR AT WBZ

Monday, March 29

Central Time Stations

KFAB, Lincoln, Nebr. (340.7m-1000kc), 8:30-10:30 p. m., staff artists.

KFNF, Shenandoah, Iowa (263m-1140kc), 7 p. m., concert, Henry Field Seed company.

KFRU, Columbia, Mo. (499.7m-600kc), 6:15 p. m., dinner music.

KMA, Shenandoah, Iowa (252m-1190kc), 6-7 p. m., popular music; 9-11, Farnham trio; Grady and Doc.

KMOX, St. Louis, Mo. (280.2m-1070kc), 6 p. m., organ recital, Arthur Utt; 6:30, Mrs. Jaques Landree, organist; 7, orchestra, "Buster Brown"; 8, orchestra; Katherine Eicher, contralto; 9, Oscar Blanke, tenor; 10, popular dance music.

KPRC, Houston, Tex. (296.9m-1010kc), 7:30 p. m., Malon Gunn's orchestra; 8:30, Humble Oil and Refining company band.

KSD, St. Louis, Mo. (545.1m-550kc), 7 p. m., program; 8, concert, West Presbyterian church.

KTHS, Hot Springs National Park, Ark. (374.8m-800kc), 9-9:40 p. m., Scotch Highland folk music, ensemble; 9:45-10:45, Pooley hour, Rainbow Garden; 10:45-11, Lon Chassy, violinist; John G. Heyn, pianist; 11-12, Firestone frolic.

KUOA, Fayetteville, Ark. (299.8m-1000kc), 8 p. m., Lambda Chi orchestra.

KYW, Chicago, Ill. (536m-560kc), 6-6:30 p. m., dinner music; 6:30-7, Congress hotel dinner concert.

WAMD, Minneapolis, Minn. (244m-1230kc), 6 p. m., WAMD Boys' A. C.; 7:01, Garrick symphony orchestra; 7:15, special program; 11, Skyrocket frolic.

WBAP, Fort Worth, Texas (475.9m-630kc), 6-6:30 p. m., dinner music; 7:30, organ concert; 9:30, Ward's "Trail Blazers"; 11, Fort Worth club orchestra.

WCAL, Northfield, Minn. (336.9m-890kc), 8:30 p. m., Norwegian program.

WCCO, Minneapolis-St. Paul, Minn. (416.4m-720kc), 6:15 p. m., St. Paul hotel orchestra; 8, University of Minnesota program; 9, classical concert.

WCOA, Pensacola, Fla. (222m-1350kc), 7 p. m., Army night.

WDAF, Kansas City, Mo. (365.6m-820kc), 6-7 p. m., Trignon ensemble; 8-9:30, girls' glee club, Baker university; 11:45-1 a. m., Nighthawk frolic.

WEMC, Berrien Springs, Mich. (285.5m-1050kc), 8:15 p. m., Radio Lighthouse music makers; Dulciana string trio; Rhea Yeager, cellist.

WGST, Atlanta, Ga. (270m-1110kc), 9-10 p. m., Howard McClave, violinist; T. G. Reddy, guitar.

WHAD, Milwaukee, Wis. (275m-1090kc), 6:15-7 p. m., Bill Bening's Milwaukee Athletic club orchestra; 8:30-10, Wisconsin theater revue.

WHB, Kansas City, Mo. (365.6m-820kc), 7-8 p. m., popular dance program.

WHO, Des Moines, Iowa (526m-570kc), 7:30-9 p. m., Paul Stoye, pianist and composer; Joseph Gifford; Dorothy Dinsmore, violinist; Myrtle Williams, soprano; 11-12, organ recital, Capitol theater.

WKRC, Cincinnati, Ohio (325.9m-920kc), 6 p. m., Alvin Roehr and his Hotel Alms orchestra; 8, popular song hour; 9, program, American Legion; 12, Kodol mid-night frolic; 12:30 a. m., Wesley Helvey's Troubadours.

WLW, Cincinnati, Ohio (422.3m-710kc), 7 p. m., Robert Visconti's Hotel Gibson orchestra; 8, Cincinnati Times-Star orchestra; Howard Hafford, soloist; 10, dance music, Castle Farm.

WOAW, Omaha, Nebr. (526m-570kc), 6:20 p. m., popular songs; Frank Peterson, tenor; Helen Higgins, pianist; 6:50, Randall's Royal Pontenello orchestra; 9, classical.

WOOD, Grand Rapids, Mich. (242m-1240kc), 10-11 p. m., Mills-Wetzel presentation; WOOD ensemble; 11-1 a. m., Merle Compton and his orchestra.

WOS, Jefferson City, Mo. (449.9m-680kc), 8:10 p. m., Easter program, Christian college.

WSAI, Cincinnati, Ohio (325.9m-920kc), 10 p. m., Cincinnati community program; songs, Marjorie Launkin.

WSB, Atlanta, Ga. (428.3m-700kc), 8 p. m., program, Mrs. Lamar Walker; 10:45, Vick Myers' orchestra.

WSM, Nashville, Tenn. (282.8m-1060kc), 6:30 p. m., Francis Craig's orchestra; 8, program; 10, Vito Pelletier's orchestra.

WSP, Milwaukee, Wis. (245.8m-1220kc), 8 p. m., "Passion Week" service, M. E. church; 9, John Swinicko and his Manhattan Beach orchestra; "Candygram" entertainers.

WSUI, Iowa City, Iowa (483.6m-620kc), 8:30 p. m., musical program.

Mountain Time Stations

CFAC, Calgary, Can. (435.8m-688kc), 9 p. m., Ladies' concert trio.

KKFX, Colorado Springs, Colo. (250m-1200kc), 8:30 p. m., Ida Blackman, soprano; Cecil E. Rodgers, tenor; Verda McCleary.

KOA, Denver, Colo. (322.4m-930kc), 6:30 p. m., Brown Palace string orchestra; 8:30, KOA orchestra; 9:30, instrumental program; Olinger Highlander Boys' First band.

Pacific Time Stations

KFI, Los Angeles, Calif. (467m-642kc), 5:30 p. m., Owen Fallon's Californians; 6:30, vest pocket program; 7-8, old-time songs of the West, Guzman string trio, Jean Hayden, soprano; 8-9, Packard Eight dance orchestra; 9-10, program, Walter M. Murphy Motors company, Fryer Moore concert orchestra; Glida Marchetti, soprano; 10-11, Melklohn Brothers.

KFON, Long Beach, Calif. (232.4m-1280kc), 6-6:30 p. m., Brayton's theater organ; 7-8, The Club orchestra; 8-9, Press-Telegram program from Municipal auditorium; 9-11, studio programs.

KFWB, Hollywood, Calif. (252m-1190kc), 7:30-8 p. m., program, Dr. Ralph Mitchell and the Associated Dentists; 8-9, Corduroy Tire orchestra; Sunburnt Jim and his ukulele; Peggy Mathews, blues singer; 9-10, program, Star Motor Car company, Billton Dollar Four orchestra, Bill Blake, tenor; 10-11, Warner Brothers' frolic.

KGO, Oakland, Calif. (361.2m-830kc), 6-6:55 p. m., twilight concert; 8, Arlon trio; Margaret Avery, cellist; Joyce Holloway Barthelson, pianist; 9:15, Josephine Holub, violinist; 9:30, Arlon trio.

KGW, Portland, Ore. (491.5m-610kc), 6-7 p. m., dinner concert; 8-9, concert; 9-10, concert.

KJR, Seattle, Wash. (384.4m-780kc), 7-8:30, Mendelssohn trio; 8:30-10, studio program.

KMTB, Hollywood, Calif. (238m-1260kc), 7:15 p. m., Y. M. C. A. musical program; 8:10, KMTB concert orchestra; Roscoe Bell, tenor; 10-11, Starr Piano company studio.

KNX, Hollywood, Calif. (336.9m-890kc), 5:30 p. m., Leighton's cafeteria orchestra; 6:30-7, Atwater Kent orchestra; 7-7:30, Mutual Motors mirth contest; 7:30-8, program, Overell's Furniture company; 8-9, program, L. W. Stockwell company; 9-10, Glassnobilia minstrels; 10-11, Silverlows Cord dance orchestra; 11-12, Ray West's Coconut Grove dance orchestra.

KOWW, Walla Walla, Wash. (256.3m-1170kc), 8-10 p. m., studio program; 10-11, Jensen's Varsity Vagabonds program.

KPO, San Francisco, Calif. (428.3m-1000kc), 6:30-7 p. m., States restaurant orchestra; 7-7:30, Rudy Seiger's Fairmont hotel orchestra; 8-9, organ, Uda Waldrop; 9-10, KFI program; 10-11, Cabrera cafe dance orchestra; 11-12, Henry Halstead's dance orchestra.

KTAB, Oakland, Calif. (239.9m-1250kc), 8-10 p. m., program.

KWSC, Pullman, Wash. (348.6m-860kc), 7:30-9 p. m., vocal numbers, Mrs. B. L. Robinson; Marion DeCoursey, pianist; Margaret McLachlan, violinist.

Tuesday, March 30

Headliners Today

Eastern	Central	Mountain	Pacific
7:30 p. m.	6:30 p. m.	5:30 p. m.	4:30 p. m.
WBZ (454.3m-600kc), WRC, WGY, U. S. Marine band.	7	6	5
8	7	6	5
WBZ (333.1m-900kc) Excerpts, "Oblio," unknown opera.	8	7	6
9	8	7	6
WBAL (245.8m-1220kc) Naval Academy band.	9	8	7
WBZ (365.6m-820kc) Feature, Shrine serenaders.	10	9	8
9:30	8:30	7:30	6:30
KFWA (200.7m-1150kc) Anniversary program.	10	9	8
10	9	8	7
KFI (467m-640kc) American Hawaiian quartet.	10:30	9:30	8:30
10:30	9:30	8:30	7:30
KOA (322.4m-930kc) "A Step on the Stairs," mystery serial.	11	10	9
KTHS (374.8m-800kc) Old-time fiddlers.	11:30	10:30	9:30
11	10	9	8
11:30	10:30	9:30	8:30
WOC (483.6m-620kc) Little Jack Little.	12	11	10
1 a. m.	12	11	10
KNX (336.9m-890kc) Movie night.			

Tuesday, silent night for: CFCA, CHIC, CKNC, CKY, CNRC, CNRE, CNRM, CNRO, CNRW, CNRT, KFKX, KFKU, KUOA, KFUO, KFWA, KYX, KOA, KOAC, KOB, KOWW, KUOM, KTAB, KWSC, WABQ, WAHG, WAMD, WBBR, WCAD, WCAL, WCAP, WEMC, WGCP, WGST, WHAD, WHAZ, WIAD, WIJZ, WKAF, WKAQ, WLWL, WMAK, WMAZ, WOI, WOS, WRVA, WSMB, WSUI, WTAM, WTIC.

Eastern Time Stations

CNRA, Moncton, Can. (291.1m-1080kc), 8 p. m., Moncton Firemen's band; 10, CNRA orchestra.

KDKA, Pittsburgh, Pa. (309.1m-970kc), 6:30 p. m.,



Whittall Anglo Persians Orchestra, heard through WEAJ and thirteen other stations, Friday evenings at 10 p. m. Eastern time, is under the successful leadership of Louis Katzman, above. To the left is Homer Grunn, one of America's foremost composers and pianists, who plays frequently at KHJ, Los Angeles.

BelleVue Stratford concert orchestra; 7, BelleVue Stratford dance orchestra; 8-11:30, WEAJ.

WGBS, New York, N. Y. (315.6m-950kc), 7 p. m., Arrowhead Inn concert orchestra; 8, Y. M. H. A. vocational forum; 8:30, Threshold players; 9, Crystal Palace orchestra; 10:30, Arrowhead Inn orchestra.

WGCP, New York, N. Y. (252m-1190kc), 3 p. m., Ora Welsh, pianist; 3:30, Isabelle Henderson, soprano; 3:45, Twentieth Century entertainers; 4:10, Max Heit, violinist; 4:20, Katherine Adolph, soprano; 4:30, Leslie McLeod, tenor; 4:45, Ukulele Bob McDonald.

WGHB, Clearwater, Florida (266m-1130kc), 6:30-7:30 p. m., Crocker and his Gater orchestra; 7:30-8, Caroline Lee and her Spanish guitar; 8:30-9:30, Bill Ewin and L. W. Joes "The Troubadours"; Florence Arlin, concert soprano; 11:45-1 a. m., WGHB.

WGR, Buffalo, N. Y. (319m-940kc), 6:30 p. m., Vincent Lopez Hotel Statler dance orchestra; 8:30, WEAJ.

WGY, Schenectady, N. Y. (379.5m-790kc), 6:30 p. m., Hotel Van Curier orchestra; 7:30, WRC; 9, WGY orchestra; 10:30, Bellinger's society dance orchestra.

WHAR, Atlantic City, N. J. (275m-1090kc), 8 p. m., Seaside hotel concert trio; 9, concert.

WHN, New York, N. Y. (361.2m-380kc), 6 p. m.,

Treasureland Neighbors; 6:30, Everglades orchestra; 7, Iceland orchestra; 7:30, Will Oakland's Chateau; 8, people's hour; 9, Loew's Eighty-third Street orchestra; 9:30, Billy Gleason and entertainers; 11:30, Al Raymo's entertainers; 12, Harry Richman and entertainers.

WIP, Philadelphia, Pa. (508.2m-590kc), 6:15 p. m., Nelson Maples and his S. S. Levathan orchestra; 8:15, "Olivet to Calvary" Maunder's Oratorio Senior Choir of Siloam M. E. church; 9:15, features, Penn Athletic club; 10:30, Pagoda cafe orchestra.

WJAR, Providence, R. I. (305.9m-500kc), 7:30 p. m., musical program; 8:05, Madge H. O'Rourke, soprano; 8:30, WEAJ; 9, WEAJ.

WJR, Pontiac, Mich. (516.9m-580kc), 7 p. m., old-time dance orchestra; 7, Tom Bartel's Boys; 9, orchestra.

WJZ, New York, N. Y. (454.3m-660kc), 7:15 p. m., Helen Davis, banjoist; Sidney Keppell, pianist; 7:30, WRC; 8:30, The Deliah half hour of romance, WGY; 10, "Devonshire and Cornwall"; 10:30, William Bailyn, sea songs; 10:45, George Olsen's Hotel Pennsylvania grill orchestra.

WLWL, New York, N. Y. (288.3m-1040kc), 9:30 p. m., Premier male quartet; 10:15, Premier male quartet.

WMAK, Buffalo, N. Y. (265.3m-1130kc), 6:15-7:15 p. m., Hotel Lafayette orchestra.

High Lights of the Week

ALTHOUGH the aroma of resin will be absent, those tuned in on WIP, Philadelphia, Saturday night will have ringside seats when the amateur leather pushers exchange blows for the Junior National Boxing championships.

Martha Attwood, who has appeared in all the large opera houses in Europe and who last winter gave a special concert for ex-Queen Sophie of Greece, will be one of the artists to appear during WBAL's third Sunday evening artists' program. With her is appearing Oliver Denton, a brilliant young pianist who has also made a name for himself abroad. The Atwater Kent stars of the evening are Richard Bonelli, baritone, and Helen Stanley, soprano. One Sunday feature which should not be forgotten is the production of "The Dancing Princess" by the Dartmouth players at WBZ.

Among the Monday features are the Scotch folk music at KTHS which reveals the simple spirit of the Scotch peasant, the sophisticated modern jazz music of the Manhattan quartet at WJZ and the college songs

of the WHAZ Campus serenaders. There is not a trick left for the banjo or guitar player when the Ararat Temple Shrine serenaders get through with a program at WHB, Kansas City. Their return engagement for this week is scheduled for Tuesday. This is a headliner no fan should miss.

One of the "Radio Franks" who appeared frequently at WEAJ, WJZ and WJY, has left the little circle to tour stations in the United States and Canada. This Frank's last name is Wright and he will begin his travels at WSAI on Wednesday.

Thursday is April 1 and one station, WLW, plans an hour of April Foolishness. The other stations do not mention special programs for this day but fans should be on the lookout for practical jokes over loudspeakers.

Many stations have planned to give the oratorio "Seven Last Words" a Good Friday. Among these is W Hartford. KGO will also give "Darkest Hour."

Boy Who Disc day's feature

SPECIAL SHRINE PROGRAM AT WHB

Thursday, April 1

dinner concert; St. Peter's Lutheran choir; Edith Frazier Rankin, soprano; Jean McCrory Newman, contralto; Vincent Kroen, tenor; C. Frederick Newman, bass-baritone; Little Symphony orchestra, accompanist; 11, Pittsburgh Post midnight revue.

WBAL, Baltimore, Md. (245.8m-1220ke), 6:30-7:30 p. m., dinner program; 7:30-8, organ recital, Frederick Weaver; 8, Dubois' oratorio, "Seven Last Words of Christ," choir.

WBRR, Staten Island, N. Y. (272.6m-1100ke), 8 p. m., Clarion quartet; Elizabeth Paul, soprano.

WBZ, Springfield, Mass. (333.1m-900ke), 6:30 p. m., Hotel Kimball orchestra; 6:45, Hotel Lenox ensemble; 7, Hotel Kimball orchestra; 8, musical program; 9, John E. Shea, ukulele soloist; 9:15, Mrs. Dora Boedeker Gottsche, mezzo-soprano; 9:30, Arthur Clifton, organist.

WCAE, Pittsburgh, Pa. (461.3m-650ke), 6:30 p. m., dinner concert; 8, WEA; 8:30, WEA; 9, WEA; 10, Silvertown Cord orchestra.

WCAU, Philadelphia, Pa. (277.6m-1080ke), 6:30 p. m., Cathay Tea Garden dance orchestra; 7:30, Snellenburg Symphony orchestra; 8, the Mitchell Gondolier; 8:15, recital; 8:45, the Kandy Kids; 9, Barry O'Moore, Irish tenor; 9:30, the Musical Chorus; 9:45, Professor Doolittle; 10, Sequi-Centennial hour; 11, Parolians dance orchestra; 11:30, Club Cadix revue.

WEAF, New York, N. Y. (491.5m-610ke), 6 p. m., dinner music, Hotel Waldorf-Astoria; 7:30, Ballin and Race, piano duo; 8, Ladies' Victory quartet; 8:30, Hire's Harvesters; 9, Clitquot Club Eskimos; 10, Goodrich Silvertown Cord orchestra; 11, Vincent Lopez and orchestra.

WEI, Boston, Mass. (348.6m-860ke), 7:30 p. m., Rickenbacker's Old Homestead group; 8-11, WEA.

WFI, Philadelphia, Pa. (394.5m-760ke), 6:30 p. m., Bellevue Stratford concert orchestra; 7, Bellevue Stratford dance orchestra; 8-11, WEA.

WGBS, New York, N. Y. (315.6m-950ke), 9 p. m., Crystal Palace orchestra; 10:30, orchestra.

WGCP, New York, N. Y. (252m-1190ke), 3 p. m., Ora Welsh, pianist; 3:30, Frank Gallasi, ukulele; 3:45, Dorothy Blechrod, pianist; 4, Ed Gillis, songs; 4:30, Al Wilson, entertainers; 4:45, studio program; 10:30, Irving Firstenberg, pianist; 10:45, studio program; 11, Piotti and Val; 11:15, Katherine Adolph, soprano; 11:30, Strickland's orchestra; 12-2 a. m., midnight program.

WGH, Clearwater, Fla. (266m-1130ke), 6:30-7:30 p. m., Belleair Estates orchestra; 11:30-1, midnight Tangle.

WGR, Buffalo, N. Y. (319m-940ke), 6:30 p. m., Hotel Statler dance orchestra; 9, WEA.

WGY, Schenectady, N. Y. (379.5m-790ke), 6:30 p. m., Ten Eyck trio; 7:45, program; 9, WJZ; 10, WGY orchestra; Frank Erwin, tenor; 11:30, Stephen E. Bolscliar, organist.

WHAR, Atlantic City, N. J. (275m-1090ke), 8 p. m., Seaside hotel concert ensemble; 11, dance orchestra.

WHN, New York, N. Y. (361.2m-380ke), 6 p. m., Treasureland; 6:30, the People's hour; 7:30, music; 8, Will Oakland's Chateau; 8:30, Mathushek half-hour beautiful; 9-9:30, Al Herman's broadcasting entertainment; 10:30, Leroy Smith's orchestra; 11, Joe Ward's Swane entertainers; 11:30, Everglades orchestra; 12, Al Raymo's entertainers.

WIP, Philadelphia, Pa. (508.2m-590ke), 6:05 p. m., Pagoda cafe orchestra; 7, Uncle Wip's bedtime stories; 8, Millicent Morse, songs; 8:15, the Y. M. and Y. W. H. A. chorus and orchestra; 10:05, Nelson Maples and his S. S. Levathan orchestra.

WJAR, Providence, R. I. (305.9m-500ke), 8 p. m., Robert W. Power's orchestra; 9-11, WEA.

WJR, Pontiac, Mich. (516.9m-580ke), 7 p. m., Petite symphony orchestra; 7:30, reallors; 9, orchestra; 10, dance music.

WJZ, New York, N. Y. (454.3m-660ke), 7 p. m., Hotel Vanderbilt orchestra; 7:45, Judge, Jr.; 8, WRC; 8:30, First National Pictures, WRC; 9, Royal Typewriter salon orchestra, WRC; WGY, WCAU; 10, Record Boys; 10:45, Freddie Rich and his Hotel Astor dance orchestra.

WMAK, Buffalo, N. Y. (265.3m-1130ke), 6:15-7:15 p. m., Hotel Lafayette orchestra; 7:30-8, program, Brookshire Cheese company.

WMC, New York, N. Y. (346.7m-880ke), 6 p. m., Olcott Vail and Hotel McAlpin string ensemble; 6:30, Parody orchestra; 7, Iwika Oaks orchestra; 7:15, Arthur West's Strings; 8:30, Snedden Weir, band; 10:30, Tango orchestra; 11, Hotel McAlpin orchestra; 12, Broadway night.

WNYC, New York, N. Y. (526m-570ke), 8 p. m., Henry Duval, concert violinist; 8:30, song recitals; 9:15-10:10, Original Black Diamond Serenaders.

WOO, Philadelphia, Pa. (508.2m-590ke), 7:30 p. m., Ritz Carlton dance orchestra; 8, recital; 9:25, Fox theater program; 10:15, organ recital, Mary V. Vogt; 10:30, Sylvania orchestra.

WOR, Newark, N. J. (405.2m-740ke), 6:30 p. m., Jacques Jacquet's Hotel Shelton ensemble.

WPG, Atlantic City, N. J. (299.8m-1000ke), 6:45 p. m., organ recital, Arthur Scott Brook; 7, Hotel Ambassador music; 8:15, concert, Atlantic Board of Education; 10, Atlantic City estates dance orchestra; 11, Eddie McKnight's orchestra.

WRC, Washington, D. C. (468.5m-640ke), 8 p. m., Ft. S. Army band, WJZ; 8:30, WJZ; 9, WJZ; 10, WJZ; 10:30, Meyer Davis' Le Paradis band.

WRVA, Richmond, Va. (256.6m-1170ke), 9:30 p. m., "Edgeworth party night," music.

WTAG, Worcester, Mass. (267.7m-120ke), 8-8:30 p. m., WEA; 9-10, WEA; 10-11, WEA.

WTAM, Cleveland, Ohio (389.4m-770ke), 6-7 p. m., Austin Wylie's Vocalion Recording orchestra.

WTC, Hartford, Conn. (475.9m-630ke), 6:50 p. m., Hotel Rond trio; 8:15, Williams college musical clubs.

WVA, Detroit, Mich. (352.7m-850ke), 6 p. m., dinner concert; 8, WDA.

WCCO, Minneapolis-St. Paul, Minn. (416.4m-720ke), 7 p. m., WEA; 7:30, Northern Pacific program; 8-10, WEA; 10:20, Golden Pheasant orchestra.

WDAF, Kansas City, Mo. (365.6m-820ke), 6-7 p. m., the Trianon ensemble; 11:45-1 a. m., Nighthawk frolic; Johnnie Campbell's orchestra; Ted Weems Victor Recording orchestra.

WGES, Oak Park, Ill. (250m-1200ke), 8-9 p. m., orchestra; 11-1 a. m., Coyne serenaders.

WGN, Chicago, Ill. (302.8m-990ke), 6:30-6:45 p. m., Drake concert ensemble, Blackstone string quintet; 6:45, old-time favorites; 8:55-7, "The Million Sing"; 8-10, WEA; 10, Sam 'n' Henry; 10:10, old-time favorites; 10:20, play shop; 10:40-11, studio ensemble.

WHAD, Milwaukee, Wis. (275m-1090ke), 6:15-7 p. m., Bill Benning's Milwaukee Athletic club orchestra; 8:30-10:30, orchestra.

WHAS, Louisville, Ky. (399.8m-750ke), 7:30-9 p. m., Virginia Vetter's entertainers.

WHB, Kansas City, Mo. (365.6m-820ke), 7-7:45 p. m., organ concert; 8-9, operatic selections, string quartet; 9-10, musical program; Thomas Healey, basso; Mrs.

WEAF, 11-11:20, Correll and Gosden; 11:20-1 a. m., studio ensemble, dance music, harmony duos.

WLS, Chicago, Ill. (344.6m-870ke), 6 p. m., trio; 6:40, Maurie Sherman's College Inn orchestra; 7, lullaby time, Ford and Glenn; 7:15, Sherman's College Inn orchestra; 7:30-7:55, Salvation Army staff band.

WLW, Cincinnati, Ohio (422.3m-710ke), 7 p. m., Robert Visconti's Hotel Gibson orchestra; 10:03, French-Bauer hour, Doherty Melody boys; 11, an hour of "April Foolishness"; 12, dance music, Castle Farm; 12:15, Night Howls, the Crosby Pups.

WMAQ, Chicago, Ill. (447.5m-670ke), 6 p. m., Chicago theater organ; 6:30, Hotel La Salle orchestra; 9:20, WMAQ players; 9:55, chimes.

WMBB, Chicago, Ill. (250m-1200ke), 7-8 p. m., Trianon ensemble, Norwegian music; Trianon trio; 9-11, orchestras; Trianon duo; Bob Duffy, baritone; C. Keithley, tenor.

WOAI, San Antonio, Texas (394.5m-760ke), 8:30 p. m., Mistletoe Melody Maids.

WOAW, Omaha, Neb. (526m-570ke), 6 p. m., Dorothy Lowden, harpist; F. M. Mills, trumpeter; 6:20, Manna

KOA, Denver, Colo. (322.4m-930ke), 6:30 p. m., Brown Palace string orchestra.

Pacific Time Stations

KFI, Los Angeles, Calif. (467m-642ke), 5:30-6 p. m., Bamboo Gardens orchestra; 7-8, program, students of U. S. C.; 8-9, program, Rexall stores of California and Arizona; 9-10, program, Chickering Hall; 10-11, popular hour.

KFON, Long Beach, Calif. (232.4m-1280ke), 6:30 p. m., Brayton's theater organ; 7:30-8, Long Beach Municipal band; 8:15-9, Long Beach Municipal band; 9-11, Lake's club orchestra.

KFWB, Hollywood, Calif. (252m-1190ke), 8-9 p. m., Frazier orchestra, Albert Keglovich, violinist; Estelle Shaker, blues singer; 9-10, Don P. Smith, Inc., Diana-Moon dance orchestra; Sol Hoopii's Hawaiians, Ashley Sisters; 10-11, Warner Brothers frolic.

KGO, Oakland, Calif. (361.2m-830ke), 8-9 p. m., Conn Instrument company orchestra, Marimba band, popular concert; Cowell Dein, banjoist; Conn trio; Londo Gelani, tenor; Al Hyndman, pianist; 9-10, Finnish music program; Saima Bloomquist, pianist; mixed chorus; Martha Jalava, mezzo soprano; 10-1 a. m., Brokaw and his dance orchestra.

KGW, Portland, Ore. (491.5m-610ke), 6-7 p. m., dinner concert; 8-10, vaudeville.

KHJ, Los Angeles, Calif. (405.2m-740ke), 8-10 p. m., program, Cochran Brothers company.

KJR, Seattle, Wash. (384.4m-780ke), 7-8:30 p. m., Eureka mixed quartet; 8:30-10, Puget Sound Savings and Loan association orchestra; 10:30-12, Keep Joy Radiating Order of Bats.

KMTR, Hollywood, Calif. (238m-1260ke), 6-7 p. m., Starr Piano company studio; 8-10, KMTR concert orchestra; Florence Mason Talsch, soprano.

KNX, Hollywood, Calif. (336.9m-800ke), 5:30, Leighton's cafeteria orchestra; 6:30-7, Atwater Kent concert orchestra; 7-8, program, H. L. Crockett Hudson-Essex company; 8-9, program, Willys-Overland dealers; 9-10, program, Frazier Mountain Park; 10-11, KNX feature program; 11-12, Ray West's Coconut Grove dance orchestra.

KPO, San Francisco, Calif. (428.3m-1000ke), 6:30-7 p. m., States restaurant orchestra; 7-7:30, Rudy Seiger's Fairmont hotel orchestra; 8-10, Islam temple band, chanters; 10-11, Cabrera cafe dance orchestra; 11-12, Henry Halstead's orchestra.

KPSN, Pasadena, Calif. (315.6m-950ke), 8-9 p. m., Pasadena chamber of commerce.

KTAB, Oakland, Calif. (239.9m-1250ke), 8-10 p. m., program.



"The Bohemian Girl" is the feature Friday, March 26, at WHAS, Louisville. The Operatic ensemble of the Greater Louisville Savings and Building association is giving the production.

W. Lyons, soprano; Mrs. Ralph Street, violinist; ukulele songsters, Harry Taylor, Sam Martin; Mrs. H. Taylor, pianist.

WHO, Des Moines, Iowa (526m-570ke), 7:30-8 p. m., the Raleigh quintet; 8-9, Bankers Life trio; 11-12, the Bankers Life Corn Sugar orchestra.

WHT, Chicago, Ill. (399.8m-750ke), 12 noon, Al Carney's complimentary organ recital; 6 p. m., dinner organ recital, Al Carney; 6:30, Hugh Aspinwall, tenor; Grayling's string trio; 6:45, Swedish program; 9:15, Cinderella cafe orchestra; 9:30, Kitchen Klezzer Klans; 9:50, Jack Turner, singers; Jack Marshall, pianist; 10:10, U. S. L. entertainers; male quartet; 11:30, Pat Barnes and Al Carney; 12, Pat Barnes and Al Carney.

WJAZ, Chicago, Ill. (322.4m-930ke), 9 p. m., chimes; Scottish male chorus; Mildred Bolan, contralto; Grace Hanson, violinist; Charles Graves, tenor; Mary Pearce Niemann, pianist.

WJJD, Mooseheart, Ill. (370.2m-810ke), 2-3 p. m., Howard L. Peterson, organist; 4-5, music, children; 5:30-7, Jack Nelson; Palmer House symphonic players; Howard L. Peterson, organist; Palmer House Victorians; Salvation Army band; 12:30 a. m., Palmer House Victorians; Jack Nelson.

WLIB, Chicago, Ill. (302.8m-990ke), 7:30-8 p. m.,

Kea trio; 6:50, Randall's Royal Fontenelle orchestra; 9, deluxe program.

WOC, Davenport, Iowa (483.6m-620ke), 7-7:30 p. m., WEA; 8-9, WEA; 9-10, WEA; 11-12, LeClaire hotel orchestra; Jack Little.

WOK, Chicago, Ill. (217.3m-1300ke), 4:30-7 p. m., Capitol theater organ; studio program; 10-1:30 a. m., dance music; Capitol theater program.

WORD, Batavia, Ill. (275.1m-1090ke), 8 p. m., Webster hotel; 8:30, studio recital, Cosmopolitan School of Music.

WQJ, Chicago, Ill. (447.5m-670ke), 7-8 p. m., Clement Laskowski, tenor; Margaret Cade, soprano; Madeline Ruff, pianist; Ralph Williams and his orchestra; 10-1 a. m., Ralph Williams and Skylarks; H. Lucille Long, harmonica player; Romo Vincent, baritone; Clark's Hawaiian trio; artists; 1-2, Ginger hour.

WSAI, Cincinnati, Ohio (325.9m-920ke), 7 p. m., Frank Wright; 7:30, WEA; 8, WEA; 9, WEA.

WSB, Atlanta, Ga. (428.3m-700ke), 8 p. m., program, E. W. Wilson, Lucie Moore; 10:45, Charles A. Sheldon, Jr., organist.

Mountain Time Stations

CFAC, Calgary, Can. (435.8m-688ke), 9-11 p. m., Hayden male quartet.

Friday, April 2

Headlines Today

Eastern	Central	Mountain	Pacific
8:15 p. m.	7:15 p. m.	6:15 p. m.	5:15 p. m.
WGY (379.5m-790ke)	"A Step on the Stairs," mystery serial.		
8:30	7:30	6:30	5:30
WIO (526m-570ke)	University quartet.		
9			
WBZ (333.1m-900ke)	Good Friday program.		
WDAF (365.6m-820ke)	Negro spirituals.		
WSM (282.8m-1060ke)	Easter program.		
WTIC (475.9m-630ke)	"Seven Last Words," symphony.		
8:30	7:30	6:30	5:30
WGY (379.5m-790ke)	"The Boy Who Discovered Easter," play.		
10	9	8	7
KOA (322.4m-930ke)	Good Friday service.		
WJZ (454.3m-660ke)	WGWB Baldwin hour.		
10:30	9:30	8:30	7:30
KTHS (374.8m-800ke)	Novelty program.		
WOC (483.6m-620ke)	Jack Little.		
11	10	9	8
KFI (467m-640ke)	Good Friday program.		
KGO (361.2m-830ke)	"The Darkest Hour," cantata.		
1:30 a. m.	12:30 a. m.	11:30	10:30
KGW (491.5m-610ke)	"Keep Growing Wiser Order of Hoot Owls."		

Friday, silent night for: CFAC, CHIC, CKNC, CKY, CNRC, CNRO, CNRR, CNRW, KFAU, KFEQ, KFKU, KFWA, KFXF, KFAU, KLDS, KPRC, KPSN, KUOA, KUOM, PWX, WBBR, WCAU, WCBG, WCAO, WEBW, WGBS, WGST, WHAZ, WIP, WJAZ, WKRC, WLW, WLWL, WMAK, WNAD, WRC, WREO, WRVA, WSAI, WSMB, WSUI, WTAM.

Eastern Time Stations

KDKA, Pittsburgh, Pa. (309.1m-970ke), 6:30 p. m., dinner concert; 10:10, Teaberry time.

WAHG, Richmond, Hill, N. Y. (315.6m-945ke), 8 p. m., organ recital, Skinner Organ company; 9, "The Crucifixion," Sir John Stainer.

WBAL, Baltimore, Md. (245.8m-1220ke), 6:30-7:30 p. m., WBAL dinner orchestra; 7:30-8, organ program, Frederick Eriksson; 8-9, Good Friday program, "Lamentations of Palestine," choir; 9-10, concert trio, Michael Welner, violinist; Leroy Evans, pianist; Samuel Stern, cellist.

WBZ, Springfield, Mass. (333.1m-900ke), 6:30 p. m., Hotel Kimball orchestra; 7, Hotel Lenox ensemble; 8, Cook's Butterfly ballroom; 8:30, Clara Larsen, pianist; Edith Woodman, soprano; 9, Good Friday program; 10, Baldwin hour.

WCAE, Pittsburgh, Pa. (461.3m-650ke), 6:30 p. m., dinner concert; 8, studio program; 9:30, WEA; 10:30, WEA.

WCAP, Washington, D. C. (468.5m-640ke), 6 p. m., Mozart string quintet; WEA.

WCAU, Philadelphia, Pa. (277.6m-1080ke), 6:45 p. m., Hotel Pennsylvania orchestra; 7:30, Snellenburg instrumental trio; 8, recital; 8:30, the Singing Groundhog; 8:45, the Bryan Girl; 9:15, Dwight Strickland, "poetician"; 9:30, the Sea Gulls dance orchestra; 10, songs; 10:30, Myers' Musical architects.

WEAF, New York, N. Y. (491.5m-610ke), 6 p. m., Hotel Waldorf-Astoria; 7, Vladio Kolich, violinist; 7:45, Jessie Covington, pianist; 8:15, Myrtle Stitt Mason, contralto; 8:30, Langis Neutrodyne trio; 9-10, Mount Oliver Calvary; 10, Whittall Anglo-Persians; 10:30-11:30, "Seven Last Words."

WEBJ, New York, N. Y. (272.6m-1100ke), 7 p. m., Blenheim theater ensemble, direction Sol Klein; 7:45, Isabel Henderson, soprano; 8, W. C. Infield, concert pianist; 8:15, Jack Maroney, the ukulele kid; 8:30, Al Ciccone's Harlem Tea Garden orchestra.

WEEI, Boston, Mass. (348.6m-860ke), 7:30 p. m., Whiting Milk company program; 8:30, musical; 8:30, Neapolitan Ice Cream company program; 9, musical; 9:30, Carter's Inca; 10, WEA.

WFI, Philadelphia, Pa. (394.5m-760ke), 6:30 p. m., Bellevue Stratford concert orchestra.

WGBS, New York, N. Y. (315.6m-950ke), 6:30 p. m., Anzell's orchestra.

WGCP, New York, N. Y. (252m-1190ke), 3 p. m., Elvira Ross Gelger, pianist; 3:30, Marie Kalla, soprano; 3:45, Sherman and Neal, songs; 4:15, studio program; 4:45, Rubey Cowan, songs; 5:10, Clarence Profit, pianist; 7, China Royal orchestra; 7:30, Billy Infield, singing pianist; 8, Milt Simpson, comedian.

WGH, Clearwater, Fla. (266m-1130ke), 6:30-7:30 p. m., Mandalyal orchestra; 8:30-10, Maurice Trayer, director; 11:30-1, Mandalyal orchestra.

WGR, Buffalo, N. Y. (319m-940ke), 2 p. m., Good Friday program; 6:30, the Californians orchestra; 7:30, WEA; 8, piano program, Hamilton A. Dakers; 9:30, Club Royale orchestra; 10, WEA; 10:30, Hewitt Humorists; 11, Vincent Lopez Hotel Statler dance orchestra.

WGY, Schenectady, N. Y. (379.5m-790ke), 7 p. m., Eastman theater orchestra; 8:15, "A Step on the Stairs"; 8:30, Stainer chorus choir; Henry W. Stewart, organist; 9:30, WGY orchestra; one-act play, "The Boy Who Discovered Easter"; 10, musical program.

WHAR, Atlantic City, N. J. (275m-1090ke), 8 p. m., Seaside hotel concert ensemble.

GENERAL TALKS AND SPEECHES

Saturday, March 27			
Eastern	Central	Mountain	Pacific
6:15 p. m.	5:15 p. m.	4:15 p. m.	3:15 p. m.
WOR (405.2m-740ke)	Sport talk, Bill Wathey.		
7	6	5	4
WEAF (491.5m-610ke)	"What I know about Architecture," Harvey Wiley Corbett.		
6:10	7:10	6:10	5:10
WRC (468.5m-640ke)	Address, James M. Beck.		
8:45	7:45	6:45	5:45
WPG (299.8m-1000ke)	"Golf," Kendall H. Read.		
9	8	7	6
WCCO (416.4m-720ke)	"Fireside Philosophies," Rev. Roy L. Smith.		
9:30	8:30	7:30	6:30
WMAQ (447.5m-670ke)	"New Zealand," Capt. Kilroy Harrison.		
9:45	8:45	7:45	6:45
KELJ (405.2m-740ke)	History story, Prof. Hertzog.		
10	9	8	7
Monday, March 29			
Eastern	Central	Mountain	Pacific
7 p. m.	6 p. m.	5 p. m.	4 p. m.
WDAF (365.6m-820ke)	Address, Edgar A. Linton.		
7:30	6:30	5:30	4:30
WHAR (275m-1090ke)	Book Review, Edna Miriam Hoopes.		
9	8	7	6
WAHG (315.6m-950ke)	"Florence," Major Dent Atkinson.		
10:25	9:25	8:25	7:25
WMC (310.7m-880ke)	Christian Science lecture, Dr. Douglas Freeman.		
11:25	10:25	9:25	8:25
KGO (361.2m-830ke)	"Chats About New Books," Joseph Henry Jackson.		
12	11	10	9
Tuesday, March 30			
Eastern	Central	Mountain	Pacific
7:20 p. m.	6:20 p. m.	5:20 p. m.	4:20 p. m.
WLW (422.3m-710ke)	"The Big Tree of California," Willis T. Sparhawk.		
7:30	6:30	5:30	4:30
WHAR (275m-1090ke)	"Glimpses Through the Stage Door," Mort Eiskman.		
9	8	7	6
WGY (379.5m-790ke)	Talk, Percy B. Scott.		
9:30	8:30	7:30	6:30
WMAQ (447.5m-670ke)	Book talk, Harry Hansen.		
10	9	8	7
WRC (468.5m-640ke)	Washington's Political situation, Frederic W. Wile.		
10	9	8	7
WJZ (454.3m-660ke)	Grand tour, London.		
10:30	9:30	8:30	7:30
WCCO (416.4m-720ke)	"Outdoors in Minnesota."		
11	10	9	8
Wednesday, March 31			
Eastern	Central	Mountain	Pacific
6:35 p. m.	5:35 p. m.	4:35 p. m.	3:35 p. m.
WIP (508.2m-590ke)	"The Farm Boy Makes Good," R. W. Helm.		

MARKETS AND WEATHER

Daily Except Sunday

Eastern	Central	Mountain	Pacific
9:30 a. m.	8:30 a. m.	7:30 a. m.	6:30 a. m.
WOAW (526m-570kc) Markets.			
9:45	8:45	7:45	6:45
KDKA (309.1m-970kc) Livestock, grain.			
10	9	8	7
WLS (344.6m-870kc) Livestock, markets, fruit.			
WOS (440.9m-680kc) Hogs.			
10:30	9:30		7:30
WFAA (475.9m-630kc) Markets.			
10:45	9:45	8:45	7:45
WCCO (416.4m-720kc) Markets.			
WHO (526m-570kc) Opening grain quotations.			
New York and Chicago stock exchange. Livestock, weather, roads.			
WMC (409.7m-600kc) Weather, markets.			
11	10	9	8
WOS (440.9m-680kc) Weather, hogs.			
11:15	10:15	9:15	8:15
WTAG (268m-1120kc) Markets, weather.			
11:30	10:30	9:30	8:30
WCCO (416.4m-720kc) Markets.			
12 n.	11	10	9
KDKA (309.1m-970kc) Weather, livestock, grain.			
WBAP (475.9m-630kc) Weather, cattle, grain.			
WLS (344.6m-870kc) Poultry, dairy, hogs, sheep.			
WOS (440.9m-680kc) Livestock, poultry, eggs, grain.			
12:30 p. m.	11:30	10:30	9:30
WEAR (384.4m-780kc) Markets, weather.			
WFAA (475.9m-630kc) Markets.			
1	11	10	9
WBAP (475.9m-630kc) Markets.			
WHO (526m-570kc) Livestock, receipts. Weather, roads.			
WOS (440.9m-680kc) Livestock, weather.			
1:30	12:30 p. m.	11:30	10:30
KTHS (374.8m-800kc) Markets, weather, market, apples.			
WOAW (526m-570kc) Markets.			
1:45	12:45	11:45	10:45
KOA (322.4m-930kc) Weather, roads, livestock, poultry.			
2	1	12 n.	11
WOC (483.6m-620kc) Weather, grain, livestock, dairy.			
3	2	1 p. m.	12 n.
WHO (526m-570kc) Livestock, Chicago and St. Louis closing cash market quotations, Chicago Board of Trade, N. Y. Stock exchange.			
WLS (344.6m-870kc) Livestock, grain, dairy, fruit, vegetables.			
WOS (440.9m-680kc) Livestock, markets, grain.			
3:30	2:30	1:30	12:30 p. m.
WFAA (475.9m-630kc) Markets.			
3:50	2:50	1:50	12:50
WWJ (352.7m-850kc) Weather, markets.			
4	3	2	1
WCCO (416.4m-720kc) Markets.			
WFAA (475.9m-630kc) Markets.			
6:45	5:45	4:45	3:45
KSAC (340.7m-880kc) Market review.			
8	7	6	5
KOA (322.4m-930kc) Sheep, markets, livestock, poultry.			

Friday, April 2

WHN, New York, N. Y. (351.2m-380kc), 6 p. m., people's hour; 7, Harry Richman and entertainers; 10, Roseland dance orchestra; 10:30, Anatol Friedland; 11:30, Kit Kat club orchestra; 12, Silver Slipper orchestra.

WIP, Philadelphia, Pa. (508.2m-590kc), 6:05 p. m., Benjamin Franklin concert orchestra; 7, Howard Waddeel, songs.

WIAR, Providence, R. I. (305.9m-500kc), 8 p. m., musical program; 8:30, Gorman's Jolly Bakers; 9, musical program; 9:30, WEAF; 10, WEAF; 10, Providence-Biltmore orchestra.

WJR, Pontiac, Mich. (516.9m-580kc), 7 p. m., Jean Goldkette's symphony; 7:30, Arctic specials; 9, Mulkey celebrities; 9:30, Caspar Lingenan symphony.

WJZ, New York, N. Y. (455m-660kc), 7 p. m., Hotel Commodore concert orchestra; 8, Sundial Shoe serenaders; 8:30, Bonnie Laddies; 9:30, Bruno Labate Woodwind ensemble; 10, Baldwin Piano hour, WGY; 11, Hotel Lorraine Grill orchestra.

WLIT, Philadelphia, Pa. (394.5m-760kc), 7:30 p. m., Dream Daddy's bedtime stories; 8, sports talk; 10, Morning Glory club concert; Arcadia cafe dance orchestra; 10:30, Rufus and Rastus; 11, Morning Glory club concert.

WMCA, New York, N. Y. (340.7m-880kc), 6 p. m., Okech Wall and Hotel McAlpin string ensemble; 6:30, Ernie Golden and Hotel McAlpin orchestra; 7:30, Sach's Musical Monarchs; 8:50, Broadway association; 9, Hardman hour of music; 10:30, Parody orchestra; 11, Hofbrau Haus entertainers; 11:30, Jaek Denny's orchestra; 12 m., McAlpin entertainers.

WNYC, New York, N. Y. (526m-570kc), 6:20 p. m., piano selections; 7:35, studio features; 9:30, violin recitals; 10, songs.

WOO, Philadelphia, Pa. (508.2m-590kc), 7:30 p. m., Sylvania dance orchestra; 8, recital; 8:25, Fox theater program; Fox theater grand symphony orchestra. Adolph Kornspan, director; 10:15, organ recital, Marcy E. Vogt; 10:30, Sylvania dance orchestra.

WOR, Newark, N. J. (405.2m-740kc), 6:45 p. m., studio program; 7:15, Copenhagen quartet.

WPG, Atlantic City, N. J. (299.8m-1000kc), 6:45 p. m., organ recital, Arthur Scott Brook; 7, Hotel Morton music; 8:15, studio program; Outbert Melody boys; 9, Hotel Traymore orchestra; 10, organ recital, Jean Wlener.

WRVA, Richmond, Va. (256.3m-1170kc), 8:15 p. m., organ prelude, Ernest H. Cosby, soloists.

WTAG, Worcester, Mass. (267.7m-1120kc), 6-7 p. m., WTAG orchestra; 8:15-10, concert announced; 10-10:30, WEAF.

WTAM, Cleveland, Ohio (389.4m-770kc), 6-7 p. m., Hotel Hollenden orchestra.

WTIC, Hartford, Conn. (475.9m-630kc), 6:30 p. m., Hub trio; 8, Coast Guard academy band; 9, Traversers symphonic ensemble.

WWJ, Detroit, Mich. (352.7m-850kc), 6 p. m., dinner concert; 8, Detroit News orchestra; C. T. S. and gang; 8:30, WEAF; 10:30, dance program.

Central Time Stations

KFAB, Lincoln, Neb. (340.7m-1000kc), 8:30-1:30, Mcd. Red, Band of Crete.

KFNH, Shenandoah, Iowa (263m-1140kc), 7:30 p. m., pipe organ concert.

KFRU, Columbia, Mo. (499.7m-600kc), 6:15 p. m., dinner music; 12-2 a. m., musicals.

KMA, Shenandoah, Iowa (252m-1190kc), 6-7 p. m., Grady and Doc; 9-11, program, talent, Colm.

KMOX, St. Louis, Mo. (280.2m-1070kc), 6 p. m., organ recital, Arthur Utt; 6:30, Mrs. Jacques Landree; 7, orchestra; Buster Brown, Charlotte with ukulele; 8, artists' program; 9, orchestra, Leonard Phillips; 10, popular dance program.

KOIL, Council Bluffs, Iowa (277.6m-1080kc), 6:05 p. m., program; Clara Kurtz, pianist; Lucy Rhybo, soprano; 6:30, Royal Fontenelle orchestra; 8:15, Katherine Lemen, contralto; Dorothy Kelloway, soprano; Margaret Lemen Green, pianist; Elizabeth Quinn, accompanist; 11, Hotzy Totsy hour.

KSD, St. Louis, Mo. (545.1m-550kc), 7:30 p. m., Westminster Presbyterian church; 9, WEAF.

KTHS, Hot Springs National Park, Ark. (374.8m-

800kc), 9-9:30 p. m., classic half hour, New Arlington Hotel Grand ensemble; 9:30-10:25, novelty program, Jack O' Lantern Night club; 10:25-10:45, Tom Cochran and John G. Heyn, tenor and pianist; 10:45-11:15, dance offerings, Meyer Davis orchestra.

KYW, Chicago, Ill. (536m-560kc), 6 p. m., dinner music; 6:30, dinner music, Congress hotel; 7:30-9, home-lovers hour; 9-10, hour of music; 10-12, mid-night revue.

WAMD, Minneapolis, Minn. (244m-1230kc), 7:10 p. m., Minneapolis Public School hour; 8, Reception Five musical program; 11, Skyrocket frolic.

WBAP, Fort Worth, Texas (475.9m-630kc), 6 p. m., dinner music; 7:30, Maggie Overstreet, pianist; 9:30, sacred program; 11, Panthers Hawaiian trio.

WCAL, Northfield, Minn. (336.9m-890kc), 8:30 p. m., classical program.

WCCO, Minneapolis-St. Paul, Minn. (416.4m-720kc), 6:15 p. m., Dick Long's Nankin cafe orchestra; 8, Watkins family party; 9, WEAF.

WDAF, Kansas City, Mo. (365.6m-820kc), 6-7 p. m., Trioon ensemble; 8-9:30, Negro spirituals, Ebenezer Methodist Episcopal church; 11:45-1 a. m., Night-hawk frolic; Ted Weems orchestra; Billy Adair's orchestra, organ, Ted Meyn.

WEMC, Berrien Springs, Mich. (285.5m-1050kc), 9 p. m., organ recital, Dr. Birt Summers; the Light-house choir; 10:05, duet, Mrs. Lela Bouchell, soprano and Martha Hutchison, contralto.

WGBF, Evansville, Ind. (236.1m-1270kc), 8 p. m., May Memorial organ concert.

WGES, Oak Park, Ill. (250m-1200kc), 8-9 p. m., entertainment; 11-1, Coyne serenaders.

WGN, Chicago, Ill. (302.8m-990kc), 6:30-6:45 p. m., Drake concert ensemble, Blackstone string quintet; 6:45, old-time favorites; 6:55-7, the Million sing; 8-8:30, WEAF; 8:30-9, quartet; 9-9:30, WEAF; 9:30-10, studio program; 10, Sam 'n' Henry; 10:10, old-time favorites; 10:20, the Play Shop; 10:45-11, studio ensemble.

WHAD, Milwaukee, Wis. (275m-1090kc), 6:15-7 p. m., Arthur Richter, organist; 8:30-10, Marquette university studio program.

WHAS, Louisville, Ky. (399.8m-750kc), 7:30-9 p. m., Southern Baptist Theological seminary.

WHB, Kansas City, Mo. (365.6m-820kc), 7-8 p. m., Selda McDivot, blue songs; Harry Kessell, popular songster; Lola Reardon, pianist.

WHO, Des Moines, Iowa (526m-570kc), 7:30-9 p. m., Des Moines university male quartet; 11-12, Philbreck and his Youkers; Tea-Room orchestra.

WHT, Chicago, Ill. (399.8m-750kc), 12 noon, Al Carney's complimentary organ recital; 6 p. m., classical program; dinner organ recital, Al Carney; Grayling's string trio; Helen Rauh, pianist; Charles Hussey, basso; 6:50, Ray-O-Vac concert; 9:15, musical features; Cinderella Cafe orchestra; 9:30, novelties; 11:30, Pat Barnes and Al Carney; Cinderella Cafe orchestra; 12, Pat Barnes and Al Carney.

WJAZ, Chicago, Ill. (322.4m-990kc), 9-2 a. m., diversified studio and dance program, Chez Pierre.

WJJD, Meeseheart, Ill. (370.2m-810kc), 12-1 p. m., Palmer House symphonic players; trio; 2-3, organ hour, Howard L. Peterson; child artists; assembly of 1,250 children; 5:30, instrumental hour; Palmer House symphonic players; Jack Nelson; Victorians; 6:40, Billy Van; 8-9, children's hour; 10-11, feature hour; Senator Harold C. Kessinger; Palmer House Violians; Jean St. Anne; 12:30 a. m., Knights of the Burning Candle.

WLIB, Chicago, Ill. (302.8m-990kc), 7:30-8 p. m., musical program; 11-11:30, Correll and Gosden; 11:20-1 a. m., ensemble, dance music, harmony duos.

WLS, Chicago, Ill. (344.6m-870kc), 6 p. m., Ford and Glenn; 6:40, Alaurie Sherman's College Inn orchestra; 7, lullaby time, Ford and Glenn; 7:15, Sherman's orchestra; 7:30, trio, picture page program; 8, Ford and Glenn; 8:30, Ralph Emerson, organist; 9, Young American artists, Earl Kardus, tenor; Wimitrid Erickson, soprano; 10-11, Ford and Glenn Music shop.

WMAQ, Chicago, Ill. (447.5m-670kc), 6 p. m., Chicago theater organ; 6:20, Family Altar league; 6:30, Wide-Awake club program; 8:30, announced; 9:55, chimes.

WMBB, Chicago, Ill. (250m-1200kc), 7-8 p. m., Trioon ensemble, Vella Cook, contralto, Frank Borner, baritone; McCready and Hart, Harmony duo; 9-11, orchestra; Ted Graham, Andy Anderson, Scotty Welch and Madison Sisters; Joe Warner, Bab Bennett.

WQAI, San Antonio, Texas (394.5m-760kc), 8:30 p. m., San Antonio college of music program.

WOAW, Omaha, Neb. (526m-570kc), 6:20 p. m., Francis Potter's banjo orchestra; 6:50, Gilbert Jaffy, violinist; Nat Young, pianist; Karl Tunberg, pianist; 9, program, M. C. Peters Mill company; 10:30, Frank Hodek and his Nightingale orchestra.

WOC, Davenport, Iowa (483.6m-620kc), 8:30-9 p. m., WEAF; 9-9:30, WEAF; 9:30-10:30, musical program; Jack Rogers and his deluxe orchestra; Jack Little; 10:30, "A Step on the Stairs," mystery serial.

WOK, Chicago, Ill. (217.3m-1300kc), 4:30-7 p. m., Capitol theater organ; studio program; 10-11:30 a. m., Tearney's Town club orchestra; Carl Lorraine's Pershing Palace orchestra.

WOOD, Grand Rapids, Mich. (242m-1240kc), 9-11 p. m., classical concert; 11-12, Bill Dalava and his orchestra.

WORD, Batavia, Ill. (275.1m-1090kc), 7 p. m., program; 9-10, program.

WQJ, Chicago, Ill. (447.5m-670kc), 7-8 p. m., Ralph Williams and his orchestra; Henrietta Nolan, violinist; Otta Moore, baritone; 10-1 a. m., Ralph Williams and Rainbo Skylarks; H. Lucille Long, harmonica player; Johnny Post, Tell Taylor, tenors; Tomo Vincent, baritone; Clark's Hawaiian trio; artists; 1-2, Ginger hour.

WSB, Atlanta, Ga. (428.3m-700kc), 8 p. m., Barnsville Civilian club; 10:45, Nunnally's Miniature symphony orchestra.

WSM, Nashville, Texas (282.8m-1060kc), 6:30 p. m., Francis Craig's orchestra; 8, Easter program; 10, Vanderbilt university program.

Mountain Time Stations

KFVA, Ogden, Utah (260.7m-1150kc), 9-10 p. m., studio program; 10-11, Merry Mad Music Makers.

KFXF, Colorado Springs, Colo. (250m-1200kc), 12-3 p. m., Passion day services.

KOA, Denver, Colo. (322.4m-930kc), 6:30 p. m., Brown Palace string orchestra; 8, St. John's Episcopal cathedral.

KOB, State College, N. M. (348.6m-860kc), 7:30-8:30 p. m., Mrs. L. A. Broadus, director.

Pacific Time Stations

KFI, Los Angeles, Calif. (467m-642kc), 5:30-6 p. m., program, Undersheriff Biscailuz; 7-8, Aeolian organ, Dan L. McFarland; 8-9:30, Good Friday program, Steiner's Crucifixion, Beverly Hills Community church choir; 9:30-10, Mutual Motors mirth contest; Sun-hunt Jim, entertainer; 10-11, Packard Ballad hour with favorite entertainers.

KFON, Long Beach, Calif. (232.4m-1280kc), 6-6:30 p. m., Brayton's theater organ; 7-8, program, Dalton & Hoagland; 8-9, Press-Telegram studio; 9-11, Long Beach Elks Lodge, No. 888, frolic.

KFWB, Hollywood, Calif. (252m-1190kc), 8-9, John Wright orchestra, Raquel Nieto, coloratura soprano, Bill Blake, tenor; 9-10, Len Nash and his Country Boys dance orchestra; 10-11, Warner Brothers frolic.

KGQ, Oakland, Calif. (361.2m-830kc), 6-6:55 p. m., dinner concert.

KGW, Portland, Ore. (491.5m-610kc), 6-7 p. m., concert; 8-9, concert; 9-10:30, Sherman, Clay and company; 10:30-12, Hoot Owls.

KHJ, Los Angeles, Calif. (405.2m-740kc), 8-10, program, Western Auto Supply company.

KJR, Seattle, Wash. (384.4m-780kc), 7-8:30 p. m., Lundquist-Lilly male quartet; 8:30-10, studio program.

KMTF, Hollywood, Calif. (236m-1200kc), 8-10 p. m., KMTF concert orchestra; 10-11, Starr Piano company studio.

KNX, Hollywood, Calif. (336.9m-890kc), 5:30 p. m., Leighton's cafeteria orchestra; 6:30-7, Atwater Kent concert orchestra; 7-8, program, Jell-X-Cell company; 8-9, program, John A. Vaughn corporation; 9-10, Order of Optimistic Donuts; 10-11, fights, Hollywood American Legion stadium; 11-12, Ray West's Cooanut Grove dance orchestra from the Ambassador.

KPO, San Francisco, Calif. (428.3m-1000kc), 6:30-7 p. m., States Restaurant orchestra; 8-9, studio program; 9-10, Palace hotel dance orchestra; 10-11, States Restaurant orchestra; 11-12, Henry Halstead's orchestra.

KTAB, Oakland, Calif. (239.9m-1250kc), 8-10 p. m., program, Breuner's.

KWSC, Pullman, Wash. (348.6m-860kc), 7:30-9 p. m., St. John choir.

Wherever There Are Ears to Hear—

There's a Tower Speaker or Headset to fit every taste, every pocketbook.

The Meistersinger Speakers, the Scientific Speaker and the famous Tower Phonograph Attachment are equipped with the wonderful new double diaphragm—the greatest single contribution to sound reproduction since Bell invented the telephone receiver. These Tower Units re-create all the instruments of the orchestra—as well as choral singing and the spoken word—in their original, living vividness with full resonance, color and shading. Before you buy—Hear a Tower Speaker.

On Sale by Good Dealers From Coast to Coast

TOWER MFG. CORP.
BOSTON, MASS.

Only Tower Products are equipped with this new Diaphragm

Scientific \$8.50

Meistersinger \$15.99

Little Spitfire \$4.95

Phonograph Attachment \$3.95

World's GREATEST SPEAKER

NEWS BULLETINS

Daily Except Sunday

Eastern 9:45 a. m.	Central 9:45 a. m.	Mountain 7:45 a. m.	Pacific 6:45 a. m.
KDKA (309.1m-970kc).	10	8	7
WGN (302.8m-990kc).	10:35	8:35	7:35
WCCO (416.4m-720kc).	11	9	8
WOAI (394.5m-760kc).	12 n.	10	9
CFCA (356.9m-840kc); KPRC (296.9m-1010kc).	12:30 p. m.	10:30	9:30
WCAE (461.3m-650kc).	1	11	10
KGW (491.5m-610kc); KNX (336.9m-890kc).	1:15	12:15 p. m.	11:15
WOAI (394.5m-760kc).	3:45	2:45	1:45 p. m.
WHAS (399.8m-750kc).	4	3	2
WCX (516.9m-580kc).	4:30	3:30	2:30
WCAE (461.3m-650kc); WFAA (475.9m-630kc).	5	4	3
CFCA (356.9m-840kc).	6:30	5:30	4:30
WPG (299.8m-1000kc).	7	6	5
KOIL (278m-1090kc); WOC (483.6m-620kc).	7:15	6:15	5:15
WMAK (265.6m-1130kc); WOAI (394.5m-760kc).	8	7	6
WMBF (384.4m-780kc); WVCA (340.7m-880kc).	9	8	7
WSAI (325.9m-920kc).	9:30	8:30	7:30
KPO (428.3m-700kc).	10	9	8
KLX (508.2m-590kc).	10:45	9:45	8:45
WEBB (370.2m-810kc).			

Sunday

Eastern 8 p. m.	Central 7 p. m.	Mountain 6 p. m.	Pacific 5 p. m.
WMAK (265.6m-1130kc).	8:15	7:15	6:15
WEBB (370.2m-810kc).	9	8	7
WPG (299.8m-1000kc).	12	11	10
KFWB (252m-1190kc).			

KYW, "The World Crier," broadcasts news every half hour from 8 a. m. to 2 a. m.

AUSTRIAN INVENTS RADIO CALL PHONE

New System Is Reported to Need No Exchange and Permits Private Conversation

VIENNA, Austria.—A new Radio telephone system is reported to have been invented by Emil Marek, an engineer of Moedling, near here, which is described as sensational because it permits Radio telephoning without interference from the outside.

The probability that an outsider will hear is said to be one in 1,000,000. The new system needs no exchange, as all subscribers to the system have sending and receiving apparatus. The person calling the number, dials similarly to that used at the present time.

Since the number corresponds to a certain wave length, the person with the receiver on this wave answers the call. A light on the receiver lights up when the number is called. If the party called does not answer, the receiver automatically registers the calling party's number.

It is said that the transmitter is no larger than an ordinary telephone, and has a range that covers the whole of Austria. Experiments on a large scale will be started shortly.

"Patsy" Is Broadcast Direct From Theater by KFWB

LOS ANGELES.—The first attempt to broadcast a play direct from the stage on the Pacific coast, with the exception of operatic performances, was recently handled by the Warner Brothers station, KFWB, operating in conjunction with the Warner mobile transmitter 6XBR, when one act of the western premiere of the musical comedy "Patsy" was microphoned for the benefit of listeners within range of KFWB.

Reports of the performance came in from all parts of the United States, many writing in that they were able to pick up 6XBR on 108 meters where KFWB itself was inaudible.

Has Air Music Contest

PARIS, France.—The Paris daily "Echo de Paris" is conducting a prize musical competition in connection with Radio broadcasting. So far there are over 600 entries, of which 410 are in the singing group, 63 for violin, 97 for piano and the rest for wind instruments or cello. Of the singers, 313 are women and 97 men.

After the pick of the contestants has been chosen by a series of elimination trials, the performances of the winners will be broadcast in a number of special concerts.

"S-O-S" GIVES THRILLS

(Continued from page 5)

and stated that he was going to take the matter up with the department of commerce. It so happens that this station in question is unfortunate enough to have an 'F' and a 'Y' in its code call."

That's realism with a vengeance. Study the faces of these Portal Players. One of these days you may be proud that you "Knew some of them when." Many famous stage celebrities have come from the Twin Cities and their vicinity.

Only ten, or maybe it was eleven years ago, I sat with Captain Fred Place of the Minneapolis Journal and Charlie Branham of the St. Paul Pioneer-Press at a table in the cafe of the Nicollet hotel where this WCCO studio is now located. While we dined a big eyed little girl, fairly bubbling with the joy of life and living skipped out on the slightly raised platform and sang "Little Gray Home in the West." The patrons stormed her with applause.

A little later I saw this girl singing at a picture theater over on Hennepin avenue. I was entranced and being interested in a motion picture enterprise, I sought an introduction and arranged to have this little charmer do some work for the pictures. She sailed out over the Mississippi in a swaying work bucket attached to a cable and was lowered to a seething, boiling mass of logs going through the foundations of the dam then under construction between the two cities. After that I had her spin around the Speedway as a mechanic for Ralph DePalma. Other thrilling stunts followed and she performed for the pictures with the same charm as she appeared before her audiences.

It happened that Al Jolson came through shortly after and the little girl with the big blue eyes joined his troupe. The next year when I happened to be in New York I saw one name standing out in the bright lights more brilliantly than all the rest. It was "Edith Day" in "Going Up." Edith Day was the little girl whom I had first heard sing "Little Gray Home in the West" there in the cafe of the Nicollet hotel where the Portal Players are now presenting "A Step on the Stairs."

Watch these Portal Players. Watch the news about WCCO and listen in when the players are on the air.

Light and Power for Twenty Years

No doubt you remember the first automobile you ever saw. Perhaps you'll remember, too, that it bore a shiny little tank marked "Prest-O-Lite" . . . for Prest-O-Lite gave the motor-car its first dependable eyes.

This same company, which has served the automotive industry so successfully for more than twenty years, today serves radio with a dependable, long-lived battery, of special design, that brings out the best in any set.

In engineering, materials and workmanship, Prest-O-Lite cannot be excelled. You can rest assured that Prest-O-Lite Batteries are cor-



rectly rated and deliver full power at all times. They are attractively priced from \$4.75 up. There is a Prest-O-Lite radio dealer or service station near you.

THE PREST-O-LITE CO., INC.
INDIANAPOLIS, IND.
New York San Francisco
In Canada: Prest-O-Lite Company of Canada, Ltd.
Toronto, Ontario

Send for this free booklet

"What every owner of a radio should know about storage batteries" is a little booklet which every radio fan will find interesting and helpful. It is crammed full of hints that will bring surprising radio results—and save you money. It's yours for the asking—without obligation.

Designed especially for radio

Prest-O-Lite
STORAGE BATTERIES FOR
MOTOR-CARS AND RADIO



Senator Walsh Asks Senate Probe of "Wired Wireless"

WASHINGTON, D. C.—The question of "wired wireless" has broken out in the United States senate.

Senator Walsh of Montana introduced a resolution which was passed by the senate and which calls upon the secretary of commerce "if not incompatible with the public interest, to report fully to the senate the circumstances attending the discovery of the method of multiplex telegraphy and telephony, the extent to which this system is now used by the American Telephone and Telegraph company, in furnishing communication to the government and to the public and the value of such use annually to the said American Telephone and Telegraph company, and what reduction in rates, if any, has resulted from the free use of 'wired wireless' by the said American Telephone and Telegraph company."

This system was invented by General George M. Squier while he was in the signal corps of the army. Under government rules the patents were made free to everyone.

Radio Car for League of Nations

GENEVA, Switzerland.—Under construction for the League of Nations is a Radio-equipped Pullman car of latest design, to be run with the express trains of Europe or as a "special" in the event of emergency. This car will carry representatives of the league to war-threatened or disease-stricken borders.

The league is hopeful of receiving messages direct from their representatives through the transmitting apparatus on the car and to send orders, suggestions and news to be handled through its receiving equipment.

KIWANIAN IS JAILED ON FAKE BROADCAST

EAST CHICAGO.—One half of East Chicago became enraged while the other half rocked with laughter. And all because Lester Ottenheimer, program chairman of the Kiwanis club struck upon a novel idea and as a result spent two hours in jail.

Ottenheimer announced that he had arranged with Station WGN to broadcast free advertising at a big Kiwanis booster meeting. The president of the club informed the meeting that two million fans were hearing the addresses and the secretary of the chamber of commerce and the mayor orated on the town's greatness for the greater part of an hour.

Then somebody discovered that the microphone had not been connected. The mayor ordered the police to throw Ottenheimer in jail where he lodged his attorney announced there was a ordinance about . . . It is said . . .

AN EVENING AT HOME WITH THE LISTENER IN CENTRAL TIME

Table listing radio stations by location and time slots (Saturday, Sunday, Monday, Tuesday, Wednesday, Thursday, Friday).

Table listing radio stations by call letters and location, with columns for Saturday, Sunday, Monday, Tuesday, Wednesday, Thursday, Friday.

STATIONS IN ORDER OF WAVE LENGTHS

Table listing radio stations in order of wave lengths, with columns for Meters, Call, Meters, Call, Meters, Call, Meters, Call, Meters, Call.

TELLS SALAD SECRETS

(Continued from page 6) salads that we need never be without them.

I will suggest a number of combinations that are possible at this time of the year. Cabbage, probably our cheapest salad food, lends itself to many delicious salad combinations.

Many Pleasing Combinations

A nourishing salad is made by stuffing prunes with cottage cheese or with American cheese grated and mixed with salad dressing.

Tasty Fruit Salads

The apple, celery, and nut combination is probably one of the most convenient and popular of fruit salads.

have tried the orange and onion combination that sounds so queer and yet is so well liked? The large white Spanish onions are best for this salad, as they are more mild in flavor than the small ones.

No doubt many of these combinations are old to you. I have not endeavored to give you anything new or startling because I have learned that what is old in one part of the country is new in another and vice versa.

SHORT WAVES

By Marcella

(Continued from page 6)

Betty Lou wants to know all about Mac Ohman. I think she means Phil Ohman, the piano wizard. If she does, here is all the scandal that I could find out about him.

Isabel and Florence missed my lines about Pat Barnes of WHT and are deeply put out. Far be it from me to keep secrets about this handsome announcer, and inasmuch as his life story was told several months back, I guess I can safely repeat and elaborate a little.

Jerry Sullivan, WQJ's Chi-CAW-goer, is married, yes. But I can recommend Eugene F. McDonald, Jr., WJAZ's fighting owner, as a most eligible bachelor.

What deep secret would you know about your town? Drop me a note and I'll do my best to tell.

Radio Digest Illustrated

Reg. U. S. Pat. Off. & Dom. of Canada

Published by the
RADIO DIGEST PUBLISHING CO.,
(Incorporated)

510 North Dearborn Street
Chicago, Illinois
Telephones: Superior 7323, 7324, 7325, 7326, 7327

E. C. RAYNER, Publisher

Eastern Office, Park-Lexington Building, 247 Park Ave.,
New York. Telephones: Ashland, 8144, 8145, 8146

Member of the Audit Bureau of Circulations



241
PUBLISHED WEEKLY

SUBSCRIPTION RATES

Yearly in U. S. and Possessions and Canada, \$5.00
Foreign postage, \$1.00 additional. Single copies, 10 cents.

Vol. XVI Saturday, March 27, 1926 No. 12

Who Will Be 1926 Microphone King?

THE third annual Radio Digest Gold Cup Award begins. Fans of a nation will pick their favorite announcer anew. George Dewey Hay won the first cup in 1924. Graham McNamee won the second solid gold trophy in 1925. Who will be the favored "voice" this year?

Announcing standards and personality expressed through the loud speaker are again up for inspection. "Straight" versus "Character" announcers again have their tilt. Which kind of announcer will top the list at the end of the 1926 contest?

Last year over a million ballots registered the listeners' choice for favorite master of ceremonies. The winner, Mr. McNamee, received nearly 200,000 of these. The interest has been growing from year to year in this great effort of Radio Digest to improve announcing objectives and reward the best in the world.

Queer Thing This Radio

IT WAS recently reported in the newspapers that a woman had made a complaint to a broadcasting station that she heard its music when she was walking along the street. At a certain point on this street she heard it. So she wanted the station to quit broadcasting before she lost her mind.

Upon investigating, the officials found that a youth had rigged a loud speaker extension in one of the trees near the spot where the lady heard music. So the mysterious phenomenon was explained.

As Shakespeare said, "There's Music in the Air." This and other queer incidents reported often leads erroneously to the impression that there is something psychic about Radio. However, when a good technical man gets busy on the case and investigates carefully, he usually finds that the incident, while unusual, is supported entirely upon the scientific laws Radio has always been known to follow.

Speaking of queer tricks of Radio, two readers built short wave receivers. One found that he heard the voice of his friend in his headset. He talked back to his friend through his headset. The friend heard him and replied that all he was doing was talking toward his short wave receiver's panel, and that the panel seemed to pick up the voice. The two were mystified and sought advice from this publication.

It was explained easily. Certain circuits act either as transmitters or receivers. The voice can be sent out by talking into one's headset. As for the reader who talked at his panel, it developed that he had a microphonic detector tube, and as he talked at the panel, his voice vibrations were transmitted directly to the elements of the detector tube, which in turn modulated the wave from his set and sent his voice out on the air.

All according to basic Radio principles it was, yet the two neighbors were puzzled. And why not? Better be careful what you say hereafter in front of your radiating receiver.

Another reader reports that he can hear talk and everything going on around a gas engine nine miles away from his Radio set, provided the gas engine is running. He wants the answer. It hasn't been explained yet, but no doubt will prove to be very simple, and in accordance with understood principles.

The latest phenomenon occurred in a store at Columbus, Ohio, when an electric phonograph of a recently introduced type began to give the market and weather reports, and then finished off with the noon musical program from a broadcasting station a mile away. The storekeeper was amazed and non-pulsed. He sought technical advice.

The technician reported that the phonograph was equipped with a Radio amplifier which electrically reproduced and amplified the sounds registered on the records. The amplifier had been turned on and this acted as an ordinary Radio receiver.

Radio is extraordinary, we grant, but not enough so to make such incidents unexplainable. It is peculiarly human that people should be surprised or startled by a result. However, be skeptical of what you hear, for they grow less mysterious with repetition.

RADIO INDI-GEST

Memories

Oh, how I remember the first Radio we had, Although 'twas only a crystal set, it made us very glad.

It wasn't much for looks or anything like that, With a bunch of funny wires and the music always flat. Compared to sets today, one would classify it "junk." And the programs we received would be considered pretty "punk."

But we got an awful kick out of galloping around, And how we'd strain our ears to hear the faintest little sound.

And we never became tired or thought of going to bed, We'd just sit there and listen with the phones glued to our head.

Those were the good-old, happy days, when everything was new.

Do we remember those old days?—You bet your life we do.

Hurray! Hurray! Bobette is back. And who don't remember when all the accessories that were needed were bed springs for an aerial and a radiator for a ground? And nobody kicked because they heard sopranos and a little static was no more than the stones in cherry pie.

Says Davenport, "Lend Me Your Ears"

WOC, Davenport, has a listener in who has the unusual gift of being able to click his ears as loud as the ticking of a watch. He has offered to do his stuff before their mike. So far, the program has been held up, awaiting the decision of whether it should be termed a duet or a solo.

OLIN RECORDER

Why not use the boy on code? Have the right ear for dots and the left one for dashes. Iowa, famous for its ears of yellow corn and their corn-fed population—may attribute these ears to pop corn.

Broadcast "Fable of the Chimes"

Did you tune in March 17 on WOC when they broadcast "Fable of the Chimes" which headed the Indi-Gest column last week? The poem by Charles Allen Branham was given at the conclusion of the Davenport station's chimes concert.

Signify by Saying "Aye"

Adam made the famous Fans club by a wide margin. He was found to possess a dozen qualifications.

Accept Napoleon, because in his attempt to "by-pass" the Alps he was met with "resistance" which caused him to "switch" his "batteries" to "choke" the enemy "charge." He then established a new "station" with new "lines," by which he was able to "detect" the enemy and cause them to lose "ground."

FRANQUE

Franz Gruber, because he composed "Silent Night." The fact that he added "Holy Night" shows just how clever he was.

IMA BLOOP

Don't Longfellow come in for consideration for starting bedtime stories with his "Listen my Children and you shall hear?"

JONATHAN JAY

Radio Rhymes

Every Easter! Every Easter!
Must I always hear—
"Needa new hat—wanta new hat—
Will you? Won't you?—Dear?"

Every Easter! Every Easter!
All the cash I've made
Goes for this hat—or for that hat—
For the Church Parade!

Not this Easter! Not this Easter!
—I'll not spend my dough!
She can go to church bareheaded
On the Radio!

CHARLES ALLEN BRANHAM

Try and Put It in a Jingle

Listen to this from KFL. It is one of the reasons why speakers are loud.

"Martha Van Hoomissen-Chevallier will play 'Die Tod und die Verklerung,' by Strauss, and accompany the 'Versonkene Glocke,' by Gretchaninoff, sung by Antoinette Konorocharakoff."

Moral: Fight on Silent Night

Somebody is wrong. Great statesmen have predicted that Radio will bring about world peace. How the heck can it when it won't even do it in a home. Man in Columbus, Ohio, was lodged in the city prison for giving his wife a black eye after she took two tubes out of their set and broke them because he wouldn't take her out one night, preferring to listen in.

Not a Miracle Play

Dear Indi: From the kind of guys these Turner birds seem to have been, I don't think this Peleg bozo will be able to talk from the dead to the persons gathered in the hunt-room for the reason that there aint no fire clay receivers with asbestos coils.

SHOBIE

Depends Upon the Brand Listen and Learn How to Smoke Meat is Latest

—WCCO News Bulletin

Let's try it, friends. We will start out with Bull Durham in the first lesson. Then a few puffs of Camels and Wild Boars will get us away from vegetarian nicotine. Maybe in the next series we may learn how to chew Brown's Mule.

INDI

Not So Blind She Can't Win



Condensed

BY DIELECTRIC

The Cincinnati Conservatory of Music has contributed to the programs of WLW, the Crosley station in that city, some features of genuine merit which Radio listeners realize and appreciate. Arthur Brecht, solo cellist with the Cincinnati symphony orchestra, was another addition to high-class musical offerings, indeed, rivaling in tonal beauty and technical proficiency those recognized as world leaders of the instrument. The sonata form of musical composition has phases of interest to which music lovers are ardently drawn.

In making some orchestrations, the brass smother the strings so as to leave an unbalanced effect, which is not the fault of the orchestra leader but of the arrangement before the mike. Again, a choir of the orchestra is intended to stand out from the rest, as in picking up a theme for its development. This latter case applied to a portion of an orchestra concert put on the air from the studio of Station WOAW, Omaha, when the clarinets beautifully played their part with accompaniment by the other choirs. It was very well done.

A real treat is in store for the music lover who tunes in on WGN, Sunday evenings at 9:15 Central time. This station has inaugurated a novel feature in their Music Room. The announcer graphically describes the den of an old-fashioned music lover; in one corner is an old square piano, sweet-toned violins adorn the walls and the tables are covered with manuscripts yellow with age. The music master talks and calls the ghost of old-time composers. Each week a different composer's work is heard.

If organ recitals mean anything to you, I would suggest tuning to WEAR, Cleveland, and sampling some of their concerts. Especially commendable was a concert given there recently by Vincent Percy and a group of soloists happily selected for the program. We have on occasion listened to organ recitals where the performer failed to make use of the subtle combinations of stops to produce effects impossible with any other musical instrument, yet no such detraction occurred while Mr. Percy entertained. His work was modestly performed with pleasing result.

The Gold Medal Station, WCCO, Minneapolis-St. Paul, is no slouch when it comes to dance programs and if you doubt that, just try them while the Golden Pheasant dance orchestra is on the air. You may prefer numbers not appearing on their programs, but few will be disappointed with the rendition of such as do appear there. Maintenance of rhythm and spirited playing are noteworthy attributes and what more do lovers of dance music demand? Try them out.

The Atwater Kent concerts have produced some remarkably fine musical talent, in fact, many of the foremost artists in the world have, or will, appear before the mike in the studio of Station WEA, New York. To find what stations are linked in the chain of broadcasters turn to the advance program pages. I shall review two concerts in this paragraph. When the London String Quartet played, their program was notably lacking in contrast, which may be set down as due to unfamiliarity with Radio broadcasting. Comparisons may be out of place, but I make bold to state that the exquisite nuances and virile attack so characteristic in the playing of the Flonzaley Quartet was lacking to a marked degree. Again, we had the good fortune to hear Josef Hofmann, master pianist, in familiar works. A great night.

1926 Model Four-Filter Super-Heterodyne

Part III—Assembly and Wiring

By the Technical Editor

IN LAST week's article, the work was taken through the alteration and drilling stages ready for assembly. The front panel assembly should cause no one any particular trouble so far as the condensers, brackets and switch are concerned. The right condenser mounts tight up against the brass shield; the brass was cut away sufficiently for the left condenser that the mounting pillars could be tight against the panel yet not touch the brass. For use in mounting the potentiometer, cut a cardboard disk the same diameter as the base of the potentiometer and cut small holes in it to pass the three mounting screws and the shaft. This unit is then mounted with the cardboard between the bakelite base and the brass shield; the cardboard is used only to be sure the lock washer around the shaft does not touch the shield.

Sub Base Assembly

The assembly holes in the sub base may need a little explanation. In the rear left corner will be found a hole $1\frac{1}{2}$ inches from the left edge and $1\frac{13}{16}$ inches from the rear edge. To the right of it $2\frac{1}{4}$ inches is another hole. These are for the pins on which the Cruver coil is mounted. In front of these, and to the right of the Bradleyeak, are two more holes $2\frac{1}{2}$ inches from front edge of sub base and 2 inches apart. These take the Benjamin socket for the first detector, mounted with P and F terminals to the rear. Proceeding further to the right and $\frac{3}{8}$ inch from the front edge will be found four pairs of holes 1 inch apart for four more sockets and each is mounted with P and F terminals to the front. This brings us to the third pair of bracket holes. Just to the right of them and only $\frac{1}{4}$ inch from the front edge, are two holes $1\frac{15}{16}$ inches apart for the oscillator tube socket, mounted with P and F to the front and with more than half the base hanging over the front edge. This will be clear from figure 5. The small hole a little further to right and $\frac{7}{8}$ inch from front edge takes the small right angle bracket used to sup-

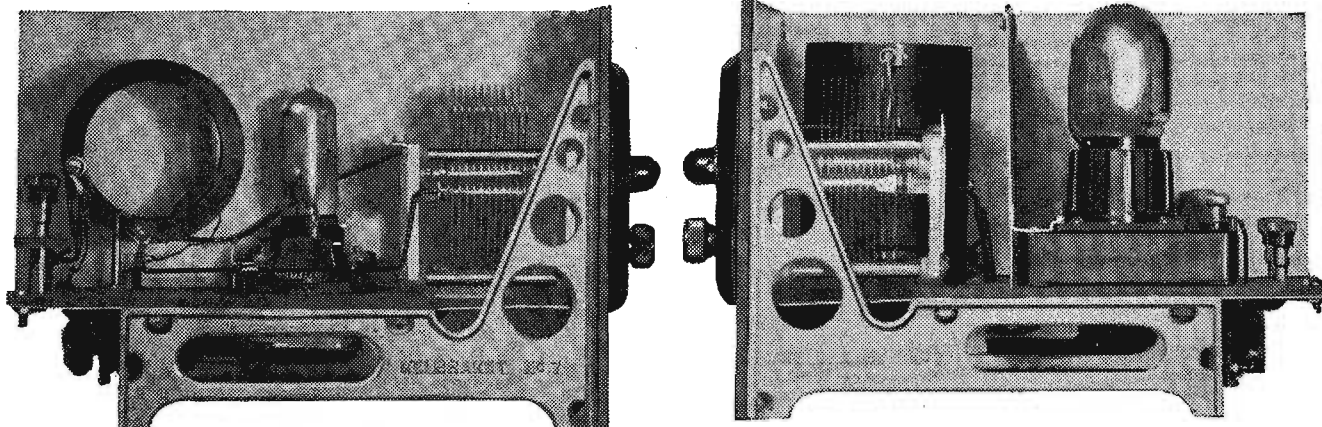

Figure 7

port the oscillator coupler so that it also hangs over the brass beyond front edge of the sub base.

right angle brackets. Two holes are needed to support the Daven unit in place. $1\frac{1}{4}$ inches from the rear edge and just

Binding posts are placed in the two holes behind this Daven unit and $1\frac{1}{16}$ inch from rear edge of sub base. The Bradley-

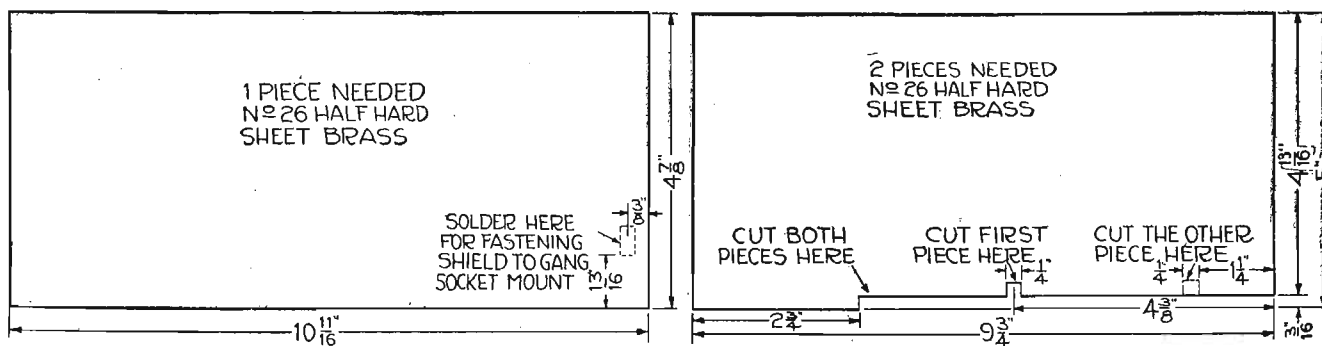

Figure 8

The two small holes near the center lengthwise, $9\frac{3}{8}$ inches apart and $\frac{1}{8}$ inch from rear edge hold the Master Long Wave Intermediate Unit with two small

leaks are put in, in both cases, with terminals to the right. Secure the assembled sub base to the brackets, which have

(Continued on page 20)



Test Your Tubes at Home

“It is Easy”—
If you have a Jewell Jr. Tube Checker.

One poor tube in a set may be the cause of all of your radio trouble.

Owners of New Radiola, Victor and Brunswick sets should have a Jewell Pin-Jack Voltmeter

JEWELL ELECTRICAL INSTRUMENT CO.

1650 Walnut St., Chicago

“26 Years Making Good Instruments”

The Last word in audio amplification

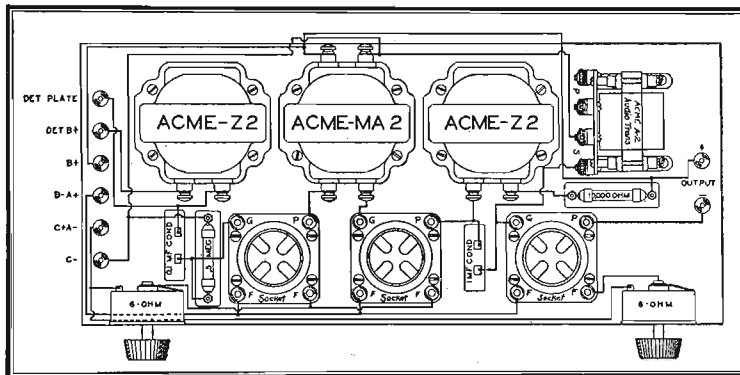

Impedance ••• Transformer ••• Impedance

THE diagram above will give you some idea of the very latest step in audio amplification. This is the outgrowth of nearly 7 years of experience in working on proper amplification—the problem of “How well you can hear.”

Acme research work has been confined to audio amplification and reproduction, and here you find the latest result. An audio amplifier using the combination of impedance and transformer coupling with over-all amplification greater than two transformers, and far superior in quality, no matter what the type of transformer used. Whatever set you have, just add this amplifier to your detector and notice the difference.

A complete working diagram of the above chart will be sent you for 25c. It is easier to follow than the plainest road map. With this chart we shall be glad to send you free a copy of “Amplification Without Distortion,” a famous radio book over 300,000 radio fans have found helpful. It tells the whole story of distortion and how it can be overcome. Use coupon below for convenience. Acme Apparatus Company, pioneer radio and transformer engineers and manufacturers, Cambridge, Mass., U. S. A.



Acme MA-2 Transformer, price \$5

ACME

~for amplification

ACME APPARATUS CO., Dept. N14, Cambridge, Mass.
Enclosed find 25c. Send me diagram and “Amplification Without Distortion.”

Name _____
Street _____
City _____

FOUR-FILTER SUPER

(Continued from page 19)

previously been attached to the front panel. Then add the Amperite strip to the back surfaces of the two central brackets and solder the bypass condensers in the positions shown in the photographs, figures 5 and 6.

The wiring of this set begins with the negative filament connections. Using a piece of heavy rubber covered wire, connect the minus A post on the Daven unit, through the sub base and forward to one of the filament switch terminals. The other switch terminal connects, with a 1-inch piece of wire, to the front panel

plus A binding post, the connections to all tubes, from the plus A of a storage battery, are completed.

Binding Post Strip

For the antenna and ground binding posts, a small piece of 3/8-inch bakelite is needed, 1 inch wide and 3 3/4 inches long. A hole is bored in this 1/2 inch in from each end; 7/8 inch in from each of these holes bore another. These two holes 1 inch apart are for the antenna and ground binding posts while the outer two are for long 6-32 machine screws which go down through 3/4-inch pillars and the sub base and are secured beneath the sub base with hex nuts. This supports the binding posts up away from the sub base

base. Speaking now of the lower row of posts on the Master unit, connect the second post to the rear left terminal on socket 2 and the third to the front right terminal on that same socket. The fourth goes to the rear left terminal of socket 3 and the fifth to that socket's front right terminal. The sixth Master post goes to the rear left terminal of socket 4 and the seventh to that socket's front right terminal. From the eighth post, a heavily insulated wire goes down through the 1/4-inch hole provided and forward to the front terminal on the second Bradleyleak. The rear terminal of this leak connects up through another 1/4-inch hole, provided, to the rear right terminal of socket 5. Connect another Hilco .00025 mfd. condenser across the second Bradleyleak.

Grid and Plate Returns

Going now to the upper row on the Master unit, connect the first post with a long piece of the heavily insulated wire,

of the second Amperite from left: From the right post on the potentiometer drop a wire to the front soldering lug on the 1 mfd. Tobe condenser shown and solder both to the flat shield on which the condenser is placed. From the rear soldering lug on this condenser run a wire up to the center post on the potentiometer. From the eighth post in the upper row on the Master unit drop a wire to the rear right terminal of socket 5.

We now come to the oscillator unit. From the lower terminal of the plate coil on the oscillator coupler run a wire forward between coil and condenser, then to left to the front left terminal on socket 6. Now connect the upper terminal of the grid coil with a short wire to the left stator soldering lug of the variable condenser and continue this wire down and across in back of the coil to the rear right terminal of the socket. Now connect the lower end of the grid coil to the lug on the upper left corner of the rear end plate on the condenser (about 1 inch), and continue the wire forward and to left to the front right terminal on the socket. From the upper end of the plate coil, use a piece of heavily insulated wire and drop it down through the 1/4-inch hole provided and back to the right one of the two separate binding posts (plus 45). Where this comes through below sub base connect it to one terminal of a 1 mfd. condenser as shown in the photographs and connect the other terminal of this condenser to the flat shield.

Pick-Up Coil

Two terminals remain on the oscillator coil which are from the pick-up coil or rotor. From each of these drop a piece of heavily insulated wire down through sub base and across to left to the 1/4-inch holes provided just below the right bakelite ring on the Cruver coil. Bring them up through these holes and connect one to each of the terminals provided from our special two-turn winding put on the Cruver coil. These wires carry the energy from the oscillator circuit and impress it onto the first grid circuit.

Now to clean up a few odds and ends and we are through. A piece of the rubber covered wire is used from the front right terminal on socket 5 to go straight back and to P post at left end of the Daven unit. Connect the .002 mfd. Hilco condenser across the front left and front right terminals on socket 5. This is condenser C8 in the wiring diagram. From the B post (second from the left) on the

(Continued on page 22)

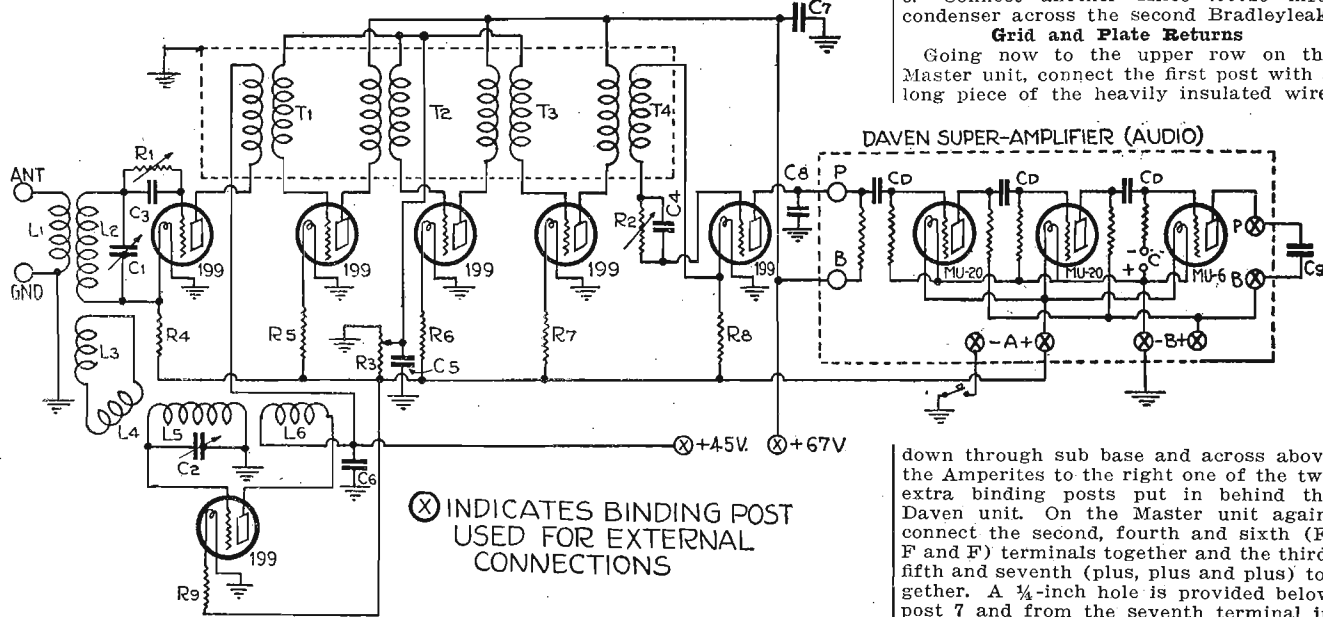

Figure 9

shield. Now connect the front right terminal of the first detector socket to the brass shield below sub base, at a point just in front of the front edge of the bakelite sub base. Similarly, connect the left front terminals of the three intermediate sockets and the second detector, also the front right terminal of the oscillator socket (No. 6). Now drop a piece of wire through sub base from the negative B post on the Daven unit and solder it to the brass shield below sub base. Thus, if the negative of a storage battery is connected to the negative A post on the Daven unit (remember, it was altered) and the switch is closed, connection is made through the shielding to each tube.

Now slip a soldering lug under the positive A post on the Daven unit and to it solder a piece of heavy rubber covered wire which goes down through sub base to the nearest Amperite unit. A piece of ordinary bus bar can then connect the lower right ends of all six Amperites. Now connect the upper end of the left Amperite, with a piece of the heavy rubber covered wire, to the rear left terminal of the first detector socket at left end of set. Call that socket number 1 and the 199 sockets from left to right as 2, 3, 4, 5 and 6. Connect the second Amperite from left to socket 2 at the rear right terminal, the same with Amperite 3 and socket 3, Amperite 4 and socket 4, Amperite 5 and socket 5 (second detector) and connect the upper end of Amperite 6 to the rear left terminal of socket 6 (oscillator). Since the proper terminals in the Daven unit are already connected to the

and its shield. With ordinary bus bar connect the left binding post to that end of the primary whose terminal is in the left coil ring and the right binding post to that end of the primary with its terminal in the right ring. Another short piece can connect this right terminal to the right coil support thus connecting it to the shield.

Now connect the left secondary terminal of the coil, forward to the left soldering lug on the stator of the left condenser, bending the wire down so it is but 1/4 inch above sub base. It will thus pass over the 1/4-inch hole bored just to left of the Bradleyleak. With a piece of the heavy rubber covered wire connect this last wire, down through the sub base to the rear terminal of the Bradleyleak. With another piece of the heavily insulated wire connect the front terminal of the Bradleyleak to the left front corner terminal of socket 1. Connect one of the .00025 mfd. Hilco fixed condensers across the terminals of the Bradleyleak as shown in the photos. There are two soldering lugs on the rear end plate of the X laboratory condenser, so run a wire from that in the upper right corner down to the right end terminal of the secondary of the coil. From the rear left corner terminal of socket 1 run a wire straight to the right and solder to this last wire put in. This completes the input circuits.

A short piece of the heavily insulated wire is used to connect the rear right terminal of socket 1 across to the first lower row (P) post on the Master unit, bending this wire down against the sub

down through sub base and across above the Amperites to the right one of the two extra binding posts put in behind the Daven unit. On the Master unit again, connect the second, fourth and sixth (F, F and F) terminals together and the third, fifth and seventh (plus, plus and plus) together. A 1/4-inch hole is provided below post 7 and from the seventh terminal in the upper row drop a heavily insulated wire through sub base and back to the left one of the two separate binding posts back of the Daven unit. Where this wire comes out below sub base, connect a wire to it and across to left to the right terminal of the 1 mfd. Tobe condenser placed to left of the second Bradleyleak. The left terminal of this condenser is soldered to the brass shield placed under the sub base. From the left post on the potentiometer drop a heavily insulated wire through sub base and back to the lower terminal



Steinite Low Loss Interference Eliminator

No Radio Set Complete Without It

Select stations at will. With music and voices crowding the air the average set fails to bring in the desired stations properly. The **Steinite Interference Eliminator** shuts out local and other interference. You get one station at a time, the one you want, and tune in loud and clear. Operates on any set—attach to aerial wire and to set—no changes—no extra tubes or batteries. Greatest Dollar Value in Radio Today.

Fred W. Stein. OVER 300,000 SOLD

Improved Results With Tube or Crystal Try entirely at my risk the wonderful improvement this inexpensive little device will make in the reception of your set. Improves results on both crystal and tube sets that use any kind of aerial except loop antenna. Clears up reception wonderfully, increases volume, and partially absorbs static. **MONEY-BACK GUARANTEE.**

Mrs. Famous 1,500 Mi. Steinite 1-Tube Set, \$6; Long Distance Crystal Set, \$6; Steinite Crystal 50¢—3 for \$1

STEINITE 5-Tube Set—\$29.75

FREE Descriptive Literature on request.

Put this interference eliminator on your set and note amazing improvement. No tools needed—install in a moments time. Connect with set and follow simple instructions. Money back promptly if not delighted. \$1.00 in U.S. when cash with order.

\$1 Postpaid If you are not delighted with results you get your dollar back

SALES FACTORIES, 161 Radio Bldg., ATCHISON, KANSAS

"The Better Condenser"



THOUSANDS will build or buy B-Eliminators this spring and summer.

The public is just beginning to realize the wonderful advantages of them.

If you build a B-Eliminator, make sure that you use TOBE Condensers in it. THE TOBE B BLOCK combines in a single unit all of the filter condensers required, sells at \$11.00, and saves you \$2.50 over the cost of separate condensers. It saves much space and wiring labor. Dimensions are 4 in. x 2 1/4 in. x 5 1/4 in. high.

If you buy a B-Eliminator, make sure that it uses the TOBE Condensers. Most of the good ones do.

And, in building your improved, resistance or impedance coupled audio amplifier and in by-passing the B Battery in your set for perfect reproduction without noise, use the TOBE Condensers.



At your dealers in the distinctive silvered case and silvered carton.

Tobe Deutschmann Co.

CORNHILL BOSTON, MASS.

How to Stop Blooming and Man-Made Static

Part VII—51 Types of Interference

By the Technical Staff

A GOOD Radio receiving set is one of the most sensitive instruments made by man. In the bureau of standards in Washington there are some of the most delicate mechanical and electrical devices in the world for measuring weights, lengths and electricity. The most sensitive of these devices, which are operated only by scientists with years of training, is hardly more sensitive than some Radio receivers. The real wonder of Radio broadcast reception is that it has been possible to make these ultra sensitive instruments so simple and convenient to use that persons with no scientific knowledge or training are able to get such wonderful results from them. A good Radio receiver will give understandable reception if the radio frequency voltage received on the antenna is only .0001 volt per foot. Is it surprising that your receiver picks up scores of disturbing noises?

Electrical Interferences

It is not yet possible to prevent static from interfering with Radio reception. Aside from static there are many causes of noises in your receiver. A large number of these are produced by electric devices of various kinds, some of which may be in good condition and operating as they are supposed to operate. It would be possible, of course, to do away with all these noises, but this would be at the expense of giving up all of our modern electrical conveniences, including electrical transportation, automobiles, motors and all household electrical devices. This, of course, is a price none of us would consider paying. Let us take a look at some of the sources of man-made interference, for which list we are indebted to Mr. E. P. Peck of the Utica (N.Y.) Gas and Electric company.

In Receiver or Accessories:

1. Improperly tuned receiver
2. Loose connection in set or speaker cord
3. Defective grid leak
4. Shorting condenser plates
5. Defective fixed condenser
6. Discharged or weak batteries
7. Loose battery connections
8. Defective B battery eliminators
9. Socket trouble
10. Poor tubes

From Apparatus in Your or a Neighbor's Home:

11. Vacuum cleaners
12. Sewing machine motors
13. Violet ray machines
14. Ozonators
15. Door bells and buzzers
16. Switching of lamps, etc.
17. Thermostatic heating pads
18. Some types of oil burners
19. Certain washing machines
20. Vibrating battery chargers
21. Some electrolytic chargers
22. Elevator controllers
23. Bad contact in switch, fuse or socket
24. Set too close to lighting wires

From Outside Sources:

25. Defective transformers
26. Regenerative receivers
27. Sign flashers

28. Commercial code stations
29. Amateur code and phone stations
30. Induction coils
31. Electric street cars
32. Defective rail bonding
33. Heterodyning between stations
34. Overlapping of stations
35. Telephone ringers
36. Telephone and telegraph lines
37. Arc motion picture projectors
38. Motors of commutator type
39. Electric welding apparatus
40. Doctor's X-ray machines
41. Static machines
42. Static produced by belts
43. Manufacturing processes
44. High potential circuits
45. Arcing wires in trees
46. Leaking power line insulators
47. Defective power lighting arrestors
48. Street lamp loose in socket
49. Bad contact in switches

50. Smoke precipitators
 51. Defective street light rectifiers.
- Fairness to Power Company**
This does not cover all possible sources of trouble by a great deal. However, in this list, it is seen that there are ten possible kinds of trouble that can be caused by your own receiver or the apparatus connected to it. There are fourteen kinds of trouble that may occur in the
- (Continued on page 22)

Radiotone Loud Speaker

Now Only \$19.95

Was \$25.00

The BEST Radio Affords

\$1.00 down!



"A Wonder" says user:—

"The Loud Speaker is a wonder. I never heard anything like it. I put it to a little test a few nights ago and it was heard clear and loud nearly one-half mile from my place through an open window."

Burton W. Cooswell,
Brockton, Mass.

Makes Your Radio Complete

The Radiotone is the last word in sound reproduction and amplification for radio sets. It is super-sensitive. Brings in distant stations with full volume so every one in the room can hear distinctly and easily. Wonderful clearness and absolute purity of tone. No distortion. No crouching in front of the loud speaker to hear announcements.

The Radiotone has a 14-inch horn made of Thorite in one piece without seam or joint, acoustically correct. This eliminates the metallic clang you often hear in other loud speakers. The reproducing unit is entirely enclosed at the base of the horn. The well balanced construction does away with all vibrations. The Radiotone has a graceful shape with a beautiful black florduline finish. It stands 23 inches high and weighs only 15 lbs. No extra batteries needed for the Radiotone—just plug it in as you do your head set. Nothing to wear out or get out of order. Sent complete with cord and plug.

30 Days Trial!

When the Radiotone comes, there's nothing to pay. Use it freely at our risk, on trial for 30 days. See how much more use and fun, you and all the family get from your radio with this loud speaker. See how loud, clear and distinct the Radiotone brings in all stations—better than any other loud speaker you've ever heard, giving you the best that is in your set. After 30 days trial if you think you can get along without the Radiotone, return it to us and we will refund your dollar plus all transportation charges. No red tape. The trial costs you not a cent.

Straus & Schram, Dept. R-6413 Chicago, Ill.

Enclosed find \$1. Ship special advertised Radiotone Loud Speaker, I am to have 30 days free trial. If I keep the Radiotone, I will pay you \$3.00 monthly, total reduced price, \$19.95. The Radiotone is to become my property as soon as you receive the final payment. If not satisfied, I am to return it within 30 days and you are to refund my money and any express charges I paid.

Radiotone Loud Speaker No. Y8728A—\$19.95

My Name _____
(Head of the family must sign this order. If you are not of age, have your parent or guardian order for you.)

My Street Address _____
R.F.D. or Box No. _____

My Post Office _____ My State _____

My Shipping Point _____ I have lived in this Town _____ years

And before that I lived in _____ Town _____ State _____ for _____ years

Occupation is _____ Age _____ Married _____ or Single _____

Give names of merchants who know you personally _____

Name _____ Town _____ State _____

Name _____ Town _____ State _____

If you have ever bought goods on credit by mail, tell us from whom. If there is anything else you wish to tell us about yourself, write on a piece of paper and enclose it with this coupon. But the coupon alone, fully filled out, ought to do. That's all we want to know and we're ready to ship the goods at once. No formalities. No C.O.D. We trust rich and poor alike when they merely show us that they are honest.

\$3.00 a Month

But if you decide to keep the Radiotone, pay only \$3.00 a month until you have paid the special reduced price—only \$19.95. See if you can equal this offer anywhere on such amazingly liberal terms. You'll scarcely feel those small monthly payments. Surely, now, you can afford to have the Radiotone—the best loud speaker—and get the most fun out of your radio set for all the family.

Send Coupon NOW!

Seize this opportunity on this special offer. Only \$1.00 with the coupon brings the Radiotone on 30 days' trial, satisfaction guaranteed, your dollar refunded if not satisfied. Send the coupon now while this special offer lasts.

Straus & Schram
Dept. R-6413 Chicago, Ill.

Gets Everything But Noise!

Read this convincing letter from a man who has "listened and marveled":

"Atchinson, Kan. Jan. 14th, 1926
Dear Sir:
The Kane Antennae sure does the work. It has cut down local interference until you cannot notice it. Now I am in as bad a place as can be found for radio. So my trouble is over with interference. Showing you that I am more than satisfied, I want the same kind of a Kane Antennae with aerial and counterpoise for my home. I am using this one at the store."
CHAS. MILLER CIGAR STORE"

Improves Reception 60%

Entirely eliminates all power noises such as leaky transformers, generators, motor hums, Delco Plants, etc. Cuts static and regeneration howls and squeals in two. Dr. Gehrig of Oakland, Cal., says it improves his reception fully 60 percent. Do away forever with disagreeable noises.

\$1.00 Brings BLUE PRINT Complete Working Drawings

and full instructions for erecting this wonderful Antennae. Just send \$1.00 (a check will do. Stamps not accepted). A limited number available. Send TODAY.

KANE ANTENNAE CO.

Dept. 823C, 3034 W. Van Buren St., Chicago, Ill.
Dealers—Send at Once for Attractive Proposition.

KANE ANTENNAE

FOUR-FILTER SUPER

(Continued from page 20)

Daven unit, drop a wire through the sub base and to the left one of the two separate binding posts (plus 67). The Hilco .005 mfd. condenser is now connected to the OUTPUT binding posts on the Daven unit. An Eveready C battery is set upright against the front panel, resting on the flat shield and just to left of the second bracket from left in front of socket 2; plus to right. From the fifth post in the upper row of the Master unit run a wire forward and to left to the "minus 3" of this battery and from the plus on the battery run a wire down and to right to the center post on the potentiometer. This battery is not shown in the wiring diagram.

Secure two of these Eveready C batteries to the underside of the flat shield beneath the Daven unit and connect them in series, that is the plus on one to the minus 4½ of the other. Two holes (not shown in drilling layout) will have to be put through the sub base 5¼ inches from rear edge and 3 inches and 2¼ inches in from left edge. The strap is removed on the Daven unit connecting the front end of the last resistor to a post close against the third socket. The plus on the C batteries not previously connected is connected up through the sub base to the post close to the third Daven socket and the remaining minus 4½ on the C batteries is connected up through to the front end of the last resistor, putting 9 volts of C on the grid of the third Daven tube.

The layouts for the three remaining shield pieces are shown here. Of the two notched, one goes tight against the left end of the Master unit, while the other fits snugly against the right side of the third bracket from left and passes about ¼ inch to right of the right end of the Master unit. Before putting in this last named one, connect a four-inch piece of flexible wire to the grounding post projecting from the right end of the Master unit and then insert the shield. The end of this wire can now be soldered to the shield at its rear edge. The third and unnotched shielding piece goes between the oscillator equipment and the Daven unit. The screw holding the front right corner of the Daven unit is loosened and a small right-angle bracket is slipped under it, the vertical portion of this bracket being soldered to the shield just put in.

Antenna and ground connections are made to the first and second binding posts at the left rear corner of set. Battery connections are made as follows: Plus A on the storage battery to plus A on the Daven unit, minus A on battery to minus A on the Daven unit. Negative of a 45-volt B unit connects to negative B on the Daven unit. Plus of this first B unit connects to negative of a second one and to the right one of the two posts behind the Daven unit. The plus 22 post on this second B unit goes to the left of the two separate binding posts while plus 45 of this B unit goes to negative of a third B unit. Plus of this third B unit goes to plus B on the Daven. The speaker goes to the two OUTPUT posts of the Daven unit.

If the ends, back, top and bottom of the cabinet are lined with the number 20 half hard brass it will be seen that the input circuit is in one pocket, the intermediates and second detector in another, the oscillator in a third and the radio frequency amplification in a fourth.

CLASSIFIED ADVERTISEMENTS

BLUE PRINTS

Super Using J. K. Long Wave Air Core Transformers and standard parts. Eight tube set which will cut down interference, static and local noises 50%. Tone Rich and Full Reception. Loop Long Range. New principle in heterodyne. Prints and assembly instructions 50 cents. James M. Davis Co., 30-A Euclid Arcade, Cleveland, Ohio.

PATENT ATTORNEYS

PATENTS. Booklet free. Highest references. Best results. WATSON E. COLEMAN, Patent Lawyer, 644 G Street, Washington, D. C.

RADIO

Big bargains in radio sets and parts. P. V. Grasberger, Bumpass, Va.

Synthetic or Galena Crystal as good as the best, better than the most. Sent any place in U. S. for 25 cents. Money refunded if not satisfied. A. F. Thompson, 704 N. Marsalis Ave., Dallas, Texas.

Five tube radio sold on easy terms to anybody anywhere. One year to pay. Descriptive circular and payment plan free on request. Enclose stamp. Serlin & Co., 1417 Broadway, Detroit, Mich.

MISCELLANEOUS

Photos of Your Favorite Radio Stars. Ten cents and coupon appearing on another page of this Digest will entitle you to one of the photos in our Radio Digest gallery of stars. Write to Radio Digest gallery of stars, 10 North Dearborn St.

HELP STOP BLOOPING

(Continued from page 21)

electric equipment in your own house or in your neighbor's house. There are twenty-eight sources of trouble that ordinarily are outside your house, and, of these, nine may be in power companies' lines. Power companies, as a rule, are very desirous of locating and correcting every case of Radio interference caused by their lines or equipment. A power company is, however, organized for the purpose of delivering electric service to its customers at the lowest possible cost, and they cannot incur unjustified expenses.

Cause Little Interference

Your power company would be subject to severe criticism if it incurred large expenses for things entirely outside its normal business. You can see from looking over this list that only a small fraction of the troubles experienced by broadcast listeners are due to power companies' equipment. The power company cannot undertake to correct Radio troubles not caused by its system, and it should not be called upon to investigate sources of

GOLDENROD GOLD PLATED AERIAL

Used by broadcasting stations and ships at sea for higher efficiency and no corrosion. Approved by Popular Science Institute of Standards, Popular Radio Laboratory, Everybody's Radio Weekly Laboratory and others. Guaranteed to bring in more stations, better reception, greater distance, more volume. Agents and Dealers write.

IMPERIAL RADIO CORPORATION
Dept. 71, 1945 Wabansia Ave. Chicago, Ill.

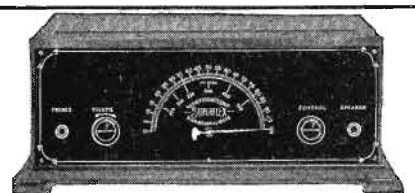

The wonderful SUPERFLEX radio

NEW CIRCUIT—ONE DIAL (one condenser—pat. pdg.) Not reflex. Volume, Clarity, Distance, Selectivity.

Sample to Rated DEALERS. TEST ONE.
RADIO PRODUCTS CORPORATION, (Inc.)
3816 N. 28th St. Birmingham, Alabama

A&B Battery \$2 Charger ONLY



SATISFACTION GUARANTEED

Charges any type of storage A or B battery, using a few cents worth of ordinary house current. Works perfectly on either alternating or direct current. Cannot injure battery and lasts for years. May be used as a trickle charger. Complete directions enclosed—anyone can operate. No expensive "extras" to buy.

Why pay \$10.00 to \$18.00 for a charger when you can

get this splendid GUARANTEED R. B. Charger by mailing us two dollars (bills, money order, check or stamps) plus 10c in stamps or coin to pay mailing costs. Charger will be sent postpaid. If you are not satisfied, return within five days and we will refund your money. Order at once—TODAY.

R. B. Specialty Company
308 East Third, Dept. 340, Cincinnati, O.

Televocal QUALITY TUBES

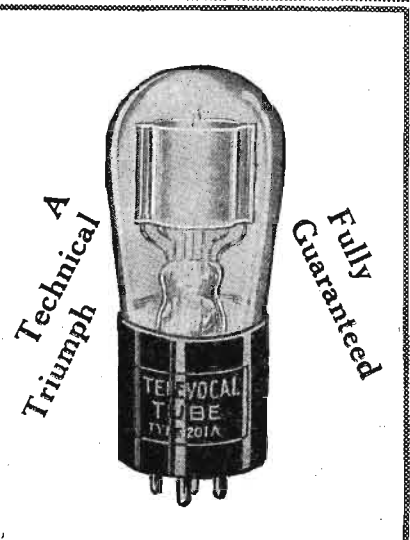

Technical Triumph Fully Guaranteed
Televocal Corp'n
61 A First Ave. — New York

trouble over which it has no control. Every Radio set owner has the duty of finding out whether the trouble is caused by his own set or by something in his house before he calls on the power company. If you are not capable of making the necessary simple tests, or do not care to make them, you should call on the Radio dealer who supplied the set for his assistance and you should expect to pay him for his work.

Join Radio Club

Find out if there is not a Radio club in your locality. Nearly all such clubs now have experts to go out and check up interference troubles, or have the equipment for doing this work by members.

A "RADEX" Tuning Chart

Shows by dial numbers, wave length to which set is tuned. Tells where to place dials for any station. Identifies programs received without announcement.

Adapted to any set

Send 25c Coin or Stamps

RADEX, Box 143-S, CLEVELAND, O.

Radio Bargain Hunters

This Cabinet \$3.45 with built in speaker 7x21

also carried in 7x24—7x26



Panel Size Price
7x21 \$3.45
7x24 3.95
7x26 4.95
Values to \$14.00

Finished in hand rubbed Adam brown mahogany. Lower part of the cabinet contains the loud speaker horn. The end of the loud speaker is covered with a silk screen which adds richness to the entire cabinet. A clip suitable for attaching a loud speaker unit is included. No unit included.

We purchase for cash, bankrupt and surplus stocks from manufacturers and jobbers throughout the country. By selling entirely for cash, we are able to offer guaranteed quality radio apparatus at hitherto unheard of, low prices. We do not have everything in radio, but if we have it, you can save money.

Send for the Bass Bargain Bulletin and save money on your radio needs.
A. H. BASS & CO.
744 N. Clark St., Dept. 14, Chicago, Ill.



9 "ROXY" ROTHAFEL OF WEAF CHAIN
Size 11x14 inches

Photogravures of Your Favorite Artists

GALLERY OF RADIO STARS

By special arrangement, Radio Digest is able to offer its readers a great opportunity to secure fine photogravures of their favorite Radio stars at practically no cost. Below is only a partial list of the photogravures now included in the Gallery of Radio stars. Complete list in March 20 issue.

- 1 Wendell Hall, king of ukulele ditties.
- 2 Graham McNamee, 1925 Gold Cup announcer.
- 3 Jack Little, popular wandering balladist.
- 4 Billy B. Van, the Sunshine Man.
- 5 Coon-Sanders' "Nighthawks" at KYW

COUPON NO. 14

This coupon entitles the holder to one photogravure selected from the Radio Digest Gallery of Radio Stars when accompanied by ten cents to pay the cost of mailing and postage. Three consecutively numbered coupons entitle the holder to three photogravures when accompanied by 25 cents. Remittance must accompany the coupon. Cash at your risk. Add 5 cents to personal checks for exchange.

Order by Number.....
RADIO DIGEST PUBLISHING CO.
510 N. Dearborn St. Chicago, Ill.

Full descriptions of the apparatus used by clubs and power companies for searching out sources of trouble will be presented in later chapters of this series.

(Next week's installment of this series contains the tests for locating the more ordinary sources of trouble and means for correcting these difficulties when found.—Editor's Note).

NO MORE BATTERIES

Eliminate all batteries, "A," "B" and "C." Any type of set, any type of tubes, and any number of tubes. Smooth, steady flow of current for filament and plate. Either Direct or Alternating Current. No Hum. Complete plans, blueprints and all instructions for only—\$2.00. Fully guaranteed—can be built by any radio amateur or fan. Send for a set today, mentioning type of current used.

ENGINEERS SERVICE COMPANY
Suite 203, 15 Park Row NEW YORK

FOR CLEAR, QUIET "B" POWER

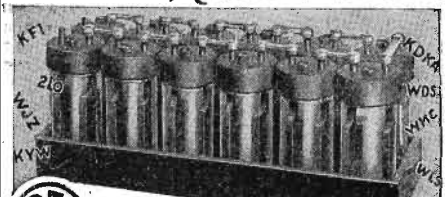

RADIO Storage "B" Battery

12 Cells 24 Volts Lasts Indefinitely—Pays for Itself
Economy and performance unheard of before. Recharged at a negligible cost. Delivers unflinching power that is clear, pure and quiet. Approved and listed as Standard by leading Radio Authorities, including Pop. Radio Laboratories, Pop. Sci. Inst. Standards, Radio News Lab., Lefax, Inc., and other important institutions. Equipped with Solid Rubber Case, an insurance against acid and leakage. Extra heavy glass jars. Heavy rugged plates. Order yours today!

SEND NO MONEY Just state number of batteries wanted and we will ship day order is received. Extra offer: 4 batteries in series (96 volts) \$19.50. Pay expressman after examining batteries. 5 per cent discount for cash with order. Mail your order now!

WORLD BATTERY COMPANY
1219 So. Wabash Ave. Dept. 76 Chicago, Ill.
Makers of the Famous World Radio "A" Storage Battery
Prices: 6-volt, 100 Amp. \$11.25; 120 Amp. \$13.25; 140 Amp. \$14.00.
All equipped with Solid Rubber Case.

World STORAGE BATTERIES

Set your Radio Dials at 210 meters for the new 1000 watt World Storage Battery Station. W.S.B.C., Chicago. Watch for announcements.

Year after Year leading builders of fine sets use more Thordarsons than all competitive makes of transformers combined—proof they are best!

ZENITH
KENNEDY
Radiodyne
Planstiehl
Howard
Thermodyne
OZARKA
Deresnadyne
ADLER-ROYAL
MURDOCK
MU-RAD
Valley
LEICH
Silver Marshall
GLOBE
MORCAUK
Newport
BUCKINGHAM
NUNN-LONDON
KIDSTOMBILT and many others

ALSO—
Choice of
MacMillan
Arctic
Expedition

Do as they do—use
THORDARSON
Super
TRANSFORMERS
STANDARD ON THE FINEST
THORDARSON ELECTRIC MFG. CO., CHICAGO

Radiophone Broadcasting Stations

Corrected Every Week—Part II

FIND MISTAKES AND YOU'LL GET DOLLAR

ONE DOLLAR will be paid to the Radio fan reader of Radio Digest submitting the most errors in any one station's listing in the Directory of Radiophone Stations, which appears in six parts, serially continuously on the next to last page. Letters must reach Radio Digest's office not later than one week from date of issue corrected. Readers are not limited to correcting one station, but such corrections must be verified by the stations themselves, and NOT by comparison to other so-called accurate Radio directories or lists. Verifications must accompany corrections. Turn in corrections for as many stations as you can find—if you can find errors! Use separate sheet of paper for each station submitted and place name and address on each sheet. In case of tie, duplicate awards will be made.

United States (Cont'd)

(Note—The second part of the schedule list appears below. The first appeared last week.)

KMOX, St. Louis, Mo. 280.2m-1070kc. The Voice of St. Louis. Announcer, Nate Caldwell. Daily ex Sun, Thurs, 9:40 am, markets; 12:30 pm, organ; 3, 4, 6, 11:30, music. Thurs, 9:40 am, 12:30 pm, 3, 4, 6, 9 pm, Central.

KMTR, Los Angeles, Calif. 238m-1260kc. 500 watts. K. M. Turner Radio Corp.

KNRC, Los Angeles, Calif. 208.2m-1440kc. 250 watts. Kierulff & Ravenscroft Co. Announcer, "Hastings." Daily ex Sun, 10 am, Mon, 1:30 pm, Tues, Wed, Thurs, Fri, 7-9 pm, Pacific.

KNX, Hollywood, Calif. 386.9m-890kc. 1000 watts. Daily ex Sun, 7:30 am, exercises; 8, prayer; 9, time; 9:05, news; 10, Town Crier; 10:30, economics; 1:30 pm, book talk; 2-4, 4:55, markets; 5, children's half-hour; 5:30, organ; 5:55, Town Tattler; 6:15, travel talk; 6:30, dinner music. Mon, Wed, Fri, 7-12 mid. Tues, Thurs, 7-11 pm, Sat, 7-2 am, Sun, 10-12:30 pm, church service; 12:45-1:45, 2-4, 6:30-7, 8-9, 9-10:30, Pacific.

KOA, Denver, Colo. 322.4m-930kc. 5,000 watts. General Elec. Co. Daily ex Sun, 11:45 am, weather, road reports, markets; Daily ex Sun, produce. Daily ex Sun, 12:45 pm, organ, Tues, Thurs, Fri, 8:15 pm, relating exercises, matinee for housewives, culinary hints, fashion review. Daily ex Sat, Sun, 6 pm, stocks, markets, produce, news bulletins; 6:30 pm, dinner concert. Mon, 7:30 pm, Sandman's hour. Tues, farm question box. Wed, Book of Knowledge. Thurs, dinner concert. Fri, Sunday school lesson. Mon, 8 pm, Spanish lesson; 9 pm, vocal lesson. Wed, Fri, 8 pm, orchestra; 8:15 pm, regular program. Wed, 10 pm, dance program. Sat, 9 pm, Sun, 10:30 am, and 7:30 pm, service; 8 pm, music. Mountain.

KOAC, Corvallis, Ore. 280.2m-1070kc. 500 watts. Oregon Agricultural College.

KOB, State College, N. M. 348.6m-860kc. 1,000 watts. N. M. College of Agril. & Mech. Arts. Announcer, Robert Stewart. Slogan, "The Sunshine State of America." Daily 11:55-12:30 pm, time, weather, road reports, news; 9:55-10:10, time; weather, road reports. Mon, Fri, 7:30-8:30 pm, Mountain.

KOCH, Omaha, Neb. 258.5m-1160kc. 250 watts. Central H. S. Announcer, C. H. Thompson. Mon, Tues, Thurs, 8:30-10 pm, Sat, 12 midnight, Sun, 3:30 pm, Central.

KOCW, Chickasha, Okla. 252m-1190kc. 200 watts. Okla. College for Women. Tues, Thurs, 3 pm, music. Wed, 10 am, chapel. Central.

KOIL, Council Bluffs, Iowa. 277.6m-1080kc. 500 watts. Mona Motor Oil Co. Announcer, Howard Martin. Mon, 6-12 mid. Tues, Thurs, Fri, 6-9 pm, 11-12, Wed, 6-7:15 pm, Sat, 5-9 pm, 11-1 am, Sun, 11-12 noon, 1-2 pm, 7-9, 11-12, Central.

KOWW, Walla Walla, Wash. 256.3m-1170kc. 500 watts. Blue Mt. Radio Association. Slogan, "The Valley They Liked So Well They Named It Twice." Mon, Thurs, Fri, 7-7:30 pm, 8-12, Tues, 5-6 pm, Wed, Thurs, 12-1 pm, 7-7:30, 9-12, Sat, 2-7:30 pm, 8-12, Pacific.

KPO, San Francisco, Calif. 428.3m-700kc. 1,000 watts. Hale Bros. and the Chronicle. Announcer, Clair E. Morrison. Slogan, "The City by the Golden Gate." Daily ex Sun, 7-7:30 am, daily dozen; 10:30 am, amusement service; 12 noon, time, scriptures. Daily ex Sun, Fri, 1-7:30, music, markets. Mon, Tues, Wed, Thurs, Fri, 8-11 pm, entertainment. Tues, Thurs, 10 am, household hour. Tues, Wed, Thurs, 10:35 am, markets. Wed, 3:30 pm, style talk. Fri, 12:45 pm, luncheon; 5:30-7:30 pm, Sat, 8-12 midnight, Sun, 9:45 am, service; 5-6 pm, organ; 6-6:30, orchestra; 6:35-10, music. Pacific.

KPPC, Pasadena, Calif. 228.9m-1310kc. 500 watts. Pasadena Presbyterian church. Announcer, G. Anton Pohlman. Wed, 7:30-9 pm; Sun, 10:30-12:30 pm; 6:45-9, Pacific.

KPR, Houston, Texas. 296.9m-1010kc. 750 watts. Houston Post-Dispatch. Slogan, "Kotton Port Rail Center." Announcer, Alfred P. Daniel. Daily ex Sun, 10:55 am, time; 11, weather, farm news; 12 noon, entertainment. Daily ex Sat, Sun, Fri, 5:30 pm, Uncle Judd's Kiddies' hour; 7:30-9:30, concert. Wed, 11-12 midnight, Sat, 10-11 pm, Sun, 10:45 am, 8 pm, services; 9:30-10:30 pm, music. Central.

KPSN, Pasadena, Calif. 315.6m-950kc. 1,000 watts. Pasadena Star-News. Tues, Thurs, 8-9 pm, Sat, 8-9 pm, 9-10, Sun, 11-12:30 am; 6:45-8:45; 8:45-9:45, Pacific.

KQP, Portland, Ore. 212.6m-1410kc. 750 watts. H. B. Read Incorp. Announcer, H. B. Read. Slogan, "Hood River Apples from Portland, Ore." Mon, Thurs, Fri, 8 pm, Tues, 5 pm, Wed, 8:10 pm, 8:30, Sun, 7:51-8 pm, 9, Pacific.

KQV, Pittsburgh, Pa. 275.1m-1090kc. 500 watts. Double-day-Hill Elec. Co. Daily ex Sat, Sun, 10:30 am, music; 11, 3, music. Eastern.

KQW, San Jose, Calif. 250.6m-1170kc. 500 watts. First Baptist church.

KRE, Berkeley, Calif. 256.3m-1170kc. 150 watts. Daily Gazette. Announcer, D. L. Black. Daily ex Sun, 7:30 am, 11:15, 5:30 pm, Mon, 8-10 pm, Tues, 9-11 pm, Thurs, 8-10 pm, 10-11, Fri, 9-12 midnight, Sat, 8-1 am, dance program. Sun, 10-11 am, church; 6:30-7:30 pm; 8-9, Pacific.

KSAC, Manhattan, Kan. 340.7m-880kc. 500 watts. Kansas State Agricultural College. Announcer, George Gemmill. Daily ex Sat, Sun, 9-10 am, 9:55, 12:35 pm, 4-5, 6:30, Sat, Central.

KSD, St. Louis, Mo. 545.1m-550kc. 500 watts. St. Louis Post-Dispatch. Daily ex Sun, 9:40 am, 10:40, 11:40, 12:40 pm, 1:40, 2:40, 3:40, Mon, 7:30, 9, 10, Tues, 7 pm, 8, 9, Wed, 7 pm, 7:30, 8, Fri, 7 pm, 7:30, 8, 9, 10, Sat, 7 pm, 8:30, 9:30, Thurs, 4 pm, 7, 7:30, 8, 9, 9:30, Sun, 6:15 pm, 8:15, Central.

KSL, Salt Lake City, Utah. 299.8m-1000kc. 1,000 watts.

Radio Service Corp. of Utah. Announcer, Charles H. Hays. Mon, Wed, Fri, 7-11 pm, Tues, Thurs, Sat, 7:30-11 pm, Sun, 3-10 pm, Mountain.

KSMC, Santa Maria, Calif. 209.7m-1130kc. 100 watts. Santa Maria Valley Railroad Company.

KSO, Clarinda, Iowa. 241.8m-1240kc. 500 watts. A. A. Berry Seed Co. Announcer, Joe Fassen. Slogan, "Keep Serving Others." Daily ex Sat, Sun, 12 n, talks; 12:30-1:15 pm, 7-8, Central.

KTAB, Oakland, Calif. 239.9m-1250kc. 1,000 watts. North Ave. Baptist church. Daily ex Sun, 9-9:30 am, prayer service; 12-1 pm, Daily ex Sat, 8-10 pm, Sun, 10 pm, 11; 7:45 pm, 9:30-11, Pacific.

KTBI, Los Angeles, Calif. 293.9m-1020kc. 750 watts. Bible Inst. of Los Angeles. Announcer, M. E. Carrier. Daily ex Sun, 8:30 am, 2 pm, 7:15-9:30, Sun, 10:45 am, 6 pm, 7:15, 9:30.

KTBR, Portland, Ore. 263m-1140kc. 500 watts. Brown's Radio Shop. Pacific.

KTCL, Seattle, Wash. 305.9m-980kc. 1,000 watts. KTCL Broadcasting Co. "Know the Charmed Land." Tues, 7-8 pm, 8-9, Wed, 8-9 pm, 9-10, Fri, 7-8 pm, 9-10, 10-15-12, Sun, 1-2 pm, 9:10-10:10, church service. Pacific.

KTHS, Hot Springs National Park, Ark. 374.8m-800kc. 750 watts. The New Arlington hotel. Announcer, G. C. Amoux. Slogan, "Kum to Hot Springs." Mon, Wed, Thurs, 12:30-1 pm, markets, weather, music. Fri, 12:30-1:30 pm, Farmers' Radio Chautauqua. Sat, 12:30-1:20 pm, boy's talk, Bible class, music, weather, markets. Daily, 9-11:30 pm, concerts. Sun, 11-12:15 pm, church services; 9-10 pm, classics; 10-11:30 pm, Arkansas Traveler frolic. Central.

KTNT, Muscatine, Iowa. 256m-1170kc. 500 watts. Tanglely Callaphone company. Announcer, Norman Baker-William Randall. Slogan, "The Homefolks' Station." Daily ex Sun, 12-12:30 pm, Callaphone concert. Daily ex Sat, Sun, 7:30-8 pm, painting lessons. Daily ex Sat, 8:30-10 pm, music. Sun, 9-10 pm, "Homefolks' Hour." Central.

KTW, Seattle, Wash. 454.3m-660kc. 1,000 watts. First Presbyterian church. Announcer, J. G. Priestly. Slogan, "Hear Ye, Hear Ye, the Gospel." Sun, 11-12:30 pm, 3-4:30, 7-9:30, church service. Pacific.

KUA, Fayetteville, Ark. 299.8m-1000kc. 750 watts. University of Arkansas. Mon, 7:30 pm, Tues, Thurs, 8 pm, Central.

KUOM, Missoula, Mont. 243.8m-1230kc. 500 watts. University of Montana. Daily ex Sun, 6:30 pm, Mon, Thurs, 8 pm, Sun, 9:15 pm, Mountain.

KUSD, Vermillion, S. D. 277.6m-1080kc. 100 watts. University of South Dakota. Announcer, Sidney Lawton. Slogan, "South Dakota University for South Dakotans." Wed, 8-9:30 pm, Central.

KUT, Austin, Texas. 250.6m-1300kc. 500 watts. University of Texas. Announcer, Orlando J. Murphy. Mon, Wed, 8 pm, Sun, 11 am, 3:30 pm, Central.

KVQO, Bristol, Okla. 374.8m-800kc. 500 watts. Slogan, "Voice of Oklahoma."

KWCR, Cedar Rapids, Iowa. 277.6m-1080kc. 500 watts. Announcer, H. F. Paar. Slogan, "The Voice of Cedar Rapids." Mon, Wed, Sat, 4:15-5 pm, 9-10:30, Mon, 10:45 pm, Sun, 11 am, 5:15-5:45, 5:45-6:30, Central.

KWQ, Stockton, Calif. 247.8m-1210kc. 500 watts. Portable Wireless Telephone Co. Announcer, Paul C. Schulz. Slogan, "Voice of the San Joaquin Valley." Daily ex Sun, 4-5 pm, news, concert, markets. Tues and Fri, 8-9 pm, concert. Sun, 6-7 pm, concert. Pacific.

KWKC, Kansas City, Mo. 236.1m-1270kc. 100 watts. Wilson Duncan studio. Slogan, "Keep Watching Kansas City." Tues, Wed, Thurs, Fri, 7 pm, 9, Central.

KWKH, Shreveport, La. 260.1m-1150kc. 500 watts. W. G. Patterson, Henderson Iron Works & Supply Co. Announcer, W. G. Patterson. Mon, 8-9:30 pm, music. Tues, Sat, 9-12 midnight, Thurs, 8-9:30 pm, Sat, 9-12, dance. Sun, 9:30-10:30 am, music; 11-12 m, 5-6 pm, 7:30-9, Central.

KWSC, Pullman, Wash. 348.6m-860kc. 500 watts. State College of Washington. Announcer, Phil Hitchcock. Mon, Wed, Fri, 7:30-9 pm, music. Pacific.

KWUC, Le Mars, Iowa. 252m-1190kc. 500 watts. Western Union College. Announcer, D. O. Kime. Slogan, "The Best Fifth Wat' Station on the Air." Mon, Wed, Fri, 7:30-9 pm, Sun, 3-4 pm, Central.

KWVG, Brownsville, Texas. 277.6m-1080kc. 500 watts. Brownsville Municipal Broadcasting Station. Slogan, "Kum to the World's Winter Garden." Daily ex Sun, 12 m, 6 pm, Mon, Thurs, 8:30-11:59 pm, Sun, 2:30 pm, Central.

KYW, Chicago, Ill. 535.4m-560kc. 3,500 watts. Westinghouse Elec. & Mfg. Co. Daily ex Sun, 9:30-1:30 pm, half market quotations; 10:55 am, time; 11:15, meat talk; 11:35, table talk; 12 n, weather; 12:05-2 pm, noonday concert; 2-2:15, market; 2:35-5, 5:45-6, news, markets; 6-7, dinner music; 7:05-7:30, bedtime story. Tues, Thurs, 7:38-7:53 pm, farm program. Daily ex Sun, Mon, 1-2 am, Tues, Thurs, 8-11:30 pm, Wed, 8-12:30 am, Fri, 9-12:30 am, Sat, 8:30-1 am, Sun, 11 am, Central church; 2:30 pm, 4:30, 7, Sunday Evening club; 9:30-11, concert. Daily, 8 am-2 am, every half hour, World-Crier. Central.

KZIB, Manila, P. I. 249.9m-1200kc. I. Beck, Inc.

KZKZ, Manila, P. I. 272.6m-1100kc. 500 watts. Radio Corporation of the Philippines.

KZM, Oakland, Calif. 239.9m-1350kc. 100 watts. Western Radio Institute (Hotel Oakland). Announcer, Elbert Cowan. Daily ex Sun, 6:30-7 pm, orchestra. Pacific.

KZRQ, Manila, P. I. 222m-1250kc. 500 watts. Radio Corporation of the Philippines. Slogan, "Radio Manila."

KZUY, Baguio, P. I. 360m-833kc. 500 watts. F. Johnson sler.

NAA, Radio, Va. 434.5m-690kc. 1,000 watts. United States Navy Dept. Daily ex Sun, 10:05-10:20 am, 11:45, time; 3:45-4 pm, 9:45, 10:05-10:20, Tues, 2:45-3 pm, Tues, Thurs, 6:45-7 pm, 7:25-7:40, Fri, 7:25-7:40, Eastern.

WAB, Cincinnati, Ohio. 258.5m-1160kc. 25 watts. Ohio Mechanics Institute. Sat, 9:45 pm.

WAAF, Chicago, Ill. 277.6m-1080kc. 200 watts. Chicago Daily Druggers Journal. Announcer, Carl Ulrich. Daily ex Sun, 8:45 am, 10:50, 11, 12:50 pm. Daily ex Sun, Sat, 3 pm, 4:30, live stock and weather reports. Central.

WAOW, Omaha, Neb. 384.4m-780kc. 500 watts. Omaha Grain Exchange. Slogan, "Where Agriculture Accumulates Wealth." Daily ex Sun, 9:30 am, 9:45, 10:15, 10:45, 11:15, 11:45, 12:15 pm, 12:45, 1:15, markets; 8-8:30 pm, marketgrams talk. Central.

WABB, Harrisburg, Pa. 204m-1470kc. Harrisburg Radio Co.

WABC, Asheville, N. C. 254.1m-1180kc. 20 watts. Asheville Battery Co., Inc.

WABI, Bangor, Me. 239.9m-1250kc. 100 watts. First Universalist church.

WABO, Rochester, N. Y. 277.6m-1080kc. 100 watts. Lake Avenue Baptist church. Announcer, Morse Clark. Sun, 10:15-12 noon, 7-9 pm, Eastern.

WABQ, Haverford, Pa. 260.7m-1150kc. 100-1000 watts. Haverford College Radio club. Announcer, William S. Halstead. Mon, 7:30-9:15 pm, Fri, 8-9:30 pm, Mon, Fri, 11-12:30 am, organ. Eastern.

WABT, Toledo, Ohio. 263m-1140kc. 500 watts. Scott High School. Daily, 9:15 am, garden talk. Central.

WABW, Wooster, Ohio. 206.8m-1450kc. 500 watts. The College of Wooster. Dept. of Physics. Announcer, Frank C. Isely. Daily ex Sat, Sun, 9:30-10 am, Central.

WABX, Mt. Clemens, Mich. 245.8m-1220kc. 500 watts. Henry B. Joy.

WABY, Philadelphia, Pa. 241.8m-1240kc. 50 watts. John Magaldi, Jr. Slogan, "Quaker City Sleep Doggers." Club. "The American Broadcasting Club." Sun, 9 pm, music; 10:30, "Sleep Doggers' Session." Eastern.

WABZ, New Orleans, La. 275.1m-1090kc. 500 watts. The Coliseum Place Baptist church. Announcer, V. W.

Bradbury. Slogan, "The Station with a Message." Sun, 11-12:15 pm, 7:30-8:45, church service. Central.

WADC, Akron, Ohio. 238.5m-1160kc. 500 watts. Allen Theater Broadcasting Station. Daily ex Sun, 11-12 noon, 6:30-7:30 pm, Mon, 1-3 am, Tues, Fri, 8-11 pm, Thurs, 9:30-11 pm, Sun, 12:30-1:30 pm, 6:30-7:30, Eastern.

WAFD, Port Huron, Mich. 275.1m-1090kc. 500 watts. Albert B. Parfet Co. Announcer, Stanley G. Smith. Slogan, "Gateway to the Great Lakes." Mon, Wed, 9-11 pm, Sat, 11-1 am, Sun, 10-11:30 am, 7:30 pm, Eastern.

WAGM, Royal Oak, Mich. 225.4m-1330kc. 500 watts. Robert L. Miller. Mon, 8-12:30 am, Wed, Fri, 8-10:30 pm, Central.

PART TWO - GUIDE LINE - :: ?

WAHG, Richmond Hill, N. Y. 315.6m-950kc. 500 watts. A. H. Grebe & Co. Slogan, "Wait and Hear Grebe." Daily ex Sun, 12-1:30 pm, Mon, Wed, Fri, 7:30-11:30 pm, 12-2 am, Sat, 12-2 am, Eastern.

WAIT, Taunton, Mass. 228.9m-1310kc. 100 watts. A. H. Waite & Co., Inc.

WAIW, Columbus, Ohio. 293.9m-1020kc. 500 watts. American Insurance Union. Announcer, Roy Snouffer. Daily ex Sun, Sat, 10-11 am, Daily ex Sun, 11:55 am, time; 12-1 pm, news, markets, weather. Mon, 10-11 am, 6-7 pm, 8-9:30, 10:30-11:30, Tues, 6-7 pm, 11-12, Wed, 10-11 am, 6-7 pm, Thurs, 6-7 pm, Fri, 10-11 am, 6-7 pm, 8-9:30, 10:30-12, Sat, 9:15-11 pm, Sun, 3-4 pm, Eastern.

WAMB, Minneapolis, Minn. 243.8m-1230kc. 1,000 watts. Radisson Radio Corporation. Slogan, "The Call of the North." Daily ex Sun, Tues, 12 m, 12:01 pm, 6:35, police alarms; 7, Tues, 1 pm, 5:45, boys' club; 7:20, program; 11, Tues, 12 n, 12:30 pm, Wed, 7:05 pm, talk; 7:10, 11, Thurs, 1 pm, 6:15, dinner concert; 7:01, 7:10, Fri, 1 pm, 7:01, 7:10, 8, 11, Sat, 1 pm, 6:15, 7:05, talk; 7:10, 11:30, Sun, 10:30 am, 2:45 pm, 6:15, 6:45, 9:30, Central.

WAPI, Auburn, Ala. 247.8m-1210kc. 1,000 watts. Alabama Polytechnic Institute.

WARC, Medford Hills, Mass. 260.7m-1150kc. 100 watts. American Radio & Research Co.

WAT, Boston, Mass. 243.8m-1230kc. 100 watts. Edison Elec. Illuminating Co.

WBAV, W. Lafayette, Ind. 272.6m-1100kc. 250 watts. Purdue university. Daily ex Sun, 9:50 am, steaks, markets, weather. Mon, Fri, 7:15 pm, special program. Central.

WBAC, Harrisburg, Pa. 275.1m-1090kc. 500 watts. Pennsylvania State Police. Announcer, A. E. Poorman. Daily ex Sun, 10 am, 1 pm, 5:45, police reports, fire protection, markets; 12 midnight, police reports. Mon, Tues, Wed, 7:30 pm, special. Eastern.

WBAL, Baltimore, Md. 245.8m-1200kc. 3,000 watts. Central Gas, Elec. Light & Power Co. Mon, Thurs, 6-10 pm, Tues, Fri, 6:30-10 pm, Sun, 6:30-8:30 pm, Eastern.

WBAO, Decatur, Ill. 270.1m-1110kc. 100 watts. James Millikin University. University activities. No definite schedule.

WBAP, Fort Worth, Tex. 475.9m-830kc. 1,500 watts. Fort Worth Star-Telegram. Announcer, "The Hired Hand." Club, "Radio Truth League." Daily ex Sun, 10, 11, 12 m, 1 pm, 2, 3, market reports, weather; 4, "Port of Missing Men." Mon, Tues, Thurs, Fri, Sat, 12:05-12:30 pm, 7:30-8:30, 9:30-11, concert. Mon, Thurs, Fri, 11-12 midnight, Sun, 11 am, church; 4 am, concert; 9:30-12, Central.

WBAR, Sisseton, Wis. 270.1m-1110kc. 500 watts. Kopp Radio Co. Slogan, "The Station of Northern Wisconsin." Mon, 9-10 pm, Wed, 8-9 pm, Thurs, 7:30-8:30, Sun, 10-11 pm, Central.

WBAX, Wilkes-Barre, Pa. 256.3m-1170kc. 100 watts. John H. Stenger, Jr. Slogan, "In Wyoming Valley, Home of the Anthracite."

WBBL, Richmond, Va. 228.9m-1310kc. 100 watts. Grace Covenant Presbyterian church. Announcer, Herbert C. Taylor. Tues, 8 pm, Sun, 11 am, 7:45 pm, Eastern.

WBBM, Chicago, Ill. 225.4m-1390kc. 1,500 watts. WBBM Broadcasting. Announcer, Floyd, Faich. Slogan, "World's Best Broadcast Medium." Daily and Sun, 4-6 pm, Mon, 6-7 pm, Tues, Thurs, Sat, 8-12 midnight, Wed, Fri, Sat, 12-2 am, Sun, 8-10 pm, 12-3 am, Central.

WBBP, Petoskey, Mich. 238m-1260kc. 200 watts. Petoskey High School. Announcer, Carl Bowman. Tues, 9-10:30 pm, Fri, 8-9:30 pm, Sun, 10:30 am, church services; 3 pm, sacred concert. Central.

WBBR, Staten Island, N. Y. City, N. Y. 272.6m-1100kc. 500 watts. International Bible Students' Association. Mon, Thurs, Sat, 8-9 pm, lectures, music. Sun, 10-12 m, 2-4 pm, 9-10:30, Eastern.

WBBS, New Orleans, La. 252m-1190kc. 500 watts. First Baptist church. Slogan, "The Gospel Wave." Sun, 7-8:30 pm, service. Central.

WBBW, Norfolk, Va. 222.1m-1350kc. 100 watts. Ruffner Junior High School. Announcer, Lee M. Klinefelter. Slogan, "The School You'd Like to Go To." Mon, 6:45-7:15 pm, Wed, 10:30-11:15 am, Thurs, 9:30-10:30 pm, Eastern.

WBBY, Charleston, S. C. 267.7m-1120kc. 100 watts. Washington Light Infantry. Announcer, Hugh Easterly. Eastern.

WBBZ, Chicago, Ill. 215.7m-1390kc. 500 watts. C. L. Carrell.

WBCN, Chicago, Ill. 225.4m-1390kc. 500 watts. South-eastern Broadcast. Announcer, J. R. Foster. Slogan, "World's Best Community Newspaper." Daily ex Sun, 5-5:15 pm, police. Daily ex Sun, Mon, 7-8 pm, Mon, Wed, Sat, 3-5 pm, Tues, 10-12 midnight; 12-2:30 am, pirate ship. Wed, Fri, Sat, 10-12 midnight, Thurs, 10-1 am, Sun, 10:30-12:15 pm, church service; 4-6 pm, 7:45-9:15 pm, church service. Central.

WBDC, Grand Rapids, Mich. 256.3m-1170kc. 500 watts. Baxter Laundry and Dry Cleaning Co. Announcer, Richard Smith.

WBES, Takoma Park, Md. 222.1m-1370kc. 100 watts. Bliss Elec. School. Fri, 6-7 pm, Eastern.

WBNY, New York, N. Y. 209.7m-1430kc. Shirley Katz.

WBOG, Richmond Hill, N. Y. 238.5m-1270kc. 500 watts. A. H. Grebe & Co., Inc.

WBPI, Newark, N. J. 263m-1140kc. 500 watts. Warner Theater. Announcer, H. E. Beaver. Daily ex Sun, 11 am, Daily ex Thurs, Sun, 6-11 pm, Thurs, 6-7:45 pm, Sun, 11 am, Eastern.

WBRC, Birmingham, Ala. 247.8m-1210kc. 500 watts. Bell Radio Corporation. Slogan, "The Biggest Little Station in the World." Mon, Wed, 8 pm, Sat, 9-12 midnight, Central.

WBRE, Wilkes-Barre, Pa. 256.3m-1300kc. 100 watts. Baltimore Radio Exchange. Wed, Fri, Sun, 8:30-11:30 pm, Eastern.

WBT, Charlotte, N. C. 275.1m-1090kc. 250 watts. Charlotte Chamber of Commerce.

WBZ, Springfield, Mass. 333.1m-900kc. 2,000 watts. Westinghouse Elec. & Mfg. Co. Announcer, A. E. Bach. Daily ex Sun, 6-8 pm, music, markets; 8-10:15, music. Sun, 8 pm, organ; 8:30, concert. Eastern.

WCAC, Storrs, Conn. 275.1m-1090kc. 500 watts. Connecticut Agricultural College. Announcer, Daniel E. Noble. Slogan, "From the Nutmeg State." Mon, Wed, Fri, 7:20-8:30 pm, Eastern.

WCAD, Canton, N. Y. 263m-1140kc. 250 watts. St. Lawrence University. Announcer, Ward C. Priest. Slogan, "The Voice of the North Country." Daily, 11 am, weather, reports, talks, time. Thurs, Fri, 7:30-12 midnight, from WGY on 1,560 meters. Wed, 8 pm, Eastern.

WCAE, Pittsburgh, Pa. 461.3m-650kc. 500 watts. Pittsbury Press, Kaufman and Baer Co. Announcer, Joseph Sartory. Daily ex Sun, 12:30 pm, news; 4:30, reports; 6:30, music; 7:30, Sunshine Girl. Mon, 7:45 pm, police reports; 8:30, 9, 11, Tues, 7:45 pm, 8, 8:30, 9, 10, 11, Wed, 7:45 pm, 8:30, 9, Thurs, 8 pm, 9, 10, Fri, 7:30 pm, 8:30, 10, Sat, 7:45 pm, 8, 8:15, 8:30, Sun, 10:45 am, 4 pm, 9:30, 7:20, 9:15, Eastern.

WCAJ, University Place, Nebr. 254.1m-1180kc. 500 watts. Nebraska Wesleyan University. Announcer, J. C. Jensen. Daily, 4:30 pm, weather, news. Wed, 8 pm, Fri, 7 pm, Central.

WCAL, Northfield, Minn. 336.9m-890kc. 500 watts. Dept. of Physics, St. Olaf College. Announcer, Hector Skifter. Slogan, "The College on the Hill." Daily ex Sun, Thurs, 9:45 am, chapel. Mon, Fri, 8:30 pm, Thurs, 7 pm, music. Fri, 7:30 pm, Sun, 8:30 am, sermon, music; 9:15 pm, Central.

WCAO, Baltimore, Md. 275.1m-1090kc. 100 watts. Albert A. and A. Stanley Brager. Announcer, R. F. Brunner. Slogan, "The People's Store." Mon, Wed, Fri, 6:30-8 pm, dinner music; 8-9:30, 9:30-11, Eastern.

WCAP, Washington, D. C. 468.5m-640kc. 500 watts. Chesapeake & Potomac Tel. Co. Announcer, O. F. Gasoligne. Mon, 7-11:30 pm, Wed, 6-11 pm, Fri, 6-12 pm, Sun, 11 am, 4 pm, 6:20, respers; 7:20-10:15, Eastern.

WCAR, San Antonio, Tex. 263m-1140kc. 500 watts. Southern Radio Corporation of Texas. Announcer, L. Tatom. Club, "Royal Order of Preparatorics." Mon, Thurs, Sat, 8:30-9:30 pm, concert. Wed, Sat, 11 pm, Central.

WCAT, Rapid City, S. D. 239.9m-1250kc. 500 watts. South Dakota State School of Mines. Announcer, J. O. Kammerman. Daily ex Sun, 9:30 am, 12:30 pm, weather, reports. Thurs, 7:30 pm, concert. Mountain.

WCAU, Philadelphia, Pa. 277.6m-1080kc. 500 watts. Universal Broadcasting Co. Announcer, Stan Lee. Slogan, "Where Cheer Awaits U." Mon, 7:30-12 midnight, Tues, 6:45-12 midnight, Wed, 6:45-1 am, Thurs, 6:30-12 midnight, Fri, 6:45-12:30 am, Sun, 11 am, 11-11 pm, 5-9:30, Eastern.

WCAV, Burlington, Vt. 252m-1190kc. 100 watts. University of Vermont. Slogan, "The Voice of the Green Mountains." Fri, 7-8 pm, Eastern.

WCBA, Allentown, Pa. 254.1m-1180kc. 15 watts. Queen City Radio station. Wed, 8:15-11 pm, Fri, 6:45-7:45 pm, bedtime stories, Bible lessons, Sat, 9:30-11 pm, dance music. Sun, 10 am, 5:30 pm, 7, church service. Eastern.

WCBD, Zion, Ill. 344.6m-870kc. 5,000 watts. Wilbur Glenn Voliva. Announcer, J. H. DePew. Slogan, "Where God Rules, Man Prospers." Tues, Thurs, 8-10:30 pm, concert. Wed, 12:30-1 pm, organ. Thurs, 2:30-3:45 pm, service. Sun, 9-10:45 am, Bible school; 2:30-6 pm, church services; 8-10:30 pm, Central.

WCBE, New Orleans, La. 263m-1140kc. 500 watts. Uhart Brothers Radio Co. Announcer, Joe Uhart. Slogan, "Second Port U. S. A." Daily ex Sun, 10:30-11:30 am, Daily, 7:30-8:30 pm, dance, Sun, 12:30-2 pm, dinner concert; 9, dance music. Central.

WCBH, Oxford, Miss. 241.8m-1240kc. 500 watts. University of Mississippi. Announcer, J. T. Wallace. Tues, Thurs, Sat, 9 pm, Central.

WCBM, Baltimore, Md. 228.9m-1310kc. 500 watts. Hotel Chateau. Announcer, Harry J. Dobb. Mon, 10-1 am, Thurs, 10-1 am, Sun, 9:45-11:30 pm, Eastern.

WCBQ, Nashville, Tenn. 241.8m-1240kc. 400 watts. First Baptist church. Announcer, Harry Stone. Sun, 7:30 pm, Central.

WCBR, Providence, R. I. 209.7m-1130kc. 100 watts. Charles H. Messter. (Portable).

WCCO, Minneapolis-St. Paul, Minn. 418.4m-720kc. 5,000 watts. Washburn-Crosby Co. Announcer, Paul Johnson. Slogan, "Service to the Northwest." Daily ex Sun, 9:30 am, 9:35, news; 9:45, markets, weather; 10:30, 11:30, markets; 1:30 pm, markets; 2:30, concert; 4, readers' club; 5:30, children's hour. Daily ex Sun, Sat, 9 pm, woman's hour. Mon, 12 n, orchestra; 3, reports; 6:15, 7:45, 8, 9, 10, Tues, 3 pm, 7, 9:30, 10, 10:05, Wed, 3 pm, reports; 6, 7, 7:30, 8, 9, 10, 10:05, Thurs, 3 pm, markets; 4:30, 7, 7:30, 8, 10, 10:05, 10:20, Fri, 6:15 pm, 7:45, 8, 9, 9:30, 10, Sat, 6:15 pm, 8,

POWEL CROSLLEY JR.

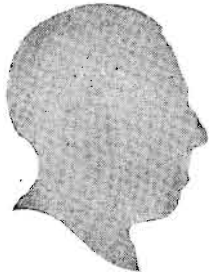

Radio Manufacturer

Linked with the invention of every valued product is the name of some man or group of men. The basic article is invariably a crude affair. Improvements and refinements follow fast. Then comes another pioneer. The production genius who reduces costs to the level of common means.

Often that man's name outlives the inventor's. He, after all, is the benefactor of the people. Several names so associated with the automobile now live in public consciousness, but who can name the inventor of the motor car?

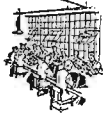

Such a pioneer is Powel Crosley, Jr. . . . liberator of radio from the grip of prohibitive prices. With his genius for reorganization and his talent for applying mass production methods, he has given to the man of modest means joys of radio in common with those of the millionaire. The desired selectivity, sensitivity, tone, volume and volume control, once exclusive to high priced instruments, are now available in Crosley sets at a fraction of the former price.

A trip through the huge Crosley plant is a revelation. Mere machinery takes on superhuman powers, and human powers are multiplied by machines. Operations that once produced only a few units per day, now turn out thousands. Other phases formerly considered so intricate as to demand hand work, are now accomplished by devices that duplicate the dexterity and speed of hands. Multiple drills make many jobs one. Automatic washers heat, treat and wash the parts, that must be chemically clean, in lightning sequence and with positive results.



And in the transformation of hand labor to machine performance the unescapable inaccuracies of human error are supplanted by absolute precision. For example, coils must consist of wires of exact length, wound to a certain tension by a certain number of turns. Variation is inevitable when this is done by hand. But Crosley automatic coil winding assures precise results, uniform tension, micrometer measurement, exactly the same number of turns in every case.



A radio manufacturer who is master of mass production! That is the earned title of Powel Crosley, Jr. And that is the gift that has enabled

him to give the public the kind of radio instruments they want at the kind of prices they want to pay.

Four New Radios

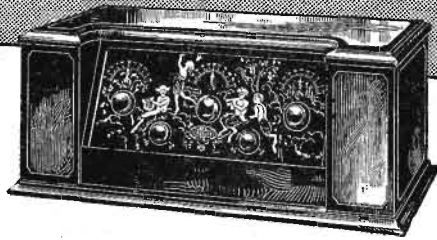

The Crosley 5-Tube RFL-75

Absolutely balanced radio frequency amplification. Non-oscillating under any handling. Exquisite two-tone mahogany cabinet—satin finish. Decorated panel with rose-gold metal fittings. Cabinet holds necessary dry cells. Price without accessories . . . **\$75**



The Crosley 5-Tube RFL-60

Same as RFL-75 but in compact cabinet only 17 1/2 inches long. Truly marvelous selectivity, sensitivity and purity of tone. Art panel—solid mahogany cabinet—rose gold fittings. Price without accessories . . . **\$60**

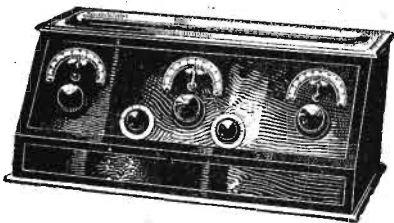

The Crosley 5-Tube 5-38

All the volume, selectivity, sensitivity and fine tone in the best 5 tube set you've heard—plus the CRESCENDON. Two toned mahogany finished cabinet—daintily striped in gold. Price without accessories . . . **\$38**

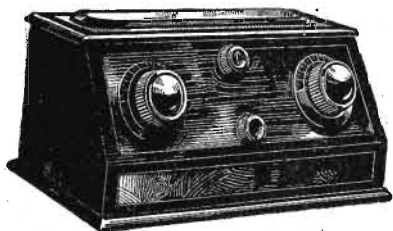

The Crosley 4-Tube 4-29

A beautifully designed set—both to ear and eye. Crescendon equivalent to one or more additional tubes of radio frequency amplification. Two toned mahogany finished cabinet. Price without accessories . . . **\$29**

West of the Rockies add 10% to all prices

"If inexperienced in radio, be sure your first set is a Crosley"

It takes neither practice nor mechanical skill to tune in stations all over the country. Children and old people operate Crosley radios easily. They are fool proof.

They are inexpensive. They don't tie up a lot of money.

They have proven their efficiency over a period of years. Thousands of letters report remarkable demonstrations. Hundreds of thousands of sets sold substantiate all claims to excellence.

They are made by a reliable, well known and financially strong concern, that guarantees them . . . absolutely.

The easy operation, tone and volume of these four new Crosley sets delight, not only the expectant beginner; they arouse the most confirmed radio lover to realization that Powel Crosley, Jr., has again made a revolutionary improvement in radio.

And the RFL sets possess true cascade amplification. For Crosley has utilized an entirely new patented circuit which achieves cumulative amplification, actually approaching the theoretical maximum efficiency per tube.

The Crescendon

In the 4-29 and the 5-38, the introduction of the Crescendon enables these two highly efficient radios to give almost unbelievable results and has lifted them away and beyond all competition.

The Crescendon is an exclusive Crosley device for increasing the weak signals of distant stations to full volume tones without distortion. Yet with these sets, loud nearby stations can always be softened practically to whispers.

Their striking beauty will please your eye, and your ear will introduce to you new qualities in radio, which you are sure to pronounce a revelation.

See the new Crosley sets at your dealers or write Dept. 49 for literature.

Crosley manufactures radio receiving sets which are licensed under Armstrong U. S. Patent No. 1,113,149, or under patent applications of Radio Frequency Laboratories, Inc.

THE CROSLLEY RADIO CORPORATION
Powel Crosley, Jr., President
CINCINNATI, OHIO

Owning and Operating WLW, first remote control super-power broadcasting station in America

CROSLLEY RADIO

BETTER—COSTS LESS

FOR THE ENTERTAINMENT CORNER