

VACUUM TUBE VALLEY

Published Quarterly
Price \$8.00

Celebrating the History and Quality of Vacuum Tube Technology

Issue 3 Volume 1
Winter 1995-96



1935 H. H. Scott 48 Tube Quaranta

In This Issue...

- Classic Radio - E.H. Scott 3
- Altec-Lansing 604 History 5
- WE 300B History and Tests 8
- EICO Early Tube HiFi 13
- Audio Test Bench: DC Meters 16
- McIntosh MI200 18
- SE Transformer Test 22
- Listening to SE Transformers 24
- Cathode Bias Column 25
- Dynaco Stereo 70 Mod 26
- Power Line Conditioning 29
- Vintage Audio Book Review 35
- VTV at the Winter CES 35

Scott Quaranta: The Ultimate Radio

Probably the rarest and most desirable of all radios, the 1935 E. H. Scott Quaranta, (48 tubes with a 100 watt all triode amplifier) is spotlighted by Norman Braithwaite Page 3

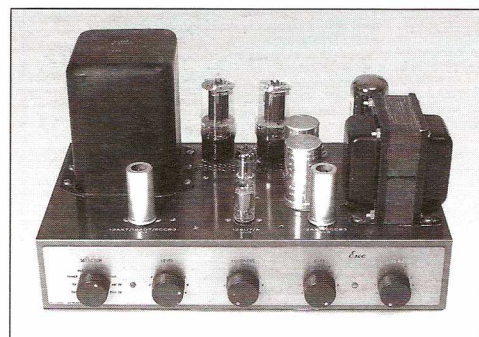

EICO HF20



New Marantz T-1 Mono Block Power Amp

McIntosh to the Max - MI-200

Check out Dave Wolze's mods to this super power amplifier Page 18

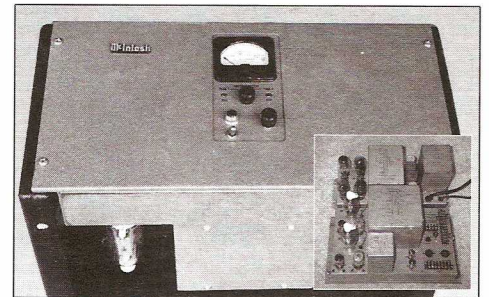

Tube Review: 300B

In existence since 1935 and one of the most controversial audio tubes of all time, the WE-300B is now the defacto standard for the new generation of single-ended amplifiers Page 8

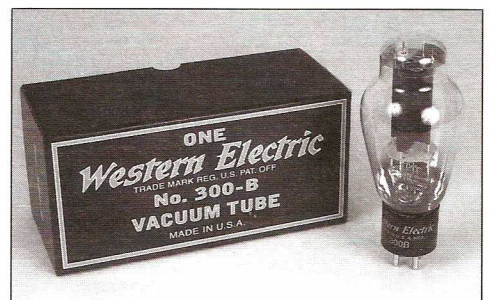

New Western Electric 300B

Classic Loudspeakers: Altec 604

VTV examines the development and history of the most popular coaxial speaker Page 5



Vacuum Tube Valley is published quarterly for electronic enthusiasts interested in the colorful past, present and future of vacuum tube electronics.

Written and Produced in the United States of America
Reprint version 1 - September, 1996

VTV CONTROL GRID

by **Charlie Kittleson, Editor**

Welcome our third and biggest VTV yet! This issue also features a special review of the 1996 Winter Consumer Electronics Show in Las Vegas, Nevada, a new book review and the latest developments in the world of vacuum tubes.

VTV has grown from 16 to 40 pages so now we have higher printing and postage costs. Since we are not completely dependent on advertisers, the increased costs have to be passed on to the subscribers. VTV has information and articles that are not available in any other publications. Our format will remain one of minimal advertising with information-dense editorial. Our high-quality paper and high resolution photographs will continue. We do not want to sacrifice quality for price and we know our readers will appreciate this.

Starting with VTV Issue #5 (Summer 1996), we will increase the annual subscription rate as follows: US \$32., Canada and Mexico \$40, Europe, Asia and the rest of the world \$45.

RCA Buildings destroyed

We have been informed that some of the original RCA/Victor Talking Machine buildings in Camden, New Jersey are scheduled to be demolished. This complex, built in the 1920s, was used by RCA until the 1960s. This is the site where RCA developed television, color television, stereophonic recording and many other important innovations. The entire industrial complex except for the famous "Nipper" tower will be destroyed.

The tower will be rehabilitated and possibly converted to office space. There are currently no developers with plans for the remaining tower building. Mr.



Richard Purvis is attempting to have the site placed on the Register of Historic places. He needs some assistance in this and you can contact him at:

Victor Talking Machine Preservation Company, 104 Elm Drive, Lansdale, Pennsylvania 19446-2636

Triode Supply of Japan at VTV

In November, VTV's offices and lab were visited by Junichi Yamazaki, owner of Triode Supply Japan, Ltd. Junichi had samples of the new VAIC VV52 power triode which were quite impressive. They retail for about US\$1200/pr. We listened to them on a single-ended amplifier using the Electra-Print VT2KB 2.7K output transformer. The tube sounded excellent with full bass extension and sweet, balanced mids and highs.



Tubes on the Internet

The first audio news group on the Internet was **rec.audio**, started several years ago. Then came **rec.audio.high-end** in 1991, started because of flame wars whenever people started posting messages about LPs, tubes and expensive equipment. To handle the technical questions, **rec.audio.tech** was started in 1994. In August 1995, a news group specifically for tubes was started on the Internet called **rec.audio.tubes**. Apparently hundreds of users demanded that this news group be created. Since then, it has been very popular.

If you would like to communicate with VTV on the Internet, our temporary e-mail address is **VTVCHK@aol.com**.

VTV in the News

This summer, VTV was reviewed in a number of audio and electronic publications. We were mentioned in the July 1995 *Stereophile*, the September 1995 *HiFi News and Record Review*, the November 1995 *Wired* magazine and the January 1996 *MJ* Japanese audio magazine.

As of September, VTV is being distributed to the newsstands by **Tower Books and Records** worldwide. **Audio Note UK** is distributing VTV in Europe. VTV is also available through **Antique Electronic Supply** of Tempe, Arizona and **Triode Supply of Japan**, Tokyo, Japan.

A Call to Authors

Here is your chance to get published. VTV is seeking quality articles from our readership. In particular, historical perspectives, broadcasting history, early recording studio equipment, early theater sound systems, speaker and equipment manufacturer profiles and more. We will also consider technical articles on your audio, radio or electronics construction projects relating to vacuum tubes.

EDITORIAL STAFF

Vacuum Tube Valley is published quarterly for electronic enthusiasts interested in the colorful past, present and future of vacuum tube electronics.

Subscription is US\$32.00/year (4 issues) \$40/Canada and \$45/Asia and Europe

CHECKS ONLY NO CREDIT CARDS

To subscribe, renew or change address call or FAX us at (408)733-6146.

Charles Kittleson - Editor and Publisher

John Atwood - Technical Editor

Eric Barbour - Associate Editor

Dave Wolze - Audio Consultant

Steve Parr - Art Director

Jeri Markiewicz - Copy Editing

Copyright 1996 Vacuum Tube Valley
All rights reserved.

No part of this publication may be reprinted or otherwise reproduced without written permission of the publisher.

Send circulation and editorial correspondence to:

Vacuum Tube Valley

1095 E. Duane Ave., Suite 106

Sunnyvale, CA 94086 USA

e-mail - vtvchk@aol.com

THE BEST MONEY CAN BUY

by Norman Braithwaite

Yesteryear's cross between a full-featured home theater system and the Ongaku

Imagine being the owner of a successful and growing foundry equipment business in the mid 1930s. You and your wife (yes - you are married for this feature) have just about everything you have wanted and pretty much do what you want to do. You own a large home, fine cars, an airplane (both you and your wife are small plane pilots), a speed boat, ocean front property on the west coast with a modest waterfall and many other fine things. You enjoy music and frequently attend concerts and operas. You enjoy running your foundry machinery business and, for that matter, tinkering with anything mechanical or electrical.

When not entertaining the likes of Douglas Fairbanks Senior and Erle Stanley Gardner, you sit by your obsolete radio wishing you could receive the now popular European broadcasts on short wave. Your wife is a concert pianist for the Chicago Symphony Orchestra. Obviously, you want the best in a radio receiver and sound system. You are willing to pay about as much for your music system as you did for your house and you want the best. Furthermore, it has to look good because it is going in the house. Not an easy order to fill.

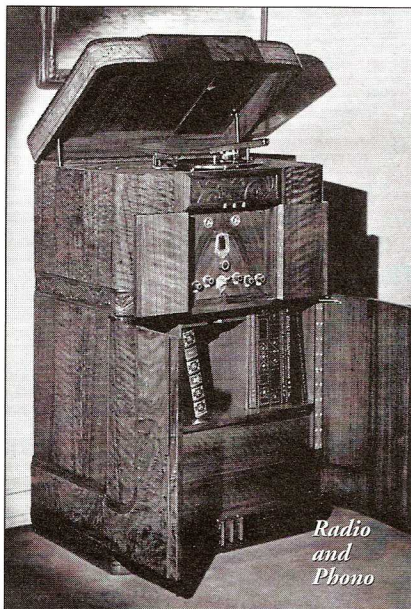

Radio and Phono

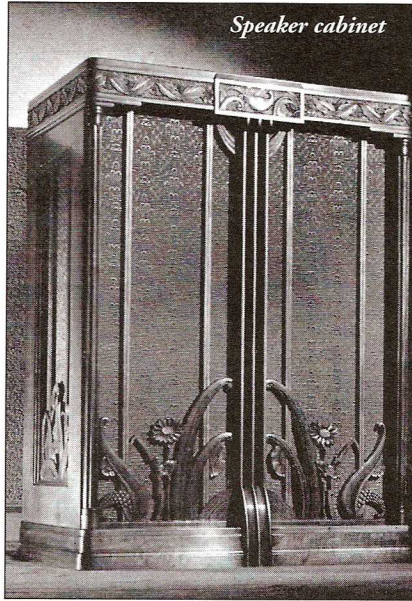

Speaker cabinet

Fortunately, you have an acquaintance in town who owns a company which has built and sold some receivers highly rated by the technical publications (to which, of course, you subscribe). You call your acquaintance to inquire how he may help. A couple of days later you receive a brochure describing the company's current popular high quality receiver of which you have read exceptional reviews along with a couple of company newsletters for customers. The brochure describes a 23-tube "Full Range High Fidelity" receiver with a chrome plated tuner chassis, a chrome-plated 35-watt "distortion free" power amplifier using the recently introduced 2A3 power tubes, a good quality 12-inch electro-dynamic pedestal speaker and two optional "tweeters". The tuner features continuously variable selectivity with an intermediate frequency bandwidth ranging from 2-kilocycles to 32-kilocycles, two stages of radio frequency amplification, voltage regulated oscillator, sensitivity control and signal strength meter. In fact, no other tuner offers such comprehensive features. The set is offered in a variety of fine cabinets and with a variety of options including several phonographs, a volume range expander and a couple of antenna kits. Certainly this is a nice receiver, but upon inspection of the newsletters, you find something of greater interest.

Described in one newsletter is a custom built 40 tube receiver with a deluxe amplifier and speaker section. The tuner of this custom receiver is essentially identical to the unparalleled tuner of the Full Range High Fidelity receiver described in the brochure. In the audio amplifiers of

this custom receiver, the audio signal is split into low and high frequency ranges and each range is amplified separately. Audio signals below 125-cycles per second are amplified by a 50-watt all triode amplifier and fed to a giant 18-inch die cast electro-dynamic low frequency speaker. The audio signals above 125-cycles per second are amplified by a separate 50-watt all triode amplifier and further divided before feeding the mid and high frequency speakers. Audio signals between 125-cycles per second and 3500-cycles per second are reproduced by two 12-inch "concert" speakers and signals above 3500-cycles per second are reproduced by two horn tweeters.

This radio incorporated nothing less than the sound system from a small movie theater! Furthermore, the custom receiver is housed in a very elegant pair of console cabinets. The cabinet containing all of the chassis and the automatic record changer is of select walnut burl and striped walnut with hand carved trim including leaves and a pheasant. The awesome speaker console, in addition to similar woods and trim carving, includes massive carvings of plants and flowers near its base and on the sides. This would go well in any luxurious home.

As if this wasn't elaborate enough, the other newsletter describes a pair of 48-tube custom receivers built for customers on the West Coast. Especially attractive in this model is a 12-inch record lathe, dual ribbon studio microphone and associated electronics (hence the additional 8 tubes). Being able to record your DX reception, live broadcasts and your wife's





piano recitals would be just the thing to impress the guests. Better yet would be a 16-inch record lathe and one of the Capehart record changers which automatically flip the records so you don't have to get up to change them!



Record Cutter

Could you have such a set built? Yes, and that is just what a Mr. Beardsley of the Beardsley and Piper Foundry in Chicago commissioned. The setting for this feature is true, and the receiver which was purchased for \$3500.00 in 1936 was the most elaborate the E.H. Scott Radio Laboratories had ever produced.

Approximately 50 years after the set was built, the Beardsley receiver was located in the attic of the west coast house formerly belonging to the Beardsley family. This set, however, defied all descriptions published or released by the E.H. Scott Radio Laboratories. Instead of two consoles, the Beardsley receiver was housed in three consoles. Unlike the sets featured in promotional literature, the consoles of the



Radio Chassis

Beardsley receiver had carving of flowers and leaves on all consoles and carvings of two pheasants on both the receiver console and the phonograph console.

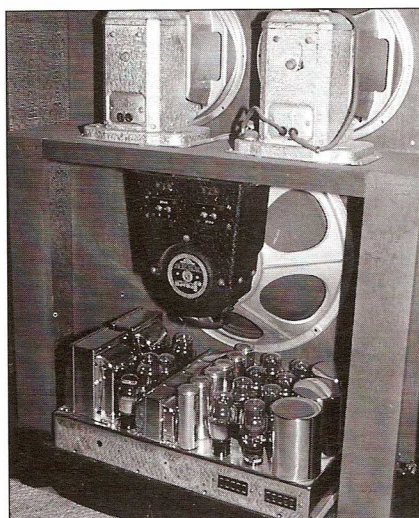

The phonograph console included a Garrard turntable as well as the Capehart automatic record changer. In addition to the tuner and "mid" amplifier (crossover and preamplification), the receiver console included a Presto 16-inch record lathe, an Amperite dual ribbon studio microphone, recording electronics and a logging desk with limited storage. In contrast, the 48-tube custom receiver featured in Scott promotional literature included a Garrard automatic record

changer (which does not flip the records) and a 12-inch Presto record lathe. Excepting a dynamic record scratch suppressor circuit most likely included in the Beardsley receiver, the receiver, amplifiers and recording circuits of the Beardsley receiver were the same as the other sets featured in the Scott promotional literature. (later included in the Scott Philharmonics)

To date, the Beardsley receiver is the only known surviving example of a Scott Quaranta (40-tube) or Scott 48-Tube Custom Receiver (50-tube for the version with the record scratch suppressor). In its day, prior to the advent of frequency modulation, magnetic recording media, and television, this receiver was the ultimate entertainment center.



Amp Chassis

*Norman Braithwaite is a Classic Radio Collector and Historian. He has published several articles on E. H. Scott and other quality radios in **Antique Radio Classified** magazine and related publications.*

CLASSIC LOUDSPEAKERS

**THE ALTEC-LANSING 604
DUPLIX**

by **Charlie Kittleson**

Early Loudspeakers

The need for a full-range speaker became apparent during the golden age of radio in the mid-to-late 1930s. Radio circuits were becoming more sophisticated, output tubes and transformers were being refined as well. The term "high-fidelity" was showing up in more radio advertising. The speakers available then were mediocre, at best, at reproducing the full musical spectrum faithfully. Most speaker systems had mushy bass and the high frequency portion of the signal was typically cut off above 8,000 cycles. Some early high-end radios, including the McMurdo Silver, E. H. Scott and Zenith Stratosphere, were available with high-frequency drivers such as the Jensen "Q" tweeter. This improved the sound, but something better was obviously needed.

Iconic

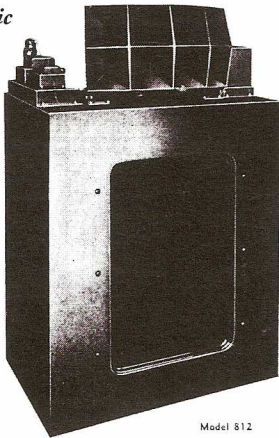

James Lansing began manufacturing speakers in the late 1920s. By 1937, he had perfected a special two-way enclosure featuring a 15 inch electro-dynamic low frequency driver and a special high-frequency driver attached to a multi-cell horn. This new speaker (Model 812, \$246.00), was called "The Iconic." It was sold as a recording studio monitor and was also available from the famous radio maker, E. H. Scott, by special order, with some of their radio sets. The cabinet was either utility finish gray or the available console system (Model 816, \$296.00) was finished in lustrous silver or bronze opalescent. Both Iconic units



Since the introduction of the original 604 speaker in 1943 the Altec 604 "duplex" has been known to all as the finest loudspeaker that money can buy. Now, after years of continuing research, the new Altec 604C "duplex" is here to set even higher standards for audio reproduction . . . for the 604C will faithfully reproduce tones from 30 to 22,000 cycles and handle 50 watts of peak power! Listen to the amazing Altec 604C soon. Your ears will agree it's the finest loudspeaker in the world.

604C SPECIFICATIONS:

- Power rating.....35 watts (50 watts peak)
- Network impedance.....16 ohms
- Maximum diameter.....15 $\frac{1}{8}$ inches
- Maximum depth.....11 $\frac{1}{8}$ inches
- Weight with network.....40 pounds

Don't forget to listen to these new members of the "duplex" line, the 12" 601A and the 15" 602A. They are designed especially for the home.

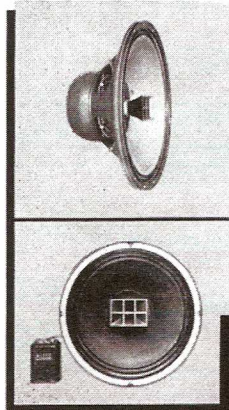

9356 Santa Monica Boulevard,
Beverly Hills, California
161 Sixth Avenue,
New York 13, New York

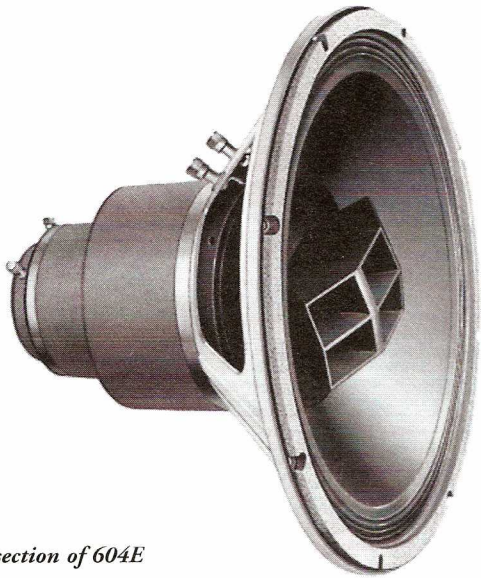

Cross-section of 604E

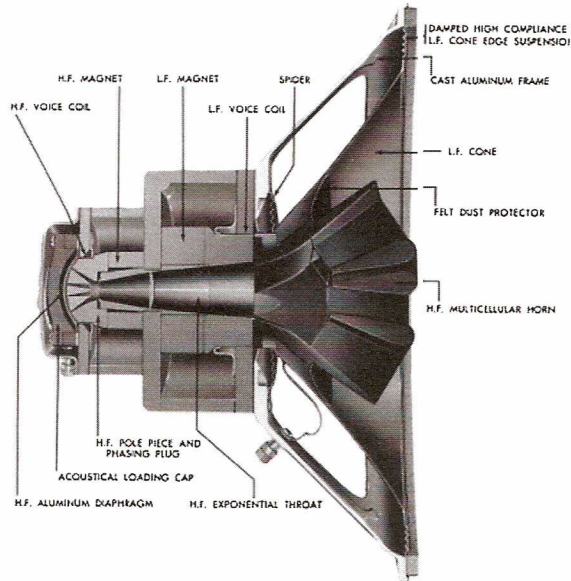

were available with the optional amplifier built in for an additional \$50.00. In the early 1940s, the Iconic was offered with permanent magnet speakers for an additional \$34.00. This speaker system is now very rare and very few examples still exist.

Other speaker manufacturers tried to come up with a combination speaker, including the "coaxial" design with a separate high-frequency unit mounted in front of the woofer. The first widely available coaxial speaker available from a US company was the Jensen 15-inch JHP-51 "Coaxial," introduced in 1940. This design had its limitations in theater and studio applications, however.

The Beginnings of Altec

Western Electric had always been the leader in audio technology throughout the first half of the twentieth century. In the 1920s and 1930s, W.E.'s Electrical Research Products Incorporated division was always at the cutting edge of audio and related technology. However, in 1938, the US government felt that WE was not spending enough of its resources on the development of vital military communications technology. Consequently, that same year, the WE audio business was divested into a separate business called "All Technical Services." A year later, the name was abbreviated to "Altec."

In the early 1940s, Altec saw the market for a high-quality, full-range speaker system and, because of its experience in the theater business, was well equipped for the task. The 604 project was started

in 1941 by a team of Altec engineers including John Hilliard and James Lansing. Their goal was to design a continuous use, heavy-duty, full-range speaker system that would be used by recording engineers and radio stations. They designed the 604 to be very efficient (105 dB/watt), to be reliable and able to endure continuous operation, to be consistent from one unit to another, and to have low distortion to reduce listener fatigue. Introduced in October 1943 at the Society of Motion Picture and Television Engineers trade show, the first 604s were an immediate success and became very popular with recording engineers and radio stations. Both the woofer and the high frequency horn that went through the middle of the unit were

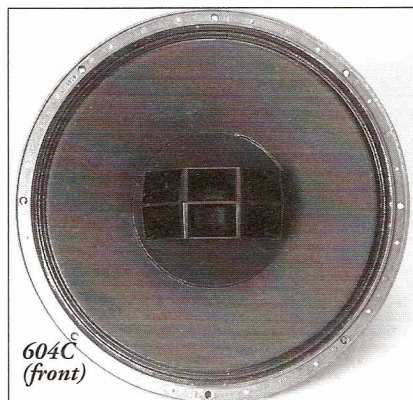

604C (front)

of electro-dynamic design. The drivers crossed over at 1000 cycles. They required separate voltage from DC power supplies to provide the magnetic field for the speakers. The 604 Duplex speaker was finished in wrinkle-black paint and

had very low production figures, probably due to war-time restrictions on materials.

Post-War and the 604

In late 1945, the 15-inch 604A Lansing "Duplex" (\$125.00) with ALNICO 5 permanent magnets was introduced. The maximum power rating of this speaker was 25 watts RMS with a frequency response of 50 to 15,000 cycles. The woofer (similar to an Altec 515A) used a rolled paper surround, and the high-frequency unit (similar to an Altec 802) featured a diaphragm-type driver and a six-cell horn. This 604 featured a deeper speaker "basket" than the later models. The impedance of the 604 was 20 ohms. A separate, 1000-cycle crossover was available. The finish was wrinkle black and the ID label was red, white, and blue in color.

The 604 Duplex was commonly available in the silver-gray type 612 A/B and type 614 A/B/C "Utility" cabinets produced by Altec from the post-war period well into the 1960s. Pictures of old recording studios often depict the Altec Type 612 cabinets as monitor speakers.

604s were commonly sold to churches, radio stations, television stations, recording studios and for sound reinforcement. A great majority of the recordings in your record collection, from postwar to mid-sixties, were mastered using various versions of the Altec 604 as monitor speakers. Most recordings and live broadcasts had plenty of mid-range, so engineers were concerned about the high- and low-"fringe" frequency quality. Thus, the 604 was popular in these environments as it

did not accentuate mid-range frequencies. With many amplifiers, this can create a "hole in the middle" sound characteristic. To get accurate reproduction, recording engineers had to compensate for this using frequency compensation, and in some cases, by playing back their recordings on home hi-fi speakers to verify the quality of the recording.

The 604 Duplex was produced from 1945 - 1948 and is highly sought-after by collectors world-wide for its natural sound characteristics.

Altec introduced the 604B (\$125.00) in 1948 as an improved version of the original 604. It had 16 ohm impedance and used the N-1000 (\$18.00) fixed 1000-cycle crossover. This unit has the same black wrinkle finish, but uses the later black and gold ID decal. The power rating is 25 watts and other specifications are very similar. Net weight of the unit with crossover was 40 pounds.

With the broadcast and recording studio market expanding, Altec introduced the 604C (\$156.00) in 1952. The crossover point was changed to 1600 cycles and it was supplied with the N-1600A crossover. Power rating was 35 watts. It was finished in the famous



Altec 604C

blue-green metallic hammertone paint with a gold colored ID decal. The woofer surround was upgraded with a rubberized material to improve performance. The woofer was similar to the improved 515B Altec unit and the high-frequency driver was similar to the improved 802B.

The 604C was produced until about 1958 and is the most common of the 604 series. It is estimated that more than 50,000 units were produced.

In 1957, Altec introduced the 605 Duplex, and in 1960, the 605A (\$177.00), a less-expensive coaxial unit with smaller magnet structures. The 605



Altec 604 8G and 604E

featured a rolled paper surround. The 605A featured a pleated and treated surround. The woofer was similar to the Altec 416 and the high-frequency unit was similar to the 806 horn driver. Power rating was 35 watts RMS with a frequency response of 30 to 22,000 cycles.

The Altec 604D (\$189.95) was introduced in late 1958 and made through 1964. It is very similar to the 604C, with improvements including: an improved bass cone and suspension and a redesigned pole-piece for less low frequency distortion. The crossover featured smoother twelve db/octave attenuation and an adjustable high-frequency shelving control.

From 1965 through 1972, the 604E (\$179.00 - 195.00) "Super Duplex" coaxial speaker was produced by Altec. The power rating was 35 watts RMS. Frequency response was from 20 to over 22,000 cycles and crossover point was changed to 1500 cycles. Speaker efficiency was 101 dB/watt at four feet. The speaker frame was finished in gloss white and the magnet structure was finished in



Altec 605

gloss light gray. The ID tag was a stick-on type. The woofer featured a pleated and treated surround with a 3-inch copper-wound voice coil. The high-frequency response on the 604E was extended to over 22,000 cycles due to an improved 2.25-inch aluminum high-frequency diaphragm. The horn was a six cell 40 degree by 90 degree high-impact unit. A higher power version, the 604-E2, was offered in the Seventies. The 604E was available raw or in the following Altec enclosures: 857A, 858A (Carmel), or 855A (Malibu).

The 604-8G was produced from 1973-79 and was finished in dark-gray hammertone. Crossover frequency was now 1500 cycles. Power rating was 50 watts RMS and frequency response was 30 to 22,000 cycles. The 604-8G also had an 8 ohm impedance and was marketed to the home audiophile market. It is commonly found in the Altec Model 17 cabinet.

The last of the ALNICO 5 - 604 types was the 8 ohm 604-H, made only in 1980 and 1981. The high-frequency driver (Type 902) now featured the unique "tangerine" phase plug fed to a single-cell, blue plastic Urei horn. The supplied 1500 cycle crossover was different as well, with two adjustable controls for mid-and high-frequencies. The 604-H is extremely rare and is thought by some Altec speaker enthusiasts to be their best version of the 604.

The last version of this speaker offered by Altec was the 604 -8K in the early 1980s. The magnets were ceramic in both the woofer and tweeter, and the coaxial horn was the Mantaray type with

(Continued on Page 32)

HISTORY OF THE WE300B AND ITS RELATIVES

by **Eric Barbour**

You'd think that a regulated power supply somehow doesn't seem related to a high-end amplifier. Yet not only are both of them amplifiers, one for DC and the other for AC, but they frequently use the same power tubes for output. It's possible to drive some audiophiles buggy just by telling them that the low-mu triode they are so fond of was just a common industrial part to the U.S. government 30 years ago. Ask a NASA electronics engineer back then what a 300B was for, and he'd immediately say this: it's a pass amplifier for a high-voltage power supply. This was a very common use for the much-worshiped 300B back in the 1960s. It was chosen for its unusually long lifetime, nothing more. 6550s or 6080s were also used, but had to be changed more frequently. This article will try to explain how the 300B went from being an early hi-fi tube, to a voltage regulator, back to hi-fi, then to holy status.

1. History

In the beginning, there were only two ways of getting more than one watt of audio: either push-pull UX-171s (if in a home radio), or Western Electric 205Ds (if in telephone or professional equipment). If more power was desired, the next jump was a big one, to transmitting triodes like the 211. More plate voltage, more heat, more expense by far. So triodes of an intermediate size were being developed in the late 1920s. The purpose was to get decent power (at least 2 watts from one tube) into the not-very-efficient speakers of home radios, or to get good volume in a movie theater using very efficient horn radiators. Since the need was for low distortion with the simple circuits of the day, triodes were preferred, until pentodes and beam tubes improved in the 1930s.

For the purposes of this article, we will pass over some important early tubes which were rarely used in home radios. These include transmitting triodes such as the 10 and 211, the Taylor triodes, and various triodes in RCA's 800 series. Direct-coupled triodes such as the Speed "Triple-Twin" types, the Triad 6B5 and 6N6, and Arcturus 2B6, will be left out, since they are very specialized units intended for class-B amplifiers only. Thoriated-filament transmitting tubes

come back into the picture for hi-fi equipment in the 1990s, due mainly to the popularity in high-end amps of the 211 and 845 and the appearance of the Svetlana SV811.

After World War I, there were only simple triodes of low-power dissipation. Filaments were plain tungsten wire and quite inefficient. Then, in 1921, Dr. Irving Langmuir discovered that adding thorium oxide to the tungsten during its manufacture would result in a much more effective emitter of electrons. The first tubes to use this filament were the UV-199 and the UV-201A, both made by GE and reaching the market in 1923. But receivers were becoming more sophisticated, and there was also a need to make RF power for transmitting, so specialized power tubes started appearing in 1925.



the type 10 or its successor, the 801A, as hi-fi output tubes.

Initially, neither GE nor RCA were involved in the next step—filaments coated with barium and strontium oxides for extremely high efficiency. Westinghouse took the honors. The UX-112 and UX-171, the first popular audio-power tri-

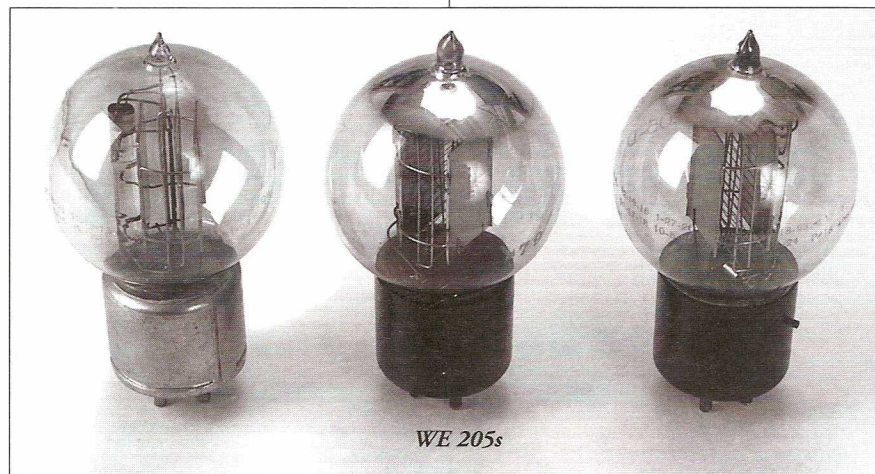

The first was the UX-120, putting out only 110 milliwatts. At the same time, one capable of more than one watt appeared, the UX-210. It was popular as a transmitter in amateur equipment for many years, but was not often used for audio output due to the high plate resistance of 5000 ohms at 450 volts, which



required a fairly complex output transformer to achieve decent fidelity. To this day, people are still experimenting with

odes, were both originated in 1925 by Westinghouse. Then, in 1928, they brought out the UX-250, the first large power triode with an oxide-coated filament. RCA was probably the biggest manufacturer of 250s. In 1929 came the UX-245, a small cousin to the 250. All of these were made in the "bubble" envelope under the numbers 112, 245, 250 etc., and later in the ST envelope under two-digit numbers such as 45, 71, 50. Most laymen think of these tubes as RCA types, though RCA didn't develop any of them. RCA did make a large percentage of the surviving old 171s, 245s and 250s, often under the Cunningham brand. The only time RCA developed audio triodes was in 1933 with the 2A3.

Similar triodes were made in Europe, such as the PX4 and PX25, PP3, PP5, AD1, AC044, and D024. Audio triode design came to an end in the late 1930s, due to the arrival of efficient beam-power tubes such as the 6L6 and KT-66.

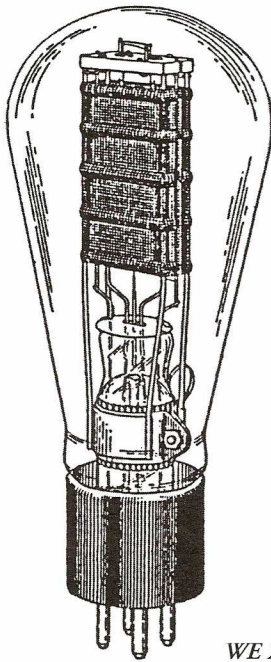

WE 252A

At Western Electric, similar developments were taking place. The 205 series was often used in small power amplifiers in telephone and pro-audio service.

The 205A appeared in 1917, and the common 205D in 1925. A single 205D could put out 1 watt and was roughly the equivalent of the later 245. If the WE engineers needed more power, they had to resort to the much larger 211 series, as used in the type 10 and 43A amplifiers. WE's tube division later produced transitional types. The 244A (1929) produced only 50 mW, but was the death knell for the 205s.

WE hit the UX-250 level in 1930 with the 252A, a very similar unit to the UX250. The 252A is rated 450v, 60 mA, and is supposed to be capable of 8 watts single-ended. It was made only in globe shape, and production supposedly stopped in the mid 1930s, although Bernard Magers says the model wasn't officially discontinued until 1978. The 252A's main use was in the type 59 amplifier, often used in wired music systems and dance halls. The 59 used push-pull 252As and produced 12 watts. The 252A's production may be uncertain, but we do know that it is one of the most valuable old audio tubes. In Japan, an NOS example can bring 300,000 yen. I wanted to get at least one for testing, but none of the local collectors were willing to admit they owned any!

By 1932, things were swinging. The 271A came out in 1932 and appeared in the type 78A, 78B and 82A amplifiers as well as some radio gear. It was good for 2.8W at 400v and was indirectly heated. It was not too popular, and its value today is much less than its directly heated cousins, possibly due to greater distortion. WE's version of the 2A3 was the 275A, also from 1932. It came in both globe and ST shapes, and appeared in theater amps such as the 95A from 1932 to 1934. Its similarity to the early single-plate 2A3 is striking, although the filament is 5 volts, which was something of a WE standard at the time. WE also made VT25As (similar to the 10) and VT52s (similar to the 45) for use in military equipment in the late 1930s.

The 300A was introduced in 1933 and was intended as a replacement for the 252A. Its most famous use was in the WE Mirrophonic film-sound system, type 500A. The system included the famous 91A amplifier, with a single 300A producing 8 watts, driving the 597 horn tweeter connected to 12A horn and TA-2151 woofer. The 300A has a base pin which allowed its use in the bayonet socket now used for 811A transmitting tubes. The base also fits the industry-standard 4-pin socket, as does the 2A3.

The 300B is a 300A with its base pin moved 45 degrees, so the tube would fit



WE 275A

the 205A-type socket, WE part 100M. Thus, 300Bs could be fitted to old 205 amplifiers such as the 42A. Most other amps used the standard 4-pin wafer socket. The 1086 and 92A were push-pull amps using 300Bs, and both were often

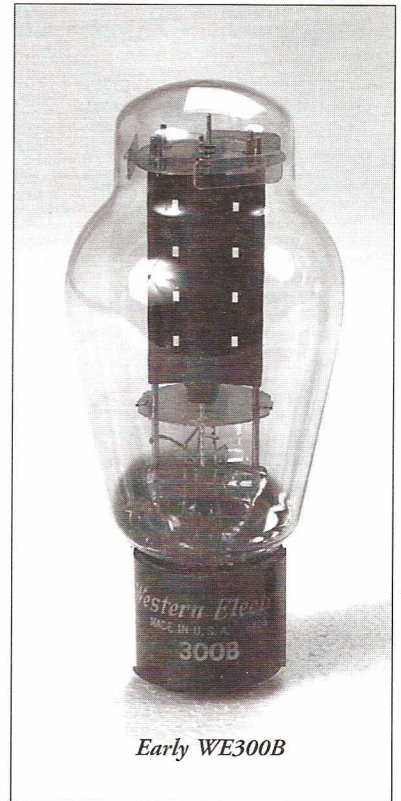

Early WE300B

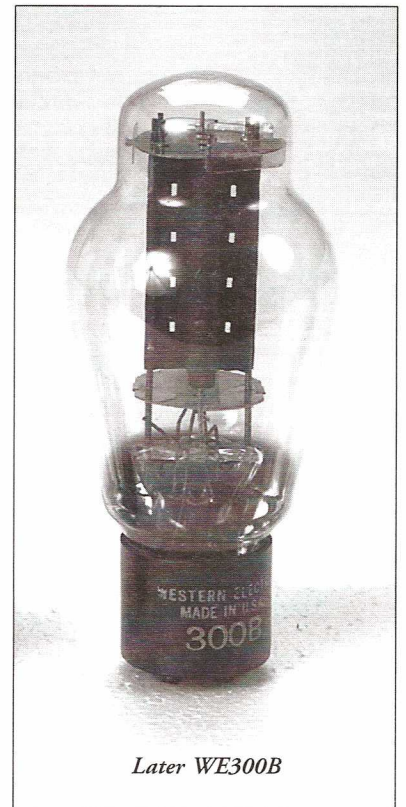

Later WE300B

found in theaters in the late 1930s.

The 300A is believed to come only with its numbers engraved on the base. The 300B, introduced in 1938, was much more long-lived, and came with numbers printed in yellow ink. Early ones had the "lightning-bolt" or "flash" WE logo; in the 1970s they were printed with plain gothic lettering. The final 1988 run went back to the old WE logo to make Japanese customers happy.

After WWII new uses for the 300B were mainly as a power-supply tube, as previously noted. Before the war, some early audiophiles made custom amps with it but were eventually deterred by the high price. The only use of the 300B in a postwar home hi-fi amp was in the Brook 10C, an early hi-fi unit. This was only a provisional use, as the amp's power transformer had filament windings to run either 2A3s (2.5 volts) or 300Bs (5.0 volts). Apparently very few users opted for the higher-priced spread, 2A3s were cheap and good enough for nearly everyone. In addition, a few construction articles appeared using the 300B.

But in the mid-1960s, some French audiophiles discovered the 300B. Apparently a small craze had started for single-ended amps and horn speakers. These guys insisted on listening to their jazz and big-band records through vintage (read: primitive) equipment. And they had tried various amps on their horn systems, and found that only the SE tube amps drove the horns with pleasant results. This was cross-pollinated to Japan in 1972, with some involvement by Jean Hiraga, an audiophile who was half French and half Japanese. The dam broke when MJ magazine wrote about the "magic" 300B in 1973.

At the time, Western Electric was canceling its lease agreements with movie theaters, and selling the equipment to them very cheaply. Since Americans had been told repeatedly that tube equipment was worthless and archaic, many theater managers couldn't wait to junk the old equipment. It's quite amazing that the stuff had remained in service for 40 years in some cases, but it was built to last. Still, it got replaced by solid-state PA gear, and the surplus market filled up with WE "junk." Much of it got shipped to Japan or Taiwan to be melted down for its iron content. Japanese dealers found out and bought it up for a song; now nearly all of it resides with Japanese collectors and dealers. The 1086 and 91A amplifiers were especially desired, for their pleasant tonal characteristics. And

WE 300B ORIGINAL DATA SHEET

- Filament Rating 5.0 volts @ 1.2 amp
- Plate Current 60 ma @ 300 volts plate
- Amplification Factor 3.85
- Plate Resistance 700 ohms
- Grid to Plate transconductance 5500 mMho
- Max Plate Voltage 450 volts
- Max Plate Dissipation 40 watts
- Max Plate Current (fixed-bias) 70 ma
- Max Plate Current (self-bias) 100 ma

so, the power tube used in them (WE 300B) became a status symbol in Tokyo. In fact, serious Japanese WE fanatics set up complete Mirrophonic theater systems in their listening rooms!

These collector status toys fit in with the wide-spread prosperity of Japan in the 1970s and 1980s. Japan is a small and crowded country, and to even have the space for a garage was a huge luxury, so the new class of salaried men didn't develop an interest in car customizing as Americans did after WWII. But small apartments do have space for displays of audio equipment. Since the salaried men had good incomes and remembered the good quality of WE electronics, anything with the Western Electric brand was regarded as the ultimate in American audio. The fact that it was all industrial-grade and rare may have helped. WE did not make much pro-audio equipment; mostly it was used in theaters or radio stations, and was leased rather than being sold on the open market. It is believed that not more than 4000 91As were made, based on serial number surveys.

The tube used in those amps, the 300B, was made up to 1988 when they cost \$125.00 wholesale in minimum lots of 5000. The audiophile interest in Japan drove up the price in the 1980s, and many ham-radio operators and "junk" collectors sold their tubes cheaply. Then, in 1988, WE shut down tube production in Kansas City, and the price began to skyrocket. After the last of WE's stock was sold in 1990, dealers began asking \$300 or more. And all this happened before American audiophiles developed an interest in 300Bs. There are some people in America who have personal stocks, and they do not let them go at any price. None of the regular distributors have any in stock, or so they claim. Any that do appear on the open market for less than \$500 are snapped up instantly.

Westrex Corporation (Western Electric Export Corporation), founded in 1928 was set up as a division of Western Electric for the marketing of their audio products. In 1958, Westrex was divested by Western Electric. Now, Westrex Corporation, headed by Charles G. Whitener Jr. is re-releasing the Western Electric 300B. The tube is said to be manufactured at the original WE Kansas City works using the original tooling and some of the original personnel. They are using the same quality materials and conducting the same stringent testing on the new generation of 300Bs. These tubes were introduced at the Winter 1996 CES in Las Vegas.

The use of the 300B in new amplifiers began in Japan long ago. Many companies such as Nishimura and Audio Professor began to produce 91A-like monoblocks in the early 1980s. The circuit was a simplified 91A, with a single 310A pentode driving the 300B, RC coupled. They must have been popular, as the number of companies making single-300B amps in Japan has spiraled up ever since. And an American company, Cary Audio, bucked the local trend and made 300B amps in both single-end and push-pull form, strictly for the Asian market until recently.

Up until 1992, the number of Americans using such equipment could be counted in two digits. Then, *Sound Practices (SP)* magazine appeared. Publisher Joe Roberts had been a salesman at a high-end audio salon, but listened to old WE equipment at home. Joe put out *SP* in order to, in his words, "shake up" the high-end scene. *SP* has focused on single-ended tube amplifiers, tube preamps, and horn speakers ever since.

At first this was heresy in American circles; tube amps were supposed to feature lots of push-pull 6550s and loads of power, according to tastemakers writing in *Stereophile* and *The Absolute Sound*. And to this day, there are still many American audiophiles who regard tube electronics as "too soft-sounding," and horn speakers as heavily colored. But Roberts was aggressive in his promotion of the single 300B, and the WE or Altec horn speakers that were usually used with it in theaters.

Many established audio reviewers started to change their minds; Dick Olsher of *Stereophile* in 1993, others later. *Positive Feedback* started raving about Audio Note amplifiers in 1993; these very expensive Japanese single-tri-

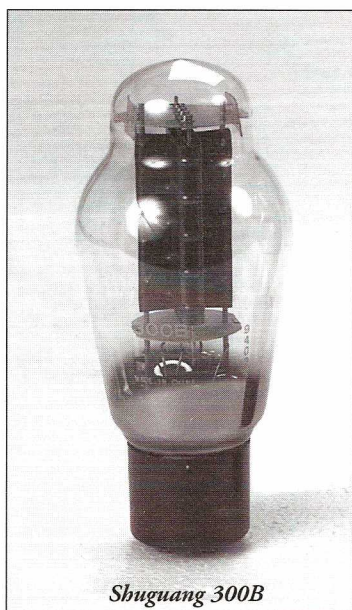

Shuguang 300B



Svetlana SV811



Cetron 300B



Vaic VV30

ode amps are available with silver wire in their circuits and transformers. And recently, Harry Pearson of *TAS* became a convert of sorts to the 300B.

This is a small cultural war, with many personalities on each side opinionated and, in many cases, also being businessmen who profit directly from the sale of audio equipment or magazines. For now, the war continues unabated. Snobbery has become a major part of high-end audio, and the experts are quite snobbish about the superiority of the original Western Electric 300A and 300B. This has only driven the prices for old 300Bs out of sight; most are either being

hoarded or are in Japan now.

The difficulty of getting the WE tubes was alleviated in 1989, when Richardson Electronics started producing its own 300B under the Cetron brand. This tube is usually original equipment in Cary and many other current 300B amps. The Chinese Shuguang 300B appeared in 1992, offering a lower-cost alternative. It's a bit amusing to me that the same dealers who sell the Shuguang 300B for \$50 are also selling Shuguang's 2A3 for \$14; the two types are not enormously different in the labor needed to manufacture them, nor are their materials terribly different.

Recently, there have been further developments. In 1994 came the Vaic VV30B, a direct plug-in replacement for the 300B but with greater plate dissipation and voltage ratings. Then came the Svetlana SV811, a low- μ triode for audio which is derived from the 811A transmitting tube; it is not quite like any other tube available today, and might be thought of as a "super 10".

Most recently, the Sovtek brand introduced a 300B of its own, made in Russia. But these new types are still being compared to the old WE 300B, which has only made it even more scarce. Similar things are happening to old tubes in the 300B league, such as the 50, 275A and 205D. The single-plate construction of the 300B seems to influence the price of the scarce, early RCA 2A3, which has a single plate structure. No doubt this will eventually drive up the prices of other old triodes, such as the 45, 71A and double-plate 2A3 types.

2. Tests

Before discussing the tube tests, a few things need to be said and understood. The audiophile market is extremely faddish and easily swayed by hype, so keep that in mind if you're looking at these triodes. Far and away, the primary use of 300Bs is in single-ended class A1 operation, with a plate load of 2500 to 3500 ohms and no global feedback at all.

In fact, these amps are very primitive; most use self-bias of the output tube at 60 mA, the figure recommended by the old WE data sheet. And the output transformers on the market seem to vary greatly in electrical performance. So take reports of high-end sound out of SE amps with a grain of salt.

A good SE amp can sound very, very good indeed. Because of the lack of any mechanism for crossover distortion, there is no danger of low-level IM distortion; because of the lack of feedback, distortion rises smoothly with output level. But the output transformer is critical, and difficult to get right. And the no-feedback design demands a tube with low inherent distortion.

The 300B, as made by WE, was very low in distortion indeed. For decades it was probably the king of triodes as far as linearity goes, at least in its class. But the world is a complicated place, and the insane prices being asked for vintage WE 300Bs have induced manufacturers to offer their own triodes of this class.

It is striking that so much hype has

built up around such a small (by modern standards) triode. And most fascinating of all, there are no recent published tests or other data testing tubes for distortion. So I built a special single-ended amplifier, for the main purpose of testing all kinds of power tubes. This is the same amp used for the EL34 tests in issue 2 of VTV; the driver is a 6EA7, grid bias is adjustable from 0 to -150v, plate current is metered, and the load is a **One Electron UBT-1** transformer with an 8-ohm dummy load connected to the 4-ohm tap, thus presenting a 3200-ohm load to the tube.

As with the EL34 tests in VTV #2, a Vu-Data 101B distortion analyzer was used for distortion readouts. Regrettably, some refuse to admit that these tests have anything to do with sound quality. Sorry guys, the figures may not be the end-all of good sound, but they are pretty good indicators of what people find most listenable. All the tube filaments were run on well-filtered DC; 5.0v for the 300Bs and VV30s, 6.3v for the SV811s, and 7.5v for the 50s. A single sample of the new (1996) WE300B was sent to VTV and tested. Two of the original WE 300Bs here were "flash" letter types with 1950s date codes, and the other two were 1970s units with gothic lettering; the two styles did not differ much in distortion.

I've chosen to try the tubes at two different plate currents; 50 mA and 75 mA. This brackets the 60 mA recommendation from the WE data. It is not critical to measure 300Bs at that current. There is a transformer manufacturer who gets hysterical if you even suggest running a 300B at anything other than the sacred, exalted 60 mA. Unfortunately, anyone with a SE amp which has adjustable bias finds that the triode becomes more linear as the plate current is increased. 75 mA at 500v is (barely) tolerable for a 300B. If a tube was rated to take 500v, it was tried at that and at 300v, though this was not possible with the UX250s since they are rated for 450v maximum.

I note that only one Vaic VV30B was tried at 50 mA, as the other broke its filament during a lifetime test; and one of the Cetron 300Bs developed a grid-filament short, so only 7 are shown. We also decided not to try all the Cetrons at 500v 75 mA, as some of them began to protest by creaking alarmingly during test. Furthermore, the owner of the original WE 300Bs insisted that his precious tubes not be run at 500v 75 mA, even briefly. Beware of gurus who recommend "setting the tube on fire," not all types can handle it gracefully. Tubes are

arranged in the tables by increasing 2nd harmonic distortion.

Table 1 Average distortion at 500V 50 mA:

Type	% distortion	# of samples
1. Shuguang 300B	0.270	1
2. Vaic VV30B	0.320	1
2. Svetlana SV811-3 (tie)	0.320	12
3. 1950s WE300B	0.323	4
4. Svetlana SV811-10	0.372	26
5. 1996 WE300B	0.470	1
6. Cetron 300B	0.500	7

Table 2 Average distortion at 500V 75 mA:

Type	% distortion	# of samples
1. Svetlana SV811-10	0.110	26
2. Shuguang 300B	0.125	1
3. Vaic VV30B	0.158	2
4. Svetlana SV811-3	0.186	12
5. Cetron 300B	0.224	4

Table 3 Average distortion at 300V 75 mA:

Type	% distortion	# of samples
1. 1996 WE300B	0.095	1
2. 1950s WE 300B	0.104	4
3. Shuguang 300B	0.125	1
4. Vaic VV30B	0.138	2
5. Cetron 300B	0.150	7
6. RCA globe UX250	0.313	2

3. Conclusions:

At 300v, the WE, Shuguang and Vaic were very close together, and sounded quite similar (except for greater bass "tubbiness" in the Shuguang). The Svetlanas were not tested at 300v, as this is very low voltage for them and they, being modified transmitting tubes, prefer more voltage and current. Note that the old globe 50s were mediocre by comparison; their readings were about what a good 2A3 would give. Also note that in this test, 0.15% is very low distortion by comparison with other types and families, so the venerable WE 300B is no slouch.

Some of these tubes aren't really waking up until 500v 50 mA. This is a reasonable dissipation for 300Bs, and it is just tickling the Vaic and Svetlana tubes. Note that they were all quite close together, except for the Cetron which was acceptable. In such tests, due to the small samples (only a single tube in the

case of the Shuguang), a difference of 0.05% is not really significant. Since the Vaic and Svetlana types can be run harder than 300Bs (and they definitely sound better when this is done), they should be run harder in order to take advantage of their greater dissipation capacity. Sorry guys, but distortion **DOES** matter.

The 500v 75 mA test was at the outer limits for conventional 300Bs. The Shuguang and four Cetron 300Bs were able to tolerate the power for a quick test (this was at the verge of redness on the plates). The SV811s and VV30Bs cheerfully absorbed it and begged for more. In fact, I ran 120 mA into an SV811-10 and a VV30B at 500v; no problem, no color was observed on the plates, and distortion was around 0.1% for both.

Note that the load impedance used for testing all of these tubes was 3200 ohms. This was conservative for the 300Bs, but rather low for the SV811s. Even so, the SV811s gave distortion figures on a par with the best 300Bs, indicating that SV811s are more load-tolerant than most receiving power triodes. These results lead to a few possible recommendations.

1. Our single sample of the new (1996) WE300B had the lowest distortion (.095%) at 300 volts and 75mA. This indicates careful attention to metallurgy and higher quality control standards.

The new WE300B should be an excellent performer in both SE and PP amps that have plate voltages under 450 volts.

2. The VV30B is an excellent tube, recommended for either 300B retrofit or for higher-power operation. Because of its high price, it would be best used in an amp designed to run it with 100 mA into the plate for best possible sound. (We do NOT recommend running regular 300Bs that hard; they just aren't made for it. Please don't try it.)

3. The SV811 is also excellent, though it is not compatible with existing amplifiers. It should be a serious contender for OEM and hobbyist use. It, like the Vaic, is very conservative in plate dissipation ratings, and should be run harder than a 300B. The SV811 plate resistance is 2000 to 2500 ohms, and will like to see a plate voltage of 500 to 800 volts which calls for a plate load of 5000 ohms or more; so it shouldn't be retrofitted to a typical 300B amp unless the output transformer is also changed.

(Continued on Page 32)

**EICO - EARLY HI-FI YEARS
1955-62**

by Charlie Kittleson

In 1945, the last year of World War II, Electronic Instrument Company (EICO) of New York, NY, became the first American company to offer a wide range of electronic test equipment in kit form. Some of their first kits included audio generators, capacitor checkers, tube testers, RF generators, vacuum tube voltmeters and more. All of their kits were reasonably priced and were popular performers with electronic technicians and hobbyists.

At that time, most households obtained their radio and music entertainment from packaged "console" units featuring an AM and FM radio, packaged amplifier, record changer, and speaker system. These were offered by Admiral, Philco, GE, RCA, Magnavox and many other companies who today no longer manufacture consumer electronics in the US.

That market was highly competitive in the late 1940s and 1950s. In order to reach the market price point, cost accountants of the top electronics companies typically compromised on quality to improve sales volume. In theory, this worked, but serious audiophiles felt that these "packaged" units lacked the very finest audio that technology had to offer at the time.

Heathkit and others preceded EICO in the kit hi-fi market in the post-war period. Ten years later, in 1955, EICO decided to get into the booming audio market. They were one of the few companies to provide the best performance for the dollar. Typically, their circuit designs were some of the best. EICO engineers were able to combine both Mullard-type and Williamson front ends with Ultra-Linear output stages.

The power supplies were mainly capacitor input type with little or no use of smoothing chokes in the B+ voltage supply. Output transformers were an area where EICO did not compromise quality, using high quality Chicago or Acrosound units. It is because of this that many vintage hi-fi enthusiasts prefer EICO amplifiers, either in stock condition or modified.

All of the EICOs described in this

**Look over the BEST BUYS
in HI-FI ... from EICO®**

EICO is a pioneer (1945) in kit test equipment — leads the industry in distributor sales to trained and critical users.

- EICO has achieved this acceptance because
- EICO engineering policy is to stress electrical and mechanical quality, soundness and functional completeness.
 - EICO prices are low because they are justly related to costs and geared for volume sales.

The same engineering and price policy underlies all EICO high fidelity equipment. You can examine and compare EICO at any of the 1200 neighborhood distributors and hi-fi specialists throughout the U.S. Judge EICO's claims for yourself before you buy. Write for FREE Catalog HF-6.

HF61 Master Control PREAMPLIFIER
KIT \$24.95 WIRE \$37.95
with Power Supply: KIT \$29.95 WIRE \$44.95
Does not add distortion or detract from wideband or transient response of finest power amplifiers at any control settings. High-quality feedback circuitry throughout & most complete control & switching facilities. Feedback scratch & rumble filters, equalizations, tone controls. Centralab Senior "Compentrol" loudness control, concentric level control. 4 hi-level, 2 lo-level switched inputs. Extremely flat wideband freq resp: ±0.3 db 12-50,000 cps. Extremely sensitive. Negligible hum, noise, harmonic or IM distortion. 4-7/8" x 12-5/16" x 4-7/8". 8 lbs.

HF60 60-WATT Ultra-Linear POWER AMPLIFIER
with ACRO T0-330 Output Transformer
KIT \$72.95 WIRE \$99.95
EF86 volt ampl direct-coupled to 6SN7GTB K-coupled phase inverter driving two U/L-connected p-p EL34 output tubes. GZ34 extra-rugged rectifier. Rated output: 60 w (130 w pk). 1M Distortion: less than 1% at 60 w; 0.5% at 50 w. Harmonic Distortion: less than 0.5% from 20-20,000 cps within 1 db of rated power. Sine Freq. Resp: at 1 w; ±0.1 db 15-35,000 cps at any level from 1 mw to rated power. Square Wave Resp: excellent 20-25,000 cps; 3 usec rise-time; Sens: 0.52 v for 60 w. 7" x 14" x 8". 30 lbs. Matching Cover E-2, \$4.50.

HF50 50-WATT Ultra-Linear POWER AMPLIFIER
KIT \$57.95 WIRE \$87.95
Extremely high quality output transformer with extensively interleaved windings, 4, 8, and 16-ohm speaker taps, grain-oriented steel, fully potted in seamless steel case. All other specs equivalent to HF60 but on 50 w level. Matching cover E-2, \$4.50.

HF20 20-WATT Ultra-Linear Williamson-type INTEGRATED AMPLIFIER complete with Preamplifier, Equalizer & Control Section
KIT \$49.95 WIRE \$79.95
Sets a new standard of performance at the price, kit or wired. Rated Power Output: 20 w (34 w peak). 1M Distortion: 1.3%. Max Harmonic Distortion: below 1%, 20-20,000 cps. within 1 db of 20 w. Power Resp (20 w): ±0.5 db 20-20,000 cps; Freq Resp (1/6 w): ±0.5 db 13-35,000 cps. 5 feedback equalizations. Low-distortion feedback tone controls. 4 hi-level & 2 lo-level inputs. Conservatively rated, fully potted output transformer; grain-oriented steel, interleaved windings. 8 1/2" x 15" x 10". 24 lbs. Matching Cover E-1, \$4.50.

HF52 50-WATT Ultra-Linear INTEGRATED AMPLIFIER complete with Preamplifier, Equalizer & Control Section
KIT \$69.95 WIRE \$109.95
Power amplifier section essentially identical to HF50, including output transformer, GZ34 rectifier, etc. Includes all-feedback equalizations (5 pos.) & tone controls. Centralab loudness control & separate level control that does not affect response at any setting. Cathode follower output to tape. Correct input loading for new ceramics. Zero cross-talk. Bi-amplification input & output facilities. 8 1/2" x 15" x 10". Matching Cover E-1, \$4.50.

HF12 12-WATT Williamson-type INTEGRATED AMPLIFIER
KIT \$34.95 WIRE \$57.95
Complete with Preamplifier, Equalizer & Control Section. Equalized direct tape head & magnetic phono inputs. Power Output: 12 w cont., 25 w pk. 1M Dist.: 1.3% @ 12 w. Freq. Resp.: 1 w; ±0.5 db 12-75,000 cps; 12 w; ±0.5 db 25-20,000 cps. 2-EL84, 3-ECC83/12AX7, 1-EZ81.

HF51 TWO-WAY SPEAKER SYSTEM \$39.95 complete with FACTORY-BUILT CABINET
Jensen heavy-duty 8" woofer & matching Jensen compression-driver exponential horn tweeter. Smooth clean bass & crisp, extended natural highs. Overall response: ±6 db 70-12,000 cps. Power-handling capacity: 25 w. Impedance: 8 ohms. Bookshelf size: 23" x 11" x 9". 25 lbs. Wiring Time: 15 min.

EICO®
84 Withers St., Brooklyn 11, N. Y.
® Prices 5% higher on West Coast

article used point-to-point wiring and typically used deep (thick) chassis to leave working room for circuit "improvements." EICO typically used high-quality rectifier and output tubes including Bugle Boy (Amperex) or Mullard EL34/6CA7s and 5AR4/GZ34s.



EICO started advertising their first audio amplifier kit, the HF20 (\$49.95), in early 1955. The HF20 was a 20-watt integrated ultra-linear amplifier featuring a very high-quality Chicago output transformer. The frequency response was 15-30KHz +/- .5 DB. Other features were a dual-input phono section and a four input line stage. Controls included function, variable loudness, volume level, bass and treble. The power supply featured a 5U4GA full-wave rectifier and DC filament voltage on the line and driver tubes to reduce hum. The phono and preamp stages consisted of two 12AX7/ECC83 and two 12AU7/ECC82 twin triodes. The output stage used push-pull 6L6GBs or 5881s. All of this was mounted on a heavy gauge cadmium-plated chassis, finished in the standard EICO baked metal-luster statuary dark bronze finish, with an embossed brushed brass control plate.

The mid-Fifties were really the Golden Age of HiFi. Then, as today, component hi-fi companies were coming out of the woodwork. Many companies offered several types of equipment, including amplifiers, preamps, tuners, receivers and speakers. EICO management felt that in order to capture a wider



cross-section of the hi-fi market, they would offer preamps, tuners, speakers and amps in several power ranges. The new designs were developed in late 1955 through early 1957, when EICO introduced a complete line of tube hi-fi components available either as kits or factory assembled. The following are descriptions and pictures of the EICO mono line manufactured from 1957 through 1961 (stereo units will be described in a future issue).

People on a limited hi-fi budget were always in need of a small but good sounding amp package. The HF12 (\$34.95) fit this bill very well, producing 12 watts using a pair of push-pull EL84/6BQ5s driven by 12AX7s. The HF12 was a compact flat unit meant for music lovers with a minimum of available space.



Eico's smallest basic amplifier, the HF14 (\$23.50) was an excellent amplifier employing a push-pull EL84 output stage. The EL84 is a very sweet and liquid sounding tube and, coupled with the wide-range transformer, produced an outstanding frequency response of 10Hz to 100kHz +/- .5DB. The voltage amplifier and phase inverter was a single 12AX7/ECC83 and the rectifier was a single EZ81/6CA4. The HF14 is an excellent high frequency amplifier for bi-amped or tri-amped horn systems.

The HF22 (\$38.95) was a top quality amplifier in its day, essentially the same in design as the HF50, except that its output tubes were self-biased 6L6GBs and the rectifier was a 5U4GB. The rated power was 22 watts RMS and the frequency response was 5 to 100 kHz at rated power +/- .5 DB. Typical for its day, the HF22 had 20 db of feedback. The front-end circuit included an EF-86 pentode voltage amplifier and a 6SN7GTB cathode-coupled (long-tailed) phase inverter which, to this day, is an excellent circuit design.

Very unique to the EICO high-fidelity line was the HF30 (\$39.95) power amplifier. Employing a quad of EL-84 output pentodes in push-



pull parallel configuration, it produced 30 watts RMS. The HF30 employed a very high-quality Chicago output transformer with extensively interleaved windings and grain-oriented steel laminations. The power supply featured two EZ-81/6CA4 rectifier tubes and ample filtering. The front-end tubes were a single 6AV6 and a single 6C4 triode.

The HF32 (\$57.95) mono integrated amp used PPP EL84 and produced 32 watts. Controls included function, bass,



treble, loudness and level. The HF32 had the same output stage design and power supply as the HF30.

In the same design configuration as the HF22, the HF35 (\$42.95) featured self-biased EL34s producing 35 watts RMS. The output transformer was a very high quality Chicago Standard Transformer Company unit in ultra-linear configuration. The output stage was self-biased, push-pull EL34/6CA7s. The front-end was identical to the HF22, but the power supply used a larger transformer and a slow-warm-up GZ34/5AR4 rectifier tube. Many EICO fans feel that the HF35 was their best sounding amp.



To this day, the HF50 (\$57.95) was a brilliant performing amplifier featured push-pull EL-34s in fixed bias mode. The front end was similar to the HF35, but the output tubes used fixed bias and had a higher B+ voltage. The rectifier was a 5AR4/GZ34. The output transformer was a gray-colored higher power unit rated at 50 watts RMS. This transformer had an exceptional frequency range and was one of the better vintage units available.

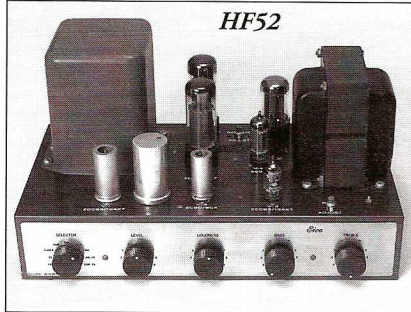

The HF52 (\$69.95) was a high-powered integrated amplifier producing 50 watts RMS. Upgraded features included push-pull, ultra-linear EL34/6CA7 output pentodes operated in fixed-bias mode. The front-end included two phono inputs and four line-stage inputs. Front-end tubes included two 12AX7s, one 6C4 and one 6CG7 (phase inverter). The rectifier was the slow-warm-up GZ34/5AR4. The power transformer was a beefier unit than the one on the HF20 and the output transformer (gray finish) was the same unit as the HF50, an extremely high-quality unit employing grain-oriented steel, extensively interleaved windings, fully potted in a seamless steel case.

Rounding out the EICO mono power amplifier line was the HF60 (\$72.95), essentially the same as the HF50, except that it featured a potted Acrosound TO-330 output transformer. Acro manufactured this transformer with the finest and costliest materials on special winding equipment, using unique and patented design methods. Even today, the TO-330 is one of the most sought-after vintage transformers. The HF60 was rated at 60



watts RMS. Like the HF50, the HF60 featured DC bias and balance adjustment pots on the top of the chassis.

EICO's first separate preamp was the HF61 and was available either as a self-powered unit (\$29.95) or powered (\$24.95) through the octal socket on their power amps, which supplied filament and B+ voltage.

A later preamp was the HF65 (\$24.95) which was more compact than



the HF61. This unit was also available as self-powered or powered through the power amp from an umbilical cord and octal socket. Tubes used were three 12AX7/ECC83s.



FM radio began to expand in the mid-Fifties and EICO wanted a piece of the action. Their first FM mono tuner was the HFT90 (\$39.95). A very compact, self-powered unit, the HFT90 featured a unique fluorescent "!" tuning indicator that doubled as the station indicator. These tuners are still very common and can still be seen at many electronic swap meets, probably because they can be unstable and prone to drifting.

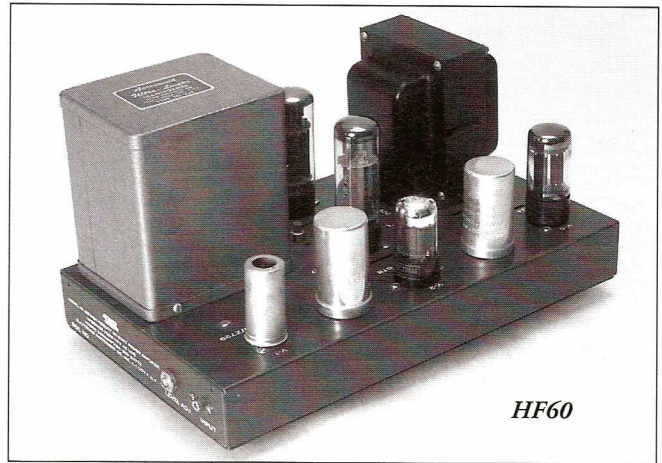

A later rendition of this tuner was the HFT92 (\$49.95) AM and FM mono tuner. The circuit of the HFT92 is similar to the HFT90, but includes AM circuitry. These are less common than the HFT90. EICO also produced an AM-only tuner, the HFT-94 (\$39.95) which is extremely scarce.

In the 1950s, EICO also produced two different types of speaker systems. The first, HFS1 (\$39.95) was a two-way bookshelf offered as a kit. It featured an 8-inch low frequency driver and a horn driver for the highs. The other was the HFS2 (\$139.95) and used a slot-loaded split conical bass horn with an 8.5-inch cone woofer. The tweeter was a suspension type using a spike-shaped driver. The HFS2 was a highly rated speaker in its day. It is very scarce now.

The EICO Sound

The EICO amps in this article can sound great if properly restored and equipped with high-quality vintage NOS tubes. Avoid adding huge amounts of filter capacitance and cutting extra holes in the sheet metal. Check all resistors, especially in the phase inverter circuits for drifting values, replace as needed. Install modern high-quality film and foil capacitors in the coupling, by-pass and tone control circuits. Use with good, efficient speaker systems for best results.

EICO tube mono equipment was listed in their catalogs through 1961 and was probably in inventories in many retail outlets through the 1960s. If you happen to find an unassembled EICO kit, DO NOT assemble it, as it is worth almost twice as much to collectors in unassembled form.

The tube stereophonic equipment produced by EICO will be covered in a future issue of VTV.

The Audio Test Bench

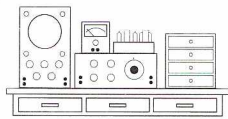

by
John Atwood

This is the second article in the Audio Test Bench series.

One of the first measurements to be made when testing or repairing electronic equipment is either resistance or DC voltage. Therefore, one of the most common pieces of test equipment is a DC multimeter. These can vary from tiny hand-held units to large bench-top models. While single-scale meters ("panel meters") can be used, their single range and low impedance make them impractical for general purpose use. The meters covered in this article are general-purpose with multiple ranges. Virtually all of these meters also take AC voltage measurements, but the issue of AC measurement will be covered in the next article in this series.

DC Measurements

There are three types of DC measurements commonly performed: voltage, current, and resistance. The important parameters for each of these measurements will be described below. It will become clear that not all meters are created equal, and that a meter that is perfectly fine for one application may be useless for another.

DC Voltage

A DC voltmeter measures the potential difference between two points without perturbing the circuit under test. In order to take the measurement, the DC voltmeter must extract some electrons from the circuit, though (i.e. draw some current). This means that the meter has a finite internal load resistance (R_L in Figure 1) that shunts the circuit being tested. R_1 and R_2 are the resistances in the circuit under test. R_L shunts R_2 , resulting in a reduction of the measured voltage, E_m . To avoid an incorrect measurement, R_L should be at least several orders of magnitude higher than the impedance of the circuit being measured.

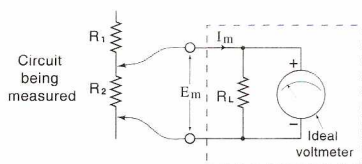
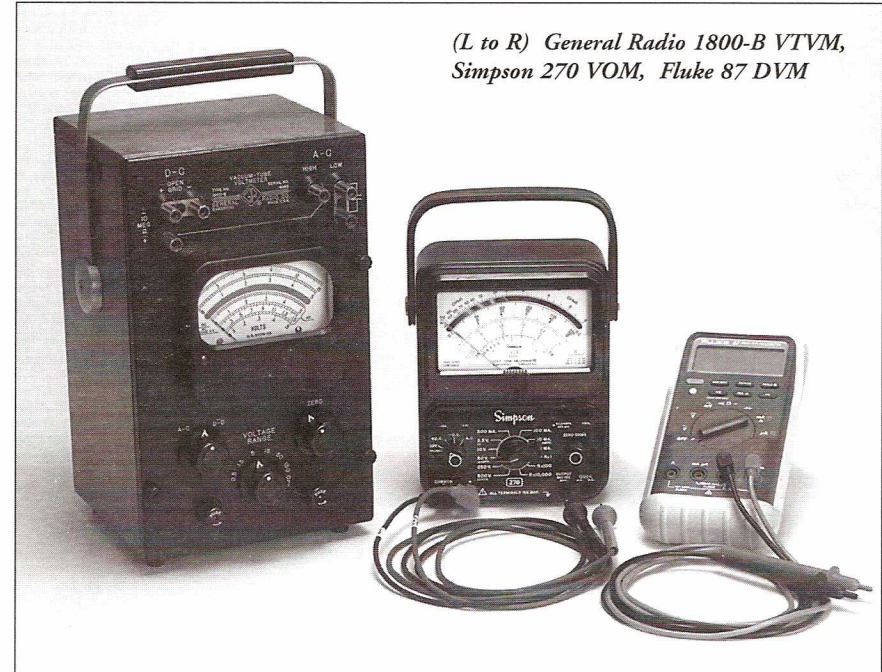

Figure 1 Voltmeter equivalent circuit



(L to R) General Radio 1800-B VTVM, Simpson 270 VOM, Fluke 87 DVM

DC Current

A DC ammeter measures the flow of current in a circuit, and must be inserted in series with the current flow. In order to take the current measurement, the flow of electrons must be impeded just a bit. This results in a non-zero series resistance (R_S

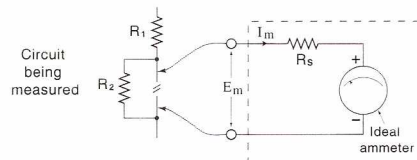

Figure 2 Ammeter equivalent circuit

in Figure 2) that will cause a voltage drop in the circuit being tested. R_1 and R_2 are the resistances in the circuit under test. The internal meter resistance R_S causes some of the current to flow through R_2 , altering the desired current reading. To avoid measurement errors, R_S must be several orders of magnitude smaller than the impedance in the circuit being measured. Since breaking a circuit to insert an ammeter is often difficult, a convenient technique for measuring current is to insert a small, accurate resistor permanently in a circuit, and measure the voltage drop across the resistor. Reminder: Ohm's law says $E=I \cdot R$, i.e. voltage (in volts) equals current (in amperes) multiplied by resistance (in ohms).

DC Resistance

Resistance can be measured either by measuring the voltage drop in a circuit

given a known current, or by measuring the current in a circuit with a known applied voltage. When a circuit is in use, resistance can be inferred from voltage and current measurements. However, a stand-alone ohmmeter is nearly always used on a powered-down circuit or a component in isolation, because the voltages and currents in a "live" circuit would disrupt the measurement, if not damage the ohmmeter.

Most ohmmeters work by applying a fixed voltage to the circuit (often through a series resistor), and measuring the resulting DC current. An ideal ohmmeter would apply zero voltage, and be able to measure infinite resistance. Due to practical limitations in meter sensitivity, a non-zero voltage is needed, often increasing when measuring high resistances. For perfectly linear circuits, the applied voltage is not much of a problem (except for possible damage to very sensitive components), but if semiconductors or other non-linear elements are present, the applied voltage is important. If the applied voltage is less than a diode turn-on voltage (about 0.2 volts for germanium and 0.6 volts for silicon), then the semiconductor will not conduct. If above the diode turn-on voltage, then the semiconductor junction comes into play; the reading is no longer linear and the polarity of the ohmmeter makes a difference. For pure resistance checks in solid-state circuits, a low (< 0.2V) applied voltage is desired, but a higher voltage (such as the 1.5V common in most VOMs) is helpful in testing diodes and transistors.

Meters

DC meters fall into three main classes: passive analog, active analog, and digital. Digital multimeters are becoming the most common today, but the older analog meters are still quite usable, especially where the delicate needle movements are important, such as in receiver alignment.

Volt-Ohm-Milliammeters (VOMs)

The mechanism used in virtually all analog DC meters is the "Weston movement," which is based on the D'Arsonval galvanometer. A coil of very fine wire is suspended in a strong, even, magnetic field. As current flows through the coil, the coil rotates, moving a needle across a dial. The energy to push the coil against a restraining spring and overcome friction is supplied by the circuit being tested. If used as a voltmeter, a resistance is added in series with the meter movement. The overall shunt resistance (RS) of such a meter is relatively low, however, for a movement with a given sensitivity, the shunt resistance will increase as the meter is switched to higher voltage ranges (more resistance is added in series with the meter). For this type of meter, the shunt resistance is measured in "ohms per volt." Cheap meters may have 5,000 ohms per volt or less, while most standard VOMs have 20,000 ohms per volt. To calculate the shunt resistance of the meter, simply multiply the ohms per volt by the voltage scale. For example, a 20,000 ohms per volt VOM set to the 150 volt scale would have a resistance of $20,000 \times 150 = 3$ megohms. At the 1.5 volt scale, though, the resistance would be only 30K ohms. Connected to a tube amplifier with a 1 megohm grid resistor, any coupling capacitor leakage would be swamped by the meter loading.

The ammeter section of VOMs simply puts various low-value shunt resistances in parallel with the meter movement. However, the amp or milliamp scales are most susceptible to damage — typically when the VOM is used as a voltmeter while still set to the milliamp scale. Good meters have fuses to protect the meter against overvoltage or over-current. Some even have resettable overload relays. However, the delicate nature of the Weston meter movement is most exposed in the VOM.

The ohmmeter section of the VOM is "backward-reading," meaning zero ohms is located at the right-hand end of the scale. A "Zero Adjust" control is needed to compensate for the aging of the internal battery. Some VOMs use a high volt-

age battery (15 or 22 volts) on the highest ohms scale, which can be dangerous for some solid-state circuits.

The classic American VOMs were the Simpson 260 and Triplet 630. They are electrically quite rugged, but the bakelite cases tend to crack with abuse. Weston



Heath IM-11

made a good VOM in a rugged Cyclolac plastic case, which was also sold as a kit by Heathkit. Small portable meters include the Simpson 160 and the Triplet 310. Many Asian meters, ranging in quality from terrible to excellent, were made at much lower costs than the American equivalents. However, even the best were generally less rugged than the better American models.

The low and varying load resistance of a VOM make it difficult to use in the high impedance circuits typical of tube amplifiers. That's why the VTVM, described in the next section, was developed. In the tube era, VOMs were typically only used for non-critical tests, heavy-duty industrial use, or where portability was crucial. However, with the advent of bipolar transistors, VOMs enjoyed a resurgence, since the low impedances of transistor circuits permitted VOMs to be used without excessive circuit loading. Nowadays, the VOM has been supplanted by the DVM. However, ruggedness and simplicity still make the VOM useful for basic measurements.

The Vacuum Tube Volt Meter (VTVM) and Solid-state Equivalents

The need for a voltmeter that doesn't

load the circuit being measured led to the development of the vacuum tube voltmeter (VTVM). Actually, the term vacuum tube voltmeter refers to many circuit topologies, but the circuits most commonly used in commercial VTVMs are a differential amplifier or differential cathode follower. The input impedance of a VTVM is theoretically limited by stray leakage and grid currents in the input tube. For extremely low current measurements, special electrometer tubes are used, but in conventional VTVMs using receiving tubes, the input impedance is typically set to 11 Megohms, and is constant for all voltage ranges. This is high enough to provide accurate measurements for most normal audio circuits. Some VTVMs provide additional DC amplification, which allows accurate measurements down to a few tenths of a volt or less. However, the difficulty of implementing stable vacuum tube DC amplifiers limits this feature to more expensive lab instruments. Even in simple VTVMs, drift is a problem, and "Zero-adjust" controls are always provided.

All general-purpose VTVMs also have AC meter ranges that use a vacuum-tube diode as an AC rectifier. Often this diode is mounted in a test probe to permit accurate readings of RF voltages without excessive capacitive loading. Many VTVMs also have ohmmeter ranges as well. The added sensitivity of the basic VTVM circuit typically allows a single 1.5V battery to power all ohmmeter ranges. Current ranges are rarely included in VTVMs.

Because the meter movement in a VTVM is isolated from the circuit under test by a tube amplifier, VTVMs are electrically quite hardy, and can withstand overloads better than most VOMs.

Nearly all test equipment manufacturers produced VTVMs. Some of the most common service-grade VTVMs include the RCA "Volt-Ohmyst," the Hickok 470, the Simpson 303, and EICO 232. Lab-grade VTVMs include the Hewlett-Packard 410B and the General Radio 1800-B. Probably the most famous VTVMs of all time were the series of Heathkit VTVMs. Heathkit's original VTVMs, dating from the late 1940s, used conventional point-to-point wiring. However, in 1957 Heath brought out the IM-11, which featured a simple, effective design and PC-board construction. This meter appeared under different part numbers as Heath changed their exterior design styles, but the same basic design

(continued on page 31)

The Quest for the Ultimate

by David Wolze

In the world of vintage audio amplifiers, arguably the ultimate is the McIntosh MI-200 industrial-grade power amplifier. The "Big Mac" is easily the biggest, baddest triode amplifier ever manufactured in quantity. It certainly warms the cockles of my heart with its two-hundred-plus watts of butt-kicking spine chilling tube-audio power!!

Getting Mac'd

Of course, getting something like this is not that easy. In fact, my quest to have a pair of these bad boys in my music room could be called the Raiders of the Lost Amps. The adventure started with a visit to Eric's stomping grounds in Albuquerque. Rumor had it that CW, a friend of Eric's, had a pair available in the highlands just outside of town. Eric, Charlie K. and I drove miles through a rainstorm in the dark of night to visit CW, who lives in a mostly abandoned housing project.

According to CW, these amps had once belonged to the Grateful Dead. However, they had seen better days. One of the Macs looked pretty good; it was missing only the cover plate for the power supply chassis. The other amplifier was a basket case, though. The output tubes were burnt out, indicating major problems. It had no front panel, and, worse, it had no meter control panel.

I was having a Mac attack, though, so I ponied up \$1500 to CW. Charlie, Eric, and I then hauled 300 pounds of Dead Mac into the trunk of the rental car. I packed them up and gave Eric a couple hundred bucks to cover the cost of shipping the amps to California. CW had told me that the basket case amp had a burnt-out output tranny, so I called around to locate a replacement. Eventually, I contacted 'Doc' Hoyer; sole proprietor of Audio Transformers, near Milwaukee, Wisconsin. The Doc is probably the only man who can do the MI-200 transformer rewind. 'That will cost you a grand', he said. I packed the bad transformer up and shipped it to Wisconsin.

Revival of the Fittest

With the larger problems of getting the amps and restoring the bad output out of the way, I began the detailed restoration of the MI-200s. The first job

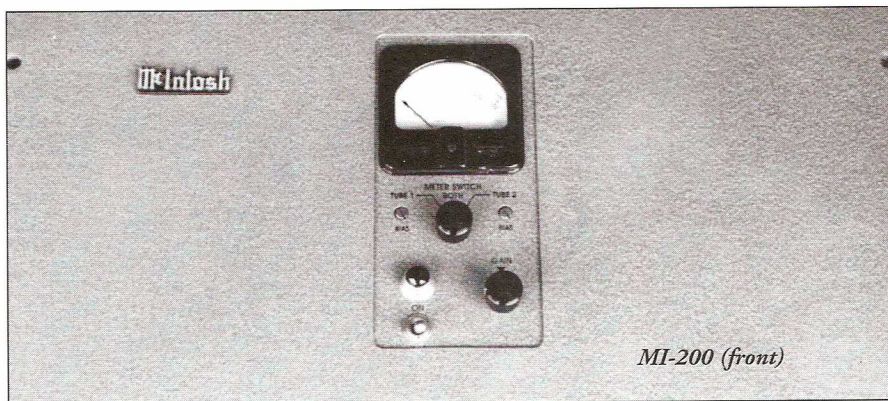

MI-200 (front)

I tackled was the control-panel wiring harness which was missing from the bad amplifier. Fortunately, I had one meter; I disassembled it and Xeroxed its faceplate. Eventually, I located an old VU meter, which was a perfect match except for its faceplate. The Xerox image was carefully glued into place, transforming the VU meter into an MI-200 bias meter.

With the meter squared away, the balance of the control panel wiring was completed. A couple of high quality Bourns 100 K linear pots were wired in to provide the bias control, and a Grayhill 3-position, 2-pole rotary switch was wired as shown in Figure 1, to simulate the function of the original bias selector switch. Another Greyhill switch and a couple more Bourns pots were wired into the original control panel as well.

Power Supply Rebuild Kinks

Now it was time to restore both of the power supply chassis. The filter caps were pulled and carefully disassembled so that I could reuse the cans. 220 uF at 450 volt caps were used, as well as a 47 uF at 450 volts. Each cap took over two hours to do; there are eight in a pair of MI-200s. But it was worth it; the fresh caps cannot be discerned from stock units, and they boast nearly twice the capacitance.

To reduce heating, I decided to add solid-state rectifiers to the power supply. I consulted my tube manual to determine resistance to add in series with the silicon diodes. The 150 ohm resistors for the 5U4 bridge rectifier are placed on the cathodes of the output tubes to improve bias stability. This mod saves 160 watts

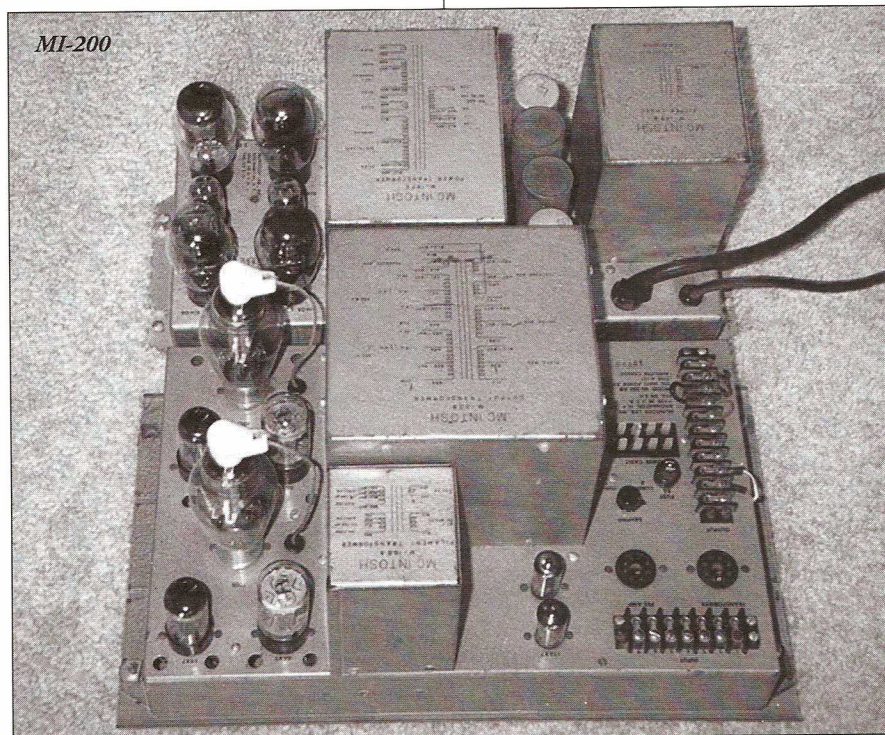

MI-200

M C I N T O S H M I - 2 0 0

MCINTOSH LABORATORY, INC.
 2 CHAMBERS ST. BINGHAMTON, N. Y.
 MI-200-AB SCHEMATIC
 SERIAL NO 2401 B UP MI-200-27

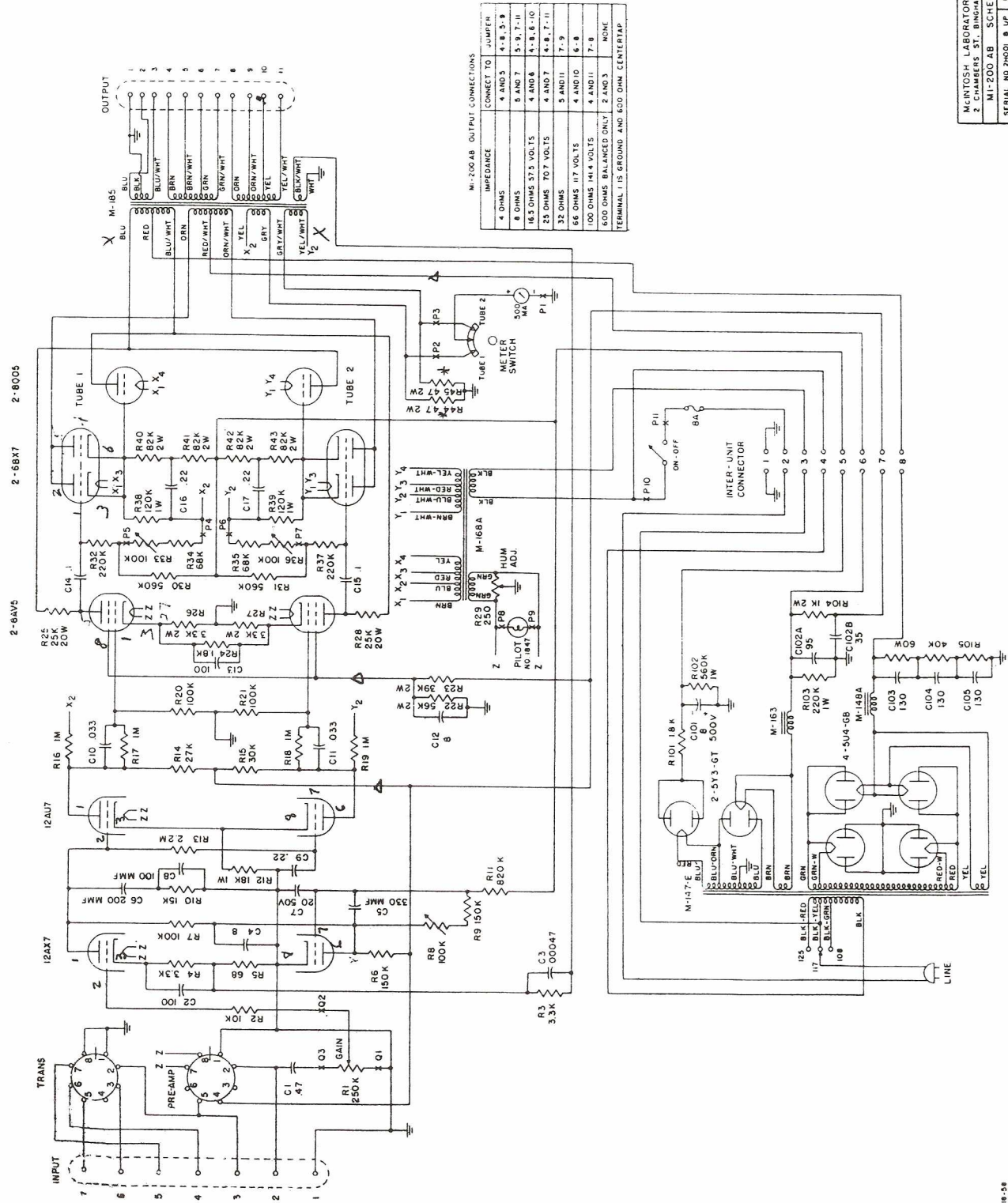

IMPEDANCE	CONNECT TO	JUMPER
4 OHMS	4 AND 5	4-B, 5-B
8 OHMS	5 AND 7	5-B, 7-B
16 OHMS	5 AND 8	4-B, 8-B
25 OHMS	4 AND 7	4-B, 7-B
32 OHMS	5 AND 11	5-B, 11-B
66 OHMS	4 AND 10	4-B, 10-B
100 OHMS	4 AND 11	4-B, 11-B
600 OHMS	BALANCED ONLY	2 AND 3
NONE	TERMINAL 1 IS GROUND AND 800 OHM CENTER TAP	

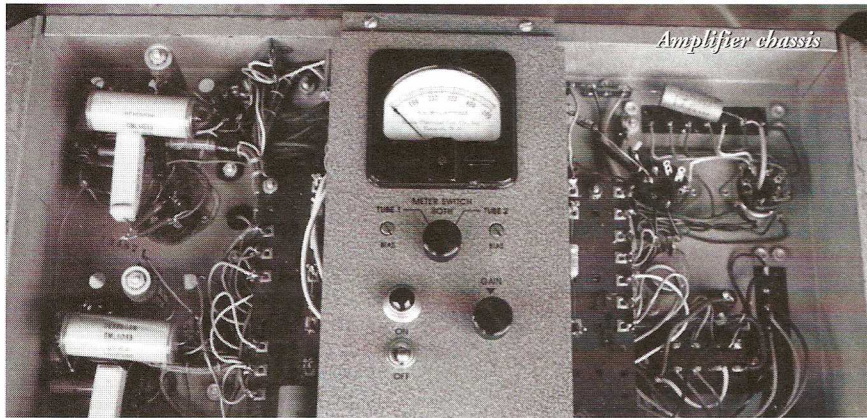

of filament power on the pair of amps, and it improves bias stability. If I wish to show the amps off, the 5U4s and 5Y3s can simply be plugged into their sockets and run.

Chassis Restoration

Audio Classics had a power supply front panel; I ordered it. Then I took it and the sheet metal from the good chassis to Phoenix Industries, a sheet metal shop in Mountain View, CA. To duplicate the entire set and repaint and silk screen everything would be \$500, Phil at Phoenix said.

Restoring and Hot Rodding the Amplifier Chassis

Since CW had performed extensive mods to the good amplifier electronics, I felt no need to preserve its authenticity. So I decided to do a complete hotrod on the electronics, exchanging every resistor for a 1% metal film type, and upgrading all caps as well. The output grid caps were upgraded to vintage mil spec oil-filled glass types, the inputs were Vitamin Q'd,

and polyprop and tantalum caps were used in between.

To preserve that vintage look, I rummaged some equivalent value vintage electrolytics and prepared them as follows: A screwdriver is used to pry the bead on the end of the cardboard tube open, then the old cap is slid out. The ends of the old cap are cut off about 3/16" from the end, and the middle is discarded. Then the ends are cleaned, their leads cut off flush, and a 1/32" hole is drilled in the middle to allow the new cap lead to come through. Then the 3 pieces are reassembled into the cardboard tube, observing polarity.

Finally the bead is recrimped, and the leads pulled to position the endpieces.

Powering Up the Mac

Power was applied slowly with a Variac. Everything came up well, but there was some low level noise and a ping-pong sound every few seconds. The ping-pong was traced to the front end power isolation circuit which did not like the new

low leakage capacitors. A 120-volt Zener fixed that problem. The noise was traced to a bad 12AU7.

The Mac in the Test Lab

With the amp running, I was curious about its performance. Square wave testing at about 25 watts was conducted first. 5 kHz, 10 kHz, even 20 kHz square waves were perfect; sharp corners and no ringing whatsoever. Power was a good 200 watts, no problem. Truly this was a legend revived; I had never seen a tubed amplifier perform so well on the bench.

A First Listen

Still missing the output tubes and transformer for the second amplifier, I recruited my Citation 2 to back up the first Mac for a stereo listening session. Its sound was significantly better than that of the Citation. The lows and highs were effortless, and the sound stage was bigger and better.

Bringing the Second Mac Up

I rebuilt the second chassis in the same manner as the first. This unit was lacking the output transformer and the output tubes. The transformer I had under control, but getting the obscure 8005 transmitting triodes that Mac used on this amplifier was proving to be a problem. Perusing the transmitting tube manual, I discovered that 812s would on paper substitute very well. I tried them in the good amplifier; handling the filaments was simply a matter of disconnecting the 10-volt tap and running a wire from pin 8 of each 6BX7 drive tube filament. Power was good, but I still did not like the bias instability.

Give Your Equipment a Solid Foundation

with P.S.I Power Conditioners

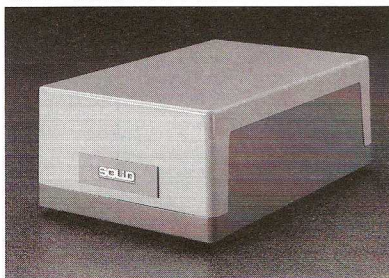

Power Science Industries now has 2 models designed to give your equipment a Solid Foundation of Power.

- Improves Power Factor and Reduces Digital Noise
- Cancels Even and Odd Order Harmonics
- Waveform Correcting

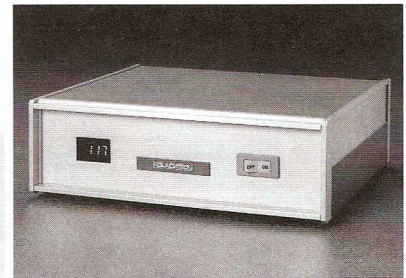

For more information contact *Power Science Industries at:*

P.O. Box 51226
Palo Alto, Ca 94303

Call or FAX :
415-424-0217

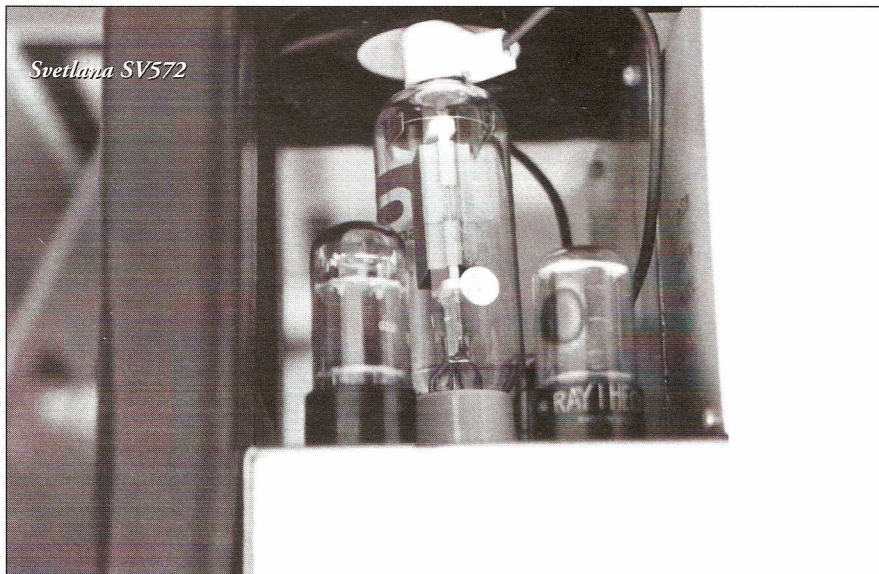

BRIEF HISTORY OF THE MI200 by C. Kittleson

The first version of this amplifier was the K-107, introduced in 1953. It was a 200 watt RMS power amplifier using a separate chassis for the power supply. Output tubes used were a pair of the RCA Type 8005, originally used in World War 2 in aircraft transmitters. Other tubes included a 12AX7, 12AU7, two-6BL7 pre-drivers and two- 6AV5 cathode-coupled drivers. The K-107 power supply featured four-5U4Gs and one 5Y3 rectifier tubes. Both chassis weighed in at 140 pounds! These amps were originally used as recording head cutter amplifiers, high quality sound reinforcement and for industrial applications including shaker tables for vibration analysis in aircraft and missile construction.

As the need for higher quality cutting head amplifiers increased with more high fidelity LP releases, McIntosh introduced an upgraded version, the K-1000. Mercury Records and many other labels used the K-1000 as the cutting head amplifier for their high quality releases. Some of the K-1000 amplifiers were available in either 8 ohm, 150 ohm or 500 ohm output impedances, depending on the needs of the cutting head setup. The K-1000 was made from 1956 through 1958.

The final version of this amplifier design was the MI-200AB, made from 1959 through 1966 and probably the most common available. MI stands for McIntosh industrial and that is typically where many of the MI-200s are found. Aerospace, airplane and other defense contractors used the MI-200AB for shaker tables and other vibration analysis applications. Some versions of the MI-200 had a plate current panel meter and some did not. Some versions featured a 4, 8 and 16 ohm output transformer and some had a higher (500 ohm, etc) impedance.

This bias instability was present even on the stock 8005s in the good unit. In fact, my opinion was that the bad amp had suffered thermal runaway as the Grateful Dead was jamming it at a concert. This burnt out the output triode and overheated the tubes.

The Right Tube is Found

I tried substituting 811s for the 812s. The bias circuit had to be modified slightly to accommodate the 811s. See Figure 1 for the modifications that were done to accommodate using 811/572s in the Mac. The bias drift was totally eliminated. I noted that the 572s were much more consistent as to their bias point as compared with the 811s. Another slight problem with the 811s is the lower plate dissipation rating as compared with the 8005s. If you want to be cheap, you can use the 811s, but run them at 40 mA per tube idle.

However, the RIGHT tube for the "Big Mac" is the Svetlana 572. Featuring a beefy graphite plate, this tube has TWICE the plate dissipation rating of the 8005. The 572 is beautifully made, and the bias is rock steady. A further advantage is that you may run the idle current to 60 or 70 mA per tube to improve fidelity. George Badger of Svetlana says that the 572s are going to be priced at \$70.00. Power output is the same with the 811s or 572s as the 8005s, and the Unity Coupled output circuit eliminates any need to change feedback circuitry.

The Second Mac Comes Alive!!!

It had now been over a month since the Mac output had been sent to the

Doc. He called to inform me that it was on its way to California. It arrived about a week later, and it was installed on the second chassis. Now the 'bad' chassis was finally restored, with new output tubes and an output transformer.

With baited breath, I brought the second Mac up on the test bench. Everything was OK, but high frequency instability was seen on the output. To fix this, I connected a 300 pF cap from the plate (Pin 1) of the 12AX7 to ground. The old compensation network was disconnected.

The Mac Blast

The sheet metal was not ready yet; but the amps were ready to go! After listening to them for awhile at my place, I brought them up to Charlie Kittleson's. Charlie had some Acoustat 2MH electrostatic speakers and a modified Scott LC-21 preamp. Ron from the Tube Club was there too. The amps were ugly, but they powered up OK.

The lights dimmed as the Macs worked the electrostats. Now, Charlie has had many high quality amplifiers go through his establishment, but we all agreed that the Macs were in a class by themselves! Their sound stage was almost galactic in its dimensions.

Finishing Up

The sheet metal came in, and so I started to design a pair of racks to mount the amplifiers. I decided to mount the amplifier section horizontally so that I could see the output tubes glowing. The racks, made of two by fours, also mount a fan which blows on the output tubes to preserve them and keep the chassis cooled. The fans are 12 volt units which are operated at 8 volts to keep the noise down. The mounting racks really provided an excellent finishing touch to the Macs.

I have run the Macs for quite a while now in my listening room. With the new racks and sheet metal, they look good, considering that they are commercial amplifiers. They sound simply wonderful, and I like to brag that when the bias meter starts to move, a Mac 240 would be into clipping!! Although I was eventually able to get enough 8005s, I kept running the 572s due to their superior stability and availability.

Since I had to rebuild the second chassis so extensively, I found that its possible to build "Big Macs" from scratch,

(Cont. on Page 34)

Tube Industry News



by
Eric Barbour

A New EL34 from Svetlana

Svetlana's new EL34 was officially released as of August. The final version was sampled to VTV, and tested on my bench setup in the same way as the EL34s in Issue 2's survey. These units, unlike the pre-production samples we saw in April, have both 2 pill getters mounted on the plate sides plus a flash getter covering the top dome of the envelope. Otherwise, hard glass was used but the other details are very similar to the late type III Mullard.

Test of Production Svetlana EL34S

500V 75 mA PENTODE CONNECTION, 1000 HZ, PLATE LOAD 3200 OHMS:

Sample	Distortion	Screen	Hot Spot?
sample 1	0.55%		no
sample 2	0.58		no
sample 3	0.52		no
sample 4	0.54		no
average:	0.5475		
average peak pwr: 13.5 v rms			

From a distortion standpoint, comparing this tube to other EL34s would place it just below the later Telefunks and slightly above the 1990s' Tesla EL34. It just noses out the Tesla to get the honors as the world's current best.

It was a close race, and the Svetlana/R&G people are to be congratulated for pulling it off. It was a special pleasure to see that they have used gold-plated wire for their grids. This will help considerably in making the tube more rugged in guitar-amp service. Still, we have to recommend that guitarists seriously consider the modifications shown in the EL34 article in Issue 2. Even a tube this good can be destroyed by some high plate voltage guitar heads, including some Marshalls, the Music Man 130 and the Seymour Duncan Convertible.

New 6B4???

Some of you have heard about a government-surplus 6B4G that is being sold in large quantities by certain dealers. VTV has obtained one of them, and as you can see in the photo, it does not look like a 6B4. In fact, its resemblance to a 6AV5 is quite pronounced. This one was dated 1981 and was made by Sylvania.

It seems that Uncle Sam wanted a 6B4G as a modulator driver to keep some old radio gear running, but the major tube factories didn't have the tooling to produce 2A3-family triodes. Sylvania cheated a bit, rebasing a 6AV5 and connecting an internal strap between the plate and screen (photo), and strapping one side of the filament (pin 2) to the cathode. John Atwood has run this thing on his curve tracer, and is certain that it is a triode-connected 6AV5 or similar sweep tube. The curves of a real 6B4G were similar to the "new" 6B4G, and a real 6AV5 in triode connection gave almost identical curves. If you buy this thing, be warned. It may work OK in a 6B4 amplifier without mods, but it will not sound like one. Its heater-cathode construction, with one end of the heater connected to the cathode, can be a major source of hum, unless the heaters are run off of DC. The 6AV5 is a fine tube and widely overlooked in audio; any serious experimenter would be well advised to try it, it is cheap and easy to get. Trying to use this surplus "triode" in a DHT amplifier may be disappointing. If you would like to try triode-connected beam tubes in your triode amp, there are less expensive ways of doing it.



New 6B4G 6B4G 6AV5

Rumor Dept:

Supposedly, Tesla is planning to produce a KT-88 very soon. Why they are doing it is a mystery, they were doing well with their only products, EL34s and E34Ls. Perhaps the competition was too much for them? There are also persistent whispers about Genalex going back into KT-88 production; details are non-existent, as the dealers in the know are being secretive.

Checking Out the Single-Ended 300B Iron

There are many companies now trying to compete in the market for tube outputs transformers. After years of decline, suddenly there are numerous brands available. Most of the new companies are addressing the growing market for single-ended transformers, a speciality which did not exist in the USA only five years ago. In 1990, if you wanted to build an

SE amplifier using a 300B triode, basically you bought Japanese (Tango, Tamura) or British (Partridge). Today there is a dizzying array of choices, all a little different from one another. What to do? (See Charlie's accompanying article covering SE listening impressions for his thoughts on transformer sound qualities.)

Remember, sound quality is very subjective, especially when it comes to SE amps. However, in spite of the claims of some "experts," there are a few electrical tests we can perform which can give some idea of which transformer is likely to give good performance (or, at the very least, we can tell what the designer had in mind). We obtained samples of most major brands of SE 300B transformers, and tested them for two major parameters:

a) Primary inductance - this is an indication of the ultimate bass extension of the iron core - a perfect tranny would have an infinite primary inductance, which does not change (due to core saturation) as the standing DC plate current increases. In the real world, the maker must choose a set of compromises due to conflicting technical problems.

b) High-frequency response - With an actual tube hooked up and biased, the upper limit will eventually roll off. This would be at infinite frequency if we had a perfect transformer; but again, making a real-world product forces compromises.

This report will cover only the most popular 300B models sold by each company. The **MagneQuest FS030** is well-known and heavily advertised, but its data sheet indicates that it is intended only for one regular 300B, and only for operation at 60 mA maximum. The other transformers specify more primary current, and the non-potted ones obviously have larger air gaps than the FS030. The **Electra-Print VT2KB** is meant for the Vaic VV30B (it works fine with the 300B) and is rated at 160 mA (and, at 14 pounds, is easily the biggest and beefiest of the lot).

The **Audio Note 3K** is rated for 140 mA, and their Model Two 2.5k is rated 90 mA. **Tango's XE-60-3.5S** (their best 300B unit) is rated 170 mA. The **Tamura** is a top-line model, rated for 100 mA. The Italian-made **Bartolucci** units are new to the American market, are well-made and potted, and are rated for 90 mA. The **Tango** and **Tamura** are also potted; the **MagneQuest** and **Electra-Print** have end-bells and the **Audio Notes** are open frame.

These transformers generally were supplied with minimal data. However, the Tango includes an extravagant test report in Japanese. Connecting the

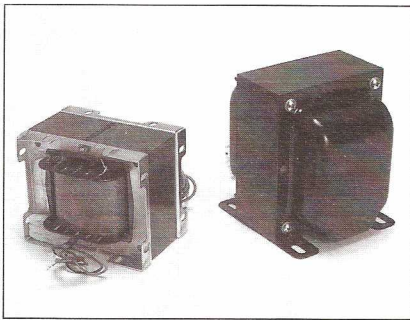

Audionote UK 2.5K and Electra-Print VT2KB

Tango and Tamura was easy and obvious, they had clearly labeled output taps for 4, 8 and 16 ohms. The Audio Notes had 4 and 8 ohms but made us decode the wire colors from the data sheet. The others had complex output winding arrangements. Electra-Print prewired theirs for 8 ohms, but it could be changed to 4 or 16 by changing winding hookups according to the included sheet (they had no lead wires, the actual enamel-coated magnet wire was brought straight out, thus eliminating one solder joint). The MagneQuest and Bartolucci units required us to study their data sheets carefully to get the output impedance right--MagneQuest used Teflon-covered wire of good quality for its leads, while Bartolucci provided brass turret terminals.



Magnequest FS-030

ELECTRICAL TESTS

The inductance readings were taken using John Atwood's transformer test set-up. We took two readings from each transformer: one with 60 mA of DC flowing in the primary, and the other with 100 mA of DC. The AC signal used



One Electron UBT-1, UBT-2

to test the inductance was 50 vrms, 1 kHz generated by a McIntosh MC-30 amplifier, and the inductance bridge was a Freed model 1110A with a Kepco regulated DC supply for the DC standing current. A General Radio 1232-A Null Meter was used to measure the bridge null.

Table 1: Primary Inductance. Arranged by decreasing inductance at 60 mA:

TYPE	L at 60 mA	L at 100 mA	% change
MagneQuest FS030	70H	41H	41%
Tamura F-2007	41H	28H	32%
Electra-Print VT2KB	37H	35H	5%
Bartolucci-16/A/Y 3K	37H	33H	11%
Bartolucci-16/A/B 2.5K	32H	30H	6%
Audio Note 3K 20W	21H	20H	5%
Audio Note 2.5k 25w	21H	20H	5%
Tango XE-60-3.5S	12H	12H	0%

If a single Western Electric 300B were to be used at 450v 60 mA, the MagneQuest and Tamura would work well. If you want to run more plate current, perhaps with two 300Bs in parallel or a single Vaic VV30B, then the Electra-Print, Bartolucci, Audio Note and Tango units would perform better, since their

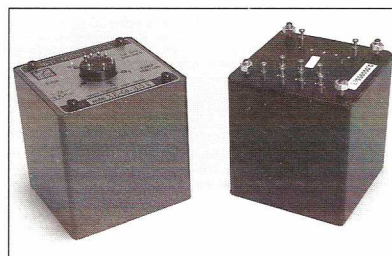

Tango XE-60 and Bartolucci 3.0K

inductance changed little as the current was increased. As we will see next, the Tango unit has relatively low inductance but excellent frequency response, so Tango apparently traded off low-end response

for high-end extension.

Table 2: Frequency Response, measured with a Vaic VV30B connected to each transformer. Level was set at 1 watt (the first watt in SE amps is most critical) into 8-ohm load at 1 kHz, then the signal generator was turned up to get the -3 db frequency, measured on an HP frequency counter. Other instrumentation as used in the 300B test article.

Table 2: High-Frequency Roll-off:

TYPE	-3db @ 60 mA	-3db @ 80 mA
Tamura F-2007	43.3KHz	45.6KHz
Tango XE-60-3.5S	42.4	42.4
Audio Note 2.5k 25w	39.4	38.7
Bartolucci 2.5k	32.9	32.9
Audio Note 3k 30w	32.4	32.4
Bartolucci 3k	31.0	31.0
MagneQuest FS030	27.0	24.8
Electra-Print VT2KB	24.6	24.6

All of the transformers went above 20 kHz at 1 watt, so none will have severe loss of high frequencies in normal use. This has not been the case with some SE transformers intended for 211 tubes, which I've tested in the past. They usually start to roll off below 20 kHz. The response should be consistent regardless of plate current, but the Tamura and MagneQuest changed slightly, again indicating that they are intended only for lower-current operation. For comparison, a Western Electric 171A (from the fabled 91A amp) rolled off at 17.1 kHz.

We tried to take distortion readings, but our attempt was complicated due to the fact that the figures varied depending on the transformer. For example, the Audio Note 2.5k should have given the same distortion as the Bartolucci 2.5k since they would present the same load to the tube; but the Audio Note gave 0.215% distortion at 1 watt/1 kHz/60 mA, while the Bartolucci gave 0.257%. This is not a major difference, but other transformers with different load impedances will alter the operating point, and hence distortion of the output tube. So the distortion might vary from one sample transformer to another, and the figures presented here cannot be 100% relied on for buyer comparison.

(SE Transformer Test Continued on Page 34)

VTV LISTENS TO SE TRANSFORMERS

by Charlie Kittleson

Our policy at VTV is to audition audio products using multiple listeners in several sessions. By doing this, we are able to get a wide variety of opinions and reduce the potential for audio hallucinations and product biases. A total of 10 different listeners gathered for three different listening sessions of the single-ended iron.

In this series of listening impressions, we obtained most of the popular, premium single-ended transformers being offered by US, Japanese, British and Italian transformer designers.

The listening set-up consisted of an all-tube single-ended power amplifier using a 300B, driven by an octal dual-triode 6EM7 and rectified by a 5U4G. This is the same test amplifier described in Eric's 300B article. We listened to different output tubes: the Shuguang 300B, the Cetron 300B, the WE300B (old version) and the VAIC VV30B and VV52.

The pre-amplifier was Dave Wolze's custom built all-octal line stage using 6SN7s, a loctal 7F8 and all tube regulation and rectification. The CD player was an Elite Electronics-modified Philips 960 or a prototype of the Dynaco CDV-Pro (tube output with HDCD). The speakers used were either the highly efficient horn-type Klipsch Chorus IIs or B & W DM110s. Program material used included some GRP recordings (Fourplay, etc.), a few classical piano CDs and the Stereophile test CD. The listening room was located in our offices in Sunnyvale.

For all of our listening sessions, we are using a SOLID line conditioner by Power Science Industries, Palo Alto, California. Our offices are located in Silicon Valley where there are thousands of noisy digital computer power supplies lousing up the line voltage. The SOLID takes care of all the line hash and really cleans up the sound.

The following is a summary of the transformers reviewed.

AUDIONOTE UK

We sampled two AudioNote UK transformers, the 2.5K (US\$140) and the 3.0K (US\$160) units. Both of the transformers are of the "open frame" construction. The 2.5K was tested with a single 300B set at 60 ma. This unit presented a balanced

sound with a solid bass and low upper-midrange distortion. Midrange seemed "just right" and the highs were not too bright, but actually sweet. A very nice transformer.

The 3.0K AudioNote unit was actually a bit better sounding with a single 300B, offering the balanced presentation with more solid bass. Overall, the AudioNotes performed quite well and were easy to listen to. Most reviewers felt the AudioNotes were the "best sound for the money."

BARTOLUCCI

These attractive transformers are hand-wound in Italy by G. Bartolucci and feature double C-core construction. They all have 4/8/16 secondaries, solid brass hookup terminals, and are beautifully potted in black, squared, all-steel cans. They are reminiscent of MC225 output transformers. The two Bartolucci units reviewed were the 2.5K Model 16/A/B (\$215) rated at 90 ma for 2A3, 300B, 6B4G, etc, and the 3.0K Model 16/A/Y (\$225) rated at 90 ma for a "91" style 300B amp design.

With a 300B set at 60 ma, the 2.5K unit had clean, balanced mid-range and crisp highs on the bright side. We did note a hump in the upper-bass range. With the VAIC VV30B set at 80 ma, the 2.5K unit displayed bright highs and what sounded like intermodulation distortion in the upper-mids. The bass was strong and tight, but sounded a bit like solid state.

The 3.0K Bartolucci sounded more balanced in amp and the highs were less tizzy compared to the 2.5K unit. With a single 300B, the 3.0K might be the way to go.

ELECTRA-PRINT

We listened to the VT2-KB Electra-Print (\$249) which is a 2.7K unit that can handle up to 160 ma. It easily won the "biggest iron" contest, weighing in at fourteen pounds. First, we tried it with the 300B and were impressed by the very balanced presentation throughout the listening range. The bass was beefy and well damped. The mids were 3D and very life-like. The highs were clear and extended. This transformer had an effortless sound quality.

Just for kicks, we tried the VT2-KB with the new VAIC VV52 Super Power Triode set at 500 volts and 100 ma. The sound was awesome with a "Big Tone" quality like no other combination in this comparison. The Electra-Print and the VV52 are the ultimate set up for amp builders who can spend some bucks.

MAGNEQUEST

The FS-030 (\$300) has been available since 1992 and is used in a lot of custom SE amps made in the US and elsewhere. We also obtained a sample of the limited production FS-030 that was wound with a special oxygen-free copper wire originally designed for cyclotron electro-magnets.

First, we tried the standard FS-030 with a single 300B. This transformer is limited to 60 ma plate current by design, so we set the current at that level using 300 volts on the plate. This transformer has a relaxed sound with nice midrange and sweet highs. However, the bass seemed under-damped and the overall sound was not as balanced as the AudioNote UK transformers.

Then we hooked the FS-030 up to a VAIC VV30B power triode set at 60 ma and 300 volts on the plate. With this combination, the bass was somewhat loose and the highs seemed slightly veiled. This is probably due to the circuit operating parameters not being optimized for the transformer.

We hooked up the limited production FS-030 with the oxygen-free copper wire and noticed a significant difference. The sound was more balanced and the bass was tighter than on the standard FS-030. We also noted that the air gap on this FS-030 was wider than on the standard one.

This may have something to do with the sound quality because all of the other open frame SE transformers we reviewed appeared to have a wider air gap.

We have no doubt that when the standard FS-030 is "tuned" to a specific amp design and speaker system, it can perform well.

ONE ELECTRON

The UBT-1 (\$95) is a 1.6K transformer that can be made a 3.2K unit by hooking an eight ohm load to the four ohm tap. In this configuration, the primary inductance is less than optimum, but this transformer has good bass response, so this is not a bad compromise. With a single 300B at 60 ma, this transformer had clear mids and highs and was very detailed, but not sibilant.

There was somewhat less bass than either the AudioNotes or the Electra-Print. We also listened to this unit through the B & W DM-110 speaker and liked what we heard. This transformer seemed to work better with a non-horn type loudspeaker system. At \$95., the

(Continued on Page 34)

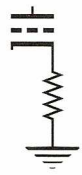

Cathode Bias

by
John Atwood

Old Components – Caveat Emptor

As part of the revival of interest in the heart of an old technology – vacuum tubes—a new interest in old passive components is developing. I won't get into the debate on the sonic merits (or demerits) of old components, except to say that they generally do sound different when used in critical circuit locations. These differences should be applied to audio design in the same way a chef adds herbs and spices to a dish. They are added to enhance the final taste of the dish, not just as an end in themselves. Recent electronic technology has made available high quality resistors and capacitors which are great for high-definition audio designs, but sometimes can leave the overall design sounding bland – like a meal with no salt or spices. Unlike food, however, still we can make use of old components from previous generations. These old components were built differently for different design goals, and have also passed through the ups and downs of aging. Decades of military stockpiling and scrapping of old equipment make passive components from the 1940s, '50s, and '60s still available. To the knowledgeable designer or builder, these parts can be used to tailor the sound of an audio system.

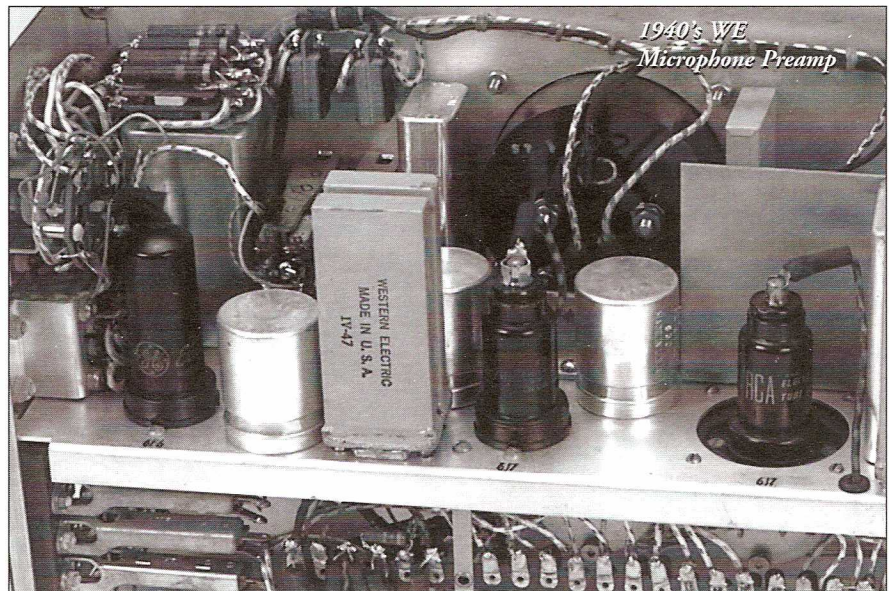

The resourceful parts scrounger can often retrieve parts from old equipment, and may even find stashes of unused parts – at ham swap meets, estate sales, or even junkyards. Those who don't want to scrounge for themselves can buy parts from a variety of places – ranging from dusty surplus stores to slick audiophile mail-order catalogs. However, when buying any old component, *caveat emptor* (buyer beware). Most components degrade with use or over time, and many components were simply not made to the tight specifications we are accustomed to in modern components. I've recently been sorting through mounds of old parts, and have found that a lot have to be put into the “non-critical use” category, or thrown away because they were simply non-functional. The better stores and mail-order

catalogs will pre-screen their old parts, but the unwary buyer may get parts in their amplifier that will be unreliable or cause other parts to fail. I will outline here some of the basic things to check for in old parts. See my article, Screening Vacuum Tubes (VTV, Issue 1) for the important items to check in old vacuum tubes.

Carbon composition resistors were by far the most widely-used resistor type in American electronics all the way through the 1970s. The military especially liked carbon composition, due to its high reliability – early carbon film and metal film resistors had a much higher chance of going open. However, while carbon comps would rarely completely fail, their resistance tended to wander around with temperature, and change with aging – almost always rising in value with age. This tendency to rise in value seems to be related to the manufacturer and time of manufacture. For instance, I have found that Ohmite resistors from the early 1950s seem to hold their value quite well, while Ohmites from the late '50s could dramatically rise in value – often 20% to 30%. More recently manufactured resistors seem to be more stable (although less aging has occurred).

When buying carbon-composition resistors, always test them with a good ohmmeter. Don't be surprised if more than half fall outside their marked tolerance range. You may set aside the out-of-tolerance parts for use as a higher-value resistor, but this is risky and confusing – someone repairing your work years from now may replace the resistor with the wrong value. Sometimes heating a resistor (by dissipating, say, twice its power

Various oil capacitors



rating for a few minutes) will bring the value back, but this only works occasionally. Even if you sort out the resistor values to very close tolerances, don't expect them to maintain their accuracy over time and temperature – they are very poor precision resistors. Also be aware that carbon composition resistors tend to have more noise (especially in the 1/4 and 1/2 watt types) than carbon or metal film, so they should be used with care in low-level (front-end) stages.

Electrolytic capacitors are one of the most temperamental components in audio equipment. During manufacture, the insulating aluminum oxide layer is grown by applying a "forming" voltage across the capacitor. As the capacitor ages without being used, this oxide layer degrades. Thus, ironically, an electrolytic that is frequently used will often last longer than

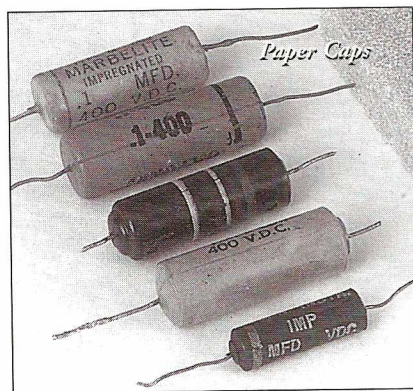

one sitting on the shelf. However, if the electrolytic is run too hot (by being cooked by an adjacent power tube, for example), the electrolyte can dry out, degrading the capacitor. I'm not aware of any sonic benefits to vintage electrolytics (usually quite the opposite!), so wherever possible, use recent electrolytics. Nearly all electrolytics have a date code, usually of the form XXYY, where XX is the year of manufacture, and YY is the week of manufacture (i.e. 7546 means the 46th week of 1975). Be wary of capacitors more than 10 years old. Any older high-voltage capacitor should be "re-formed" by slowly applying a DC voltage to it. This either can be done manually with an adjustable DC power supply (letting no more than about 10 ma flow at a time) or through a current-limited supply, such as the ones found in capacitor checkers (like the Sprague Tel-Ohm-Mike). Some old capacitors can take over an hour to re-form, but once re-formed, they can often work well.

Paper capacitors often can have the single biggest impact on sonics of any passive component, which explains the

renewed interest in vintage oil and paper capacitors. Paper capacitors can degrade in several ways. Paper is hygroscopic, so unless the capacitor is hermetically sealed, water vapor will leak in and be absorbed, causing DC leakage and raising the capacitance (water has a high dielectric constant). Waxed-cardboard capacitors are the worst-sealed, but even plastic molded capacitors can develop microscopic cracks. The metal-cased, glass-sealed ("mil-spec") capacitors have the longest shelf life. Regardless of the capacitor package, the paper dielectric can also degrade by itself, due to acids and other residual chemicals in the paper. This type of degradation is greatly accelerated by applied voltage, which explains why DC blocking capacitors often fail well before tone-control capacitors. This degradation causes DC leakage and increased losses. Plastic film capacitors became popular because they do not have these degradation modes.

Before using old paper capacitors, or restoring old equipment with such capacitors, it is prudent to check the capacitors with an LCR meter or an impedance bridge. This will not only show if the capacitance value is correct, but will indicate degradation by a higher-than-normal dissipation factor. You can get a feeling of reasonable dissipation factors by testing known-good capacitors of the same type. On my General Radio 1650A impedance bridge, good paper capacitors have a dissipation factor of between .005 and .02, polyester (mylar) between .003 and .008, and mica, polystyrene, and polypropylene essentially zero. Cheap hand-held digital capacitor checkers can sometimes give erroneous capacitance readings on capacitors with high dissipation factors or leakage.

Components that have an essentially infinite shelf life include: ceramic, mica, and plastic film capacitors, sealed potentiometers, hermetically-sealed inductors and transformers, switches and sockets (assuming they have not been corroded), hermetically-sealed silicon transistors and rectifiers, vacuum tubes, and brass or stainless-steel hardware. Non-hermetically sealed versions of the above parts can also be fine if they were not stored in a humid environment.

These warnings about old components are not meant to scare you away from using old parts, but to make you aware of the possible pitfalls with these parts, and to insure that they won't ruin your carefully-built project. With a little knowledge, you can avoid problems and enjoy the sound you want from vintage components.

STEELE 70 MK II

by Daniel Steele

People are always asking us about Stereo 70 mods. Here is an example of a fairly extensive modification with a beautiful mechanical execution.

It should be noted that the amplifier circuit in this amp is very similar to one I designed in 1986 for a pair of Dynaco Mark IVs that belonged to Jeff Rininger of Cayucos, CA. - Tech. Editor

After servicing modern and tube electronics for 25 years, the tube Hi-Fi bug finally bit me. Once struck, I knew it was time to either build or modify a tube power amplifier. I had two Dyna Stereo 70s in my shop at the time. They proved excellent candidates due to their immense rust and cosmetic denial. They weren't very pretty and even though they worked perfect, no body seemed interested in buying them. I knew that I could make these amps into something very special.

My first step was to decide on the parameters of my modification. The following is a list of what I came up with:

- Must look aesthetically pleasing without a cage and with tubes exposed.
- Must be shock hazard free so there can be no exposed power except at tube pins.
- Must have easy bias output tubes so that no tools are required.
- No extensive changes to existing chassis like drilling, cutting, etc.
- No pc boards, strictly hand wired.

My second step was to strip the chassis of all the rusty iron, sockets, etc.

In the third step, I had all the transformer covers powder coated in black with a clear-coat top finish. The chassis had a powder coated silver-bronze finish with a clear coat.

The fourth step was the hard part. I had to design the driver module enclosure. In consulting with my machinist friend, he advised me to build a cardboard model. The first model took me two hours to create and I was displeased with the outcome. I finally came up with the stepped tower design after several more attempts. The finished module is made from 1/8 inch flat aluminum stock cut and welded to shape. The welds were

polished out at a local polishing shop. One unit received a clear powder coat and the other was finished in a black powder coat.

My fifth step involved deciding which "glass" to use. I'm partial to the looks of octal "ST" shaped tubes. So, I naturally chose two octal and four 9 pin miniature sockets. This way, the unit can be flexible with many different circuits.

Step six involve the creation of the circuit. I've gained a lot of experience as a service technician over the years. I've seen many different amps and am a devoted reader of **Glass Audio** and **Vacuum Tube Valley**. I methodically combined my favorite circuits from the golden era of Hi-Fi to create the Steele 70 Mark II. I chose parts of the Dyna, Scott, and of course, the Williamson designs. For the gain stage I used an EF86 and a 6J5 for the phase inverter. In a sense, these two tubes act like a discrete 7199 tube. GE/Mullard EL-34s were chosen for the outputs tubes.

I decided not to regulate the bias supply. Regulation tends to be hard on the output tubes if the line voltage rises above the point where the bias was originally set. However this would not be so if the B+ supply was also regulated. A word of caution: a Zener diode on the bias supply line will work but if the diode shorts, you can kiss your output tubes good-bye. The bias circuit is similar to a Scott 299 amp. Now you can use a DC balance arrangement which allows for the use of non matched tubes. I use a 50k-10 turn pot because that's what I have in my "Hell Box." As luck would have it, the pot allows for extremely accurate dc balance adjustment. A 20K to 50K would work fine-just dither the voltage divider to arrive at the right bias range; approximately -40v mid range is ideal.

I added 200µf of filtering to the B+ supply which brings a total of 290µf plus the stock choke and star grounding. The bias meter is for checking the bias level and dc balance. To adjust, set bias level for max. negative voltage. Then set the switch to the balance position and adjust the 10 turn pot for null reading. Then switch to VR so you can set the amplifier to the proper voltage. Warm up the amp and re-adjust as needed.

One other addition to the amp is the level indicator tubes. After reading **Glass Audio's** 1995 #2 article on level indicators, I went to my tuning eye collection and found a pair of 6GX8/EAM86s. These aren't mentioned in the article, but

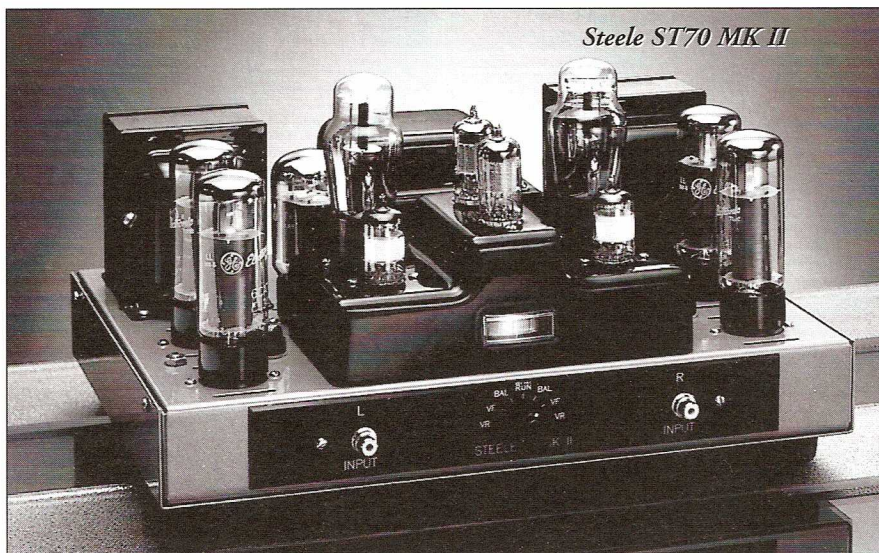

these tubes have a horizontal display area and look great. I use these tubes for output level displays and they have a fast response time which is great for looking at rumble from a turntable. On the topic of negative feedback, I tried the method suggested in my Mullard manual:

Circuits for Audio Amplifiers, copyright 1959. However, it's trial and error so try different values. The ones I choose work well for me. (The schematic for the Steele ST70 MKII is on page 28)

The components used can be chosen from your junk box or you can use common inexpensive type, polyester film capacitors, 2% flame proof resistors, or 1% film type. I used Teflon-coated silver wire that can be found in an electronics junk yard. (Don't pay retail for the wire-it's highway robbery.) The resistors for the plate load and cathode on the phase

inverter are matched within 200 ohms. The ESR and value of the coupling capacitors are matched within .1% (not bad for .09 cents each!). The sockets are surplus Cinch brand with a nice tight fit. After careful consideration, I decided to drill 4 holes in the chassis to mount the two fuse holders and bias/ balance pots. Another option would be to mount the parts beneath the chassis to avoid drilling holes.

The crew at VTV was treated to a listening session of this amp and all were very impressed with the sound quality. If anyone is interested in obtaining further information on this project, they can contact me at:

Bob's Radio and TV Shop, 2300 Broad St., San Luis Obispo, CA 93401

(805)-543-2946

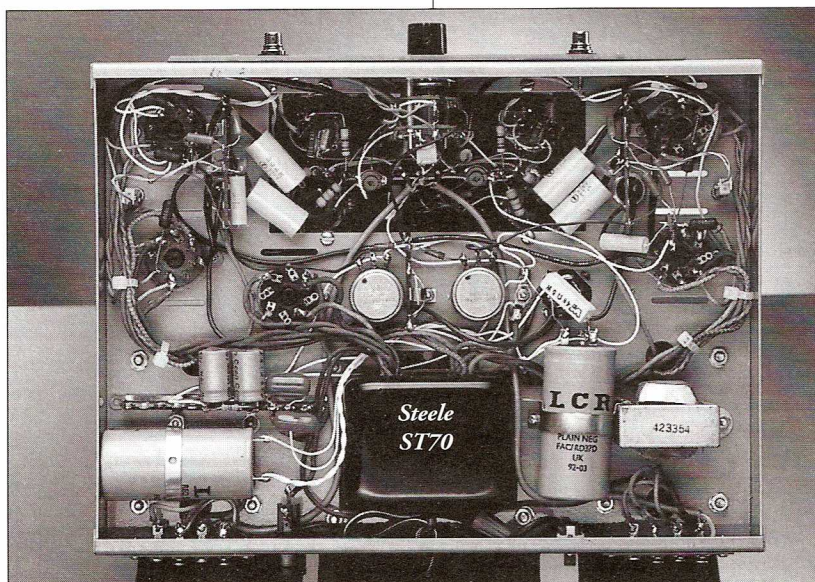

S T E E L E 7 0 M k I I S C H E M A T I C

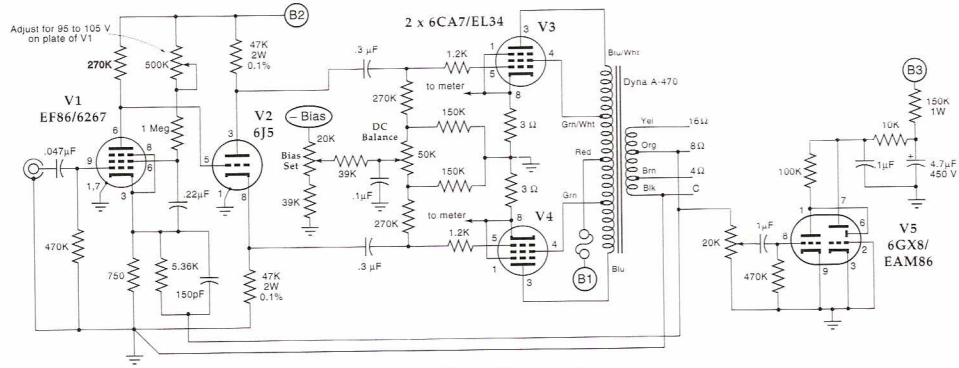

Steele 70 Mk II

Only one channel of amplifier and indicator is shown

8-15-95

Notes: All resistors are 2% 1/2W, unless noted. All capacitors are 630V unless noted.

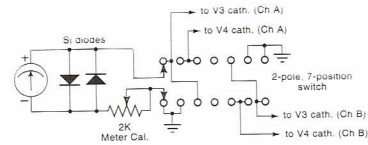
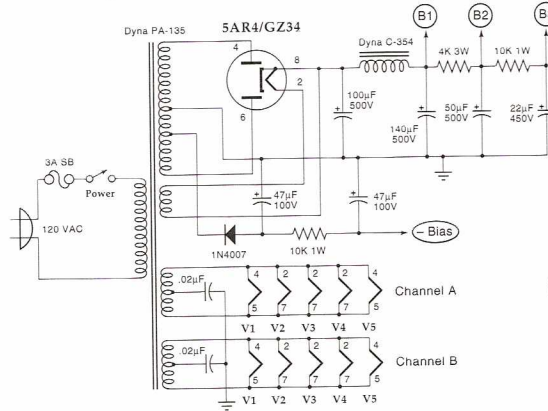

one electron™

Single-Ended Output Transformers
High Quality for a Reasonable Price
Designed and Built in the USA

Now Available
UBT-2



4.8k primary
15 watts
160 mA

\$118 Can be used with:
300B, 50, SV811-3, etc.

Also Available

UBT-1

Designed for parallel operation of:
2A3s, EL34s, 300Bs 6AS7s,
etc. or Sweep-tube in
"enhanced triode" mode

\$95

Quantity Discounts Available

To Contact us
On-Line www.one-electron.com
atwood@one-electron.com

Write or FAX for Information and Prices
65 Washington Street, Suite 137
Santa Clara, California 95050 USA FAX: 408 985-2006

S.E. OUTPUT TRANSFORMERS

MODEL	PRIZ	Ip	PRICE
CT3KB	3KΩ	100mA	\$195.00
MT5KB	5KΩ	60mA	\$195.00
VT2KB	2.7KΩ	160mA	\$249.00
*E18B	6KΩ	100mA	\$195.00
**E48B	1.8KΩ	350mA	\$425.00

- -.5DB 20 KHZ to 30 KHZ
- End Bell Construction
- Secondary Wire Output (No Splice)

* For SV 811-3

** For 4 x SV 811-3 60+ Watts

Call Our Design Department For
Any Custom Requirement

Electra-Print Audio

1311 N. Winwood St.
Las Vegas, NV 89108

702-646-7990

FAX 702-646-7752

We are not many, but we know how to find each other

SOUND PRACTICES

A quarterly journal for the advanced audiophile, featuring experimental approaches, historical perspectives, future directions, and cutting edge developments in music reproduction.

One year/4 issues— \$20 USA,
\$24 Can., \$30 Eur., \$35 Pacific.
Sample \$5. MC/VISA accepted.

Box 180562, Austin TX 78718
512-339-6229 Voice/FAX
e-mail: sp@tpoint.com

WHAT IS POWER LINE CONDITIONING?

by Marc Manion

Many devices are advertised as "line conditioners." Some are little boxes that plug into the wall receptacle; some have cords and multiple output receptacles; others are large, heavy, expensive equipment. For the same power rating, one device may sell for \$75.00, while another sells for \$5,750. Is the difference in performance? Reliability? Profits?

Specifications should be the starting point of any comparison. Here we encounter our first problem. With few exceptions, manufacturers provide few detailed specifications. Most make vague claims of "power protection," "noise protection," unspecified "guarantees," and similar unscientific claims. But you don't find complete specifications. Many of these devices are sold over the counter to users of home and personal computers, stereos, etc. Is such a customer knowledgeable about power disturbance technology? There are few authoritative textbooks on this subject. This article is a technical update on line conditioners. The first question is "what is a line conditioner?"

The term "line conditioner" is applied to devices that will protect against one or more of the following power problems:

1. Surges and over-voltages
2. Sags and brown-outs
3. Drop-out
4. Normal-mode spikes and noise
5. Common-mode spikes and noise
6. Transverse-mode interferences

Any device that has no specification for any one of the above types of disturbances is a "gadget" and probably serves no useful purpose. Any device which shows specifications for only some types of these disturbances probably will not perform well under other types, or for any conditions omitted from the specifications. Any device with inferior or incomplete specifications was either never tested under all types of disturbances, or introduces other problems under those conditions.

There are some power disturbances

that exist all the time but that do not cause any malfunction or component stress on delicate electronic equipment. For example, there is always a fair amount of distortion of the power line sine wave, and there are occasional frequency of phase shift transients. These distortions are troublesome for hi-fi but cause no harm and transitory phase shifts are troublesome only for ferroresonance and tap-switching regulators.

CVT or Ferroresonance

CVT (Constant Voltage Transformers) that use ferroresonance are common, but have some problems. The apparent advantage of being short-circuit proof can become a severe limitation when involved with start-up surge currents of electronic equipment. Surge currents that occur when electronic equipment is being turned on can cause the output of a ferroresonant regulator to collapse if the ferro is improperly specified (i.e., if the Ferro over-current limit is not properly specified above the anticipated inrush load.) Thus if two or more pieces of equipment are operating on the same CVT, disturbances can result whenever a switch is turned on. Since the output of the CVT is a resonant circuit, if the load includes any reactive (power factor) components, it will change the output voltage. If a CVT is tested with a realistic input termination drop-out (a short) its behavior becomes catastrophic. It draws horrendous input currents. The output voltage collapses and it takes 4 to 10 cycles of severe overshoots and undershoots for the output to stabilize. CVT performance is surprisingly bad when it is tested under realistic conditions; for example, low input source impedance.

Adding a CVT to the system without understanding how it works and what it does can cause wasted hours of testing and trouble-shooting with no results. This is because nobody suspects that the problems are caused by the CVT -- the label on the device says 3% regulation.

The myth of the ferroresonance CVT and its magic performance was born at a time when the protected devices were not particularly sensitive to momentary, erratic line behavior and there was no test equipment available to evaluate true performance. However, good test equipment has been available since the 1970s. The problems introduced by CVTs can now be demonstrated.

Problems of CVTs :

1. The output phase can vary 30 to 50 degrees depending on input voltage and

load conditions. Equipment relying on zero-crossing techniques for operation would be affected.

2. Switching loads on or off causes output transients, which can disturb other equipment operation off the same CVT.

3. The devices are heavy, audibly noisy, get hot, and are inefficient. The inefficiency aggravates the problem of power losses of inadequate conductor wire sizes because with the CVT the total input demand to the system increases significantly.

4. CVTs generally add about 1.5 to 3% distortion to the output waveform.

Tap switching

Tap switching regulators use either an autotransformer or isolating transformer with multiple primary taps, which can be switched in electronically by SCRs. When the line voltage sags, the next lower tap is selected, boosting the output voltage. Good tap switchers have circuits that sense the zero-crossing of voltage and/or current, and switch only at the zero crossings, so that inductive spikes are avoided.

Tap switchers are useful for protecting computer equipment from brown-outs, but their abrupt voltage changes when taps are switched make them unsuitable for most audio equipment.

Early line conditioners

Around 1964 the first line conditioner was introduced using AC-to-AC converter implemented by an amplifier. It had an impressive performance. It could restore an almost perfect sine wave, and response time was in microseconds. It was big and heavy, and with active (vacuum tube) amplifiers the energy efficiency was only about 50%. Of course it was expensive. However, many of these line conditioners were used in military applications, metrology labs, and similar installations.

An interesting unit that appeared in the early 1950's is the Ampex 375. Developed to run tape recorder capstan motors at a constant speed, this all-octal tube rack-mount unit had a 60 Hz tuning fork oscillator driving push-pull 807s, giving about 100 watts at 120 volts.

Isolation Transformers

Many test programs in nuclear, space, and military developments use signals in the nanovolt and picoamp levels. These low signal levels introduced grounding problems. Ground loops caused error

Definition of Terms

Constant Voltage Transformer (CVT)--

Initially it was called a Constant Voltage Transformer. It is comprised of transformer laminations, copper windings and a capacitor. This transformer became so popular that it was generally known as a "Sola" manufactured by Sola Basic Industries and others, under patents held by Sola. This device has been used in such volume that now, years after the patents have expired, most transformer houses produce CVTs.

Current (I)--

Amount of electric charge that flows through a conductor.

Harmonic Distortion--

The presence of harmonics that change the AC wave form from simple sinusoidal to a complex wave form. Harmonic distortion can be generated by a load and reflected back in to the AC utility line causing power problems to other equipment on the same circuit.

Isolation Transformer--

A multiple winding transformer with physically separate primary and secondary windings. Although the primary and secondary windings are physically disconnected, the magnetic field in the windings of the primary creates (induces) electrical power in the secondary windings. In this way the electrical power at the input can be transferred to the output, without electrostatic coupling of noise to the output.

Mode, Common--

Disturbances, such as spikes, are voltages which exist between input neutral and ground, caused by currents flowing through the neutral conductors and by leakage currents through the input ground conductor.

Mode, Normal--

Similar to Common Mode except the disturbance is on only one input line of the amplifier.

Mode, Transverse--

This refers to signal or noise induced by radiation (RFI and EMI), which transverse the conductors; it is a poor but widely used term for radiation-induced interference.

Power Factor (PF)--

The ratio of total watts (the real power) to that total root-mean-square (RMS) volt-amperes apparent power (w/va). A power factor of 1 means that all the power is delivered to the load. A lower power factors means that not all the power is delivered to the load, but dissipates heat in the transformers and transmission lines.

Transient--

That part of a change in voltage or current that disappears during the transition from one steady-state operating condition to another.

Volt-Amp (VA)--

The voltage multiplied by the current driving the load. If the power factor is less than 1, then the VA is always higher than the true power (watts) delivered to the load.

Volt (V)--

Unit of measure for voltage. Voltage is the electrical pressure which forces the current to flow in a conductor such as a wire.

Watt (W)--

Unit of measure for true power. Watts = VA/Power Factor.

voltages that often exceed the true signals by many orders of magnitude.

The solution to ground-loop problems was found in ultra-isolation transformers. At first it involved small signal transformers used in chopper stabilized dc amplifiers, which made it possible to measure microvolt dc signals in the presence of common mode voltages of 100 V. Some high performance dc amplifiers had common mode-rejection (cmr) specifications of 160 dB (10 to the 8th power:1).

Other ground-loop problems in those systems were ultimately solved by isolating each piece of equipment from the power line ground, and by using a totally separate, dedicated ground that was connected to the system. This established one common reference point that solved many problems in instrumentation systems with ultra-low level signals.

An isolation transformer was used to "break the ground loop." The isolation transformer with a shielded primary winding connected to the power line input; the shield is connected to the power line ground. An isolated, shield secondary-winding provides the output

power to the system. The shield around the secondary winding connects one of the two output wires, and a quality ground connection is then made to the same point. The quality ground was usually taken from a solid rod, driven deeply into the ground. Note: this is now prohibited by most electric codes.

The purpose of this scheme was to break the ground loop in eliminate common-mode problems. Common-mode disturbances are voltages that exist between input neutral and input ground, caused by currents flowing through the neutral conductor (and by leakage currents through the input ground conductor caused by poor equipment design).

The isolation transformer cannot remove any normal-mode signal or disturbances. In fact, the isolation transformer introduces problems of its own, which had to be anticipated in the design of so sophisticated a system.

1. One problem is the excessive power loss that causes clipping of the sine wave peaks due to the characteristic rectifier-current demand pulses of capacitor-input DC power supplies. This causes harmonics and can drop the RMS voltage delivered to the equipment.

2. The second problem is that the tight shielding forms an LC circuit with the windings, which is resonant at some high frequency. All normal-mode spikes represent energy dumped into that tank, causing it to "ring" so badly that the output spike became larger than the actual input spike. This was not understood for a long time and is the cause of many component failures and logic errors, particularly in computers. Appropriate filtering or damping circuits can reduce this problem.

3. The third problem of isolation transformers is that they can be saturated during voltage transients. The worst condition (and the best one to test) is a half-cycle, terminated, total dropout. Unless the transformer is designed to operate at extremely low flux densities (24 Hz operation spec.) it will saturate immediately following dropout, draw horrendous input currents, and not produce any usable secondary voltage. The next few cycles thereafter will be severely distorted, until it becomes a sine wave again.

The saturation currents may be so severe that input fuses may blow and sometimes an input breaker will trip. An isolation transformer ahead of a switch-mode power supply can easily cause errat-

ic power supply behavior. When isolation transformers were first marketed, they had adequate specifications. The specification for leakage capacity gave a good indication of the quality and completeness of the shield, and common-mode rejection specifications were properly stated. Load regulation was always specific for resistive load because that is common practice in the transformer industry. However, over a period of years, the specifications got distorted and new terms were added.

One manufacturer realized that, in theory, an isolation transformer can reject transverse-mode (radiation-induced) noise. Theoretically, that is correct; if you mount a well-shielded, ultra-isolation transformer on the power pole, the transformer can reject radiation-induced (transverse-mode) noise, but only if the power input to the transformer is totally floating or balanced.

With other utility users hanging on the same network, that is not the case. In fact, this "transverse-mode rejection" is only a theoretical specification which has little practical meaning.

Once the ac input power has passed through the main transformer that feeds the buildings, all radiation-induced transverse-mode inferences are either canceled in the input power transformer or converted to normal-mode noise. All normal-mode noise passes right through any transformer, shielded or not.

Unfortunately, some data sheets showed diagrams that led users to believe that transverse-mode is the same as normal mode noise. This has led to a lot of confusion and misunderstandings.

Then came another new term: "inter-coupling noise suppression." This means absolutely nothing. After a few years, the specifications disappeared altogether. Instead, big words were used to advertise isolation transformers with "guaranteed noise protection" and similar nonsense. This is the present state of affairs.

If an isolation transformer removes any normal-mode noise from a system, it is not the result of either isolation or shielding; it is the series of attenuation (resistive and leakage inductance) which add impedance ahead of the input filter of the system.

Spike Suppression

This discussion thus far has related to voltage regulation. Let us now consider the subject of spike and transient suppression.

There are two devices broadly advertised as "power protectors": "surge or spike protectors," or sometimes called "line conditioners", radio frequency interference filters (RFIs) and spike suppressors that perform transient suppression but no regulation.

Spike suppressors are semiconductor devices that behave like zener diodes. Up to some critical voltage level they conduct virtually no current but as soon as the voltage across them rises above that critical level, they start conducting heavily. These devices may be semiconductor Transzorb or metal-oxide-varistor devices (MOVs). They connect from line to neutral and must have an initial stand off voltage that exceeds the nominal expected peak voltage (250 V peak for 120 V power.) With a high line voltage of 127 in the USA, and some margin for product tolerances, these devices do not start conduction until the voltage across them reaches about 250 V peak.

The amount of energy spike-suppressors can absorb depends on their physical size; typical numbers used for spike energy are 20 or 40 joules of a single spike that does not occur repetitively. If such a device is over-stressed, it will self-destruct (MOV) or develop a permanent short circuit (Transzorb). In the case of the MOV, you can only tell by physical inspection that the device is damaged and no longer operates.

Neither transzorb nor MOVs are effective "noise protectors" for computers because their initial standoff voltage must be large (250 V peak for 120 V power or 400 peak for 240 V power) and because spikes of twice that level (500v) can easily pass without any clamping at all. Spikes occur at random- i.e., they may be positioned any place along the line voltage sine wave. The suppressor doesn't even know that the spike exists.

It has been known since the middle 1960s that many spikes on the power line have nanosecond rise time and duration. These spikes will pass into your electronics.

RFI Filters

The RFI filter is designed to attenuate radio-frequency interference. It is specified with 50 ohm signal source impedance and is effective only at frequencies far above 1 MHz. It was never intended for and never tested for behavior under high energy spike conditions. If an RFI filter is subjected to typical high energy line voltage spikes, it will exhibit ringing phenomena that can cause severe com-

puter problems; any resonant tank "rings" at its resonant frequency; a small amplitude spike at the filter input can cause ringing with an amplitude much larger than the input spike. Large spikes can cause such severe ringing that they produce corona, arcing, and physical destruction of (ceramic) capacitors.

Summary

So what is the best line conditioner? It depends on what is being protected. Most computer systems can withstand a momentary drop-out, but can lose data or be damaged by spikes and transients. Analog equipment is less tolerant of drop-outs, and abrupt changes in line voltage. The best line conditioner may be a combination of techniques described here.

Not mentioned in this article are other conditioning techniques, such as motor-generators (only used in large installations such as mainframe computers) or UPSs (Uninterruptable Power Supplies). But, for those evaluating a small line conditioner for their system, the information here can help clear away some of the overrated claims.

Copyright 1995 by Power Science Ltd.

Marc Manion has been involved in audio since the late 1960s. In 1990, Marc founded Power Science Industries and has been devoted to improving AC power for audio applications ever since.

(DC Meters, continued from Page 17)

was produced up through the 1980s.

When cheap field-effect transistors became available in the late 1960s, solid-state "VTVMs" were brought out. These permitted the performance of a VTVM in a design that was as compact and portable as a VOM. However, many of these early solid-state meters had drift problems that were even worse than real VTVMs, and were susceptible to RF fields and blow-outs. The result was that, except for portable testing, the solid-state meters did not completely supplant VTVMs.

The Digital Voltmeter (DVM)

Digital voltmeters first became widely available as lab test equipment in the 1960s, using discrete transistor circuits and Nixie tubes. These were very expensive; out of the price range for normal service work. With the advent of integrated

circuits, especially CMOS LSI circuits such as the Intersil 7106, cheap, hand-held digital voltmeters became practical. Some manufacturers tried to put a DVM into a conventional VOM package (such as the early Simpson DVM), but eventually two styles dominated: a low-profile bench unit, and the hand-held DVM.

The cheaper DVMs are typically so-called 3 1/2 digit meters (meaning that they can display a value as high as 1999). Some fancier units are 4 1/2 digits, and expensive lab-grade units can go to 5 1/2 digits or higher. One thing to look at carefully in selecting a DVM is the accuracy spec. Whereas a 4 1/2 digit meter implies a maximum accuracy of .005%, few 4 or 4 1/2 digit meters have accuracies better than 0.25% on DC and 0.75% on AC. The 3 1/2 digit meters are even worse, especially the cheaper imports. So, be careful not to assume that the DVM reading is correct to the last digit. Having a high number of digits is helpful in giving good *resolution* even if the absolute accuracy is not good. Resolution is needed when making sensitive circuit adjustments, such as aligning an RF circuit to maximum resonance. This is a type of measurement, though, where analog meters are still the best.

The input impedance of DVMs is generally high: typically 10 Megohms, so circuit loading is similar to a VTVM. Some DVMs, though, can inject a large amount of digital noise into the circuit being tested, which can disrupt AF or RF systems. DVMs share the same susceptibility to damage as solid-state VOMs. The better-quality units are usually well-protected by fuses and/or electronic protection. The AC ranges of DVMs can have some significant limitations, but these will be discussed in the next article in this series.

Summary

Probably the most convenient DC meter for the average technician or builder is a decent DVM. The traditional VOM can be effectively used, especially on solid-state circuits (as long as the circuit loading issue is recognized), but is not very useful in tube circuit measurements. The VTVM is still quite useful as a bench-top meter, and actually can be more convenient than DVMs for things such as receiver alignment.

The Audio Test Bench topic for next issue: AC Meters.

(Altec 604, continued from Page 7)

the Tangerinetype phase plug high-frequency assembly. Frequency response was 20 to 20,000 cycles and power rating was 65 watts RMS. A higher power model of the 604 - 8K was the 904 - 8A, with a rating of 120 watts RMS. In the 1980s, Urei apparently used the 604 speaker baskets in some of their speaker systems.

Making a Good Thing Better

With the crossover point at about 1000 to 2000 cycles, the 604's 4-6 dB rise in the middle of the listening range between 2000 to 4000 cycles became a concern to many recording engineers. In 1971, Doug Sax, a recording engineer who owned The Mastering Lab in Hollywood developed a special crossover that was better than the original Altec unit. The Mastering Lab crossover boosted low frequency response to 40 cycles, boosted high frequency to 15,000 cycles and flattened the annoying 2-4,000 cycle peak.

The Mastering Lab Crossover was offered to Altec, but they decided not to go for it. Sax then offered the crossover to Audiotechniques of Stamford, Connecticut, a studio design and consultation firm. Audiotechniques liked it and offered the ML Crossover as a studio retrofit item and as part of their Red Series Studio Monitors. The Big Red Monitor used a 604-E2 in a sealed, six cubic feet enclosure designed by Capitol Records. Response of the speaker was 40 to 17,000 cycles +/- 2dB with increased sound pressure levels. The Super Red used a twelve cubic feet sealed enclosure with a 604-E2 plus a 15 inch low frequency woofer that crossed over at 1000 cycles. About a thousand pairs of the Red Series Monitors were sold in the Seventies and early Eighties.

Getting the Best Sound From 604s

A 604 can be a very finicky speaker. It is best not to use it with a solid state amplifier or a high powered tube amp, which will yield a hard and honky sound. Also, using it in a small listening room with the listener close to the speaker is inappropriate. The ultimate set-up for a late 604 would be the Mastering Lab Crossover, but it is quite rare. An alternative would be to design a crossover that flattens the 2,000-4,000 cycle peak.

In stock form, some of the finest sounds come from using a 604 with a low-powered triode amp such as the Brook 12A3, Craftsmen 500,

Leak TL-12s, etc. 604s can also be bi-amplified using a push-pull amp for the bass speaker and a low-powered triode or single-ended amp for the high-frequency horn. The enclosure should be at least 6 cubic feet and include a bass reflex port. Altec published plans for various speaker enclosures that used the 604. With a good triode or bi-amp set-up, a proper cabinet and a good crossover, the Altec 604 can be an excellent performer.

(300B Tests, continued from Pg. 12)

4. The Shuguang 300B is surprisingly good quality, but it obviously has limits on dissipation. It seems to use materials similar to other Shuguang tubes, so lifetime is expected to be less than that of the other brands.

5. As noted above, the first Cetron 300B we got developed a filament-to-grid short upon plugging into the amp. Even with 4.0VDC on the filament, it still shorted out. THIS IS NOT GOOD....

More 1995 samples worked, but some had filaments that splayed out rather than staying in a flat plane; thus, performance was degraded. Cetron's materials appear good, but quality control is an issue. Two good used 1994 samples we borrowed were excellent, so maybe a bad 1995 lot was involved. This tube works well at 300v 75 mA, but new ones should be checked before use in an amp.

A single sample of the long-awaited new Western Electric 300B arrived right before press time. This new tube had the lowest distortion at 300 volts/75ma. VTV listened to this tube in several amplifiers at the Winter 1996 CES including the new Jadis SE300 amplifier. The results were impressive.

Also, Sovtek/New Sensor has been advertising a 300B, and I've heard that samples were being passed out in October, so we will try to get some for test. This tube is believed to be made by Reflector Corporation in Russia and is unrelated to other versions.

3. Final Items

The 300B is a fine audio tube; but not godly, as some claim. When opening the box on an old Western Electric 300B, you won't hear a celestial chorus singing hal-lulujah. But if operated within its ratings, the WE 300B performs well in an amplifier using high quality components connected to a well-designed efficient speaker

(Cont on page 34)

Svetlana, The Tube Giant.

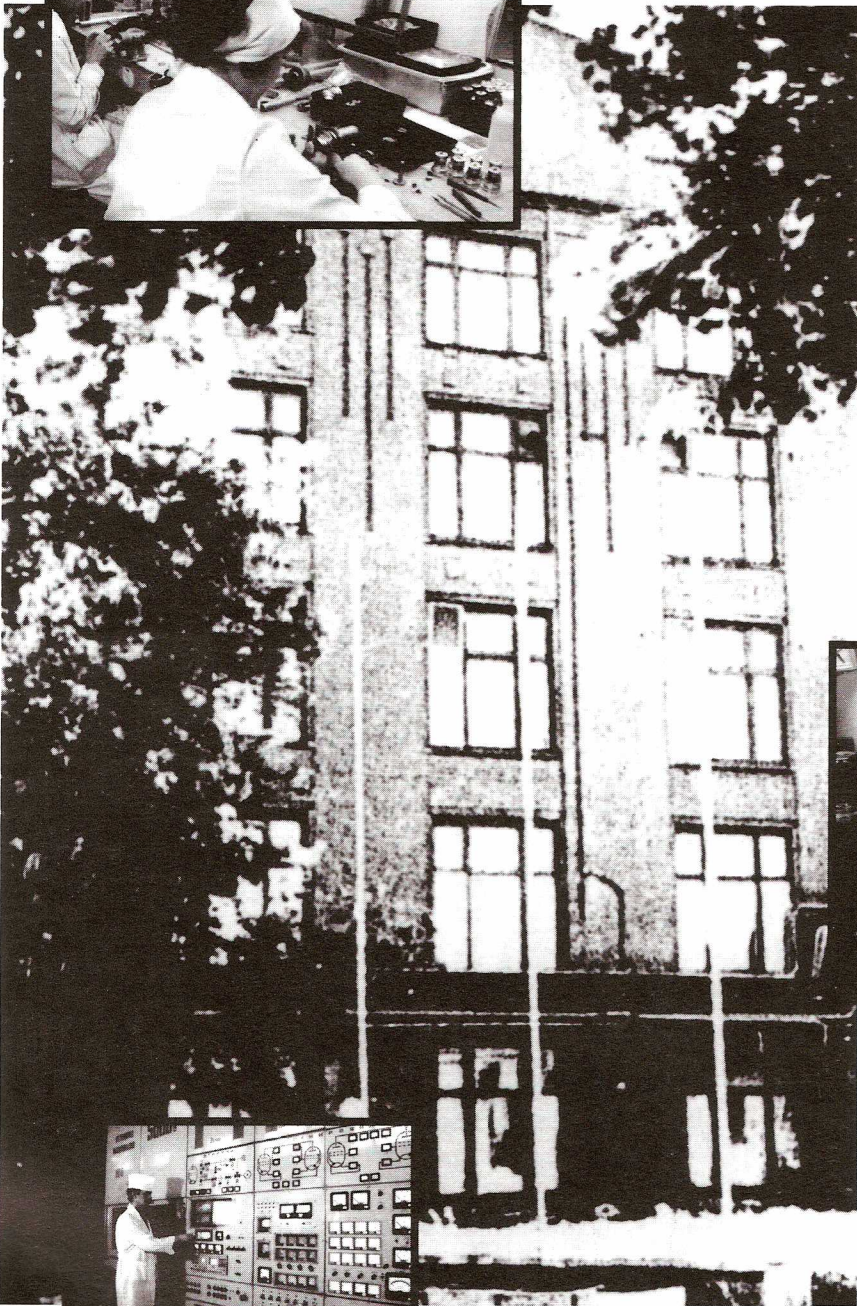

*E*verything is bigger than life at Svetlana. We're the world's largest manufacturer of vacuum tubes. With thousands of employees and millions of square feet under one roof, Svetlana leads the tube industry and sets the standards for excellence in engineering, design and manufacturing. When you buy Svetlana tubes, you are assured of getting the very best value for your dollar. Every tube is full-power tested at the factory and we guarantee each of our tubes with a warranty unprecedented in the industry. So think BIG, think Svetlana.

We're big on customer satisfaction!

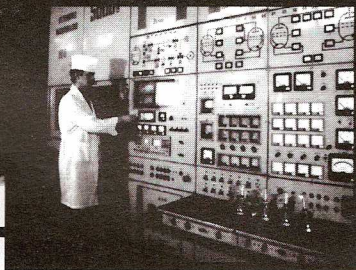

The huge Svetlana vacuum tube plant in St. Petersburg, Russia.

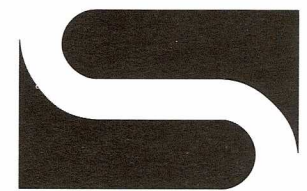

Svetlana
ELECTRON DEVICES

Power Tubes for the World.

Headquarters:
8200 S. Memorial Parkway
Huntsville, AL 35802
USA
Phone: 205 239 6900
Phone: 205 882 1344
Fax: 205 880 8077
Toll Free: 800 239 6900

Marketing & Engineering:
3000 Alpine Road
Portola Valley, CA 94028-7582
USA
Phone: 415 233 0429
Fax: 415 233 0439
Toll Free: 800-5-SVETLANA
(800-578-3852)

(SE Listening, continued from Page 24)

UBT-1 is a "best buy" in its performance range.

The 4.8K UBT-2 (\$118) we tested was a pre-production unit, but was checked for specification. Connected to a single 300B at 60 ma, this unit had clear mids, but the highs were somewhat peaky. The bass was a little mushy and there was not a lot of punch in the low frequency spectrum. This performance can be attributed to somewhat of a "mismatch" in impedances with this transformer. (4.8K vs approximately 3K in the others)

TAMURA

The Tamura 3.0 K F-2007 (\$600) is easily the most attractive transformer in the test. It is flawlessly finished and beautifully potted and has a gold band on the bottom with a metal and ceramic ID badge on the top of the unit. This transformer is used in many of the "high end" amps made in Japan.

With a single 300B at 60 ma, the sound was smooth with balanced mids and highs. There was "extreme detail" in the upper mids, but the lower bass was somewhat distorted. This transformer would sound excellent through early Western Electric horn drivers or Altec 288 horn drivers.

Again, just for kicks, we tried the Tamura with the VAIC VV52 set at 500 volts/80 ma and were treated to "ultra detailed" sound with balanced mids and highs. The bass was not as full as the Electra-Print, however.

TANGO

In the typical Japanese tradition, the Tango transformers were beautifully made and well potted with a hammertone metallic finish. The XE-60 (\$450) we listened to was a 3.5K unit rated at 140 ma.

First we tried it with a single VAIC VV30B at 80 ma. The overall sound was balanced and sweet. Very nice to listen to. There was a nice presence and lots of musical information. The bass, however, was somewhat soft, especially when compared to the Electra-Print.

We hooked up a single 300B at 60 ma and the sound was a bit more recessed and laid back compared to the VV30B. The mids had good depth and presence and the highs remained sweet.

Lastly, we tried a single VAIC VV52 power triode at 80 ma with the XE-60. We noticed more bass, more detail and a bigger sound. The mids were "flatter"

and had a bit less presence.

THE BOTTOM LINE

In a properly designed amplifier, any one of the transformers we evaluated in this article can sound excellent. However, our listening group came up with some "favorites":

For those on a budget using a single 300B, the AudioNote 2.5K or 3.0K were the clear winners with a well-balanced sound and a realistic quality with low listener fatigue.

Users of a single 300B with horn speakers and a larger budget, should consider the Tango XE-60 for its sweet and balanced sound that would complement many finicky horn speakers.

The audiophile who wants the ultimate in "Big Tone", regardless of price, should consider the Electra-Print VT2-KB with the VAIC VV52. This combination easily had the best balance, biggest bass and the best low and mid-bass clarity with our SE amp and speakers.

(MI-200, continued from page 21)

using the sources that I came to know. It is not cheap; figure about \$5000, and a couple months of evenings and weekends to build the amps. But it can be done, and the results would be well worth the time and expense!! Following is a list of sources.

Custom Chassis, Schematics, Meters (Author):

David Wolze, 3076 Shadow Springs Pl. San Jose, CA; 95121

Transformers (Power, Choke, and Output):

Audio Transformers, 185 N 85th St. Wauwatosa, WI; 53226 (414) 774-6625

Tubes, Sockets:

Antique Radio Supply, 6221 S. Maple Av, Tempe. AZ; 85283 (602) 820-5411

Resistors, Capacitors, Etc

Mouser Electronics (800) 346-6783

Output Tubes (811s, 572s):

R & G Svetlana (800) 456-5642

Capacitors, fuse holders, rectifier diodes:

Marlin P. Jones (407) 848-8236

David Wolze is an electronics engineer and audio consultant based in San Jose, California..

(WE300B Cont from Page 32) system.

There are new tubes in a similar vein, some capable of nearly equal sound quality, but in its power range, the original WE 300B is excellent. Nevertheless, in a properly-designed amp, any of this family can give outstanding sound. Ultimately, the end user must decide whether a given tube or amplifier sounds good or bad.

Many thanks to Antique Electronic Supply, Richardson Electronics, Svetlana Electron Devices, Electra-Print Audio and Vaic Valve AG for their invaluable help with this article. Thanks to Charles Whitener of Westrex Corporation in Atlanta, Georgia for sending us their reissue of the WE300B to test. Also thanks to Bernard Magers for his excellent book 75 Years of Western Electric Tube Manufacturing, and to John Stokes for his invaluable book 70 Years of Radio Tubes and Valves.

(SE Transformer Test Continued from Page 23)

Recommendations:

For one 300B at the recommended 60 mA plate current, any of these transformers will give good audio fidelity. For amp designs using more current, choose a Tango, Electra-Print, Bartolucci or Audio Note. The Tango seems especially good for the high-frequency driver in a bi-amped system. If fit and finish are important, the Tango, Tamura and Bartolucci units are very attractive, while the Electra-Print is a hulking iron beast and the Audio Notes look unfinished. The Electra-Print is available with gold or chrome plated end-bells or in potted form at extra cost.

A special thanks to Steve Melketesian, Angela Instruments, 10830 Guilford Rd., Ste 309, Annapolis Junction, Maryland 20701 for lending VTV the AudioNote and Bartolucci transformers. Also Jack Elliano of Electra-Print for lending the VT2-KB, Don Pettee of Sunnyvale, California for lending the Tango, John Peterson of Seattle, Washington for lending the Magnequests and John Atwood for lending the Tamura transformer.

**VTV Feature Book Review
Audio! Audio!**

Jonathan Hill - Author

Sunrise Press

by **Charlie Kittleson**

In the world of audio history from the so-called "Golden Era", very few books exist. When I obtained a copy of "Audio! Audio!" by Jonathan Hill, I was pleased to see a compilation of data and photographs covering Golden Age valve HiFi equipment. What makes this book even more appealing is that it covers early British audio!

The author, Jonathan Hill, has a considerable background in vintage electronics. In 1976, he co-founded the British

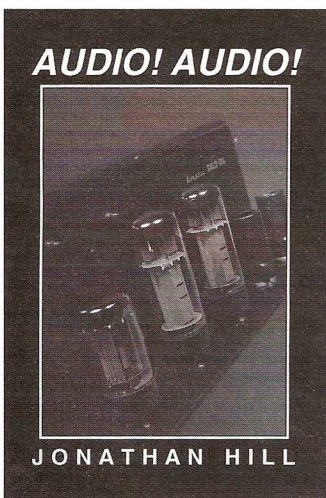

Vintage Wireless Society which is dedicated to the preservation of obsolete wireless equipment and broadcasting history. He is the author of other related books including "Radio! Radio!"

"Audio! Audio!" covers over 850 different valve amplifiers, control units and early public address equipment from nearly 150 British manufacturers. The well-known ones like Quad, Leak, Lowther, Radford, Tannoy, etc are featured as well as ones I have never heard of. Models are listed with basic specifications, valve complement, power ratings and years of manufacture. Some companies appeared to have lasted only two to three years, then faded into obscurity.

There are 71 high-quality black and white photographs of your favorites including the Leak mono and stereo

units, early Quad amplifiers, US export models of Heath, Fisher, H. H. Scott and many more. The book has a glossy color cover with 96 pages.

A few added features in the book are a time-line of audio developments from the invention of the valve to the early transistor era. Hill also has two charts showing the steady rise in valve and valve equipment production from the Forties until the early Sixties, when transistors came in.

For vintage hi-fi collectors, British valve audio enthusiasts and other interested tube heads, "Audio! Audio!" is an excellent book to have in your reference library. It contains information and photographs which heretofore were not available anywhere.

"Audio! Audio!" is available direct from the publisher for \$33.00 US dollars, postage paid to the USA. The address is:

**Sunrise Press, 2-4 Brook Street,
Brampton, Devon, England EX16 9LY**

**VTV AT THE WINTER
1996 CES IN LAS VEGAS**

by **Charlie Kittleson**

Every January, in Las Vegas, Nevada, 80 to 100,000 people gather to see the latest and greatest electronics products at the Consumer Electronics Show. The show takes over the entire Las Vegas Convention Center and several hotels. Everything from calculators and watches to home theater and high-end audio is on display for the buyers, distributors, dealers and press. Traditionally the high-end audio exhibitors set up camp in the Sahara Hotel, a Vegas landmark.

This year, VTV staff including John Atwood, Steve Parr and I attended the show to check out the latest in tube audio products at the Sahara. We were all pleasantly surprised to see that almost 70% of the rooms had some sort of tube amplification or preamplification.

What's New

Every year, there are some new products that are show stoppers. This year was no different. Marantz America unveiled the re-introduction of their classic vacuum tube hi fi products: the Model 7 Stereo Preamplifier (\$3800), the Model 8B 70 watt Stereo Power Amplifier (\$3800) and the Model 9 70 watt Mono Power Amplifier (\$4200). The equipment was made to look just like the original, right down to the machined aluminum knobs and the medium bronze hammertone finish. Even the circuitry inside was like the originals including point-to-point wiring throughout, multi-section can capacitors, carbon composition resistors and more.

The original vendor for the transformers was located and they still had the original specifications for the Marantz iron. In most cases, their chief engineer had worked with Sid Smith, the Marantz engineer, in designing the superior quality transformers including the Model 9's legendary TO-3 output transformer. Tube complement and specifications are the same as the originals.

Once again, spare parts will be available for the repair and restoration of original Marantz gear. These are not to be limited editions and will be manufactured on an ongoing basis.

New Marantz Products





T-1
 Marantz also displayed the spectacular Project T-1 Class A triode, push-pull 50 watt amplifier. The amplifier features four-300Bs in the front-end driving a pair of 845 transmitting triodes. Two additional 845s are used as rectifiers for the high voltage plate supply to the output tubes. Each 50 watt RMS amplifier has seven transformers (including three chokes) and is priced at \$25,000.

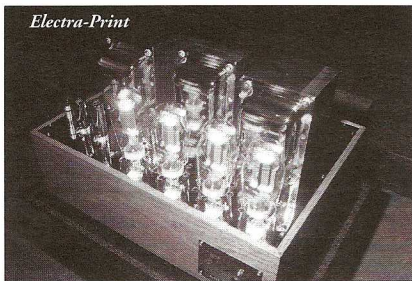

Electra-Print
 Jack Elliano of Electra-Print Audio in Las Vegas showed off his beautiful chrome and gold plated Verzhina (\$4475/pr) 50 watt class A Single Ended Amplifiers using the Svetlana SV811-3 output triodes. The amps were hooked up to the new Edgar Horn speakers.

The new Quadric line of equipment included the Quadric MT-35 (\$4990/pr) SE 845 power amp, the MT-10 (\$3595/pr) SE 300B power amp and the F 1 (\$2990) tube stereo preamplifier.



Quadric MT-10

We spoke with Dennis Had, President of Cary Audio about the new SE-811 (\$2000/pr) amplifiers using the Svetlana SV811-3 power triodes. These amps



Cary SE-811

sounded great and are a bargain in their price range.

One of the more interesting exhibits was the Chinese Shenzen Electronic Industrial Co, Ltd. Their line featured beautifully styled SE and PP 845 power amplifiers, 100 watt EL34 monoblocks, and other budget priced amps using PP KT88s, KT66s, EL34s, and 6L6s. They also had SE amps using the VAIC VV30B and the 211. In addition, they featured



Shenzen PP845

an impressive line of tube preamplifiers and integrated amplifiers. We expect to see more Chinese tube audio equipment in the marketplace this year.

Dr. Ricardo Kron of VAIC Valve Ltd demonstrated his new line of amplifiers including the SE VV30B, SE VV52B amplifiers designed around his line of high

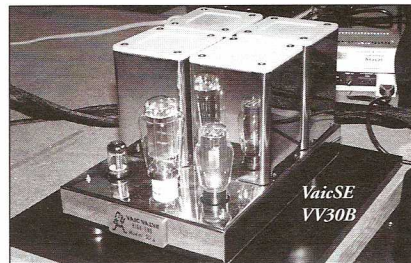

Vaic SE VV30B

quality vacuum tubes. These amplifiers were beautiful and sounded excellent.

It's companies like JoLida, Inc. Annapolis Junction, Maryland that continue to bring the cost of quality tube hifi down to affordable levels. They displayed their entire line of nicely finished and great sounding equipment. Most were PP 6550s and EL34s with different styling and power ratings. The Model SJ 202A (shown) had a unique vintage looking transformer set. JoLida amplifier prices ranged from \$850 to \$1650 and they should be very competitive in that range. They even had a PP EL84 stereo amp in the \$550 range and spoke of a new tube car audio amplifier using this design.

Steve Parr and I met with Charles Whitener, President of Westrex Corporation who proceeded to walk us to



JoLida SJ202A

various rooms where his new WE300B (\$350) reissue was being played in amplifiers. We listened to the new Jadis SE300B amplifiers with their new Jadis Eurithmic horn speakers (\$37,800/pr). The results were very impressive. According to Whitener, export demand for the tube has been great and he indicated that the tube would be available in limited quantities in America after April 1996. (See our 300B article in this issue for testing results on this tube.)



Some of the most beautiful looking and best sounding equipment was the line of WAVAC equipment from Japan. We met with their designer, Mr. Nobu K. Shishido who has been designing amplifiers since the early 1950s. He is the inventor of the Inverted Interstage Transformer Coupling used in these amplifiers. Their equipment was exquisitely detailed and used the latest high end Japanese circuitry including original Western Electric small signal tubes in the front end. Three stereo SE amps were available including the 300B (\$12,000), 4304 (\$22,500) and the 805 (\$45,000).

All of their amps featured a unique ventilated plexiglass cover for safety and to keep the dust off the chassis. They also displayed their beautiful ATT-S (\$5,000) and ATT-Q (\$3,800) passive attenuators.

Although a lot of the source material was from compact discs, records are still in vogue by the looks of the exquisite Thorens Prestige turntable.



Mr. Junichi Yamazaki of Triode Supply Japan, Ltd exhibited and demonstrated his new Plentious SE triode amplifiers. Apparently the Plentious amps can use the 300B, VV30B, the VT52 and many other types of filamentary triodes. These amps were beautifully finished in metallic torquoise blue and sounded great.



Plentious SE Amp

Dynaco is back in the tube business. Over in the main Las Vegas Convention Center, we met with Raymond Sassoon, Exec. Vice President of Dynaco/Panor Corporation. We listened to their new PAS-5 remote control tube stereo preamplifier and their new HDCD tube compact disc player. Both of these are reasonably priced and excellent performers. Dynaco has also re-issued the famed A-25 bookshelf loudspeaker using the original SEAS tweeters.



VTV Editor and Raymond Sassoon

One of our suggestions to the tube amplifier manufacturers: do a better job of matching your amplifiers to the loudspeakers. Steve and I went into several rooms where the amplifiers were three times larger than the mini-monitors they were being played through. The amps that should have sounded good sounded restricted and tinny.

Some of the best sounds came from rooms using large speaker systems. These included the new Sunlight Engineering Sunharts Mk II (\$36,000/pr), an excellent reproduction of the famed JBL Hartsfield speaker. This four way system featured all JBL drivers including an 18" woofer, 375 mid-horn, 175 tweeter and and 075 super-tweeter. The system driving them was a vintage McIntosh

MC275 amplifier and a C-11 preamplifier. The sound was big, airy and very satisfying.



Sunhart Mk II

The WAVAC room was driving huge JBL two way systems with two-15" JBL woofers and a horn driver in the middle. Using SE 805 transmitting triodes in the amplifier to drive these speakers produced outstanding realism and to our ears one of the best at the show.



WAVAC SE 805

A lot of the new speakers have the "tall pyramid" look and some were quite impressive sounding including the Gershman Acoustics Avant Garde (\$4,600/pr). These units are a three-way design using a custom made 8 inch Cambridge driver, a three inch dome



WAVAC Room

mid-range by Vifa and a fabric dome tweeter also by Vifa. There are two speaker cavities for the high and low frequencies and the bottom cavity is loaded with 22 kilograms of lead shot to reduce cabinet resonance. The speakers have the air and delicacy of Quad electrostats, but more solid bass.

New Tubes In Your Future?

VTV also met with Charles Gray, Vice Chairman, George Badger, President and other officials from Svetlana Electron Devices, distributors of Russian vacuum tube products. We discussed tube types they are going to be manufacturing later this year.

Owners of McIntosh MC225s, Fisher and Scott integrated amps and receivers can breath a sign of relief. Svetlana is planning to reintroduce the 7591A beam tetrode! The tube should be in production by late 1996 or early 1997 if not sooner. Other tubes they are working on include the type 5881 "Tung-Sol" type, the type 50 power filamentary triode and a few others that it's too early to announce.

All in all, the Winter 1996 CES was a great show for the growing vacuum tube audio business!



VACUUM TUBE VALLEY
SUNNYVALE, CALIF.

Be the first in your neighborhood to have an official VTV "BIG TONE" T-shirt.

2 color heart print on a blue spruce 100% cotton shirt. Only extra large available.

Only \$20. plus \$3.00 postage US CA residents add \$1.55 Sales Tax Canada and Mexico add \$8.50 postage Europe and Asia add \$15.00 postage

Cash, Check or Money Order No Credit Cards

Vacuum Tube Valley
1095 E. Duane Ave., Suite 106
Sunnyvale, CA 94086 USA

TUBES • LITERATURE • PARTS • SUPPLIES

YOUR COMPLETE SOURCE FOR...

TUBES:

Over 3500 audio, receiving, transmitting and industrial types in stock, including many foreign and early types. We offer the complete line of Svetlana audio, amateur radio and industrial power tubes.

TRANSFORMERS:

Hard to find power, filament and output transformers as well as filter chokes for tube equipment. We feature HAMMOND performance transformers, MagneTek and Thordarson as well as many new old stock transformers.

CAPACITORS:

High voltage electrolytic and mylar capacitors, multi-section capacitors and more for tube circuits.

PARTS:

Resistors, tube sockets, potentiometers, chassis boxes and aluminum enclosures, knobs, dial belt, lamps, diodes, speakers, wire, phonograph needles and cartridges and much more.

LITERATURE:

Extensive selection of literature and books on tubes, hi-fi equipment, circuits diagrams, communication gear and antique radios. Some items not available elsewhere!

SUPPLIES:

Grill cloth, cabinet restoration supplies, batteries, chemicals, tools, test meters, gifts and kits.

AUTHORIZED DISTRIBUTORS FOR

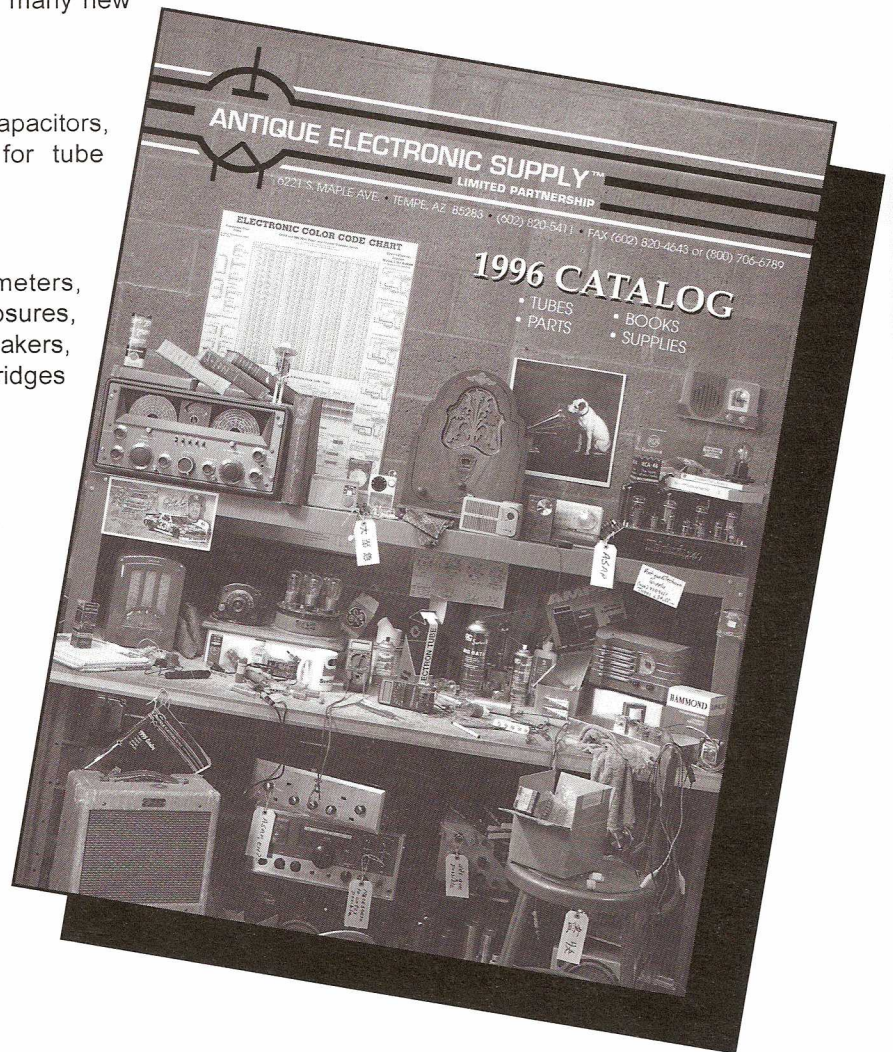

CALL OR FAX FOR OUR FREE 40 PAGE CATALOG

ANTIQUE ELECTRONIC SUPPLY™

LIMITED PARTNERSHIP

6221 S. MAPLE AVE. • TEMPE, AZ 85283 USA • (602) 820-5411 • FAX (602) 820-4643

NOVEMBER 1995

NEW SENSOR CORPORATION

20 COOPER SQUARE • NEW YORK, NY 10003
 (212) 529-0466 • (800) 633-5477 • FAX (212) 529-0486

USA MILITARY JAN TUBES *NEW, ORIGINALLY BOXED, AVAILABLE IMMEDIATELY*

TUBE NUMBER	1 PC.	10 PCS.	25 PCS.	50 PCS.	100 PCS.	500 PCS.	1000 PCS.
0A3 JAN	1.15	.90	.75	.65	.55	.45	.40
0C3W JAN RAYTHEON	3.65	2.90	2.30	1.90	1.60	1.30	1.20
5Y3WGTA JAN PHILIPS	4.90	3.90	3.40	2.90	2.60		
6AN8a JAN PHILIPS	5.90	4.70	4.20	3.80	3.15	2.60	2.30
6AS7GA JAN GE	6.15	4.90	3.50	2.90	2.55	2.20	1.90
6BJ7 JAN GE	2.00	1.60	1.40	1.20	1.00	.90	.80
6BL8 JAN SYLVANIA	1.65	1.30	1.10	.80	.65	.50	.45
6BQ7a JAN GE	2.00	1.60	1.35	1.15	.95	.80	.70
6C4WA JAN PHILIPS	4.70	3.75	2.90	2.30	1.80	1.65	1.55
6DJ8 JAN PHILIPS	3.65	2.90	2.30	1.60	1.40	1.15	.95
6EA8 JAN PHILIPS	2.00	1.60	1.35	1.15	.95	.80	.70
6J5WGT JAN PHILIPS	4.40	3.50	2.60	2.10	1.80	1.65	1.55
6L6GC JAN PHILIPS	21.50	16.90	16.20	15.40	14.90	14.40	13.90
6L6WGB JAN PHILIPS	19.90	15.90	14.90	13.90	12.90	12.20	11.80
6SJ7 JAN GE METAL	1.15	.90	.80	.70	.60	.55	.50
6SL7WGT JAN PHILIPS	7.40	5.90	4.90	4.40	3.90	3.60	3.30
6SN7WGTA JAN PHILIPS	7.40	5.90	4.90	4.40	3.90	3.60	3.30
6SQ7 JAN GE	3.15	2.50	2.00	1.50	1.20	1.15	1.10
6U8a JAN PHILIPS	2.00	1.60	1.35	1.15	.95	.80	.70
6V6GT JAN GE (GLASS)	12.40	9.90	9.50	8.80	8.40	7.60	6.90
6X5WGT JAN PHILIPS	1.90	1.50	1.35	1.20	1.05	1.00	.95
12AT7WC JAN GE	6.15	4.90	4.40	3.90	3.25	2.90	2.70
12AU6 JAN PHILIPS	1.90	1.50	1.25	1.00	.90	.80	.70
12AX7WA JAN GE	9.65	7.70	6.50	5.90	5.40	4.90	4.50
12AX7WA JAN PHILIPS	9.65	7.70	6.50	5.90	5.40	4.90	4.50
12SG7 JAN RCA	1.00	.80	.70	.60	.50	.40	.35
12SH7 JAN GE	1.00	.80	.70	.60	.50	.40	.35
12SL7JAN GE	1.25	1.00	.90	.80	.70	.60	.55
83 JAN GTE	875	7.00	6.40	5.80	5.50	4.90	4.65
829B JAN CETRON	8.55	6.85	6.25	5.65	5.35	4.75	4.50
5656 JAN RAYTHEON	7.50	6.00	5.00	4.20	3.30	2.50	2.20
5750 JAN GE	1.00	.80	.70	.60	.50	.40	.35
5751 JAN GE	6.15	4.90	4.30	3.90	3.20	2.70	2.30
5814a JAN PHILIPS	3.75	3.00	2.75	2.50	2.20	2.00	1.90
6072a JanGE - MIL 12AY7	9.65	7.70	6.50	5.90	5.40	4.90	4.50
6080WC JAN GE	6.15	4.90	4.40	3.90	3.40	2.90	2.60
6188 JAN PHIL -MIL 6SL7	11.15	8.90	7.90	6.40	5.90	5.60	5.30
6189W JAN PHILIPS	3.75	3.00	2.75	2.50	2.20	2.00	1.90
6922 JAN PHILIPS	4.25	3.40	2.80	2.10	1.90	1.65	1.45
7581a JAN PHILIPS	19.50	18.00	17.25	16.50	15.75		

MASTER CARD/ VISA ACCEPTED • MINIMUM ORDER \$100.00 • ALL ORDERS SHIPPED F.O.B. N.Y.C.

Announcing the availability of the original WE 300B electron tube.

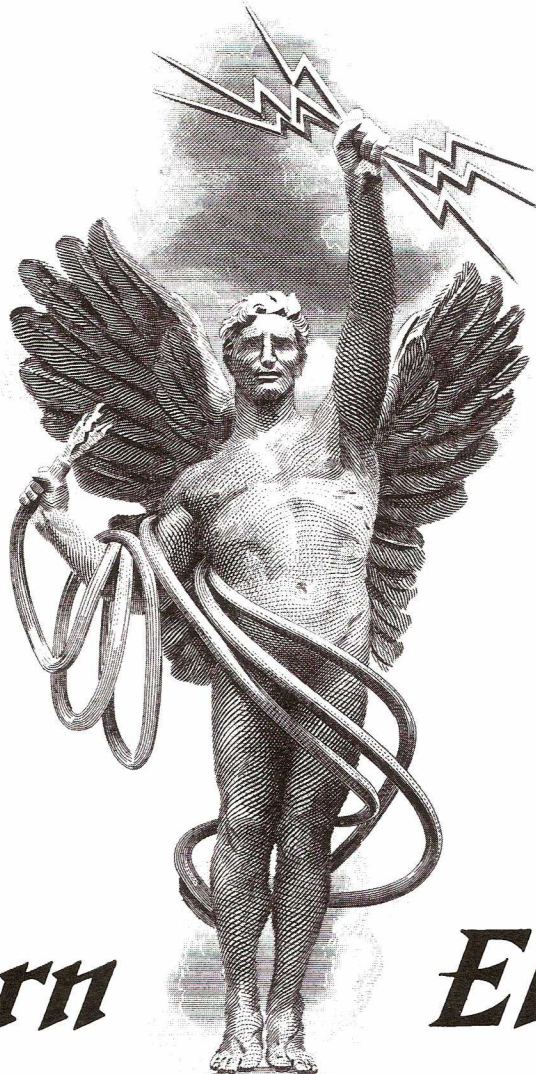

Western

Electric

Western Electric® • High Fidelity • Electron Tubes • Interconnects

Westrex Corporation • AT&T Promenade II • 1230 Peachtree Street • Suite 3750 • Atlanta, Georgia 30309-3575

Western Electric High Fidelity products are marketed worldwide exclusively by Westrex Corporation.
Western Electric is a trademark of AT&T licensed to Westrex Corp., a company independent of AT&T.
All Western Electric High Fidelity products are manufactured in the U.S.A.