

# VACUUM TUBE VALLEY™

Issue 5  
Fall 1996

Celebrating the History and Quality of Vacuum Tube Technology

Published Quarterly  
Price \$8.00

## In This Issue

### *The Ultimate Tuner Shootout*

*Looking for Big Tone on the FM Band*

*VTV evaluates many of the best tuners, both new and vintage, tube and solid state.*

### *Bendix Red Bank Tubes*

*1950s Guided Missile Tubes for Today's Amps*



### *Hi-Fi in Hong Kong*

*VTV takes a look at the vintage audio marketplace in Asia*

### *Uncle Eric's Deluxe SV8II*

*Single-Ended Amplifier*

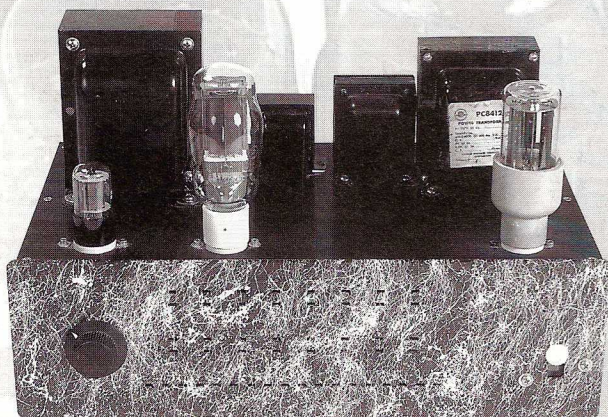

■ Editor's Page	2
■ Bendix Red Bank Tubes	3
■ FM Tuner Shoot-out	7
■ Vintage Hi-Fi in Hong Kong	14
■ Guitar Amp Book Review	17
■ Audio Signal Generators	20
■ Eric's Deluxe SV811 Amp Project	22
■ The Birth of the Marantz 10B	25
■ Cathode Bias - Buyer Beware	32
■ Rectification for Guitar Amps	33

**VTV Control Grid**

by **Charlie Kittleson, Editor**

**One Year and Growing**

Thanks to our readers and subscribers, VTV is celebrating its one year anniversary with a new, colorful cover design. We all hope you enjoy this issue.

Judging from all the positive comments we receive every week, our subscribers are pleased with VTV. Comments include: "the best audio magazine I have read"..., "I read every issue of VTV at least three times cover-to-cover"..., "great magazine!!". We strive to provide you with an interesting, quality read with accurate information so you can learn more about tubes, their development and how to use them to make the finest music.

Keep VTV growing and strong - tell your audio friends about VTV. Show them an issue, let them borrow it. Convince them to subscribe so you don't have to constantly lend them your issue. New subscribers are the lifeblood of any magazine and we can always use more tube electronics enthusiasts in our ranks. VTV has lots of great tube topics on the way and more interesting stories about vacuum tube pioneers from the past and present.

If you don't see VTV at your favorite bookstore or magazine rack, request that they carry it. Get your friends to subscribe. **Keep VTV Growing!!!**

**VTV Road Trip**

In August, John Atwood and I made a trip to the fatherland of tubes, "Vacuum Tube Alley" in Newark, New Jersey. We visited most of the original tube manufacturing sites in this area including Arcturus, National Union, Tung-Sol,

RCA and more. In addition, we visited Long Island City, New York and Boston, Massachusetts, locations of legendary hi-fi manufacturers including Acoustic Research, EICO, Fisher, Marantz, H.H. Scott and more. In the next few issues, we will be writing about our experiences and interviews while in this area. We even visited the "Fisher Doctor", Al Pugliese in Staten Island, New York. Al has given us permission to publish an article he wrote on the history of Fisher in a future issue!

**Eric Barbour, Tube Applications Engineer**

For those of you who haven't heard, our very own Eric Barbour recently accepted a position as an applications engineer at Svetlana Electronic Devices in Portola Valley, California. Eric is in charge of audio tube applications and development. Eric tells us that Svetlana has some very interesting tubes in the pipeline, including some of your favorites, such as an outstanding 6L6GC and a 300B that is a near-exact duplicate of the original item. In the next several months, VTV will be evaluating new Svetlana tubes and reporting on them.

**Northern California Tube Enthusiasts Group**

Our Technical Editor, John Atwood is current president of this non-profit, but fun group of individuals devoted to tube audio and perfection of music reproduction. Meetings are about every two

months and are held in various locations in the San Francisco Bay area and are open to the interested audio enthusiast. These are no dues, but in order to get meeting announcements, you must send John self-addressed stamped envelopes to: Tube Audio Enthusiasts, 65 Washington St. #137, Santa Clara, CA 95050.

The topic of the next meeting will be a comparison of eight inch high-quality speakers using tube amps. The meeting will be held at the Randall Museum in San Francisco, on Oct. 19, 1996. Contact John at 408 245-5428 for more information.

**VTV on the World-Wide-Web**

In August, VTV installed a web-site on the www. This is a good method to advertise our publication and other products to a potentially huge audience. From our site you can:

Subscribe to or renew your VTV subscription using your credit card

Learn contents of and obtain all back issues

Order Vintage Hi Fi Spotter's Guides and other products using your credit card

Download **free** VTV articles from current or back issues.

View our **free** tube electronics buy-sell want ads for subscribers and web viewers

Access several direct links to very **cool tube audio sites** from manufacturers, music and shareware providers.

Check it out. Dial up VTV's web site at:

**www.vacuumtube.com**

That's all for now. Enjoy Issue #5. We welcome your comments and suggestions. Also, any authors out there who want to get published, send us your manuscripts on tube electronics projects, audio history or related topics. Authors are compensated for published articles.



HH Scott 333 tuner

**EDITORIAL STAFF**

**Vacuum Tube Valley** is published quarterly for electronic enthusiasts interested in the colorful past, present and future of vacuum tube electronics.

Subscription is US\$32.00/year (4 issues) \$40/Canada and \$45/Asia and Europe **CASH, US BANK CHECK, CREDIT CARDS**

To subscribe, renew or change address call or FAX us at **(408)733-6146**.

**Charles Kittleson** - Editor and Publisher

**John Atwood** - Technical Editor

**Eric Barbour** - Associate Editor

**Steve Parr** - Art Director

**Julie P. Werner** - Copy Editor

Copyright 1996 **Vacuum Tube Valley™** and **Big Tone™** All rights reserved.

No part of this publication may be reprinted or otherwise reproduced without written permission of the publisher.

Send circulation and editorial correspondence to:

**Vacuum Tube Valley**  
1095 E. Duane Ave., Suite 106  
Sunnyvale, CA 94086 USA  
e-mail [triode@vacuumtube.com](mailto:triode@vacuumtube.com)

**Red Bank:  
The Ultimate Tube**  
By Eric Barbour

The fact is this: many NOS tubes have developed cult followings, because of the efforts of gurus to hype these tubes into godhood. Usually the tubes in question deserve the good reputation, especially given the poor quality of current Chinese tubes. So, consumers are exhorted to search out Tung-Sol 6550s, Western Electric 300Bs, Telefunken smooth-plate ECC83s, and a few other things. This has driven the prices of the things to outrageous levels. Thus, NOS dealers and collectors can profit handsomely. It all seems a bit gamey to me.

Well, now it's MY turn to hype... and I've chosen the truly *OBSCURÉ*.

There is a brand of tube that you have not heard of. The audiophile gurus know nothing of it. The vintage-guitar experts, ditto. Ask any of these "experts" about it and you get blank stares, or possibly a mumbled "it probably ain't no good..." and nothing more.

Why? Because they are running a scam. And their knowledge is limited to the kinds of tubes that old hams and TV shops once had in abundance. So their scam is sharply limited by their ignorance.

They don't know this brand of tube because it is EXTREMELY scarce in surplus or in industrial use. It was introduced in the early 1950s, and was used by virtually only one customer: the U.S. military. A few of the tube types this company made were commonly used in the electronics in early ICBM warheads. These tubes were used in missiles because they were the most rugged, overdesigned and extravagant tubes available. Their primary reason for existing was because the U.S. Air Force wanted super-tough tubes for use in missiles and avionics, in a steady supply. To win the Cold War, of course.

The identity of this mystery tube maker is so unexpected that tube "experts" will probably joke about it. But the fact is: these super-tubes were made by an obscure division of Bendix Aviation Corporation. The plant in which they were made was called Bendix Red Bank Division, Eatontown, New Jersey. Thus,

**DEPEND ON**



**RELIABLE ELECTRON TUBES**



With electronic controls taking over more and more operational functions in military and industrial applications, it is becoming increasingly important that the electron tubes used be dependable under extremely severe conditions. This applies particularly to installations in aircraft where tubes must operate reliably at high altitudes, while subjected to continuous vibration, varying voltages and frequent shock. Because of their advanced design and construction... born of never-ceasing research and special production skills... Bendix Red Bank Reliable Electron Tubes have the dependability necessary to meet these severe operating conditions. You can depend on our long, specialized experience to give you the right answer... for all types of regular as well as special-purpose tube applications. Tubes can be supplied to both commercial and military specifications. Call on us for full details.

*Manufacturers of Special-Purpose Electron Tubes, Inverters, Dynamotors, Voltage Regulators and Fractional D. C. Motors*

DESIGNATION AND TYPE					TYPICAL OPERATING CONDITIONS		
Type	Proto-type	Bendix No.	Description	Base And Bulb	Heater Voltage	Plate Voltage Per Plate	M.A. Load
5838	6X5	TE-3	Full Wave Rectifier	Octal T-9	12.6	350.	70.
5839	6X5	TE-2	Full Wave Rectifier	Octal T-9	26.5	350.	70.
5852	6X5	TE-5	Full Wave Rectifier	Octal T-9	6.3	350.	70.
5993	6X4	TE-10	Full Wave Rectifier	9-Pin Miniature	6.3	350.	70.
6106	5Y3	TE-22	Full Wave Rectifier	Octal T-9	5.0	350.	100.

Type	Proto-type	Bendix No.	Description	Base And Bulb	Heater Voltage	Plate Voltage	Screen Voltage	Grid Voltage	Gm	Plate Current	Power Output
5992	6V6	TE-8	Beam Power Amplifier	Octal T-9	6.3	250.	250.	12.5	4000	45. MA	3.5 W
*6094	6AQ5 6005	TE-18	Beam Power Amplifier	9-Pin Miniature	6.3	250.	250.	12.5	4500	45. MA	3.5 W
6385	2C51 5670	TE-21	Double Triode	9-Pin Miniature	6.3	150.	—	-2.0	5000	8. MA	—

\*Tube Manufactured with Hard (Nonex) Glass for High Temperature Operation (Max. Bulb Temp. 300°C.)



DIVISION OF



**EATONTOWN, N. J.**

West Coast Sales and Service: 117 E. Providencia Ave., Burbank, Calif. • Export Sales: Bendix International Division, 205 East 42nd St., New York 17, N. Y. Canadian Distributor: Aviation Electric Ltd., P.O. Box 6102, Montreal, P. Q.

they are called Red Bank tubes. Even though they were second-sourced by Tung-Sol and, later, Cetron, the "Red Bank" name sticks to all the special types in this series. You guitarists know what else was made in the Red Bank/Eatontown area...yes, Danelectro guitars and amps. No doubt the Danelectro engineer knew about the Bendixes, but didn't dare specify such expensive tubes for guitar amps.

You have to look a bit askance at "tube experts" who try to tell you what the "best" tubes are. They are biased in favor of something, often something they themselves have a few hundred of, hidden in a closet. All bets are off when you bring up Red Bank tubes, because they ARE the best ever made—from the standpoint of reliability, consistency and physical toughness. And as far as I know, NOBODY is hoarding Red Bank tubes, certainly not like 300Bs or Tung-Sol 5881s. And please don't wave those cute RCA "Special Red" things at me. Good they may be, but next to Bendix Red Banks they seem like pale imitations.

Red Banks were NEVER used in audio equipment. All of them were originally versions of some commercial prototype, but usually used a nonstandard base pinout. In the advertisement shown here, most of the types available in 1955 are shown. Note the many versions of the 6X5 rectifier, but the few signal or power types. So, no equipment known is wired for them, except possibly some scrapped ballistic-missile assemblies rusting in a junkyard somewhere.

Those few types usable for audio—the 5992 beam tube, 6094 beam tube, 6384 beam tube, 6385 and 6900 dual medium-mu triodes—can be retrofitted to guitar amps and high-end equipment, by rewiring the sockets. I was able to borrow some from John Atwood for the tests below (many thanks, John).

**6094**

This type seems more common than the others. Examine the photo carefully, and you will see nothing but wretched excess. This is a 12.5 watt beam tetrode, a small tube similar to a 6BQ5. Mica spacers would be more than adequate, yet all the spacers are made of ceramic. Note the numerous structural supports, just the ticket for 500g mechanical shocks in a missile. The glass envelope isn't regular glass at all, but Nonex, a type of silicon-boron "hard" glass only used for transmitting tubes and lamps which get very, very hot.

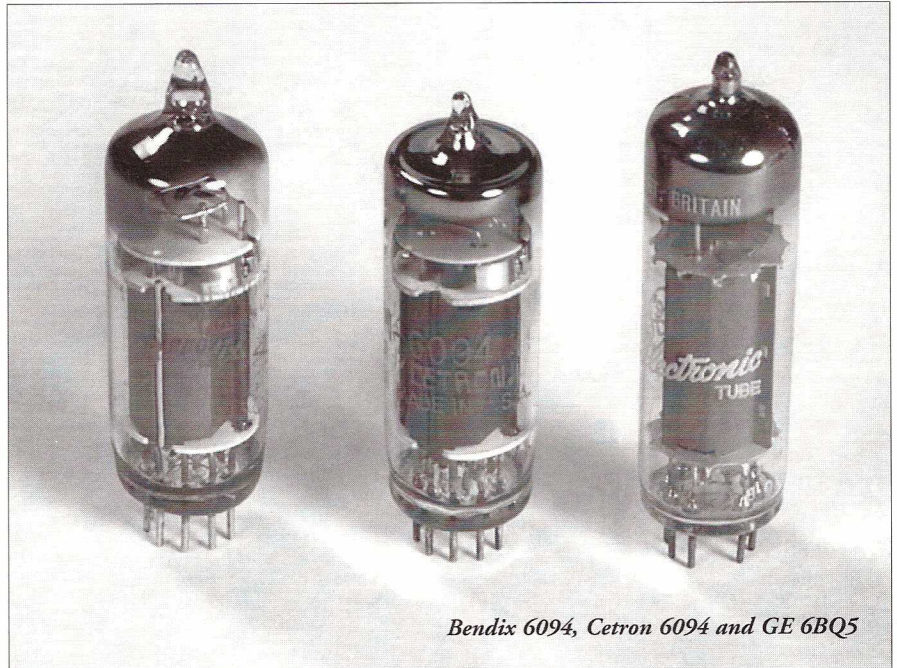

*Bendix 6094, Cetron 6094 and GE 6BQ5*

It's more difficult to see the cathode construction deep inside, but the heater isn't just coated with alumina, folded and inserted into the cathode sleeve. Instead, Red Bank engineers went back to 1928 for a vulgar, extravagant touch; the heater is threaded into tiny holes in a machined ceramic block, which is then inserted into the cathode. The only other place you'll see this is in very early indirectly-heated tubes like the UX-227. It was very costly, so as soon as the alumina coating was perfected, the ceramic block disappeared. Its use here is mute testimony to the purity of design practiced by Red Bank. It gives the 6094 a heater-cathode voltage rating of +/- 450 volts, and since the plate rating is 275 volts, you have to think that this tube is rated in a grossly

conservative fashion. This also gives a very long warm-up time.

The photo shows some of the variations of the 6094. The original Bendix Red Bank was the 1950s original, while Tung-Sol made a version from the late 1950s until its purchase by Webster Electric in 1970, and up until it closed its doors in the late 70s. The Cetron starts in the 70s and looks suspiciously like the Tung-Sol; the same tooling may have been used. Cetron 6094s apparently were made until the late 1980s.

I made two adapters to allow plugging 6094s into EL84/6BQ5 sockets. Although the EL84 has much more gain, the 6094 is similar enough to work well in a variety of EL84 amps. (*It is actually*



*Tung-Sol 6AR6, Bendix 6384 and Tung-Sol 5881*

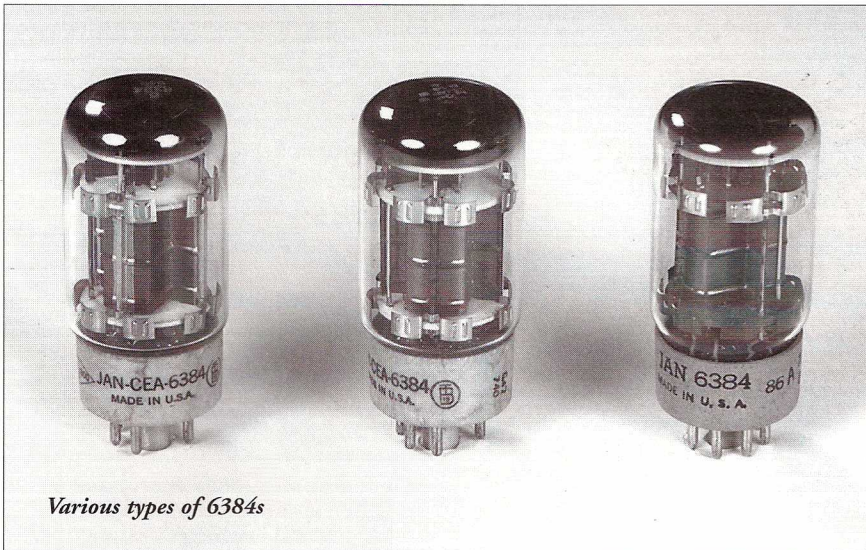

Various types of 6384s

more similar in characteristics to the 6CW5/EL86 – tech. ed.) But the pinout is different, as it is on most Red Banks. First a single-ended listening test was done, using the VTV test amp with no feedback and comparing with some EL84s.

We agreed in general on the EL84s; all had quite distorted and bloated bass, and highs that varied quite a bit. The Sylvania 6BQ5, from the 1970s, had modest detail and was very warm. The Sovtek EL84M was somewhat better balanced in sound, while the Yugoslavian EI EL84 had a glassy effect in the midrange and accentuated highs. All the 6094s were lower in voltage gain, but used virtually the same bias point at 300 volts. They were much clearer than any EL84, with clean bass, very nice highs and a

slight nasal quality in the mids. There were some small differences between the versions; the Bendix was a little softer-sounding while the Cetron and Tung-Sol showed a bit more treble detail and the Tung-Sol gave a “forward” effect to the drums.

Then a matched pair of 6094s was plugged into one channel of an Eico HF-86 amp. This is one of the finest-sounding EL84 stereo amplifiers ever made. The example was in near-new condition and was provided by our publisher. Upon comparison with a pair of fresh Mullard EL84s from the 1960s, the 6094s gave slightly cleaner bass and a less congested midrange. Imaging was excellent with both tube types. The difference was not as dramatic as in the SE test, and the difference in tube gain was less noticeable,

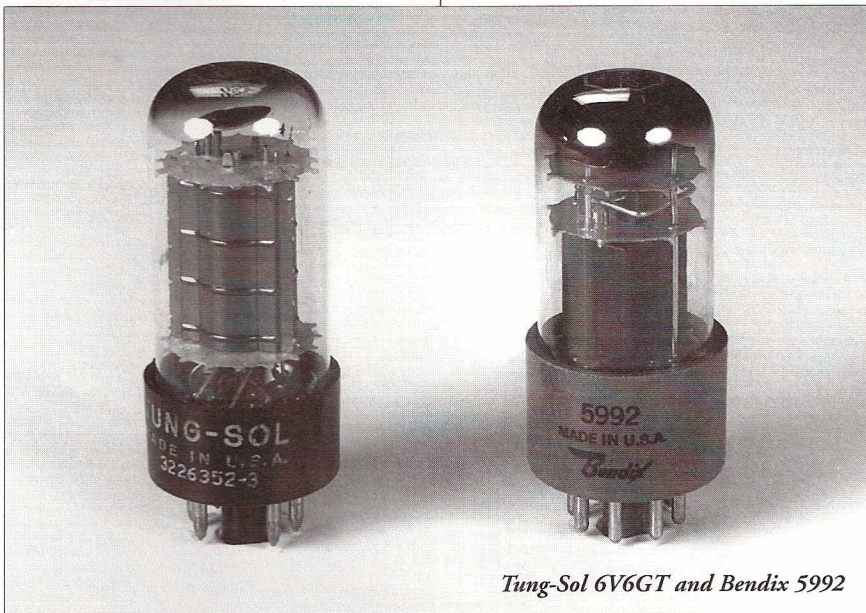

Tung-Sol 6V6GT and Bendix 5992

due to the considerable negative feedback in the Eico amp. Yet a small improvement was apparent.

Even though they sounded cleaner than EL84s, the 6094s gave considerably higher distortion readings on the test amplifier than typical EL84s. The distortion at 300v 40 mA, 1 watt into 3200 ohms, was on the order of 0.9% to 1.2%, while EL84s average around 0.9%. This load is rather severe for the 6094s and probably favors the EL84s. Peak power from the 6094s was about the same as from EL84s. *(The lower gain of the 6094 reduces the feedback in the amplifier, changing the sound and increasing measured distortion. - Tech Ed.)*

And for toughness, even the old 7189A is a toy. I put 500 volts at 40 milliamps on a 6094's plate, with 300 volts on the screen. It didn't even blink. No red spots on the plate or the screen, no creaking. Try that with any other 12-watt tube, and you'd better stand well back.

### 6384

The debate often taken up in various magazines, about which 6L6 type is “best,” seems a bit silly if the 6384 is compared to the available 6L6 types. Even the Tung-Sol 5881, Mullard EL37 and Genalex KT66 look like fragile and lightweight toys next to the Red Bank tube.

So it's safe to say: you won't see the likes of this tube again. The base is some kind of ceramic material, and is one of the few ceramic octal bases I have ever seen. The construction is the same luxurious style as the 6094, with all-ceramic spacers and a heater block. The pinout is the same as the obscure Tung-Sol 6AR6, a very similar tube to the 5881 physically but not quite the same electrically. Still, the 6AR6 or 6384 can be easily substituted into a 6L6 socket with rewiring or an adapter, and are rated closely enough to work well, though the 6384 makes the 6AR6 look pathetic.

Extreme scarcity means we had only one 6384 to test, a new-in-the-box original Red Bank. The plate rating is 750 volts at 30 watts, which is outrageous for a 6L6 type and more typical of the infamous Mullard EL37. Yet EL37s bring \$200 or more on the current NOS market, while 6384s are scarce but have nearly no value. It shows how narrow-minded the gurus can be. Simply rewire your amp's sockets, and you can use this “Beastatron.”

Tests showed that it is indeed a beast.

At 300v 50 mA, distortion was 0.77%, lower than that of a typical Tung-Sol 5881. Peak output was 9.8 volts, far more than most 6L6 types and even better than a KT66. It's a shame that so few modern hi-fi amps use 6L6s, as the 6384 is a hot little number. Oddly enough, the single sample made a chorus of tinkling sounds while heating up and cooling down. It didn't appear to affect electrical behavior. I briefly put 500v 75 mA into the tube, and it continued to work without showing red spots on the plate.

**5992**

I believe this to be the first-ever Red Bank electron tube. When it was introduced in May 1952, Bendix called it the "Eclipse-Pioneer" tube. This was because Red Bank Division started out as Eclipse Instrument Company, a maker of aircraft electrical generators in the 1930s. It's hard to find out why Bendix started making tubes there; knowledge was lost over the years and Red Bank Division itself is believed to be defunct.

The 5992 is a 6V6GT with balls. Although rated for 10 watts and 300

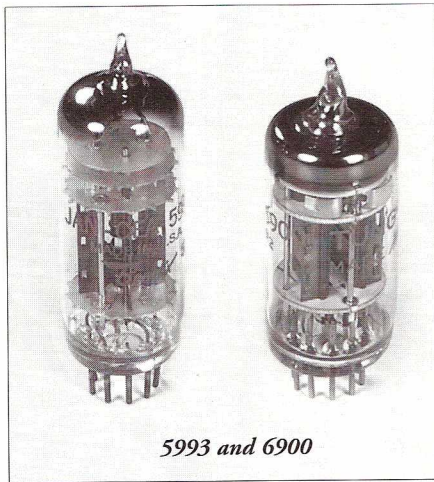

5993 and 6900

volts, its construction is the same kind of wretched excess. So it's probably safe to assume that this tube can take far more than the rated voltage. The pinout is identical to 6V6, so it can be used in 6V6 guitar amps with no changes. Unfortunately, some gurus have found the type in their GE tube manuals, so samples are very hard to find even by Red Bank standards.

**6900 and 6385**

The 6900 is a version of the 5687 medium-mu triode. Like the power types above, its construction is massive, though it does feature a mica spacer. It plugs

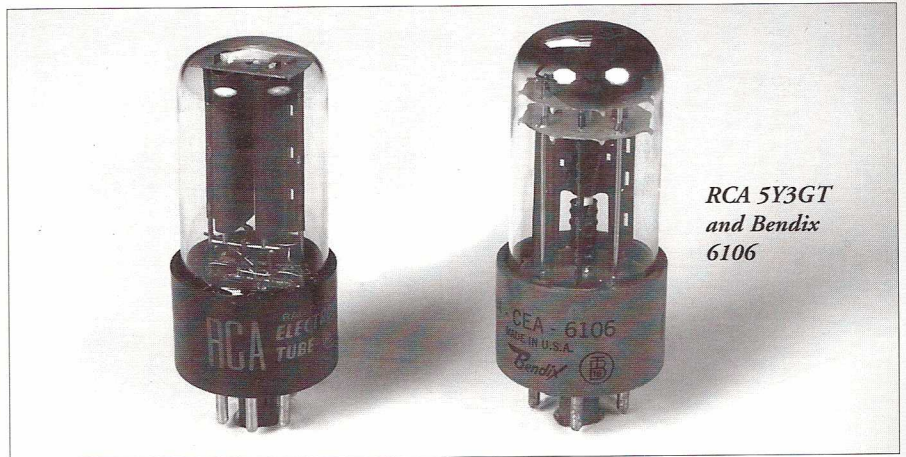

RCA 5Y3GT and Bendix 6106

right into a 5687 socket and works. Its transconductance is about twice that of a 5687, making the 6900 a very intriguing item for high-end audio equipment. I've seen a few in surplus, so some fairly common military radio gear must have had sockets for it.

The 6385 is a dual triode which can replace the 2C51/5670 VHF triode. Since the 2C51 is a good-sounding signal tube, the 6385 may make an excellent line amplifier. We did not have any to test, again due to its scarcity.

**5993 and 6106**

Some of the rectifiers made by Red Bank included the 5993 and the 6106.

If your equipment uses a 6CA4 or 6V4 rectifier, the 5993 is similar. It is much lower in plate-current rating than the common versions, but this may have been deliberate conservatism on Red Bank's part rather than a real limitation. The 5993 has a unique pinout, so the socket must be rewired.

6106 is the Red Bank version of the 5Y3GT. It is indirectly heated and has the typical overdesign seen in all the Red Banks. Again, it is very conservatively rated but appears usable for any 5Y3 application.

**Final Note:**

Red Bank tubes may be the ideal devices for the guitarist who loves music enough to buy only the very best. They were created to help destroy the "Red Menace," and represent Pentagon spending excess reminiscent of those \$700 toilet seats, in 1950s electronic form. At that time, one could buy a very good 6L6GC for \$3, while a 6384 (assuming you were permitted to buy one) was \$50 or more. Imagine someone today paying \$1000 for a 6L6, and you will get the

idea. It does seem more appropriate to use these expensive "Commie smashers" for making and listening to music instead. In a world drowning with advertising hype and ego, it's nice to know of something that is unquestionably "the best."

As a postscript, it does seem that Richardson/Cetron has made these tubes up until recently. So they may still have the special tooling, stowed away in the warehouse. If enough demand for Red Banks reappeared, Richardson might be interested in restarting production.

**Rewiring amp sockets to accept 6094s and 6384s:**

**6BQ5/EL84/7189A to 6094:**

- a) be sure pins 1 and 8 are open.
- b) lift wiring on pin 2 (grid), move to pin 1.
- c) lift wiring on pin 7 (plate), lift wiring on pin 9 (screen). Move screen to pin 7, plate to 9.
- d) lift wiring on pin 3 (cathode), move to pin 8.
- e) lift wiring on pin 4 (one side of heater), move to pin 3. Bias adjustment not needed but voltage gain of amp will be less.

**6L6 to 6384:**

- a) lift and relocate any wiring on pin 1 and 6.
- b) lift wiring on pin 8 (cathode) and move to pin 1.
- c) lift wire on pin 7 (one side of heater) and move to pin 6.
- d) lift wire on pin 2 (other side of heater) and move to pin 8.
- e) lift wiring on pin 5 (grid) and move to pin 7.
- f) lift wiring on pin 4 (screen) and move to pin 5.
- g) A small adjustment may have to be made to biasing. Note that 6384's heater draws 1.2 amps, so the power transformer must be capable of supplying the extra current.

**The Ultimate Tuner Shoot-out**  
By Charlie Kittleson

In late July of 1996, VTV held an FM tuner shootout at my house in the hills above the San Francisco Bay. The Northern California Tube Enthusiasts held their first tuner shoot-out at the same location in 1992. Richard Links, a club member, wrote a detailed article on that event that appeared in the May 1993 issue of the British audio magazine, *Hi Fi World*.

Present at the shoot-out were members from the Northern California Tube Enthusiasts Club and other local FM tuner experts including: Richard Links, John Beach, Roger E. Coon, Terry Buddingh, Earl Yarrow, Ray Stafford, Rich Curtis, Steve Parr, Eric Barbour and John Atwood. Everyone was required to bring their favorite FM tuner, either tube-type or solid-state. All told, there were over 25 tuners available for the group to evaluate. Before we get into the shoot-out, let's do a reality check on the state of FM broadcasting in the 1990s.

**Modern FM Broadcasting Conditions**

If you have a good tuner, your ability to enjoy FM broadcast music is limited by the quality of the signal from the station. During the early days of FM, station owners were very concerned about the quality and musicality of their signals. Also, many stations broadcast continuous music with very few commercials. In those days, FM often meant "free music." However, in the 1970s and afterward, all that changed with the buyout of many popular FM stations by media conglomerates who were mainly concerned about the bottom line. In short, that meant selling more commercials and broadcasting less music.

With the corporate bean counters at work, stations even got rid of live announcers by using pre-taped music shows and rebroadcasting them on several different stations. To reduce operating expenses even further, many stations no longer have a full-time radio engineer on staff. Now, they use consultants and contract technicians to maintain their studio equipment and transmitters. How many times have you heard signal problems with a station that goes uncorrected for hours? Throughout the 1980s and 1990s, stations owners looked for more

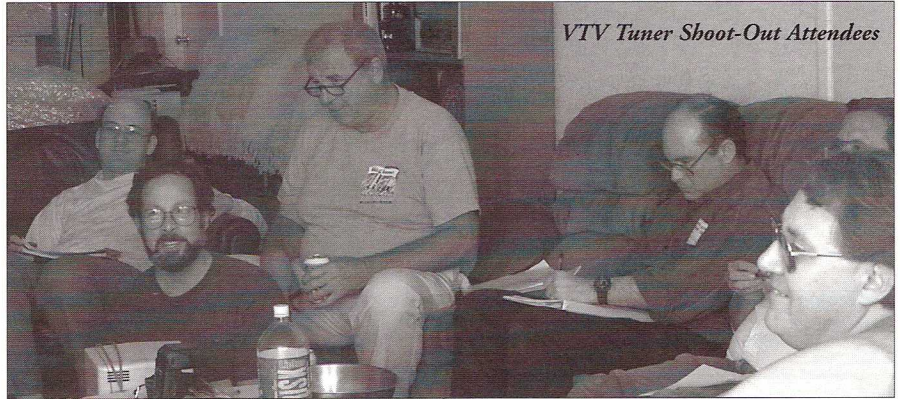

ways to cut costs including using cheap, digital signal processing instead of more musical (read more expensive) tube-type compressors and limiters.

**Factors in a high-quality FM signal**

**1. The quality of CD players and program material used by the station.** Many stations use inexpensive CD players with that "digital," strident and shrill sound. Stations that care about the music spend more money on high-quality CD players. Some college and jazz format stations not only use better quality CD players, they also use turntables to play vinyl!!! In addition, the recording engineering on finer classical and jazz recordings is superior to most rap and rock CDs.

**2. The quality of audio signal processors used by the station.** Most stations use solid-state digital compressors and limiters of inferior quality. They use either the Orban Optimod or the newer Digital Audio Processing (DAP) devices that tend to add a harsh, shrill and edgy effect to the music. Compressors are used to avoid wide swings in the signal before it goes to the transmitter. Many times these compressors introduce distortion because they are cheaply made. Again, stations that care about the music select high-quality compressors and limiters to enhance the musical tonality of the broadcast. The reason many college owned and jazz stations sound better is that they use little, if any, digital processing. You know the old saying - "Less is More."

**3. Whether the transmitter is being overdriven.** Lower power stations often use devices that boost the signal to make the station sound loud, like a higher power station. These devices include a wide variety of effects that overmodulate the signal for more volume compared to other stations, boost the bass (for rap stations), add echo and reverb effects and

other audio modifications. If these effects are used, they typically add distortion to the signal and can overdrive the transmitter. A listener can identify station problems by using a spectrum analyzer with an oscilloscope to determine whether a station is overdriving or overmodulating their transmitter.

One or more of the above problems typically manifests itself with an FM signal that is shrill and strident. Voices of announcers become sibilant and music has bass accentuated or has digital distortion which is dry and hard sounding causing listener fatigue. Hopefully, some radio station engineers or station owners will read this and address the problem. Hey guys, maybe if you improved your signal and played a little more music you could get more listeners and charge more for advertising!!! After all, there are many people with quality tuners who can still hear well.

**Factors for good FM tuner performance**

As a result of this tuner test, all who attended learned that FM tuners definitely sound different. There are noticeable differences between tube-type and solid-state. We all found that a typical solid-state tuner sounded flatter and more analytical than tube tuners, which were more live sounding and smoother. Other factors in FM tuner performance include:

**1. IF and Limiter Stages.** The bandwidth and number of IF stages is important, as is effective limiting at all signal levels. Alignment for constant phase shift over the IF passband is critical.

**2. Detector.** Both discriminators and ratio detectors can give good results, but good alignment is important.

**3. Multiplex section.** There are various types, including the early matrix and switching types, and the later solid-state PLL types. Correct alignment and

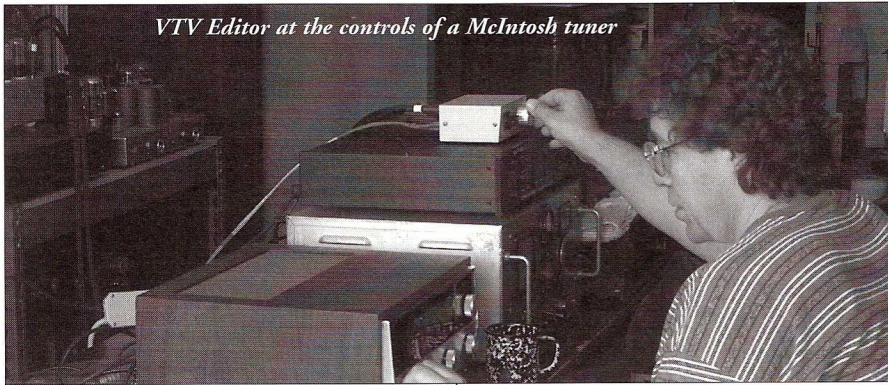

VTV Editor at the controls of a McIntosh tuner

component quality are main performance factors in the older designs.

4. **Audio output stage.** The design and quality of the output devices as well as whether tubes or transistors are used to drive the amplifiers. Cheaper tuners use low-cost opamp output devices, which often have problems with crossover distortion and are grainy or harsh sounding. Better tuners use either vacuum tubes or discreet transistors in the output stages. The quality of coupling capacitors is important.

5. **Antenna.** The type of antenna, placement and distance from the transmitting station affect both signal strength and multi-path distortion.

### The Setup

Because there are literally hundreds of different brands and types of tuners, both tube and solid-state, we were not able to sample them all. For example, we did not sample the McIntosh MR78 or MR80, the Citation III, the Onkyo, the H.H. Scott 350 or LT110, etc. The tuners we did evaluate belonged to the eleven attendees at the shoot-out. They came in various states of repair. Some were completely restored and aligned while others had languished in their owner's closet due to their high value and collectability. Tuners that showed up, but did not work well, were not included in the evaluation. Condition and state of restoration is described for each tuner. Some tuner owners wanted their units plugged in and warmed up before they were evaluated to reduce the potential for drift.

The results of this test may not reflect the ultimate performance of the tuners evaluated. For the purpose of this evaluation, however, their performance characteristics were compared to each other. Each tuner shoot-out attendee was given an evaluation sheet to rate each tuner on a scale of A to E with A being the best. Performance factors evaluated included:

*Mono Sensitivity, Stereo Sensitivity, Stereo Imaging, Tonal Balance, Detail, Noise and Multipath Rejection.* A subjective comments section was also included for each tuner. Both local and distant stations were tried.

### The Stations

San Francisco Bay is a major market for FM broadcast media with almost 50 stations. Over the last five to ten years, several of the FM music stations with a good signal and music format have been sold to media conglomerates. However, there are still a few good stations with a good signal and a high percentage of music time. We listened to a wide variety of music and stations, both local and distant. Stations we listened to included: **KCSM 91.1 mc**, a non-profit college station with a jazz-only format operated by the College of San Mateo about four miles north, **KKSF 103.7 mc** a jazz-new age station located in San Francisco about 24 miles north, **KDFC 102.1 mc**, a classical station located in San Francisco about 24 miles north, **KKHI 100.7 mc**, a classical station located in Marin County about 40 miles North; **KALW 91.7 mc**, an alternative talk and music station located in San Francisco about 25 miles north, **KUKI 103.3 mc**, all country format located in Ukiah, California, which is over 125 miles north. We tried a number of other stations typically located within a forty mile radius of my house. We also tried to DX stations from Sacramento, 100 miles to the east and stations in Monterey, about 105 miles to the south.

Due to scheduling, we had to schedule a second mini tuner-shoot-out on the following weekend because one of the members wanted to verify that his tuner was functioning correctly. We also tried a few other tuners that showed up. We learned that weather conditions definitely make a difference. During the first session, conditions were overcast and on the second session, conditions were sunny

and clear. FM reception performance was far better on distant stations with overcast conditions.

### The System

My main listening room is fairly large (18' x 45') and is located in the lower part of the house. Current speakers are late model Bozak Concert Grands which are three-way and include four-12 inch woofers, two-eight inch midranges and eight tweeters in a vertical array for each speaker. The system is bi-amped using a modified and upgraded Audio Research tube-type two way crossover set to 440 cycles.

Speaker cables are two sets of Kimber weave-type cables for the high and low frequencies. The high-frequencies are split inside the speaker using the Bozak passive crossover, which crosses over at 2500 cycles.

Low frequency amplifiers are a pair of 1954 Altec 1530A high-fidelity theater units rated at about 90 watts each. The front-end is a typical Williamson design using a 12AY7 first audio and a 6SN7 phase inverter. Rectifiers are dual 5R4GYs and the screen grid supply of the output tubes is regulated by dual voltage regulator tubes. The output stage uses two 6146Ws driving the original Peerless 16295 output transformer. These amps have been completely restored using new capacitors and tubes in all stages.

The high-frequency amplifier is a 1961 H.H. Scott LK150. This amp uses push-pull 6550B Svetlana output tubes and are driven by a 7199 triode/pentode. This unit has been totally rebuilt with new electrolytics and signal capacitors that are clear glass oil/paper type. All signal wire in the amplifier is silver plated copper with teflon insulation.

The line stage is a custom unit built by Eric Barbour and featured as the cover article "Brute Force in a Line Stage" in a recent Glass Audio article. Dave Wolze performed some modifications on the line stage to reduce gain and changed the tube complement to four-6SL7s with a 5V4G rectifier. Interconnects were Tara Quantum IV and Monster Cable 400s. All equipment was connected to a Power Science SOLID line conditioner. We used a Technics SLP-370 CD player to "calibrate" our ears to the system and speakers. An aligned and restored H.H. Scott model 335 multiplex adapter was used to provide stereo output from the mono tube-type tuners evaluated.



My house is located on top of a hill overlooking the Bay and has line-of-sight to both Oakland and San Francisco. The antenna used was a combination FM-TV dipole mounted on a 10' pole and beamed towards San Francisco (north). The antenna lead wire is 72 ohm coax. For some tuners, the coax was fed in directly, for others a 300 ohm balun adapter with lug terminals was connected to the antenna input.

OK, let's get down to business and listen to some tuners beginning with mono tube types, then stereo tube types and finally solid-state tube types. (The tuners were listened to in essentially random order).

### Mono Tube Type Tuners

While most people would consider a mono tuner outdated, some of these units have outstanding sound. Most mono tuners can receive an FM stereo signal when used with a tube-type multiplex adapter such as the Fisher MPX 100 or H.H. Scott 335. Outboard multiplex adapters were made for about three years from 1961 through 1963. However, there was a short period in the late 1950s when stereo tuners consisted of a dual tuner with one side of the signal receiving AM and the other side receiving FM. The system required the station to have two transmitters, one AM and one FM with each broadcasting a side of the program. This system was problematic from the beginning due to reception differences between AM and FM as well as other issues. While there are literally hundreds of vintage mono FM tuners, we sampled some of the most common and best sounding ones.

#### Fisher FM-90X

This was Fisher's first super performance FM tuner introduced in 1957. The tuner evaluated belongs to me and has been completely restored with new capacitors and tubes. The alignment was done about a year ago. This tuner was very sensitive and musical. It picked up distant stations with ease. Comments from the reviewers include: "nice balance,



FM-90X

musical and warm, lush, pleasant, rich mids, very listenable, very non-tuner like, nice, good budget item, best mono, good on stereo." Two of the reviewers felt that this unit was not aligned correctly, but most thought it performed very well.



R-202

#### Fisher R-202

The 202R was Fisher's most costly mono AM/FM tuner and was only made for about a year (1960-61). It is also very rare and few examples are known to exist. It features six IF stages and five limiters, very similar to a mono version of the FM1000 Fisher tuner. This particular unit was tested as found with no restoration or alignment touch-up. Comments from reviewers included: "good potential, lumpy frequency response, needs work, unrestored, just passable." Obviously, while this unit did not perform up to expectations, it should have been properly restored with new tubes, a recap job and a quality alignment for optimum reception. This will be done and featured in our next tuner shoot-out.



PT-1

#### Heathkit PT-1

This was a late fifties AM/FM binaural unit that had been restored and aligned by its owner John Atwood. These still can be found for reasonable prices at flea markets and through Audiomart. It was played in mono and in stereo using the Scott 335. Comments from reviewers: "good value, musical, slight 'radio' sound, smooth, good in stereo, super sleeper, very nice sound, OK but not up to any of

the others." For most, this is a good value tuner, but not up to the Fisher's or Scott's performance.

#### McIntosh MR-65

McIntosh made some excellent tuners and the MR-65 is no exception. The MR-65 was the second tuner sold by Mac, introduced in the late Fifties after their model MR-55 tuner. A stereo MPX adapter could be installed on later units and a full stereo unit, the MR-65B was sold in 1961. Our sample had been cleaned up and re-tubed, but not recapped or aligned. This tuner has a tube rectifier which adds to the sonic character. Comments from reviewers: "good sound, pretty good for listening, balanced sound." Most reviewers thought the tonal balance and detail was excellent.

#### Nems-Clark 1502



One of the original surveillance receivers used by our government to monitor commies in the Fifties, this unit tunes continuously from the broadcast band to well above the standard FM band. John Atwood obtained this unit from a local surplus store and carefully rebuilt and aligned it. The sound was somewhat clinical and dry. This unit is very sensitive, and was easily overloaded at the listening session. In addition, the tuner is not as musical as other home hi fi units or as forgiving with stations broadcasting a poor quality digital signal. This tuner or its derivatives might be good for monitoring spies or listening to the audio portion of some television stations, but it doesn't cut it as a home entertainment unit.

#### Radio Craftsmen RC-10

This company started after WWII and produced a line of quality audio components until 1955 when it became Sherwood. The RC-10 is an AM/FM mono tuner and preamp. We listened to a beautiful example that was in cosmetically excellent condition, but completely

RC-10



stock and unrestored. Comments from reviewers included: "bass is heavy, needs tuning, needs restoration for best results." This tuner has potential for being an excellent mono performer. You can even use it as a stereo tuner by taking the output from the detector jack and plugging it into the multiplex adapter. This RC-10 unit will be completely restored and evaluated in a future tuner shootout.

S-3000



Sherwood S-3000

This unit was Sherwood's first FM mono tuner offering from 1955. There were several variations and upgrades including the S-3000 II, S-3000-III, etc. Later versions were available in stereo. The S-3000 was played in mono and in stereo using the Scott 335. This tuner is a real sleeper from a sensitivity and sonic standpoint. Our sample was obtained from the original owner who was an engineer at Hewlett-Packard and bought the tuner new in 1956. It appeared to be original, but had probably been serviced over the years by the engineer. Sherwood used superior IF coils based on ceramic coil forms which tend to last much longer than the typical paper coil forms used by Scott and Fisher. Our Sherwood was very warm and musical and was very easy to listen to for long periods of time. It performed competently using the 335 MPX adapter presenting good imaging and detail. With a restoration job including new tubes, new capacitors and an alignment, this tuner has the potential for the most sound for the buck. Currently, you can find Sherwood mono tuners at electronic swap meets for \$50 or less.

## Stereo Tube-Type FM Tuners

One piece stereo tube tuners started to appear in 1961 when the FCC finally approved an FM stereo multiplex system. Some of the first units with on-board multiplex adapters included the H.H. Scott 350, Fisher FM 1000, etc. While it would be impossible to test every type of tube FM stereo tuner, we did obtain samples of the most popular types.

### Dynaco FM-3

A very popular and high-production tube stereo unit that replaced the original mono unit, the FM-1, the FM-3 was built by tens of thousands of audio hobbyists throughout the sixties. There have been a dozen or so articles written on how to modify and upgrade the FM-3. Our test unit was very clean, stock and sold as a kit. The original builder did a very good job of assembly, but apparently this unit had not been aligned recently. Comments from reviewers: "flat-sounding, congested, not very open sounding, the Sherwood is more musical." Sensitivity was average, but overall performance of this unit was below average, at best. With a parts upgrade and a good alignment, this should do better.



FM 100B

### Fisher FM 100B

This tuner was introduced in late 1961 and was mid-priced in Fisher's line. Our sample had been completely restored, recapped and aligned by John Atwood using VTV's H.H. Scott 830 factory MPX alignment generator. Our reviewers said: "balanced bass compared to other tube tuners, better than FM 200B and 4310, gorgeous, great detail, nice tube sound, excellent, warm and musical, balanced, a bit laid back, good budget value". Most people rated the mono and stereo sensitivity as excellent and tonal balance/detail as very good to excellent. It was obvious to all that a good restoration job can do wonders for an already good tuner.



FM 200B

### Fisher FM 200B

The FM 200B was one step down from the FM 1000, Fisher's finest. It used a 6DJ8 as the front-end and a pair of 6CW4 Nuvistors as the oscillator and mixer while the FM 100B used a 6AQ8 and a 6DJ8 "Golden Cascode" design. We had two samples of the FM 200B, one fully restored with premium capacitors (Rel-Caps), aligned and equipped with new tubes and the other in excellent condition, but tested as found with no restoration. Let's take the restored FM 200B first. Our reviewer's comments: "thinner sound than Mac, narrow bandwidth, closed-down and recessed, solid-state sounding, lousy sound, darker, not as lush or musical as MR67, more veiled, less compelling, smaller sound." Their comments with the stock FM 200B: "typical Fisher, warm yet lean, slightly more open than upgraded unit, less recessed, better balance than modified unit." This tuner, usually rated fairly high, did not score well in upgraded condition. Perhaps changing the caps to premium foil and film dried out the sound and possibly collapsed the soundstage of the tuner. Overall sensitivity was above average.

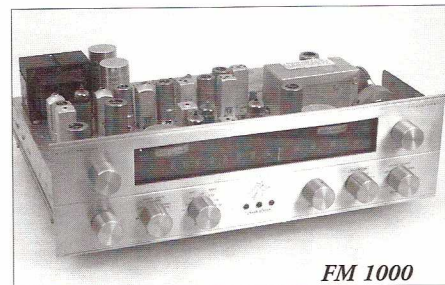

FM 1000

### Fisher FM 1000

As flagship of Fisher's tuner line, the FM 1000 has achieved collector status and is a highly sought after vintage tuner. The design has six IF stages and five limiters. FM-1000s came stock with a cathode-follower driver output stage for driving a strong signal long distances. The output stage consisted of two-EF86s driving a 6DJ8. Needless to say, this was overkill for the typical home audiophile

and the resultant sound was bloated and mushy. Our FM 1000 had been modified by removing the cathode follower drive stage and taking the output directly off the 12AX7 on the multiplex adapter. Comments from our reviewers: "nice balance, warm and sweet, non-tuner sounding, very musical and smooth, beautiful, a wonderful sounding unit, highly hot-rodged, second to 10B, best Fisher, beautifully balanced, good detail, less sensitive than 10B." We were not able to obtain a stock FM 1000 for the event--maybe next time.



**Marantz 10B**

This legendary tuner sets the standard in FM performance that all others try to live up to. Introduced as the Model 10 in 1962 and the 10B in 1964, it was produced until 1970 when it was replaced by the solid-state Model 20. The Model 10B has 22 tubes, a CRT used for tuning and multipath indication and six unique IF stages that were specially aligned at the factory. According to Marantz experts, only about 5000 10Bs were ever produced, making it very rare. Occasionally you can find one for sale in Audiomart or on the rec.audio.marketplace internet newsgroup. Current price levels range from \$1000 to \$2000. Our sample was in excellent cosmetic condition and well-maintained by its owner, John Atwood.

Reviewer comments: "relaxed, easy sound, less tuner sounding, balanced, easy to listen to, three-dimensional, life-like imaging, the best-bar none!, most pleasing overall, the ultimate!, fabulous, very open, best audio signal, clear, best imaging." Without question, this 10B performed flawlessly. When you close your eyes and listen to a 10B on a good station, it is as close to live music as a tuner gets. However, one should note that as with all tube tuners, the 10B is a collector's item that needs regular maintenance by a professional technician who is familiar with the peculiarities of this handsome unit. (For more information on the 10B see our interview with Syd

Smith and Dick Sequerra, the 10B's designers, on p.25). An interesting side-note - between 1976 and 1978, K101 in San Francisco broadcast four channel quadraphonic signals. Sacramento was the second location for the four-channel broadcast. They had to receive the signal in Sacramento perfectly in order to rebroadcast. Only a Marantz 10B tuner was successful in picking up the signal from San Francisco to Sacramento with good enough quality to be broadcast in quad.



**McIntosh MR67**

An updated version of the MR65B using a solid-state rectifier, the MR67 was a very popular and good performing Mac tuner. This was the first Mac tuner to use a Nuistor in the front-end circuitry. Our test MR67 belonged to Don Bartoni who was not able to make it in person, but sent his tuner. The unit was in excellent condition and basically stock. It appeared as though it may have been in storage for a while. Our reviewers rated this unit as follows: "excellent bass, very airy and musical, lush detail, warm-tube sound, more "live" sounding, very nice, life-like, works good on weak stations, pleasant, lush detail." They rated its sensitivity in both mono and stereo as excellent.



**McIntosh MR71**

McIntosh's last tube-type FM tuner, the MR71 is a beauty. It has one more limiter than the MR67, a better RF front-end, and better SCA filtering. This

unit was in excellent condition and stock. Probably aligned some time ago, but it performed well. Our reviewers said: "lush, broad bandwidth, relaxed, lacks detail, sort of laid back, better bass than MR65, more recessed than MR67."

McIntosh made quite a number of MR71s, so finding one in good shape won't be too difficult.



**H.H. Scott 310E**

The Scott 310E FM tuner was made for only one year, 1963. According to Scott's Chief Engineer, Daniel von Recklinghausen, it was their best performing tuner and his favorite. The circuitry is very similar to the legendary Scott 4310 tuner, but with fewer features, such as separate audio meters and other controls. This tuner has exceptional sensitivity and great imaging. The test unit was stock except for being re-tubed with fresh tubes. It was not aligned or rebuilt. Our reviewer's comments were: "open sounding, great potential, needs alignment, bright, not as musical as others."

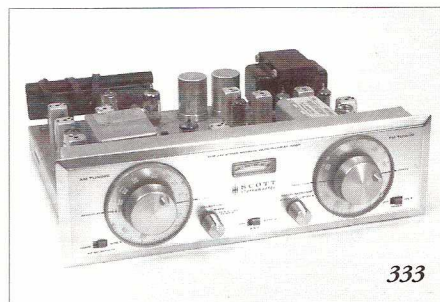

**H.H. Scott 333**

This tuner was the final evolution of the long-running Scott 330 series. It featured dual dials, one for AM and one for FM. The main difference in the 333 is that it featured an on-board multiplex adapter so it could receive FM stereo. The 333 was made in 1962 and the 333B, a later version with different front

panel styling was made in 1963. Our test unit was in excellent cosmetic condition with fresh tubes, but had not been aligned or rebuilt. Our reviewer's thoughts: "weak bottom, narrow sounding, needs work, boomy bass, veiled, warm, mid-bass hump, not even close to the 310E."



4310

**H.H. Scott 4310**

At the peak of tube tuner technology, Scott introduced the 4310 in 1963. This device is tube technology excess at its finest. The 4310 features diversity reception, individual channel level controls, dual audio output meters, 20 tubes and more in a very impressive package. Scott 4310s are very rare and command prices well in excess of \$1000 today. Our review unit was in excellent condition and was unrestored, but with good tubes. Our reviewer's thoughts: "the best for listening to FM, very clear sounding, open, forward midrange, wide tonal balance, overall-impressive, outstanding tube tuner, lacked detail, very liquid and juicy sounding, warm and smooth, rich, musical, lush, very open, less full sounding than MR67."

**Solid-State FM Tuners**

Even though VTV is dedicated to tube technology, we thought it would only be fair to compare some of the finest modern solid-state tuners in the shoot-out. A number of the shoot-out attendees brought quality transistor tuners with them to compare to the tube units. Again, with literally hundreds of solid-state tuners out there, we were able to obtain some of the most expensive and popular units on the market. If your tuner is not listed here, don't feel bad, we just didn't have access to it for the shoot-out.

**Accuphase T-100**

Accuphase are very high quality components made in Japan. They are extremely well-built and perform quite well, especially their tuners. Unfortunately, not many of them were sold in the US, so finding used



T-100

Accuphase equipment may be challenging. Our Accuphase tuner was probably built in the 1980s and the current owner has had it in his system for several years. He actually found it at a Goodwill store for \$35!!! This tuner was not aligned or rebuilt for the shoot-out. Reviewer impressions: "extremely well-balanced, musical, bright in the middle, surprisingly good, very hi-fi, detailed, comparable to Sequerra, quite fresh, better sounding than Fisher or Mac tuners, wide imaging, open, liquid sound, leaner than Sequerra."



Day-Sequerra

**Day-Sequerra**

For a long time, the Day-Sequerra was the ultimate FM tuner after the 10B became unavailable. Our unit was about 3 years old and was very attractive. This unit featured a large scope tube for tuning and multipath indication and switchable FM bandwidth. Our reviewer's comments: "most hi-fi, good balance,



AJ-1600

open-forward midrange, most listenable transistor unit, very clear, good sensitivity." This tuner is no longer being made, but in its day, it was the most expensive tuner available.

**Heathkit AJ-1600**

Heathkit produced dozens of great audio kits, both tube and SS. The AJ-1600 was sold in 1978. Our review unit was assembled from a kit. It belonged to John Atwood and was not rebuilt or aligned recently. Our reviewer's thoughts: "for a late 70s unit-very impressive, very good sound, musical, solid-state dryness, not as musical as tube-types, good balance, very good-but still slight transistor sound, recessed, lacks bottom."



Etude

**Magnum Dynalab Etude**

This tuner is currently being manufactured by Magnum-Dynalab which was very kind in allowing us to evaluate this tuner and its MD-108. It is a handsome unit with three illuminated meters for tuning and center of channel. Some of our reviewer comments: "upward tilt, less bass, more detail, dry-sterile, not lush, compressed, quasi-distorted, handles noise OK, rolled-off, rough, un-musical." These comments were very predictable from the group of "tube heads" we assembled. The Etude faced tough competition from the tube units, but it was very sensitive and performed flawlessly. It is also available from your favorite audio retailer and has features not found on lesser modern tuners.



MD-108

**Magnum Dynalab MD-108**

The MD-108 is the ultimate statement in modern FM tuners. It retails for \$6000 and is a most impressive unit with two large meters and a unique tube-type four section eye indicator. According to its designer, the MD-108 uses high quality capacitors, resistors and discreet transistors in the circuit. It even has a tube-type audio stage using two-12AX7s!!!

Some of our reviewer's comments on the MD-108: "the best solid-state, not as dynamic as tube units, the best yet, hyper detail though overpriced, similar to but warmer than the Accuphase, great balance, hi-fi detail and clarity, very musical, very hi-fi, not as warm as the MR67, airy and lush detail."

I had a chance to live with MD-108 for a few weeks and fell in love with it. It truly is a dream to operate and was extremely functional with huge tuning and antenna switching knobs as well as real toggle switches for mono-stereo, bandwidth, muting, etc. It was extremely sensitive, detailed and had superb noise rejection. The MD-108 was also very adaptable to a wide variety of reception conditions, a feature not found on the older tuners. The great thing about the MD-108 is that you can still buy a new one. Plus, it has tubes in it!!! If you truly enjoy FM and can afford the very best, the MD-108 is for you.



Model 20

**Marantz Model 20**

After the 10B was discontinued in 1970 or so, the Model 20 replaced it. Featuring discreet transistor circuitry and high quality components, the 20 was a top performer in its day. Like the 10B, it featured an oscilloscope indicator for multipath and tuning. The sound of the 20 is very tube-like after it warms up for about an hour. "Very detailed, with excellent imaging and sensitivity" was one of the comments from the reviewers. The 20 is a well-made follow-up to the legendary 10B.

**SAE T-101**

When digital tuners came on the scene in the early to mid-eighties, SAE was there with a number of tuner products. The T-101 was produced in that time period and was a styling match to their preamplifiers and amplifiers of that era. Here is how our reviewers felt about it: "handles noise poorly, needs a strong signal, very grainy sounding, not very sensitive, similar in performance to con-

temporary digital tuners, downward tilt, stuffy, lack of detail." This tuner was not in the same league as the Dynalabs or the Accuphase.

**Sansui TU-9900**

Sansui produced a wide variety of audio products in the 1970s. The TU-9900 was made in the late seventies and was most likely its top-of-the-line tuner in that era. It was a handsome unit and performed very well. Some of the reviewers comments were: "balanced, comparable to modern tuners, smooth, balanced, excellent noise rejection, similar to MR-71."

The Sansui TU-9900 and other top-of-the line 1970s Japanese solid-state tuner from Pioneer, Onkyo, Kenwood and others are typically excellent performers with lots of features. They can be found at flea markets and thrift stores for a bargain.

**The Winners are:**

While every comparison test between audio gear has variations, we tried to be as fair as possible by having a large group of evaluators. Some of the tuners may have not been up to spec for the shoot-out, but that was difficult to control as these tuners all belonged to private parties and we did not have the time or resources to completely rebuild and align every unit for this event. However, the group did come up with their picks for the best in specific categories.

**Best Mono Tuner**

Without question, the Fisher FM-90X was the winner in this category, hands down. It was extremely sensitive, selective and musical. The 90X was the first Fisher tuner to use the "Golden Cascade" front end circuit using a 6DJ8. One could almost give up FM Stereo for the 90X. These tuners can still be found and are typically priced from \$75 to \$175 depending on condition.

**Best Bargain Tube Stereo Tuner**

The Fisher FM100B was the winner in this category. Comments like: "gorgeous, nice tube sound, detailed, more bass than other tuners" came from the group. This unit was completely restored and aligned by John Atwood so performance was optimized. However, these tuners have been known for their great sound by tuner enthusiasts for years. The FM100B is not too rare and does show up in price ranges from \$90 to \$250 depending on condition.

**Most Sensitive Tube Tuners**

These were the tuners that did the best on distant stations with minimal noise, great selectivity and excellent sensitivity. Our group picked: Scott 310E and 4310, McIntosh MR67 and Marantz 10B.

**Best Bargain Solid-State Tuners**

This group of tuners performed extremely well and can be found at reasonable prices: Heath AJ1600 and Sansui TU9900.

**Best New FM Tuner**

Without question, the Dynalab MD-108 was the hottest new tuner at the shoot-out. It was the best sounding and one of the most sensitive solid-state units in the event. It even has a vacuum tube audio output stage! It performed flawlessly and was extremely musical. This tuner had good depth, was clear but not overly spacious or overly analytical like some other high-end solid-state tuners.

**Best Overall FM Tuner**

For those of you who own one, this is a no-brainer. Ten out of the eleven attendees voted the Marantz 10B as the overall best FM tuner at the shoot-out. Comments like: "the best, bar none, fabulous, most musical of all, 3-D sounding" tend to express their views. The 10B is one of those tuners that let you close your eyes and imagine the turntable playing directly into your system. It is very life-like and has tremendous depth and soundstage. The 10B is also very rare, expensive and hard to maintain.

**Conclusion**

All of the tuners reviewed have their merits, but some are clearly better performers than others. If your tuner wasn't evaluated, write us and we will try to locate one for the next tuner shoot out.

**VTV is now on the Web!**  
 When you are cruising the world-wide web, dial up VTV. Our URL is:  
**www.vacuumtube.com**  
 Free articles to download  
 Free on-line want ads  
 VTV Products and Back Issues  
 Subscription Information  
 Links to Cool Tube Websites  
 Have some fun and learn something  
**Tell your friends about our site**

**Vintage Hi-Fi in Hong Kong**

By Rick Graves

Have you complained to your friends that vintage hi-fi gear is much scarcer than it used to be? Have you gone to the swap meets only to find junk when you are lucky, and nothing most of the time? Have you heard that all the good stuff has been shipped overseas, mainly to destinations in Asia? *It's true!*

I had some vacation time that I had to take or I would lose it. Early in 1996, a friend said he might have business in Hong Kong in June, and asked if I would like to come along. I had never been to Hong Kong, so I said "Sure!" However, my friend's business plans did not come together. Under the ultimatum, "Take it or lose it!", I decided to go to Hong Kong on my own. I happened to mention my plans to Charlie Kittleson, publisher of VTV. Charlie suggested that I investigate the vintage hi-fi scene there, and find out what is *really* going on in Hong Kong. "Great idea!", I said. I had a front for going to Hong Kong.

Armed with the Lonely Planet Hong Kong guidebook and Traveler's Tales Hong Kong, I began reading up before my trip. I learned that one thing is in the forefront of everyone's mind: Great Britain will give up Hong Kong in 1997, and Hong Kong will become part of communist China. True, China has "promised" to keep Hong Kong the way it is, and to allow Hong Kong "a high degree of autonomy" in its internal affairs. But who would want to live under China, once having tasted economic and cultural freedom? Is it true that all the rich have already left Hong Kong for Canada? Be that as it may, there are 6.2 million people left in Hong Kong. (Enough politics.) Hong Kong residents use the shorthand "1997" to refer to the Chinese takeover on July 1, 1997. (Rumor has it that all Hong Kong hotel rooms for that night have been booked solid for years!)

So I arrived in Hong Kong in the middle of June, and began looking for vintage hi-fi. Walking around the shopping arcades, I found high end, tubes, and mass market gear. But I seemed to be getting nowhere in my search for vintage gear. At first, the leads Charlie had given me had not panned out, and I was just a tourist. I found the electronics street market in Sham Shui Po, under the flight path of the Hong Kong airport.



*Mong Kok Hi Fi District (Outside of Prosperity Bldg.)*

There, all kinds of electronics and electrical items are for sale. You can buy new hi-fi equipment (receivers, CD and video cassette players, speakers, interconnects) from vendors selling out of street stalls. This is also the location of the Golden Computer Arcade, which Bill Gates has been complaining about. Inside are dozens of small shops selling pirated software at prices just above the duplication costs. I priced Microsoft Visual C++ on CD ROM at about US \$4. The address for one of the vintage hi-fi leads that Charlie had provided was in this district, but I could not find it, even with the help of Hong Kong police.



Finally, I connected with Allan Yee at Excel Hi-Fi, located just blocks from my guest house in Tsim Sha Tsui. He invited me over to his shop the next morning. Mr. Yee brought me into the listening room, and surrounded by Audio Research, Fourier, Magnepan, and other high end brands, told me his story. He had been in the business for many years. For example, at one time, he had carried gear by Heath, and he recognized the W-6 on the cover of the Fall 1995 VTV. Because his shop takes trade ins, he has maintained contacts in the used gear side of the business. The shops do not open until 2:00 PM, and are hard to find, so he offered to take me there later that afternoon.

We met that afternoon, and headed uptown via the MTR (we would call it the subway, but in Hong Kong, "subway" means pedestrian underpass). We first went to Sun Wah Hi Fi, the largest used audio gear store in Hong Kong. The shop was small by American standards, but it was stacked to the ceiling with hi-fi gear. There were a few vintage pieces, but most of the merchandise was of more recent manufacture. We did not stay long, because their air conditioning had just broken down, and the temperature inside was pushing 100 degrees F (38°C). From there, we headed back downtown on foot to the Mong Kok district. This is the location of the ladies' clothing street market on Tung Choi Street. Along Tung Choi Street, in the midst of the street market, we came to Nelson Street, and the Prosperity Building (see picture). The Mong Kok Hi-Fi Centre, a conventional hi-fi shop, is at the corner of Tung Choi and Nelson Streets.

As we came up to the building, I noticed the Audiotronics sign above Nelson Street, and pointed this out to Mr. Yee. The sign cleverly spells "Audiotronics" with a drawing of a tube instead of a capital "A." I had an appointment to visit with Simon Lee at Audiotronics at the end of my stay in Hong Kong. On my first day in Hong Kong, while fighting off jet lag, I had found the corner and the sign, but I could not find the shop. I asked at Mong Kok Hi-Fi Centre, and had even brought one of the salesmen out into the street to point at the sign and to ask where the shop was. No one knew. Mr. Yee said "Later."

From Nelson Street, Mr. Yee first took me downstairs into a small shopping arcade in the basement level of the



*Gear on display at Audiotronics*

Prosperity Building. There is located Charles Audio Company, a listening room shop specializing in Marantz and McIntosh vintage gear (see pictures). Charles is a former barber and audiophile, who decided to open a vintage gear shop with the assistance of his wife, Ann. After introductions there, Mr. Yee took Charles and me out onto Tung Choi Street to the main Prosperity Building entrance, and upstairs to the third floor, to Soundcity Audio Company. There, Mr. Yee knew the proprietor, Michael Lee. In addition to McIntosh and Marantz gear, Soundcity had gear from other US brands in stock (see pictures). After introductions and pictures, I thanked Mr. Yee for his assistance, and allowed him to return to his shop in Tsim Sha Tsui.

On this day and on subsequent days, I visited the various vintage hi-fi shops in the Prosperity Building. As you can see from all the pictures, there is a wealth of collectable vintage hi-fi gear available for sale in Hong Kong. All the proprietors were kind enough to allow me to look around and answer my questions about prices and the market in general. A complete list of all shops, addresses, phone numbers and fax numbers is included at the end of this article.

Audiotronics was the first vintage hi-fi shop in the Prosperity Building, and they are the only shop to have a sign outside. Mr. Simon Lee from Audiotronics was very helpful. The other shops have located there more recently. One shop I visited had recently moved from elsewhere, and did not have new business cards yet. I had an incomplete address for one shop in the Sham Shui Po district, which I had searched for without success, only to find the shop in the Prosperity Building. It seems the vintage hi-fi business is concen-

trating there. Mr. Yee informed me that there were some other such shops in Hong Kong. If you visit at some point in the future, more shops may have relocated to the Prosperity Building. My personal theory on that relates to the ladies' clothing street market outside. When a couple comes to the Prosperity Building, the wife can shop for clothes while the husband shops for vintage gear, tubes and parts.



*Tubes at Audiotronics*

Most of the amps and speakers were from the United States, and almost all of the rest were from England. I only saw one amp from Europe, a Telefunken from Germany. From my experience on the West Coast, there was somewhat more gear from England in Hong Kong than you find in the States, but not a lot more. The one exception is the Rogers LS3/5A, which is popular in Hong Kong (I assume) because they are so small. (Hong Kong apartments are small by US standards.) I had heard of the LS3/5A, but I am not aware that I have ever seen one in the States. The tubes were both from the States and from Europe. About half of the box designs were familiar, the rest were not. Allen-Bradley carbon composition resistors seem to be much more popular in Hong Kong than they are in the States.

I asked about prices on many of the amps and preamps popular in the states and available for sale in the shops, and these are set forth on the accompanying table. (All prices were quoted in Hong Kong dollars, and converted to US dollars at the exchange rate then in effect, 7.725 HK dollars per US dollar.) From the asking prices quoted, it would appear that most Hong Kong prices are higher than Audiomart prices in the States by perhaps 20% to 30%. Considering the shipping costs and customs duties, this is not a big margin. Virtually all of the proprietors stated that the market for vintage gear was flat to declining in Hong Kong. Their feeling is that the market is mostly saturated. Some stated that the demand was high for the sought after pieces from McIntosh and Marantz in mint condition. Consecutive serial numbers on mono components is a selling point.

I did not attempt to get prices on tubes or other small parts. Next time!

**Typical Vintage Hi Fi Prices in Hong Kong** (In 1996 US dollars)

ACRO UL II	pair	\$1,040
Altec 19	pair	\$3,620
Altec 1568	pair	\$1,040
Altec 341A	pair	\$1,230
Altec 511 & 808	pair	\$840
Altec 604C w/cabs	pair	\$1,550
Altec A-340	pair	\$1,170
Altec A-350	pair	\$1,170
Altec A-7 w/ drivers	pair	\$3,620
Ampex 6516R2	pair	\$910
Craftsman C400	pair	\$650
Craftsman C500	pair	\$1,040
Dyna FM-3	pair	\$130
Dyna PAS-3	pair	\$260
Fairchild 260	pair	\$1,360
Fisher SA-300	pair	\$450
Harmon Kardon Cit II	pair	\$910
Heath W-1	pair	\$1,040
Heath W-4	pair	\$620
Heath W-5	pair	\$670
Heath W-6	pair	\$1,810
Heath W-7	pair	\$520
Heath WA-P2	pair	\$320
JBL 075	pair	\$580
JBL 375	pair	\$1,550
JBL D130	pair	\$520
JBL D150	pair	\$520
JBL LE 075	pair	\$520
JBL LE-15A	pair	\$780
JBL LE-15A	pair	\$780
JBL LE-8T	pair	\$390

Leak St-50,Variscope	\$1,170
Marantz 1 pair	\$3,880
Marantz 10B	\$1,940
Marantz 2 pair	\$3,880
Marantz 5 pair	\$2,330
Marantz 7	\$2,850
Marantz 8b	\$1,290
Marantz 9 pair	\$10,360
McIntosh 225	\$1,170
McIntosh 240	\$1,940
McIntosh 275	\$3,880
McIntosh C-11 preamp	\$1,170
McIntosh C-20 preamp	\$1,170
McIntosh C-22 preamp	\$1,940
McIntosh C-8 pre pair	\$650
McIntosh MC-30 pair	\$1,040
McIntosh MC-60 pair	\$1,550
McIntosh MC-75 pair	\$1,290
McIntosh MI-200 pair	\$9,710
McIntosh MX-110 nocab	\$780
Rogers LS3/5A pair	\$540
Stancor 2-chassis amps pr	\$650
Stromberg-Carlson pre	\$390
Tannoy Arden pair	\$2,330

*Note: The above prices are retail selling prices in a foreign market. Prices for similar American items in the US will be typically 30 to 40 % less due to shipping and retail mark-ups. Ed*

Some vintage audio proprietors said they were making the rent on sales of tubes and service. Simon Lee at Audiortronics showed me a 300B manufactured in China which he is marketing, which he states is better than the Chinese 300B's previously available. (I promised I would ask Charlie Kittleson to evaluate this tube against the new WE 300B, when the latter becomes available.)

Do it yourself (DIY), single ended amps using vintage transformers and parts are popular now in Hong Kong. Those are popular here also, but the emphasis there is on use of vintage transformers and parts, more so than in the States (to my knowledge).

I wondered if the impending return of Hong Kong to China, on July 1, 1997, was impacting the vintage audio business. Perhaps because many of the most wealthy Hong Kong Chinese have left for Canada, there is less disposable income there pursuing the available supplies. From what I have read, most business people still in Hong Kong are discounting and downplaying the impact of 1997 on business there, and I found that to be the case among the vintage hi-fi proprietors. From what I could tell, 1997 was



Wall of gear at Sound City Audio

not hurting high end hi-fi in Hong Kong. Jack Szeto of Jadis Electronics Limited was kind enough to demonstrate the French-manufactured Jadis high end line for me. Jack believes that the price of vintage gear is declining because the quality of lower-cost new tube gear is increasing, so new gear is becoming a better value.

For me, it was a thrill to see so much vintage gear in a single location. I know of no collection of hi-fi equipment, tubes and parts anywhere in the United States that comes close to what the Prosperity Building houses. There were several collectable pieces that I saw for the first time in Hong Kong. VTV readers traveling to Hong Kong should definitely visit Mong Kok, the Tung Choi Street Market, and the Prosperity Building vintage hi-fi shops.

**If you go ?**

Wherever you stay, obtain a Hong Kong map from the Hong Kong Tourist Association (HKTA) (your first of several chances will be at various stands near customs and immigration in the Hong Kong airport). The Tung Choi Street Market is one of the standard tourist attractions, and is well marked on the map of the Mong Kok area. The best way to get to Mong Kok from virtually anywhere in Hong Kong is by taking the MTR (in the States, we would call it the subway) to the Mong Kok station. Bear in mind that the Prosperity Building shops open at 2:00 PM, so plan your visit accordingly. Also, most shops are not open on Sundays.

The Prosperity Building is at the intersection of Tung Choi and Nelson Streets (both streets are marked on the

HKTA map). Finding your way there should be no problem, and if it is, you should have stayed home. Finding your way into the Prosperity Building is somewhat more challenging. Charles Audio Company is in the downstairs shopping arcade, which is most easily found from Nelson Street. The shop is at the far end of the arcade from Nelson Street. To enter the shops on the second and third floors, you must enter the Prosperity Building from Tung Choi Street. That is the challenging part. The shops are open when the street market is in business, and the street stalls obscure the building entrance. If you stay on the sidewalk on Tung Choi Street along the Prosperity Building (not down the middle of the street through the street market), you will see the entrance to the building. If you go past the building and come back on Tung Choi Street toward Nelson, you will see a small (1 foot square) blue Audiortronics sign (with a tube for the "A") just inside the entryway. Take the stairs or the elevator up to the second and third floors.



Marantz 7s and 10Bs at Charles Audio

You may also want to go shopping at Sun Wah, which is uptown. It is within walking distance from the Prosperity Building, and near the Prince Edward MTR station. Although Sun Wah has a Nathan Road address, the building entrance is on a side street between Nathan Road and Sai Yeung Choi Street (based on my recollection and the map, I believe the side street is Nullan Road, but the Nathan Road address should help you zero in). Take one of the elevators up to the fourth floor. (You have to pick an elevator that goes to the fourth floor - in Asia, it is common for certain elevators to only stop on certain floors.)

The Sham Shui Po district is the location of the electronics street market and the Golden Computer Arcade. Sham Shui Po is further uptown and a stop on the same MTR line that serves Mong Kok, Prince Edward, and Tsim Sha Tsui. That MTR line runs under Nathan Road. In Sham Shui Po, the electronics street



market is on one side of Nathan Road, and the Golden Computer Arcade is on the opposite side. The electronics street market is on a street running parallel to Nathan Road. On the opposite side of Nathan Road, also on a street running parallel, is a clothing street market, and the Golden Computer Arcade is in this area.

**Notable Hong Kong Audio Dealers**

**Audiotronics Company**  
Prosperity Building, Room 302  
61 Tung Choi Street  
Mongkok, Kowloon  
tel 2770-6123 fax 2385-0581  
e-mail audio@iohk.com

**Charles Audio Company**  
Prosperity Building, LG11  
6E Nelson Street  
Mongkok, Kowloon  
tel 2385-1828

**Excel Hi-Fi Company Ltd.**  
(Audio Research, Magnepan)  
Shop 318, Ocean Centre  
Canton Road  
Tsim Sha Tsui, Kowloon  
tel 2735-2726 fax 2735-1637

**Jadis Electronics Limited**  
(high end audio by Jadis)  
Shop 224-226 Caroline Centre  
2-38 Yun Ping Road  
Causeway Bay  
tel 2882-7072 fax 2894-8957

**Soundcity Audio Company**  
Prosperity Building, Room 305  
61 Tung Choi Street  
Mongkok, Kowloon  
tel 2782-6612 fax 2782-7223

**Sun Wah Hi Fi**  
(largest used hi-fi dealer in Hong Kong) 760  
Nathan Road, Room 433  
Mongkok, Kowloon  
tel 2381-8125 fax 2381-3343

**Valve Physics Company**  
Prosperity Building, Room 304  
61 Tung Choi Street  
Mongkok, Kowloon  
tel 2770-9239 fax 2896-5311

**Wai Yip Electronics**  
Prosperity Building, 2/F, Room 10  
61 Tung Choi Street  
Mongkok, Kowloon  
tel 2359-4866 fax 2385-7331

*Rick Graves, based in Seattle, Washington, owns a software company and is a tube audio enthusiast and vintage hi fi collector.*

**SOUND PRACTICES MAGAZINE**

*featuring*

Cool DIY Projects  
History and Classics  
Future Perspectives  
International News  
Wild Entertainment  
Refuge for Audio Nerds  
and much more!!

**SUBSCRIPTION RATES**

1 year (4 issues) \$20 US, \$24 Canada, \$30 Europe, \$35 elsewhere.

Sample \$5. MC/Visa accepted.  
Money back if not delighted.

**PO Box 180562 Austin TX 78718**  
**512-339-6229 voice/fax**  
**www.soundpractices.com**

**one electron™**

**Single-Ended Output Transformers**  
High Quality for a Reasonable Price  
Designed and Built in the USA

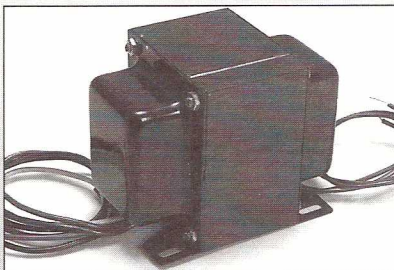

**UBT-1**      Designed for parallel operation of:  
1.6k primary      2A3s, EL34s, 300Bs 6AS7s,  
15 watts      etc. or Sweep-tube in  
160 mA      "enhanced triode" mode  
**\$90.25**

**UBT-2**  
4.8k primary      Can be used with:  
15 watts      300B, 50, SV811-3, etc.  
110 mA      **\$112.10**

**BFT-1**      **\$160.55**      Power transformer for use  
with UBT-1

Call for more information and quantity discounts available

**ANTIQUE ELECTRONIC SUPPLY™**  
LIMITED PARTNERSHIP  
6221 S. Maple Ave. • Tempe, AZ • 85283  
Phone (602) 820-5411 • FAX (602) 820-4643 or 800 706-6789

**BOOK REVIEW:**

*The Ultimate Tone* - O'Connor  
*Inside Guitar Amps* - Torres

By Eric Barbour

One recent development in the guitar world was brought on by the high prices of current tube amps. Many musicians are trying to learn how to repair and modify their own amps, an area which has always had some small action but which has become big business in the last ten years. More and more players aren't satisfied with the sound of their amps and are opting for "mods," which usually involve such things as swapping in different output tubes, changing values in the tone controls, and adding extra stages for overdrive distortion.

Such things were considered too difficult for average musicians to understand. But the current interest in modding, plus the high cost of amps that have such features already built in, have created a market for books dealing in this area. Tube guitar amps are especially well-suited to this because of their simplicity, and (in the case of old silver-face Fender amps) the commonness of older amps in the used market makes them attractive platforms for mods.

Two recent books deal extensively with mods and common repairs. They are very different books, as different as their authors (both of whom are well-known amp technicians who specialize in mods). One is aimed squarely at the novice, the other is more sophisticated and not really suited for rank beginners in amp repair.

Kevin O'Connor is a Canadian tech who has some reputation for working with famous musicians. His book *The Ultimate Tone* appeared early in 1995 and was one of the first of the modern books to cover tube-amp mods.

This is an exhaustive and well-researched book. The nine chapters cover the whole gamut. Chapter 1 is about amp systems; Chapter 2, power supplies (with some treatment of electronic regulation, which is a very advanced concept in guitar amps and rarely seen); and Chapter 3, a short history of tubes, with modest technical explanations of their operation. Chapter 4 covers the basics of preamp design, including typical tube signal-gain stages and grounding. Chapter 5 is the most sophisticated treatment of preamp

modifications I have ever seen. It covers everything from preamp topologies to diode "bounding" circuits used to simulate tube distortion. The discussions of preamp architecture covers Fender and Marshall circuits, as well as O'Connor's own "London Power" designs, and numerous variations are described. Some of the topologies shown here are very complex. For an experienced technician, this chapter alone is worth the cost of the book.

Chapter 6 covers the power stage of guitar amps. Biasing is well-covered, and phase inverters are extensively discussed. O'Connor calls the simple one-triode phase splitter a "concertina splitter." Paraphase, Schmitt and diff-amp inverters are also described. This chapter also talks about presence controls which use negative feedback, output transformers, alternate output designs, power tube types, and applications of these types. There is a section on switching different kinds of power tubes into and out of the circuit, and some complex circuits (using MOSFETs and cathode-switching) to accomplish this are shown. This is definitely not a book for the average guitarist.

Effects loops are covered extensively in Chapter 7. As before, numerous topologies are described. The tube signal circuits rarely use anything other than 12AX7s and 12AT7s, as does the rest of the book. Except those areas that talk about solid-state circuits, that is. Chapter 7 has a section entitled "Solid-State Loops." Most of the circuits here use common op-amps, although there is no discussion of protection circuits when connecting them to tube preamp stages. High peak voltages from tubes could damage the inputs of op-amps, and back-to-back zener diodes are usually placed on the signal input to clip such spikes. But O'Connor does not cover that. He does finish the chapter with buffer circuits based on high-voltage MOSFET cascodes; not a bad discussion, though a bit out-of-place in a book on tube guitar amps.

Chapter 8 is a thorough treatment of the use of spring reverbs in guitar amps. Both tube and solid-state circuits are covered adequately. The obscure subject of reverb tank "hot-rodding" is not covered; this usually involves putting very low-impedance transducer coils in the tank, which supposedly improves clarity. It is rarely done today. Chapter 9 is 91 pages long, and all it covers is electronic switch circuits, of the type used for channel selection with a footswitch. The coverage is remarkably thorough, and focuses on

using bipolar transistors, MOSFETs and CMOS ICs to switch audio signals, with some coverage given to relay controls and CMOS/TTL logic circuits.

Chapter 9 could be a good separate book by itself; it seems out-of-place here, since guitarists rarely need anything more complex than A-B switching for two channels (clean and distorted) and switching in reverb. O'Connor even shows complex electronic schemes for switching output tubes from triode to pentode and switching in different speaker loads.

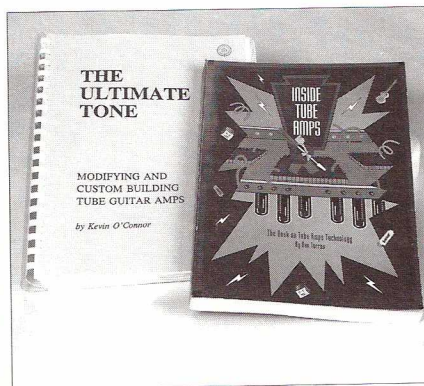

The book ends with three appendices. Appendix A is a series of tube data sheets, covering the usual guitar types plus 6CG7/FQ7, 6EU7, 6SN7, 6AS7/6080 and 7199. Appendix B is one page on the Futterman OTL amplifier, but shows the diagram of the Dickie-Macovski OTL design from the June 1954 issue of *Audio* magazine, which was not a Futterman design. Appendix C is two pages of data on Hammond output transformers.

Mr. O'Connor has assembled an excellent book here, but it has a few glaring flaws. On page 3-3 he says of vacuum tube diodes: "Most diodes are indirectly heated cathode types. These are easier and cheaper to mass-produce than directly-heated types..." I suspect that he is talking about power rectifiers here. And I suspect that filamentary rectifiers (such as 5U4 and 5Y3) are about as difficult to make as cathode types (5V4, 5AR4). Most vacuum signal diodes are cathode types, true. But power rectifiers are of both types, and there is no clear-cut advantage of one over the other. They both have valid applications in guitar amps.

Another oddity is on page 4-1. It says "...an absolutely clean and uncolored guitar sound is only obtainable with solid-state circuitry. A clean tube circuit is not 100% accurate and will sound "warmer"

than the clean transistor sound." Utter nonsense! A tube amp can be built that is as "clean" as any solid-state design. It isn't easy, and very few tube amps would come close, all of those being audiophile types. When that high level of electrical performance is reached, the result is a very bland sound, identical in tubes or in transistors. It's peculiar for two technical statements of such blatant misinformation to appear in such a well-written and advanced text.

Some of the facts in chapter 6, in the descriptions of power tubes used in guitar amps, are off-base. The 8417 was not single-sourced; Sylvania and GE made their own versions. The first glass 6L6 was the 6L6G, not 6L6B. And not all 6BQ5/EL84 types sound like small EL34s; some are beam-power types. It's also obvious that O'Connor does not know very much about the current tube manufacturing scene; he talks about the old National (Union?) 5881 as if it were still in production. Believe me, all new guitar-amp tubes come from Russia, China, Serbia or the Czech Republic at this time, and this situation has obtained since 1991. None of the guitar-amp techs (who have written about their trade) seem to know much about the current tube industry.

Also, O'Connor has no love for the EL34, for reasons of reliability and sound. He recommends replacing it with 5881s "whenever possible." True, it isn't the most reliable tube, but 5881s sound quite different, and people seem willing to accept an occasional blow-up in order to get the Marshall sound. He's entitled to his opinion, I suppose. On page 6-48 he claims that the 6L6 is a "higher-current, higher-power" tube than the EL34. Wrong! The plate rating of an EL34 (25 watts) is less than a 6L6GC (30 watts), but EL34s usually have much larger cathodes and can deliver more current. As O'Connor had previously noted, an EL34 in bias failure delivers 50% more plate current than a 6L6GC in a typical setup.

So even though this book is one of the best on its subject, it still betrays its amateur-publishing origin. And, as usual with amp "gurus," O'Connor is not afraid to push his own agenda and his personal tastes onto his readers. He claims in his preface that there are "no gurus, no magic," but indulges himself in a few guruisms and magical statements, later in the text.

*The Ultimate Tone* is worth reading if you are not put off by mathematical calculations and are somewhat

knowledgeable in electronics already. Just beware of some small banana peels.

On the other hand, we have Dan Torres. He is famous in the San Francisco Bay Area as guitar amp-tech-to-the-stars. Torres' book *Inside Tube Amps* is as different from O'Connor's book as night and day, even though they both cover exactly the same subject.

While O'Connor writes from a sophisticated standpoint, uses very exact language, and gives much detail on the math and basic concepts of tube audio electronics, Torres is obviously aiming his book at the musician who does not understand Ohm's law. The language tends to be very blunt, and is spiced with "hey dude" slang. Torres writes most paragraphs with only one or two sentences, giving a "See Spot Run" aspect. This is not a bad idea, since most rock guitarists are not exactly rocket scientists. Obviously Torres laid out and desktop-published this entire book himself, as the text layout is very generous with blank space and large type, and most of the drawings are prominently labeled "Drawn By Dan Torres." Punctuation is occasionally missing from the text, and a few errors in grammar are present.

This book is entertaining, to put it mildly. Torres is not trying to cover every obscure corner of amp modification here, but he definitely is making it palatable to the audience that O'Connor might alienate. Instead of complex topologies and solid-state switching, Torres covers just the basics: preamps, effects loops, driver stages, power stages, output transformers, biasing output tubes, rectifiers, filter capacitors, power transformers and heater strings.

Most of the circuit drawings are in both in schematic and physical form, and usually show old Fender circuits. Used Fender amps with fiberboard construction are common and easy to modify, and this book is suitable for most such mods. Strangely, Torres shows two extensive mods for the Traynor Mark 3 amp. The preamp mod is relatively early in the book, considering its complexity. And Traynor amps are uncommon in the U.S., so the space given to the Mark 3 would be better as an advanced project at the back of the book.

The discussion of biasing is very clear and useful. Torres talks about the peculiar tendency of guitarists to call the EL84 a "Class-A" tube, when in fact there is no such thing. The charts of bias points in this section are excellent and appear to be

fairly accurate; this kind of information is vital to anyone trying to bias a guitar amp after replacing output tubes.

Useful mods discussed in this book include tone control variations, "aged parts" (usually out-of-spec resistors), adding a spring reverb, switchable gain stages, adding an effects loop, upgrading small-value capacitors, and putting pre-CBS Fender phase inverter circuitry in later Fenders.

Output tube conversions are covered briefly. Adding tube rectifiers and more capacitance to power supplies are treated reasonably well. Common repairs, such as tremolo couplers and filter cap replacement, are also dealt with. The last chapter is a full construction article for a simple, single-6V6 amp. Clear enough, though not really simple enough for the rank beginner.

Major oddities include the lengthy disclaimer about high-voltage hazards and manufacturer trademarks. It appears in its entirety on pages 4-5, 120-122, 147-149 and 266-267, with a shorter disclaimer on 284-285. Also, most of the usages of the word "Fender" are followed with the "TM" device to indicate a trademark, followed by "®" which indicates a registered trademark, even when referring to Leo Fender as a person. This is excessive-- once at the beginning of the book would have been enough. I suspect that Mr. Torres went to an attorney for consultation, and was told to overdo it. Welcome to California.

Torres makes a few technical errors here and there, usually small ones. They include the discussion of the 12AT7 reverb driver in Fender amps on page 34--Torres claims that the two sides are connected in parallel for more gain. He describes 12AX7s and 12AT7s on pages 60-61, including claims that "audio 12AT7s" are available (no such thing) and that all modern 12AX7s are low-hum (they vary greatly). A mod for adding a triode-pentode switch to Fender 6L6 amps on page 111-112 tells us to "arrive at a compromise" bias setting. This only works when the screen voltage is taken from the same supply as the plate.

On page 116-118 is a method for putting EL34s in a Fender 6L6 amp. It is adequate, except that the greater filament-current consumption of EL34s is not addressed. This mod will stress the amp's power transformer. Torres discusses this on page 270, but it should be combined or referenced with the actual mod. Math tends to be treated like a poisonous

snake. Usually, if something involves calculation, Torres warns the reader in advance. Also, the calculations tend to be in verbal descriptions rather than in formula.

This makes the text easier to follow for a non-technical reader. Nevertheless, the total novice is advised to read and understand a beginner's book in electronic theory before reading Torres' book.

*Inside Tube Amps* is a worthwhile item for the less-experienced amp modifier, though it does require some care in use. Read the entire book carefully before attempting any of the mods.

**The Ultimate Tone: Modifying and Custom Building Tube Guitar Amps** (\$55.00) by Kevin O'Connor; Paperback, 356 pages, 1995. Power Press Publishing, PO Box 1777, Station B, London, Ontario N6A 5H9 Canada. (also available from Antique Electronic Supply).

**Inside Tube Amps: The Book on Tube Amps Technology** (\$49.95) by Dan Torres; Paperback, 310 pages, 1995. Sparco Inc., San Mateo CA 94402.

### Additions and Rectifications

**Issue #2 - Early Heathkit Hi Fi Article:** We mention that the large Peerless output (16458) transformer on the Heath WM-5 amplifier came first. Actually, the small Peerless output (16309) was on the first WM-5s. (Thanks to Bruce Tilden of San Jose, California)

**Issue #3 - WE 300B Article:** The type 71 tube was a 1925 GE design, not Westinghouse. GE and Westinghouse manufactured tubes for RCA, who acted as a sales agency for radio products made by others. In 1930, RCA got its own plants in Camden, New Jersey (formerly the Victor Talking Machine Co.) and later in Harrison, New Jersey. (Thanks to Alan S. Douglas of Pocasset, Massachusetts)

**EICO Article:** The EICO HF-20 does not have a DC filament supply. (Steve Lafferty of Roswell, Georgia)

**Issue #4 - Vintage Bookshelf Speaker Article:** The AR-4 and AR-4X speakers featured an eight inch woofer, not a ten inch. (Thanks to Steven Bender, Queens Village, New York)

**6L6 Article:** A British EMI team should be credited with the invention of the aligned grid beam tetrode. Hivac started selling the first critical distance power tetrodes in early 1935. Initially they were battery types Y220 and Z220, with AC main types following. (Thanks to Phil Taylor, W. Sussex, England)

**Harman-Kardon Citation Article:** The output transformer used in the Citation II power amplifier was made by Magnetic Windings of Easton, Pennsylvania, not Freed Transformer of Brooklyn, New York. (Thanks to Howard Bardach, Studio City, California)

**Tube Industry News Article:** In the 300B comparison chart, we say the new 300B is a "Westrex." The new WE 300B is a *Western Electric*, not *Westrex* tube. (Thanks to Charles Whitener, Atlanta, Georgia)

**Please keep us informed of any corrections or errors you note in VTV.**

**The Audio Test Bench**

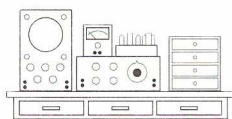

by  
**John Atwood**

**Audio Signal Generators**

Up to now, we have described signal measuring instruments in this column. We will now look at signal sources used for various audio tests. RF signal generators will not be covered in this article.

A signal generator is needed whenever an amplifier or recording system needs a well-controlled stimulus for making measurements. For general audio testing, there are two primary types of signals used: sine and square waves. Other signals are sometimes used (two-tone signals, white noise, FM multiplex signals, etc.), but these will be covered in future *Audio Test Bench* articles.

**Sine-Wave Testing**

Sine waves were among the first AC signals to be used in electrical engineering, since they were the natural result of rotating a coil in a magnetic field. AC power distribution is universally sinusoidal for this reason. In the early days of audio, the power-line (or harmonics of it) was sometimes used as a test signal. This is seldom done now, due to the limited frequency choices and the impurity of the sine wave.

Many AC meters only give correct reading for sine waves. As a result, sine waves are usually used to find the maximum power output of an amplifier. Sine waves are also used to test the amplitude and phase response of a system. For these applications, only a moderately accurate sine wave is needed – about 1% distortion or less.

Sine waves have the unique property that they are made up of just a single frequency, i.e. they contain no harmonics. Since only a perfectly linear system will not create any new harmonics, sine waves are used to measure harmonic distortion. Since any noise or distortion in the oscillator will get added to the distortion from the amplifier, sine-wave oscillators used for harmonic distortion (THD) measurements must have very low residual distortion – 0.1% or less. The details of distortion measurements will be covered in a future *Audio Test Bench*.

The most common use for sine-wave oscillators is frequency response testing.

To do this, the oscillator is fed into the input of the system, and an accurate AC voltmeter is connected to the output. Unless you are testing specifically for full-power bandwidth, the amplifier output level should be well below overload. You can take measurements at roughly logarithmic intervals (say 1, 2, 5, 10, etc), and plot the results on either log-log graph paper (if you are measuring the output in volts), or semi-log graph paper (if you measure the output in db). In place of graph paper, a computer spreadsheet graph or chart can be used.

**Square-Wave Testing**

Square waves are made up a fundamental frequency and a declining series of odd harmonics (3rd, 5th, 7th, etc). This spread of frequencies allows a single signal to stimulate a system over a wide frequency range. This makes square waves very useful in conjunction with an oscilloscope to get a quick visual indication of phase and frequency response problems. Here is a brief summary of what can be determined from square waves:

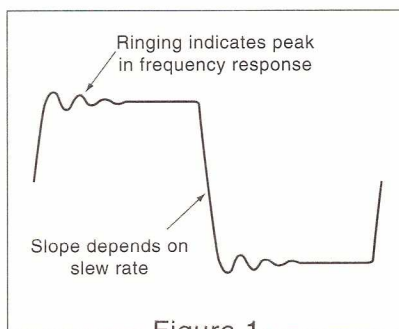

Figure 1

High frequency effects are shown in figure 1. The rise and fall time depend on both the small-signal high frequency cutoff frequency as well as the large-signal slew rate. Damped sine-wave ringing is a sign of a peak in the frequency response. The inverse of period of the ripple is the frequency of the peak.

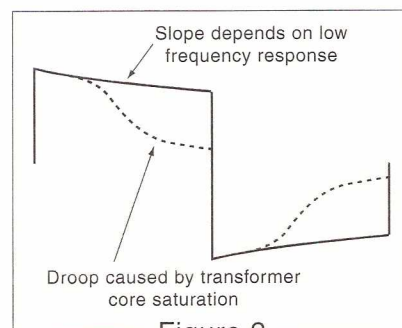

Figure 2

Figure 2 shows low-frequency effects revealed by square waves. The slope of the top and bottom of the square wave is caused by a finite low-frequency response. If transformer core saturation in a power amp occurs, it often is manifested by a non-linear drooping.

**Sine-Wave Oscillators**

Early audio oscillators used LC (inductor-capacitor) networks in circuits similar to RF oscillators. The inductors were expensive, and the tuning range was limited

A common laboratory audio oscillator during the 1930s and '40s was the Beat Frequency Oscillator. The outputs of a fixed and a variable RF oscillator were mixed to provide a beat frequency – the difference between the two frequencies. This was then amplified to provide a sine wave. Good frequency stability was difficult to achieve, and the distortion was not very low. This type is seldom used today.

The most famous sine-wave audio oscillator is the Wien-bridge type, developed by Frederick Terman and Bill Hewlett at Stanford University in 1939. This oscillator was the first product sold by Hewlett-Packard. The Wien-bridge oscillator uses an RC network in a two-stage feedback amplifier to set the operating frequency. It was easy to get a 10-to-1 frequency range in each frequency band by using a conventional radio-type variable capacitor. A key to the success of this circuit was the ingenious use of a tungsten-filament light bulb as an amplitude stabilizing device. This made the oscillator have relatively stable output and very low distortion over a very wide frequency range.

The vast majority of low-distortion sine-wave oscillators available on the used market today are the Wien-bridge type. Tube-type oscillators typically have worst case distortion specs of 1% down to 0.1%. Some of the better solid-state oscillators have distortion as low as 0.005%. By careful tweaking, both tube and transistor oscillators can be brought down to 0.001% or less. The Wien-bridge circuit can either be implemented with a variable capacitor and fixed resistors, giving a continuously-tuned oscillator, or by switched resistors and capacitors, giving a "decade" type switchable frequency.

Tube-type sine-wave oscillators are quite cheap, yet when overhauled, are very useable. Hewlett-Packard, of course,



*Heathkit IG-1275 function generator and EH 136A pulse generator*

is the grand-daddy of Wien bridge oscillators. The most commonly-available H-P models are the various models in the 200-series. The differences tended to be in the frequency range, power output, and distortion level. Probably the best overall H-P tube-type oscillator was the 200CD. Solid-state models include the 204B and 241A.

Wien-bridge sine-wave oscillators were made by nearly all test equipment companies, and due to the robustness of the circuit, it is hard to recommend one brand over another. In the lower-cost arena, Heathkit, Knight Kit, and EICO made several types of Wien-bridge oscillators. These did not use as high-quality components as the more professional models, and their dial calibration was not as good, but, if fixed up and carefully calibrated, they can work as well as the more expensive models.

It should be noted that most harmonic distortion analyzers have built-in sine wave oscillators that are, by requirement, very low distortion. If you invest in such an analyzer, you probably will not need a separate sine-wave oscillator.

Some of the best quality sine-wave oscillators have circuits to automatically stabilize the output level. Most, however, do not, and it is common to see 1 db or more of variation when the frequency is changed. When running frequency response tests, it is necessary to monitor the oscillator output level, and readjust it, if necessary.

Dial calibration or push-button accuracy on these oscillators cannot always be trusted, especially in cheaper units. For accurate and repeatable frequency response tests, connecting the output of the oscillator to a frequency counter is

highly recommended.

### Sine/Square-Wave Oscillators

Many manufacturers made Wien-bridge sine wave oscillators that had built-in square-wave generators. These were typically a set of over-driven amplifiers or a Schmitt-trigger type of circuit. The quality of the square-wave output varied; for example, the H-P 209A and Heathkit IG-82 have quite a good square-wave output, but the EICO 377, while having a good sine wave oscillator, has only a mediocre square wave.

### Function Generators

In the 1960s, a type of oscillator called a function generator became popular. The most popular models were made by Wavetek, but other companies made similar models. Function generators typically put out sine, square, and triangle waves over a wide frequency range. Many versions were voltage-controlled, and had a built-in sweep function, allowing automatic frequency sweeping.



*HP 200CD and Waveforms 510B*

The heart of a function generator is a triangle-wave generator implemented by a constant current source and sink accu-

rately charging and discharging a capacitor. The circuit that switches over from charging to discharging and back again inherently puts out a square wave. To generate a sine wave, the triangle wave is passed through a special non-linear network that squishes the triangle into something close to a sine wave.

The advantages of a function generator include a wide frequency range, voltage controllability, and a very constant output voltage over frequency. Its main disadvantage for audio work is that the sine wave is not accurate enough for decent harmonic distortion measurements. For general frequency response testing, though, it works fine. As with Wien-bridge oscillators, the output of a function generator should be monitored by a frequency counter for accurate frequency settings.



*EICO 377*

### Square-Wave Generators and Pulse Generators

Some square-wave-only generators were made, the H-P 211A being an example. Much more common, though, are pulse generators, intended for testing digital logic. They can provide a sequence of high quality pulses of arbitrary duration and duty cycle. The better pulse generators also have adjustable rise and fall times. Some pulse generators have a square-wave mode, that allows the duty-cycle control to act as a frequency control. Those that do not are very difficult to adjust, since both the duty cycle and pulse length controls must be adjusted carefully to give a square wave. An oscilloscope connected to the output of the pulse generator is a necessity to see what is going on.

Aside from the adjustment problem, the frequency stability of pulse generators is not very good, and some have the annoying characteristic that the output voltage cannot be adjusted below a certain point (say 1 volt or so). Despite these problems, a pulse generator can be pressed into service as a square-wave generator.

**Frequency Synthesizers and Directly-Synthesized Oscillators**

In the 1970s, desktop synthesizers began to appear that covered the AF as well as the RF band. The H-P 3320- and 3330-series are examples of this. This generation of synthesizers uses an analog signal path and phase-locked loops to create a sine-wave signal, but are controlled by digital logic. Frequency accuracy, stability, and resetability are excellent, and many synthesizers are digitally controllable through busses such as the GPIB. Distortion and residual noise may not be as good, though, as high quality Wien-bridge oscillators. These synthesizers are complex and can be difficult to repair.

The advent of cheap digital memory and low-cost, high accuracy digital-to-analog converters in the 1980s allowed a new type of synthesizer to come to the market: directly synthesized oscillators (DSOs). These use either a look-up table in ROM or a digital algorithm generator to send 12-to-16 bit digital words to a D/A converter. Some generators allow the waveform to be programmed or down-loaded, making them "arbitrary waveform generators."

Examples of directly synthesized oscillators include the H-P 8904A and 33120A. DSOs have excellent stability, repeatability, and accuracy, and can have excellent waveform accuracy. The availability of other useful waveforms (square, triangle, pulse, two-tone, etc) is handy. These instruments are fairly new, so are expensive on the used marketplace, but an enterprising experimenter could build one himself using off-the-shelf digital logic and converters.

**Summary**

So what generators should you use? It depends on your needs and your budget. Fortunately, fairly good oscillators are available used at low prices (\$10 to \$50 at a swap meet, \$100 to \$400 from a used equipment dealer). On my own test bench, the high-quality sine wave oscillator is the built-in oscillator in a Sound Technology 1700B distortion analyzer (0.002% distortion). The general purpose sine and square wave source is a Heathkit IG-1275 function generator. An H-P 205AG drives the big impedance bridge. And I have an H-P 3330B synthesizer that is part of a network analyzer and spectrum analyzer set-up. Keep in mind that for most oscillators, the output amplitude and frequency should be monitored for most accurate results.

*Next issue: Oscilloscopes, part 1*

**Uncle Eric's Deluxe SE SV811 Amplifier Project**

by Eric Barbour

**1. The Sales**

Everyone is entitled to their opinions. And most of you have strong ones, if you're reading this magazine. It seems that nothing creates a strong opinion quite as strongly as inferior products. A pity, isn't it, that crap seems to have commercial value? Advertising and promotion (and legal threats to publishers) have more sheer power than truth.

What does this have to do with building a single-ended amplifier? Well, it's a little problem with getting the right parts. To do this properly, we need tubes with inherent low distortion, an output transformer that has wide frequency response and low distortion with unbalanced DC in the primary, a basic power supply with low AC ripple, and not much else. Unfortunately, the important three things are often botched up by the manufacturers.

You, the consumers, are passive. So, anyone who makes bizarre or optimistic claims for their audio products will usually make some money if they are aggressive in promoting themselves. The most recent audio trend is single-ended amplifiers using a 300B tube, a mediocre driver stage and output transformers of varying quality. All these things were available a few years ago, but now they are legit-

imized by advertising hype and specialty audio publications. And since most people are passive, some of them can be induced to buy these inferior gadgets at inflated prices.

First the 300B. It's a pretty good little triode, at least in the original Western Electric form (recent import versions are less than stellar). But it's delicate. You get 8 watts and no more. Distortion is low at 1-2 watts, but that's all you can expect. Yet the worshippers of the Church of 300B, technically unqualified as they are, assert the glory and holiness of it. Amazing, that some are willing to accept hype about this 1935 public-address amplifier tube. And woe betide you if you handle it roughly, or overdrive the grid, or put excess voltage or current into the plate. Thou shalt not exceed 450 volts, thou shalt not exceed 60 milliamps, thou shalt not draw grid current by driving the grid positive.

It gets worse. Most of the driver stages I've seen are 1930s table radio ripoffs. The Church of 300B asserts the perfection of driving that dinky triode with the WE 310A pentode. It usually has fairly low distortion. It also isn't much of a driver. As far as I can tell, maybe one or two of these "boutique technicians" are actually qualified to design electronics, while the rest are eminently qualified to produce copycat or mediocre products

And now we come to the output transformer, probably the most important item in the package. Aren't we lucky to have so many choices? I say hah. Some of them are actually suitable for SE



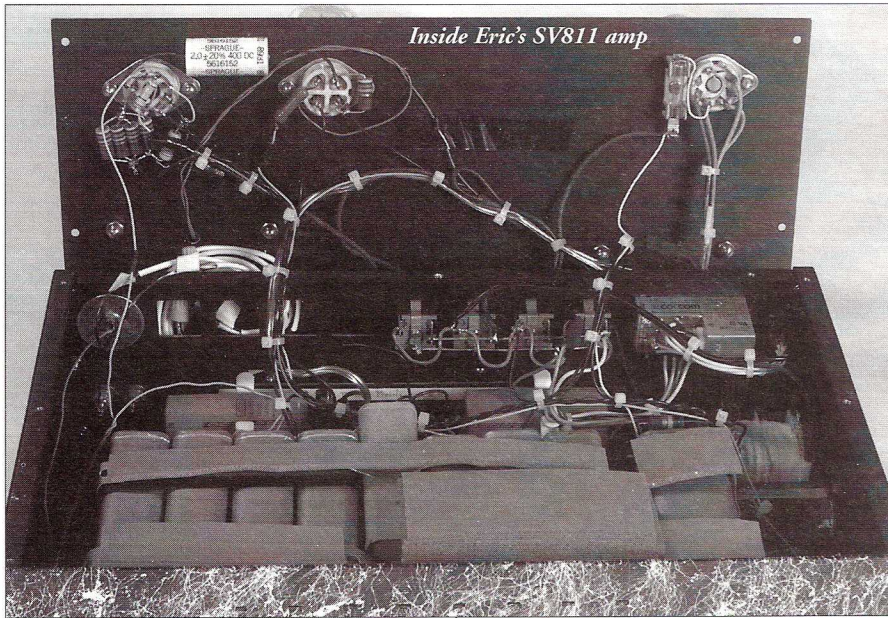

operation, and can produce good sound. This would include products by Audio Note, One Electron and Bartolucci. Some are OK but harsh-sounding. Other SE transformers bring to mind words like "flabby," "mushy," "lacking in treble" and "table-radio quality."

## 2. The Truth

Is it my turn yet? Good.

This article presents *MY* idea of a top-grade, 10-watt SE amplifier. This amp actually sounds good and is linear. It has the detail that audiophiles expect. It has



SV811-10

good speaker damping and clean bass, both difficult to get in SE without feedback. See the sidebar for our august publisher's take on the sound of this amp. This isn't the only way to build a good-sounding SE amp, but it's one of the simplest, and requires no obscure and high-priced tubes.

My circuit is an ultimate version of my SV811-10 amp in *Glass Audio* 3/96. In this case, I have carried it to the extreme. No parts list is given, for while the *GA* amp was intended as a beginner's project with reliability, this version is the ultimate clarity that you can get from an SV811-10, a tube that gets no respect because of its frequent misapplication.

If you want this, you are expected to be an expert builder, and a good scavenger after vintage parts. I am specifying old oil capacitors that are almost impossible to get. If you want them, you are on your own... nobody will sell them to you cheaply or easily. The same goes for the antique chokes in the power supply. All I can say is, hit the ham-radio flea markets and good luck. And also, substitute at your own risk.

## 3. Facts

300B? Thanks but no thanks. Because the SV811-10 is tougher, longer-lasting, can be operated with no bias circuitry at all, and gives distortion and sonic clarity which are the equal of the 300B. But you have to treat it right. Many have tried to use SV811 types, and have had problems with the need to drive the grid positive to get full power; the 4-amp filament; the plate resistance, which

is admittedly three times that of the 300B.

One also gets tired of hearing them go on about the dangers of red spots on the plate of an SV811 type. Having been conditioned by small audio tubes failing due to bias trouble, they all seem to think that red on the plate is death. Sorry, the SV811s can run their full lifetime even with substantial red spots showing. As I said, the SV811-10 is tough. Drive is all-important for this tube. Since cathode followers seem to have an undeserved bad reputation, and they are also inexpensive to use, let's use them.

A perfect synergy for the SV811-10 is the 6EM7/EA7/GL7 dual triode. The first stage is a high-mu triode that is just like half a 6SL7, which is well-known to be a great-sounding tube. It provides most of the voltage gain. It is coupled directly to the other triode, which is a low-mu device somewhat like a 2A3 with a cathode. It provides a low output impedance to drive the SV811-10 grid properly. This tube's distortion is low, and cathode-follower operation gives degenerative feedback which yields even less distortion. The signal then passes through only one capacitor.

An interstage transformer would be even better, but really good ones (as good-sounding as the \$10 capacitor) are incredibly hard to find. I realize that a directly-coupled cathode follower is the best arrangement, but there have been quite a few embarrassing blowups in amps that use such drivers.

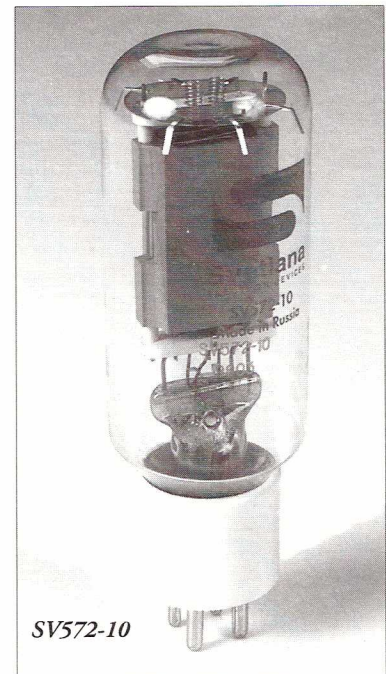

SV572-10

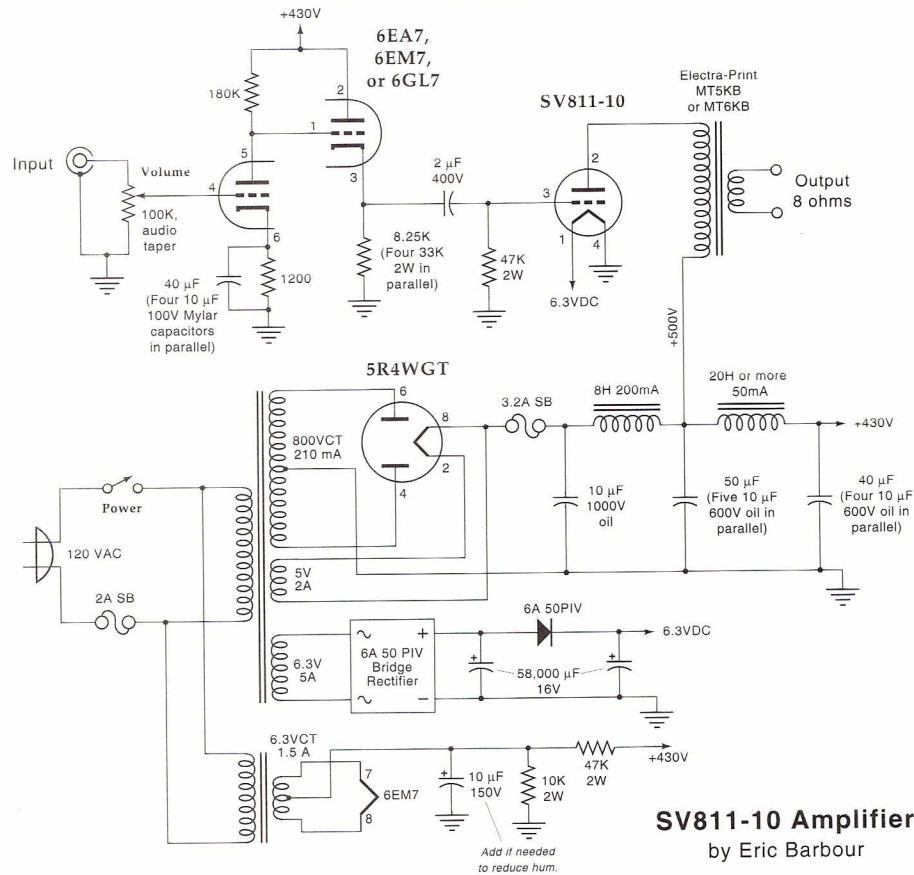

**SV811-10 Amplifier**  
by Eric Barbour

The capacitor-coupled design here is extremely reliable, and gives a full 10 watts peak with about 7 watts continuous with 2% distortion. In this circuit the SV811-10 is capable of 15 watts, so conservative ratings are being observed.

The SV811-10 has its grid at zero potential (actually a few volts below ground because of contact potential), so it draws about 100-120 mA on the plate. At this operating point, there is no color showing on the plate at all. Bias failure is not an issue, because the only thing that can go wrong is if the grid resistor or coupling capacitor goes totally bad. And that won't happen if parts selection is very conservative.

Then there is the output transformer. Having sampled some old types and many of the current "high end" products, I choose Electra-Print. The MT5KB or the MT6KB are clearly the way to go. It is my opinion that Electra-Print makes the best-sounding SE transformers in the world. They are *HUGE*, which equates to high saturation, which means great bass and low distortion. And treble is there in the right quantity. Even with 120 mA in its primary, the MT5KB is still just loafing. So that is what I used.

The One Electron UBT-2 used in the **GA** amp is very good, and gives fine sound on small 2-way speakers. But the high-priced ultimate is Electra-Print. End of discussion.

Keeping with the theme of synergistic simplicity, the power supply is minimal and reliable. Oil-filled (or PCB-filled, possibly) filter capacitors are the norm. You need 10 of them. They are big, rectangular steel cans, so you will need a big, big box to hold them. Take my tip and don't use those oval jobs you find in surplus shops, they are meant for motor starting and don't sound as good as the rectangulars. Mine are old Cornell-Dubilier 121J series types, and I found a pile of NOS units at the notorious Black Hole in Los Alamos, NM. They may indeed be toxic waste, but *DAMN* they sound good. I used an ugly "potato-masher" 5R4WGB rectifier because it sounds good, is conservatively run here, and is far tougher than any other type.

For lowest hum, the SV811-10 filament is run off a heavily-filtered DC supply. The 6EM7's filament is run off its own 6.3V transformer, which has its center-tap stood off ground about 100Vdc

by the two resistors shown. This prevents the heater-cathode insulation from failing. There is no need to use DC in this tube, the hum is very low. The 6.3V windings are overrated for maximum lifetime, as are all of the components here.

#### 4. Exit

You are entitled to think what you want about this. But the proof is in the listening. Having heard many SE transformers and quite a few SE amps, the editors of VTV feel that this homebrew black box is one of the best-sounding SEs that you will ever hear. If I have offended any of our readers, they are certainly welcome to write in (not phone) with their objections. Responsible and reasonable letters will be considered for publication.

#### Editor's Note

*Mr. Barbour recently became Applications Engineer for Svetlana Electron Devices, marketer of the SV811-10. But he constructed this amp during the summer of 1995, long before Svetlana offered him employment. Similarly, this article was written before the employment offer, and has not been seen or approved by Svetlana management.*



*It is commonplace for audio publishers to print feature articles of this type, about designs the authors themselves manufacture and profit from.*

*Barbour is not profiting from the sales of transformers, nor does he sell copies of the amplifier described here. He simply is an employee of the company that imports and distributes one of the tubes used in the amp.*

### VTV listening impressions of Eric's SV811 amplifier.

By Charlie Kittleson

All of us at VTV have had the experience of listening to and evaluating various single-ended amplifiers, including those using 300Bs. We were very curious how the new Svetlana SV811-10 tube compared to the famous 300B using Eric's SE test amp and the Cary Audio SE-1 kit amp. Our listening group included Steve Parr, Don Pettee, Terry Buddingh, John Atwood and myself. Speakers were either Klipsch Chorus 1s or B&W DM110s. Program material was CDs played on a modified Elite Electronics CD player plugged directly into the amp and not using a preamp.

We immediately noted that the SV811-10 was less colored than the 300B. Granted, the 300B has super mids, but the SV811-10 mids are every bit as good, especially on vocals. This is a well-balanced tube with musical highs and clean, powerful bass. The use of a thoriated tungsten filament emitting a bright yellow glow gives the SV811-10 that transmitting tube look and smooth, powerful sound. Also, there is lots of headroom with this tube, even when pushed. The 300B on the other hand, can sound mushy when pushed to equivalent volume levels.

Next we tried the Svetlana SV572-10, which is a direct plug in replacement for the SV811. It has a vintage transmitting tube look with a straight-sided glass envelope reminiscent of the early 1930s Sylvania and Taylor transmitting triodes. It sounded balanced and had tight bass. Overall sound was similar, but more refined than the SV811-10. The SV572 had a little better detail on the top-end.

Then we switched rectifiers. First trying the Chatham "Potato Masher" 5R4WGB, then a Chinese 5AR4 and finally a GE 5R4GA type. All of us agreed that the 5R4GA was cleaner, with better presence than the other rectifiers which seemed to be more rolled-off sounding.

These new Svetlana tubes seemed to do everything well if used in a properly designed circuit. They are a reliable and powerful alternative to other medium-sized audio triodes.

## The Birth of the Marantz 10B

By Michael Zuccaro

(From taped telephone interviews)

Let us make no mistake about it – anything well done, well made or well designed is a work of art. We know who painted the great paintings, who wrote the greatest pieces of music, maybe even who designed the greatest bridges or most respected cars, but I have always wanted to know who, for God's sake, was responsible for the actual circuit design of the venerable Marantz 10B tuner? It's no small task to design anything well - especially consumer electronics, where price is always a major factor, but in 1961, Saul Marantz had an idea which would both produce the most advanced FM stereo tuner of its time, and almost bankrupt his company: What would happen if we threw all the rules away, and built a no-holds-barred, money-is-no-object tuner?



With the possible exception of McIntosh, no other hi-fi manufacturer of the time could have made such a calculated gamble. The Marantz name had the reputation for superb quality, to be sure. Their Model 7 preamp and 8 and 9 power amplifiers were already recognized as masterpieces of design by both engineers and hi-fi men. But they had never ventured into RF design, and a tuner was a natural next step. Chief Engineer Syd Smith conferred with Saul Marantz, and decided to hire on Dick Sequerra (later to produce the legendary FMI Sequerra tuner) who designed the RF section, with Syd designing the multiplex, audio and power supply stages. So here in their own words is that story:

### Syd Smith

"The thing that really started the 10B project was the adoption of the General Electric stereo system in the early 60's. When that happened, GE gave courses on multiplex FM Stereo. Dick was already aboard, working with me on the finishing details of the 9 amplifier. I couldn't be



spared from work, so we sent Dick. I had not had tuner experience, it wasn't my expertise. But Dick had some experience in RF work. If it weren't for him, we probably wouldn't have started it. Before that, I was the only engineer, except for occasional technicians helping me here and there. We had maybe 70 employees and were at 25-14 Broadway in Long Island City in Queens, New York. All the design work on the 10 was done there, as well as initial production.

We contracted out all the sheet metal work and stamping, and transformers we had made by several different companies. The last outfit was Magnetic Windings Company, who produced the prototype transformers for the 9, but they were not satisfactory. We found we had a guy in the factory who knew how to hand-wind transformers, and we learned enough to improve the transformers in the 8 and this became the 8B. Magnetic Windings is still in business in eastern Pennsylvania, Jim Loweth was our transformer guy. Anyway, back to the 10B. It started out as the model 10, with a slightly different front panel and IF configuration above the chassis, instead of below it. Originally, we used toroids as the inductors, but we learned, to our chagrin, that these were becoming magnetized on the production line by the Weller soldering guns! It changed the bandpass. We couldn't align them. So when we did the 10B we went to gapped pot cores, which had been very well tested for reliability. The drift of the magnetic characteristics would stay within spec. We made 100 of the model 10s, and they're OK if no one gets a magnet near them. There are always little problems in manufacture – the dial mechanism is a problem, for instance. We redesigned that in the 10B to make it easier to assemble. We had learned enough in production of the 10 that it took us another year to come out with the 10B.

We hired a consultant in the beginning named Mitch Cotter. (Mitch could not be reached for an interview.)



## Mr. Saul Marantz discusses his revolutionary new model 10-B FM Stereo Tuner

**Q. Mr. Marantz, your new 10-B tuner is quite revolutionary. Do you feel it will obsolete all other tuners?**

**Mr. Marantz:** In one sense, yes. The performance of this tuner is so dramatically superior to conventional tuners that anyone who wants or needs perfect FM reception today has no choice but to use the model 10-B. Its superiority, however, does not necessarily *obsolete* conventional tuners. Rolls Royce, of course, makes superior cars, but they haven't obsoleted Chevrolets.

**Q. Is this superior performance discernible to the average listener?**

**Mr. Marantz:** Very much so. The difference is quite dramatic. As you know, conventional tuners have never been able to pick up and reproduce broadcasts which could match the quality of a fine disc or tape playback system. This has often been blamed on *broadcasting* quality. But the new 10-B disproves this theory. It reproduces the *broadcast* of a disc or a tape with the same clarity and separation as if played through a playback system — proving that broadcast quality is generally excellent.

**Q. Is this true with weak broadcast signals also?**

**Mr. Marantz:** Yes. In fact the model 10-B will reach 55 db quieting at only 3 microvolts! This is better than most conventional tuners will reach at 1000 microvolts. With a 25 microvolts station the Model 10-B reaches a phenomenal 70 db quieting which is about 20 db better than most conventional tuners can achieve at *any* signal strength. This means that with the Model 10-B there will be excellent reception even in fringe areas, particularly so because of the tuner's high sensitivity, its extremely sharp selectivity and reduced susceptibility to multipath effects, which on other tuners cause distortion.

**Q. How are such improvements accomplished?**

**Mr. Marantz:** The answer to that question is very complex, because the 10-B is far more than an improved tuning system; it is a completely new *design concept* with *many* technical innovations developed by Marantz engineers.

**Q. Can you give us some examples?**

**Mr. Marantz:** Yes. The RF section, for example, contains a balanced-bridge di-

ode mixer — a technique used in modern sensitive radar designs to eliminate a major source of noise, harmonic distortion and other spurious interference. The whole RF circuit is balanced-tuned, using a precision tuning capacitor with four double sections, for further reduction of spurious images.

For the critical IF strip, we've developed the first commercial application of the "Butterworth," or phase-linear filter. This new concept provides a number of distinct characteristics essential for good results. The passband, for example, is phase-linear for extremely low distortion — especially at high frequencies — and it remains essentially phase-linear at all signal levels.

Cutoff slopes beyond the passband are extremely steep, allowing unprecedented selectivity; it is much less subject to the effects of multipath, and it doesn't require realignment with tube changes or aging. The old standby coupled IF circuits currently in use do not have any of these characteristics.

**Q. Are there any innovations designed specifically for multiplex?**

**Mr. Marantz:** Yes. For multiplex reception we've developed our own unique

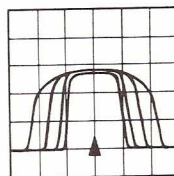

IF Passband retains phase linearity and sharp slopes at any signal strength for low distortion, sharp selectivity.

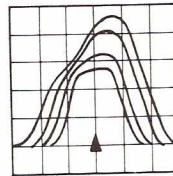

Conventional mutually-coupled IF circuits change characteristics drastically depending on signal strength.

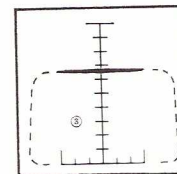

Station tuning is simply and accurately adjusted by centering the trace.

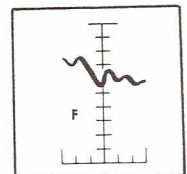

Multipath (Ghosts) shows up as 'wiggles' on the tuning trace. Antenna is simply rotated until trace is smooth.

MARANTZ MULTIPATH/TUNING INDICATOR



**marantz**

MARANTZ, INC., SUBSIDIARY OF SUPERSCOPE, INC., SUN VALLEY, CALIF.

## T H E B I R T H O F T H E M A R A N T Z 1 0 B

The philosophy of the design, the proportioning of the stages, and so on with the 10, and some of the mathematics involved, were derived from Mitch. He was a theoretician. He wanted to use a switching power supply in the tuner, for example. It required many different voltages, including the CRT voltages, but in those days digital switching power supplies switched in the audio band, which was audible. We ultimately had to go to a linear supply. But he was a brilliant guy.

We used an idea we got from Tektronix oscilloscopes on the model 9 amp and 10B tuner – neon safety lamps, to protect the tubes at turn-on in the direct coupled audio stages. It kept the grids from going too far positive before the filaments come up – you could have a few hundred volts on the grids! It would arc internally, but the neons come on at 70, 80 volts and protect the grids. It only adds a few picofarads of capacity to the circuit. It's a great, cheap way to protect circuitry that's direct coupled. A lot of other companies should be using it. But that's what it's there for. In the 10B we also used them in light-activated switches, which we made to switch from stereo to mono, and for muting. They were silent and very smooth. We put those together ourselves. We tried to build things that would last.

Now, the IFs. Most tuners use double-tuned IF cans, which go out of alignment with time. They drift. Our design goal was to make something that did not have to be aligned and tuned. Never try to adjust the IFs on a 10B!! We hid the tuning screws so no one could easily get into it. The final inductor in each stage is vari-

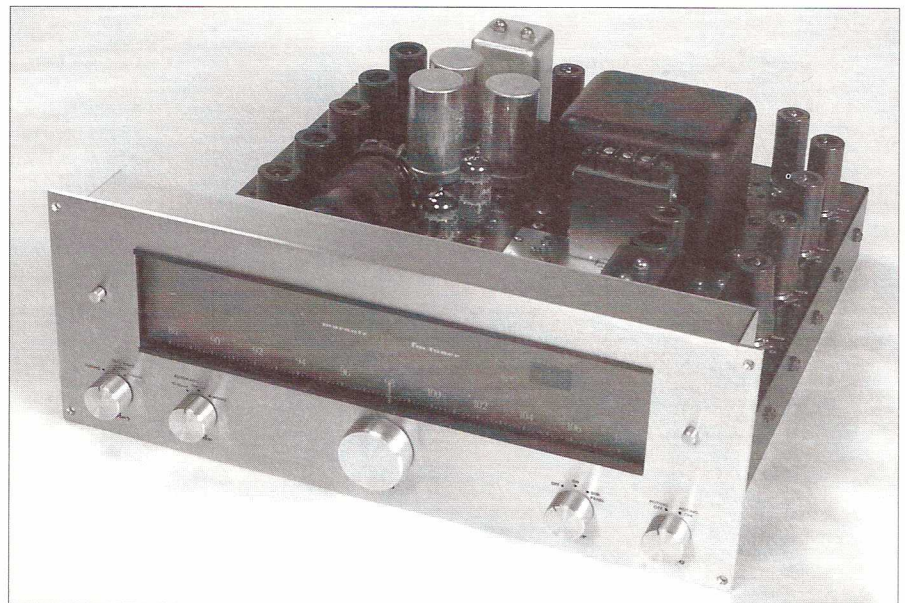

able and these IF stages were aligned in a jig in the factory and people who want to get in there and twiddle with them are crazy! There may be no way to really put it back right again.

Here's what really should be said about those tuners. We had special equipment that we designed on the production lines to align these initially. It may be okay to adjust the last IF inductor if you change a tube for tilt of the passband if you have a sweep generator, but that's it!

We used a balanced RF system and a very special, expensive 8-section tuning capacitor made by Hammarlund. It's a similar system to push-pull, it balances out the circulating currents and minimizes

cross-coupling from other stages. We used the same system (balanced) with the Sequerra tuner, but we used varactors.

The multiplex section is something that people don't really appreciate. I never wrote an article on it. It's called "quasi-vestigial sideband system," we used more of the lower sideband than the upper sideband by unbalancing the mix between the two over the frequency range. The phase/amplitude relationship of that is very tricky, and we used a phase-linear filter to keep the separation high. I came up with that. To set this up in production I had to modify some of the available multiplex generators then. I had to "un-kink" some of the distortion. Later at Sequerra we designed our own.

Our production manager was Joe Sclefani, who has since died. He was very conscientious about things, and every time we tried to blame a worker for something, he was right behind them. He was so helpful and important to us that we hired him on for a while at the Sequerra company. The service department changed a lot, and Engineering always worked closely with the guys in Service and Testing. Joe Sclefani would appoint people to quality control as part of the production department.

The 10B we built in sub-assemblies. It's very important to break things down like that. We followed the same philosophy with the Sequerra tuner, and on that project our roles were reversed. Dick was my boss since it was his company. If you can get in touch with him he could tell you more. Dick and I spent one day with Mitch on transistors, and that got us started

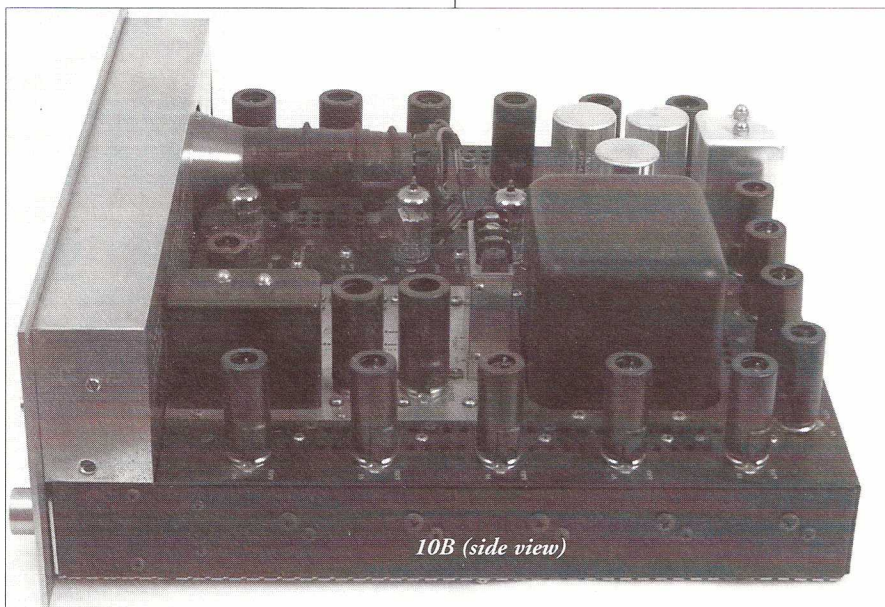

10B (side view)



on the 7T preamp. We put off working with solid state deliberately, I didn't want to know anything about transistors while we were working on the 10. And that led to the 15, which I designed.

Interestingly, neither Mitch or Dick or I were graduate Electrical Engineers. Here's an interesting story: After the war, Mitch was in the Genius Program at the University of Chicago. They took genius kids out of school and taught them college level things in an experimental program. These were children 8, 10, 12 years old. Gave them research to do!! Mitch was one of these kids, educated by the University of Chicago but not on a regular degree program, as far as I know. And Dick is one of those guys who doesn't study by conventional means at all. I have no EE and Dick doesn't either. I had some speeded up radar training in WW2, then went to India and worked on direction-finding radios for airplanes. When I came back I wanted to be a singer! I did quite a bit of work to be an operatic tenor. I came to New York from Chicago after I worked for Radio Craftsmen. I have 3 years of college but most of it is in Music. Anyway, I had a list of about 8 different hi-fi companies that I interviewed with in NY, and I interviewed with Saul Marantz. He was making the Audio Console preamps in his basement at that time. He had one full time lady and a few part-time, and I came along just as he was finishing up the first 100. He was a commercial artist, and I met him in his art studio. This was the end of the summer of 1954. Shortly, he moved his operation from the basement of his house in Kew Gardens, Queens to Vernon Boulevard. And that's how I came to Marantz."

### Dick Sequerra

Dick Sequerra is a man who doesn't rest. After working as an engineer at Pilot radio and running his own company (Unilux), and working for Marantz, he went into the speaker business and is now in the business of making spark plugs (advanced, and revolutionary, of course) for cars. Along the way he also started the Sequerra company to make the fabled FM1 tuner. Being such a busy guy, I felt doubly lucky to be able to interview him on his involvement with the 10B. Here's what he had to say:

"Before I went into the Army I worked for a company called Hudson Radio. I heard through a friend that Marantz needed some help. I had another business going at the time. I was interviewed by Saul and by Syd and I was

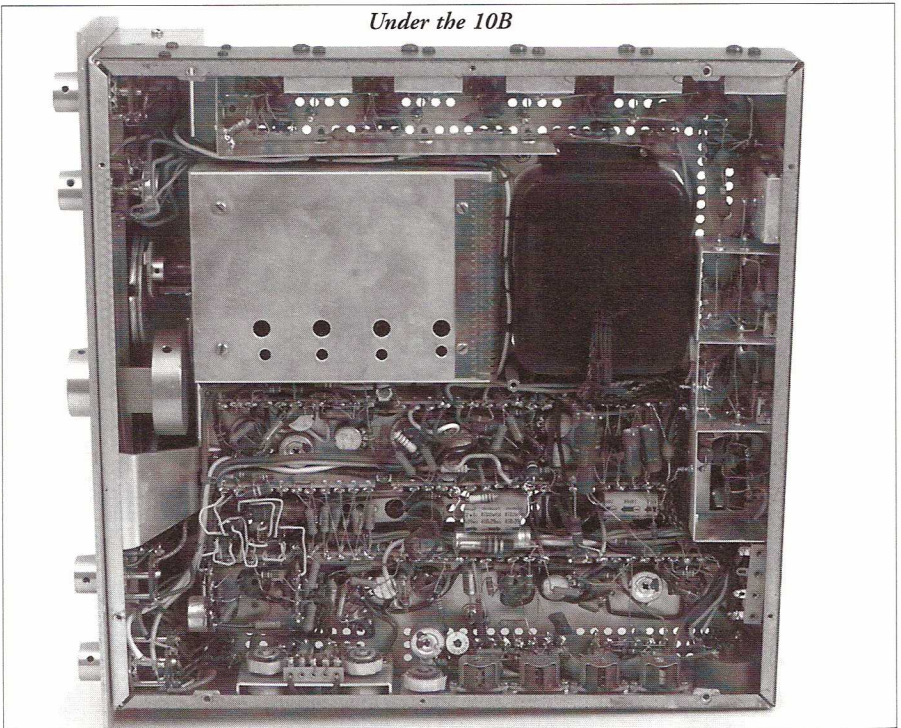

hired on the basis that I could only be there 6 months or so, and tell me what you'd like to have done. They were setting up to make the transformers for the model 9, and asked if I could supervise that. I said "sure," since I was just getting my company, Unilux, off the ground. We were making the largest stroboscopes in the world for commercial and industrial applications, like for inspections in steel mills, video, and so on. The company still exists. So I invented all of that. At Marantz, I supervised all the tests that had to be done and did general engineering work. Then, because I had worked on RF at Pilot, and since Marantz had no tuner, and I had done some tuners at Pilot, I started work on a mock-up of a conventional tuner for an audio show to show that Marantz had a tuner in the works. One thing led to another, my thing at Unilux went more slowly than I had hoped, and I started to work at Marantz. They kept on saying "this tuner has to be the best tuner in the whole world, beyond anything that has ever been done," so it all had to be looked at afresh. Mitch Kotter came in as a consultant. He had a firm up in Riverdale, and he said there are new approaches to doing this. The use of an oscilloscope was his suggestion, and more elaborate filters were also his suggestion, though he didn't design them. Essentially, that's the genesis of it, and as you know, when something gets started it gets a life of its own.

The ring bridge mixer was my idea.

Ring modulators were developed many years before that, the Germans had used them, but the problem was we didn't have diodes of sufficient quality. Then Hewlett-Packard introduced hot-carrier diodes for use in military and instrumentation electronics. We were the first people to use these in a consumer product, or even a commercial product. They were terribly expensive (HPA-2034). We traded off a conversion gain to be able to balance out the common-mode anomalies, and it was designed with that in mind.

After I came back from the GE Stereo symposium, I built the first stereo generator that we used. The 10B was truly a collaborative effort between Syd and I, and we were both responsible for the finished product. Now for the IFs: there was an article published by the IRE (now the IEEE) by Dr. Dishell in which he defined, theoretically, the ideal filter for phase linearity over any given, defined bandwidth. Most of us were members of the IRE, and a guy who worked with Mitch, Larry Saleckson, now the head of test for Consumers Union, pointed out that Dishell's work, with a 3-pole filter, was probably the best way to approach this. But the realization of this, the actual design, was Syd and I. I bought a very exotic Q-meter and a scope that could do X-Y at 10 MHz, a Tektronix 536, so we could measure the phase change thru the filter and we could define it very carefully. But I realized the filters.

We worked a good two years, sometime 18 hours a day, weekends, it was really hell. Though it was built like a commercial or military item, we viewed it as a consumer product, with the constraints and compromises you would make for a consumer product, regardless of where it stood vis-a-vis the rest of the industry. I did not try to write up anything on the circuit. We didn't want to disclose too much because people might try to "sweeten it up," so to speak. That would cause trouble. Later, when I made the Sequerra I tuner, we had a few 10Bs that had never been touched. They just sat. There was nothing wrong with them. We specifically did this to help project a mean time between failure based on experience with the Marantz. Our opinions were validated that we should have not disclosed what constituted the tuner and how to align it. I had trained service men many years earlier, and I knew what with egos of service men, they would want the opportunity of improving it. This was a real anxiety of both Syd and myself. This was a new product, but the survival of the company depended on it. We did not want any problems in the field. We finally published a schematic. And that's all that was ever published. Now, in the 10B, (not the 10), the IF's were first put in an oven then put in an alignment fixture. They are aligned hot. I built a special jig to do this. We knew the temperature the set would reach, and that's the temperature they were aligned at.

We used some very exotic front end tubes. We did not want to use Nuvistors. We used the 6JK6 tube because I was innocent - Sylvania misled me. It was their new tube at the time. They told me it had the highest transconductance (18,000), and it was going to be used universally in television sets. At the time it was the most fantastic little tube going. We designed the IFs around a gm of 8,000-9,000 so as the emission falls off in time, nothing would happen. Then, of course, TVs started going solid state, and the tube is now scarce. But I never would have designed it around the 6AU6. It's a much older design, it had other problems. I would have needed more gain, more tubes, and making that string of tubes longer gets tricky. If you look at the bottom of the tuner, you see all the shielding, all the bypassing and, frankly, I didn't have as clear an understanding of how to deal with some problems of RF feedback as I do now. It was very difficult to have that IF string turn around like that.

Now, the RF front end uses an all balanced system, and a very special 8-gang tuning capacitor. This was used by General Radio in their test equipment, but not in a home tuner because it is so expensive. It's only a question of money. It's a vastly better way of dealing with front end design because it balances out common-mode feedback problems. It was the most expensive gang that was ever used in almost any product, consumer or military. In order to get that gang, it took the head of design at Hammarlund and me probably a few weeks, then I went down to Mars Hill, North Carolina (the Hammarlund factory). They are all made out of Invar, so that their temperature coefficient is pretty flat. It was the most expensive part in the tuner. A gang like that is just unthinkable today. But I had insisted on a linear, 10 inch dial, which is another problem. Which meant that the increments, the delta changes in the tuning cap, had to be very accurately controlled.

I learned some of this at Pilot. I designed all their production test equipment. I designed a resistor noise measuring set that became the standard of the industry. Before that I was at Telefunken right after I got out of the Army. When you take an average engineer, which is what I am, and you give them the opportunity and the facilities and you don't sit on their backs then, you can produce wonderful things. I don't consider that I'm that unique, I think that my opportunity was unique. First of all, working with Syd. Two totally different types. Between the two of us, we've been told we make a very good engineer. I think Syd is the best engineer I've ever known, most capable and gifted. I'm more theoretical than Syd, we take different approaches, and when we fight and argue together. What has come out of our work over the years has been very nice. I want to emphasize the work that he did. Without either one of us, you never would have had the 10B. I miss working with him, there's an understanding, an empathy, after working all those years.

**Marantz 10B Technical Features and Specifications**

*(from Marantz 10B Data Sheet)*

**Features:**

**RF Section** - The precision tuning capacitor has a "Linear frequency" characteristic so that station calibrations appear evenly and accurately spaced along a full 10" tuning dial. RF stages are balanced-tuned throughout. An important feature is the radar-type balanced-bridge diode mixer.

**IF Section** - The unique MARANTZ IF circuit is based on the development of an "18-pole" phase-linear filter. The ideal characteristics of the filter passband permit performance improvements which are unobtainable with conventionally coupled circuits. Phase linearity in the 200 kc passband eliminates a major source of high-frequency distortion and loss of separation. 108 db/octave cutoff slope makes the Model 10B the most selective FM tuner in existence. The strongest signals have no deteriorating effect on its ideal passband characteristics. IF alignment is permanent, being unaffected by tube changes or normal aging.

**Limiters and Discriminators** - There are 9 limiters in the Model 10B using matched pairs of silicon planar diodes. Each IF stage is self limiting, preventing overload on strong signals, and eliminating the usual need for AGC circuits. Quieting on weak signals is close to the theoretical threshold, with the ultimate quieting in excess of 70 db. The discriminator circuit is extremely linear, ensuring low distortion throughout the subchannel range.

**Multiplex** - The highly sophisticated MARANTZ circuit permits the inclusion of phase correction to maintain proper phase-amplitude relationships. This allows the use of an extremely effective SCA rejection filter without the usual loss of separation at high frequencies. Separation is well in excess of 30 db to 15 kc. The output filter circuit provides very sharp attenuation of residual sub-channel components above the audio range, eliminating noise and interference from SCA. Precision-gapped ferrite cup cores or precision toroidal cores are used in all filters. Automatic stereo switching and inter-channel muting are both accomplished by means of ingenious electronically triggered photoelectric circuits.

**Multipath Tuning Indicator** - In March, 1962, MARANTZ introduced the concept of using an oscilloscope tube as a multi-path and tuning indicator in the early prototypes of the model 10. As each station is tuned, its correct center position on the passband is clearly displayed. Simultaneously, the presence of multipath becomes visible, making it quite easy to readjust the antenna for beat results. A panel switch permits test display of the left and right FM channels, or external signals from tape recorders, discs, etc.

**Specifications:**

**I.H.F. Sensitivity** - 2  $\mu$ V or better

**Quieting Slope** - at least 50 db @ 3  $\mu$ V, 70 db @ 25  $\mu$ V.

**6 IF Stages** - Each with 3-pole phase-linear band-pass filter. IF bandwidth, 200 kc. Cutoff slopes, 108 db/octave.

**Selectivity Curve** - Adjacent carrier - 42 db; Alternate carrier - 150 db.

**9 Dynamic Symmetrical-Aperture Limiters** - full limiting on noise.

**Ultra-linear Discriminator** - For low distortion through sub-channel range.

**Balanced-Bridge Diode Mixer.**

**Automatic Stereo Switching** – Photoelectric, with indicator light and threshold adjustment.

**Interstation Muting** – Photoelectric, with defeat switch and threshold adjustment.

**Total Spurious Rejection** – Better than 100 db. Includes images, cross-modulation, etc.

**Volume Sensitivity** – -10db maximum (reached at 0.8  $\mu$ v).

**Harmonic Distortion** – Less than 0.2% @ 15 kc after de-emphasis, and less than 1% at detector.

**AM Rejection** – At least 70 db @ 80% modulation with all signal levels.

**Separation** – Approximately 45 db average throughout the range. Better than 30 db at 15 kc.

**Built-In Multipath/Tuning Indicator** – 3" oscilloscope tube.

**Tuning Gang** – Military type, silver-plated, four balanced sections, ceramic spacer. Precision calibrated at 10 points.

**Dimensions** – Front Panel, 15 3/8" x 5 3/4" (39 cm x 14.6 cm); Chassis, 14 3/8" wide by 15" deep (36.5 cm wide by 38.1 cm deep) (Panel dimensions are identical to Model 7).

**Panel Finish** – Gold anodized, to match Model 7.

**Shipping Weight** – 38 lbs (17.2 kg).

**Price** – \$650 dollars (higher in West)

Anyway, I stayed at Marantz from 1961 through 1967. The last project I worked on was the model 18 receiver. I left in February, Syd left in March (Marantz had been sold to Superscope, and Saul Marantz left the company at that time - MZ) Then Syd came with me and we developed some additional things for Unilux. I'm very proud of what we've done together. Syd is a very modest guy.

Now I've developed a new electrode for spark plugs, the company is called Research Transfer Technology, and I still have R. Sequerra company, making speakers and a new pre-amp. I was going to introduce a new world-wide tuner, from 10kc to about 500Mhz. But no one wanted it. The future is moving to satellite communication. Terrestrial things are serviced very nicely by a car or table model radio. The CD also put the nail in the coffin of radio. The Sequerra FM1 was not a commercial success. We made about 1400 of them, we had an offer to sell the company, one of the principals refused to sell, so Sydney and I walked. But it was never designed to make a profit; it was designed to set an example.

Incidentally, the 10B started out as the model 10. There were only 94 of them made. We took a look at it, it was like the pilot run. We said "Gee, we gotta take money out of this thing." It had 8 chrome plated chassis, the IF's are in cans above the chassis. The circuit is

essentially the same with one or two small exceptions. We also made the 10B in a rack mount version. One of the reasons for the change in the IF layout was production. I had built the Model 10 IF's with toroids, and the Weller soldering guns used by some technicians would magnetize all of the toroids so the whole IF was ruined. We said "this is ridiculous, we can't use toroids," we couldn't take the chance. I also threw out all the solder guns. Then we went to pot cores, which are self-shielding. But once we got these bugs worked out it all worked smoothly. The tuner was produced into 1970, and we made about 14 or 15 thousand units, maybe even more. (Note: *Many Marantz experts think only about 5000 10Bs were made based on serial number surveys - Ed.*) They stopped making them when they moved out of the Woodside, New York plant to California. The Tushinsky brothers, who ran Superscope, were making 1,000 at a time, at least.

**Saul Marantz**

Like Sid Smith and Dick Sequerra, Saul Marantz is a gem. I called him out of the blue one Sunday morning. He spoke to me as if we were old friends, and he had this to say about the 10B:

"Many people feel, to this day, that the 10B was the best tuner ever made. When I was in Japan in 1975, the price on used ones was about \$3,700, and a few years ago I heard they were over \$10,000. When they were new, the last price was about \$750, retail, and I still felt I was putting a few hundred dollars in every box. The cost of developing that unit, over about 3 1/2 years, was enormous. My wife had to put up some cash to help out. In fact, we were thinking of closing up, of finding some way to get out, when the offer from Superscope came up."

Incidentally, Saul recommends that anyone who needs old Marantz gear repaired contact Tom Cadawas of Staten Island, New York (718 981-9138) for repairs. Tom was the Service Manager at the Marantz factory from 1964 until Superscope moved the company to California in 1974. Tom says that 10Bs were definitely being produced until about 1973 in New York, and he remembered that the Measurements 310 RF signal generator was being used on the line for production testing, with custom designed stereo generators.

**Bibliography**

"An interview with Saul Marantz," *The Absolute Sound*, issue 94, Spring 1994, pages 54-82 – A superb, in-depth interview with Mr. Marantz.

"World's most expensive FM tuner," *Radio-Electronics*, July 1966 By Peter Sutheim, pages 30-34 – A rare interview with Dick Sequerra explaining some of the design details of the 10B.

"This FM tuner costs \$2500!" by Len Feldman – *Radio-Electronics* March 1975 – Interview with Sequerra and details of his model 1 tuner.

**Test Reports**

*Audio Magazine*, April, 1965

Mike Zucarro, based in San Diego, California, is a full-time audio technician and tube electronics specialist.

**VINTAGE HI FI SPECIALTIES PRODUCTS**



- 1. **Vintage Hi Fi Spotter's Guides**  
Volume 1 or 2 \$18.95 each
- 2. **The Ultimate Tube Substitution Guide** 240 pages \$29.95

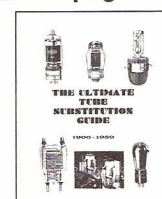

- 3. "Vintage Hi Fi - The Golden Era" the video \$25.00
- 4. **Tube Audio schematic and literature list \$5.00 (refundable)**

US Checks, Credit Cards  
Foreign orders add \$7.00 per item for postage and handling.

**Vintage Hi Fi Specialties**  
1095 East Duane Ave. #106  
Sunnyvale, CA 94086  
408-733-6146  
triode@vacuumtube.com



## Cathode Bias

by  
John Atwood

### Buyer Beware, Part 2

In *VTV* issue 3, I talked about the problems of old components. This time, I will look at consumer problems in buying tubes. Counterfeiting and misrepresentation have been part of the human experience for ages. Any time there is a commodity that has value that is not always obvious to the buyer, unscrupulous sellers have taken advantage of buyers. With all the different brands and grades of vacuum tubes on the market, it is not surprising to see misrepresentation of tubes. With the recent increased interest in tubes, shady dealers are coming out of the woodwork. Some of the techniques of misrepresentation to be careful of will be looked at here.

Misrepresentation of tubes is nothing new. Anyone reading serviceman's trade magazines from the 1930's, '40s, and '50s will see stories of companies caught selling "rebranded" tubes or used tubes being sold as new. By the mid-fifties, enough pressure was applied to this situation that some of the companies, such as Rad-Tel, went "legitimate," and specified in their ads that their tubes were surplus or re-tested. However, I have tested many off-brand tubes in their characteristic red and white boxes with the brand name crudely stamped on, and found many tested very poorly.

Don't confuse "re-branding" with cross-branding. Since each tube manufacturer supported a dealer network that required a full complement of tubes for all TVs and radios, many manufacturers would make arrangements to exchange tubes with other manufacturers, so each would not have to actually make all tube types. In an upcoming article in *VTV*, we will explain how to identify the actual manufacturer of a tube, regardless of the brand marked on the tube, to help in spotting cross-branding. By the late 1970s and 1980s, most American tube companies were phasing out their domestic production, and bringing in tubes from England, Holland, Japan, Korea, and Eastern Europe. This cross-branding is actually re-branding (since the American companies had few tubes to exchange), but was perfectly legitimate.

### Fake "New Old Stock"

With the rapidly increasing prices for certain N.O.S. (New Old Stock) tubes, i.e. unused tubes in their original boxes, there have been more reports of fake N.O.S. tubes showing up. A friend of mine gave me an interesting example of this. He was looking for N.O.S. Mullard EL34s. A tube distributor in Southern California (which will remain unnamed here) said it had some, so he ordered them. What he got were suspiciously new looking EL34s, stamped Mullard, in plain white boxes. He returned the tubes, complaining that what he wanted were original tubes in their original boxes. He then received EL34s in old Mullard boxes. But the tubes themselves were the same new-looking ones stamped Mullard. My friend was not sophisticated enough to actually identify original Mullards, but he suspected something fishy was going on, and ended up eventually returning the tubes.

My friend was lucky, since he got his money back. However, there are many overseas tube buyers, particularly in Asia, that buy American tubes sight-unseen, and are perfect targets for this kind of abuse.



Tung-Sol 6550, "Mullard" marked Tung-Sol 6550 and Philips-marked Chinese 6550

### Old Tubes as New Tubes

An interesting twist on re-branding tubes is the rebranding of good N.O.S. tubes with a contemporary brand, and being sold as new. In the old days, this might have been considered a questionable tactic, but today, the N.O.S. tubes are often better than newly manufactured ones. Richardson Electronics' National Brand is well known for doing this. In all National receiving tubes I have seen, the tubes have been re-marked, but the originals appeared to be unused, high-quality tubes, often from U.S. military stocks. Having a consistent brand name simplifies stocking and inventory, but the buyer doesn't always know what brand they are really getting.

### Right Name, Wrong Tube

Another misrepresentation of tubes is changing the name of a tube. A well-known example of this was the renaming of 6ES8/ECC189s as 6DJ8/ECC88s. Both look the same, and are roughly similar in characteristics, but the 6ES8 is a remote-cutoff type that will cause substantially higher distortion in audio applications. Some tube substitution guides list the 6ES8 as a replacement for the 6DJ8, which is possible in RF front-end applications, the original use of the 6DJ8, but this does not work in audio or oscilloscope applications. Another example is the renaming of GZ32s, 5V4Gs, and even 5Y3GTs as 5AR4s. These may work, but will often arc-over or have a short lifetime. A similar example is the Sovtek "5V4G." The little Russian data sheet that comes with the tube gives it a maximum current rating of under 125 ma, as opposed to the 175 ma rating of a real 5V4G, and indeed, I have had problems with them when used in applications designed for a 5V4G. The Russian tube is nicely built and works well in low-current applications, but should really be considered a "5Z4GT."

Somewhat more innocuous is the renaming of tubes with essentially identical electrical characteristics. A good example of this is the KT88 and 6550. Both have basically the same characteristics, but the original G.E.C. (Genelex) KT88 had lower grid current and was more reliable. Nowadays, it is common to see Chinese 6550s and KT88s that clearly came off the same production line. The KT88 may have the straight-sided English-style envelope, but are otherwise the same. The problem here is that some people still think that the name "KT88" implies the higher quality of the original English type, and are willing to pay more money for it.

Even more disturbing are reports of people buying 45s and getting Chinese 2A3s. These two types, while sharing the same filament voltage, are sufficiently different that an amplifier could be damaged by using the wrong type.

### "Selected" Tubes

Another area of consumer confusion is from "selected" tubes offered by many companies, such as Audio Classics, Groove Tubes, RAM Tubes, Ruby Tubes, ARS, etc. These are usually either matched (for output tubes) or selected for low noise (for input/preamp tubes). One problem is that buyers are often convinced to buy a better type than they



really need. For example, most of these companies don't indicate which amplifiers have a more critical need for matched tubes than others. The main problem, only with a few of these vendors, is the hyping of very high quality types that are actually just selected versions of standard Chinese or Russian tubes. If the claims were modest, this might be reasonable, but, for example, one vendor was claiming their 12AX7s were as good as the classic flat-plate Telefunken. To put it bluntly, even if you pick the best-looking turd, it is still a turd. The classic tubes had attributes that cannot be obtained by selection, such as superior metallurgy and processing. Also, every tube brand tends to have certain sonic characteristics. Simply selecting based on noise, distortion, or whatever, is not going to impart these qualities. Sophisticated buyers will see through the advertising claims, but many buyers will spend their money on these tubes with high expectations. If one is willing to select for low noise or do the matching themselves, they can often save money.

### What to Do?

What do you do to avoid these pitfalls? The best way is to become an educated tube user: learn how to spot real N.O.S. tubes, learn how to test tubes to spot used ones, know what selected types you really need. Also, buy from trusted dealers. Ask how they select their tubes, how they get rid of bad ones, and what their return policy is.

I recently went to Phoenix, Arizona to visit Antique Electronic Supply concerning distribution of my One Electron transformers. While there, I was impressed by their honesty in selling N.O.S. tubes. Their catalog clearly states whether a tube is new, used, or N.O.S. Their incoming examination of tubes weeds out used or defective tubes quite well. And, if the box of an old tube is damaged, they will place it in a white box, and correctly mark that it is unused or used. They will even try to ship a particular brand, if it is available. This is an example of how tube dealers should be run. I do have a business relationship with Antique Electronic Supply, but was aware of their service well before working with them.

Fraud and misrepresentation will always be with us, but the best way to combat it is to be sophisticated enough not to get misled. If you can't learn to spot misrepresentation, then learn who to trust to give you good advice. Don't forget, it always takes two to complete a transaction, and if you are suspicious, you don't have to buy.

## The Art Of Rectification

By Terry Buddingh

True guitar amp connoisseurs know the "sweet spot": the dynamic pivot point between crystal-clean and the threshold of increased distortion. Skilled players can use this phenomenon to expand the timbral dynamic range and voice of their instrument—play lightly and the sound is sweet and pretty; use a more aggressive attack and the tone becomes progressively more mean and nasty. The tonal spectrum's broad palette can be accessed simply by varying one's technique. The amp responds like a musical instrument.

Each amp has its own particular volume level where this sweet spot occurs. A Fender Champ begins to distort at a much lower volume than a Super Reverb. Many guitarists keep a stable of amps to accommodate various playing situations. It's possible to move the sweet spot up or down by substituting different rectifier tubes.

All tube rectifiers have a certain amount of internal resistance that produces a voltage drop. This voltage drop increases as the current increases (Ohm's Law). Solid state rectifiers have very little resistance so they have the least voltage drop. Tube rectifiers with indirectly heated cathodes generally have less voltage drop than those with directly heated cathodes. The other advantage of the indirectly heated cathode rectifier is its slow warm-up time. It takes about 30 seconds to attain full DC voltage, thus allowing the other tubes to warm up before the high voltage is applied. It also charges the filter capacitors slowly, straining them less.

The ranking of commonly used rectifiers from least voltage drop to most voltage drop is as follows:

**1. Solid State:** The least dynamically responsive (in regards to changes in timbre). The tone stays tight, stiff, and punchy. It provides the most headroom. 1N4007 rectifiers are the most commonly used today.

**2. Type 83:** A mercury vapor rectifier tube used briefly by Fender in the late 50's. It requires a four pin socket and 3.0 amps of filament current. You can expect about a 2%-3% reduction in B+ voltage compared to solid state rectification.

*Mullard Type 1, Mullard Type 2 and Bugle Boy 5AR4s*



**3. Type 5AR4/GZ34:** An indirectly heated cathode rectifier. Due to their great musical sweetness and clarity, the most famous and sought after examples are the Dutch-made Amperex and the British Mullard. Many were re-branded RCA, GE, Tung Sol, etc.. The earliest examples utilized a metal collar around the base. The use of serrated cut-outs on the plate edge appeared later. Some examples have four cut-outs, while others have seven. B+ voltage will be about 3%-7% lower than solid state devices. 1.9 amps of filament current.

*Bugle Boy, Sylvania and Chinese 5AR4s*



Beware of fraudulently re-labeled 5Y3s, 6087s, etc. Memorize the internal construction details of a real Mullard GZ34 so you won't get burned. There are some nice Japanese built Mullard copies. You can spot these by their pronounced "X" seam on the top of the bottle. Sylvania and GE also made their own domestic versions of this tube.

**4. THD's "Reactive Rectifier":** A solid state rectifier replacement designed to mimic the voltage drop and other characteristics of a 5AR4. Sonically it's between a 5AR4 and a solid state rectifier—a bit tighter and dryer than a tube, but more musically responsive than conventional solid state rectification. No filament supply is needed so it can be used to "soften-up" non-tube rectifier amps such as Fender Twin Reverbs, etc.

**5. Type 5V4:** Another indirectly heated cathode tube, rated for less current than a 5AR4. NOS examples are primarily US made. The hard-to-find Mullard GZ32 is an excellent Euro near-equivalent. 2.0 amps filament current. 6%-12% less voltage than S.S. types.

RCA-5V4G, GE and RCA 5V4GAs

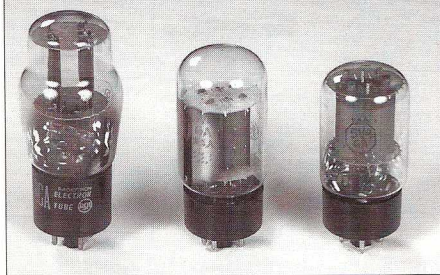

**6. Type 5U4:** A very common directly heated cathode rectifier. Every US tube manufacturer made millions of these. European near-equivalents include the indirectly heated cathode GZ37 and currently prevalent (and gorgeous) CV378. A 5U4 requires 3.0 amps of filament current. Beware! This could be 1 amp more than your power transformer was designed to handle! 8%-16% less voltage (depending on brand) than S.S. types.



5U4G, and two types of 5U4GBs

**7. Type 6106:** A fairly uncommon, lower current, US industrial tube with an indirectly heated cathode. 11%-20% less voltage. The 6106 was originally made by Bendix as a Red Bank type. Some of these have been re-branded as GZ34/5AR4s. They are really a ruggedized 5Y3GT.

**8. Type 5R4:** A heavy duty directly heated cathode tube. NOS examples made by Chatham are especially rugged. 2 amps filament current. Expect a 12%-22% reduction in B+ voltage compared to S.S. types.

**9. Type 5Y3:** A lower current directly heated cathode tube. 2 amps filament current. 13%-23% less voltage than S.S. types.

**10. Type 6087:** A low current indirectly heated cathode rectifier, referred to by some as an "industrial 5Y3." 2 amps filament current. 18%-30% less voltage than S.S. types.

RCA 5R4GY, Sylvania 5931 and Tung-Sol 5R4



### Effects of Changing Rectifiers

Power = voltage X current. If you decrease the B+ voltage supplying the output tubes you reduce the output power. Changing to a rectifier with more voltage drop lowers the amplifier's B+ voltage, thus lowering its output power and threshold of distortion. It "gives it up" at a lower volume. Lowering the voltage also tends to reduce treble response, richens the midrange and loosens the bass. Keep in mind that you're also lowering the voltages to the pre-amp tubes as well, which respond similarly. Using a rectifier with more voltage drop also increases the amount of dynamic voltage "sag" that gives the notes a more compressed envelope creating more sustain.

By experimenting with different rectifier types the player can tailor his amplifier's response to suit varying playing situations. For a small quiet club gig he might use a 5R4 or a 5Y3 to lower the volume level of the "sweet spot". For loud outdoor gigs he could substitute a solid state rectifier for the most power and volume.

### Effects on Bias Supply

In a fixed bias supply amp the B+ power supply functions independently of

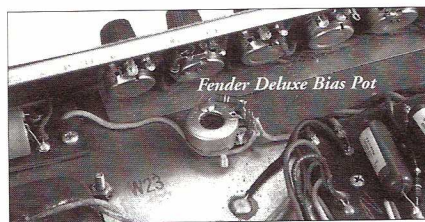

the bias supply. When you change the B+ voltage you must also change the bias voltage! If a set of 6L6s needs -53 volts on the control grid to idle at 35 milli-amps per-tube with a solid state rectifier, then they would need about -43 volts to idle at 35 milli-amps with a 5R4. Failing to re-bias would run the tubes in an over-biased condition producing a

weak and punchless sound on the verge of crossover distortion.

### Bias Settings and Tone

Bias setting definitely affects tone. For 6L6s the idle current "sweet spot" is between 30 and 40 milli-amps per tube. It varies depending on the tube manufacturer, amp design, B+ voltage, player's taste, etc. It's a very subjective issue. Lower current settings sound tighter, thinner, and spankier. Higher current settings sound looser, fatter, and rounder. There's a dynamic sweet spot to look for when making bias adjustments. It can be found by playing the amp at the anticipated performance volume level (preferably by its primary player), and adjusting the bias voltage "by ear" to produce the greatest dynamic range.

The objective is to "ride the sweet spot" between the amplifier classes. The change in tonal character between classes can be used expressively by the player. Use your meters, etc., to verify that the tubes are running in the safe range. Running the bias too hot shortens tube life and threatens runaway, and ultimately tube destruction

### Not Too Much Capacitance!

Over-filtering can be hazardous to your rectifier's life. There's a current trend to injudiciously increase the values of the filter capacitors. The original Mullard spec. sheet for the 5AR4/GZ34 specifies a maximum of 60 micro farads filtering. Increasing the capacitance beyond this limit risks the danger of shorting and damaging the rectifier, because the capacitor can draw excessive amounts of current as it charges/forms. The amount of filtering affects the sound, a little goes a long way, and there's a sweet spot here also. Too much filtering can adversely affect tone—tightening to the point of constriction.

### Conclusion

The art of obtaining great sound is accomplished through the balancing of many parameters, and tailoring these parameters to the needs, playing style, and taste of the individual player. It's obtained through listening, experimentation, and more listening; not from blindly following theories, notions, or advice. Let your ears be the ultimate judge.

*Terry Buddingh, based in Livermore, California, is a performing musician, guitar technician and tube amplifier guru for Guitar Player Magazine, a Miller-Freeman publication.*

# safe S.E.X.\*

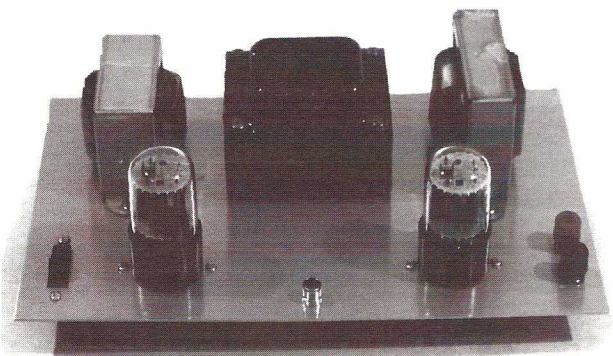

## Single ended amps and speakers for \$350!

The S.E.X. kit of parts includes the following:

- Basic parts for two parallel single ended monoblock amplifiers, using two 6DN7 dual triodes per channel, with power supplies. Includes two laser cut 10" X 6" chassis top plates with cutouts for mounting transformers, tube sockets and other hardware.
- Four 5" aluminum cone full range drivers, two for each channel
- Manual, including plans for speaker baffles, suggestions for chassis bases, and simple "by the numbers" amplifier construction directions. Builders need only supply lumber for baffles, bases for the precision laser cut chassis top plates, and their favorite flavor of wire and solder.

Before you take the plunge, spending big bucks to learn if single ended amps are for you, only to find you need to spend even more money on efficient speakers, you can try a whole singled ended system on your talented ears for \$350 (plus shipping, WA residents incl. 8.1% sales tax).

The Single Ended eXperimentation kit contains the basic parts and instructions to build a pair of great sounding parallel single ended 2 watt monoblock amplifiers and a pair of efficient, full range one way speakers.

Future issues of **VALVE**, the monthly newsletter of gonzo DIY tube audio, will encourage experimentation with the basic kit, publishing lots of modification ideas, from high performance output transformer upgrades by Magnequest, to detailed, radical circuit mods. (You don't know about **VALVE**? Ask for a subscription when you call - it's \$25 per year, \$35 overseas)

You already have efficient speakers? That's fine, we'll sell you a basic "amps only" kit for \$320 (plus shipping and WA resident 8.1% sales tax)

Make sure your first experience with S.E.X.\* is a low risk one. Get a S.E.X. kit! Call 360-697-1936 for more info.

## ELECTRONIC TONALITIES

P.O. Box 2786, Poulsbo, WA 98370

\*Single Ended eXperimentation



## VTV Back Issues

### VTV #1 \$8. ppd US \$10. Foreign

- Early Tube Amps 1920-1938
- History of Dynaco Tube Gear
- Tube Testing Methods
- Audio Test Bench Set-up
- 12AX7/ECC83 History and Tests

### VTV #2 \$10. ppd US and \$13. Foreign

- EL34/6CA7 History and Tests
- Heathkit WM Series Williamson Tube Amp History
- Western Electric Large Theater Sound 1930
- Great Tube Guitar Amps and Tubes
- Tube Matching

Magnum SE Amplifier Construction Project

### VTV #3 \$12. ppd US and \$15. Foreign

- Western Electric 300B History and Tests
- Single Ended Transformer Tests
- SE Transformer Listening Tests
- 1935 E H Scott 48 Tube Classic Radio
- EICO Tube Mono HiFi History and Photos
- McIntosh MI 200 Adventure and Mods
- Dynaco Stereo 70 Super Modification

### VTV #4 \$12. ppd US and \$15. Foreign

- 6L6 History and Tests
- Harman Kardon Citation I & II
- Review of Vintage Bookshelf Speakers
- Tube Manuals from the Golden Era
- Designing for Sound

### Vacuum Tube Valley

1095 East Duane Avenue, Suite 106  
Sunnyvale, CA 94086 USA  
408-733-6146 phone/FAX  
US Bank Check, Master Card, VISA or AMEX



## S.E. OUTPUT TRANSFORMERS

MODEL	PRIZ	Ip	PRICE
CT3KB	3KΩ	100mA	\$195.00
MT5KB	5KΩ	60mA	\$195.00
VT2KB	2.7KΩ	160mA	\$249.00
*E18B	6KΩ	100mA	\$195.00
**E48B	1.8KΩ	350mA	\$425.00

- -.5DB 20 KHz to 30 KHz
- End Bell Construction
- Secondary Wire Output (No Splice)

\* For SV 811-3

\*\* For 4 x SV 811-3 60+ Watts

Call Our Design Department For Any Custom Requirement

### Electra-Print Audio

1311 N. Winwood St.  
Las Vegas, NV 89108

702-646-7990  
FAX 702-646-7752



VACUUM TUBE VALLEY  
SUNNYVALE, CALIF. U.S.A.

Be the first in your neighborhood to have the official VTV "BIG TONE" T-shirt.

2 color heart print available in either **Blue Spruce** or **Desert Sand** colors. (Please Specify when ordering)  
100% cotton shirt. Only extra large available.

Only \$14.50. plus \$3.00 postage US,

CA residents add \$1.12 Sales Tax

Canada and Mexico add \$7.00 postage

Europe and Asia add \$12.00 postage

Cash, Check or Money Order

Credit Cards OK

### Vacuum Tube Valley

1095 E. Duane Ave., Suite 106  
Sunnyvale, CA 94086 USA

## Have You Been Wondering Which Tubes Sound The Best? Then You Need This Report!

Eric Barbour of Glass Audio and Vacuum Tube Valley, recently tested more than 1000 audio tubes-both vintage NOS and current production. These tests resulted in a list of distortion readings that correspond to the sound clarity. Now YOU can know what tube dealers know.

### Tubes Covered

EL-34	300B	6DJ8	7591	6550
2A3	6L6	12AX7	8417	6V6

The test reports in VTV were derived from this raw data!

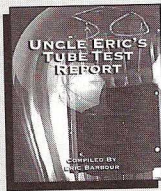

**\$49** Send Check or  
Money Order To:

**METASONIX**  
1095 E. Duane #106  
Sunnyvale, CA 94086

**Now Available!**

## The Randall Amplifier



This is the same amplifier built in the "Audio From Tubes" class taught by John Atwood at the Randall Museum in San Francisco. Available either completely assembled or as a partial kit for the serious constructor.

- Stereo, single-ended amplifier, with 13 watts (RMS) per channel
- 3 db of feedback provides a balance between dynamic sound and good speaker damping
- Power supply distribution isolated between channels, with choke filtering
- All tube design (no semiconductors anywhere)
- All point-to-point wiring (no PC boards)
- Wrinkle powder-coat finish in either dark gray or black (other finishes available by special order)

**Special Introductory**

**Price: \$1395 (assembled)**

F.O.B. Sunnyvale, CA  
Contact One Electron  
for more details

**one electron™**

65 Washington Street, Suite 137  
Santa Clara, California 95050 USA  
FAX: 408 985-2006  
<http://www.one-electron.com>

## VTV Renewal or Subscription Form (Photocopy form)

Yes, I want to subscribe \_\_\_\_\_ renew \_\_\_\_\_ to VTV  
Number of Years \_\_\_\_\_

**\$32/yr** four issues US, **\$40/yr** Canada and **\$45/yr** Asia,  
Europe and World.

Cash, US Bank Check, Money Order or Credit Cards

**Vacuum Tube Valley, 1095 E. Duane Ste. 106,  
Sunnyvale, CA 94086 (408) 733-6146**

NAME \_\_\_\_\_

ADDRESS \_\_\_\_\_

CITY \_\_\_\_\_

STATE \_\_\_\_\_

COUNTRY \_\_\_\_\_ MAIL CODE/ZIP \_\_\_\_\_

CREDIT CARD TYPE \_\_\_\_\_

CREDIT CARD NUMBER \_\_\_\_\_

EXP. DATE \_\_\_\_\_

AMOUNT ENCLOSED \_\_\_\_\_

## GO AHEAD

Ask top engineers and music lovers worldwide what  
capacitor they choose for their ultimate designs.

— H O V L A N D —

## MUSICAP®

The most naturally revealing capacitor. Film and foil  
polypropylene construction — optimized for fine speakers  
and vacuum tube electronics. Precision made in the U.S.A.

Values from .01  $\mu$ F to 10  $\mu$ F.

Listen and compare for yourself.

## UPGRADE NOW

"If you want see-thru, high definition, detail and  
listenability, try the Musicaps." **Joe Roberts**

SOUND PRACTICES, Issue 6

For more information and to purchase, contact these  
quality distributors:

- Welborne Labs, USA 303-470-6585
- The Parts Connection, Canada 800-769-0747
- Michael Percy Audio Products, USA 415-669-7181
- A & S Speakers 510-685-5252
- Allpass Technologies, Inc. 407-786-0623
- SJS Electroacoustics, England 44-1706-823025
- Tang Hill International Ltd., 886-2-5813605

OEMs and international distributors may contact  
HOVLAND COMPANY at 209-966-4377 Fax 209-966-4632

# AUDIO NOTE PARTS & KITS...AND A WHOLE LOT MORE!

## Audio Note UK Kit Amplifiers

**Kit One!** 8 glorious watts of pure Class A single-ended triode power! Tubes: 2-300B, 2-5687, 6SN7, 5U4/GZ37. Designed for experienced D.I.Y. tube audio enthusiasts but several absolute beginners have also crashed the party. If you can mod a Dyna you can build the Kit One! Price \$1300, TUBES INCLUDED! We ship anywhere! Curious? 40 page Kit One Assembly Manual available for \$15 postpaid. Over the past year, reviewers from Listener, Fi and other mags confirmed what we've been telling you for over three years now: the Kit One sounds *wonderful* and is an incredible value for the price! You should buy one today! Hundreds sold *worldwide*!

**Kit Three!** Essentially a monoblock version of the Kit One with double the power, the same components and on two chassis instead of one. Features 2-300B per channel running in parallel single-ended yielding 17 watts, vastly expanding your speaker choices. Price \$2400 per pair, complete with tubes. Manual \$17 ppd.

**Kit Four!** Stereo 10 watt per channel push-pull Class A amp design from the brilliant Steve Wroe of Audio Note UK! Tube complement: 4-6V6GT, 2-6SN7GT, 2-12AX7. Designed for beginners, the Kit Four is fairly easy to build, even if you've never soldered before! Any careful person willing to follow the instructions and learn E-Z basic electronic assembly and test procedure can successfully build this *great* sounding amp in a couple of evenings. Unbelievable price! \$400 complete!

**Audio Note Preamp Kit!** Due out soon! All tube, phono and line stages, avail. in a basic 'bare bones' hardcore D.I.Y. version for only \$199! Other, more elaborate packaging is also available for around \$500 complete. Send SASE for schem.

**Angela Note 91 Single-Ended 300B Triode Mono Amplifier Plans!** Back by popular demand! Still \$5! If you've been thinking about building an S.E. amp you should check out our simplified pictorial plans for building the classic Model 91 style 300B mono theatre amplifiers as featured in Issue One of *Sound Practices*. Includes parts list, schematic, pictorial, MORE! Dozens of our crafty customers worldwide have successfully built these fine amplifiers according to our plans. Our '91' compares very favorably to similar 300B designs costing thousands more. Why not build 'em yourself? It's easier than you think! We include a 2A3 conversion schematic. We've got all the parts you need in stock!

**Audio Note "Experimenter" Output Transformers For Single-Ended/PSE** 2.5K, 15W, 300B/2A3, 90mA, \$75!!!!!!

**Audio Note "Audiophile Standard" Transformers For Single-Ended/PSE** 1.25K, 30W, 2A3/6B4 PSE 130mA, \$160  
1.25K, 50W, 300B PSE 180mA, \$240  
1.5K, 30W, EL34 PSE 180mA, \$175  
2.1K, 30W, 6L6/5881 PSE 140mA, \$175  
2.3K, 60W, KT88 PSE 110mA, \$200  
2.5K, 25W, 300B/2A3 SE 90mA, \$145  
2.5K, 50W, 845 etc. PSE 180mA, \$275  
2.6K, 20W, EL84/6V6 PSE 100mA, \$155  
3K, 30W, Model 91 300B SE 140mA, \$160  
5K, 75W, 211VT/4C PSE 240mA, \$350  
10K, 50W, 211 'Ongaku' SE 150mA, \$225

*Most 4-8 ohm sec., all air-gapped, as found on excellent A.N. UK SE amps!*

**Audio Note "Deluxe C-Core" Output Transformers For Single-Ended/PSE** 1.25K, 50W, 300B SE 90mA, \$400  
10K, 50W, 211/845 SE 150mA, \$475

**Audio Note Pure Silver Wired Output Transformers For Single-Ended/PSE2** 2.5K, 25W, 300B SE 90mA, \$250  
10K, 50W, 211/845 SE 150mA, \$3000

**Audio Note "Audiophile Standard" Output Transformers For Push-Pull** 2.2K, 100W, KT88/EL34 PP UL, \$200  
3K, 50W, 6L6/5881/KT66 PPP, \$100  
4.3K, 60W, KT88/6550 PP UL, \$110  
5K, 30W, 300B/2A3/6B4 PP, \$85  
5K, 30W, 6L6/5881/300B/EL34 PP, \$80  
6K, 25W, 6L6/5881/807 PP, \$115  
6.8K, 50W, 845 etc. PP, \$180  
8K, 15W, EL84/6V6/ECL86 etc. PP, \$85

*All impedances are calculated for Class A. Most have 4/8 ohm secondaries. "Dyna-Acro" etc. "Ultralinear" with screen taps and 4/8/16 secondaries. Made in UK.*

**Audio Note Power Transformers**  
1. For Stereo 300B amp/Kit One, \$160  
2. For Stereo 211SE 'Ongaku', \$175  
Send SASE for hookup diagrams.

## Audio Note Chokes And Inductors

.5H/400mA, \$35  
3H/100mA, \$30  
3H/200mA for 'Ongaku' clone etc., \$42  
5H/150mA, \$40  
5H/400mA, \$60  
10H/125mA, \$50  
10H/200mA, \$65  
20H/50mA, \$45

**Angela Universal Power Trans. For Monoblock Tube Amplifier Projects** 120V/240V primary! 380-320-55 (bias tap) -0-320-380 at 200mA. 6.3V at 2.5A! 5V at 3A for rectifier tubes. 5VCT at 1.5A so ya' can run a 2A3 or 300B! Simple hookup with color coded leads! Send SASE for diagram. Build a classic Model 91 300B SE triode amp! Or, if you need more power, build a 50W Acro/Dyna EL34 amp with fixed bias using the 55V bias voltage tap! YOU be the BIG BOSS MAN! Made in USA. Popular upright end bell type! FIVE YEAR GUARANTEE! EACH \$90!

**'MIL. SPEC.' Potted Power Transformers For Tube Amps** 120V primary, 6.3V at 5.5A, 560VCT at 110mA. Built like a little tank! Potted, sealed, welded steel cans like some old UTC military units. MINT condition USA GONZO government surplus! *KILLER* for building compact single-ended EL34/6L6 or other tube monoblock amps. Mounting studs and solder lugs on bottom of transformer. Approx. 3.5"X3"X4" tall. TONS in stock! WOW! EACH \$38!

**Bartolucci Double C-Core Output Transformers For Single-Ended/PSE** 1.25K, 52W, 6C33 PSE 220mA, \$225  
2.5K, "10W", 2A3/300B SE 90mA, \$185  
3K, 30W, Model 91 300B SE 90mA, \$225  
10K, 30W, 211 SE, NEW Model 20! \$325

*Individually wound by G. Bartolucci and Co. in Italy, these fine transformers feature double C-core construction as found on Tango and other premium iron. All configurable for 4/8/16 secondaries. Solid brass hookup terminals, potted in beautifully finished steel enclosures!*

**Bartolucci UNIVERSAL Double-C Core Output For SE/UL-PP/UL!!!** A unique 'breakthrough' product! Can be configured for 3K SE 300B or for 3K SE EL34 with 50% Ultralinear screen taps! Also works for push-pull 3.2K 48W UL! Just think of all the different circuits you can try with this transformer! PAIR \$300!

**Bartolucci Double-C Core Output Transformers For Push-Pull Amps** 4.3K, 60W, KT88/EL34 PP UL, \$135!

**Hammond Transformers In Stock!** 10H/125mA choke for tube amps, \$21  
1.5H/200mA choke for Dyna-junk, \$10  
2H/200mA choke for tube amps, \$19

*Hammond offers a vast range of good power, output, filament, choke, etc. iron. We deal the entire line. See our NEW on-line Catalog this Fall for a list of models and unbeatable discount prices!*

**Audio Note 99.99% Silver Wire** Wire priced per meter. .05mm (\$30), .2mm (\$40), .35mm (\$45), .6mm (\$55), .8mm (\$60), 1mm (\$70).

**Audio Note Silver Solder** 9 meter length, 1mm diam., \$30.  
One Kilo roll, 1mm diam., \$250.

*Acid/chloride free, as used on Ongaku!*

**Rare Books About Tube Electronics** RCA Radiotron Designer's Handbook 4th Edition, \$100-\$175. Audio Cyclopedy by Tremaine/SAMS, \$100. RCA Receiving Tube Manuals RC22, \$12. Fundamentals Of Vacuum Tubes by Eastman \$30. Our NEW on-line Catalog due fall '96 will feature hundreds of shockingly rare & cool old print items for students of tube audio electronics. <http://www.angela.com>

**Alps Black Beauty Potentiometers** Coveted 40mm stereo volume controls! 40mm wide, 34mm high, 30mm deep. Solid aluminum 6mm shaft, solder lugs. Excellent upgrade for high end audio gear or custom designs! E-Z retrofit available in dual/stereo 100K or dual/stereo 250K! SALE! USA FREAKOUT PRICE! \$23!!!!

**Icar (Italy) Paper In Oil Signal Caps** Special! .047/1.5KV (\$5), .1/1.5KV (\$6), .22/1.5KV (\$7), .33/1.5KV (\$8).

*Similar in sound and build to A.N. caps.*

**LCR Dual & Quad 500V Electrolytics!** 1-5/16" round can with solder lugs on bottom. With slight modification of the chassis these new UK made clamp mount caps will replace hard to find, expensive Mallory Twistlock types found in old Dyna, vintage guitar amps and other old gear!  
1. 40uF/20uF/20uF/500V, New! \$15  
2. 50uF/50uF/500V, for Marshall, \$6.90  
3. Chassis mount clamps for above, \$2

## Audio Note Paper In Oil Signal Caps

2.2/50V, \$19  
.1/200V, \$7  
.56/200V, \$8  
.001/400V Silver Leads, \$9  
.0028/400V Silver Leads, \$9  
.0082/400V Silver Leads, \$10  
.01/400V Silver Leads, \$10  
.015/400V, \$6  
.022/400V Silver Leads, \$10  
.047/400V Silver Leads, \$11  
.082/400V, \$8  
.12/400V, \$9  
.15/400V Silver Leads, \$12  
.18/400V Silver Leads, \$13  
.22/400V Silver Leads, \$13  
.33/400V, \$13  
1mF/400V Silver Leads, \$25  
1.4mF/400V, \$30  
.0018/630V, \$6  
.0004/630V, \$6  
.00082/630V, \$6  
.0015/630V, \$6  
.0047/630V, \$6  
.012/630V, \$8  
.015/630V, \$8  
.022/630V Silver Leads, \$12  
.033/630, \$7  
.039/630V, \$8  
.047/630V Silver Leads, \$14  
.056/630V, \$8  
.065/630V, \$8  
.072/630V, \$8  
.082/630V, \$9  
.1/630, \$12  
.15/630V Silver Leads, \$15  
.18/630V, \$10  
.22/630V, \$14  
.22/630V Silver Leads, \$18  
.27/630V, \$11  
.33/630V, \$13  
.36/630V, \$15  
.39/630V, \$16  
.47/630V Silver Leads, \$20  
.018/1000V, \$11  
.22/1000V, \$15  
.39/1000V, \$23  
.68/1000V, \$30  
1.2mF/1000V, \$35  
22/1600V, \$20  
22/2000V, \$25

*Axial leads, considered by many triode hobbyists to offer sound quality superior to ANY other oil or plastic cap available today. Try 'em as an upgrade in your rig!*

**Audio Note Paper In Oil Copper Foil Axial Lead Signal Capacitors**  
.001/630V Silver Leads, \$21  
.0028/630V Silver Leads, \$21  
.0082/630V Silver Leads, \$22  
.01/630V Silver Leads, \$23  
.022/630V Silver Leads, \$26  
.047/630V Silver Leads, \$30  
.1/630V Silver Leads, \$32  
.15/630V Silver Leads, \$33  
.22/630V Silver Leads, \$40  
.33/630V Silver Leads, \$46  
.47/630V Silver Leads, \$55  
1mF/630V Silver Leads, \$85

*The best signal capacitor ever made? Oxygen free copper foil construction.*

**Audio Note Paper In Oil Silver Foil Axial Lead Signal Capacitors**  
.047/630V Silver Leads, \$70  
.1/630V Silver Leads, \$130  
.15/630V Silver Leads, \$170  
.22/630V Silver Leads, \$225  
.47/630V Silver Leads, \$325  
1mF/630V Silver Leads, \$850

**Angela Oil/Polypropylene Capacitors For Tube Amplifier Power Supplies** 15MFD/600VDC, 1.75" diam., \$12  
30MFD/515VDC, 1.75" diam., \$15  
50MFD/515VDC, 2.50" diam., \$18

*Clamps for above (specify size) \$2 each.*

**More Good Caps For Tube Amps!** Sprague axial lead ATOM electrolytics for tube guitar and hi-fi amps! Solen "FAST CAP" 630V metallized polyprop. film caps for replacing cheap electrolytics in tube power supplies, bypass, signal and in speaker crossovers! SBE (Sprague) film and foil 715P/716P polyprop. signal caps. See our NEW on-line Catalog for prices.

**Black Gate Premium Electrolytic Caps** 1. 100+100/500V, 1.13125" diam., clamp mount, solder lugs, WKZ type, \$125  
2. 100/500V, 1.13125", WKZ, \$90  
3. 47+47/500V, 1.13125", WKZ, \$95  
4. 100/100V radial bias cap, \$12  
5. 220/100V cathode bypass cap, \$18

**Elna Cerafine Electrolytic Caps** 47/500V (\$16), 47+47/500V (\$18), 100/500V (\$22), 100+100/500V (\$30), 220/500V (\$33), 220+220/500V (\$53), 330/500V (\$45). Mount clamp included! Excellent power supply upgrade!

## Audio Note Ceramic Tube Sockets

1. Octal ceramic/silver, chassis mount from below to 1.125" hole as found on old Dyna and most vintage gear, \$5.50  
2. Octal ceramic/gold, 1.125", \$7  
3. 9 pin ceramic/silver, chassis mount from above to 1" hole, for 12AX7, \$5.75  
4. 9 pin ceramic/gold chassis mount from above to 1" hole, \$6  
5. 9 pin ceramic/silver, chassis mount from below to 1" hole, \$5.75  
6. 9 pin ceramic/gold, chassis mount from below to 1" hole, \$6  
7. 9 pin ceramic/silver PC mount, \$5  
8. 9 pin ceramic/gold PC mount, \$5  
9. 7 pin chassis mount above silver, \$5  
10. 7 pin chassis mount above gold, \$6  
11. 7 pin chassis mount below silver, \$5  
12. 7 pin chassis mount below gold, \$6  
13. 7 pin PC mount ceramic/silver, \$5  
14. 7 pin PC mount ceramic/gold, \$6.50  
15. Ux4 for 300B/2A3, ceramic/silver, mount from below to 1.1875" hole in chassis, \$8.50  
16. Ux4 ceramic/gold, 1.1875", \$8.50  
17. Johnson '224' style wafer socket for 300B/2A3 etc., ceramic silver, \$22  
18. Ux5 five pin socket for 807 etc., ceramic/gold, mounts from below chassis to 1.1875" hole, \$8

*A.N. sockets are the very best you can buy. As used in Ongaku, etc. Finest white ceramic and special alloy GOLD or SILVER plated metal contacts. Essential for serious D.I.Y. projects or for upgrades to vintage and modern gear.*

**Riken Ohm Carbon Film Resistors** .5 watters avail. in the following values: 10, 12, 16, 22, 27, 33, 39, 47, 56, 68, 82, 91, 100, 120, 150, 180, 220, 270, 330, 390, 470, 560, 604, 680, 820, 910, 1K, 1.1K, 1.24K, 1.33K, 1.5K, 2.2K, 2.7K, 3.3K, 3.9K, 4.7K, 5.6K, 6.8K, 8.2K, 9.1K, 10K, 12K, 15K, 18K, 22K, 27K, 33K, 39K, 47K, 56K, 62K, 68K, 75K, 82K, 91K, 100K, 120K, 150K, 178K, 180K, 182K, 220K, 249K, 270K, 330K, 390K, 470K, 510K, 560K, 620K, 680K, 820K, 1MEG. EACH \$1.50

1 watters avail. the following values: 47, 68, 91, 100, 150, 220, 330, 390, 470, 560, 680, 820, 1K, 1.24K, 1.33K, 1.5K, 2.2K, 2.7K, 3.3K, 3.9K, 4.7K, 5.6K, 6.8K, 8.2K, 9.1K, 10K, 12K, 15K, 18K, 22K, 27K, 33K, 39K, 47K, 56K, 62K, 68K, 75K, 82K, 91K, 100K, 120K, 150K, 178K, 182K, 220K, 249K, 270K, 330K, 390K, 470K, 510K, 560K, 620K, 680K, 820K, 1MEG. EACH \$2.50

*Riken Ohm feature gold plated copper leads, 1% tolerance. These Japanese audiophile resistors are considered by some to be the best for classic tube audio circuits like Marantz Model 2, Mullard 520, Acro, original Williamson, vintage guitar amp designs, too! We proudly introduce them to the American market. If you've never heard how good premium carbon resistors can sound, you're in for a very pleasant surprise!*

**Shinko Tantalum Film .5W Resistors** Available in the following values: 10, 12, 15, 22, 27, 33, 47, 56, 68, 82, 100, 120, 150, 220, 270, 330, 390, 470, 560, 600, 620, 680, 820, 1K, 1.1K, 1.2K, 1.5K, 1.8K, 2K, 2.2K, 2.7K, 3.9K, 4.7K, 5.6K, 6.8K, 8.2K, 10K, 12K, 15K, 22K, 27K, 33K, 39K, 47K, 56K, 62K, 68K, 75K, 82K, 91K, 100K, 120K, 150K, 220K, 250K, 270K, 330K, 390K, 470K, 510K, 560K, 620K, 680K, 820K, 1Meg. Each \$5

*As used in Ongaku and other A.N. gear.*

**Audio Note Tantalum Film 1W Resistors** 15, 47, 91, 100, 150, 220, 330, 470, 600, 680, 890, 910, 1K, 1.24K, 1.33K, 1.5K, 2.2K, 2.7K, 3.3K, 3.9K, 4.7K, 5.6K, 6.8K, 8.2K, 9.1K, 10K, 12K, 15K, 18K, 22K, 27K, 33K, 39K, 47K, 56K, 62K, 68K, 75K, 82K, 91K, 100K, 120K, 150K, 178K, 182K, 220K, 270K, 470K, 620K, 1Meg., \$1, \$7

*Considered by many to be the BEST resistors ever made for audio circuits.*

**TONS of Great N.O.S. Tubes In Stock! Tested and Guaranteed!** We now have one of the world's largest inventories of fine NEW OLD STOCK tubes, including many rare gems from Amperex, RCA, Philips, Mullard and other esteemed makers. Check out our new on-line Catalog this Fall for current stock and pricing (<http://www.angela.com>)!

**Ordering Info:** VISA/MC/AMEX OK for phone/fax/e-mail orders or prepay with cert. funds. Most goods shipped on 7 day approval! We ship *WORLDWIDE* every business day. Prices and availability subject to change. Check our NEW on-line Catalog (<http://www.angela.com>) this Fall for current stock and pricing. Now celebrating our 20th year! Thanks! *STEVE*

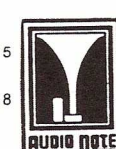
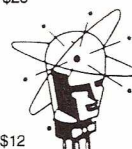

ANGELA INSTRUMENTS 10830 GUILFORD ROAD, SUITE 309, ANNAPOLIS JUNCTION, MARYLAND USA 20701 PHONE (301) 725-0451 FAX (301) 725-8823 E-MAIL [steve@angela.com](mailto:steve@angela.com)

*"Now, **that's** how my audio tube needs should be handled."*



Thousands of Tube Types from the Industry's Leading Manufacturers: Amperex, Cetron, GE, Western Electric, National, Philips and Raytheon.

**Available Fall '96!**

**Amperex**

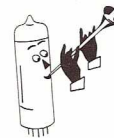

**Amperex Bugle Boy  
Premium Audio Tubes**

When you deal with a source dedicated to serving your needs for premium quality audio tubes, you'll find yourself repeating these words time and again.

The Audio Product Division of Richardson Electronics offers you specialty sales and applications engineering support to ensure that your requirements are handled properly. One of the world's largest inventories of receiving tubes for the audiophile and an ISO 9002 Registered distribution network provide further proof of our commitment to serving your needs better than any other source.

So if you haven't dealt with a source capable of meeting your demands, call us at **1-800-TUBE USA** and we'll help put the words in your mouth --

*"Now, **that's** how my audio tube needs should be handled."*

**TUBES\***

6AU6WC-JAN	\$ 6.80	6L6WGB-JAN	\$ 20.00	811A	\$ 35.75
6B4G	\$ 54.50	6SL7WGT-JAN	\$ 11.90	6005W-JAN	\$ 9.20
6C4WA-JAN	\$ 9.00	12AT7WC-JAN	\$ 12.00	6189W-JAN	\$ 14.40
6CA7/EL34	\$ 12.90	12AX7WA-JAN	\$ 8.00	6550/6550A-USA	\$ 49.00
6CG7/6FQ7	\$ 15.60	12BH7A	\$ 15.00	E34L	\$ 12.90
6L6GC	\$ 12.90	300B-USA	\$ 261.00	KT88-USA	\$ 135.00

\*Price and availability subject to change without notice. All prices US dollars, FOB LaFox, Ill. USA.

***In addition to the tubes listed above we also carry a wide variety of other popular tube types and sockets. Call us with your requirements!***

Call **1-800-TUBE USA** (1-800-882-3872) today and request our full linecard or call **630-208-2200** for information on additional products and the worldwide locations nearest to you.

**APD** Audio Product Division

40W267 Keslinger Road  
P.O. Box 393  
LaFox, IL 60147-0393  
(630) 208-2200

# Magic To Your Ears



8200 South Memorial Parkway • Huntsville, AL 35802 • Phone (205) 882-1344 • Fax (205) 880-8077

<http://www.svetlana.com>

# WE HAVE ENOUGH COMPONENTS TO BUILD A SMALL CITY

## TUBES:

Over 3500 audio, receiving, transmitting and industrial types in stock, including many foreign and early types. We offer the complete line of Svetlana audio, amateur radio and industrial power tubes.

## TRANSFORMERS:

Hard to find power, filament and output transformers as well as filter chokes for tube equipment. We feature HAMMOND, One Electron, MagneTek and Thordarson as well as many new old stock transformers.

## CAPACITORS:

High voltage electrolytic and mylar capacitors, multi-section capacitors and more for tube circuits.

## PARTS:

Resistors, tube sockets, potentiometers chassis boxes and aluminum enclosures, knobs, dial belt, lamps, diodes, speakers, wire, phonograph needles and cartridges and much more.

## LITERATURE:

Extensive selection of literature and books and tubes, hi-fi equipment, circuits diagrams, communication gear and antique radios. Some items not available elsewhere!

## SUPPLIES:

Grill cloth, cabinet restoration supplies, batteries, chemicals, tools, test meters, gifts and kits.

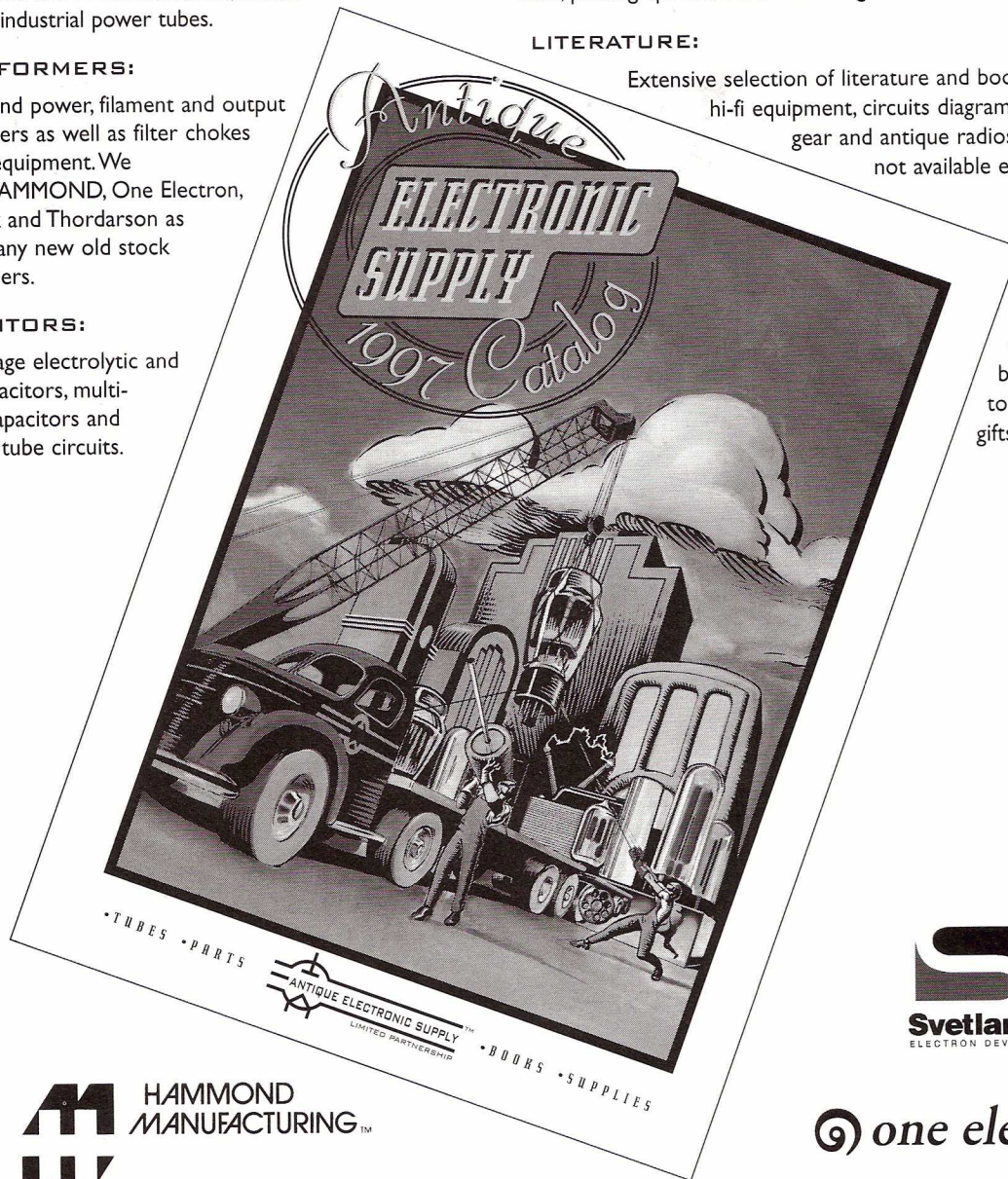

HAMMOND  
MANUFACTURING™



one electron™

CALL OR FAX FOR OUR FREE 40 PAGE CATALOG

ANTIQUE ELECTRONIC SUPPLY™

Limited Partnership

6221 S. MAPLE AVE. • TEMPE, AZ 85283 USA  
(602) 820-5411 • FAX (602) 820-4643