

VACUUM TUBE VALLEY™

Issue 6
Winter 1997

Celebrating the History and Quality of Vacuum Tube Technology

Published Quarterly
Price \$8.00

Special Issue:

*A Tribute to Avery Fisher
and The Fisher Line of
Tube Receivers*

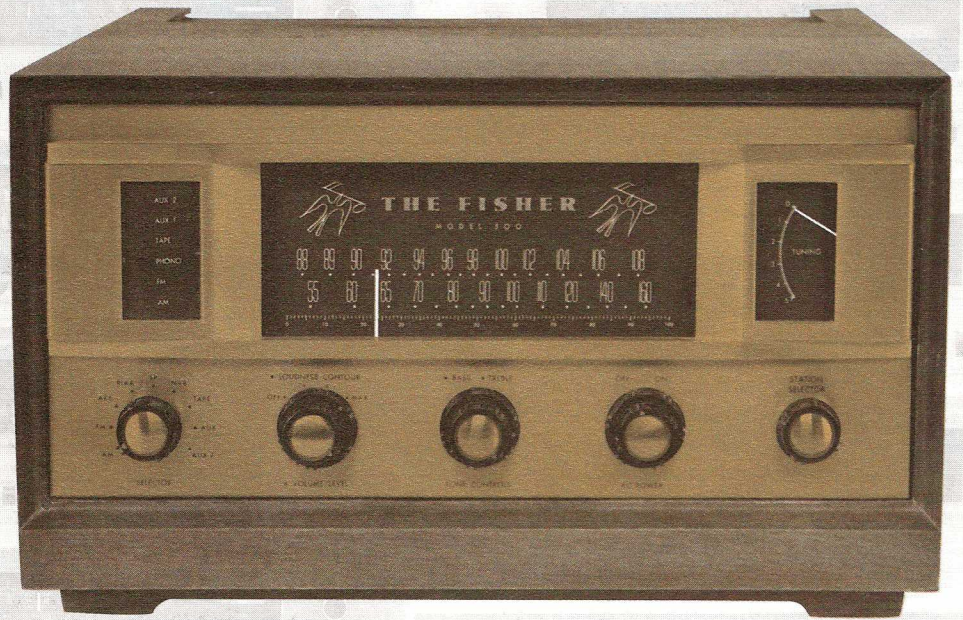

THE FISHER 500

In This Issue

Fisher 500 Family of Receivers

Design, History and Restoration

6550 and KT88 - The Power Kings

Comparisons Between New and NOS Types

■ Editor's Page / Tube Industry News	2
■ Fisher 500 - The Start of a Generation	3
■ A Tribute to Avery Fisher	10
■ Book Review - "Tube Lore"	12
■ The Randall Amplifier Project	14
■ Story of the Loftin - White Amplifier	17
■ The Power Kings - 6550 and KT88	21
■ The Audio Test Bench - Oscilloscopes	25
■ Uncle Eric's Dumpster - Type 5687	31



*On-line tube audio buy/sell want ads, library of
articles, links to other tube web sites and more.*

www.vacuumtube.com

Editor's Page and Industry News

by **Charlie Kittleson, Editor**

Due to Eric Barbour's recent employment with Svetlana Electronic Devices, I have taken over the Tube Industry News column and combined it with the Editor's Page.

VTV in the News, Again!!!

Recently, the offices of VTV were visited by editors from the famous Japanese audio magazine, Audio Technology MJ. Makoto Wantanabe, MJ Editor and Hishashi Ohtsuka, Tech. Editor spent two days with us. They got a chance to see our operations, tour the electronics surplus stores in Silicon Valley and visit local tube audiophiles and vintage audio collectors. The result is an impressive eight page article on VTV and Co in the January 1997 issue of MJ.

New Distributor for Triodes

Welborne Labs is the new distributor for KR Enterprise Vacuum Valve (formerly Vaic Valve Co.) products. The products available include the VV300B, a direct replacement for the Western Electric 300B tube featuring improved linearity and increased power capability. Also available are the VV300B, and VV52B, plus blue glass versions of the VV30B (VV32B) and VV300B (VV302B). Matched pairs may be purchased directly from Welborne Labs. Quantity discounts are available to OEMs and dealers. For more information, contact:

Ron Welborne, Welborne Labs
PO Box 260198
Littleton, CO 80126 USA
phone (303) 470-6585
fax (303) 791-5783
email wlabs@ix.netcom.com

Northstar Leading The Way, Inc. will be distributing the KR Enterprises vacuum tube preamplifiers, integrated amps and power amplifiers. For more information on these products contact:

Frank Garbie
Northstar Leading The Way Inc.
PO. Box 3763, Durango, CO 81302 USA
phone (970) 259-6722
fax (970) 259-6727

Svetlana Announces New Products

Svetlana Electron Devices has introduced its SV572 series of 125-watt power triodes for high-end audio amps. This series is available with mu of 3, 10, 30 and 160 for a variety of SE or push-pull applications. Svetlana also introduces its new SV6L6GC, a close copy of the classic Sylvania 6L6GC/STR387 with ruggedness and low distortion, suitable for use in guitar amps or high fidelity equipment. For more information, contact:

Svetlana Electron Devices
8200 S. Memorial Parkway
Huntsville, AL 35802
phone (800) 239-6900
phone (205) 882-1344
fax (205) 880-8077

Audio Note and Alesa Vaic Join Forces

An agreement has been made between Audio Note UK Ltd. and Mr. Alesa Vaic (formerly of Vaic Valve) to set up a manufacturing and distribution agreement. Mr. Vaic, in conjunction with the Audio Note design team, will develop, design and manufacture a range of AV high-gain small-signal directly heated triodes, together with a small range of AV Super Linear® driver and medium-to-high-power, directly heated triodes, which Audio Note UK Ltd. will finance and exclusively distribute under the brand name Audio Note worldwide. As of this date, Alesa Vaic's association with Vaic Valve has been completely severed.

Production will start on a version of the 300B, dubbed the AV300B SL. It will be available from late December 1996 in limited quantities of numbered units, and carrying a 12 month or 2000 hour "absolutely undisputed" warranty, where faulty samples will be exchanged without argument or delay. The worldwide retail price of the AV300B SL is US \$425.00, not including local taxes. Six months after the launch of the AV300B SL, Audio Note intends to introduce a 120-watt-dissipation triode, dubbed the AV62B SL. Estimated retail price is US\$750 each. All Audio Note triodes will be in clear glass, but can also be had in cobalt-blue or ruby-red glass at an additional cost of US\$75 each. It is planned to also offer replacement versions of the previous Vaic Valve triodes, with revised cathode materials to prevent filament breakage, which was a problem with early VV30Bs. The AV32B SL will be

US\$550 and the AV52B SL will be US \$750 each. For more information contact:

Peter Qvortrup
Audio Note UK Ltd.
Unit C, Peacock Ind. Estate
Lyon Close
125-127 Davigdor Road
Hove, East Sussex
BN3 1SG UK
phone (44) 1273-220511
fax (44) 1273-731498

Groove Tube and Fritztronics Announce US Tube Production

A co-operative agreement has been entered into by Groove Tubes of Sylmar, CA and Fritztronics of Randolph, MA. The latter company, headed by Mr. S. F. Johnson, will manufacture glass vacuum tubes in its facility in Milford, MA. The first product scheduled for release is a replica of the RCA 6L6GC from 1956, to be marketed by Groove Tubes and called GT-6L6FZ. Groove Tubes claims that all materials and specifications will be the same as the original tube, including "Carbonized Grade A Nickel plates, pure Tungsten grids, premium A-31 Catholy Cathodes etc...all from the original American vendors!" Release date is mid-1997, and price is to be announced.

Quoting from the press release: "The Fritztronics Milford factory has been established inside of the historic Beam Power Tube building (sic) that once produced vacuum tubes for the US government and tube companies such as Hytron, Raytheon and RCA. The facility contains the original RCA production machines from the RCA Harrison, New Jersey plant in pristine restored operating condition. Mr. Johnson has also developed new and innovative non-toxic processes for environmentally friendly tube manufacturing (sic), an important goal for both Groove Tubes and Fritztronics. For more information, contact:

Mr. Aspen Pittman
Groove Tubes Co.
12866 Foothill Boulevard,
Sylmar, CA 91342
phone (818) 361-4500
fax (818) 365-9884

In Memory of Saul Marantz, Audio Pioneer who passed away January 16, 1997

EDITORIAL STAFF

- Charles Kittleson** - Editor and Publisher
- John Atwood** - Technical Editor
- Eric Barbour** - Staff Editor
- Terry Buddingh** - Guitar Editor
- Steve Parr** - Art Director
- Julie P. Werner** - Copy Editor

Vacuum Tube Valley is published quarterly for electronic enthusiasts interested in the colorful past, present and future of vacuum tube electronics.

Subscription is US\$32.00/year (4 issues) \$40/Canada and \$45/Asia and Europe
CASH, US BANK CHECK, CREDIT CARDS
To subscribe, renew or change address call or FAX us at **(408) 733-6146**.

Copyright 1996 **Vacuum Tube Valley™** and **Big Tone™** All rights reserved.

No part of this publication may be reprinted or otherwise reproduced without written permission of the publisher.

Send circulation and editorial correspondence to:

Vacuum Tube Valley
1095 E. Duane Ave., Suite 106
Sunnyvale, CA 94086 USA
e-mail triode@vacuumtube.com

The Fisher 500 Family of Receivers - The Start of a Generation

By Charles Kittleson

The Beginnings of the Fisher 500

In the fifties, the hi fi hobby was considered an expensive proposition. A 1957 home hi fi set with all the bells and whistles could set you back \$1000 or more in 1950s dollars! Most of the US population (95%+) did not have that kind of money to throw around. They were busy rearing the millions of Baby Boomers populating the countryside. For most folks, a phonograph or a combination radio, phono, TV console provided the home entertainment. Component hi fi was for rich bachelors, doctors and engineers who had the spare change and time to hook up all the cables and fine-tune the set-up.

Avery Fisher, who got his start in the late 1930s by manufacturing high-quality radio and phonograph sets, was just getting his stride in 1956 with a very comprehensive line of amplifiers, preamplifiers, tuners, integrated amplifiers and package hi fi consoles. Fisher components were considered by musicians and engineers alike to be the finest available in their respective categories. Fisher, as well as other audio manufacturers of the time, used symphony musicians to audition and critique their new products. The goal was to achieve the most life-like and natural reproduction by using the ears of actual professional musicians. Since the early beginnings of Fisher, many of the worlds most prominent and powerful people, including US presidents and foreign heads-of-state, owned Fisher gear. Fisher truly was the standard all others had to measure up to.

What was missing from the Fisher lineup was a complete am/fm tuner amplifier in one compact package. Other manufacturers, including Harman-Kardon and Stromberg-Carlson had introduced hi fi receivers in 1954, but they didn't have the Fisher attention to detail and that famous luxurious Fisher sound.

In late 1956, The Fisher TA500 (\$249.50) receiver was introduced. It was "everything you need-on one superb chassis." The TA500 featured an extremely sensitive FM-AM tuner, a powerful 30-watt amplifier, and an audio control center- all built on one compact chassis! All

you had to do was to add a record player and a loud-speaker and you had a complete high-fidelity system for your home. The 500 was a Fisher in every sense of the word, meaning excellent design, build-quality and performance. Its styling was spectacular with a die-cast brushed-brass faceplate and escutcheon with tuning meter and function lights.

The 14 tube circuit featured dual rectifiers with a 6X4 for the tuner section and a 5V4G for the 30 watt output stage, featuring the excellent Mullard EL37 output tetrodes. Later TA500s used 5881s. Original specifications touted uniform response from 16 to 32,000 cycles. Audio controls included a volume control, continuously variable bass and treble, a four-position loudness contour control and function selector. There was a tape recorder output and playback preamp-equalizer, four inputs, output impedances of 4, 8 and 16 ohms. The 500 is a mono receiver, but still featured a multiplex detector-out RCA jack for use with stereo adapters which became available with standardization of the FM stereo broadcasting system in 1961. The FM section featured three IF stages and two limiters.

For a mono receiver, the 500 has no equal. I personally own one that has been my bedroom radio for years. I completely restored it with new electrolytic capacitors, new signal and bypass capacitors, new tubes and an alignment job. The AM performance is incredible because the 500 is very sensitive (3 microvolts) and has excellent signal-to-noise ratio. FM performance is equally impressive and very musical with a 1 microvolt sensitivity rating. The TA500 is probably the ultimate tube hi fi table radio. The TA500 was made from 1956 through 1958 and is not commonly seen anymore. Production figures are not known, but at least 30,000 TA500s were probably made.

The Beginnings of Stereo

With the advent of stereo LP records in 1957 and 1958, almost all manufac-

EVERYTHING YOU NEED — ON ONE SUPERB CHASSIS!

THE FISHER "500"



An extreme-sensitivity FM-AM tuner, a powerful 30-watt amplifier, and an audio control center — all built on one compact chassis! Simply add a record player and loudspeaker, and as easily as that you have a complete high fidelity system for your home. Its quality — in the finest FISHER tradition. Its appearance — the timeless beauty of classic simplicity.

SPECIFICATIONS

• Full wide-band FM detector. • Powerful 30-watt amplifier; handles 60-watt peaks. • Meter for micro-accurate tuning; pin-point channel indicator lights. • Tape recorder output and playback preamp-equalizer. • Uniform response, 16 to 32,000 cycles. • 4 inputs. • Output impedances: 4, 8 and 16 ohms. • 14 tubes plus 2 crystal diodes. • Beautiful die-cast brushed-brass panel. • Size: 13 1/2" wide x 13 1/2" deep x 6 1/2" high. WEIGHT: 26 pounds.

FM-AM TUNER PLUS MASTER AUDIO CONTROL PLUS AMPLIFIER

turers introduced stereo components with two complete amplifiers on one chassis. Harman-Kardon, Pilot, H.H. Scott and many others also introduced stereo FM/AM receivers. The catch is, they weren't really FM stereo multiplex units because that system wasn't developed yet. For a short time in the mid to late 1950s, however, there was a system of broadcasting stereo with one channel on AM and the other on FM. It was available in limited areas and was troublesome. Most tuners and receivers of the time had an external multiplex adapter jack on the chassis for the future date when the FCC would standardize stereo FM or for use with SCA multiplex adapters.

All the rage in the late 1950s, stereo LPs needed two amplifiers to get the stereo effect. A large number of audiophiles rebelled against the stereo system. They claimed that it was a conspiracy between the record companies and the hi fi manufacturers who could now sell a listener two amps and two speakers instead of one each. Hi fi manufacturers decided to appease the mono perfectionists with high power amps including the Fisher 200, and elaborate mono preamps such as the Fisher 90C. Their thinking was that most consumers would opt for an all-in-one hi fi receiver because the mess of wires and complexity from separate components was a nightmare for all but the most possessed audio bugs.

Early Fisher Stereo Receivers: TA600 and 500S

In late 1958, Fisher introduced the TA600 FM/AM receiver (\$349.50). It was the hit of the San Francisco and Los Angeles Hi-Fi shows. The TA600 was the first complete stereo FM/AM receiver, with two 20 watt amplifiers with a frequency response of 25 to 20,000 cycles + or-1 db. It had separate tuning indicators

and front-ends for both AM and FM. The 600 had a total of 22 tubes and a selenium rectifier for DC on the preamplifier filaments. It used the newly introduced 7189 output tubes in push-pull configuration. The 600 is the only Fisher stereo receiver with tube rectification, a 6X4 for the tuner and 5AR4 for the amplifier sections. There were dual eye tubes for indicating signal strength and center-of-channel for both am and fm.

The 500S FM/AM receiver (\$324.50) replaced the TA600 and was only made in 1960 and 1961. It was very similar to the TA600 except that it used solid-state diode rectification instead of tubes. The FM tuner sensitivity was improved to 0.9 microvolt for 20 db s/n ratio with a 72 ohm antenna. The FM front end featured three IF stages and two limiters. The stereo master audio control had twenty controls and switches. There were nineteen tubes including two signal indicator tubes, three diodes and two silicon rectifiers. The output stage was rated at 22.5 watts music power and used push-pull 7189s.

500S receivers are relatively scarce and were not even listed in Allied Radio or Lafayette catalogs of the era. They are similar in appearance to the TA600, but the faceplate and controls are slightly different.

500B and 500C

With the introduction of FM stereo-multiplex broadcasting in 1961, the audio world was ripe for an all-in-one FM stereo receiver. Fisher, for their 1962 line, introduced the first of the higher powered 500s, the 500B (\$364.50). Peak music power using push-pull 7591s was 65 watts (32.5 Wpc). The output tubes were mounted in front of the output transformers on the 500B. The output transformers on the 500B and most other Fisher integrated amplifiers and receivers were made by Todd Electric, Bronx, New York.

The 500B was the first 500 with a built-in multiplex adapter for full FM stereo reception. Styling was modernized with the attractive golden-champagne anodized extruded aluminum faceplate and the gold medallion knobs. Being an FM only unit, the 500B featured a single eye tube indicator, Golden Cascode front-end and four IF stages. There was also a sub-channel multiplex filter to eliminate background hiss and noise on distant FM stereo stations. The rated IHF sensitivity was .9 microvolts, separation of 35 db, overall frequency response was 25 to 25,000 cycles with harmonic



TA500

distortion of .5% and hum and noise at -85 dB. The Power supply was silicon rectifier with DC on the low-level audio stage filaments.

In 1963, after spending millions of dollars and eight years of research on

From serial numbers 20,000 and on, the 500C was the first stereo receiver to use the newly developed 6CW4 Nuvistor Golden-Syncrode front end which afforded higher sensitivity, a wider overload margin and better noise rejection. The low-noise 6CW4 Nuvistor triodes, used

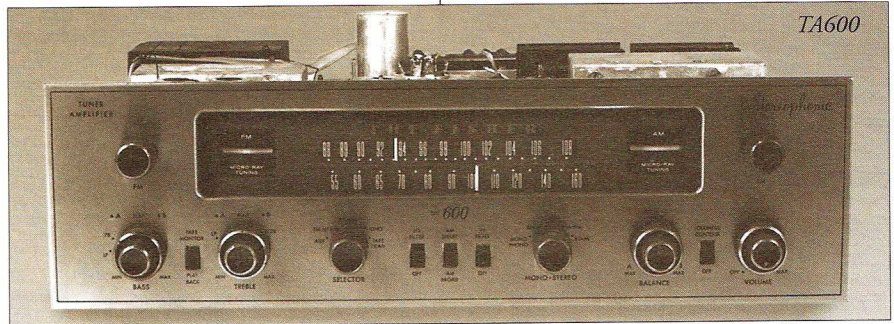

TA600

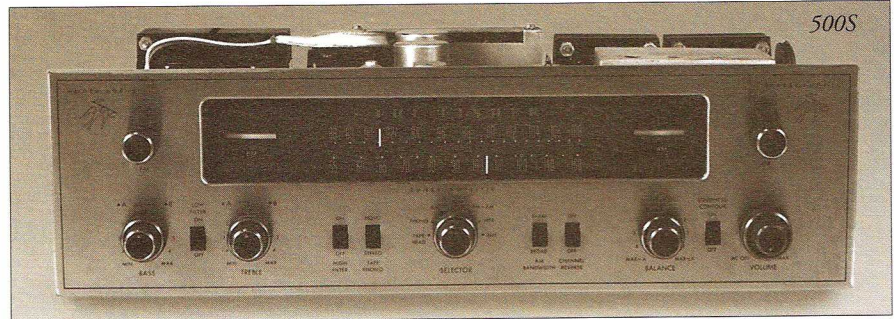

500S

receiver development, using the best audio engineers available, the culmination of Fisher FM stereo receivers, the 500C (\$389.50) was unveiled. 500C receivers with serial numbers from 10,000 to 20,000 used the 500B Golden Cascode FM front-end with a EC97 (6GK5) as the RF amp and a ECC85 (6AQ8) as the oscillator/mixer. Gone was the eye tube indicator, replaced by a tuning meter and a stereo beacon light.

for both mixer and oscillator stages, provided a much higher degree of stability, mechanical noise isolation and a better signal to noise ratio. The FM signal was amplified by four wide-band IF stages and converted to an audio signal by a wide-band one-megacycle ratio detector using two balanced germanium diodes. The detected audio signal was then fed to the famous Fisher Stereo Beacon, where the receiver sensed whether the signal was mono or stereo.

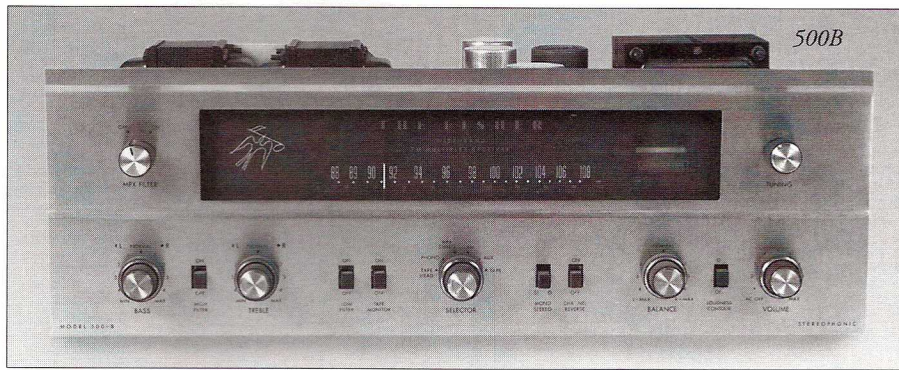

the golden color of the 500B faceplate. The output and power transformers on the 500C are noticeably beefier than those found on the 500B.

The Fisher 800 Series

The Fisher 800 (\$429.50) was introduced shortly after the TA600 in late 1959. It was another FM/AM unit with 1 microvolt of FM sensitivity for 20 dB of quieting. It also featured the exclusive Golden Cascade front-end identical to the type used on high-end Fisher tuners. AM sensitivity was 10 microvolts with three-way switchable bandwidth.

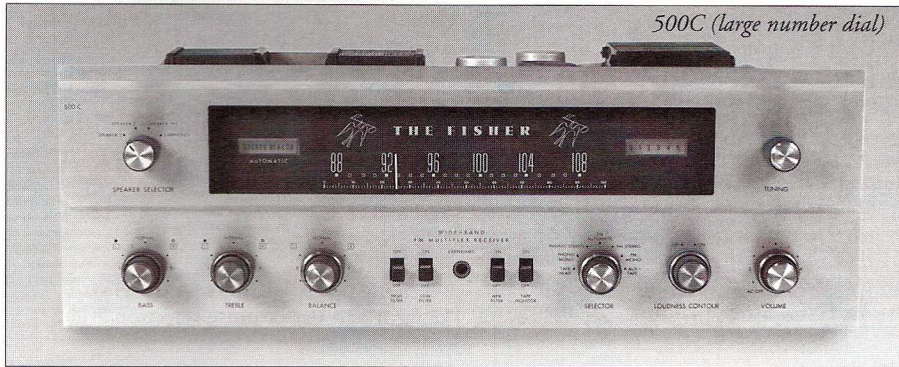

The 800 was claimed to be the most powerful stereo receiver of the day. It was the first stereo receiver to use the newly introduced 7591 output beam tetrodes designed by Westinghouse. Power rating was 80 watts peak music power and 60 watts RMS (30 Wpc) with a frequency response of 19 to 32,000 cycles. There were 20 tubes, two silicon diodes for the solid-state power supply and a bridge rectifier for DC on the preamplifier filaments. The 800 featured 24 knobs and switches for complete stereo master control. By the way, the early 500S, 600 and 800 knobs are one-piece and do not have the annoying brass medallions that pop off when the glue dries out.



The 800 had a variety of faceplate variations; solid architectural-brass framed face, the solid brass non-framed face and the thin stamped brass faceplate. There were minor circuit differences as well, performance gradually improved. The 800 was made from 1959 to late 1961 when it was replaced by the 800B.

The stereo beacon used an electronic switch to eliminate pops from a relay when switching to multiplex converter. The stereo multiplex on board was a time-division type and consisted of two balanced four-diode bridges and a 38 kc synchronous oscillator, which acted as an electronic switch. Some Fisher enthusiasts prefer the sound of the 500B to the 500C because of the non-Nuvisitor front end. Their opinion is that the Nuvisitor circuit is less open sounding.

The 500C is the most popular of the Fisher receivers. Although the Fisher serial number system is somewhat confusing, it is estimated that at least one hundred thousand 500Cs were produced. Serial numbers range from 10,000 to 70,000. Serial numbers also have a letter following them ranging from A to S. For example: 34897C or 58219S. More

research needs to be done before any accurate production figures on popular Fisher receivers can be determined.

A 500C is equipped with an incredible array of audio controls including: dual bass and treble, balance, high filter, low filter, MPX filter, tape monitor, speaker selector, function/mode selector, loudness contour and volume control. The audio line and phono sections of the 500C used Telefunken 12AX7 smooth plate tubes which were and are the best 12AX7s ever made. A four-position speaker switch was added to permit the use of remote speaker systems. There were also jack facilities to use the Fisher Spacepander K-10 reverb system. The output transformers were of the highest quality with grain-oriented and laminated steel cores. The faceplates on 500Cs are a lighter shade of champagne compared to

In 1961, touted as the very first full multiplex stereo fm receiver, the 800B (\$434.50) was a beautiful instrument and an outstanding performer. Styling changed dramatically with a new, champagne colored anodized aluminum faceplate, new dial glass, brass medallion knobs and chassis layout. The first 10,000 800Bs were made with the 7591 output tubes mounted in front of the output transformers. After that, the output tubes were mounted in their usual position, behind the transformers. The 65 watt output section was similar to the 500B.

The first 800Bs had three IF stages for the FM section. Sensitivity was improved to .9 microvolts for 20 dB of quieting on the FM band and 5 microvolts on the AM band. The AM section also featured variable bandwidth. Like the 800, the 800B featured separate tuner front-ends for the AM and FM bands. The 800B

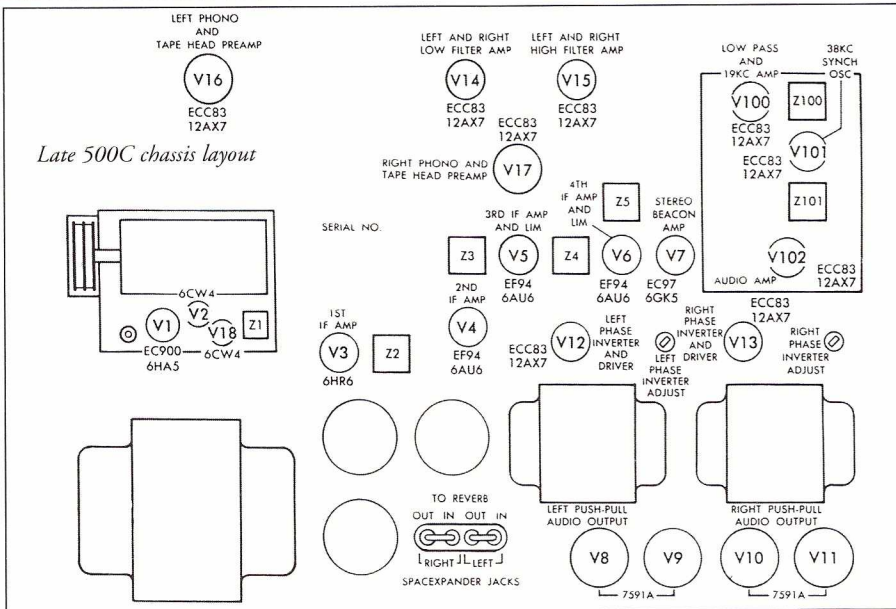

500C FM tuner specifications

- Usable Sensitivity - .9 microvolts
- Signal to Noise ratio - 70 dB
- Selectivity - 60 dB
- IF rejection at 100 mc - 90 dB
- Image Rejection at 100 Mc - 65 dB
- FM Harmonic Distortion - .5%
- FM Stereo Separation - 35 dB
- Capture Ratio - 2.5 dB
- Drift - 0.01%.

500C Amplifier Specifications

- IHF Music Power - 75 watts
- RMS Power 66 watts (33 wpc)
- Harmonic Distortion -.7% at 1000 cycles
- Intermodulation distortion -.7% at 30 watts
- Frequency response -5 to 45,000 cycles +0 and -2 dB.
- Hum and noise - 80 dB below rated output
- Channel separation - 50 dB
- Total variation of bass and treble controls -23 dB.
- Power Consumption at 1/3 power - 205 Watts

combines the best of all worlds and is a highly sought-after collector item. According to Al Pugliese, noted Fisher expert from Staten Island, New York, the 800B it is the most valuable of the Fisher multiplex receivers.

1964 and the last all-tube receiver listed in the 1968 Fisher catalog. The 400 was basically an economy version of the

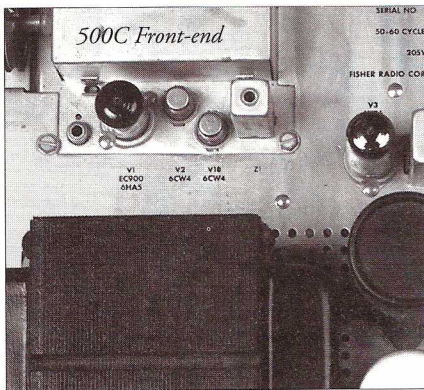

The culmination of the dual-band stereo receivers was the 800C (\$449.50), introduced in 1964. The 800C did not use Nuvistors (like the 500C) in the front-end and the am and fm tuner sections were combined to one tuning capacitor. Now there was only one tuning knob for both bands and a different tuning dial glass. Gone were the dual-eye tube tuning indicators which were replaced by a single tuning meter and the stereo beacon light. The faceplate was a lighter shade of champagne. Power and output transformers were noticeably beefier in both the 500C and 800C.

The 400 Receiver

Last of the Fisher tube receiver designs was the 400 (\$329.50), introduced in

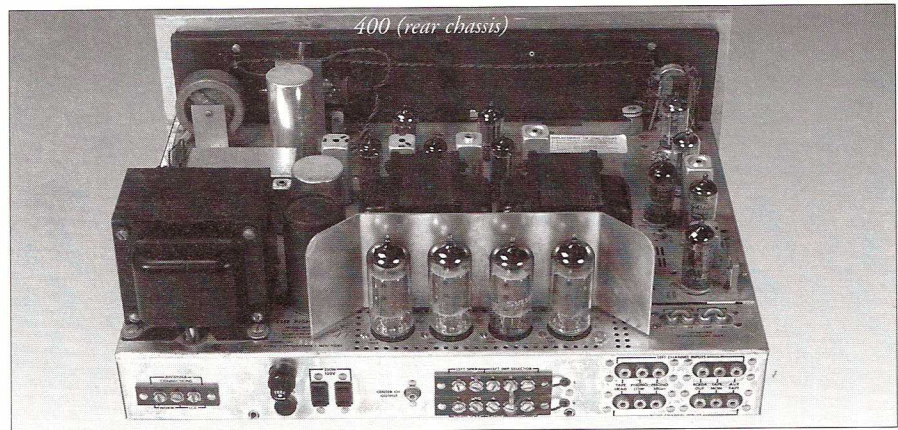
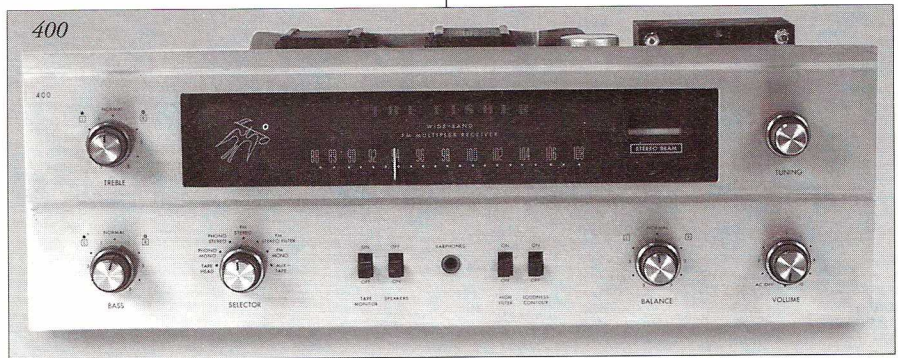

500C. Audio controls on the 400 included: bass and treble, balance, loudness compensation, high filter, speaker switch, tape monitor and volume. There was a headphone jack on the front panel. A major departure in the output stage, the

400 used the new RCA 7868 Novar type output tubes in push-pull for a 65 watt music rating. The first 400s used three IF stages and later versions used four IF stages. The FM front-end was the Golden Syncrode, Nuvistor front-end.

THE FISHER 500-C

SCHEMATIC DIAGRAM • MULTIPLEX SECTION

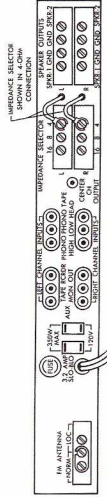
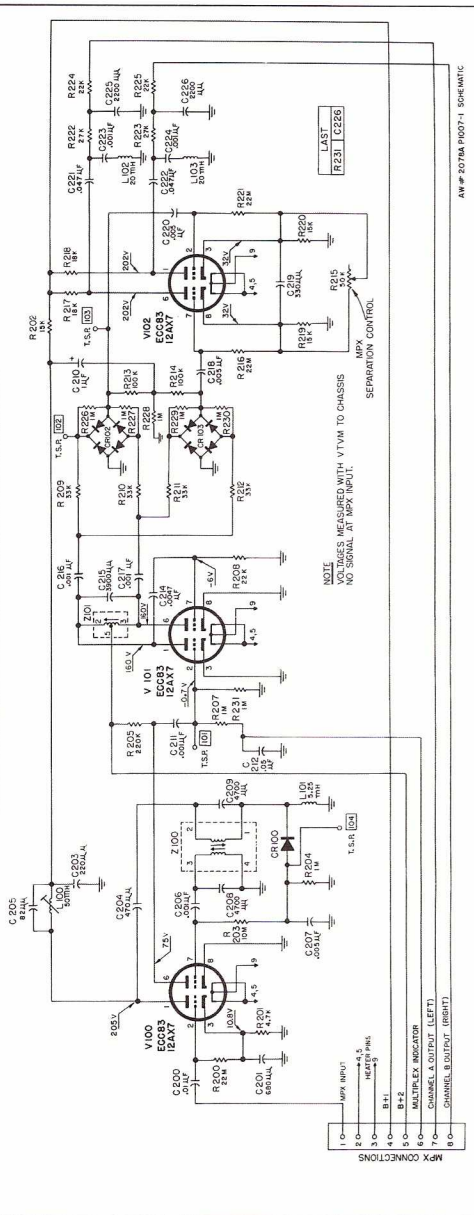

SCHEMATIC DIAGRAM • TUNER AND PREAMPLIFIER

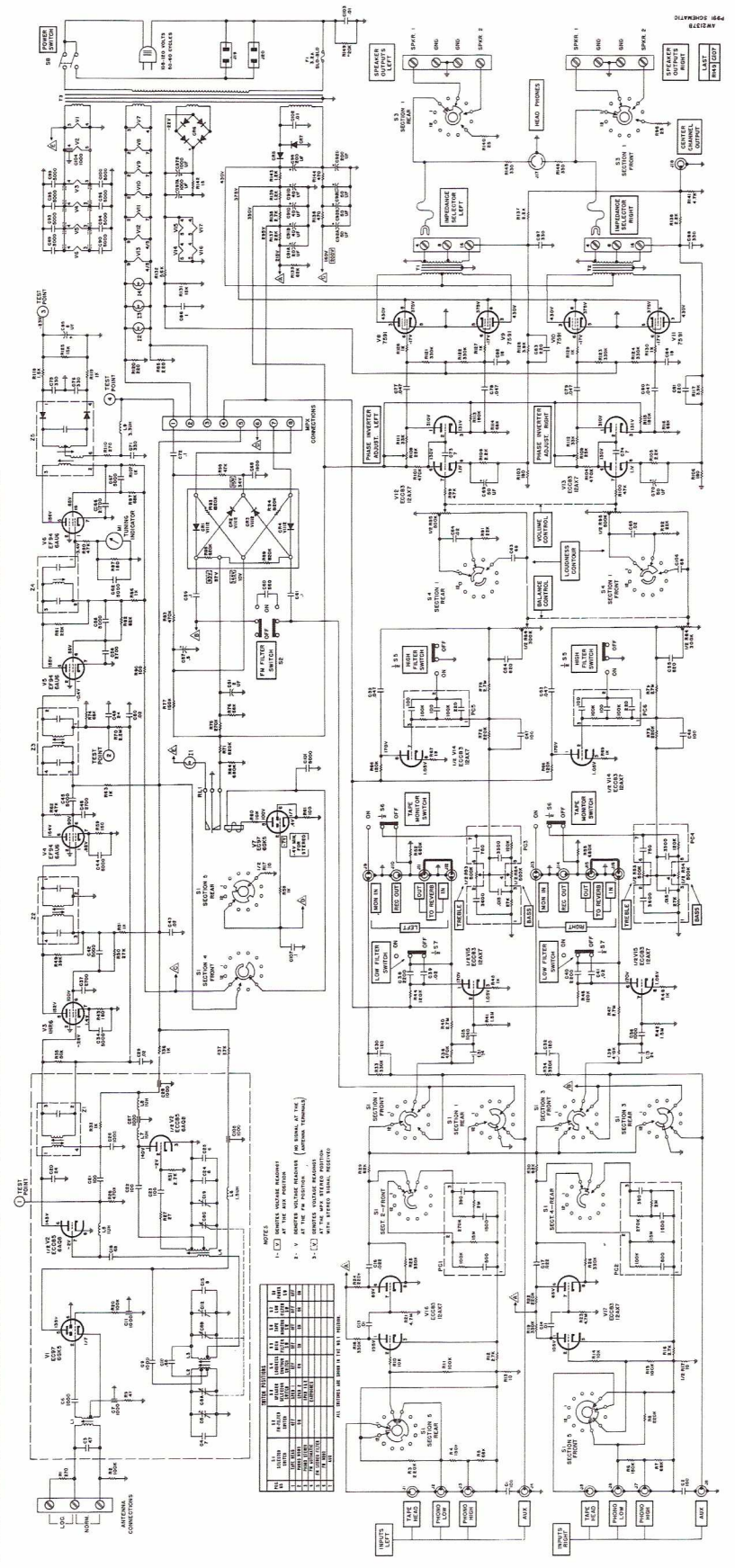

800A

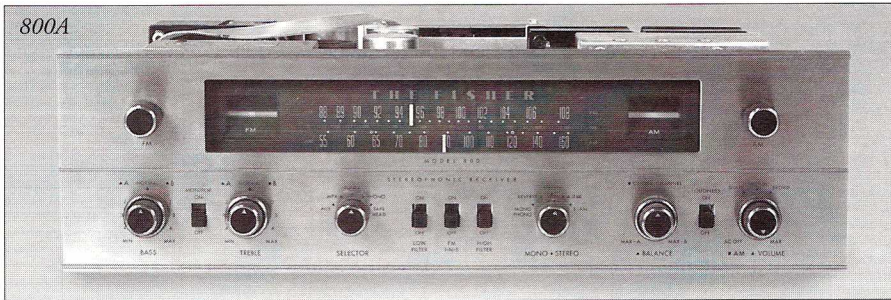

800B



800C

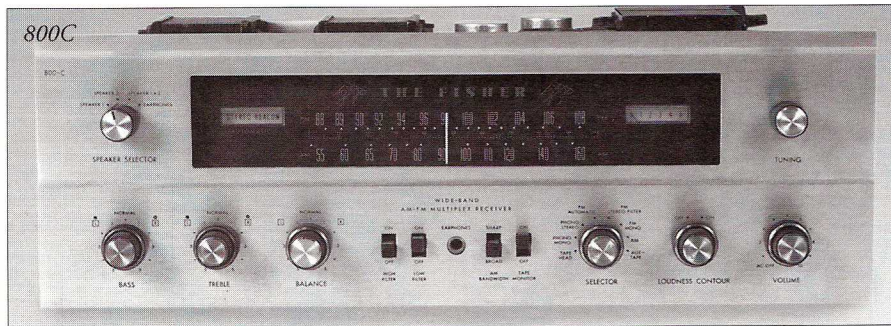

800B (R)

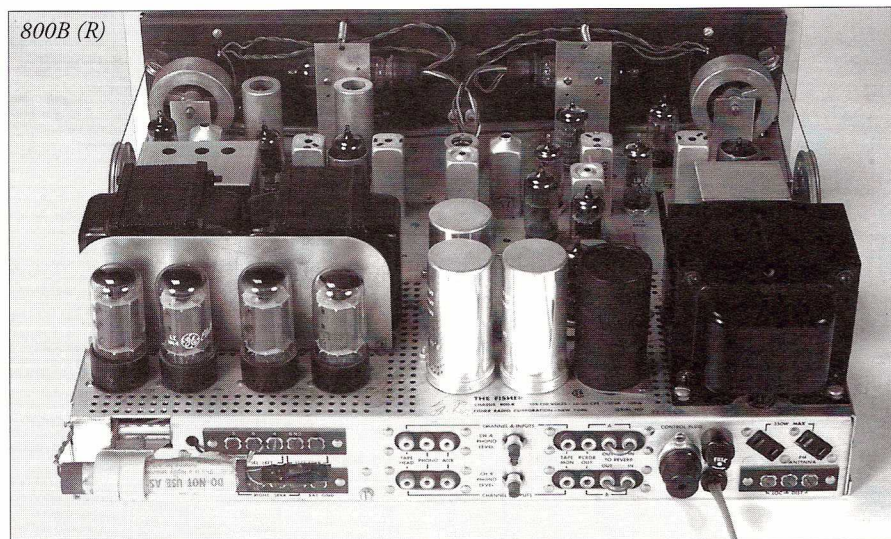

Fisher went back to the eye tube tuning indicator for the 400, instead of the meter as used in the 500C. The tuner and amplifier specifications were equal to or slightly less than the 500Cs' specifications. The advantage of the 400 is that it is

a simpler circuit with fewer switches and capacitors in the signal path, making for a cleaner sound. 400s were sold by Allied Radio and Lafayette as well as stereo stores at greatly reduced prices until the early 1970s when the stocks ran out.

Restoration

All Fisher receivers are high quality instruments that should be cared for to preserve their looks and performance. Never plug a newly found receiver into AC until you are sure the filter capacitors in the power supply are formed and that there are no electrical shorts.

The receiver chassis are heavy gauge cadmium-plated steel and are susceptible to corrosion if exposed to moisture when dusty. I have found several Fisher receivers with suspicious round or oblong rust stains that are typically caused by a small rodent who relieved itself in the set when in storage. It is important to dust off the chassis with a new, soft-paint brush occasionally to keep moisture attracting dust to a minimum. Be careful around the chassis lettering as it will rub off easily if you use too much elbow grease. Dial glasses should not be removed unless you have done this procedure before. They are very easy to break and should be left in place unless you know what you are doing.

If tubes are missing, try to locate the correct ones before beginning restoration. The rarest and most expensive tubes are the 7591A type, which are currently out of production, but are planned to be made by Svetlana in 1997 or 1998. Be careful when working around the IF cans, so you do not bend or break them. Store the receiver in a cool-dry area, away from sunlight if possible.

Early Fisher receivers used one-piece brown plastic control knobs with a gold ring around the edge. Later Fisher products, starting with the 1961 product line, used a two-piece knob with a machined brass medallion on the front of the knob that is a continual source of problems for enthusiasts restoring Fisher products. The knobs were made in Germany and the glue used to attach the medallion to the knob face deteriorates with time and the medallion piece falls off and gets lost. Al Pugliese tells me that he is looking into getting the medallions re-manufactured. Hopefully, these will be available soon.

Suggested Upgrades and Modifications

We currently recommend that you do not convert your Fisher from 7591A to EL34s. The filament current in EL34s will put a real strain on the 500C power transformer. 6L6GCs are a closer match, but will result in less power output because they do not have the sensitivity of the 7591s. Also, this modification should be done by a competent techni-

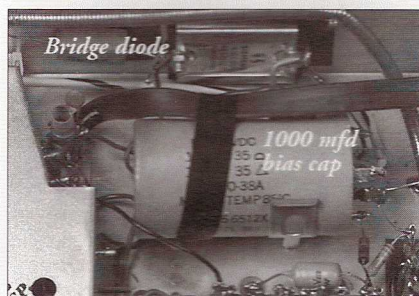

cian as it requires extensive rewiring of the tube sockets and changing the bias power supply. Svetlana has informed us that they will be introducing their re-issue version of the 7591A in late 1997 or 1998. The 7591 is an excellent hi fi tube and is designed for these receivers. To modify a receiver is to detract from its value, so be patient and carefully restore your receiver while you wait for the Svetlana 7591s to become available.

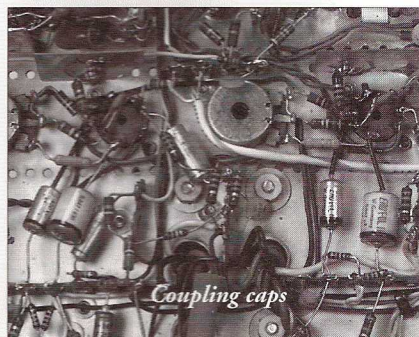

How do they Perform?

Due to the large number of receivers covered in this article, there is no way we can give sonic evaluations of every unit. To give everyone an idea of what a typical Fisher stereo receiver sounds like, we chose the 500C with a Nuvistor front-end, which is probably the most common and the overall best sounding according to Al Pugliese.

John Atwood went through our 500C, checking and replacing tubes, replacing specific capacitors and filtering areas and performing a complete FM and Multiplex alignment on his precision lab equipment. The work John did on the 500C is not a full restoration, but one that will get your unit functioning. Later, we will completely restore the 500C and report on the project in a future VTV.

The 500C was checked for reception at my house, which has virtually no multipath issues, and it performed flawlessly, with excellent mono and very good stereo reception on local stations less than 35 miles away. The FM stereo signal had a

little background noise on weaker stereo stations which is apparently is typical for these units.

Then we checked the amplifier section of the 500C using a prototype Dynaco CDV-PRO CD player using a 6DJ8 tube output stage. Speakers used in the VTV offices were the Klipsch Chorus 1s or B & W DM110s. At the same time, we were also comparing a variety of single-ended amps including ones with 300Bs, EL34s, and sweep tubes. The 500C compared favorably to the trendy SE amps!! The SE amps had great midrange, but their bass performance was mediocre and their highs seemed rolled-off. Some listeners, however, may prefer this sound characteristic. The 500C had a seamless, balanced sound from top to bottom. It had much deeper bass and clearer highs than the SE 300B amp along with good midrange transparency. While not a "reference audio component, the 500C is an excellent choice for your den, office, second system or as a stereo television home theater amplifier. All-tube receivers like the 500C will never be re-manufactured. If someone did, they would probably cost several thousand dollars to duplicate the quality and performance of original models.

Collectability

When you are out looking for Fisher tube receivers, it is likely that you will probably run across a 500C most frequently. The next most common is the 400 receiver, which were sold at reduced prices by Allied Radio until about 1970. TA500s, TA600s and 500Ss are relatively scarce in good condition and should be acquired if found in excellent shape. 800Bs are very popular among Fisher collectors and currently the most valuable Fisher receiver if they are in excellent condition. Current 1996 US prices for Fisher receivers ranges from free to about \$400+ for an excellent 800B. The rarest Fisher receivers are probably the 1500 and 1800 sets that were the last of the tube receivers made by Fisher in 1968. These sets are basically the same as 500C and 800Cs, except the bottom half of the faceplates are a metallic maroon.

Conclusion:

The Fisher tube receivers were the most popular stereo home entertainment units of their day. They outsold all of their competitors and many are still around providing enjoyment to their original owners who bought them over 30 years ago. The 400s and 500s are an excellent way to start in the tube hi fi hobby. If carefully restored, they are reliable and their performance can

Reviving a Fisher 500C

Before using that old Fisher 500C (or 400 or 800) that you just picked up, here are some basic steps in restoring it. This is the bare minimum – you can go as far as you want later.

1. If it hasn't been turned on in many years, use either a Variac or adjustable DC power supply to slowly bring up the voltage on the filter capacitors. This "re-forms" them.
2. If possible, test the tubes. Weak tubes will cause audio distortion and weak tuner performance.
3. Any obviously burnt resistors or leaking capacitors should be replaced.
3. A selenium bridge rectifier(CR-6) supplies both the fixed bias for the output tubes and DC filament voltage for the audio pre-amp tubes. These almost always deteriorate, starving the pre-amp tubes and burning up the precious 7591s. The rectifier is the flat aluminum box on the inside edge of the chassis near the power transformer (see photo on this page). If the old rectifier is not shorted, a silicon bridge rectifier can be soldered across it (with the silicon bridge in the circuit, the old rectifier is essentially inert), making sure the match up the -, +, and - leads. The silicon bridge will actually give too much voltage, so insert a 4.7Ω, 5 watt resistor between the bridge and the 1000 μF filter capacitor to give 22 volts at 117VAC line voltage. You may want to replace the dual section 1000 μF/35V capacitor (C97 A,B) at this time with axial-type electrolytics.

4. There are two electrolytics in the tuner/multiplex sections that should be replaced: the 8 μF/50V (C-85) at the ratio detector behind V15 (10 μF/50V will work fine), and the 1 μF/250V (C-210) in the multiplex section (a good film type works well here).

5. If you see brown paper coupling capacitors in the multiplex or audio sections, replace them with film types. They look like fat little caramel candies, about .75" long, with wires coming straight out the ends. They sound quite bad. Don't confuse them with the smaller dipped mica capacitors (wires coming out one side) in the multiplex section, which are good, and shouldn't be changed. The clear plastic/silver- or white-inside coupling capacitors(C-77-C-80) can be good sounding, but may be replaced.

6. Don't replace the ceramic capacitors in the RF and IF amplifier stages (unless actually broken). Their inductance and temperature coefficients are matched to the circuit. You can replace the ceramic capacitors elsewhere with film types, if wanted.

7. Don't try to align the FM or multiplex sections unless you have the right equipment and know what you are doing. Unless it is already hopelessly messed-up, aligning by ear or tuning meter usually leaves it worse than when you started.

- John Atwood - VTV Technical Editor

match or exceed that of contemporary audio equipment in their power range.

Bibliography:

Various Fisher catalogs and flyers from 1957 through 1966

Fisher magazine advertisements from **Audio** and **High Fidelity** magazines 1958-1965

A special thanks to Al Pugliese, The Fisher Doctor, Staten Island, New York, for his assistance with this article.

A Tribute To Avery Fisher

By Al Pugliese

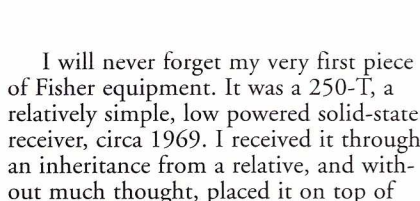

I will never forget my very first piece of Fisher equipment. It was a 250-T, a relatively simple, low powered solid-state receiver, circa 1969. I received it through an inheritance from a relative, and without much thought, placed it on top of the family TV set and connected a pair of speakers. That was in 1976. It was also around this time that I was introduced to my friend and mentor, Mr. Peter Broniecki. He saw the receiver in my home, and immediately wanted to buy it. Knowing full well that my buddy was an electronics engineer, and had a keen recognition of quality, I figured I had something real good and should hold on to it. When he realized that there was no hope of persuading me to surrender this receiver, he informed me of the unit's high quality, value and history. Noticing my intense interest in electronics and quality recognition, he began training me in the field, a process that would continue for several years. This was the beginning of my interminable search for Fisher equipment, the history of the company, the eventual contact with the "Old Man" himself.

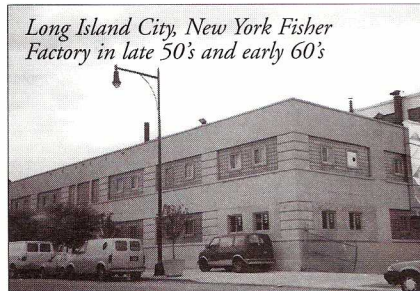

Long Island City, New York Fisher Factory in late 50's and early 60's

A few years after my initial introduction to Fisher products, I decided to contact Mr. Fisher himself if for nothing else, to at least let him know how much I appreciated his efforts and respected his demand for quality. Not knowing how to contact him, I addressed a letter to him in care of Lincoln Center; after all, this was the home of Avery Fisher Music Hall. Sure enough, within a few weeks, I received a large manila envelope with the return address, "A. R. Fisher, Park Ave., NY". Enclosed was an autographed 8 x 10 photo of Mr. Fisher, and a letter offering his profuse thanks for my "gracious

and heart-warming letter." He informed me that I had the most extensive and valuable collection of Fisher gear that he was aware of—and I only owned 40 units at the time. I immediately framed his photo and letter, which to this day hang over my main stereo console.

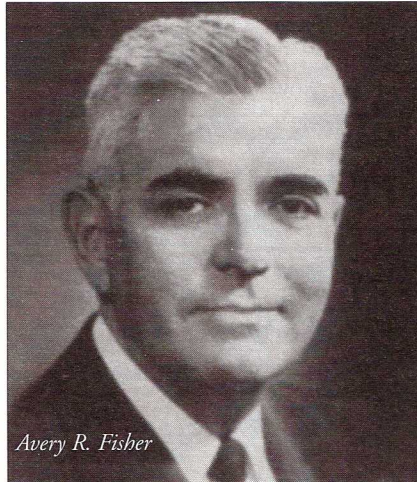

Avery R. Fisher

I was fortunate enough to have the opportunity to communicate with Mr. Fisher several times over the years, and would often receive interesting bits of information from him. On one occasion he gave me his personal keepsake, an "all in one" pocket tool in its original leather case sporting a bright gold engraving: "THE FISHER".

Avery Robert Fisher was born in New York on March 4, 1906. Avery Fisher's father was quite interested in music, and all of the six Fisher children learned to play an instrument. Avery Fisher chose the violin. He was extremely fond of chamber music, and would later frequently invite musicians to his apartment on Park Avenue for live chamber music sessions. In Mr. Fisher's earlier days, he was

employed as a book designer with Dodd, Mead & Company. He would win awards for his design work, but not necessarily be credited in the books themselves. In fact, it was during his employment with this company that Mr. Fisher's world famous trademark bird was "hatched". As Mr. Fisher himself explained, "Before I went into the electronics field, I earned my living as a book designer with Dodd, Mead & Company. In creating a design for their Spring Books Catalogue, I did the bird, but with a twig in its bill, en route to build a nest. When I went into the hi-fi business, I simply substituted a musical note and that is the origin of a trademark that is now recognized worldwide." Not only is this trade-mark world renowned, it was synonymous with the ultimate in quality and workmanship. Our working vintage Fisher equipment is evidence of this.

Although Avery Fisher made his fortune by designing and building hi-fi components, he was not really an electronics engineer. This was not much of a problem, when his usual demand for outstanding performance in a unit required

1957 Fisher Amplifier line
FISHER Exclusives That Make a World of Difference!

Exclusive FISHER Features provide that added measure of control to satisfy all listening requirements. Here is flexibility that obviates all fashioned bias. Here is FISHER FIDELITY... it makes a world of difference.

Progressive Engineering At Its Superlative Best...

THE FISHER - Model 90-A
90 Watt Audio Amplifier

• A full 90 watts of gentle power... capable of reproduction characteristics only in THE FISHER. With less than 1% distortion at full output, the 90-A performs with breath-taking, life-like clarity. • Two power supplies. • Exclusive FISHER Performance Monitor for exacting operating conditions. • Response within 0.1 db from 20 to 20,000 cycles. • Power takeoff for unpowered quality equipment. • Exclusive 2-Matic. • Output for 8 and 16 ohm speakers. • Damping factor in excess of 16.

\$229.50

THE FISHER - Model 80-AZ
30 Watt Audio Amplifier

• Incomparable FISHER amplifier with Power Scope, a visual Peak Power Indicator. • More clean watts per dollar than any amplifier in its class. • Less than 1% distortion at 30 watts. • Uniform response within 1 db from 10 to 20,000 cycles. Exclusive 2-Matic and Power Scope indicator conveniently mounted on panel. • Hum level better than 95 db below full output. • Damping factor of 24. • Outputs for 4, 8 and 16 ohms.

\$99.50

THE FISHER - Model 55-A
55 Watt Audio Amplifier

• Plenty of power for your present — and any possible future needs. • The world's foremost self-tune amplifier — a laboratory instrument functionally designed for use in the home. • Full 55 watts at less than 1% distortion. • Exclusive FISHER illuminated Power Monitor indicates average audio power. • Uniform response within 1 db from 5 to 100,000 cycles. • New 2-Matic variable damping control provides three times the range. • Damping factor of 31. • Outputs for 8 and 16 ohms.

\$169.50

THE FISHER - Model 80-C
Master Audio Control

• Containing features found only in professional studio consoles — the Master Audio Control matches any power amplifier. • Provides professional phone and tape-head equalization. • Full mixing and fading facilities for from two to five channels. • Seven inputs. • Two cathode follower outputs. • Pre-amplification and equalization directly from tape playback head. • DC filaments for non-measurable hum level. • Self-powered. • Less Cabinet, **\$99.50**

THE FISHER - Model 20-A
15 Watt Audio Amplifier

• A laboratory standard amplifier of incalculable FISHER quality, designed to meet the requirements of the most exacting user. • Low to cost, high in quality, the 20-A boasts advanced design throughout. • Less than 0.7% distortion at full output. • Uniform response within 0.1 db from 20 to 20,000 cycles. • Power takeoff for auxiliary equipment. • Damping factor of 16. • Outputs for 4, 8 and 16 ohms.

\$59.50

THE FISHER - Model CA-40
Master Control-Amplifier

• Complete in every respect — the remarkable Model CA-40 Master Control Amplifier with ToneScope! • A 25-watt amplifier with complete Audio Controls — you actually see all of the control settings! • Less than 1% distortion at full output. • ToneScope panel lights up for ready reference. • Direct taphead playback and microphone preamp. • Uniform response within 1/2 db from 10 to 90,000 cycles. • Cathode follower recorder output. • Outputs for 4, 8 and 16 ohms. Complete with cage.

\$139.50

FISHER RADIO CORPORATION • 21-29 44 DRIVE • LONG ISLAND CITY 1, NEW YORK

overly sophisticated electronics design work to be performed, he would hire an engineer who would work on a particular circuit to achieve his specifications. He was, however, almost totally responsible for the magnificent architecture, functionality, and color schemes employed in the high quality Fisher product line. He was, after all, a designer by trade.

His great talent for design work was further evident in the furniture trade as well. It was during the 1950's to mid 60's that Fisher Radio produced the finest quality home high fidelity console systems ever made. These units, which were quite popular in their day, were designed utilizing top quality hardwoods and premium electronic components. They were fine high fidelity music systems as well as classic pieces of quality furniture. Custom-made units were not uncommon, and top-of-the-line models would stretch to six feet or more and tip the scales in excess of 200 pounds. A customer could order one of these consoles equipped with the finest components available, including broadcast monitor tuners and 130-watt stereo amplifiers.

Mr. Fisher began putting his radio-phonograph sets together mostly for friends in the 1930's, using many second-hand components salvaged from movie theaters. He soon formed his first company, Philharmonic Radio. An old Philharmonic Radio service manual I have notes its location as 21 West 45th Street in Manhattan. It was not until the early 1940's that his company would become productive enough to be his sole



1960 Fisher President

PRESIDENT IV. MODERN

means of support. The U.S. involvement in World War II temporarily interrupted the business of audio production, with the company concentrating on the war effort by taking on Navy contracts. In 1943 Mr. Fisher sold the company but remained on board until 1945 at which time he resigned and began Fisher Radio Corporation.

Fisher Radio Corporation had its beginnings in a relatively inconspicuous, older style building located at 41 East 47th Street in Manhattan. At that time, the tiny storefront facility was the only place you could go to purchase Fisher equipment. A 1946 write-up in Fortune

magazine gave the new company a well deserved boost. Eventually, due mainly to the public's desire for quality equipment, dealerships would come of age, making Fisher equipment much more accessible to everyone. Sometime in the late 1940's or early 50's, production facilities were established in the Long Island City area of Queens, NYC. This became the main office and production facility of Fisher Radio, and the 47th Street store would eventually be closed. This was followed by Fisher Radio blossoming into a wonderfully successful company, boasting a 20-acre facility, known as Fisher Park in Milroy, Pennsylvania, as well as production facilities in Lewistown, Pennsylvania and Belleville, New Jersey.

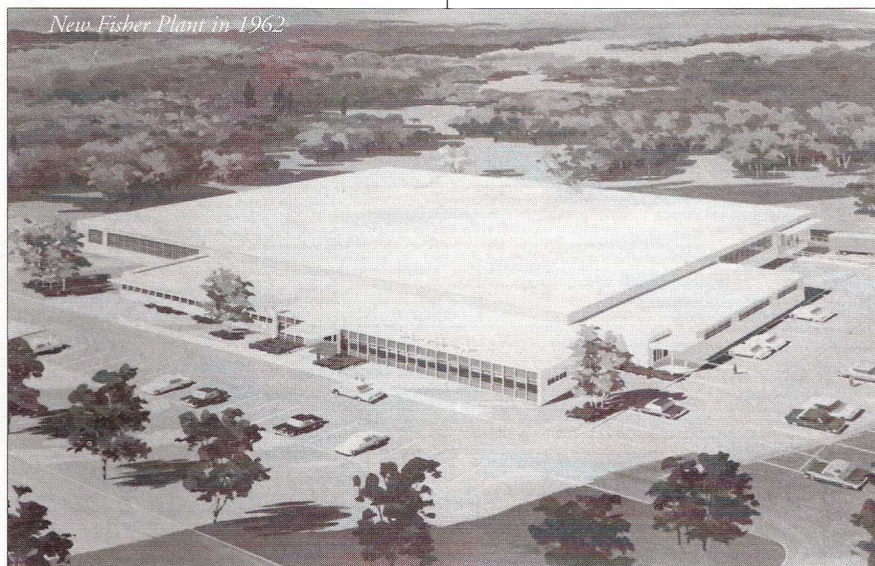

New Fisher Plant in 1962

VIEW OF THE NEW FISHER RADIO CORPORATION PLANT SITUATED IN TWENTY-ACRE FISHER PARK • MILROY, PENNSYLVANIA

Throughout his career, Avery Fisher never lost sight of the importance of human needs and customer satisfaction. Never was he inaccessible to any individual. A common story I enjoy relating is how Mr. Fisher, upon receiving a gentleman who was complaining about his Fisher equipment not working right, suggested that they go to the gentleman's home to have a look. The astounded man brought Mr. Fisher to his house, and in a few minutes, a small wiring problem was corrected, providing this customer with total satisfaction. Mr. Fisher would often drive to his empty Long Island City plant on a Saturday (they were closed Saturdays), just to answer the telephone. He would take a message, promising a return phone call on Monday.

It was this kind of genuine care and concern for his fellow man, that made Avery Fisher so very special. Never did he

forget the public that made him the success he was, a victory so unequivocally deserved. Mr. Fisher's products faithfully served everyone, from the everyday laborer, to Presidents Truman and Kennedy, even the King of Siam. In fact the list of prominent individuals who sought out Fisher equipment is exhaustive, and was proudly displayed in the 1963 Fisher Handbook, as well as in other Fisher literature. Undoubtedly, a list of all satisfied owners of his finely crafted equipment would be a huge undertaking to compile. Surely, it was good foresight, noticing the changing trends in business and manufacturing, that prompted Mr. Fisher to sell his empire to the Emerson Electric Company in 1969 for \$31 million. At this time, Mr. Fisher felt it was time to give back something to the music world, the world from which he derived his success. He therefore, in 1973, donated more than a third of the pre-tax proceeds from the sale of Fisher Radio to Lincoln Center for the Performing Arts in New York City.



The unusually sophisticated grant was designed to cover everything from maintenance, to funds held in trust for the express purpose of awarding grants to deserving musicians. Lincoln Center in turn used a portion of the grant to totally redesign the acoustically ailing Philharmonic Hall, Lincoln Center's major concert hall, and rename it Avery Fisher Hall. The gesture was mind boggling to Mr. Fisher, and made him uncomfortable at first, owing to his "regular guy" personality.

Being native New Yorkers, my wife and I frequently visit Manhattan, whether to see the latest Broadway play, or just to take a stroll down Madison Avenue on a weekend to blend in with the thousands of tourists. I could not even begin to count how many times we have made that turn onto 47th Street, so I could just once more stroll past the site of the very first store where one would go to buy a Fisher product. His modest shop existed here so many years ago. We notice how the entire neighborhood has so dramatically changed from the days when Mr. Fisher walked these very same streets.

Today, they are littered with 60 and 70-story steel and glass skyscrapers. I can only imagine how quaint and homey this part of the city must have been when he ran his business here. I can almost see that tiny storefront, with the words "Fisher Radio Corporation" on the glass window, tucked neatly in the shadow of a typical New York City 1890's brownstone.

On February 26 of 1994, just a few days before his 88th birthday, Avery Fisher passed away in New Milford, Connecticut. I will never forget how and when I heard the news. I had been making periodic purchases from an old warehouse of what I believe is the only surviving stock of vintage Fisher parts and original factory documentation known to exist. The building was being sold, and this would probably be one of my last visits to this historic place. It was a very cold, sunny Sunday morning. At the very moment that I stopped my car in front of this warehouse, I heard the newscaster on the car radio report that Avery Fisher had passed away the day before. Shocked by the news, I began to reflect about all the time that had passed since I first made Mr. Fisher's acquaintance. It seemed to make my efforts to preserve the history of Fisher even more important. I recalled in particular, the closing line of one of the last letters I received from him. It read, "Incidentally, my closest friend at college many years ago was a man named Anthony Pugliese. There may be a message in that coincidence." Yes Mr. Fisher, there is a message it that coincidence, there certainly is.

Al Pugliese is The Fisher Doctor. Al is the Fisher expert and offers rebuilds, repair and service for Fisher tube hi if equipment. He also has a comprehensive library of schematics and technical information as well as some Fisher replacement parts for sale. Contact him at: The Fisher Doctor, 27 Daleham Street, Staten Island, New York 10308 718-948-7489

Reprinted with permission from Classical disCDigest The Audiophile/Collector Magazine, PO Box 192, Ringwood, NJ 07456 (201)487-3344



Al Pugliese and VTV ed

Tube Lore:

A Reference For Users And Collectors by Ludwell Sibley

Reviewed by Eric Barbour

Paperback, 8 1/2 x 11", \$19.95 US/\$24.95 elsewhere from Ludwell Sibley, 44E. Main St., Flemington, NJ 08822 or Antique Electronic Supply, Tempe, Arizona

There are quite a few books in print related to antique radio and tube audio. Many of them are just reprints of old texts, and some are in the how-to-make-your-own-tube-amp category. But tube collecting is one area of vintage electronics that is not well served today. The few books available, such as John Stokes' *70 Years of Vacuum Tubes and Valves* and Gerald Tyne's *Saga of the Vacuum Tube*, seem to concentrate mostly on the early years of tube manufacture. There are two books out now on Western Electric tubes, so that (small) area is well-covered. But most of the world's tube types were introduced between 1940 and 1970, and those years have never been adequately researched and documented.

Finally, an exhaustive book has arrived. Compiled by Ludwell Sibley, *TUBE LORE* is an instant classic. Sibley is the former editor of the Antique Wireless Association Journal, and it appears that he got lots of help from some noted experts in the field. He also seems to have delved into the old records of the RMA/EIA registration system, which once assigned standard numbers to new tube types for industry to follow. These data are extremely valuable and not available to the public in any previous form.

If you're looking for a pretty coffee-table book, with lots of nice photos of antique triodes, this book isn't for you. There are a few photos, but the vast majority of the book consists of lists of tube types. Technical data is kept to a minimum, but historical discussions of the types and families abound. And individual type listings are treated much like Bernard Mager's book on Western Electric tubes, with the date of introduction and the original manufacturer(s) usually being shown. I guarantee that you will not find most of this information in any other book, and it is a real boon to serious tube collectors (not to mention the VTV staff).

Chapter 1 is titled "Trends In Tube Design". It gives the basic histories of the common post-1934 tube varieties: acorn,

metal, loktal, miniature button-base, sub-miniature, lighthouse, button-stem octal, Nuvistor, Compactron, Novar, and even the very obscure Sylvania T-9 envelope used on the 6GM5 and a few other types. A discussion of the early days of U. S. military "high-reliability" types leads up to the end of American production in the 1980s thru 1991. The Stokes book does not have most of this information. No tube book to date has any substantial coverage of the post-WWII industry, so this chapter alone should sell *TUBE LORE*. But this is only the first chapter.

Chapter 2 should be read before studying the type data. Here are the codes for such things as manufacturers and ratings, plus definitions of contractions, technical terms and the like. A unique history of the EIA-RMA registration system is here, covering the common 1A6-type designators as well as the earlier 2E26-type designations. This led to the later "non-system" of the 4-digit series. The previous RMA designators contained such data as filament or heater voltage/power, and general type or number of elements. The 4-digit series started with 5500 and went through 9019.

It shows what a mess the industry was; some of the 4-digit series are not even tubes--for example, the 7223 is a germanium photodiode. The 4-digit numbers were assigned chronologically, and have absolutely no descriptive meaning for the devices they are attached to. The next chapter is called "Prehistory". It seems to attempt to list all the types made by nearly all the manufacturers before RMA registration began. These are alphanumeric lists--first a general list, followed by family lists for each factory, from Arcturus through Van Horne. This was even worse than the 4-digit numbering, as these companies cheerfully assigned their own designations to their tubes. Luckily, some kind of gentlemen's agreement (or perhaps the force of RCA's marketing) led to the 2-digit system being a part of most of these types. With a few intractable exceptions, a tube with a designator containing "45" was probably a replacement for a UX-245. Almost as crazy as today's semiconductor industry, eh?

Chapter 4 is the alphanumeric list of "commercial" RMA types, starting with 0A2 and ending with 117Z6. A typical entry looks something like this:

6AB4 [aka EC92] miniature high-u RF triode for G-G amps, heater 6.3v @300mA, u 62 (SY) (4-25-49) <5CE>. Variant: 6664.

Priceless information in there--original intended application, original introducing manufacturer (Sylvania in this case), and date of registration. Try getting all that from old magazines, as we at VTV have been doing up to this point (or trying to do). Even the AKAs and variants, base pinout, and heater data can be difficult to find for some types. Although not all the listings are fully detailed, there is a wealth of facts in this chapter and throughout the book.

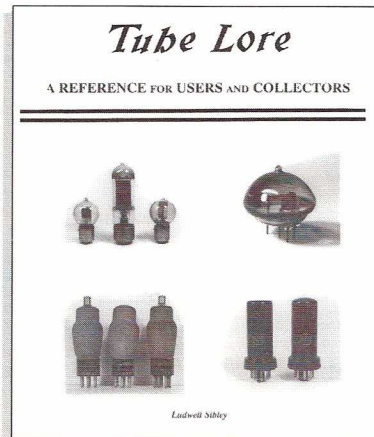

Chapter 5 shows the same kind of list for the old RCA 800-series of transmitting and power tubes. Chapter 6 covers the pre-1946 RMA "special purpose" types, starting with 1B21 and going through 9C31. These were mostly seen in WWII and were replaced by the 4-digit scheme. Finally, we plunge into the 4-digit listings in Chapter 7. Ironically, they start at 5500, a type that apparently never existed. As I said, this list is a real mish-mash--most are "industrial" types, but some are intended for consumer use, such as common audio types 6550, 7591, 8417 etc. And you will find everything from germanium diodes to giant klystrons. Many of the later 4-digit numbers were grabbed by Eimac in the early 1960s and attached to their transmitting types, most of which also had perfectly good Eimac designators. All the large tube manufacturers have been guilty of this alphabet soup game.

For audio geeks, Chapter 8 will result in boredom, as it lists CRTs from 1AP5 through Z1304. But there are people who collect rare CRTs, and this will be indispensable to them. Note that this list is sketchy at times, as manufacturers often attached their own numbers to CRT types (and always do today). This chapter lists something most of you would recognize the output of, but have never seen the actual device that did it: monoscope tubes were special-purpose camera pickup

tubes that produced only one picture--usually standard test patterns, etched on a metal mask buried inside the tube. Now you know where that test figure with the war-bonneted Native American came from.

There was a mess of nonstandard numbers during this time period. Chapter 9 tries to cover most of them. This subject has some gaps, but try finding any of it elsewhere. Here are listed the original developmental numbers of all the Bendix Red Bank tubes, including some that I have never seen or read about before. The list also includes most special types by specialty manufacturers: Electrons Inc. (industrial thyratrons and rectifiers), Federal Telegraph (later ITT), Heintz and Kaufmann (transmitting and industrial), Machlett (exotic high-voltage types), Sperry Electronics, Taylor (transmitting tubes), Victoreen (tubes for radiation counters), and Weltronic (industrial types).

Chapter 10 is a reasonably complete list of military types. The American Army VT series and Navy series are followed by the little-seen Canadian REL types. Chapter 11 covers DeForest, which made mostly transmitting types compatible with the RCA 800 series. And Chapter 12 is a long, long list of Eimac's products. It seems that Eimac has been willing to make weird tubes for single customers--their line is full of tiny variations of power tubes built on a few basic stems. This list is not complete, as Eimac also makes a mess of customer-special types in the YC series, which are extremely specialized and difficult to get information about.

All of the big tube factories had their own developmental numbers. Chapter 13 shows most of GE's, which are primarily special things such as photomultipliers, CRTs, vidicons and industrial types. Chapter 14 is the Raytheon RK series (mostly RF types), CK (mostly subminiature), and QK (specialized types). RCA's 1600, 1800, 2000 and 4000 series are shown in Chapter 15. The 4000s were the last ones RCA developed before Thomson sold the division; it is now called Burle Industries, and still produces many 4000-series types (primarily vidicons, microwave tubes, etc.)

Sylvania had its own series of tubes under development, and they are seen (most for the first time) in Chapter 16. The 1200 series was mostly loktals from the WWII time frame. Later came SA, SD and SN types, most very obscure. Like the other special series in this book,

the Sylvania chapter has some gaps, but seeing as this information is impossible to get any other way, no one has a right to complain.

Chapter 17 covers most Western Electric types that are seen in the Magers book already. Westinghouse had numerous special series, and they are in Chapter 18. I must express admiration for Sibley; trying to get this corporate proprietary information, about obsolete products made by now-defunct divisions, must have required the patience of a saint.

A good book could be derived simply from Chapter 19. It's called a "User Guide", and gives information on testing, rejuvenating and fixing bad bases on used or damaged tubes. This chapter actually describes date coding on most American brands--try finding that in your old textbooks or tube manuals!

The first lengthy discussion of TV sweep tubes in publishing history occupies Chapter 20. Nearly all the common American types are listed, along with typical equipment other than TV sets that used them. Some unusual hi-fi and guitar amps used sweep tubes, along with a wide variety of ham-radio and CB linear RF amplifiers. Sweep tubes occupy a lost world, and Sibley has done it a priceless favor by documenting it.

Chapter 21 is a lengthy list of recent auction prices for various tubes, compiled from auction reports in magazines such as ARC. As might be expected, it's not very complete and contains mostly pre-1930 radio types. Nevertheless, it gives some idea of values for early types. Because this market is unstable, we probably will not see a conventional price guide for tubes for many years to come. Besides, most of the "junk" TV tubes you see at flea markets are and probably always will be worthless. But the hardball collectors go for things like the single-wing Audion (\$1400) and the Oscillion (\$2100). And audio triodes, such as 50 and single-plate 2A3, are quick-cash things to be shipped to the Far East. Finally, there is a 1-page index at the end, with keyword listings.

This book is not perfectly exhaustive. No book is. Yet Sibley has done an impressive job of gathering information that no one has dared to collect in one place before. The post-1945 data are regarded by the antique-radio crowd as boring and unimportant, yet any decent historical text on tube electronics should cover that era. Anyone with the nerve to call themselves "tube experts" should own TUBE LORE. It is one of the most mandatory books in this area,

A Museum Class Inspires an Amplifier

By John Atwood

In the fall of 1995, a single-ended stereo amplifier was designed for a museum crafts class, at the request of Chris Boettcher. Chris, a member of our Bay Area Tube Enthusiasts group, works at the Randall Junior Museum in San Francisco as a curator of industrial arts. The museum gives arts and crafts course for children and adults. Since woodworking is his specialty, Chris has taught classes in guitar building and speaker building. After he got interested in tube amps, he asked me if I could teach a class on tube amplifier construction. Having recently built some single-ended amps, and being in the process of putting together the One Electron transformer product line, I thought that a moderate-power single-ended amplifier would make a good project. Since that time, two classes have been taught and the "Randall Amplifier" that resulted is now on the market. The design philosophy, development, and class experiences will be covered in this article.

Design for a Museum

Since the class at the Randall Museum would be open to anyone, the amplifier would have to be inexpensive, simple to build, be easy to use, and be "bullet-proof." I also wanted the amp to be a statement of tube technology, which meant no compromises with solid-state components. Simplicity of design and cost considerations led to an integrated stereo amplifier. I knew from work on modifying conventional stereo tube amps that if care was taken in component location and power-supply filtering, virtually the same performance could be achieved as having two "monoblock" amps. Adding an input level control and making the amp relatively sensitive allowed it to be run directly from a tuner or CD player without a separate pre-amp. To keep the amp inexpensive and maintainable, only parts that are readily obtainable from sources such as Digi-Key, Mouser

Electronics, Newark Electronics, New Sensor Corp., Antique Electronic Supply, etc. would be used. And finally, the amplifier had to sound good and be usable by people who had previously been using solid-state equipment, i.e. not a tweaky, funny-sounding cult amplifier.

The circuit topology was drawn from two earlier amps: my SEA-1 amplifier using three 2A3s (described in *Sound Practices-Fall 1994*), and John Broskie's dual-EL34 single-ended amp. John Broskie's amp proved that two triode-connected EL34s driving a One Electron UBT-1 1.6K output transformer could sound quite good. A key to his design was the connection of of grid #3 (suppressor grid) to the plate, instead of the cathode as is usually done. The driver circuit of the Randall amp was a somewhat down-sized version of what was in the SEA-1 amplifier, using more obtainable tubes. The power supply is based on the One Electron BFT-1 power transformer, which was developed to support the Randall amplifier, as well as other stereo amplifiers in the similar power range.

It was clear that a custom chassis would be needed to make the Randall amplifier attractive, rugged, and reliable. The chassis layout is reminiscent of a Dyna Stereo 70. An interesting variation, though, is the use of a sub-chassis to support the output tubes and rectifiers. This was originally done to prevent the insertion of metal 6L6s or 6550s - their pin 1s are attached to their metal shells, while in the Randall amp, pin 1 is tied to the plate. By physically preventing the insertion of these tubes, a safety problem is averted. The sub chassis has other benefits: it stiffens the chassis and provides shielding between the power supply and the input circuits. The main chassis is made from 14 gauge steel. This is thicker than usual, but results in a really stiff,

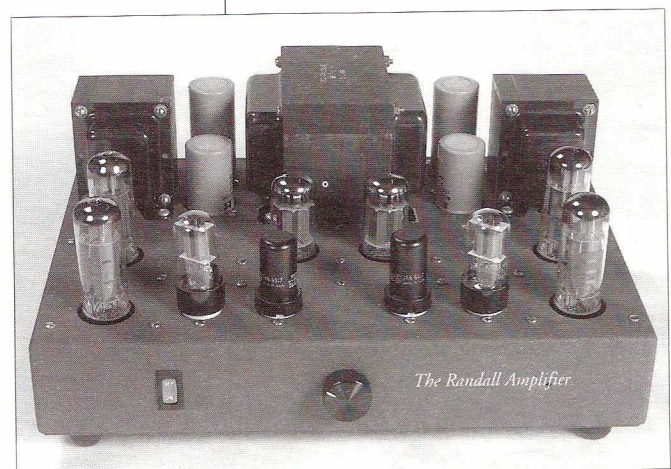

THE RANDALL AMPLIFIER

solid chassis. Anyone using a tube amplifier has already foregone lightness and efficiency, so we might as well go all the way. Besides, steel is cheap. A grey-wrinkle powder coat finish is used. This is remarkably like the classic solvent-based wrinkle finishes, but is very rugged and environmentally-friendly. Drawings were made up, and the chassis were built by a local sheet-metal shop, U.S. Fabrications, in San Jose, California.

A circuit board had been considered, but in the interests of cost and period authenticity, it was decided to go with point-to-point wiring. This made the construction phase more difficult, but made circuit changes and parts substitution a lot easier. A set of wiring diagrams was produced that showed the sequence of wiring and parts installation.

Circuit Details

The Randall Amplifier is a conventional single-ended amplifier using all medium-mu triode amplification. The UBT-1 output transformer provides 4, 8,

and 16 ohm outputs. The maximum power is about 13 watts per channel before clipping. A small amount (3db) of negative feedback is used to increase the speaker damping factor and reduce distortion. The BFT-1 power transformer

allows use on power line voltages from 100V to 240V, 50 or 60Hz. Note that on the following circuit description, that where the schematic diagram reference designators have a dash ("-") in them, the part is used in both channels.

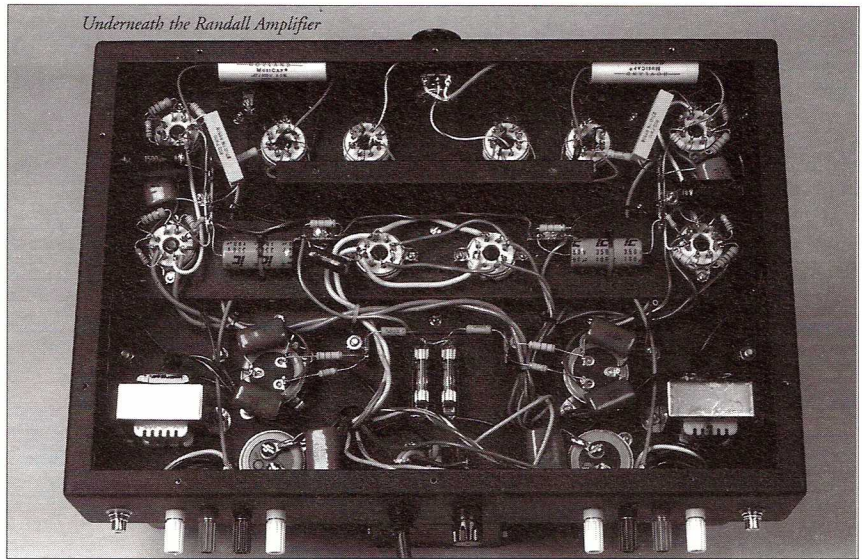

Underneath the Randall Amplifier

The first stage is a triode-connected 6SJ7 biased at 3 mA. This has a mu of 20, making it similar to a 6J5 or 1/2 a 6SN7GT. The second stage uses a 6SN7GT with both sections paralleled, biased at 11 mA. The small cathode capacitor (C-05) is used to boost the output at high frequencies to compensate for the capacitive loading of the output stage. This technique, called "cathode compensation" was originally developed for use with video amplifiers.

The output stage uses two triode-connected EL34s, biased at about 125 mA. An unusual aspect of this stage is the connection of the suppressor grid to the plate through 1K parasitic suppressor resistors. Experiments done by John Broskie and others showed this to be a better sounding configuration than if the suppressor is connected to the cathode. Cathode bias is used, which is stable enough to not require any adjustable bias controls. The positive cathode voltage, about 33 volts, is connected to the two heater windings. The elevated heaters help reduce hum and noise in the driver stages. An output stabilization network (R-19 and C-11) is needed to avoid oscillation with certain inductive speaker loads.

The power supply is a conventional capacitor-input vacuum-tube rectified supply. It was originally designed for two 5V4G rectifiers, with the hope that the inexpensive Sovtek "5V4G"s could be used. It turns out that these have a much

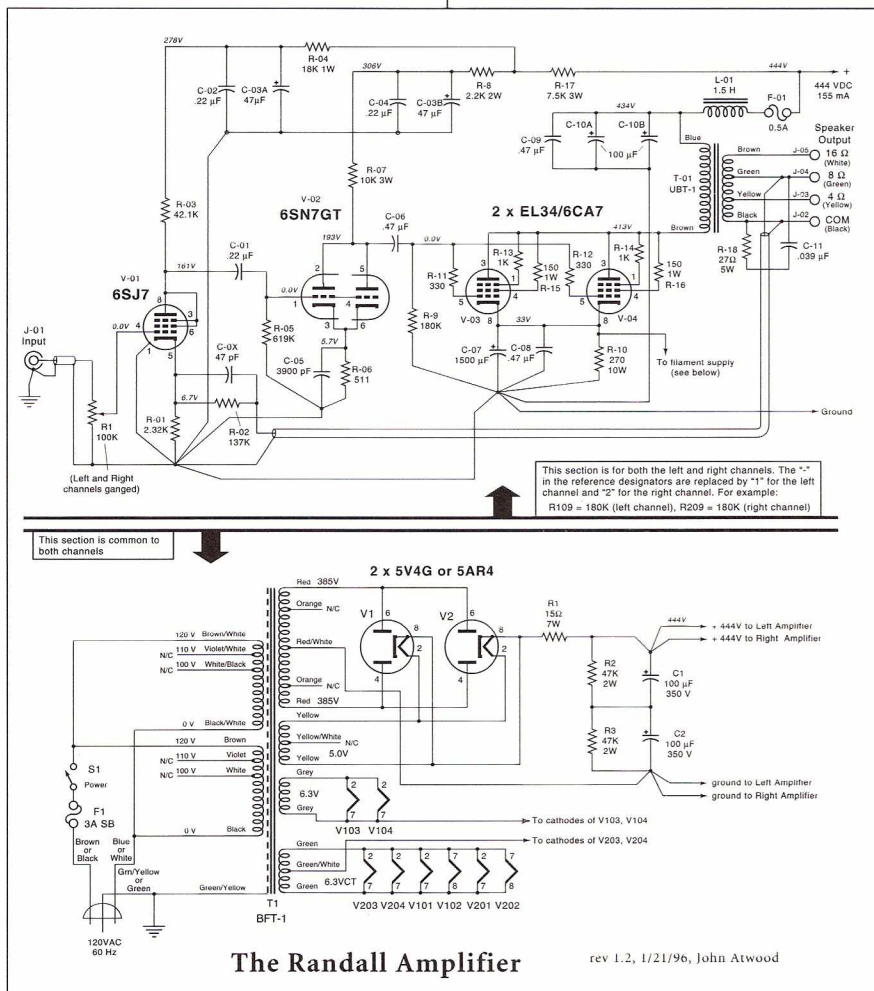

lower current rating than real American 5V4Gs (less than 125 mA vs 175 mA), and problems with arcing occurred. N.O.S. 5V4GAs worked well, as well as Chinese 5AR4s, which are used in the current models. R1, a 15 ohm resistor, limits the peak charging current, both protecting the rectifiers, and lowering the overall system noise. R2 and R3 are bleeder resistors that also equalize the voltage across the input filter capacitors.

Special care was taken with the high voltage distribution and filtering. None of the amplifying stages share a common filter capacitor, reducing interaction to near mono-block levels. Often, single-ended output stages disturb the power supply enough to cause "motorboating" or other kinds of feedback. The driver stages are filtered separately from the output stage to reduce interaction between these stages. A fuse is used in series with the filter choke to the output stage to protect the output transformer in case of a tube short.

Despite the two stages of filtering to the output stage, 120Hz hum coming from the B+ supply was present in the output of the original design. Raising the filter capacitor values would endanger the tube rectifiers, and there was not enough room to increase the choke size. A form of hum cancellation was used to reduce the hum substantially. By tapping the B+ supply to the first stage from part way between the raw +444 volt supply and the well-filtered supply to the second stage, enough 120Hz signal from the raw supply is fed into the first stage to cancel most of the hum from the output stage. The correct ratio of R-8 to R-17 was found by substituting a rheostat for these two resistors, and adjusting it for minimum hum. If changes are made to the stage gains or filter capacitor values, these resistors will need re-adjustment.

The grounding scheme is a form of "hierarchical star grounding", and is shown in the schematic. The grounds for each stage is starred at a single point, then these stars are connected to the next lower-level stage's star. The grounding between the two channels meet at the power supply, and are connected to the chassis near the input connectors. An important part of this scheme is that the output common lead is grounded through the feedback shielded wire to the input stage's star ground. This grounding scheme works well, with very little hum or noise.

High-quality yet inexpensive components are used in the Randall Amplifier. The plate or cathode resistors are metal

film or metal oxide. All coupling capacitors are "Xicon" polypropylene types, as are capacitors that bypass all electrolytics. Small capacitors are either mica or polystyrene. The critical output cathode bypass capacitor is a Panasonic HFS low-ESR type. The B+ filter capacitors seen by the amplifying stages are the British LCR type. The filter choke is by Stancor (although made in Thailand), and the transformers are One Electron types. The tube sockets are mil-spec Russian ceramic types. Although these parts make a good-sounding amp, some students substituted even higher quality parts (see sidebar).

Class Dynamics

Ten evening sessions, one a week, were scheduled for the class. The first two classes were lectures on the history of tube amplification and basic theory. The next six classes or so were dedicated to construction, and during the last two classes, the amps were checked and tested. The class size was limited to ten. Two classes have been given so far, the first at the end of 1995, and the second during spring 1996. About half of each class



were people who had had some tube electronics background, but the rest had little or no electronics experience. Most students came from San Francisco, but a few (including the teacher!) came from as far away as San Jose and Santa Rosa. The Randall Museum provided workbench space in their woodshop, as well as soldering irons, solder, and handtools. In addition to a \$72 tuition fee, each student paid about \$475 for the parts. This parts price is only minimally marked-up over cost.

On the whole, the classes were quite successful, with all but three people finishing finishing their amps during the scheduled classes. Two of those three have since finished the amps on their own. There was a definite spread in construction quality and wiring skill. Some people quickly and accurately wired up their amps, while others took time and needed help in getting the wiring right. Interestingly, people who had no previous electronics background often did the most accurate wiring.

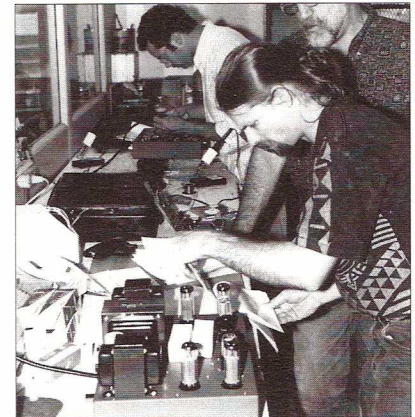

Before applying power, I did a visual check of the wiring, then ohmed-out critical circuits. Power was applied in stages, and once we got past the "smoke test" phase, the amp was tested for frequency response and distortion on a Sound Technology 1700B distortion analyzer, Tektronix 561A oscilloscope, and Heathkit IG-1275 function generator. At this point, some subtle wiring errors were often found. Once the wiring was corrected, all the amps came out with surprisingly consistent performance: about 13 watts rms per channel before clipping, about 2 to 3% THD at 5 watts output.

Results

Students who had only used solid-state equipment loved the sound of the Randall Amp. (This is kind of like shooting fish in a barrel!) Some of the students were dedicated high-end audiophiles, familiar with the best push-pull and single-ended tube designs. They found the Randall amp the be very competitive, especially after using high-quality components (see side-bar). One student reported the amp sounded better than \$5,000 single-ended amps he had heard. Most found that the power level suited their speakers. Speakers used ranged from no-name department store speakers to Vandersteens to Lowthers in custom-built cabinets. The most serious power mismatch I found was with my own Celestion SL-700s – just too inefficient.

Aside from component substitutions, some of the students made some modifications to suit their sonic tastes. Several experimented with removing the feedback. The general consensus was that with no feedback, the sound was more dynamic, but that complex music could get congested. One student added a switch to bypass the first driver stage (thus also eliminating the feedback and reducing sensitivity), finding that eliminating one stage helped the detail. One

Randall Amplifier Student Listening Impressions Using Designer Components

Several students experimented with putting high-end "designer" components into their amps. Here is what some of them found:

George K. experimented with putting both Hovland Musicaps and old mil-spec paper capacitors in the coupling capacitor positions. He found the best combination was the stock Xicon capacitors for the .22 μF and the Musicaps for the .47 μF positions.

Ghanti S. and Mike B. did extensive listening tests with many components. They used Cera-Fine electrolytics in place of the LCR capacitors and experimented with removing the film bypasses around them. They found a loss of detail, so put them back. Nichicon "EX" capacitors were used for the 2200 μF cathode bypasses. Many tests were done on the coupling capacitors. Audio Note paper and oil (aluminum foil) were first tried, and gave good tonality and "weight", compared to the Xicons but had indistinct imaging. The copper-foil audio note paper and oil capacitors were compared to the aluminum-foil types, and not much difference was noticed. Hovland Musicaps gave much better detail, although had less weight. The Hand-Made Electronics oil capacitors were much better than the Audio Notes - good weight but better imaging. The best were MIT "RTX" polystyrene capacitors which were faster and had pin-point imaging without sacrificing body.

In summary, the designer components made a difference, although did not have to be used everywhere. Film bypasses of the big electrolytics were important.

person found that when driving his JBL speakers, the bass seemed too loose. I modified the feedback from 3db to 6db, and this satisfied his speakers.

Due to popular demand in the South San Francisco Bay area and around Santa Cruz, I will likely give courses in these areas, as well as probably more courses at the Randall Museum in San Francisco in the future. I have also made semi-kits and fully-constructed amplifiers available commercially (see the One Electron ad on page 35). This class has been a good proving ground to see how a design can be built by everyday people and how it will work in real-life situations. It has also really been gratifying to help both novices and experienced people get into tube electronics.

For more information on the Randall Museum and its activities, write: The Randall Museum, 199 Museum Way, San Francisco, CA 94114 USA, or look at <http://www.wco.com/~dale/randall.html>.

For information on the Randall Amplifier, contact: One Electron, 65 Washington St., #137, Santa Clara, CA 95050 USA, or look at <http://www.one-electron.com>.

The Story of the Loftin-White Amplifier

By Alan Douglas

Conventional audiophool wisdom has it that direct coupling, when it appeared in 1929, was far better than anything else in existence, was a resounding success, and lives today in audio systems worldwide, a testament to the genius of its creators Edward H. Loftin and S. Young White.

Every one of these facts is wrong.

Direct coupling was fifteen years old by the time Loftin and White came along. When they first published their circuit in 1930 their avowed goal was to make the "smallest and cheapest" amplifier, not the best. It sank like a stone. Every novel feature of their amplifier was soon abandoned, and present-day "Loftin-White" designs owe them little or nothing.

How have their names come to be synonymous with circuitry they did not invent? Why did the recognition they craved, arrive sixty years too late?

In the Beginning

Edward H. Loftin was born in Montgomery, Alabama in 1885. After graduating from the U.S. Naval Academy in 1908 he held various high-level positions in Naval radio, before resigning in 1924 to take up private research and to act as a patent attorney and an expert in patent suits. By successfully prosecuting fifty of B.F. Meissner's patent applications on AC-powered radios, and licensing various radio companies before finally selling these to RCA, Loftin received more than \$300,000 in royalties up to July 1930, which money doubtless financed the Loftin-White Laboratory. But he got into marital and stock-market difficulties, and was soon down and out, according to Meissner's autobiographical account in "The Early History of Radio Guidance" (San Francisco Press, 1964), and reportedly died alone in a New Jersey trailer park.

S. Young White was born in New York City in 1901 and worked at various jobs including shipboard radio operator and in the General Electric Company Test Department. In 1924 he joined the Loftin-White Laboratory. After the Second World War he surfaced in New York City in the ultrasonics field, writing a lengthy series of articles for *AUDIO* magazine in 1947-1949 on high-sound-level experiments. His credo seemed to be "If I can't hear it, it's harmless" but one wonders what became of him. Incidentally, in the August through December 1948 issues he showed how to make your own transistor.

An Engineering Team

Loftin and White joined forces in 1924 to leave their mark on the world, attaching the "Loftin-White" name to whatever advances their laboratory produced in the field of radio. Initially in 1928, this was an RF amplifier circuit with equal response over the entire broadcast band, offered as a set of mail-order plans and also to have been incorporated in the new Splitdorf radio line, to avoid RCA patents. At about the same time the two inventors presented a paper before the Institute of Radio Engineers on a method of stabilizing the grid bias in direct-coupled amplifiers, an interesting laboratory exercise but of no commercial value. It did, however, indicate the direction their work was taking. By mid-1929 they had solved a technical problem that previously had prevented the use of the 50 tube in resistance-coupled amplifiers. They presented another IRE paper in November 1929 (published in April 1930) and attempted to license their new method to radio manufacturers. The January 1930 issue of *Radio News* published some hints of the new develop-

Loftin-White Amplifier

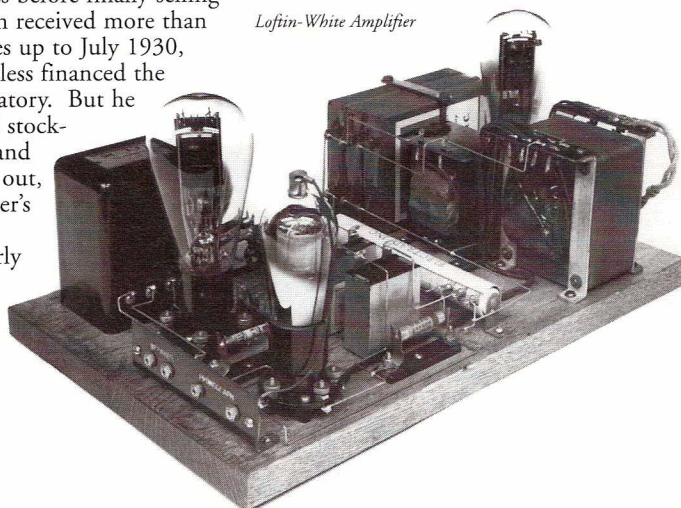

ment, and beginning with February a lengthy series of articles containing the details. Several other magazines jumped on the bandwagon, and thus were the names of Loftin and White indelibly associated with direct coupling.

Why Direct Coupling?

It is necessary to backtrack, to understand what Loftin and White did, and why. The 50 tube, developed by Westinghouse for RCA in 1926-1928, was the largest practical output tube for home radios, used wherever more than the 2 watts available from 71As was needed. But the 50 was prone to grid emission and gas, so the maximum grid-circuit resistance was limited to 10,000 ohms. Now to get reasonable bass response from a resistance-coupled circuit, a large coupling capacitance was needed, and this created two problems. Available capacitors of that size tended to be leaky, and momentary overloads charged up this large capacitor and blocked or cut off the 50 until the charge leaked off through the grid resistor. A lower grid resistor helped the latter problem but required a larger capacitor which only made the first problem worse. In practice then, the 50 was not suited to resistance coupling, but was always used with an input transformer which was expensive.

Loftin and White's idea was to eliminate the pesky coupling capacitor and therefore the blocking problem. This immediately created more difficulties than it solved, but each of these new challenges had its solution and the inventors doggedly attacked them one by one. Bias instability, only made worse by referencing the 50 bias to another drifting amplifier stage, was reduced by three inverse feedback networks: the 50 cathode current controlled the 50's own bias as well as the 24's screen voltage and grid bias. This worked very well, and was Loftin and White's chief contribution to direct-coupling technique.

Now the 50 needed a high plate voltage, to which was added the 24's operating voltage, resulting in a minimum requirement of 500V which could only be supplied by an 81 rectifier. Unfortunately the 81 was half-wave, and using two would violate the "smallest and cheapest" promise; furthermore very little filtering could be done since 500-volt-plus paper capacitors were expensive and modern "dry" electrolytics did not then exist (yes, at that time they were actually filled with liquid electrolyte).

Lack of filtering was sidestepped in two ways: an ingenious but somewhat

touchy hum-bucking arrangement that fed an out-of-phase hum signal back to the 24 cathode. But largely, hum with dealt with by ignoring it, on the reasonable assumption that a small speaker in an average radio would not respond to 60 Hz anyway, nor would the output transformer pass it.

Here, then, was what Loftin and White presented to the world: a rather clever box of tricks that allowed a small radio to use a high-power 50 tube. This filled a need and might have been a modest success, had not fate (read "RCA") intervened with a better solution: a new tube.

RCA's answer to the audio-power dilemma was the 45 tube, not too small (71A), not too large (50), but just right. Usable on a low plate voltage, well within the capability of the full-wave 80 rectifier and practical electrolytics, two 45s in push-pull could produce enough audio volume for any reasonable radio set. RCA introduced the 45 in March 1929 and it immediately superseded the 71A and 50; some manufacturers even redesigned their models in mid-production to incorporate it before the Christmas selling season. By the time Loftin and White's IRE paper was presented in November, the 50 was history.

The natural response of Loftin and White was to revise their circuit for the 45, and indeed this is what they did, and what they showed in the *Radio News* articles. However, the 45 did not have the gas problems of the 50, and it was perfectly feasible to use it resistance-coupled; a circuit in fact had already been published in *Radio News* in December 1929! Loftin and White's clever box of tricks was now a pointless exercise, a fact they did not seem to appreciate. *Radio News* gamely promoted the circuit, but its readers were not fools, not all of them, nor were manufacturers. To eliminate one coupling capacitor, the Loftin-White needed a string of biasing resistors and a higher-voltage power supply, and was tricky to adjust. Only three or four commercial radio models were ever built with the Loftin-White circuit, and this may have been for patent-avoidance reasons as much as practicality.

The promotional activity did carry over to the Public Address field for a few years: from 1930 to 1933 Lafayette and other mail-order catalogs featured several Loftin-White amplifier models, but they were completely gone in 1934. Magazine articles fell off drastically once the *Radio News* editor found something new to

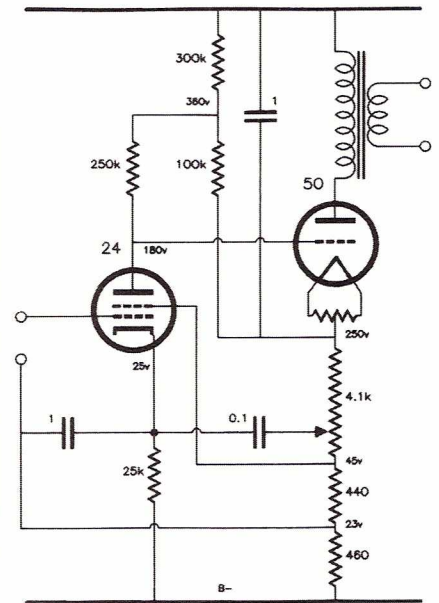

ORIGINAL LOFTIN-WHITE CIRCUIT

exploit (he owned a resistor-manufacturing company at the time) and by 1940 the Loftin-White was entirely forgotten. Textbooks never even mentioned it (there is not one reference in Langford-Smith!) and there are essentially no surviving examples.

Hardly a ripple - Except in Japan

Where did it go? What lily pad was it hiding under, all these years? We must backtrack once again, to Japan in 1929. The firm of Kinsuido (now Luxman) had been keeping abreast of American developments, importing some items and manufacturing adaptations of others, notably the Silver-Marshall style of "Unipacs" or combined power packs and audio amplifiers for attachment to radio sets.

Kinsuido also published the *Kinsuido Radio Book*, whose July 1930 issue stated that Kinsuido had developed a direct-coupled amplifier using the 24 and 50 in September 1929, and began importing "Durham" resistors from the International Resistance Co. in November. In January 1930 Kinsuido launched the "LUX661" Unipac with the 24, 50, and 81, followed by the LUX662 (24, 45, 81) and the LUX665 (24, 24, 45, 81). This seems like very fast work, but the timetable is not impossible. The RCA 24 was announced in May 1929, and not produced in Japan until 1930, but Tokyo Electric Co. was fully licensed by GE to make American tubes, and could well have had samples of the 24 in

1929, or some might have been brought back by a Kinsuido agent. Incidentally, Tokyo Electric combined in 1939 with Shiba-Ura Engineering Works to form today's Toshiba.

In June 1935 the LUX661A appeared, using the original Loftin-White circuit except that a 57 pentode replaced the obsolete 24. So while the Loftin-White was forgotten elsewhere, it was alive and well in Japan. More construction plans appeared soon after the war in one electronics magazine, and from time to time during the 1950s and 1960s. Direct coupling appears to have been re-introduced to the Western audiophile community from Japan when Jean Hiraga published "Le Circuit de Loftin et White" in issue no. 1 of *L'Audiophile* in October 1977.

Western Remnants of the Circuit

Yet Loftin and White had not been entirely forgotten in the West. Stromberg-Carlson built a commercial amplifier in 1953-54, the AP54-LW with four push-pull direct-coupled stages (12AX7-12AX7-6AS7-pp 811As) and there was also an AP100 with four 811As. Lack of any bias stabilization probably explains why it became the AP54-CC (capacitor coupled) in 1955.

In July 1948, British pipe-organ authority Rev. Noel A. Bonavia-Hunt published a circuit in *Wireless World* for a 20-watt direct-coupled amplifier (he did not use the term Loftin-White) using parallel DA30 triodes. He claimed great sonic benefits from direct coupling but did not seem bothered by the 8 mfd electrolytic coupling the DA30s to the output transformer. His circuit drew a fusillade from such readers as Peter Baxandall ("I do sincerely believe it desirable to do what one can to stop people building amplifiers of this kind"). Bonavia-Hunt

expanded on his theme in a book *High Fidelity Radio* (Bernards, 1952) but apparently had little further influence.

Modern Loftin-White Applications

In the March 1961 *Popular Electronics* Herbert I. Keroes, co-inventor of the ultra-linear circuit, published plans for a "Loftin-White" with 6BQ5s. Not surprisingly it used transformers and a printed-circuit board made by Acro Products, Keroes' company. Uncharacteristically for modern "Loftin-White" designs, Keroes did use one of the bias-stabilization schemes proposed in 1929, referencing the input 12AX7 grid bias to the 6BQ5 cathode current. Some less-informed modern constructors have copied the original circuit (except for the power supply!), even to the hum-bucking capacitor. However, well-designed direct-coupled amplifiers hardly resemble the original Loftin-White circuit at all.

Modern direct-coupled amplifiers can sound very good indeed, but what of the original Loftin-White? Many authors, among them Keroes in 1959, have claimed that it was better than previous designs, but we should remember that Loftin and White's own words were "smallest and cheapest." The way to find out was to build one. Duplicating the original circuit is easy enough, but I decided also to recreate the original appearance with authentic parts, an instant "collectors item" if you will, since no original examples appear to have survived. And I needed something to illustrate this article!

Building the Loftin-White Today

While several of Loftin and White's breadboard models were pictured in *Radio News* (some actually built on wooden boards as was common practice

of the day) there was no "definitive" example to copy of the 24-50-81 version, the one I wanted to build. And I wanted to limit myself to parts I already had on hand, partly to save time and effort, partly as a matter of honor (recall the proper Bostonian

ladies who, when asked where they bought their spring hats, snipped "We *HAVE* our hats".) After all, there has to be a reason for hoarding all this junk for thirty years, yes?

Ideally, I thought to myself, I should use Silver-Marshall parts since they were considered the best obtainable at that time, and were widely sold by mail order. But evidently I wasn't going to cannibalize a good piece of equipment to get some, so I began searching the junk in the shed until I found a derelict power transformer and filter capacitors still attached to a bit of sheet iron. A quick trial revealed two 7.5-volt windings, perfect for my amplifier, and even a 2.5-volt for the 24 tube. This was too good to be true, especially when cleaning off the rust and dirt left a very presentable specimen, but then on a hunch I went through some Silver-Marshall literature and found this exact item: the sheet iron had been the interior partition of a 1928 Silver-Marshall power pack. So the filter capacitors were also authentic! They proved too leaky to be trusted in actual use, so my major concession to modernity was to hide Mylar capacitors inside the old cans.

It didn't matter if the low-voltage bypasses leaked, so I chose two Tobe Deutschmann units imported from Germany in 1925. Tobe was a colorful character whose brother Arnold founded Radio Shack. He also imported excellent glass-sealed resistors, some of which I found, a real stroke of luck since good units of the right values that will withstand hundreds of volts without changing resistance are scarce. Molded carbon resistors had barely been developed in 1930, and I eventually had to use one made a couple of years later for the 25k cathode resistor on the 24. Finding the 5k wirewound by Electrad was another stroke of luck, as it was unused, with its protective cardboard sleeve, though I had to "borrow" some slider taps from other Electrads. The stamped Bakelite strip with input and output jacks came just as you see it (why would anyone save junk like this?) and even the oak board, complete with holes that I hid by careful parts arrangement, was a bit of office furniture my father brought home from the insurance company in 1945 (it runs in the family).

The output transformer is a story in itself. Finding one that will handle a 50 is no joke, and I wasn't about to dismantle my 1928 Zenith console. Besides, I wanted a Silver-Marshall, to give Loftin and White the benefit of the doubt on quality (but note that the output transformer was

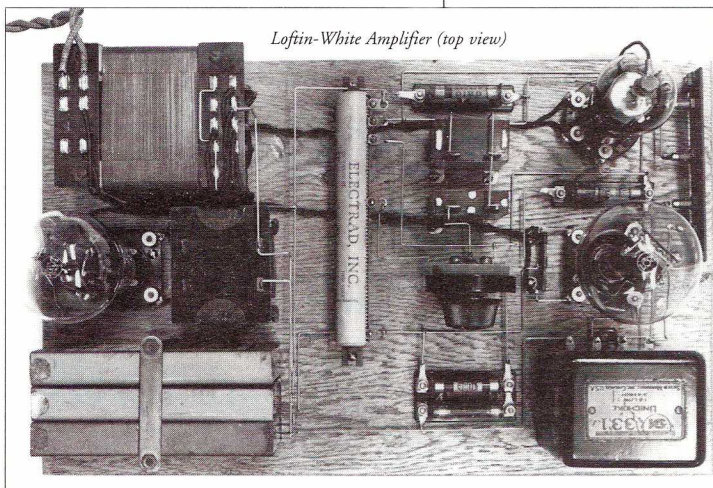

Loftin-White Amplifier (top view)

AMPLIFIERS

Heralding A New Departure in Amplifier Design

THE SMALLEST BUT MOST POWERFUL EVER BUILT
WEIGHS ONLY 11 1/2 POUNDS!

ONLY 9 in. LONG - 7 in. WIDE
Greater compactness, improved appearance, less weight, longer life, and lower hum voltage are but a few of the features built into the new Lafayette Loftin-White Amplifier. You will be surprised at the new brilliance of tone due to uniform amplification throughout the entire range of audibility. The high notes and the deep low notes are amplified with surprising fidelity.

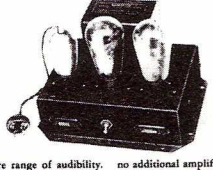

WILL HANDLE AN AUDITORIUM UP TO 1000 CAPACITY!
UNDISTORTED OUTPUT—5 WATTS

ABSOLUTE HUM MINIMUM AND SPECIALLY BUILT TO RIGID SPECIFICATIONS.
The profit making possibilities are unlimited. For phonograph or microphone amplification there is no equal to these superb units. When used with "mike" no additional amplifier is needed.

NOTE:
The Lafayette Loftin-White Amplifier is the only one of its kind that has been built in the United States. It is made in the U.S.A. by the Lafayette Radio Service Co., Inc., 35 Vesey St., New York City.

To further assure you that the LAFAYETTE LOFTIN-WHITE AMPLIFIERS ARE BETTER—we enclose a WRITTEN GUARANTEE against electrical or mechanical defects for one year from date of sale. Watt consumption 45 watts. Shipping weight 17 lbs. Uses 1-245, 1-224, 1-280. List Price, less tubes, \$55.00.
YOUR COST \$4.95

\$17.50 NET

NOTICE: All Lafayette Amplifiers are Licensed by Loftin-White Laboratories. NOTICE: No surplus parts go into the making of this Amplifier.

Pentode Loftin-White Amplifier
POWER — SAFETY
In this new Lafayette Amplifier, the pentode power tube has been substituted for the triode tube. This change has resulted in a more powerful and more efficient amplifier. For the same reason, the pentode tube is more rugged and longer lasting than the triode tube. The new Lafayette Amplifier is built to handle a load of 1000 ohms. The quantity of power made available to the speaker is increased. The amplifier has been completely redesigned to meet the requirements of a portable amplifier. It is now smaller and lighter than any other amplifier of its class.

250" Push-Pull Loftin-White Amplifier
The new Lafayette Amplifier is built to handle a load of 1000 ohms. The quantity of power made available to the speaker is increased. The amplifier has been completely redesigned to meet the requirements of a portable amplifier. It is now smaller and lighter than any other amplifier of its class.

The Most Powerful Direct Coupled Amplifier Built
With the presentation of the new, small, 250 PUSH-PULL Direct Coupled Amplifier, the Lafayette Radio Service Co., Inc. has introduced a new type of amplifier. This amplifier is built to handle a load of 1000 ohms. The quantity of power made available to the speaker is increased. The amplifier has been completely redesigned to meet the requirements of a portable amplifier. It is now smaller and lighter than any other amplifier of its class.

Inexpensive Loftin-White Direct Coupled AMPLIFIERS
In answer to a demand for a direct coupled amplifier that could be used in the home, the Lafayette Radio Service Co., Inc. has introduced a new type of amplifier. This amplifier is built to handle a load of 1000 ohms. The quantity of power made available to the speaker is increased. The amplifier has been completely redesigned to meet the requirements of a portable amplifier. It is now smaller and lighter than any other amplifier of its class.

Samson Amplifiers
The new Lafayette Amplifier is built to handle a load of 1000 ohms. The quantity of power made available to the speaker is increased. The amplifier has been completely redesigned to meet the requirements of a portable amplifier. It is now smaller and lighter than any other amplifier of its class.

Percent "250"
The new Lafayette Amplifier is built to handle a load of 1000 ohms. The quantity of power made available to the speaker is increased. The amplifier has been completely redesigned to meet the requirements of a portable amplifier. It is now smaller and lighter than any other amplifier of its class.

Genuine Percent Product
The new Lafayette Amplifier is built to handle a load of 1000 ohms. The quantity of power made available to the speaker is increased. The amplifier has been completely redesigned to meet the requirements of a portable amplifier. It is now smaller and lighter than any other amplifier of its class.

Compare this price for a 250 Push-Pull
The new Lafayette Amplifier is built to handle a load of 1000 ohms. The quantity of power made available to the speaker is increased. The amplifier has been completely redesigned to meet the requirements of a portable amplifier. It is now smaller and lighter than any other amplifier of its class.

WHOLESALE RADIO SERVICE CO., INC., 35 VESSEY ST., NEW YORK CITY

underfiltered half-wave supply is atrocious. It measures 26 dB down, or 5%, tolerable on 1930 speakers but all too annoying on modern ones. Especially when using the Silver-Marshall "Unichoke" as an output transformer, with its good bass response: down 6dB at 40 Hz and 6 kHz. The Silver-Marshall 221 output is 6 dB down at 80 Hz and 11 kHz. 1 kHz harmonic distortion with the Unichoke is 6% at 1 W into 10 ohms. With the 221 it is 8% into 1000 ohms, mostly second harmonic, 1.3 % third. These figures would improve at a higher B-plus and by re-biasing the tubes, but the hum won't go away. Even adding another 22 mfd of filtering (no electrolytics, remember, at 500-plus volts) the hum is audible, and this is with a real 30-Henry choke (measured at the 37

Hunt's book, while Russ Hudon found the Stromberg-Carlson schematics.

Particular thanks to two correspondents: Desmond Thackeray pointed out that Loftin and White came close to inventing bootstrapping, long before anyone else, and could have applied it to increase the apparent impedance of the grid-return resistor. But they abandoned it without ever realizing what they had, by bypassing the 50 cathode to B-plus.

Nobu K. Shishido (Shishido Koichi) has also built a modern replica of Loftin and White's original circuit, with much the same result: decent performance but intolerable hum. His findings, and a description of the Loftin-White brought up to present-day audiophile standards, are in MJ magazine for February 1996. Shishido-san obtained the Lux historical information from the present-day Luxman firm, as well as other material on the post-war Japanese stereo scene.

Bibliography

- Radio News Nov. 1926 pp. 504-506, 585 Clyde Fitch Battery-coupled circuits. Fitch states that capacitors above 1 mf are too leaky for resistance-coupled amps.
- Proc. I.R.E. March 1928 pp. 281-286 Loftin & White Bias stabilization in direct-coupled amplifiers (battery-powered tubes only).
- Radio News Jan. 1930 pp. 600-602 Loftin & White Schematic without parts values.
- Radio News Feb. 1930 pp. 704-705, 763-765 Loftin & White Circuit data.
- Radio World Feb. 1, 1930 pp. 8-13 J. E. Anderson (technical editor) Some earlier circuits by Arnold (1915), Hartley, Morgan (1929), Johnston (1928), Parls (1928).
- Radio News March 1930 pp. 801-802, 873-874 Loftin & White Circuit data.
- Radio World March 8, 1930 pp. 12, 13 J.E. Anderson Practical circuit data, adjustment.
- QST March 1930 pp. 37-40 George E. Fleming (Loftin-White Laboratory) Practical, details of the original circuit.
- Radio News April 1930 pp. 890-891, 967 Loftin & White Adding the L-W circuit to a radio.
- Proc. I.R.E. April 1930 pp. 669-682 Loftin & White the original circuit and development process.
- Radio News May 1930 pp. 1004-1005, 1054-1055 Loftin & White Miscellaneous notes, illustrations of Electrad, Amplex, Lafayette models.
- Radio Craft May 1930 pp. 584-586 Basic principles.
- Radio News June 1930 pp. 1104-1105, 1146-1147 Loftin & White An unbalanced push-pull circuit, and another using a 50-watt tube on 1250V.
- Radio News June 1930 pp. 1115-1116, 1157 George E. Fleming (Loftin-White Laboratory) History, including patent 1,112,655 of G.W. Pierce issued Oct. 6, 1914 and 1,129,943 of H.D. Arnold, filed March 28, 1914, issued March 2, 1915.
- Radio Craft June 1930 pp. 646-647, 661 More basics;
- Radio Engineering June 1930 pp. 63-64 Original circuit.
- Radio News July 1930 pp. 34-35, 74 Loftin & White More on push-pull. Lab photos.
- Radio Craft July 1930 pp. 39-41 David Grimes Variations.
- Radio News Aug. 1930 pp. 114-115, 180-181 George E. Fleming PA system, no schematics.

considered "part of the speaker" and not included in the published frequency-response curves, a neat bit of chicanery). In the barn I recalled seeing a Silver-Marshall whatsit, that on inspection proved to be a dual choke with high- and low-resistance windings. Intended for a tuned B-Plus filter, it was also recommended in the catalog as an output device! In fact, with its air gap, it is perfect as a single-ended output transformer, and its optimum match is into 8 to 10 ohms. I have since been given a real Silver-Marshall output transformer, also from the 1928-1930 period, that matches 1000 ohms, the impedance of a Western Electric 540AW cone speaker, one of the best available for home use then. Performance of the two output devices is comparable, as we shall see.

Auditioning the Loftin-White

So who do we believe, Loftin and White or the modern writers? You guessed it, "smallest and cheapest" wins hands down. It sounds all right, if you don't mind 6 to 8% second-harmonic distortion at 1 watt out (the clipping point at the rather low 500 volts B-plus I'm stuck with). But the hum from the

MA operating current). Much of the residual hum is from the direct-coupled 50.

What killed the Loftin-White? Later writers claimed it was too tricky to adjust, no snap even with Tektronix scopes and Fluke DVMS of today. But mainly it was economics. To eliminate one coupling capacitor, the Loftin-White required a long string of biasing resistors, several bypass capacitors, and a high-voltage power supply with expensive filters. The same can be said of modern direct-coupled designs too: they eliminate one coupling capacitor, but still contain two or more bypassed resistors which are just as surely in the signal path, along with the power supply. We won't even mention the output transformer, except to marvel at how tube fans can make a virtue out of necessity. Now that the fundamental rationale for direct coupling—coping with the flawed 50 tube—is gone, the words "pointless exercise" come to mind again.

A number of friends have contributed bits and pieces for this project. Mark Oppat (Antique Audio, Plymouth, MI) sent me the 221 output transformer. Philip Taylor supplied a copy of Bonavia-

Radio News Sept. 1930 pp. 226-227, 281-282 George E. Fleming Radio using L-W audio amp.

Radio Craft Sept. 1930 pp. 156-157 Morton W. Sterns (president of Cresradio, supplier of the resistors specified) Original circuit but wrong resistor value.

Radio News Oct. 1930 pp. 322-323, 383 George E. Fleming More on the radio circuit.

Radio Craft Dec. 1930 pp. 354-355 S.H. Burns Original circuit.

Radio News Jan. 1931 pp. 614,667 George E. Fleming Sterling midget (cathedral) radio radio using a Loftin-White audio circuit.

Radio News Feb. 1931 pp. 701, 736 Loftin-White with 2v battery tubes.

Radio News Jan. 1932 pp. 587-588, 616 George E. Fleming, (now with Electrad, Inc.) Minor improvements on the original circuit by Electrad.

(book) Radio Engineering Handbook, Keith Henney, ed. 1933 Chapter on audio amplifiers by Julius G. Aceves shows a simplified circuit with no bias on the 2A.

Radio Craft Aug. 1933 pp. 80, 81, 111 L.M. Barcus Lots of circuits but nothing practical.

Radio Craft Sept. 1933 pp. 154-155 L.M. Barcus More impractical circuits.

Radio News May 1937 p. 660 Gerard J. Kelley (formerly an engineer with Loftin-White Laboratory) Aceves' circuit (Henney 1933) but 1.5V cell added for bias.

Radio Craft Mar. 1937 pp. 534,557 April 1937 pp. 601, 622 July 1937 pp 36,62. A. C. Shaney (Amplifier Co. of America) Direct-coupled push-pull 6L6 amplifier. Uses a special output transformer, and appears to be unbalanced.

Radio News Aug. 1937, pp. 89, 128. G.J. Kelley Push-pull 2A3s or 6A3s, poor balance.

Radio Craft Aug. 1937 pp. 91, 124 Australian circuit uses 2A6 - 2A3. Very simple.

Radio News Dec. 1937 pp. 336-337, 382-383 Triode-connected 6L6, capacitor-coupled to output transformer.

Radio Craft Aug. 1939 pp. 16-18, 57-59 A.C. Shaney Push-Pull but has no phase splitter, requires input transformer.

Radio Craft Oct. 1939 pp. 202-203, 234-235 A. C. Shaney Higher power, more frills, but still has no phase splitter.

This bibliography includes all of Loftin & White's own publications, and other magazine articles on direct-coupled power amplifiers based on their work. It does not include any direct-coupled instrumentation amplifiers or preamps, or the so-called mu-follower. Neither does it include any references to direct-coupled dual triodes in one envelope, such as the original Triple-Twin or its descendants 2B6, 6B5, 6N6, etc. which couple the driver cathode to the output-triode grid. None of the references listed in this bibliography is in Langford-Smith, Radiotron Designer's Handbook, 4th ed

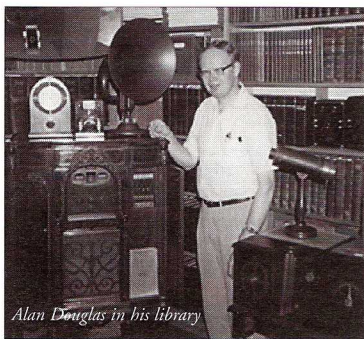

Alan Douglas in his library

Alan Douglas, based in Pocasset, Massachusetts, is an electrical engineer and author of *Radio Manufacturers of the 1920s*, a three-volume set detailing early American radio manufacturing. He has also an established electronics historian with published articles in the *AWA Journal*, *Antique Radio Classified* and several other related publications.

The Power Kings: 6550 and KT88

By Eric Barbour

Power is critical to the growth of high fidelity as a market. It's easy to stick a label on an amplifier with a big wattage number, and it SELLS. Ever since the early 1950s, consumers have been told to seek more power when looking at components, whether separates or receivers. The fact that speaker efficiency is just as important, or that average bass-reflex speakers will give plenty of loudness with only 30 watts per channel, is of no importance in this power war.

1. History

In the halcyon days of hi-fi, getting more than 30 watts was relatively expensive. It required at least four 6L6Gs at typical 300-400v plate voltages, or transmitting tubes at much higher voltages. Even though a pair of 807s would do the job, the plate voltage would have to be more than 550--this usually required oil capacitors in the power supply, plus more expensive transformers that were rated for such operation. The price added up, and by the time the customer has paid for a tuner, turntable, speaker, and the mandatory cabinet, there isn't much left for a transmitting-tube power amp.

There was unquestionably a strong desire for such products. Construction articles in *Audio Engineering* in the 1948-1954 time frame often featured large tubes. The *Audio Anthology* books, volumes 1 thru 3, contain 21 amplifier construction articles, of which one used 211s, two used 807s, one used 845s, and one used the type 6146, which was new in 1952. The vast majority of the amp circuits were good for less than 15 watts, which most people thought was plenty. The transmitting-tube circuits must have been seen as luxury projects intended only for the serious "audio bug". Such amps were NOT available from early hi-fi dealers.

Power was the need, even though most people were using relatively efficient speakers and horns were at the peak of popularity. Bear in mind that these users were nearly all middle-aged men who listened primarily to classical music; hi-fis weren't used for rock'n'roll until the late 1960s. They must have been desperate for louder crescendos, perhaps to drown out the wife's TV shows?

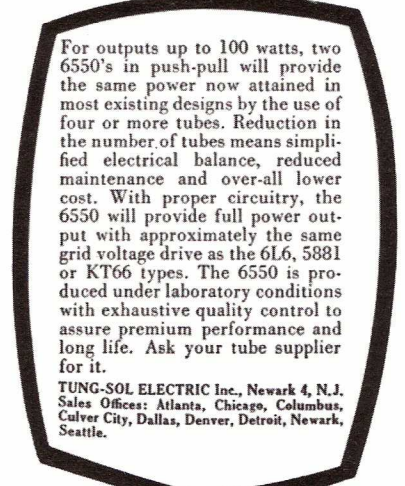

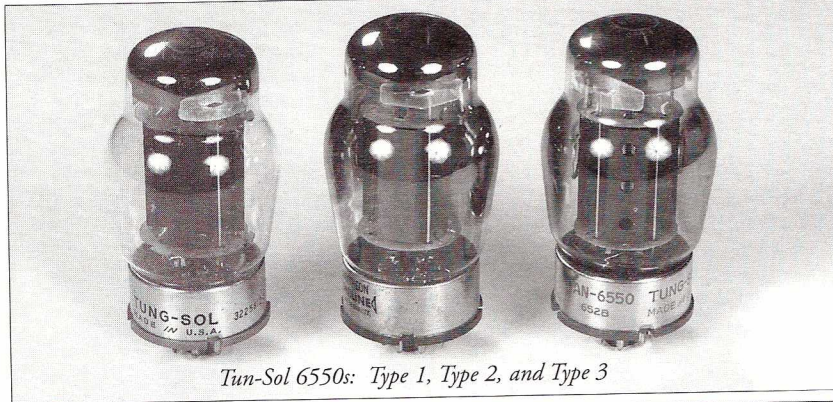

Tun-Sol 6550s: Type 1, Type 2, and Type 3



GE 6550A, Tung-Sol 6550 and Svetlana 6550C

The RCA 6146 was a landmark tube in some ways. It was rated to take 750 volts on its plate, and a pair was good for 100 watts. Its main application was compact amateur radio transmitters and a few theater/PA amps. Its relatively high cost meant that it never saw commercial use in hi-fi. The only major audio amps to use it were the Altec 1530 and a few versions of 1950s RCA public address amplifiers. And the only well-known musical instrument amp with 6146s was the early Ampeg SVT bass-guitar amp, introduced in 1964, well after the time period we are covering. The SVT is my candidate for heaviest amplifier in the world, at least it FEELS like the heaviest. It puts out 300 watts into 4, 8 or 16 ohms, and requires an enormous speaker. (The standard SVT speaker set-up was two cabinets, each with eight-10" speakers!)

Obviously there was a demand for a tube that could do more than 50 watts, with low distortion, at a cost below that of the 6146. Mullard's EL37 could do it but was about as expensive as the 6146.

A need existed, and it was fulfilled in February 1955. And it wasn't done by a giant like RCA, or GE, or Sylvania. It was done by Tung-Sol, a medium-size tube manufacturer in Newark, New Jersey. The 6550 appears to be heavily

influenced by the 6146, but is clearly intended for audio. This was probably the power tube that started the power wars.

The 6550 was designed for home audio equipment, and it was designed to save money. No plate cap meant no plate cap connector, with the added advantage of less risk of electrocution to the user when replacing tubes. A large octal base with a metal ring at cathode potential was another safety feature which also improved electrical stability. Tung-Sol engineers had a distinctive envelope made for the tube, derived from the older "ST" shape. This squat, rounded "Coke bottle" appearance set the tube apart from the crowd. It might have been a marketing ploy, I suspect--it makes the tube LOOK powerful and tough.



Shuguang/ECG 6550

And indeed it is. With rated plate dissipation of 35 watts in tetrode and 40 watts in triode, the advertisements bragged that "two 6550s in push-pull will provide the same power now

attained in most existing designs by the use of four or more tubes." Thanks to the large low-loss base with molded-in dams between the pins, to discourage leakage currents, the 6550 was rated for 600 volts on the plate and 400 volts on the screen. It had about twice the transconductance of the 6L6 types, so it could produce 100 watts with about the same drive voltages as the 6L6s. The grids of the 6550 were gold-plated and carbonized, to prevent grid emission and bias runaway. The result was more like a transmitting tube, but at receiving-tube prices.



Altec 340A

Like its grandfather, the 6L6, this tube was an instant hit. Numerous hi-fi amps began to use it, the first being the 40 watt Altec 340A amplifier in 1955. Later applications included the McIntosh MC60, Heath WM-6, Fisher 55A (early version), Scott LK-150 (stereo). The 6550's toughness and low cost caused it to be used by engineers in applications like servo amplifiers for computer tape drives. Because its cathode was clearly rated to produce 175 milliamps, it became popular as a pass tube in regulated power supplies. A 6550 could produce nearly as much current as a 6AS7, and with greater regulation effectiveness and reliability. There are at least three distinct variations of the Tung-Sol 6550: Type 1 - top getter only and no holes in plate; Type 2 - top getter and holes in plate and Type 3 - Top and side getter with holes in plate (many of this version are marked Raytheon, RCA, Sylvania, etc.) Generally, there are no significant sonic differences in the three versions, although the Type 1s are more sought-after by collectors.

For many years, Tung-Sol's version was seen as one of the best power tubes on the market. But, in 1957, a competitor appeared from England. The Marconi-Osram Valve Co. of Hammersmith, London, which already made and sold the KT66 and KT77 beam tubes under the Genalex name (in America), introduced the imposing KT88. Its improved ratings made it a



Cetron KT88 and Genalex KT88

popular substitute in hi-fi amps. The first version of the KT88 was shaped in the ST style, similar to the Tung-Sol 6550. This short-lived version was soon replaced with distinctive shouldered-barreled envelope.

The first popular British amp to use the KT88 was the 50 watt Leak TL50+ in 1957. The first popular American amplifier was the early Dyna Mark III. Other notables were the Harman-Kardon Citation II, McIntosh MC75 and MC275. And one of the largest guitar amps ever made, the Marshall Major of



Genalex KT88 and Shuguang KT88

1967, used four KT88s at 650 volts to deliver 200 watts. Although the 6550 was a tough tube, operation at above 550 volts in triode, near-triode or ultralinear connection was very hard on it. The KT88 could handle those operating conditions very easily.

By the 1960s, these tubes had set the standard for power amplification. So it was inevitable that other makers would introduce their own versions. GE came out with the straight-sided 6550A in 1971. It was called 6550A, because of the introduction of an exotic 5-ply metal plate material manufactured by Texas Instruments. This metal, produced by cladding a copper and iron core with aluminum outer layers using explosives,

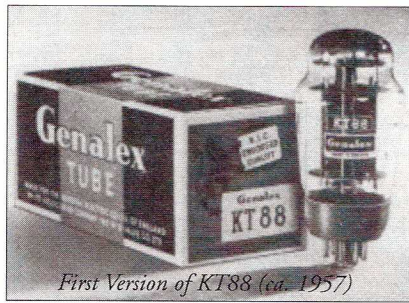

First Version of KT88 (ca. 1957)

made for a more reliable tube with greater bias stability. The clad metal was better at dissipating plate heat, and it thus lessened plate and grid emission and reduced hot spots on the plate.



Leak TL50+

The early KT88s suffered from this, so they were built with clad plate metals until the cessation of tube production at MOV. There were two versions of the GE 6550A; earlier ones had rough-looking spot welds on the plate, while from about 1979 the plates were stamped and swaged. There doesn't seem to be a major difference between these versions, although the overall quality declined during the 1980s. In 1984 GE spun off their electron-tube division into a separate company called MPD, which continued to produce and sell tens of thousands of 6550As each year until 1991.

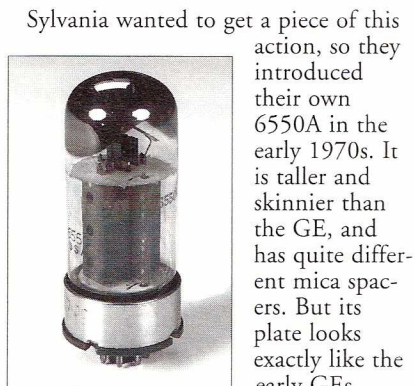

Sylvania 6550 (marked RCA)

Sylvania wanted to get a piece of this action, so they introduced their own 6550A in the early 1970s. It is taller and skinnier than the GE, and has quite different mica spacers. But its plate looks exactly like the early GEs, complete with rough-looking spot welds. In fact, it looks suspiciously like a Sylvania 6L6GC or 6CA7 with a large metal-ringed base. Some experts



Groove Tubes/Teslovac KT88

claim that this tube was made by GE under contract, and a few are insistent that it never existed at all! Yet I recall seeing it occasionally in guitar amps during the 1980s. Sylvania apparently had such difficulty competing with GE for this market that production ceased in the early 1980s; I don't recall seeing any that were date-coded after 1984. Many were rebranded and sold by RCA and Westinghouse.

Table 1:

ESCALATION OF 6550-TYPE TUBE RATINGS OVER THE YEARS (absolute maximums when given, all assuming tetrode connection)

Type	F_p	E_{g2}	P_d
6550 Tung-Sol, 1955	600	400	35
KT88 Genalex, 1958	800	600	42
6550A GE, 1970s	660	440	42

The 6550 and KT88 were extremely popular in high-end amplifiers during the 1970s and into the 1980s, including nearly all the models produced by Audio Research, Conrad-Johnson, Theta and MFA. The Jadis amps, which appeared in 1983, were designed around the KT88 and operated their KT88s in Class A, at the limits of their dissipation. Even more extreme is the humongous Carver Silver Seven, with its fifteen 6550s per side (fourteen in push-pull parallel with one more as a screen-grid regulator) and 375 watts output.

For a time, all Marshall guitar amps imported into the USA were equipped with 6550As instead of EL34s, for greater reliability. However, Marshall switched back to EL34s in the Eighties because their amps using 6550As did not have the classic Marshall "crunch" sound that so many players demanded. And the numer-

6550 and KT88 Listening Tests

For our listening evaluation of these tubes we used a Dynaco CDV-Pro tube CD fed directly into a restored Scott LK-150 power amp and Klipsch Chorus 1s.

GE 6550A - Balanced, fat, rich mids but softer bass and not as punchy or detailed as the Svetlana 6550s.

Svetlana 6550B - (discontinued) Detailed, slight glare (shows digititis), good, solid bass and competent, but slightly recessed mids.

Svetlana SV6550C - Strong, deepest bass, more detailed than GE, but a little harder sounding on the highs.

Sylvania 6550 - Big, smooth mids, but softer bass and rolled off highs. Like a big EL34.

Tung-Sol 6550 - Detailed, even tonal balance, good bass, but not as much deep bass slam as the Svetlana SV6550C.

Cetron KT88 - A lot of dynamic range, balanced, great bass, rich mids, but somewhat hard treble.

Genalex/MOV KT88 - Balanced and natural with good, strong bass. Excellent on female vocals. Rich detail and extremely musical.

Groove Tubes/Teslovac KT88 - Balanced and warm sounding with smooth highs, but not as much high-end extension as MOV KT88s. Balanced bass similar to a Tung-Sol 6550.

Shuguang/Chinese KT88 - Minimal bass, weak midrange with harsh and sibilant highs. Lacks any depth, two dimensional.

Best Sounds:

6550 - Hands down, the old reliable Tung-Sol comes out on top for its balanced, musical sound.

KT88 - The Genalex/MOV is the best there is. The most musical with effortless, rich tonal balance.

Best Buy - The Svetlana SV6550C is the best buy because it is powerful, durable and has the strongest, deepest bass. A good replacement tube for high-end amplifiers at a bargain price.

ous Mark IIIs still in service kept these tubes popular, not to mention McIntosh MC60s, MC75s, MC260s, MC275s, Heath W-6s, Peavey's VT series of guitar amps, Ampeg's later SVTs and most of their V-series, some Fender PA amps, the Hiwatt 400, the Mesa-Boogie Bass-400, and various models by Sunn, Rissn, Sound City, and Sundown. Ampeg switched the SVT to 6550s around 1970, probably for cost reasons. And I haven't even mentioned the thousands of high-voltage regulated power supplies that used 6550s as pass tubes, including models by Dressen-Barnes, Kepco and Lambda.

Unfortunately, good things come to an end, especially when someone offers a cheaper version. Tung-Sol stopped making tubes in the late 1970s, Sylvania in 1988, and MPD made its last 6550A in July 1991. This latter was partly brought on by the appearance in the 1980s of the cheap Shuguang 6550. It was and is known to be inferior in most ways, and short-lived due to poor cathode materials. But it looked like a Tung-Sol, and unscrupulous dealers were willing to rebrand it with any number of old, classic brandnames. (Beware of Shuguang 6550s bearing Amperex and Philips brands.) It

pushed out competition, since it was about one-half the price of the GE/MPD 6550A. Eventually people realized what was going on, but by then it was too late.

Shuguang offered a KT88, which turned out to be just their 6550 in a large cylindrical envelope that was more-or-less shaped like a KT88.

It too was inferior, but MOV/Genalex stopped making KT88s in 1988 anyway. Since some honest distributors, such as RAM Labs, Groove Tubes, and Audio Classic/R&G, had gotten so many Shuguang 6550s and KT88s returned by consumers, they pushed for Shuguang to improve their quality. This happened, but not adequately to meet the severe demands of amps like the Marshall Major and the Jadis JA-200 and JA-80. The increasing popularity of tube hi-fi in the 1990s has caused OEMs to demand better stuff. This resulted in the National/Richardson KT88, the "Golden Dragon" 6550 and KT88, and the Svetlana 6550 and Teslovac KT88. This is why we decided to test some of the 6550/KT88 types that are generally available.

3. Tests

All tests were performed at 500v, 75 mA, in pentode connection with 300v on the screen grid. Plate load was 3200 ohms and the grid resistance was 47k ohms. Note that many of the NOS samples represent many years of manufacture. The Tung-Sol samples here cover nearly 20 years of production, and the MOVs, GEs and Sylvania's were various samples from 10-20 year production time frames.

Table 2.

6550/KT88 Distortion, @500 V Pentode (arranged by increasing distortion)

Type	Dist %	# Samples
1. Sylvania 6550	0.527%	7 (5 gd used)
2. TungSol late	.615	7 (4 gd used)
3. MOV KT88	.616	14 (gd used)
4. TungSol 2-getter	.620	4 (gd used)
5. TungSol top getter	.623	17 (gd used)
6. Svet 6550B	.633	6 (out of production)
7. EI KT90	.647	3
8. Svetlana 6550C	.653	4



Late Gold Lion KT88 Box, KT88 and Early Gold Lion Box

9. GE 6550A	.655	4 (3 gd used)
10. Shuguang KT88	.665	4
11. Tesla KT88S	.670	2
12. Shuguang 6550	.690	2
13. Svet 6550B3	.746	5 (out of production)

Table 3.

Peak Power Test, 500 V Pentode (arranged by decreasing peak voltage)

1. Svetlana 6550B16.67 volts
2. Svetlana 6550B316.33
3. Svetlana 6550C16.25
4. Tesla KT88S16.00
5. TungSol late15.75 (tie)
5. GE 6550A15.75 (tie)
5. Shuguang 655015.75 (tie)
6. MOV KT8815.57
7. TungSol top getter15.38
8. Shuguang KT8815.25
9. TungSol 2-getter15.13
10. Sylvania 6550A14.93
11. EI KT9013.80

Summary:

Tung-Sol's 6550 is still the best in overall performance. It was made with the kind of care that is rarely seen now. In 1961, Harman-Kardon sent a letter to its dealers, telling them that the Tung-Sol was superior to the KT88 for grid current, thus making its bias point more stable in the H-K Citation II amplifier; so they recommended against putting KT88s into Citation IIs.

Tung-Sols were ridiculously common ten years ago, and many were crushed by scrap dealers along with the power supplies they were usually in. Now, NOS examples in original blue-and-white Tung-Sol brand boxes can bring \$100 or

more. Even NOS units in white military surplus boxes are hot. RCA, GE, Raytheon and Sylvania were all remarking and selling Tung-Sols in the 1950s and into the 1960s, so some will turn up with these other major brands on them.

In spite of Harman-Kardon's complaint, the original MOV KT88 is an excellent tube. It is rated to take more voltage and dissipation than any 6550. This applies only to the original MOV/Genalex/Gold Lion version, and NOT to the current Shuguang version sold by most dealers. The Shuguang looks like a small imitation of the MOV with a 6550 structure inside.

NOS KT88s are very, VERY hot on the market, and can bring \$350 each if new in the original box. Factory-matched pairs, recognizable by the paper band around both cartons, have been known to sell for \$800 in the USA. Rumors abound that MOV will start making KT88s again soon--I've heard this for 2 years now, and have yet to see product. They're gonna have serious competition from Teslovac.

The old Sylvania's were provided by Terry Buddingh of *Guitar Player Magazine*. It seems that hi-fi users rarely see these, but guitarists sometimes have a few old ones kicking around. Note their extremely low distortion. Ironic that this tube was used in guitar amps, yet would be more suitable for high-end amps. The peak power was lower than for any other NOS type, which tends to indicate that it may have been another tube type which was modified for 6550 duty. Similarly, the EI KT90 is said to be derived from the PL509, a TV sweep tube. In any case, the Sylvania 6550A is definitely a scarce collectible today, and NOS pricing will be extreme. It's been more than 6 years since I saw one, and Terry's old stash brought back some memories. As far as current production goes, the Svetlana 6550 seems to be the best quality. Three versions were tested: the plain B has a flash getter, the B-3 has two pill getters (the latter is more effective at preventing gassing), and the C had both. All three use a clad plate metal which is apparently different from the GE 6550A metal. These Russian tubes have more peak power than any others; this is due to good processing during evacuation, plus quality cathode materials. The B versions had some reliability problems, so only the SV6550C version is being sold today, which has only a flash getter. As I've noted in the distortion table, the B and B3 are out of production. These tubes might still be available from some dealers, so be sure that you are getting the

SV6550C version. The getter arrangement was not the problem--the B and B3 had bias instability in some samples and some quality-control issues. The SV6550C uses carbonized and gold-plated grids, like the original Tung-Sol.

The Shuguangs are acceptable, and no real problems were observed, so quality control is better than it was a few years ago. We burned one in on a life-tester with some other types for comparison, the results will be posted in a future issue of VTV. Still, I can't recommend Shuguangs for triode connection or for dissipation above 30 watts due to continuing problems with processing. They are cheap tubes, and some very questionable dealers are putting all kinds of brands on them. The Shuguang KT88 doesn't look like the MOV, but the 6550 is very similar in appearance to later Tung-Sols with 6 plate holes. Shuguang's glass containers have a noticeable green/brown discoloration (recycled beer bottles?), and getter flashes in their tubes tend to be excessively large compared to the original American and European versions.

EI's KT90 is known to be a good tube, and is popular with audiophiles who have used Shuguangs in the past (and been dissatisfied). This tube is a modified TV sweep tube, and it is usable in a 6550 amp. But it is not a true 6550, nor will it sound like a 6550. Unaccountably, our samples had very low distortion at 300v triode, much lower than any of the other types could do. But since these tubes are never run at such low voltages, real-life results do not appear here. EI's KT99 is just a selected KT90, so none were tested here. The future availability of EI tubes will improve now that the embargo is over and Edicron is distributing their products. The Shuguang KT99 and KT100 are new, we know nothing about them yet. We will try to get samples soon. Teslovac's KT88S appeared in April 1996. We got two samples from Terry Buddingh of *Guitar Player*. These both had Groove Tube logos, which is not surprising as GT's Aspen Pittman is a part-investor in Tesla. The KT88Ss did well in my 500v pentode test, and I ran one at 100 mA without any problems at all. This level of dissipation might be death to a Shuguang tube, and most other 6550s would show red spots on their plates. So Tesla has an excellent product here and I hope that it is successful.

The Sovtek 6550, which was sold during 1992 and 1993, was made (briefly)

KT88 by **Genalex**
a high power tube
designed for the new
low distortion amplifiers

KT88 New high power version of the original KT66. A smaller, more powerful tube for highest possible performance with lowest distortion. For the manufacturer; an impressive sales point, a key to customer satisfaction, a valuable component for high power amplifiers. For the individual; a longer lasting, economical tube to increase day-to-day listening pleasure. Delivers up to 100 watts per pair, fits standard octal socket, same pin connections as KT66 and 6L6 tubes.

For full information, write Dept. XD-29, BRITISH INDUSTRIES CORP., PORT WASHINGTON, NEW YORK

by Svetlana. Since the Sovtek dealers can no longer obtain this tube, it was not available for this test. If Sovtek manages to find another factory to produce 6550s, they will be tested as soon as samples can be obtained. It seems that Sovtek distributors may just be carrying the regular Svetlana product in the future rather than a specially-made version, due to financial difficulties at the Reflector plant that was making "Sovtek" tubes.

We received four samples of the Richardson National KT88s from Richardson's Jerome Czakowski. Their electrical test results were good, and their sound was excellent. These tubes apparently are not in production at this time, although plenty of stock exists in Richardson's warehouse. These tubes are more expensive than any of the other currently-produced types, and are similar in price to NOS Genalex KT88s. If you have money to burn, want top quality, and can't find any NOS, the Nationals would fill the bill.

4. Outro

The 6550 will be available for the conceivable future. It is a massively popular type, and there are probably hundreds of thousands of sockets for it in the world. Its future was looking bleak when GE/MPD stopped production in 1991, but the Svetlana version and the new KT88s are proof that the Power Kings will live on into the 21st century.

Acknowledgements

Thanks to John and Charlie for most of the old 6550 and KT88 samples, and to Terry Buddingh for the Sylvania's and Teslovac. Also thanks to Aspen Pittman of Groove Tubes, Jerome Czakowski of Richardson Electronics, Svetlana Electron Devices and Antique Electronic Supply for sample tubes.

The Audio Test Bench

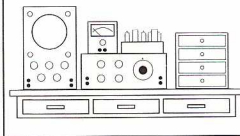

by
John Atwood

Oscilloscopes, Part 1

We have now reached the point in our Audio Test Bench series where we will cover one of the most useful, yet complex test instruments for audio work: the oscilloscope. By providing a two-dimensional view of signals, rather than the one-dimensional view from meters, you can gain a much better understanding of circuit behavior. Due to the large number of uses for oscilloscopes, this article will be broken into two parts: theory and oscilloscope descriptions in this issue, and oscilloscope applications in the next issue.

Theory

The heart of an oscilloscope is a cathode ray tube (CRT). This is the same kind of tube used in televisions and computer displays, but for laboratory oscilloscopes, nearly always has electrostatic deflection rather than magnetic deflection. The CRT moves a beam of electrons across a fluorescent screen under the influence of the electrostatic deflection plates. These plates are placed at 90° angles, and so allow the beam to be deflected horizontally (in the X-axis) and vertically (in the Y-axis). Thus it allows a two-dimensional representation of electronic signals. There are some applications where just this X-Y display is needed. However, the real power of the oscilloscope is when a sweep circuit is added to the horizontal axis. A sawtooth wave sweeps the beam from left to right at a constant speed. The screen thus shows a plot of the vertical signal versus time. From AC circuit theory, the two main ways of representing any transient or recurring signal is either by time or by frequency. The oscilloscope gives a convenient way of displaying a signal by time. (The spectrum analyzer, to be described in a future article, displays a signal by frequency).

The block diagram of a basic oscilloscope is given in figure 1. The signal from the vertical input is amplified and applied to the vertical deflection plates in a push-pull fashion. Push-pull is needed here to keep the focus of the beam even as it is deflected. Low-cost oscilloscopes usually have AC (capacitor) coupled vertical and

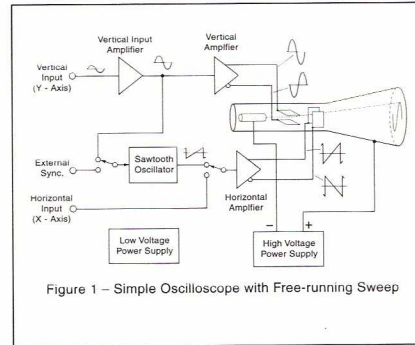

Figure 1 - Simple Oscilloscope with Free-running Sweep

horizontal amplifiers. This is cheaper and more stable than DC-coupled amplifiers, but severely disrupts the display of non-repetitive signals, such as seen in digital logic. DC-coupled amplifiers, though, need balance controls to compensate for component tolerances and drift.

A free-running sawtooth oscillator is applied to the horizontal deflection plates. Since this provides a constant sweep over time, this is also called the timebase oscillator. A portion of the vertical signal is forced into the sawtooth oscillator where it tends to synchronize the oscillator to the vertical signal. This form of injection locking is fairly primitive, and only works well on well-defined, repetitive signals. A switch is provided to allow an external signal to synchronize the timebase. The timebase can be disconnected so that the horizontal amplifier can be driven by an external signal, letting the scope show an X-Y display.

The high-voltage power supply accelerates the electrons from the electron gun to the screen. On small or low-speed oscilloscopes this voltage can be 1000 to

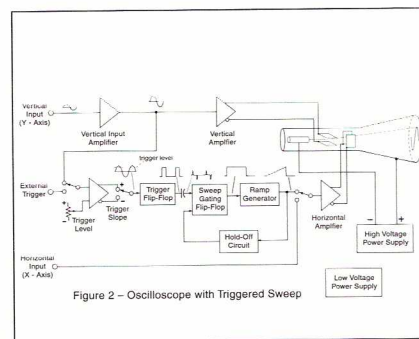

Figure 2 - Oscilloscope with Triggered Sweep

1500 volts, while higher-speed scopes can have acceleration voltages as high as 10 to 15 KV. The low-voltage power supply supplies the operating voltages for the rest of the scope. The size of the trace on the screen is proportional to the acceleration and deflection voltages, so in order to have a calibrated scope (where you can

measure voltage or time from the screen), the power supplies must be regulated. Cheaper scopes don't use regulation, and so are mainly useful for qualitative, not quantitative measurements.

The block diagram of a triggered scope is shown in figure 2. The main changes are in the timebase circuit. The trigger signal, either from the vertical amplifier or external, is fed into the trigger flip-flop (also called the trigger multivibrator). This is a type of Schmidt-trigger flip-flop that has a very well-defined trigger point. The exact point on the trigger waveform where the sweep is to start is determined by the trigger level and trigger slope controls ahead of the flip-flop. The output of the trigger flip-flop is converted to pulses, and the positive pulse turns on the sweep gating flip-flop. This enables the ramp generator, which starts producing a linearly-increasing voltage. When the voltage reaches a pre-determined level, the hold-off circuit resets the sweep gating flip-flop, and holds it off (disabling any new triggers) until all associated circuits have settled down. At the end of the hold-off period the sweep gating flip-flop waits for the next trigger event.

The advantage of this complex triggered sweep circuit is that single or irregular events can be accurately displayed just as well as repetitive waveforms. Even in all-analog audio applications where most test waveforms are repetitive, a triggered sweep gives a more solid display. A DC-coupled, triggered scope is essential for any work on digital waveforms.

History

The historical ancestor to the oscilloscope is the oscillograph, an electro-mechanical device for recording transient behavior in power systems. First developed in the 1880s, it used a small mirror driven by a galvanometer (a small coil in a magnetic field) to move a light beam across a moving roll of film. The film was developed, giving a trace of the galvanometer current versus time. Although produced up through the 1930s, the oscillograph was expensive, difficult to use, and had a maximum frequency limit of about 10KHz. It should be noted that the name "oscilloscope" was first coined in 1927, and some all-electronic CRT-based units were still called "oscillographs" for many years, most notably by Dumont.

The first practical, all electronic oscilloscopes used CRTs that had a small amount of gas in the tube that helped

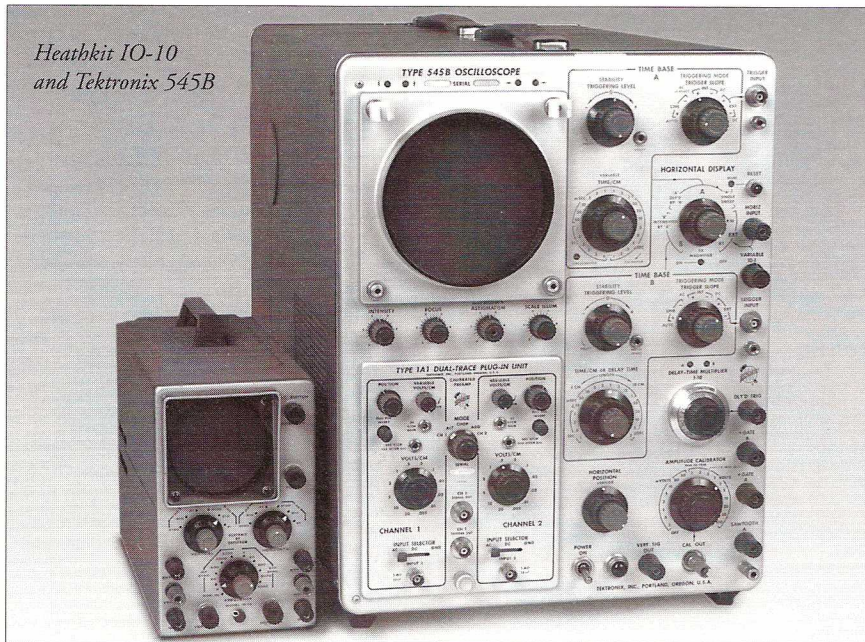

focus the electron beam. This was researched by Bell Labs, and the Western Electric 224A was representative of this type. Their lifetimes were short, and they had limited brightness. The development of an effective electron gun permitted hard-vacuum CRTs to be mass-produced, with General Electric and Westinghouse first introducing them in 1932. These were shortly followed by tubes from RCA and Dumont (who became the dominant American suppliers), and tubes from Sylvania, National Union, Cossor (English), Ediswan (English), and Leybold & von Ardenne (German).

By the late 1930s, oscilloscopes had started to become a common part of electronic development labs. Horizontal sweep circuits and vertical amplifiers were being built into the units, and their cost was coming down. The pre-eminent American brand at this time was Allen B. Dumont Laboratories. The average service shop or radio production line did not use them extensively, though, since radio tuning and alignment could still be done with meters. World War II changed all that. The only effective way to debug and align the pulse circuits used in radar, LORAN, sonar, and many other wartime systems required the visual display of an oscilloscope. Television broadcasting, started in Europe before the war, and just after the war in America, also required oscilloscopes for its pulse circuitry and “sweep” alignment of the RF and IF sections. The result was an explosion of low-cost oscilloscopes aimed for the service and hobbyist market. Common brands included RCA, Sylvania, Simpson,

Triplet, Heathkit, EICO, and many others. These often had vertical bandwidths of 5 MHz to handle video signals, but were AC-coupled, had fairly primitive recurrent horizontal sweep systems, and as with their pre-war predecessors, were not calibrated.

During World War II, the explosion of work on pulse circuitry led to the development many specialized oscilloscopes, most notably the “Synchroscope”. This was similar to a conventional laboratory oscilloscope, but the free-running sweep generator was replaced by a triggered sweep oscillator (see Fig. 2). This allowed single events to be predictably captured on the screen. For general-purpose use, the triggered sweep could be periodically re-triggered, simulating the older free-running sweep generator. Synchrosopes were developed at research laboratories during the war, and were built by contractors such as Sylvania, Browning Laboratories, Western Electric, Dumont, and others. After the war, a few companies, notably Browning Labs, continued to sell laboratory scopes based on the synchroscope concept. However, the major oscilloscope manufacturers, most notably Dumont, concentrated the bulk of their post-war effort on conventional recurrent-sweep designs.

Two engineers who had worked with synchrosopes during the war were destined to change the oscilloscope landscape. They formed a company in their native Portland, Oregon to build high-quality oscilloscopes based on the laboratory needs they saw in World War II

research labs. Their scopes had triggered sweep generators, regulated power supplies, and DC-coupled vertical amplifiers were available. The designs were stable enough that their screens could be calibrated in volts/cm and sec/cm. The construction was excellent, with all but the earliest models using ceramic terminal strips. Their features were aimed squarely at the new generation of television, defense electronics, and computers. Tektronix was ready to become the dominant industrial and laboratory oscilloscope manufacturer for decades.

Tektronix scopes became enormously popular in R&D labs, especially their 530- and 540-series with plug-in vertical amplifiers. Dumont was still selling a lot of their old-fashioned scopes, mainly to schools and less-sophisticated labs, but by the late 1950s, Tektronix had eclipsed Dumont. In the early 1960s, Dumont was bought by Fairchild Instruments, then faded into obscurity. In the late 1950s, Hewlett-Packard, by then the dominant test equipment manufacturer, stuck its toe into the oscilloscope market. Despite its size, though, H-P never overcame Tektronix as the largest oscilloscope maker.

Up until the early 1960s, all laboratory scopes used tubes. As transistor technology matured, a few all-transistor portable scopes were made, but Tektronix and H-P made a generation of oscilloscopes using a hybrid technology (mixed tubes and transistors). By the early 1970’s, tubes were gone (except, of course, for the CRT), and oscilloscopes became lighter, smaller, and tended to have much higher bandwidths.

In the TV servicing market, American companies, such as Sencore, B&K, and Heathkit were dominant in the 1960s. By the 1970s, though, lower cost oscilloscopes started to become available from Japan, and later Korea and Taiwan. Some of these were OEM’ed under American brand names, and others were sold under their own names: Hitachi, Kikusui, etc. These scopes were often near-clones of solid-state Tektronix models, and as such had quite good features. The build quality was good, but reliability of the early models was sometimes not very good. These types of scopes dominate the low-cost analog field today.

In the 1980s, some specialty oscilloscopes were developed that digitized the incoming signal, then displayed it on a computer-driven display. These were expensive and had fairly low bandwidths initially, but permitted better viewing of

transient events and allowed computer analysis of the signals. H-P and Tektronix sold these Digital Sampling Oscilloscopes (DSOs) along side their analog models, but as the cost of digital technology fell, these became dominant, and today Tektronix has just a few token analog scopes in its product line.

Low cost hand-held DSOs using LCD displays are currently made by Fluke, Tektronix, and others. These, along with desktop DSOs, are potentially attractive for someone looking to buy a new oscilloscope. However, digital scopes have little or no capability for trace intensity modulation, and can often miss subtle events that occur amidst repetitive events. Being somewhat of a traditionalist, and given the low cost of audio-capable service scopes or used scopes, I recommend an analog scope.

Choosing a Scope

Viewing audio signals is generally the least demanding task of all the things oscilloscopes can do, so nearly any oscilloscope can be used for audio testing. However, convenience, accuracy, reliability, and cost need to be considered. We will first look at the raw technical specifications needed, then the general type of scope, and finally, some specific models.

The primary oscilloscope spec is the vertical channel bandwidth. A rule of thumb is for the bandwidth to be at least 5 times the maximum frequency to be tested. For most tube-type audio systems, 1 MHz or even 500 KHz would be enough. Really broad bandwidth systems would require several MHz. If you are looking at digital signals, though, you may need 50 MHz or more. The maximum sweep speed in each scope is generally commensurate with the maximum vertical bandwidth.

An AC-coupled oscilloscope is quite usable for most audio signals, but DC coupling ("direct coupling") insures that low-frequency signals are not distorted by the scope's low-frequency cut-off.

The greater the sensitivity, the better, for audio applications. This is especially true if you use the "X10" attenuated scope probes (recommended), since they cut the input by a factor of 10. Most general-purpose scopes go down to 10 mv/cm, but a few go as low as 200 μ V/cm. Some scopes have DC coupling down to, say .1 V/cm, then have AC coupling for the lower ranges. Some other scopes have restricted bandwidths on the high-sensitivity ranges. These trade-offs are not too bad, since most of time large

signals will be observed. Some scopes, especially newer solid-state ones, have limited maximum input voltages, such as 20 V/cm or 200 volts maximum. Unless used with a decent X10 probe, these scopes can be blown out when measuring typical voltages in tube equipment. If you are measuring over 600 volts, you will need special high-voltage scope probes.

If possible, get a 2 (or more) channel scope or a dual-beam scope for your test bench. This allows signals to be compared. A two channel scope works by either rapidly switching the electron beam between the channels (the "chop" mode) or alternately sweeping each channel (the "alt" mode). The chop mode is usually used for lower frequencies, and the alt mode is for high frequencies. Both of these modes can sometimes cause odd behavior, especially with digital signals, so a little experience is needed when using this. A dual-beam scope has actually two separate electron guns with separate vertical amplifiers and deflection plates. Both beams are swept by a single timebase. This is more expensive, but has the least ambiguity between traces. Single channel, single beam scopes are useful for simple monitoring.

Many older oscilloscopes have poor sensitivity for the external horizontal input, compared with the vertical input, and most have poorer frequency response for the horizontal input. If you need to use the X-Y mode, look for a scope with good horizontal sensitivity or one that allows a second vertical channel to be configured as the horizontal channel.

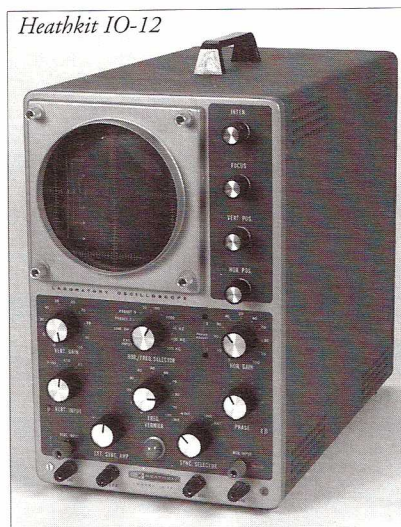

As mentioned earlier, a triggered sweep is recommended. An enhancement to the triggered sweep is the delayed

sweep, which permits the sweep to start after an adjustable delay time. This is not too useful for audio testing, but can be helpful in digital debugging.

Your budget will determine the class of scope you can buy. If it is unlimited, microprocessor-controlled analog scopes or advanced digital scopes are available. However, even the best of these do not have the pin-point clarity or smoothness of operation of some classic analog scopes. If you have \$200 to \$600, a good used solid-state Tektronix or H-P scope or a new Asian oscilloscope can be purchased. These are small and reliable, although do not have the fine traces of the bigger tube-type scopes. At the opposite extreme, for \$5 to \$25 you can pick up a simple hobbyist or serviceman's scope at a swap meet, but aside from being of poor quality, they often need repair work. For \$25 to \$200, professional-quality tube-type scopes and cheaper used solid-state scopes are available. The older scopes may need repairs and alignment, but if you can get the technical manual, you may be able to work on them yourselves. Getting scopes repaired professionally can cost hundreds of dollars.

A problem with most older tube-based oscilloscopes is that they are large, put out a lot of heat, and can be noisy (from the cooling fan). This is why they are often for sale cheap. If you can handle this, though, you will get a scope that can have excellent resolution – far better than modern high-speed scopes – and are electrically very rugged. They can have a lot of tubes – from 15 to more than 65, so make sure the tubes are good, or that you have a good supply of 6DJ8s. Re-tubing at retail prices can be really expensive. Audiophile-quality tubes are not needed, though, in most cases.

Representative Oscilloscopes

(Note: These are scopes that I am familiar with. Many others may be quite suitable, so use the criteria given above for selection)

There are not many of the recurrent-sweep scopes that I have found to be very good. Of the kit scopes, the Heathkits are generally the best. A Dumont scope in good condition may be useful, but avoid the ones with PC-boards – they are unreliable. Some good compact scopes include the Heathkit IO-10 and the Waterman portable scopes.

Sencore and B&K made a series of solid-state serviceman's scopes in the 1960s and 1970s that perform decently,

although have questionable reliability. By the 1980s, most of these models had been replaced by Japanese-built ones that were better quality and more reliable.

Of the laboratory scopes, the best is Tektronix. Nearly all of their scopes are good, but there are some that are either very common, or stand out as being especially good for audio work, which will be mentioned here.

The "mainframe" plug-in scopes: the 531, 533, 535, 541, 545, and others, were built from 1955 to the early 1970s. They are large and noisy, but have a tremendous variety of vertical amp plug-ins, ranging from ultra-sensitive audio channels to spectrum analyzers. They are common, and usually fairly cheap. For best reliability, get ones that were made from the early 1960s or later. Look for ones with embossed blue metal "skins", not ones with brown or blue wrinkle paint. Before about 1961, all Tektronix scopes used the infamous Sprague "striper" capacitors and paper high voltage capacitors, both of which tend to go bad. Many early ones used selenium rectifiers, which also deteriorate. I have also run into problems with open-circuit metal film resistors – usually either the orange-brown "TI" brand or the light blue striped ones. Other than these problem areas, I've found tube-type Tek scopes to be remarkably reliable.

The second generation mainframe Tektronix scopes, the 560-series, built from the early 1960s to the 1970s, are better suited to the audio test bench. They are smaller, have no fan, and have a good selection of plug-ins. They span the tube-to-transistor transition, with the early ones being all tube, and the last ones being all transistor, and hybrid circuits used in between.

The final generation of Tektronix mainframes was the 7000-series. These are high-performance solid state models from the 1970s with bandwidths up to 400 MHz and many complex plug-ins available. These would be good for digital use but are overkill for audio. These are beginning to come onto the market as surplus, but beware: a bad type of plastic was used in some of the rotary switches, especially in the timebases, that deteriorates and breaks, and cannot be repaired. Make sure all the plug-ins work before buying them.

Tektronix made a variety of "portable" and lower cost tube-type scopes, such as the 310, 316, 317, 503, and 515. These single channel scopes work well, but a

two-channel scope is recommended as your main scope.

One of my favorite Tek scopes is the 502. This is a true dual beam scope with excellent sensitivity (100 or 200 $\mu\text{V}/\text{cm}$). It has about 1 MHz bandwidth on most sensitivities, which I have found fine for audio use. It also has true differential inputs (good for measuring in the presence of common-mode noise) and can be switched so that one channel can drive the horizontal deflection plates. The 502 is somewhat odd in that it has no continuously variable deflection sensitivity or timebase controls. This is not too difficult to live with, but is rectified in the 502A model. The 502A also has better sensitivity, a single-sweep feature, and a front-panel control to balance the beam brightness. Later models of the 502A (after about 1965) replaced the all-tube vertical amplifier with a hybrid PC-board, which, although more stable, uses hard-to-find 8056 nuvistors.

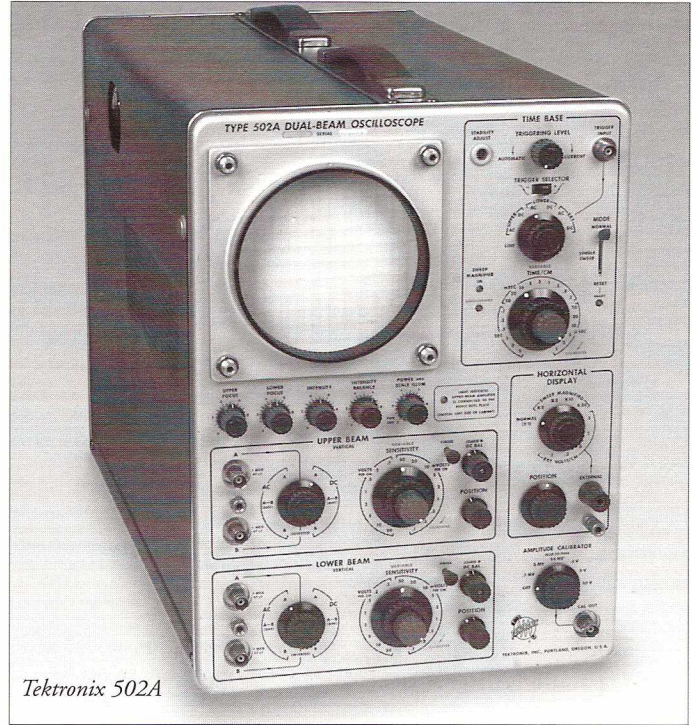

Tektronix 502A

bandwidth is 100 MHz, the 475 went up to 200 MHz, and the 485 went up to 350 MHz. Because of their popularity, they still command a high used price. As with most small high-bandwidth scopes, they used "mesh-expansion" CRTs which limit the minimum spot size (they do not have crisp displays). However, if you were to own a single oscilloscope to handle both audio and digital, these can't be beat. Low-cost follow-ons to these models were the 2213 and 2215. The early models of these last two had power-supply reliability problems.

In the 1980s, Tektronix added micro-processor controls to their portable scopes. The best-known models are the 2435, 2445 and 2465. These can make on-screen measurements of voltage, time, and frequency, and can save control setups in memory. Tek's most recent low-cost analog scopes are the TAS 220 and TAS 250.

Hewlett-Packard's tube-type oscilloscopes, such as the 130, 140, 150, and 175, are quite useable, but, feature-for-feature, lag equivalent Tektronix models. If you stumble across a good one, that's fine, but don't go out of your way for them. They mostly used PC-board construction (something Tektronix avoided until well into the solid-state era), which can be a reliability problem with older tube equipment. H-P's scopes got better when they went solid-state. Their 180-series mainframes were quite good, and



Tektronix 310

Probably the most famous and well-liked Tektronix scopes are their solid state portables: the 453, 465, 475, and 485. Of these, the 453 and 465 are most suited to general audio work. The 465's

the later 1700-series low-cost scopes are decent, although, again, not as good as competing Tek scopes. Many engineers complain that H-P scopes never triggered as well as the Tektronix scopes. H-P was one of the first companies to use internal gratules, which gives more accurate displays.

Aside from the low-cost Asian imports, other imports seen in America are English brands such as Marconi and Telequipment. I recently worked on a Telequipment D43, a portable dual-beam triggered scope with plug-in vertical amplifiers. It used hybrid technology. While not as mechanically rugged as American lab-quality scopes, it worked quite well, and would be good for audio work.

What scopes do I use? On my main test bench, I have a Tek 502A and a 485. At the One Electron office I have a Tek 561A and 561B. And, there are a few odd scopes kicking around: a Tek 310, 317, a Heathkit IO-10, and an H-P 1300A.

In the next Audio Test Bench: Oscilloscopes, Part 2: Applications.

Bibliography

Greenwood, Holdam, Macrae, **Electronic Instruments** (MIT Radiation Lab Vol. 21), McGraw-Hill, 1948, pp. 576-664. Detailed descriptions of synchroscopes, etc.

Peter A. Keller, **The Cathode Ray Tube, Technology, History and Applications**, Palisades Press, 1991. Comprehensive history of the cathode ray tube. Many photographs.

Rider, Uslan, **Encyclopedia on Cathode Ray Oscilloscopes and Their Uses**, 2nd Ed., John F. Rider Publisher, Inc., 1959. Enormous book on all aspects of oscilloscopes. Many scope schematics.

Soller, Starr, Valley, **Cathode Ray Tube Displays** (MIT Radiation Lab Vol. 22), McGraw-Hill, 1948. Detailed info on CRT technology and support circuits.

Stan Griffiths, W7NI, **Oscilloscopes: Selecting and Restoring a Classic**, privately published, 1992. Service hints and descriptions of all Tektronix scopes up to 1970. (Available from Antique Electronic Supply).

Tektronix, Inc., **Typical Oscilloscope Circuitry, Tektronix**, 1961. Excellent description of tube-type Tektronix circuits for the technician.

Uncle Eric's Dumpster

The 5687 Tube Family

By Eric Barbour

This series of articles is intended to focus a spotlight on tube types which are commonly ignored today. Many things were made over the last 60 years which were well-suited for audio use, but are rarely or never seen in audio. I hope that my series will prevent valuable NOS tubes from being discarded before they bring beautiful music to someone's ears.

Be sure to check that box of old tubes before you throw it out. Just because it contains no 7025s, does not make it disposable. Not all the tubes that we call "audio" tubes today were justifiably per-

huge cathodes. Around 1954, the plate structure was changed so the axis of the tube elements was perpendicular to the plate flange, resulting in more plate area, and a stronger construction. All other companies used this plate structure for 5687s, and in the 1960's Sylvania adopted it for their 12AX7 and 12AU7 types, as well.

The 5687 was intended as a high-transconductance dual triode for general use in industrial and military equipment. It was not intended for RF use, but usually ended up in IF stages and as a logic or pulse amplifier in computers. Audio use was very rare commercially until recently, although some power amplifier articles appeared in the 1950s in Electronics magazine that used the 5687 as driver tubes. An example of use in a contemporary exotic SE amplifier is the Audio Note Ongaku, applying it as the cathode-follower driver for the 211 power

RCA, GE, Sylvania and Toshiba 5687s



fect for audio. In many cases, a type was used for economic reasons. Witness the 12AX7. If you don't need extremely high gain, but DO want low distortion and a clean sound, the nearly-forgotten 5687 and its kin are worth a serious look.

The 5687 was introduced in 1948 by Tung-Sol as a member of the so-called "ARINC" tube series, intended for use in commercial avionics. Tung-Sol, GE, and Raytheon originally introduced the ARINC types, although Sylvania and RCA also made these types. All of these companies, as well as some foreign companies, made the 5687. By the late 1970s and 1980s, only GE and Sylvania (later Philips ECG) were making the 5687.

The first 5687s by Tung-Sol had a black carbonized plate in the identical shape of the 12AU7s of the time. An easy way to tell the difference was the 5687's

tube. RCA's 5687 is probably the most desired, because of the general aura of magnificence surrounding their "black-plate" tubes. RCA's early 6L6GC, 6V6GT, 5751 and others were also in this sought-after series.

Many experts (both real and virtual) feel that high transconductance makes a

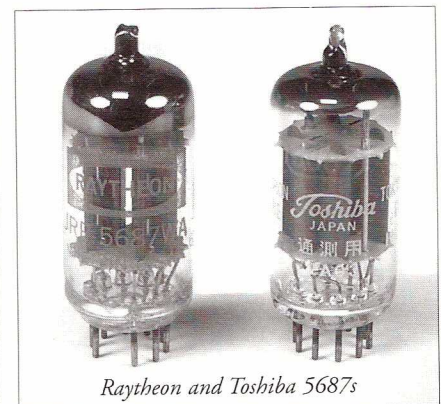

good tube, to the exclusion of other factors. Despite this, the 5687 has low distortion as well as a Gm of 8500 μ mhos, making it a very clean-sounding tube. The few people who have experimented with it agree that it is a sleeper. Later developments included the 6900, introduced by Bendix in 1957. It was the Red Bank version, with gm =11,500 and extreme ruggedness. Then came the GE 7044 of 1957, with gm =12,000 and less ruggedness, intended for cathode followers in computing circuits. The 7370 was a 1959 GE version with a 40-volt heater for series-string use, and the obscure Tung-Sol 7892 (1961) was intended as a high-current pulse amplifier version. A European version of the 7044 was the E182CC, introduced in 1958 by Philips. It was a premium type with a large plate

Warning! Don't plug the 5687 or its cousins into 12AU7, 12AX7 or similar sockets. The pin connections are different, and damage to the tube and your equipment will result!

Sound tests revealed that the 5687 is very consistent from brand to brand, but there are slight but detectable sonic "signatures" to each brand. The older Sylvania and GEs were very clean and smooth, while the RCAs had the typical soft, gauzy quality of all RCA black-plate types. And recent Philips military surplus 5687WBs were notably harsher

and more detailed than the others. An NOS Bendix Red Bank 6900 gave a mellow quality, similar to the RCA but less pronounced.

Large cathodes and careful manufacture make these tubes suitable for audio use, especially as cathode followers or for line-level

stages. The 7892 was a remarkable device for its small size; it is rated to produce 5 amperes in short-duty-cycle pulses. All the 5687 types are similar in general ratings to the 6CG7 or 6SN7GT, while hav-

GE 7370 and Red Bank 6900



Dutch Amperex PQ, HP Marked Amperex and late US Amperex 7119s

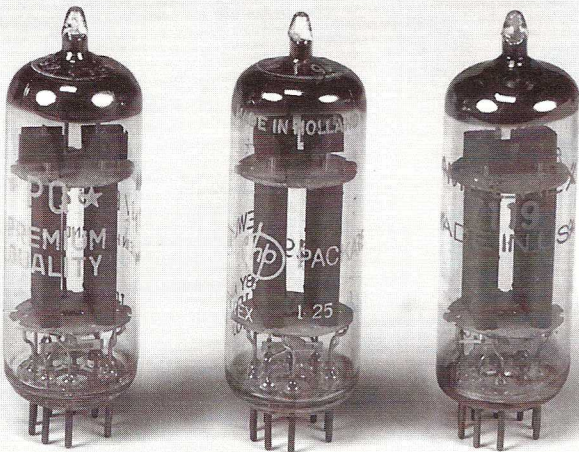

structure and a gm = 15,500 μ mhos at 36 ma. This type was brought into America as the 7119 by Amperex. Some later military 7119s were built here.

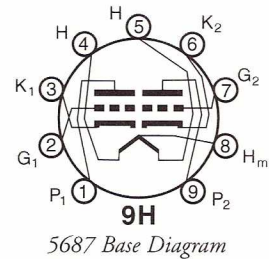

ing the high transconductance and high permeance that make them technically excellent classics. If you have a stock of them, use them in your own homebrew equipment. Do act quickly, though, and

stash away a lifetime supply; these types are disappearing rapidly. The only one still being used by the U.S. government is the 6900, and even that is declining in numbers as old avionics are scrapped. MU still manufactures it in occasional lots, making it one of the very few receiving tubes still in production in the USA.

If you have experimented with any unusual tubes that have worked well in audio applications, let us know.

Condensed Tube Specifications:

	6FQ7	12BH7	5687	6900	7044	7119
E_h :	6.3	12.6/6.3	12.6/6.3	12.6/6.3	12.6/6.3	12.6/6.3 V
I_h :	0.6	0.3/0.6	0.45/0.9	0.45/0.9	0.45/0.9	0.4/0.8 A
Max. E_p :	330	300	300	600	300	300+ V
Max. Pd (ea. section):	.4	3.5	4.2	4.25	4.5	4.5 W
μ :	20	16.5	17	18.5	21	24
gm:	2600	3100	8500	11500	12000	15500 μ mhos
r_p :	7700	5300	2000	1700	1750	1600 ohms
at: $V_p =$	250	250	180	120	120	120 V
$V_g =$	-8	-10.5	-7	-2.0	-2	-2 V
$I_p =$	9	11.5	23	36	36	36 mA

(sources: GE Essential Characteristics, Philips Miniwatt Pocket Book, Bendix Ad.)

Get Big Tone

Check out VTV on-line at www.vacuumtube.com
 -Library of Tube-Related Articles
 -On-Line Tube Audio Buy/Sell Ads
 -Cool Links to other Tube Sites
 -Subscribe to VTV + get all issues using your credit card
 -Order Big Tone T-Shirts and other goodies
www.vacuumtube.com

HI-FI SPOTTER'S GUIDE SERIES

Brought To You By

VINTAGE HI-FI PRODUCTIONS

order now!

1. VINTAGE HI FI SPOTTER'S GUIDE - VOLUME 1

A unique collection of photos, specifications and advertising from the Golden Age of Hi Fi. Over 450 amps, tuners, and other equipment is depicted.

\$18.95

2. VINTAGE HI FI SPOTTER'S GUIDE - VOLUME 2

This Volume covers equipment not listed in Volume 1. Almost 500 amps, preamps, tuners, etc are depicted. This edition covers early audio, Golden Era (1947-63) and includes a "Speaker Spotter" section with Altec, EV, JBL, Jensen, University and more.

\$18.95

3. NEW 1997-98 VINTAGE HI FI and PRO AUDIO PRICE GUIDE

New, updated price guide for vintage hi fi amps, preamps and tuners. Now includes Vintage Altec, IPC, JBL, RCA and Western Electric pro audio and theater gear. Also, home and pro loudspeakers, N.O.S. vacuum tubes and audio transformers. Over 1600 items covered with grading and collector information. Corresponds with Volumes 1 and 2 of the Spotter's Guides.

\$25.00

4. "VINTAGE HI FI THE GOLDEN ERA 1947-65"

A one-of-a kind video covering the nostalgic post-war and 1950s home hi fi era. Over 80 classic audio amps, tuners, etc are shown. This video is professionally produced and is 34 minutes in length.

VHS NTSC

\$25.00

5. THE ULTIMATE TUBE SUBSTITUTION GUIDE

No tube electronics enthusiast should be without this book. Over 10,000 tubes are listed on 240 pages including: audio, radio, transmitting, and special. Also features an audio tube section with tube evaluation and testing information.

\$29.95

6. NEW 1997 VINTAGE SCHEMATIC AND LITERATURE LIST

New, updated large list of audio books, catalogs, tube hifi schematics and owners manuals available for: Altec, Bell, Dynaco, Eico, Fisher, Grommes, Harman-Kardon, Heath, Leak, Marantz, McIntosh, Newcomb, Pedersen, Pilot, RadioCraftsmen, Scott, Western Electric and more.

\$5.00

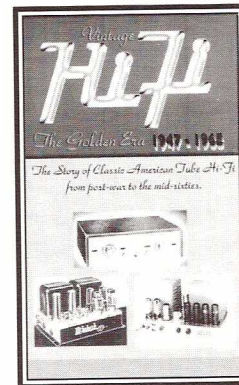
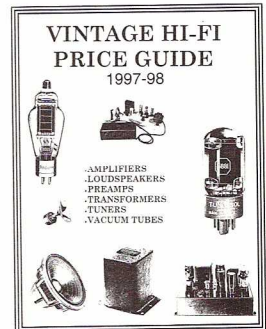
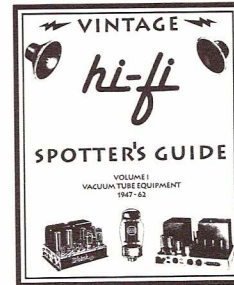

VIDEO

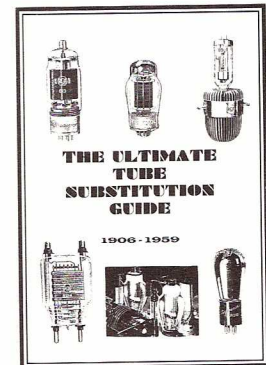

ORDER FORM

NAME _____
 ADDRESS _____
 CITY _____ STATE _____ ZIP _____

PLEASE SEND THE FOLLOWING PRODUCTS!

FREE SHIPPING IN USA ADD \$7.00 PER ITEM FOREIGN (foreign shipping)
 CA RESIDENTS ADD 7.75% STATE SALES TAX (CA TAX)

CREDIT CARDS, US CHECKS OR MONEY ORDERS OK TOTAL ORDER

PRICE

\$ _____
 \$ _____
 \$ _____
 \$ _____
 \$ _____
 \$ _____

Credit Card Type _____
 Exp Date _____
 Card# _____

VINTAGE HIFI PRODUCTIONS
 1095 E. DUANE AVE STE 106
 SUNNYVALE, CA 94086
 408-733-6146 phone/FAX
 email -
 triode@vacuumtube.com



VACUUM TUBE VALLEY
SUNNYVALE, CALIF. U.S.A.

Be the first in your neighborhood
to have the official VTV
"BIG TONE" T-shirt.

2 color heart print available in either
Blue Spruce or **Desert Sand** colors.
(Please Specify when ordering)
100% cotton shirt. Only extra large available.
Only \$14.50. plus \$3.00 postage US,
CA residents add \$1.12 Sales Tax
Canada and Mexico add \$7.00 postage
Europe and Asia add \$12.00 postage
Cash, Check or Money Order
Credit Cards OK

Vacuum Tube Valley
1095 E. Duane Ave., Suite 106
Sunnyvale, CA 94086 USA

one electron™
Single-Ended Output Transformers
High Quality for a Reasonable Price
Designed and Built in the USA

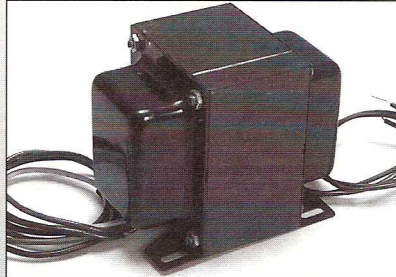

UBT-1 Designed for parallel operation of:
1.6k primary 15 watts 160 mA **\$90.25** 2A3s, EL34s, 300Bs 6AS7s,
etc. or Sweep-tube in
"enhanced triode" mode

UBT-2
4.8k primary 15 watts 110 mA **\$112.10** Can be used with:
300B, 50, SV811-3, etc.

UBT-3
3k primary 15 watts 110 mA **\$121.60** Excellent for single
2A3 or 300B

Quantity discounts available

ANTIQUE ELECTRONIC SUPPLY™
LIMITED PARTNERSHIP
6221 S. Maple Ave. • Tempe, AZ • 85283
Phone (602) 820-5411 • FAX (602) 820-4643 or 800 706-6789

VTV Back Issues

- VTV #1 \$8.** ppd US **\$10.** Foreign
Early Tube Amps 1920-1938
History of Dynaco Tube Gear
Tube Testing Methods
Audio Test Bench Set-up
12AX7/ECC83 History and Tests
- VTV #2 \$10.** ppd US and **\$13.** Foreign
EL34/6CA7 History and Tests
Heathkit WM Series Williamson Tube Amp History
Western Electric Large Theater Sound 1930
Great Tube Guitar Amps and Tubes
Tube Matching
Magnum SE Amplifier Construction Project
- VTV #3 \$12.** ppd US and **\$15.** Foreign
Western Electric 300B History and Tests
Single Ended Transformer Tests
SE Transformer Listening Tests
1935 E H Scott 48 Tube Classic Radio
EICO Tube Mono HiFi History and Photos
McIntosh MI 200 Adventure and Mods
Dynaco Stereo 70 Super Modification
- VTV #4 \$12.** ppd US and **\$15.** Foreign
6L6 History and Tests
Harman Kardon Citation I & II
Review of Vintage Bookshelf Speakers
Tube Manuals from the Golden Era
Designing for Sound
Vacuum Tube Valley
1095 East Duane Avenue, Suite 106
Sunnyvale, CA 94086 USA
408-733-6146 phone/FAX
US Bank Check, Master Card, VISA or AMEX



**ELECTRA-PRINT
AUDIO**

QUALITY HANDWOUND S.E. OUTPUT TRANSFORMERS

- Primaries from 1.8K to 10K
- Exclusive wideband design
- 16, 8, 4, or 2 ohm secondary
- Gold plating

CUSTOM-BUILT POWER TRANSFORMERS/CHOKES

- Wound to your requirements
- Heavy-duty design for Class A use
- DC filament supply windings
- HV chokes to 15H, 300ma
- Low voltage, high current filament chokes

Component pricing and specifications catalog available

ELECTRA-PRINT AUDIO

4117 Roxanne Drive Las Vegas, NV 89108
702-396-4909 FAX 702-396-4910

VTV Renewal or Subscription Form
(Photocopy form)

Yes, I want to subscribe _____ renew _____ to VTV
Number of Years _____

\$32/yr four issues US, **\$40/yr** Canada and **\$45/yr** Asia,
Europe and World.

Cash, US Bank Check, Money Order or Credit Cards

Vacuum Tube Valley, 1095 E. Duane Ste. 106,
Sunnyvale, CA 94086 (408) 733-6146

NAME _____
ADDRESS _____
CITY _____
STATE _____
COUNTRY _____ **MAIL CODE/ZIP** _____
CREDIT CARD TYPE _____
CREDIT CARD NUMBER _____
EXP. DATE _____
AMOUNT ENCLOSED _____

Original Vinyl Sound

Vacuum Tube Phono-Preamplifier

- True RIAA Equalized
- Full Gain Adjust
- Gold plated RCA
- HF boost switch
- Low Distortion
- Low Noise
- Drives P/A direct
- Designed & Made in USA
- Superb Quality and Sound
- Operates on 100/115/230VAC
- Tube shields (not shown) are supplied



Technical Specifications

Model PP-1

Model PP-1H

Voltage Gain	40dB min @ 1kHz	56dB min @ 1kHz
Variable Gain Adjust Range	Full gain to -85dB	Full gain to -85dB
Frequency Range	20-20,000Hz	20-20,000Hz
Equalization (2 positions)	RIAA or HF boost	RIAA or HF boost
Input Impedance	47K Ohm	47K Ohm
Output Impedance	1K Ohm	10K Ohm
Hum & Noise Output	Less than .6 mV	Less than 3mV
Channel Separation	-60dB at 10kHz	-55dB at 10kHz
Sensitivity (at 1kHz)	10mV for line output	1-2mV for line output
Maximum Output	7V RMS	5V RMS
Heater Voltage	3 section DC filter	3 section DC filter
Tube Compliment	3 each 12AX7	3 each 12AX7
Level Adjust	Individual channel adj.	Individual channel adj.
Connectors	Gold plated RCA	Gold plated RCA
Primary Requirement	100-230VAC 10VA	100-230VAC 10VA
Size (W x L x H)	19 x 13 x 5 cm (7.5 x 5 x 2")	19 x 13 x 5 cm
Weight	1.8 kg (4 lbs)	1.8 kg (4 lbs)
Finish (2 choices)	Black or Chrome	Black or Chrome
List Price (assembled)	\$469 black, \$489 chrome	\$479 black, \$499 chrome
List Price (kit)	\$379 black, \$399 chrome	\$389 black, \$409 chrome

*****Call us for Factory Direct Discount*****

Antique Sound USA

6717 NE 181st Street, Seattle WA 98155 USA, Phone 206-481-8866, Fax 206-485-3836

<http://www.amemura.com/sound/>

Now Available!

The Randall Amplifier



This is the same amplifier built in the "Audio From Tubes" class taught by John Atwood at the Randall Museum in San Francisco. Available either completely assembled or as a partial kit for the serious constructor.

- Stereo, single-ended amplifier, with 13 watts (RMS) per channel
- 3 db of feedback balances dynamic sound and good speaker damping
- Power supply distribution isolated between channels, with choke filtering
- All tube design (no semiconductors anywhere)
- All point-to-point wiring (no PC boards)
- Wrinkle powder-coat finish in either dark gray or black (other finishes available by special order)

Special Introductory Price: \$1395 (assembled) \$595 (partial kit)

F.O.B. Sunnyvale, CA
Contact One Electron
for more details

one electron™

65 Washington Street, Suite 137
Santa Clara, California 95050 USA
FAX: 408 985-2006
<http://www.one-electron.com>

GO AHEAD

Ask top engineers and music lovers worldwide what capacitor they choose for their ultimate designs.

H O V L A N D

MUSICAP®

The most naturally revealing capacitor. Film and foil polypropylene construction — optimized for fine speakers and vacuum tube electronics. Precision made in the U.S.A.

Values from .01 μ F to 10 μ F.

Listen and compare for yourself.

UPGRADE NOW

"Your capacitor artistry is profound."

Harvey "Gizmo" Rosenberg
THE AMERICAN AUDIOMANIAC

For more information and to purchase, contact these quality distributors:

- Welborne Labs, USA 303-470-6585
- The Parts Connection, Canada 800-769-0747
- Michael Percy Audio Products, USA 415-669-7181
- A & S Speakers, USA 510-685-5252
- Handmade Electronics, USA 610-432-5732
- SJS Electroacoustics, England 44-1706-823025
- Tang Hill International Ltd., 886-2-5813605

OEMs and international distributors may contact HOVLAND COMPANY at 209-966-4377 Fax 209-966-4632

IMPROVE YOUR HEARING.

We're a company of musicians and engineers in our 17th year researching ways to relate laboratory data measured from a tube to the way the tube will sound. Our unique system produces sets of tubes that have various performance characteristics, much like the choices you'd find in speakers and microphones. Groove Tubes not only sound better and last longer, but cater to the type of music you're producing or listening to.

Our clients include thousands of professional musicians ranging from Stevie Wonder to Chet Atkins and world class recording engineers such as Eddie Kramer and Roy Thomas Baker. Our matched power tube sets are rated 1 to 10 and our preamp tubes are selected for low noise. We also build world class vacuum tube recording mics, tube preamps, tube reference amps, tube equalizers and tube compressor/limiters... and all our GT products are guaranteed to Improve Your Hearing!



Our new GT-KT88s by **TESLOVAK™**
The first legitimate European KT-88 made in 30 years. This newly developed beam power tube has special heat dispersion wings welded to the plate structure to help keep the tube's audio performance stable at high power handling levels and Gold wound grids for improved fidelity. Available in Blue and Red Glass.



Our new GT-34Ls by **TESLOVAK™**
This totally new design upgrades and replaces all EL34 applications, producing more power, wider frequency response and dynamic range than any other EL34 past or present! This new tube also has special heat dispersion wings to improve the audio response at higher power levels and Gold wound grids for improved fidelity. Available in Blue and Red Glass.

TESLOVAK Tubes are exclusive designs manufactured for GT and Penta Labs at the newly reorganized Tesla European factory.

Send \$5 for a color catalog with power tube comparison charts and a Beethoven sticker.

Send \$20 and we'll include a Beethoven T-Shirt.



Groove Tubes

12866 Foothill Blvd., Sylmar
California 91342 USA

Tel: (818) 361-4500 Fax: (818) 365-9884

e-mail: GrooveTube @ AOL.com

It's Like Music to Your Ears...

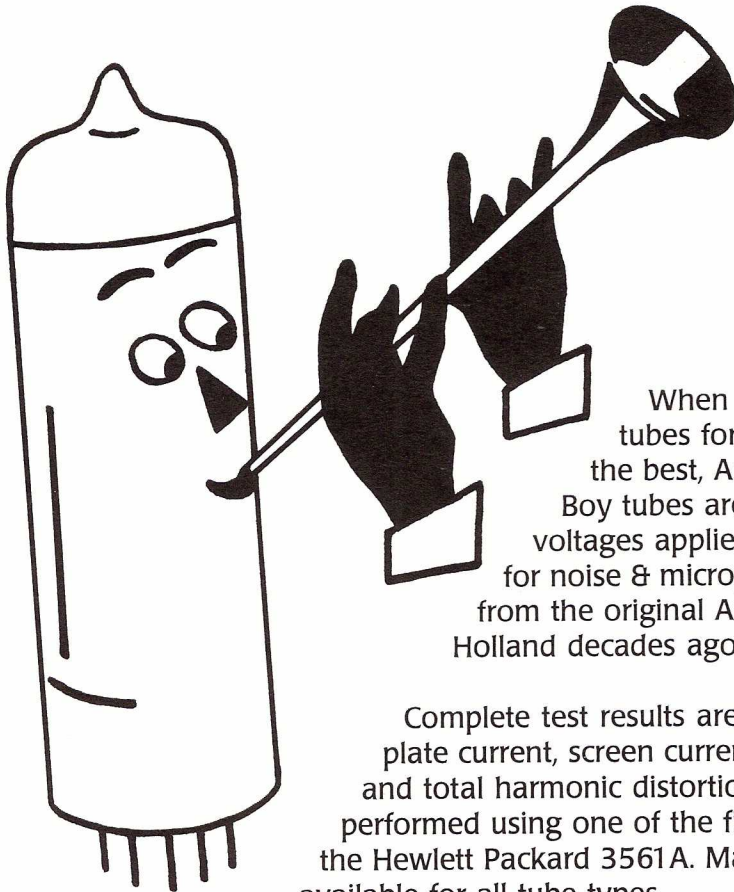

Amperex Bugle Boy audio tubes are back and they're better than ever!

When it comes to selecting premium audio tubes for your amplifier, accept no less than the best, Amperex Bugle Boy! Amperex Bugle Boy tubes are burned in under full load with all voltages applied for 24 hours before being tested for noise & microphonics. The aging racks used are from the original Amperex production line built in Holland decades ago.

Complete test results are supplied with each tube, including plate current, screen current, grid one current, filament current, and total harmonic distortion (THD). The THD measurement is performed using one of the finest spectrum analyzers available – the Hewlett Packard 3561A. Matching in pairs, quartets & octets is available for all tube types.

Special test requirements? Not a problem. For a slight additional charge we will test and match to your specified operating conditions.

Types available: **6DJ8/ECC88**, **12AU7A/ECC82**, **12AX7A/ECC83** and many more!

So if you haven't dealt with a source capable of meeting your demands, call us at **1-800-TUBE USA** or call **630-208-2200** today for information on additional products and the worldwide locations nearest to you. You'll like what you hear!

APD **Audio Product Division**

a division of Richardson Electronics, Ltd.

You can also visit our Classic Components site on the Internet at:

<http://www.tubes-r-us.com>

 **Richardson
Electronics, Ltd.**
ISO9002 Registered

40W267 Keslinger Road
P.O. Box 393
LaFox, IL 60147-0393
(630) 208-2200

TESLOVAK™

VACUUM TUBES...from the Heart of Europe!

Introducing three totally new vacuum tubes from **TESLOVAK™**: the KT88s, the E34Ls and the E83CCs. These new vacuum tube designs are the product of years of research, development, and hard work by our USA based engineering staff of Groove Tubes and Penta Labs in a joint venture with the staff of the newly reorganized Tesla factory recently relocated in the heart of Europe: the Slovak Republic.

These tubes are being handmade in limited quantities exclusively for Penta Labs and Groove Tubes in the classic European tradition. This legendary tube factory has manufactured many OEM tubes under the brand names such as; Telefunken, Siemens, Amprex, Mullard, and Brimar, to name a few.

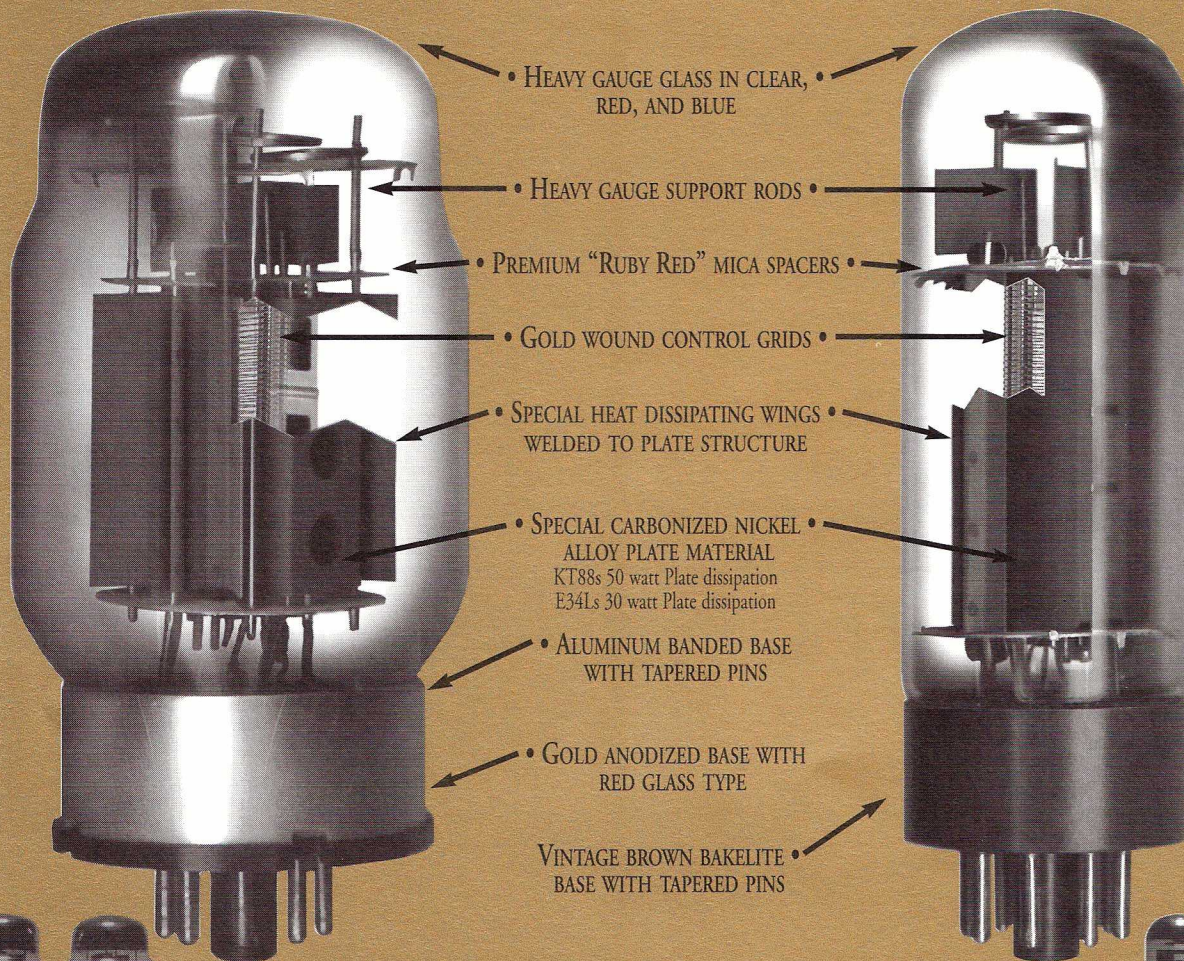

• HEAVY GAUGE GLASS IN CLEAR, RED, AND BLUE

• HEAVY GAUGE SUPPORT RODS

• PREMIUM "RUBY RED" MICA SPACERS

• GOLD WOUND CONTROL GRIDS

• SPECIAL HEAT DISSIPATING WINGS WELDED TO PLATE STRUCTURE

• SPECIAL CARBONIZED NICKEL ALLOY PLATE MATERIAL
KT88s 50 watt Plate dissipation
E34Ls 30 watt Plate dissipation

• ALUMINUM BANDED BASE WITH TAPERED PINS

• GOLD ANODIZED BASE WITH RED GLASS TYPE

• VINTAGE BROWN BAKELITE BASE WITH TAPERED PINS



Our new **TESLOVAK™** KT88s

The first legitimate European KT88 made in over 30 years. This new beam power tube has our unique and specially developed heat dispersion wings welded to the plate structure to help keep the tube's audio

performance stable at higher power handling levels. It also has gold wound grids for improved fidelity and lower noise. Additionally, our new KT88s is now available in blue and red glass.

Our new premium **TESLOVAK™** E83CCs preamp tube with special frame grids, wound with gold wire, help to reduce microphonic interactions, lower noise, and improve both transient and frequency response.

Selected preamp tubes and matched power tubes available from:



Groove Tubes
12866 Foothill Blvd., Sylmar
California 91342 USA
Tel: (818) 361-4500 Fax: (818) 365-9884
e-mail: GrooveTube @ AOL.com



Our new **TESLOVAK™** E34Ls

This totally new Pentode design upgrades and replaces all EL34 applications, producing more power and wider frequency response and dynamic range than any other EL34 past or present! This new tube also has special heat dispersion wings to improve the audio response at higher power levels and gold wound grids for improved fidelity. Available in blue and red glass.



Great attention is given to materials and assembly with over 30 hand welded contacts in this single dual triode! This great sounding new tube replaces the 12AX7/7025 in all applications.

(Tube pictured is the GT selected version, GT-ECC83)

Call for Design Engineering data sheets and OEM price schedule:

Penta Laboratories
21113 Superior Street, Chatsworth CA 91311 USA
Tel: (800) 421-4219 or (818) 882-3872
Fax: (818) 882-3968
e-mail: PentaLab1 @ AOL.com



VV300B CLEAR VV300B BLUE VV30B CLEAR VV52B CLEAR VV300B CLEAR VV300B BLUE VV30B CLEAR
POWER TRIODES WITHOUT OUTPUT LIMIT
 VV300B CLEAR VV300B BLUE VV30B CLEAR VV52B CLEAR VV300B CLEAR VV300B BLUE VV30B CLEAR
KR ENTERPRISE VV TUBES

CLEAR VV300B BLUE VV30B CLEAR VV52B CLEAR VV300B CLEAR VV300B BLUE VV30B CLEAR VV52B
 VV300B BLUE VV30B CLEAR VV52B **AVAILABLE IN THE U.S.A.** VV300B CLEAR VV300B BLUE VV30B
 CLEAR VV52B CLEAR VV300B CLEAR VV300B BLUE VV30B CLEAR VV52B C B CLEAR
VV300B CLEAR 14 WATTS VV300B BLUE VV30B CLEAR VV52B CLEAR VV300B C OB BLUE
VV300B BLUE 18 WATTS VV30B CLEAR VV52B CLEAR VV300B CLEAR VV30 CLEAR
VV30B CLEAR 18 WATTS VV52B CLEAR VV300B CLEAR VV300B BLUE VV30 CLEAR
VV52B CLEAR 25 WATTS VV300B BLUE VV30B CLEAR VV52B CLEAR VV300 VV30B
 VV300B CLEARVV300B BLUE VV30B CLEAR VV52B CLEAR VV300B CLEAR VV3 CLEAR
HIGHER POWER INCREASED LINEARITY LOWER NOISE AND LONG LIFE VV300B VV300B
TONAL ACCURACY THREE DIMENSIONALITY AND DYNAMIC RANGE VV300B VV300B
 VV52B CLEAR VV300B CLEAR VV300B BLUE VV30B CLEAR VV52B CLEAR VV300 OB BLUE
DIRECT INQUIRIES TO: VV30B CLEAR VV52B CLEAR VV300B CLEAR VV300B B CLEAR
 CLEAR VV300B CLEAR VV300B BLUE VV30B CLEAR V V 00B BLUE
 CLEAR VV52B CLEAR VV300B CLEAR VV300B CLEAR VV300B B CLEAR
 CLEAR VV52B CLEAR VV300B CLEAR VV300B VV300B OB CLEAR
 CLEAR VV300B BLUE VV30B CLEAR VV52B VVCLEAR VV5 CLEAR VV300B
 CLEAR VV52B CLEAR VV300B CLEAR VV300B BLUE VV30B CLEAR VV52B CLEAR
 VV300B CLEARVV300B BLUE VV30B CLEAR VV52B CLEAR VV300B CLEAR VV3

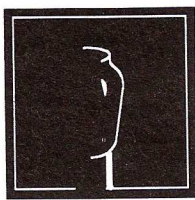
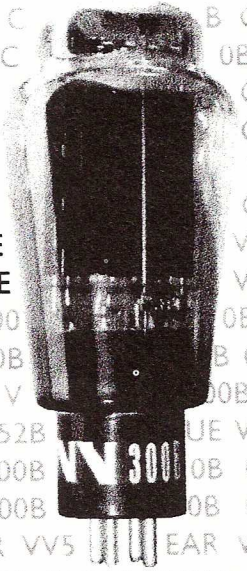

**Welborne
Labs**

PHONE: 303.470.6585 FAX: 303.791.5783 VV52B CLEAR VV300B CLEAR VV300B BLUE VV30B CLEAR
 E-MAIL: WLABS@IX.NETCOM.COM WEBSITE: HTTP://WWW.WELBORNELABS.COM VV300B CLEAR

Design In the "Real McCoy"

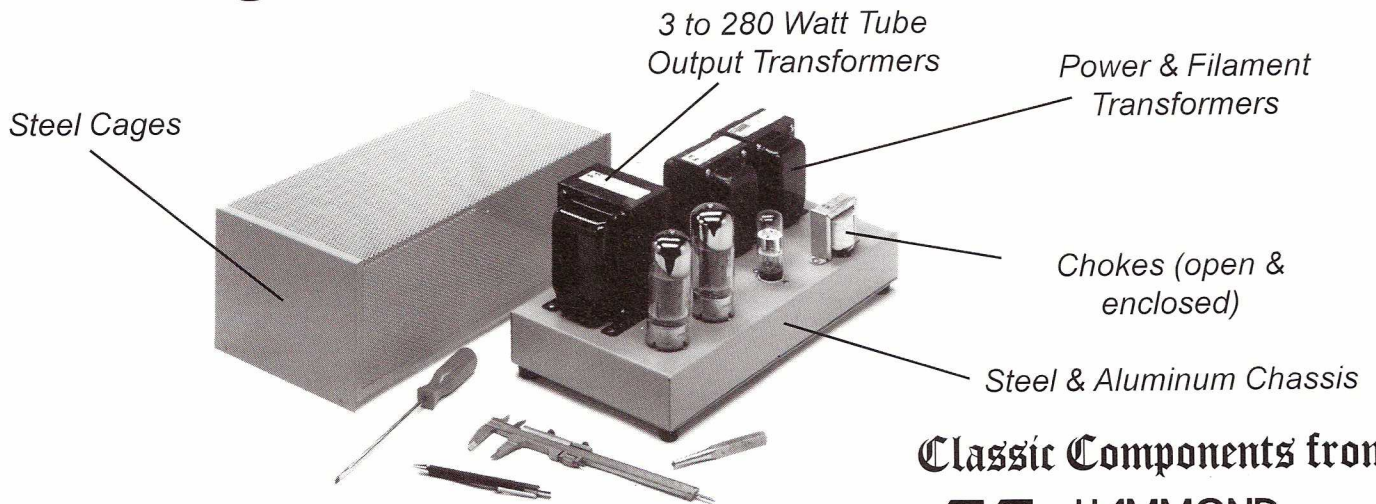

We've been in the transformer & enclosure business for over 70 years. In fact, most of the components shown here have been in continuous production since the 1950's! Trust your design with our experience...

Classic Components from:



4700 Genesee St., Cheektowaga, NY 14225 Phone (716) 631-5700 Fax (716) 631-1156
 394 Edinburgh Rd. North, Guelph, Ontario N1H 1E5 (519) 822-2960 Fax (519) 822-0715

Svetlana Audio Tubes



◀ *"...Svetlana's (SV)6L6GC showed up...and were easily the best-sounding new 6L6s we've heard..."*

*Power Tube Taste Test
Guitar Player Magazine
November, 1996*



▲ *"The Svetlana (SV)6550C beat the pants off my treasured Tung-Sol coke bottles, bass was tighter and more defined. The Tung-Sols had a little too much bass, they were too chesty and tubby by comparison"*

Dan Schmalte
Publisher, Valve Magazine

"To our ears, the best sounding EL34 of the group was Svetlana's Gold Top EL34."

*Power Tube Taste Test
Guitar Player Magazine
November, 1996*

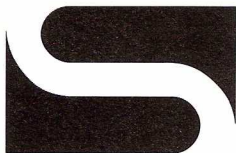

Svetlana
ELECTRON DEVICES

Visit our web site or call for a distributor near you!

Headquarters: 8200 S. Memorial Parkway • Huntsville, AL 35802 • phone (205) 882-1344 • fax (205) 880-8077
Marketing & Engineering: 3000 Alpine Road • Portola Valley, CA 94028 • phone (415) 233-0429 • fax (415) 233-0439

www.svetlana.com

WE HAVE ENOUGH COMPONENTS TO BUILD A SMALL CITY

TUBES:

Over 3500 audio, receiving, transmitting and industrial types in stock, including many foreign and early types. We offer the complete line of Svetlana audio, amateur radio and industrial power tubes.

TRANSFORMERS:

Hard to find power, filament and output transformers as well as filter chokes for tube equipment. We feature HAMMOND, One Electron, MagneTek and Thordarson as well as many new old stock transformers.

CAPACITORS:

High voltage electrolytic and mylar capacitors, multi-section capacitors and more for tube circuits.

PARTS:

Resistors, tube sockets, potentiometers chassis boxes and aluminum enclosures, knobs, dial belt, lamps, diodes, speakers, wire, phonograph needles and cartridges and much more.

LITERATURE:

Extensive selection of literature and books and tubes, hi-fi equipment, circuits diagrams, communication gear and antique radios. Some items not available elsewhere!

SUPPLIES:

Grill cloth, cabinet restoration supplies, batteries, chemicals, tools, test meters, gifts and kits.

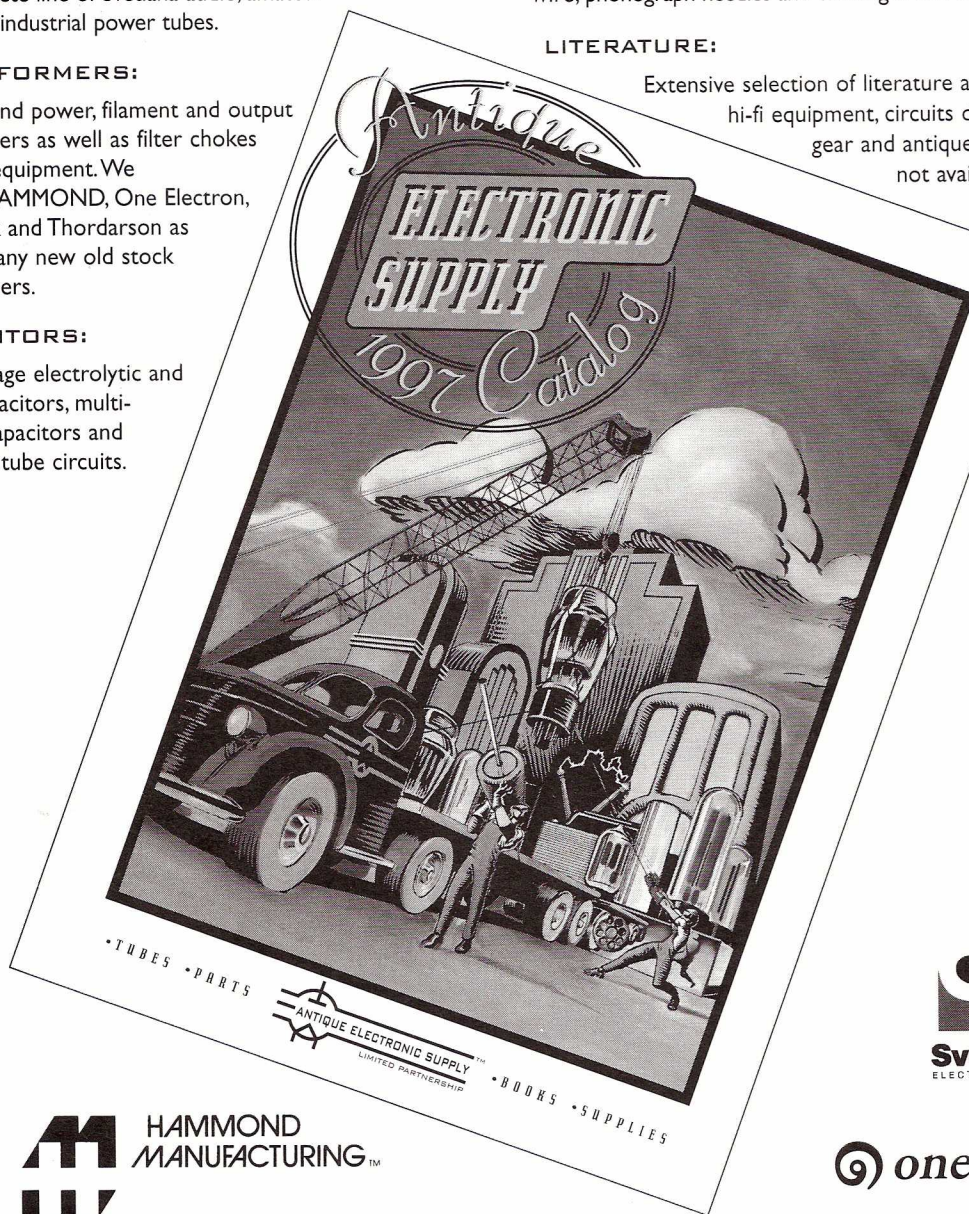

HAMMOND
MANUFACTURING™



Svetlana
ELECTRON DEVICES

one electron™

CALL OR FAX FOR OUR FREE 40 PAGE CATALOG

ANTIQUE ELECTRONIC SUPPLY™

Limited Partnership

6221 S. MAPLE AVE. • TEMPE, AZ 85283 USA
(602) 820-5411 • FAX (602) 820-4643