

VACUUM TUBE VALLEY™

Issue 7
Spring/Summer 1997

Celebrating the History and Quality of Vacuum Tube Technology

Published Quarterly
Price \$8.00

The 6DJ8 and other Frame Grid Tubes

Vacuum Tube Computers

The Savage Art

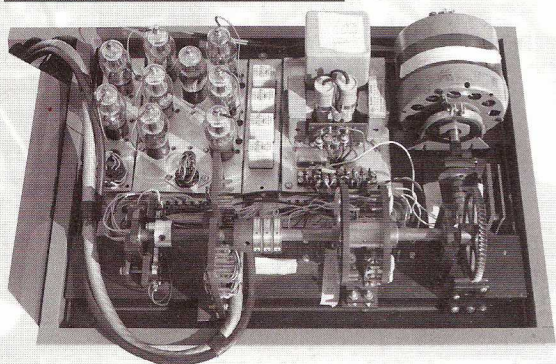

Big-Time Theatre Sound

Altec Lansing Powerhouse



The Peter Jensen Story

Early Sound Amplification

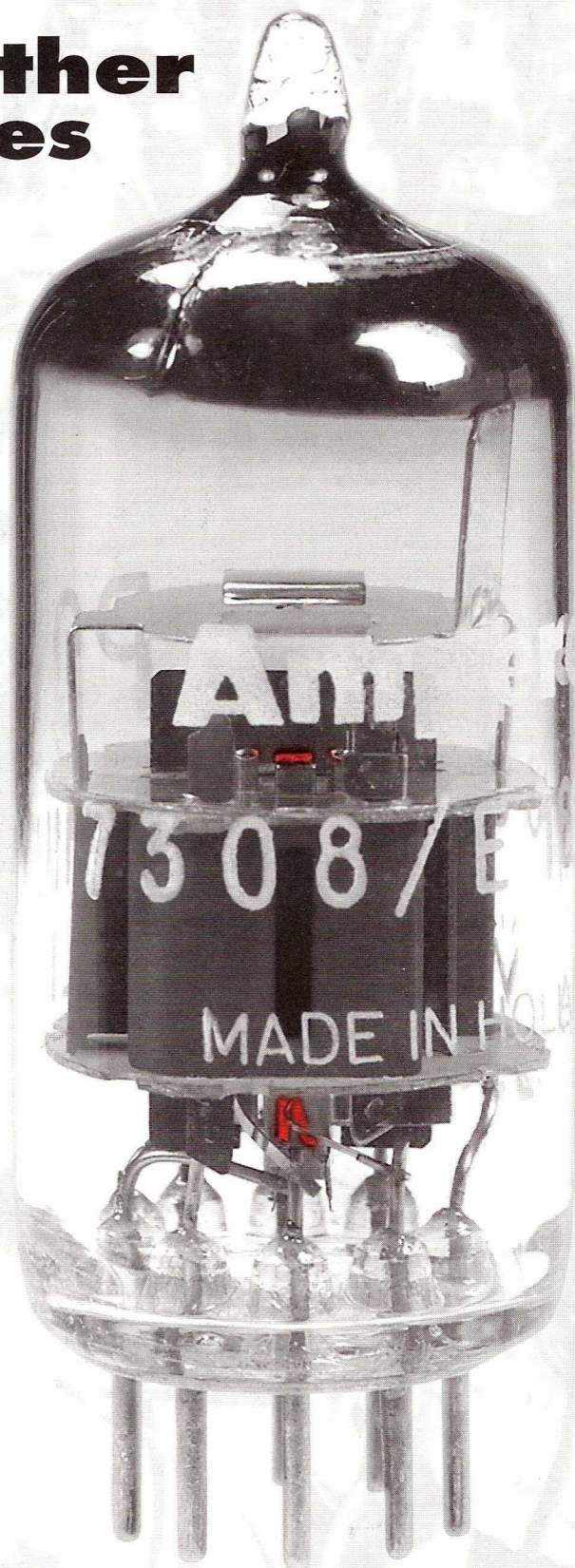

**VTV Issue # 7
Table of Contents:**

**All About the 6DJ8 and Other
Frame Grid Tubes 3**

Listening to the 6DJ8 8

Oscilloscopes - Part 2 10

Altec 1500 Series 13

The Great Voice - Peter Jensen 18

Build A Comparison Preamp . . 24

Antique Sound Lab AQ-1002 . . 26

Computing With Tubes 28

Ceramic Capacitors 31

Computer Video Review 32

VTV at CES 1997 34

Tube Dumpster - 417A/5842 . . 36

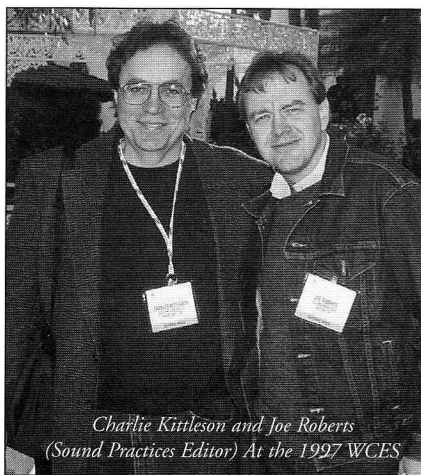

*Charlie Kittleson and Joe Roberts
(Sound Practices Editor) At the 1997 WCES*

New Tubes from Svetlana

Svetlana Electron Devices has recently introduced their version of the **EF86**. This tube features low noise, high gain, internal shielding and gives extremely low distortion in either pentode or triode connection. Retail price of the EF86 is \$14 US.

VTV received pre-production samples of Svetlana's **SV6L6GC**, which is a very close copy of the original Sylvania 6L6GC/STR387. These tubes work very well in guitar amps, both new and vintage. Sonically, they are similar to the original RCA 6L6GC blackplates and the STR387 Sylvania's. Retail price is \$18 US for single tubes and \$24 each in matched pairs or quads. Large quantities of this tube will be available in late 1997.

Svetlana has also introduced an amazing power triode. The new **3CX300A1** looks like a transmitting tube, but is actually a low- μ audio triode. Plate dissipation is 300 watts and plate resistance is 450 ohms. It is an external anode type and requires forced-air cooling. If driven correctly, in Class AB1, a pair of these tubes would produce more than 400 watts!

Pre-production samples of the long awaited Svetlana version of the **300B** power triode were received by VTV for evaluation. The tube is well made, with heavy glass and internal components that appear identical to the original item. It is clearly superior to the other less-expensive 300Bs on the market. It has great bass, extended high frequency response and is extremely musical. The Svetlana 300B will not be available until late 1997. Price has not been determined yet. For more information, contact: Svetlana Electronic Devices, 8200 Memorial Parkway, Huntsville, Alabama 35802, FAX 205-880-8077, Phone 205-882-1344.

Electra-Print Introduces New Transformers

Electra-Print Audio Co. has started manufacture of three new single-ended output transformers intended for maximum-quality

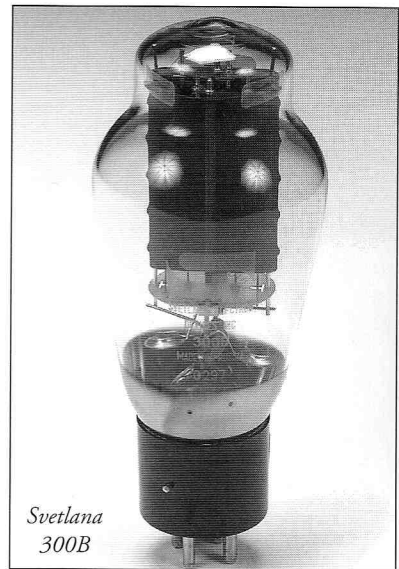

audio. The **BE5KB** is an affordable transformer with a 5000-ohm primary, intended to match tubes such as 45, 50, SV811-3, 300B and the like, running up to 65 mA plate current. The similar **TM3KB** has a 3000-ohm primary, intended for a single 2A3, 6B4G or 300B running at up to 70 mA. Bandwidth of both types is 18 Hz to 40 kHz, -1 dB, with maximum power rating of 10 watts and with output capabilities for 2-ohm through 16-ohm speakers.

For really big power, the Electra-Print **KL10KB** is a perfect match for a single SV572, 211 or 845. Its 10k-ohm primary and 30-watt rating go along with a bandwidth of 19 Hz to 24 kHz at -1 dB--world-class performance for such a high primary impedance.

And finally, Electra-Print has interstage transformers for SE and push-pull applications. The **3533-2** has a primary of 8.5 KOhms and a 1:1 ratio. The primary can handle up to 20 mA of DC plate current. For push-pull, the 3634-P has a 9k primary and center-tapped secondary, with a 17 mA primary current. Contact: Electra-Print Co., 4117 Roxanne Drive, Las Vegas NV 89108, phone (702) 396-4909, fax (702) 396-4910.

EDITORIAL STAFF

- Charles Kittleson** - Editor and Publisher
- John Atwood** - Technical Editor
- Eric Barbour** - Staff Editor
- Terry Buddingh** - Guitar Amp Expert
- Steve Parr** - Art Director
- Julie P. Werner** - Copy Editor

Copyright ©1997 **Vacuum Tube Valley™** and **Big Tone™** All rights reserved. Unauthorized copying or duplication of this publication or any materials within it is strictly forbidden without permission from publisher.

Send circulation and editorial correspondence to:

Vacuum Tube Valley
1095 E. Duane Ave., Suite 106
Sunnyvale, CA 94086 USA
email - triode@vacuumtube.com

Vacuum Tube Valley is published quarterly for electronic enthusiasts interested in the colorful past, present and future of vacuum tube electronics.

Annual subscription (4 issues) is \$32/US \$40/Canada, \$50/Europe \$60 Asia.

Cash, US Bank Check or Credit Cards are accepted as payment.

Phone/FAX 408-733-6146

Web Site: <http://www.vacuumtube.com>

All About the 6DJ8 and other Frame Grid Tubes

By Eric Barbour © 1997 All Rights Reserved

1. Intro

In previous issues of VTV, we have introduced you to many tubes that are now popular for audio use, and nothing but. And we have told you that many of these popular types weren't even intended for the current applications when they were first introduced. So, just to warn you in advance, it's time to do that again.

Many audiophiles today swear by the 6DJ8/6922 dual triode family. They tend to think of these as the most detailed-sounding tubes of all. Yet that whole technology and design was intended for low-noise RF applications, usually in receiver front ends. Audio was hardly considered until the 1970s. These types are constructed with a complex kind of grid which was pioneered in 1948, known as a frame grid. Sophisticated equipment is required to make frame grids, whereas the conventional tube grid is just a spiral of wire wrapped around two soft metal posts. The idea of using frame-grid tubes for hi-fi would have been unthinkable in the early Fifties, but eventually their technical superiority and common manufacture made them viable for home audio equipment.

2. History

Unlike the conventional tube grid, the frame grid is just what it seems. Rather than being wound around a swaged pair of posts, very fine wire is wound onto a rectangular frame of stamped metal, often molybdenum. This gives very consistent grid structures, which allows the grid to be placed closer to the cathode, thus yielding higher transconductance.

Usually, because the frame grid is flat rather than tubular, a pair of grids must be used for a triode, with one being placed on each side of the cathode. A tetrode requires four frames, a pentode six. Many metal/ceramic tubes intended for microwave use had a single frame grid and a flat, one-sided cathode, and were thus known as planar tubes. The extreme consistency of frame grids also tends to produce the most beautiful, consistent plate curves possible, which in turn tends to result in low distortion.

The development of the frame grid took place simultaneously on both sides of the Atlantic, in 1948-49. Tungfram (UK) engineer John A. Sargrove was the forgotten British pioneer of this tube type. He developed the Tungfram UA-55 as a dual-section beam tetrode for audio power applications, ironically. But it was apparently a commercial failure. It was sensitive and was also designed to operate efficiently, giving 1 watt on only 90 volts plate power. This was made possible by the close spacing that frame grids allow.

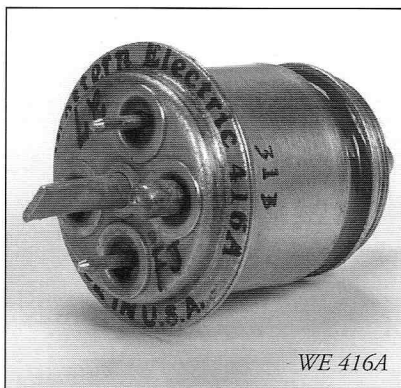

WE 416A

The credit for the frame grid usually goes to J.A. Morton and R.M. Ryder of Bell Telephone Labs. They introduced the 416A triode at the winter 1949 meeting of the AIEE. This remarkable (and odd-looking) metal tube was intended as a microwave RF amplifier for telephone long-distance relay equipment. The extremely fine pitch of the grid wires, 1000 per inch, and their 0.6 mil spacing from the planar cathode were records at the time.

During this time period, some more conventional-style miniature glass tubes were introduced by Bell Labs and manufactured by Western Electric. Besides the 416A, WE also produced the 404A pentode, 417A triode, 418A power tetrode, 435A tetrode, 436A power tetrode and 437A triode during the 1948-1951 period. All of them used frame grids.

Up until that time, there were limits on the capabilities of conventional tube manufacture. To get low noise, the tube

has to have high transconductance; and to use it at UHF or higher frequencies, the tube structure has to be small. The limit given for conventional tube manufacture is usually the 6AK5 pentode, with a rated transconductance of 5000 to 5500 μ hos and a grid-plate capacitance of 0.02 pF. Raytheon's 6AH6 bettered that in 1946, reaching a Gm of 9000 μ hos with some difficulty.

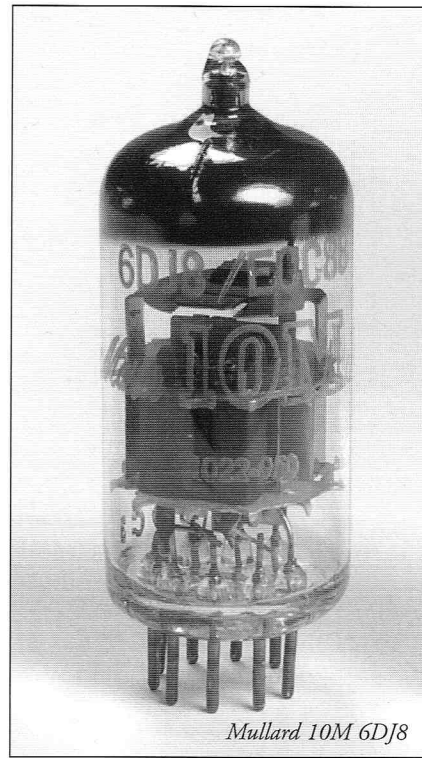

Mullard 10M 6DJ8

Special tubes were developed for UHF before World War II; they were usually made as physically small as possible to reduce capacitance and parasitic inductance, but were not outstanding in transconductance. This family includes the Western Electric "doorknob" tubes such as the 316A, 380A thru 387A, 713A and 717A; RCA's "acorn" series; and the 9000 miniature series. Many were used in early FM broadcast receivers and in UHF military radio equipment of the war. RCA pushed this as far as it would go with the 6J4 in 1944, a UHF triode with Gm=12,000 μ mo. The 6J4 was not very successful. It apparently was very difficult to make, and a high infant-mortality rate may have been the reason for the high price of \$8.35. Imagine paying \$100 today for a small RF transistor--it had better have special characteristics for that price!

The RF performance of such types was acceptable, but not enough for such critical applications as microwave telephone

FIRST
it was
industrial
applications...

THEN
exacting
military
systems...

...and **NOW**
it's the
TV
MANUFACTURER
who sees the solution
to his problems...



The frame grid is the closest approach to the ideal "Physicist's grid"—electrical characteristics but no physical dimensions. It results in: • higher transconductance per milliamperere • tighter G_m and plate current tolerance • low transit time • low capacitances • lower microphonics • rugged construction

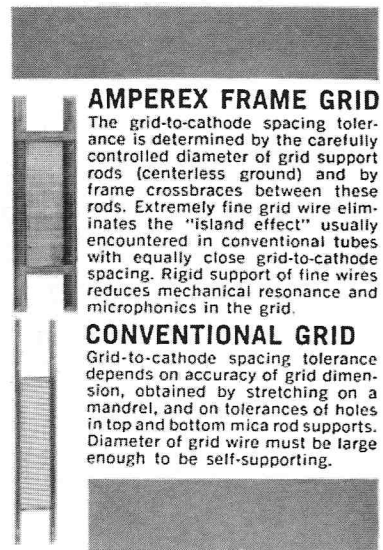

AMPEREX FRAME GRID
The grid-to-cathode spacing tolerance is determined by the carefully controlled diameter of grid support rods (centerless ground) and by frame crossbraces between these rods. Extremely fine grid wire eliminates the "island effect" usually encountered in conventional tubes with equally close grid-to-cathode spacing. Rigid support of fine wires reduces mechanical resonance and microphonics in the grid.

CONVENTIONAL GRID
Grid-to-cathode spacing tolerance depends on accuracy of grid dimension, obtained by stretching on a mandrel, and on tolerances of holes in top and bottom mica rod supports. Diameter of grid wire must be large enough to be self-supporting.

... in

Amperex

FRAME GRID TUBES

FOR TV TUNERS

6ES8
4ES8
6ER5
2ER5
6DJ8

FOR MILITARY REQUIREMENTS
AND
EXACTING INDUSTRIAL APPLICATIONS:

6688
6688A (MIL-E-1/1218)
6922
6922 (MIL-E-1/1168)
5847 (MIL-E-1/467)
5842 (MIL-E-1/466)

AVAILABLE FROM ALL
AMPEREX FRANCHISED DISTRIBUTORS

systems and specialized military equipment. AT&T wanted to expand long-distance networks after the war, and microwave was seen as the only cost-effective way to do it. So the development of frame-grid tubes was sparked by telephone application more than any other. RF transistors were awful until the 1960s, and so frame-grid tubes like the venerable and popular 417A ruled the VHF and UHF bands. Some high-performance 2 meter amateur receivers and converters of this era used 417A front ends.

The race for more transconductance continued through the 1960s. GE held many of the records with their ceramic planar triodes, starting with the 7077 in 1954 ($G_m=10,000$) and moving all the way up to the 7768 ($G_m=50,000$) and the 8917 ($G_m=65,000$), which has been unbeatable since the late 1960s except by some bipolar transistors and very exotic MOSFETs.

I should also note that the tubes are much more linear than the MOSFETs. Tubes follow a $3/2$ power relationship, while MOSFETs follow a square law and bipolar transistors follow an exponential relationship. The transconductance of the transistors varies considerably with drain or collector current, as well as with the ambient temperature; while tubes vary in transconductance only moderately with plate current, and hardly at all with temperature. The input capacitance of transistors (especially MOSFETs) changes dramatically with bias. In spite of 40 years of aggressive R&D on semiconductors, frame-grid tubes remain very close in RF noise performance to the world's best transistors.

And frame-grid tubes have other advantages over the current crop of semiconductors: high tolerance of ESD and EMP, wider dynamic range due to high-voltage operation, and a tendency towards lower distortion. Even so, the mainstream electronics industry has declared tubes obsolete. See the Rohde article in the bibliography (page 8) for an example of this anti-tube bias, written by a well-known expert in microwave electronics (who presumably should know better). Rohde used the 417A as an example to prove that tubes are noisier than the best GaAs FET, yet he was only able to show a 0.6 dB difference.

Some of the R&D for frame-grid tubes rubbed off onto power types like the Sylvania 8417 audio beam power tube ($G_m=23,000$). These latter two types had conventional construction but incorpo-

1957 Amperex Ad

ALL ABOUT THE 6DJ8

rated some special manufacturing processes derived from frame-grid methods. Sylvania developed a few frame-grid power tubes for TV sweep and audio applications; this included the 6FG6 and 6DY7, which we will cover in a future article. By the 1960s, frame-grid tubes became common in TV sets. Single-section variants of the 6DJ8 such as the 6EH5, 6GH5, etc, replaced the dual-triode cascode as the front-end RF tube. Frame grid pentodes such as the 6EH7, 6EJ7 and 12GN7 were used for IF and video amplifiers.

The 6DJ8 was introduced in 1957 by Amperex, the American division of Philips. It was developed by Philips in Holland, under the European standard designation ECC88, and intended as a cascode amplifier for television VHF and UHF tuners, nothing more. The series-string version, 7DJ8/PCC88 was also introduced at this time. It was apparently a higher-performance descendant of the 6BQ7 dual triode, which was also intended for RF cascode circuits. The 6DJ8 became a popular type, especially when the engineers at Tektronix discovered it. They found that it was consistent enough for their oscilloscopes, and gave excellent pulse fidelity. So, it can be found in the sweep and vertical amplifiers of Tek's major tube scopes, starting in 1959. Since the 6DJ8 was low in cost, it also ended up in a great deal of military and commercial radio equipment.

It first appeared in home hi-fi equipment as a front end for FM tuners. The classic Fisher FM-90X tuner was the first to use the 6DJ8 in 1957, although the tube was a developmental unit at the time. Fisher called it a "Gold Cascode", and for a time it was exclusive to Fisher. But everyone wanted this hot tube, so it was issued a standard RETMA code: 6DJ8. For many years, Amperex/Philips was the major source, with Siemens, Telefunken, GE and Sylvania weighing in with their own versions later.

Premium 6DJ8 types appeared during 1959 to 1961. The 6922 was an industrial version, introduced in the USA by Amperex. The rare and expensive 6922-PQ version was from Amperex, with gold-plated pins and having the two triodes in each envelope carefully matched. This was an early example of a "super-premium", although this was done by the original manufacturer and for use in critical applications, not audiophile equipment. Many PQs were used by Los Alamos National Laboratory in custom-built electronics. Siemens introduced their own super-6DJ8 at the same time,

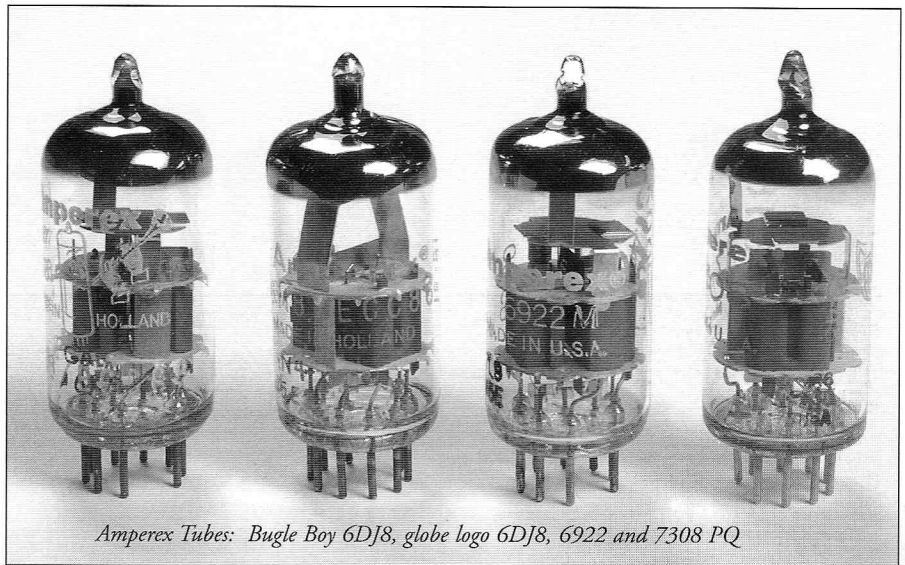

Amperex Tubes: Bugle Boy 6DJ8, globe logo 6DJ8, 6922 and 7308 PQ

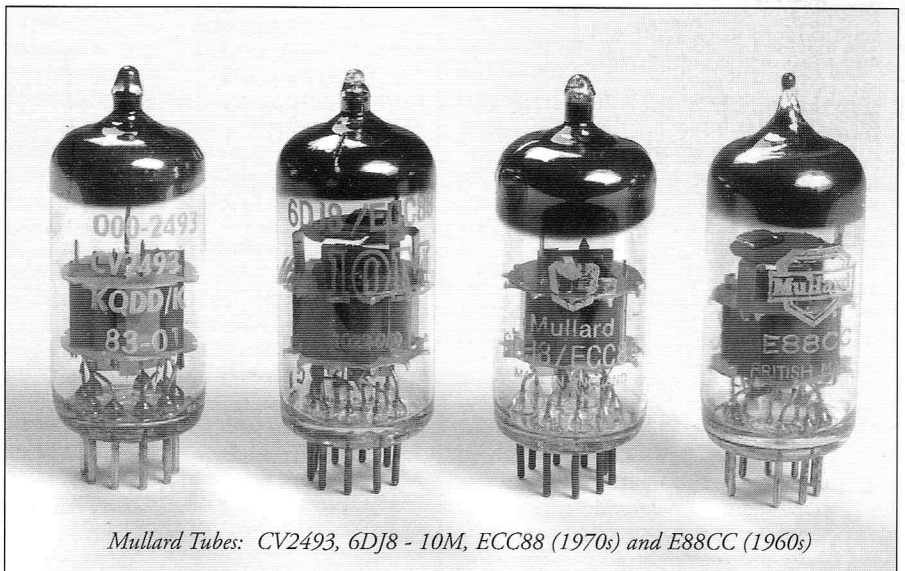

Mullard Tubes: CV2493, 6DJ8 - 10M, ECC88 (1970s) and E88CC (1960s)

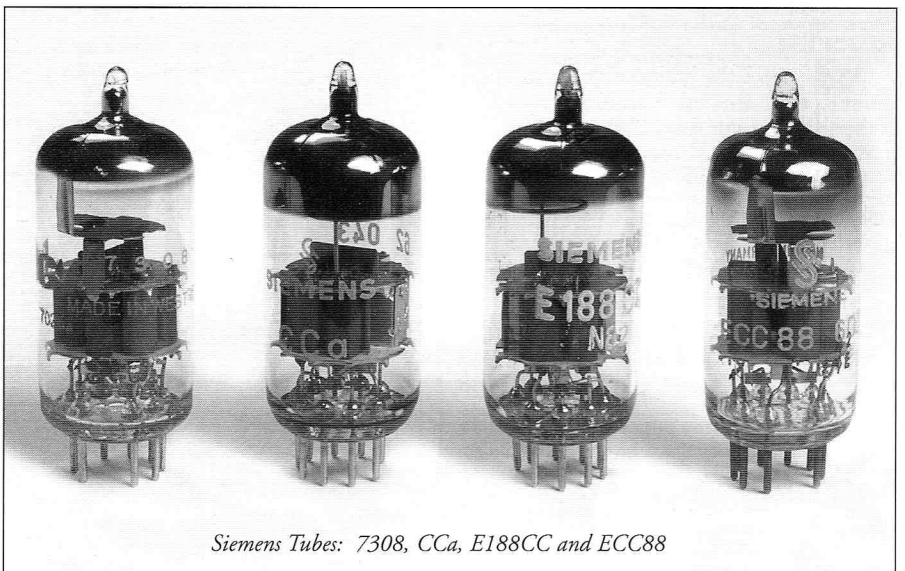

Siemens Tubes: 7308, CCa, E188CC and ECC88

in the form of the type "CCa". Apparently this was a contraction of the original European designation for the 6922, E88CC, with the "a" indicating a premium version. In 1961, Amperex introduced a special version, the 7308. It was the first to have guaranteed low microphonics, suggesting use as the input stage in high-gain audio as well as RF preamps.

Nevertheless, these tubes were used primarily in VHF receivers, TV sets, test equipment and nuclear instrumentation. One of the first audio uses for the 6DJ8 was the Marantz 9 power amp of 1960. This was one of the first "high-end" audiophile amps ever made, long before the term "high-end" existed. Its use in the 9 guaranteed that the 6DJ8 would have a certain cachet with audiophiles. The 9 is now a rare collector's item, so popular in Asia that Marantz recently reintroduced it, with the same circuitry and most of the same components.

In the late 1970s, Audio Research introduced the SP-6E preamp with two 6DJ8s in the phono stage. This was followed by the SP-8, then by the massive SP-10 which used them in all the gain stages. Since then, the 6DJ8 has pushed the 12AX7 out of most high-end preamps. Currently, the 6DJ8 (or 6922--the two types are basically interchangeable) is found in preamps and other equipment by Audible Illusions, Sonic Frontiers, Melos, Dynaco, Balanced Audio, Music Reference and too many others to remember.

3. Tests

Because of the ongoing popularity of the 6DJ8 family in high-end audio, we decided to gather some NOS samples and subject them to the same distortion testing that we had previously done to the 12AX7. After the tables, we discuss the results and some more applications info about these popular dual triodes.

Table 1: Distortion tests at 10 vrms out, 48k ohm plate load. Listed in order of increasing 2nd harmonic distortion. *= good used tube. B+ was 250v, filament 6.3vdc.

Type	Distortion:	2nd	3rd	Bias
6922 Sovtek 90s	.037%	.027%	-1.10	
CCa Siemens 60s	.055	.055	1.31	
6922 Sovtek 90s	.060	.040	-0.81	
6DJ8 Golden Dragon 90s*	.062	.052	0.74	
ECC88 Russian 70s	.065	.055	-0.67	
6922 RCA/Siemens 1965	.070	.050	-1.11	
6DJ8 Amperex bugle 1962	.072	.055	-1.20	
6DJ8 RCA/Siemens 1966	.072	.055	-0.92	
6922 GE/Telefunken 70s	.072	.057	-0.84	

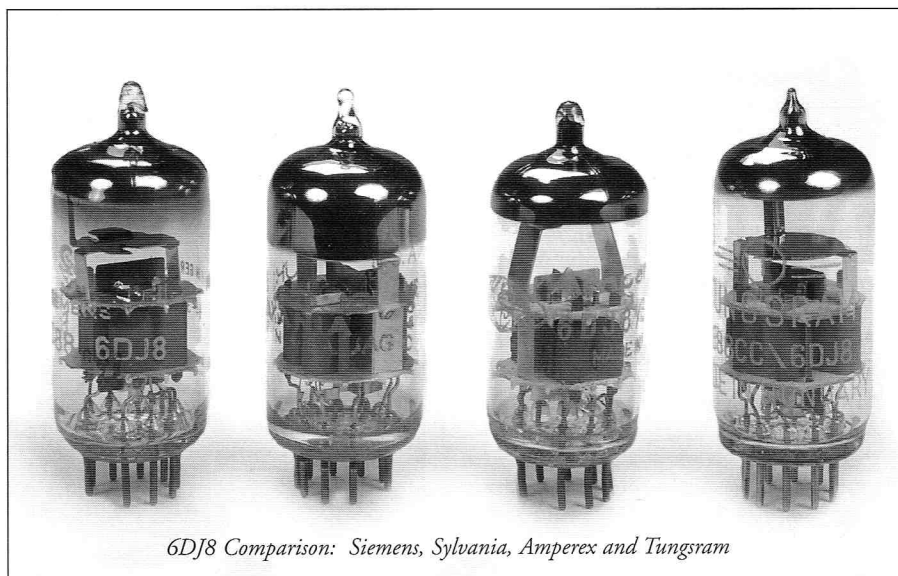

6DJ8 Comparison: Siemens, Sylvania, Amperex and Tungram

6N23P/6922 Russian 90s.	.075	.047	-1.07	6DJ8 Amperex bugle 60s*	.092	.052	-0.81
6922 RCA/Siemens 1973	.075	.052	-1.04	6DJ8 Amperex bugle 60s*	.092	.067	-0.78
6922M PQ Amp1965	.075	.052	-1.29	6DJ8 HP/Amperex 60s*	.092	.070	-0.73
6DJ8 West./Siemens 1962	.077	.065	-1.24	6DJ8 HP/Amperex 60s*	.092	.072	-0.66
6DJ8 Golden Dragon 90s*	.080	.052	-0.82	6DJ8 Telefunken 60s*	.095	.047	-0.85
6922 Heinz-Kauf. 1972	.080	.055	-0.95	6DJ8 HP/Amperex 1974*	.095	.072	-0.73
6DJ8 Amperex bugle 1962	.082	.060	-0.79	CCa Siemens 60s*	.097	.072	-1.16
6DJ8 Telefunken 60s	.082	.060	-0.82	6922 Sylvania JAN 1972	.097	.075	-0.88
6922 Siemens 60s	.082	.060	-0.84	6922 PQ Amperex 60s*	.100	.060	-0.67
6DJ8 Amperex 1977	.082	.065	-0.90	6DJ8 Amperex bugle 60s	.100	.062	-1.20
6922 Sovtek 90s	.085	.050	-0.75	6DJ8 Amperex 60s*	.100	.065	-1.03
6DJ8 Mullard (Brit) 60s	.085	.057	-1.30	6DJ8 GE 70s	.100	.070	-1.30
6DJ8 Gold Aero 80s*	.085	.057	-0.97	6DJ8 Amperex 60s*	.102	.060	-1.04
6DJ8 West. (USA) 1963	.085	.070	-0.96	6DJ8 Amperex bugle 60s*	.102	.065	-1.02
6N23P/6922 Russian 90s	.090	.055	-1.10	6922 Amperex PQ 1962	.102	.065	-1.01
6922 Amperex bugle 60s*	.090	.057	-0.68	6DJ8 HP/Amperex 60s*	.102	.065	-0.69
6DJ8 RAM Labs 90s*	.090	.057	-0.80	6DJ8 Amperex bugle 60s	.102	.070	-1.22
7308 PQ Amperex 60s	.090	.060	-1.22	6DJ8 CBS/Siemens 1960	.105	.050	-1.23
6DJ8 Syl (USA) 60s	.090	.070	-1.12	6DJ8 Amperex bugle 60s	.105	.065	-1.12
7308 RCA/Siemens 1969	.090	.070	-1.03	6DJ8 Amperex bugle 60s	.105	.065	-0.65
6922 Sovtek 90s	.092	.045	-0.92	6DJ8 Amperex bugle 60s*	.105	.067	-0.99

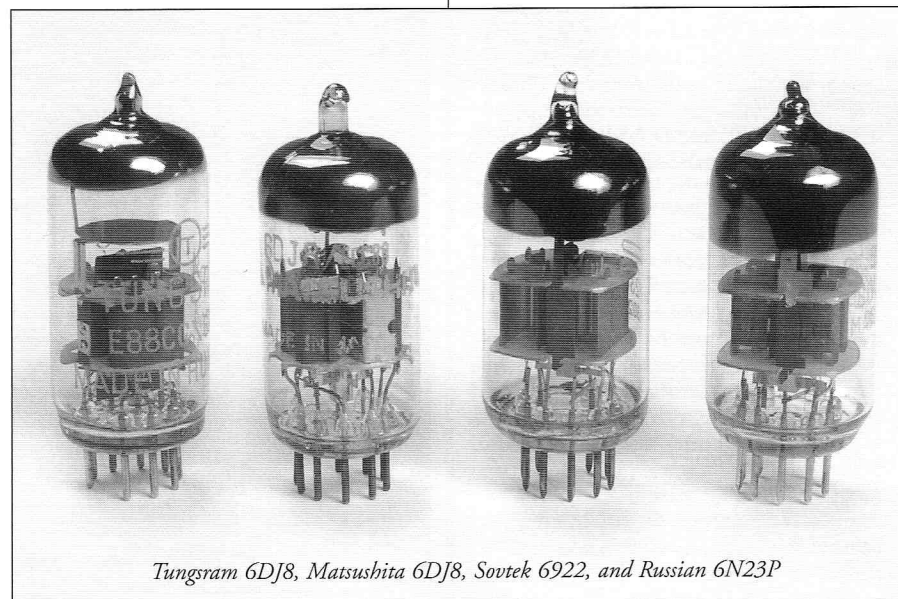

Tungram 6DJ8, Matsushita 6DJ8, Sovtek 6922, and Russian 6N23P

A L L A B O U T T H E 6 D J 8

7308 Raytheon(USA) 1968	.105	.070	-1.10
6DJ8 Tektronix/Amp 60s*	.107	.060	-1.60
6DJ8 Siemens 80s*	.107	.067	-0.97
CCa Siemens 60s*	.107	.080	-1.02
6DJ8 Telefunken 1972*	.110	.057	-1.23
6DJ8 Amperex 1975	.110	.065	-0.99
6DJ8 Amperex bugle 1967*	.110	.067	-0.71
6922 JAN Amperex 1971*	.110	.075	-0.98
6DJ8 GE 70s*	.112	.065	-0.90
6DJ8 Amperex 1975	.112	.067	-0.89
6DJ8 Amperex bugle 60s	.112	.075	-1.20
6DJ8 Amperex bugle 60s*	.112	.075	-1.53
6DJ8 West./Siemens 1961	.112	.085	-1.33
6922 JAN Sylvania 1972*	.112	.090	-0.58
6DJ8 Amperex bugle 60s	.115	.072	-1.16
6DJ8 Mullard/Philips	.115	.072	-1.05
6DJ8 Amperex bugle 60s*	.115	.080	-0.68
6KN8 IEC (Japan) 70s	.115	.090	-1.24
6922 JAN Amperex 1967	.117	.072	-0.98
6DJ8 Amperex bugle 60s	.120	.072	-0.99
6DJ8 Amperex bugle 60s*	.120	.075	-0.73
6922 JAN Sylvania 1977*	.125	.082	-1.01
6DJ8 Amperex bugle 60s*	.125	.087	-0.75
6922 JAN Sylvania 1970*	.130	.072	-0.82
6DJ8 Amperex bugle 60s*	.140	.107	-0.73
6922 JAN Sylvania 1973*	.145	.087	-0.85
6922 JAN Sylvania 1977*	.150	.100	-0.93
6ES8 Amperex bugle 1967	.212	.200	-1.06
6ES8 RCA/Mullard 70s	.235	.215	-1.26

Table 2: Averages and RSDs (regular standard deviation) of 2nd harmonic distortion for most common versions.

Version	2nd	RSD	#
Sovtek 6922	.0685	.0251	4
Siemens 6922,7308,CCa	.0823	.0175	7
Siemens 6DJ8 (various)	.0946	.0186	5
Telefunken 6DJ8s	.0957	.0140	3
Amperex 6922 (various)	.0990	.0149	6
Amperex 6DJ8 (various)	.1041	.0140	29
Sylvania JAN 6922	.1265	.0199	6
6ES8 RCA/Amperex	.2235	.0115	2

Table 3: Some of the same tubes above, tested as above, but with a 12k-ohm load resistor. This information is NOT intended for tube selection guidance, but only for illustration of how distortion can vary (or not) with plate load. Arranged by increasing 2nd harmonic distortion.

Type	Distortion:	2nd	3rd	Bias
6922 Sovtek 90s	.015	.025	-0.91	
6922 Sovtek 90s	.050	.060	-0.88	
6DJ8 Golden Dragon 90s*	.057	.040	-0.83	
6DJ8 Golden Dragon 90s*	.060	.050	-0.82	
6DJ8 Tektronix/Tele 60*	.065	.060	-1.23	
6DJ8 Siemens 80s*	.072	.057	-0.92	
6DJ8 Amperex bugle 60s*	.082	.070	-0.60	
6DJ8 RAM Labs 90s*	.085	.070	-0.80	
6DJ8 Amperex bugle 1967*	.090	.065	-0.67	
6922 PQ Amperex 60s*	.100	.062	-0.61	
6DJ8 GE 70s*	.105	.070	-0.83	
6DJ8 CBS/Siemens 1960	.107	.072	-1.19	
6DJ8 Amperex bugle 60s*	.190	.067	-0.83	

4. Summary

Even though the Russian 6922s came out on top in distortion, they would

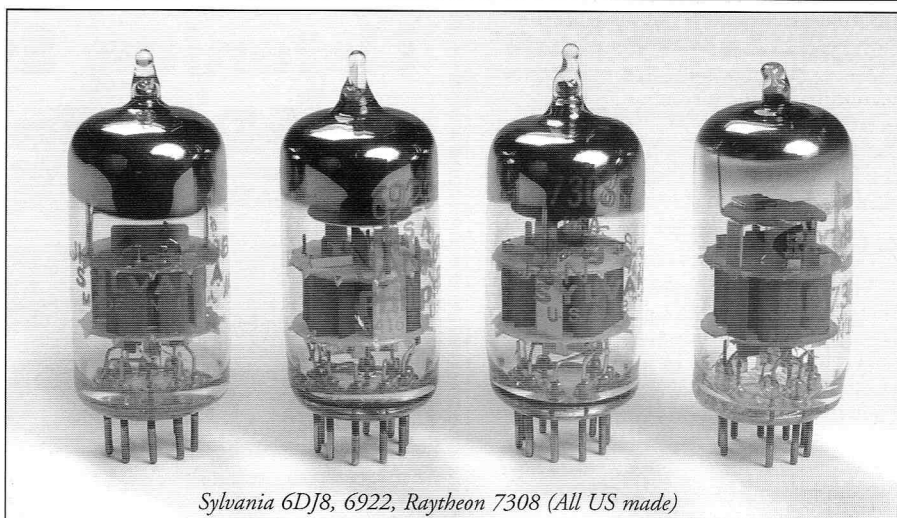

Sylvania 6DJ8, 6922, Raytheon 7308 (All US made)

obviously benefit from grading and selection. The Sovteks were highly variable, even among the 4 samples tested. One major advantage for the NOS tubes by Amperex (made by Dutch Philips), Telefunken and Siemens is that they are reasonably consistent. Note that their RSDs were lower than for the Sovteks, in spite of a range of many years of manufacture. A general consensus of users is that the Sovtek 6922 is good, but not quite as smooth as the NOS types.

The Sylvania JAN 6922s were not the greatest, and my listening tests tend to confirm this. These are common military surplus from the 1970s and 1980s. And as you've seen in Glass Audio, beware of 6ES8s relabeled as 6DJ8 types. 6ES8 is a remote-cutoff version, and will work in the socket but will give much higher distortion. There is at least one dealer relabeling 6ES8s, and I have been unable to find out who.

There are a lot of Amperexes shown here because they were the biggest sellers for many years, and are often found in old test equipment. It should be noted that not all of them had the Bugle Boy logo; it was dropped around 1970, and subsequent tubes just had the Amperex globe.

European versions were often relabeled; witness the Siemens units with CBS and Westinghouse marks from the 1960s. GE was the only major American 6DJ8 manufacturer aside from Sylvania, and theirs were distinctive--inside the glass is a thin Aquadag coating.

The Sovteks are quite different from the generic Russian 6N23Ps shown here. These tubes are said to be made in the same plant (Reflector Saratov) but are obviously different tubes, even though

they are both sold in the West as 6922s. Either one is acceptable, though the 6N23Ps did not do as well in listening tests in line stages. Phono stages seem to be less critical of sound quality than line stages and are better places to save money, although noise and microphonics become more important in low-level phono preamps and individual selection can be necessary, even with frame-grid tubes.

The appellation 6922/E88CC no longer means what it once did: a high quality version. The old 7308, CCa and PQ were super-premium versions, with guaranteed matching between the two triodes and other characteristics tested for and controlled. They could be discerned by the gold plating on their pins. This was unusual until recently--all kinds of cheap tubes are now sold as premiums, and have gold plating on the pins. In the 50s and 60s, gold pins meant quality. Today it's just a marketing ploy. Given a choice between a dirty, used Bugle Boy and a beautiful Russian with gold pins, I'll clean off the dirt, thank you.

A few notes about the test conditions: the load resistance is a relatively high 48k ohms, because this is seen in older 1970s preamps that take 6DJ8s. Most high-end equipment since then has used active loads, and runs 6DJ8s very hard (10-12 mA per triode is typical). These tubes will give lower absolute distortion figures in the actual preamps or amps, but will tend to wear out much faster. If you don't believe me, ask any Audio Research SP-12 owner.

We left out input signal levels, seen in the 12AX7 list in VTV #1, because tubes in the 6DJ8 family seem to vary less in gain, much less than 12AX7s.

Microphony was also not tested for in this series of tests. However, as with 12AX7s, the bias point that gives lowest second harmonic distortion can vary greatly from tube to tube; so that changing to an identical new tube can change the sound character. There's another argument in favor of matching and grading.

4. Outro

The 6DJ8 is permanently ensconced in the audio world. Although it sees little use in pro-audio equipment or guitar amps, it is dominant in high-end preamps and in some power amps. Continued manufacture in Russia and China are assuring its availability. In an era when most high-gain RF tubes have become thoroughly obsolete by proxy, one RF type has survived by becoming an audio tube.

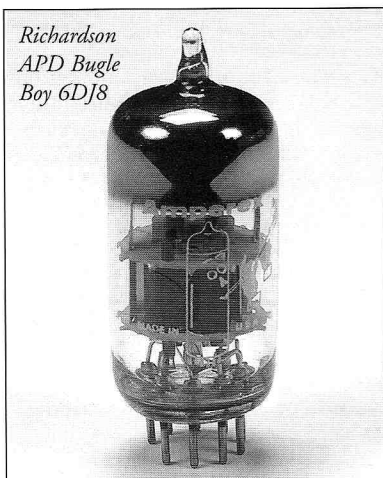

Bibliography

1. "Special Tubes for Broad-Band Amplifiers," **Electronics**, January 1952, p. 203.
2. Advertisement for Raytheon 6AH6, **Proceedings of the IRE**, December 1946, p. 20A.
3. Advertisement for RCA 6J4, **Proceedings of the IRE**, July 1944.
4. J. L. McKain and R. E. Schwab, "A Frame-Grid Audio Pentode for Stereo Output," **IRE Transactions in Audio**, July-August 1959, p. 101.
5. Ulrich L. Rohde, "Differences Between Tube-Based And Solid-State Based Receiver Systems And Their Evaluation Using CAD," **QEX ARRL Experimenter's Exchange**, April 1993, p. 3.

Listening Evaluations of 6DJ8 Tubes

By Charles Kittleson © 1997 All Rights Reserved

Over the last several months, VTV conducted what are probably the first ever published listening evaluations of the 6DJ8 family of tubes. Using the preamp tube evaluator built by Eric Barbour featured elsewhere in this issue, Steve Parr, Terry Buddingh, Don Pettee, Eric Barbour, John Atwood and I listened to what seemed like a hundred different types and varieties of the 6DJ8.

Amplifiers used included an upgraded Scott LK-150, an AudioNote Kit One SE-300B, a Dynaco Stereo 70 and the One Electron Randall Amplifier. Speakers were Klipsch Chorus Ones and B & W DM 110s with a modified Elite CD player or the prototype Dynaco CDV-Pro CD player. Program material included various classical, jazz, vocal and rock CDs including: "The Best of Chesky - Volume 1," Chuck Loeb "Simple Things" and other good recordings.

We noted in our listening tests that the 6DJ8 is not the most neutral sounding tube. The typical 6DJ8 is lacking in bass and mostly tilted to the upper mids and highs. Even in this frequency range, many examples tended to be two dimensional and "transistor" sounding when compared to a good 6SN7 or a 12BH7. Used with the SE 300B amplifier, 6DJ8s were smoother sounding than when used with push pull ultralinear amplifiers, where they was harsher sounding.

Many modern tube audio designers prefer this tube over dozens of others that are available. Witness the significant number of modern tube preamps using 6DJ8s. They are probably used because of their high transconductance (gain), ability to use low plate voltages and ready availability. However, most modern 6DJ8s can be prone to microphonics and are short-lived due to modern designs that push the tube hard. The best sounding European 6DJ8s are rare and expensive. Typical prices of European-made Amperex Bugle Boys, Amperex PQs, Mullard 10Ms and Siemens types now range from \$50 to 75 each and climbing!

NOTE: When reading the following listening evaluation, remember that this is a subjective test and our opinions may be different than yours. Your system is

probably different and you may be perfectly happy with your 6DJ8s and the equipment that uses them. However, readers should be open to other opinions in order to learn more about the hobby and potential sonic improvements to their system. The following is a summary of the listening evaluations:

Amperex

6DJ8 Bugle Boy (Dutch -1964) - Good lows and mids, but the highs were a bit brighter than the Siemens. Used in a lot of test equipment in the 1960s, many used examples available.

6DJ8 Globe Logo (West German-1970s) - Similar to early Bugle Boy. Great bass and very good musical involvement.

6922 (US-PQ 1965) - Balanced, but somewhat harsher than Euro 6922s. Two-dimensional and drier sounding than Bugle Boy.

7308 (US-PQ 1973) - Glorious, involving and well-balanced with very smooth highs. We also listened to a 1968 version of the 7308 PQ which was very musical and live sounding. Lots of air, smooth and pleasant sounding. A great sounding tube!

6DJ8 Bugle Boy (Richardson 1997) - This tube is a tested and graded ECG/Phillips. It was cleaner sounding than the current Chinese and Russian types and had less distortion that typical, out-of-the-box military surplus types. However, it was not up to the musicality of the top-rated Dutch manufactured Amperexes and Siemens tubes.

8223/E288CC (Euro-1970s) - This is the tall version of the 7308. More gain and slightly more forward than a 7308.

General Electric

6DJ8 (1963 US) - Fat mids and upper mids, a little light on the bass. Not as balanced as a Telefunken or Siemens.

6BQ7 (1960s US) - Not really a 6DJ8, but has the same pin-out. Balanced and smooth sound, but lacking any significant high frequency detail. Very microphonic and two-dimensional sounding.

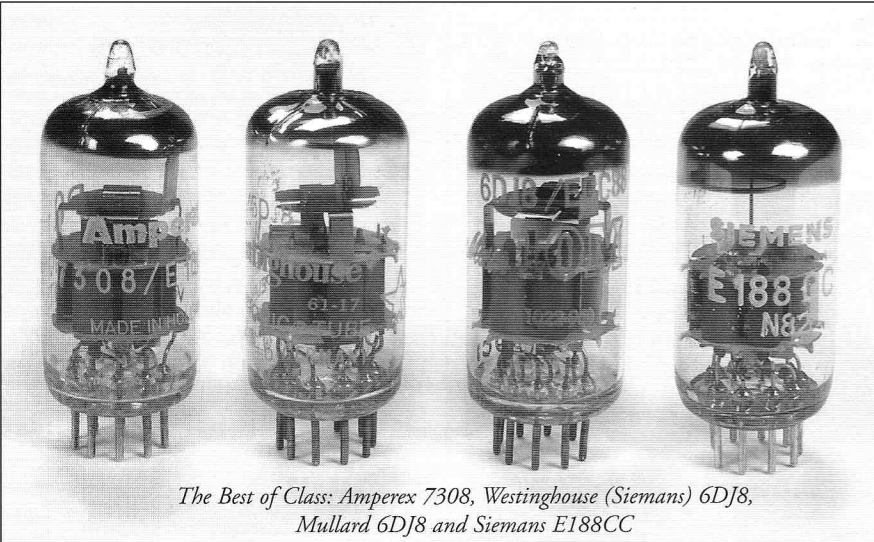

The Best of Class: Amperex 7308, Westinghouse (Siemens) 6DJ8, Mullard 6DJ8 and Siemens E188CC

Matsushita

6DJ8 (Japanese 1970s) - Balanced, clear sound. Very listenable with translucent highs.

Mullard

10M - 6DJ8/ECC88 (1960s British) - A natural, musical and sweet sounding tube. Highs were smooth and not sibilant.

E88CC (1970s British) - Another smooth and musical tube, but a little thin on the top.

CV2493 (British Military 1983) - Lively, musical and 3D sounding. A balanced musical presentation. Appears to be a good value.

Raytheon

7308 (US 1968) - Smooth musical performance with balanced mids and highs.

Russian Types

Sovtek 6922 - Bright and tizzy sounding, but has better bass than other Russian types of 6DJ8s. (Most common type used in modern preamps)

6H23P/6922 - Harsh, spitting highs with etched, sibilant sound. Reasonable low frequency performance. (Note: This tube is very often remarked as "Made in England" and "Mullard," so be aware! The fat envelope is a give-away that this a Russian tube).

Siemens

CCa (West German 1962) - A tube with great balance and imaging. Three-dimensional sounding with balanced, deep bass performance.

6DJ8 (West German 1964) - Highs not as extended as other Siemens tubes. Not a lot of instrumental separation and slightly congested sounding.

6DJ8 (West German/ Westinghouse Brand 1961) - Sweet highs with a nice musical presence.

6DJ8 (West German/RCA Brand 1969) - Typical Siemens sound with rich mids and good musical separation.

E188CC/7308 (West German 1980s?) - Very detailed, but highs not super-extended. Bass is not as deep as Amperex 7308 PQ.

Sylvania (US Manufacture)

6DJ8 (JAN 1966) - Smooth sounding, but slightly congested top end. Other than that, a competent performer.

6922 (Philips/JAN 1986) - Better bottom end than Russian types. High frequencies not as offensive. Midrange is acceptable. Due to price and availability, this tube is a best buy.

7308 (JAN 1970) - Bright and sibilant sounding with a raw top end.

Telefunken

6DJ8 (West German 1964) - Smooth and realistic highs. Lots of air and depth with excellent imaging.

ECC88/6DJ8 (West German 1963) - Great imaging with smooth, detailed highs and balanced presentation.

Tungsram

E88CC (Hungarian 1980s) - Very detailed, but forward sounding. More gain than other 6DJ8s and a slight amount of upper-end sibilance.

**Vacuum Tube Valley
Tube School Special
Announcement**

The first Practical Tube Audio Seminar was held in San Mateo, CA on June 1. As anticipated, the event was a huge success. If there is regional demand for this class, we will hold it on the East Coast, Midwest or other areas of the country.

NOTE: We have a few class manuals and tube school t-shirts available for \$50 ppd in US and \$75 ppd Europe or Asia. Send payment to VTV in Sunnyvale, CA.

The Winners Are:

For the most musical and involving performance, we recommend:

1. Amperex 7308 PQ - Very dimensional and musical with smooth, balanced highs.
2. Siemens 6DJ8 (1960s West German) - Balanced sound, smooth and detailed. This tube does almost everything right.
3. 10M Mullard ECC88 (1960s British) - Natural and sweet sound with good balance. Minimal, if any sibilance.

The above tubes are becoming rare and costly, so get your lifetime supply now!

For those on a budget, the JAN/Philips 6DJ8 and 6922 are capable of good sound at a reasonable price. To get the best performing and select versions of these tubes, try the newly introduced Richardson/APD Bugle Boy 6DJ8s*. These tubes are burned in at full load for 24 hours on the original Amperex burn-in rack. Then, each triode is matched and they are selected for lowest distortion. They are not made in Holland like the original Bugle Boys, but they are still available at reasonable prices and are good performers.

*NOTE: Richardson/APD has purchased the rights to use Amperex and Bugle Boy trademarks on their products.

VTV ISSUE #8

Featured articles:

- 6BQ5/EL84 Tests
- 300B Listening Evaluations
- Tube Mfg. in New Jersey and much more!!!

The Audio Test Bench

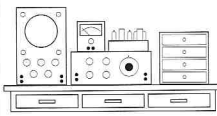

by
John Atwood

Oscilloscopes, Part 2

In the last issue, the theory and choice of oscilloscopes were covered. We now turn our attention to typical audio applications of oscilloscopes. By no means all possible applications can be covered here, but the basic ones will be. Once the reader becomes familiar with these techniques, other uses should spring to mind. Not included here are techniques specific to digital, television, industrial and some RF uses.

Frequency and Phase Measurements

One of the simplest uses of an oscilloscope is to compare the phase or frequency of two signals by the use of Lissajous patterns. The oscilloscope is put into the "X-Y" mode (no time base is used), one signal is fed into the X (horizontal) input, the other is fed into the Y (vertical) input, and the gains are adjusted so that both signals have the same amount of deflection. If the signals are exactly identical, and in-phase, a 45° line will be formed. If the signals are sine waves, and they are out of phase, but the same frequency, a circle or ellipse is formed. If the signals are not the same frequency, but harmonically related (i.e. 2:1, 1:2, 3:4, etc.) then a more complex pattern is produced that indicates the harmonic relationship. These Lissajous patterns have been cataloged to show these relationships.

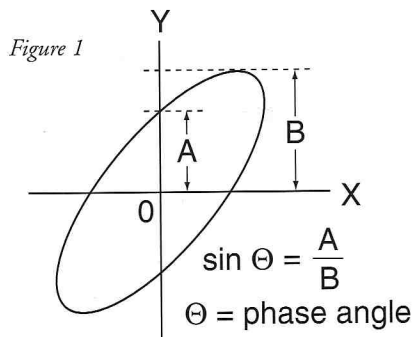

Figure 1 shows how the phase difference of two sine waves can be calculated. Figure 2 shows typical Lissajous patterns. Lissajous patterns were very popular in the early days of electronics when frequency counters were expensive or non-

existent, phase meters were expensive, and oscilloscopes were not calibrated. Nowadays, phase and frequency measurements can either be done off the screen of a calibrated scope, or using frequency counters and network analyzers.

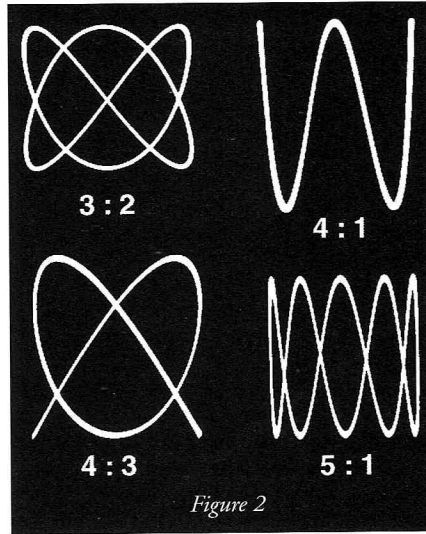

Figure 2

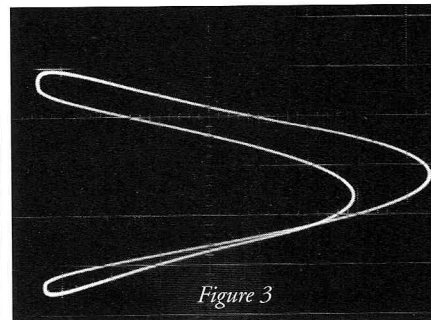

Figure 3

Figure 3 shows a practical use of Lissajous patterns in adjusting the 38KHz oscillator of an old stereo de-multiplexer. The 19KHz pilot tone is fed into the vertical input, and the 38KHz oscillator output is fed into the horizontal input. The 19KHz amplifying stages are adjusted for maximum horizontal amplitude, and then the 38 KHz oscillator transformer is adjusted for a stable pattern. The phase of the pattern depends on the make of the de-multiplexer, but figure 3 shows the result for a Sherwood S3MX adapter. This is an example of a 2:1 Lissajous pattern, although with some waveform distortion. If the 38KHz oscillator falls out of sync, the pattern becomes blurred.

Amplitude Measurement

While not as accurate as AC meters for sine-wave level measurements, calibrated oscilloscopes can be used to measure the

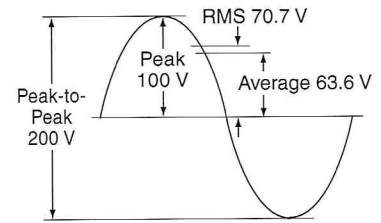

Figure 4

peak-to-peak signal level. It is important to remember to convert peak-to-peak values to RMS values when comparing against meter measurements.

In the audio, RF, and AC power distribution worlds, RMS voltages are nearly universally used, since the most common waveforms used for testing are sine waves. In the digital logic and pulse world, though, peak-to-peak measurements are used, since the waveforms are far from being constant. Figure 4 shows the relationship between peak, peak-to-peak, average, and RMS (Root-Mean Square) voltages for a sine wave.

Waveform Analysis

The most valuable use of the oscilloscope is the analysis of signal waveforms. By representing an image of a voltage over time, many effects and subtleties can be quickly seen. In audio testing, a repetitive waveform is used to allow an easily viewable image on regular oscilloscopes. Where a single event is to be analyzed, a storage scope, either analog or digital, can be used, although the old analog storage scopes are finicky and can be difficult to use.

Sine, Triangle Waves

One of the most common test waveforms for audio work is the sine wave. It has special meaning for distortion tests and spectrum analysis because it is composed of one frequency. For visual tests on a scope, it is not ideal, but because it is so common, it helps to get familiar with it. A common use for sine waves is to test the maximum RMS power output of an amplifier. A quick way to do this is to increase the signal level until just before the output starts to "clip".

The upper trace in Fig. 5 (page 11) shows the Antique Sound Labs AQ-1002 amplifier driven somewhat into clipping. The power measurement would be made with the signal level backed-off so that the flat spots on the top and bottom of the waveform just disappear. The lower trace is the distortion analyzer output, showing the waveform of the output with the fundamental sine wave removed. The

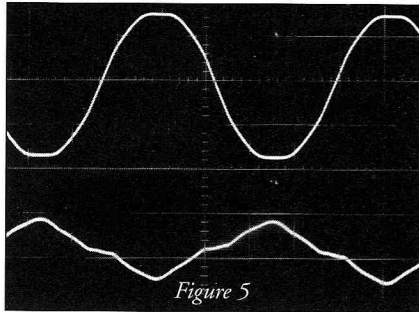

Figure 5

meaning of this will be explained in an upcoming article on distortion analyzers.

For a quick visual check of linearity, a triangle wave is helpful. The slope of the triangle wave is perfectly straight in a purely linear system. Problems such as amplitude clipping or cross-over distortion cause a deviation in this straight line and are readily apparent.

Square Waves

As explained in the first oscilloscope article (VTV Issue 6, p. 26), square waves are an excellent way of quickly checking the frequency response of a system. Figures 1 and 2 in that article show the effects of high- and low-frequency problems on the square wave.

A quick way to find the "flat" position of tone controls in a pre-amp is to apply a 1 KHz square-wave input to the AUX input (or other non-equalized input) and find the positions of the tone controls where the square wave is closest to being square. If you can't get a decent square wave, either the circuit is defective, or the design is not very good. On many amps and pre-amps with finite low-frequency response, there will usually be a slight tilt to a 1KHz square wave, which is normal. This is caused by the slight phase shift due to a frequency roll-off below 20 Hz.

Using a similar technique, the correct response of a phono pre-amp can be checked. By using a reverse RIAA network ahead of the pre-amp, the phono equalization is canceled, preserving the shape of the square wave.

Transient Response

All of the tests mentioned so far use a continuous signal. This makes testing easy, but isn't typical of the real world. Audio amplifiers, especially power amps, can have poor transient response. In other words, after the signal level changes, the amplifier's operating points shift, adding a thump, clipping, or other momentary aberration to the signal.

A good way to test transient response is to apply a gated sine wave, and watch the

output after the onset and absence of the sine wave burst. A clean transition is desirable. This same technique is used for testing audio compressors for minimum thump or control voltage feed-through.

Parasitic Oscillations

An insidious problem in audio amplifiers is high-frequency parasitic oscillation. It can be either caused by poor phase margin in feedback circuits or by high-transconductance tubes breaking into oscillation by themselves. A common cause of power amplifier feedback instability is the practice of setting the compensation network experimentally using a resistive dummy load. Everything looks good on the test bench, but when it is hooked up to speakers (with their various inductances and capacitances) the amp oscillates, often well above human hearing. The subjective effect of this can be just generally poor sound. Things like tube currents and voltages can be erratic. Tube oscillation can happen at quite high frequencies (1 to 100 MHz), and can cause similar poor sound, as well as radio/TV interference. Sometimes the amplifier will oscillate all the time, but, often, oscillation only happens during part of the waveform.

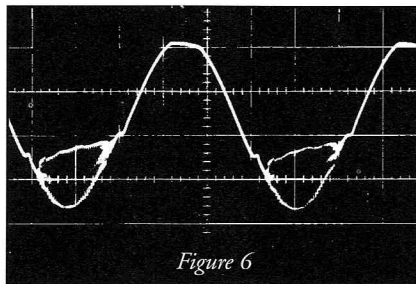

Figure 6

The easiest way to find parasitic oscillation is to look at the signal on an oscilloscope. Figure 6 shows a fairly bad case of oscillation on an amp driven into overload. Usually the "fuzz" caused by oscillation is smaller and can be quite high in frequency. This is one of the few cases in analog audio work where a really high bandwidth scope helps.

RF Alignment

Although this series concentrates on testing in the audio domain, there are times when one may want to align radios and tuners. Many simple adjustments and most AM/shortwave radio alignment can be done with signal generators and meters. However, wide-band equipment, such as FM tuners and television sets, can benefit from more advanced techniques (such as sweep) alignment that require a visual display.

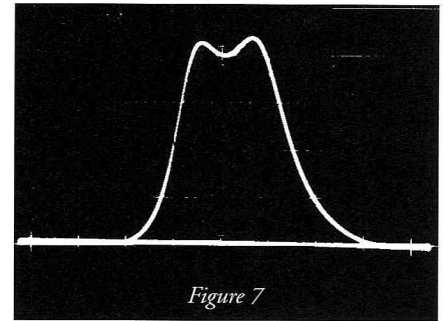

Figure 7

RF alignment techniques will not be covered here (maybe in a future article), but to show the power of the oscilloscope, two examples of frequency sweep alignments will be shown. Figure 7 is the display using a Heathkit IG-52 TV Alignment Generator on the IF strip of a Heathkit PT-1 tuner. The horizontal input to the scope is a 60Hz sine wave from the generator and the vertical input is from an RF detector probe on the output of the IF strip. The 60Hz sine wave also sweeps the frequency up and down from 10.7 MHz. Barely visible in the center of the trace is a squiggly variation in the trace caused by a 10.7MHz marker signal. This set-up is typical of consumer service equipment, and, while far better than simple meter-based adjustments, is uncalibrated and rather unstable. The vertical axis is in approximately linear units, which emphasize the ripple within the passband (not that critical), but does not show the "skirt" selectivity outside the passband.

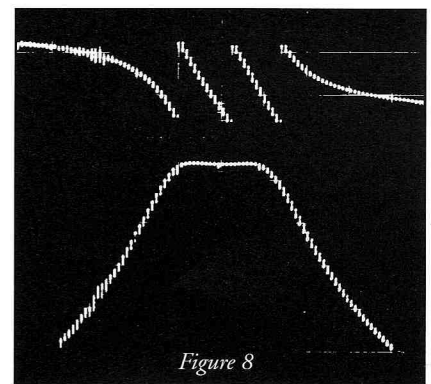

Figure 8

A more accurate sweep alignment display is shown in Figure 8. The sweep generator is a Hewlett-Packard 3330B Frequency Synthesizer that is set up to step the frequency in one hundred 10KHz steps. It feeds a signal proportional to the frequency into the oscilloscope horizontal input. The output of the IF strip (the same Heathkit PT-1) is monitored by a Hewlett-Packard 3570A Network Analyzer, which runs in lock-step with the 3330B. The bottom trace in

Tektronix 465B with multi-meter option

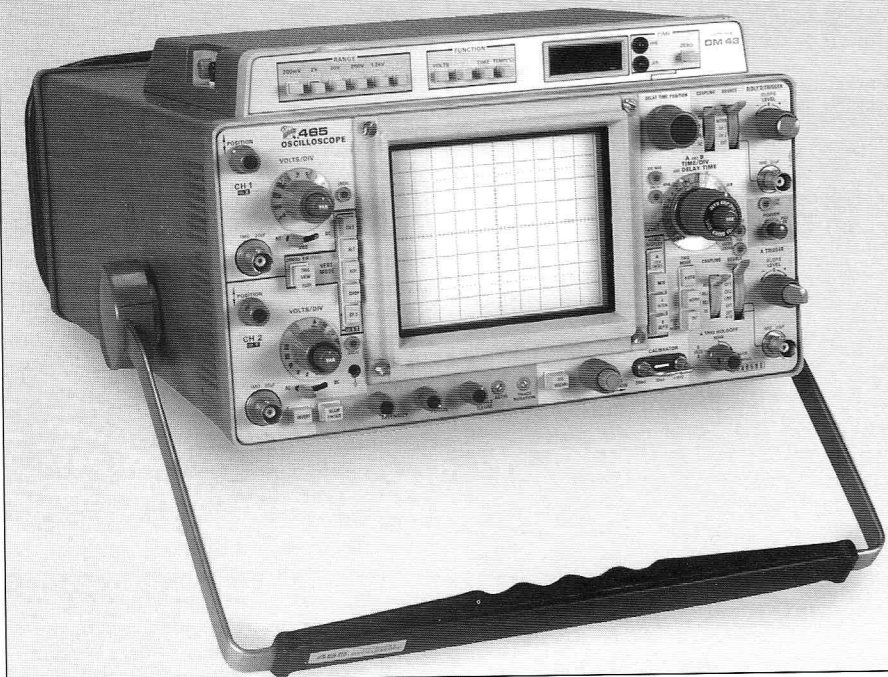
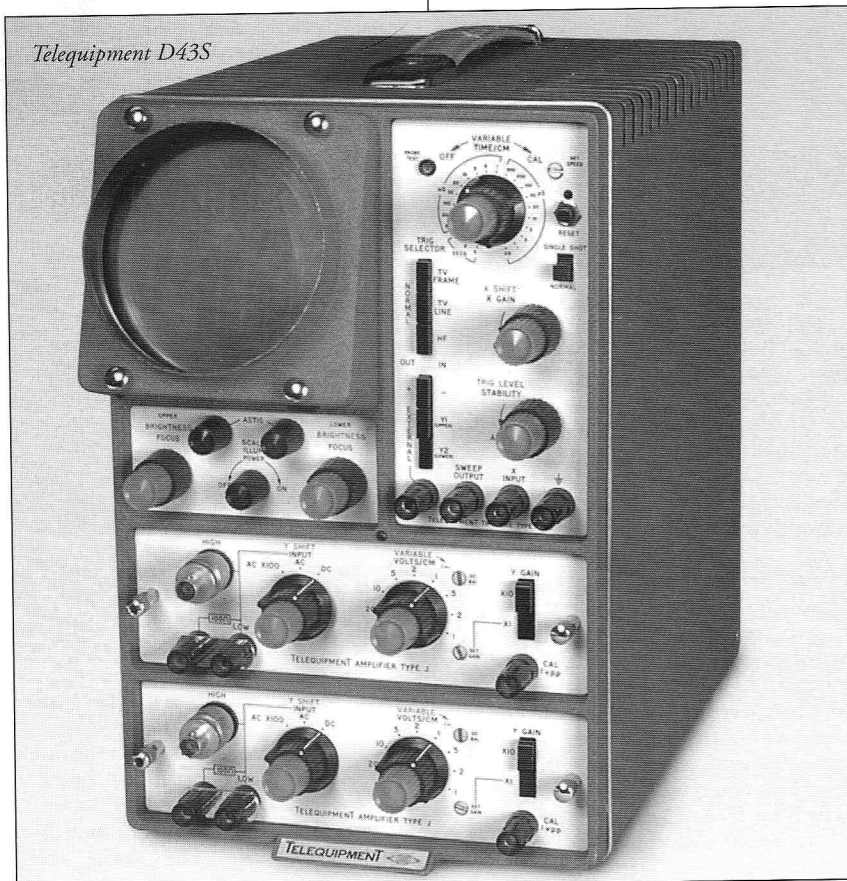

Figure 8 is the amplitude response, but this time in a logarithmic form – much better for seeing the skirt selectivity. The

top trace is the phase response. The abrupt jumps are where the phase crosses the 180° boundary, and are an artifact of

Telequipment D43S



the analyzer. For minimum distortion in an FM receiver, the group delay should be flat across the IF bandpass. Group delay is the rate of change of phase with frequency, in other words, the slope of the phase response in Figure 8. For best linearity, the IF strip should be aligned for a straight slope of the phase response in the passband.

Summary

Only some of the many techniques using oscilloscopes have been touched upon here. If you view the oscilloscope as a tool to allow you “see” electronic signals, soon its use will become second-nature. The power of a two-dimensional display of information is a tremendous help in understanding the operation or non-operation of a circuit.

In the next Audio Test Bench: Distortion Analyzers.

Bibliography

1. Rider, Uslan, **Encyclopedia on Cathode Ray Oscilloscopes and Their Uses**, 2nd Ed., John F. Rider Publisher, Inc., 1959. In addition to all the scope schematics, there are hundreds of drawings of square waves with specific distortions, many Lissajous patterns, and detailed AF and RF alignment techniques.
2. Tremaine, **Audio Cyclopedia**, 1st or 2nd Ed., Howard W. Sams & Co., 1959 or 1969. A huge audio resource which includes descriptions of oscilloscopes and audio test techniques using oscilloscopes. Oriented towards pro-audio.

Check Out VTV On The Web!

- Free Buy-Sell Tube Ads
- Free Articles to Download
- Cool Pictures of Tubes and Vintage Gear
- Cool Links to Other Sites
- Buy T-Shirts, Back Issues
- Technical information and other announcements about VTV and tube-related events across the country

We now get over 1000 visits to the VTV site each week!
www.vacuumtube.com

CINEMA AMPLIFICATION

Altec-Lansing 1568, 1569 and 1570

By Charles Kittleson

© 1997

All Rights Reserved



Trains, Planes and Movie Halls

If you ever went to an airport, motor sports race, church, movie theater, drive-in-movie, or sporting event from the 1950s through the 1970s, you were probably listening to Altec-Lansing 1500 series vacuum tube amplifiers. From their introduction in 1956 through the last production in 1973, Altec produced more public address and movie theater amplifiers than any other manufacturer in the world. It is estimated that during this time period, more than one hundred thousand 1568-70 series amplifiers were produced and sold to most every country on the globe.

All of the 1500 series amplifiers sold by Altec were conservatively designed and made for continuous, trouble-free use. Circuits were simple, but effective in producing the required performance. Although preceded by the Altec 1520A

and 1530A amplifiers in the early 1950s, the later amplifiers are easier to find due to higher production figures. (The 1520A and 1530A will be covered in a future issue of VTV.)

Typically, these amps were paired up with Altec preamps and control systems as well as the famous "Voice of the Theater" loudspeakers. In larger theaters, A1 or A2 systems were used. In small to mid-sized theaters, A4, A5s or A7s were used. In sport arenas, large churches and outdoor facilities, large, suspended horn and woofer arrays were installed to reach even larger crowds. Some high-profile installations of these amps included: Disneyland, The Houston Astrodome, Cinerama Theater in Hollywood, The Oakland Coliseum, The Seattle Cineplex, Madison Square Gardens, hundreds of military facilities and most airports.

1570

The first of the "green wonder" amplifiers was the 58-pound 1570A (\$284), introduced in 1956. It was billed as producing "the most watts per pound of any amplifier" available then. Using push-pull 811-As, it produced 165 watts RMS with less than three percent THD from 70 to 20,000 cycles. Overall frequency response was rated at 10 to 50,000 cycles. The front-end circuitry was Williamson-type using a 12AX7 as the first audio and cathodyne phase inverter with a 6SN7GTB as the diff-amp driver and phase inverter.

Negative feedback was carried around all stages from a tertiary winding on the output transformer. The driver circuit used a Peerless 17173 center-tapped choke driven by triode-connected 6W6GTs. The power supply featured a massive Peerless 6236 transformer and four-5U4GBs that supplied 930 volts of B+ voltage. The output transformer for the 1570A was a potted Peerless 15416 with a Peerless 17195 power transformer. Finished in the famous Altec metallic hammertone green, the A featured potted Peerless transformers and inductors. The 1570A was produced for only about two years and is somewhat scarce.



In 1958, the 1570B (\$348) was introduced and became the standard high-power amplifier used in coliseums and drive-in movies. They were painted the famous Altec Forest Green with a 10 1/2 inch rack panel and a full cage with a high-voltage safety switch that cut off the B+ when the cage was removed. The rating was 175 watts RMS at less than 5% THD from 65 to 20,000 cycles. The circuitry and tube topology were similar to the 1570A, but the B featured a different chassis and transformers that were non-potted. The rectifier tubes were changed to 5R4GYs with a Peerless 6410 power transformer and Peerless 16492 output transformer.

Another version of the 1570 was the 1570 BT (\$439), introduced in 1963, which featured a switchable meter to monitor individual tube performance.





The 1570B was the most popular high-powered pro-audio amp ever made in the US. Many of them are still in use as installed while others have been modified with different circuitry, tubes and other mods for home hi fi use. (See Tom Tutay's mod info on pages 15-17.)

1569A

Introduced in 1957, the 1569A (\$246) was a popular theater amplifier used in thousands of movie houses in the Golden Age of Cinema of the late 1950s through the 60s. It was also used in schools, factories, military complexes, churches and airports. Rated at 80 watts RMS with 2% THD from 60 to 20,000 cycles, the frequency response ranged from 5 to 30,000 cycles + or - 1 dB.

Power output tubes were four-EL34/6CA7s driven by two 6CG7 dual triodes. The rectifier tubes were two 5U4GBs supplying 440 volts B+ to the plates of the EL34s. The output trans-

former was a Peerless 16433 and the power transformer was a Peerless 6289. The output impedances were 4, 8, 16 and 62 ohms. Another version of the 1569 was the 1569AT (\$322), introduced in



1963, which featured a switchable meter to monitor individual tube performance. Many 1569As are still in use, but several have been modified by tube audio enthusiasts with a variety of circuit changes and tube substitutions.

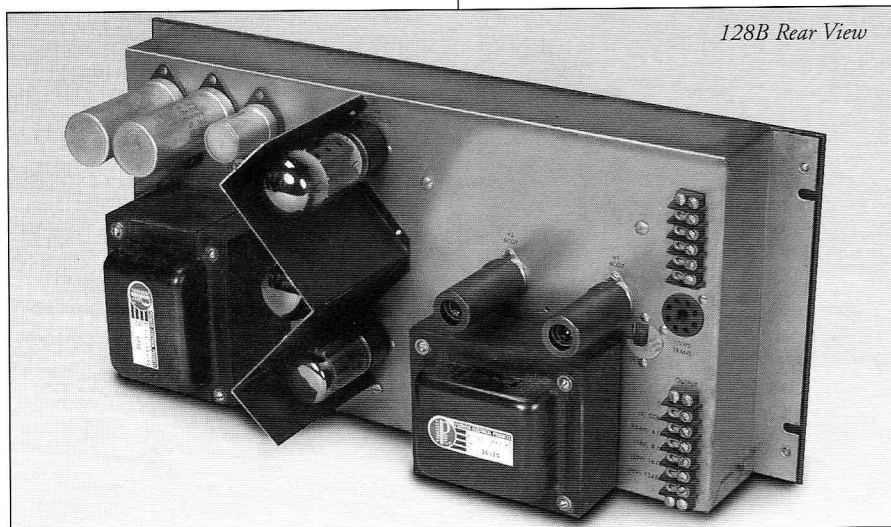

1568A

The low power version of this long-lived line of vacuum tube amplifiers was the 40 watt 1568A (\$195), also introduced in 1957. This 22-pound amplifier featured push-pull EL34/6CA7s driven by two 6CG7s and powered by a single 5U4GB. Frequency response was 5 to 30,000 cycles + or - 1 dB with total harmonic distortion of less than two percent at rated power from 40 to 20,000 cycles. The Peerless 6288 power transformer supplied 390 volts B+ and the Peerless 16432 output transformer provided the smooth sound output.

128A and 128B

Although not in the same numbering system, the 128A (\$234) amplifier was a wider band, hi fi version of the 1568A. Introduced in 1956, the 40 watt amplifier featured the same tube compliment as the 1568A. The 128A was intended for use in broadcast, recording and television studios. Frequency response was 3-30,000 cycles + or - 1 dB. It was finished in the earlier Altec blue-green metallic hammertone finish with attractive Peerless potted output and power transformers. Not very many 128As were sold and they are somewhat scarce.

Billed as the "Thermoguard" amplifier, the 128B (\$240), introduced in 1961, used a specially designed heat shield to limit the "chimney effect" when the amps were stacked in racks. The "Thermoguard" featured an automatic resetting circuit breaker located within the windings of the power transformer and was capable of sensing any excessive rise in temperature or component failure. The tube complement was the same as the 128A and 1568A, except for the use of a 5AR4 slow-warmup tube rectifier. The power transformer also featured a heavy copper flux shield to reduce the AC field. The amp includes a switchable meter on the faceplate to inspect the performance of each vacuum tube by measuring space current. Many vintage theater amp enthusiasts claim they prefer the 128B over the 1568A, because of its balanced sound over the music spectrum. The 128B was discontinued in 1970.

Sonic Characteristics

The 1500 Series amps were primarily used as PA amps, designed primarily for mid-range applications in big areas. But with the correct upgrades and/or modifications, they can sound excellent. The 1568A is very smooth and hi fi sounding due to a wideband transformer, good design and conservative rating. Its bigger brother, the 1569A, is a bit more of a



brute with a punchier, bigger mid-range, decent bass above 40 hz and sweet highs that are a slightly rolled-off compared to the big midrange. A bandwidth limiting device on these amps is the optional high-pass input filter.

The 128B is probably the most hi fi sounding of this group with the wider bandwidth output transformer and a 5AR4 slow-warmup rectifier tube. Lastly, the 1570B is a brutish, voice frequency amp that can be modified to be an excellent hi fi amp. Low frequency power is limited below 60 hz compared to the monstrous midrange response. High-frequency response is very extended, well beyond 50 KHz, with little phase shift. 1570Bs can sound spectacular with electrostats or other power-hungry speakers.

Collectability

Many hi fi purists would never consider buying a vintage "PA" amplifier, but these Altec amps can be quite useful in home audio applications when restored or correctly modified. The rarest types are the 128A and the 1570A with potted Peerless transformers. In excellent condition a 128A can fetch \$200 to \$400 and an excellent 1570A can fetch \$400 to 650. On the other hand, 1568As, 1569As and 1570Bs are relatively common. In excellent shape, a 1568A is \$125 to 200, a 1569A is \$200 to \$450 and a 1570B is \$300 to \$600 each. (1997 US collector prices.)

Repairs and Modifications

All of the amps mentioned in this article have big chassis, are roomy and easy to work on and best of all, very simple and dependable. If you come into some of these amps, never plug them in until you are sure there are no shorts, missing parts, or dried out filter capacitors. Check these items, replace and repair as needed. Then bring the amps up slowly on a variable AC transformer and check for other problems. Fix as needed. Basic restoration for these amps includes upgrading capacitors, resistors, tubes, selenium rectifier and general clean-up.

Remember-**SAFETY FIRST!!!** The voltages within an Altec 1570B can exceed 1000 volts and a screwdriver or finger in the plate supply can kill you. Use extreme caution when working on this amp and always turn the power off when working on it.

Although there are several versions of mods to these amps, I have contacted two competent amp designers for their versions. Bill Jones of Santa Cruz, California, has had success with the following mod:

1569A Modification

1. Remove the two 6CG7 front end tubes and replace with an octal Type 5691 first stage tube (requires chassis modification) and a type 5687 diff- amp stage.
2. Output tubes can remain EL34s or can be changed to 6L6GC or type 5932s.
3. Replace all capacitors and resistors to modern, high quality units.
4. Replace rectifier tubes with solid-state diodes or replace 5U4GBs with 5AR4s. 5AR4s will give a slow-start to the B+ voltage, draw less filament current from the power transformer and B+ voltage will rise a bit to about 475 volts.
5. Increase power supply filter capacitance from 200 to 400 mfd for tighter bass response.
6. Install separate power supplies for first and second tube to reduce voltage swings from idle to full power operation. (No schematic available for this mod)

1570B Modification

Tom Tutay, located in Fort Walton Beach, Florida, has completed a number of successful and good sounding mods to the 1570B over the last few years. Tom's 1570B mods are as follows:

1. Replace the four 5R4GB rectifier tubes with one 5000 volt-500 ma fast full-wave diode bridge.
2. Install a slow-start time delay relay.
3. Install filter choke to the negative side of the supply.
4. Install separate power transformer, tube rectifier, choke input power supply for the input and drive stage tubes.
5. Replace V1, originally a 12AX7, with a GE 6072A.
6. Add a "tail" resistor to the diff-amp (6SN7) cathode.
7. Replace triode-connected 6W6GTs with triode connected Tesla E34Ls.
8. Install B+ power supply fuses, bias adjustment pots and voltage test point.
9. Upgrade bypass and coupling capacitors with modern, high-quality types.
10. The two-75K V2 plate resistors should be matched within 1%.
11. The 47K plate and cathode resistors on the V1 splitter section should be exactly matched.
12. Upgrade most resistors to one-half watt metal-film. The two watt resistors are either metal-film or metal-oxide,

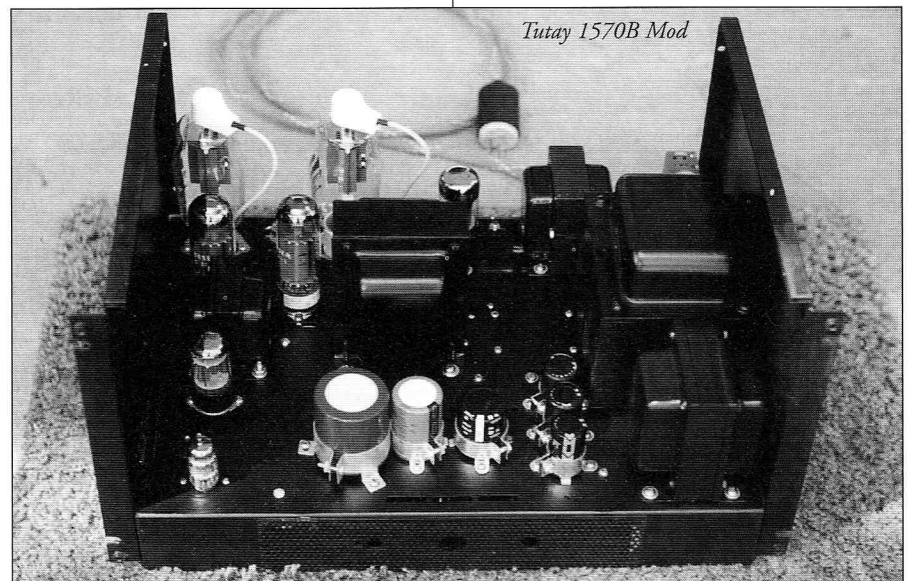

ALTEC 1568, 1569 AND 1570

NOTE:
AMPLIFIER IS SHIPPED WITH C1 & C2 STRAPPED
OUT. WHEN USED WITH DRIVER LOUDSPEAKER
WITHOUT NETWORK CUT STRAPS AS REQUIRED.

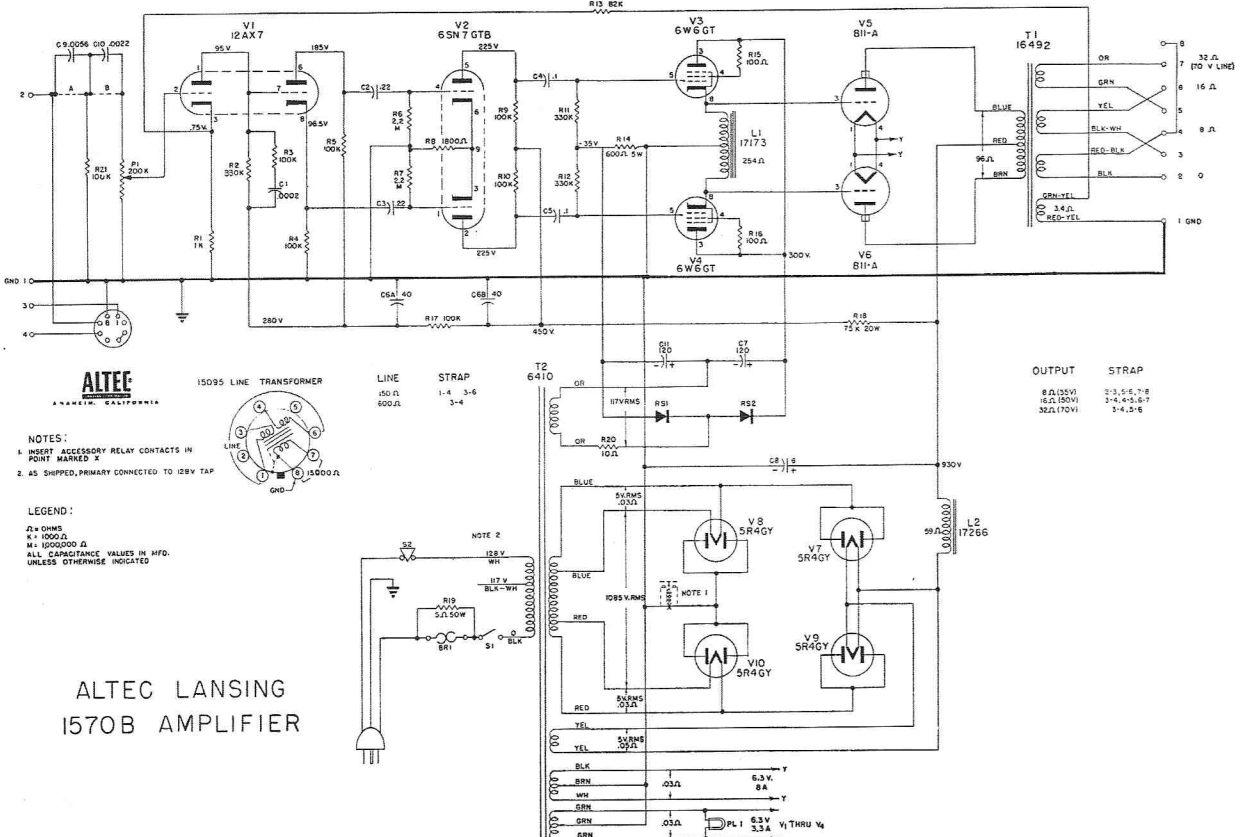
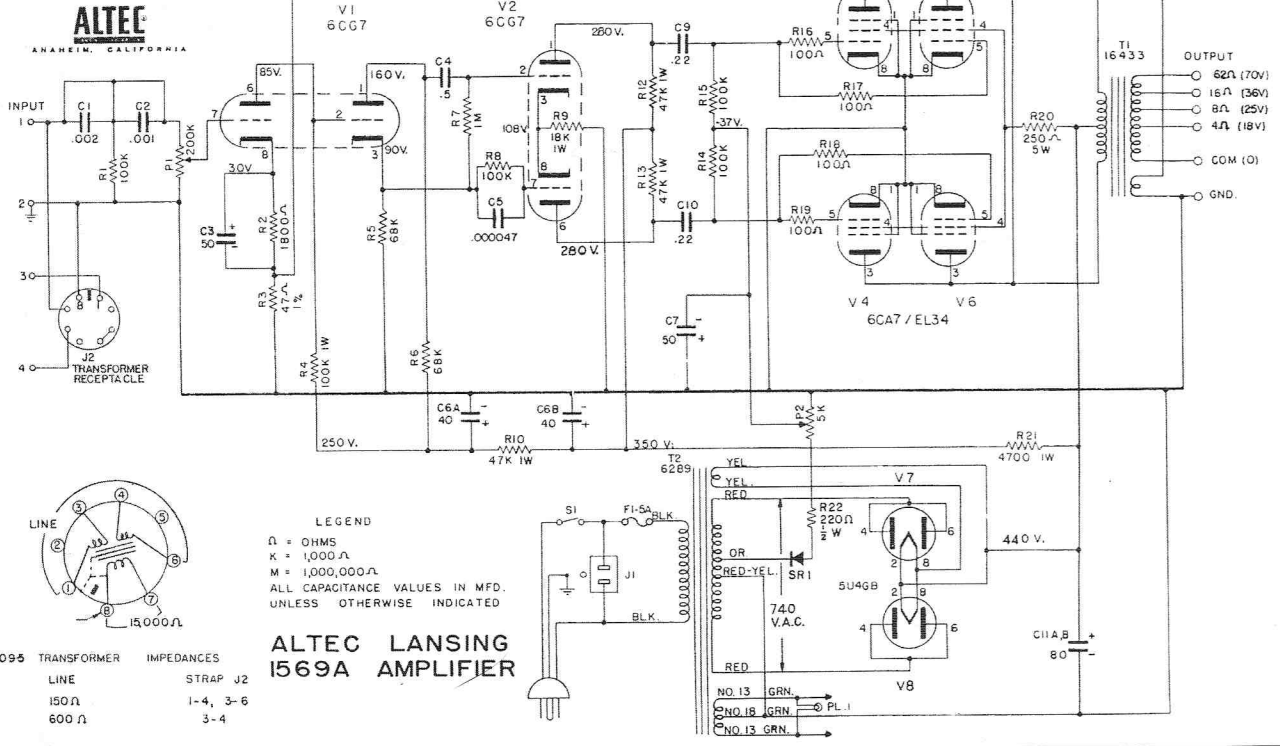

The Great Voice

A Tribute to Peter Jensen, Founder of Magnavox and Jensen

Based on Jensen's Memoirs Through 1930

By Paul S. Bourbin

© 1997 All Rights Reserved

Introduction

This book is quite different than other books I have reviewed in that it was never offered to the public. The Great Voice is the memoirs of Peter Jensen, co-founder of Magnavox, published by his daughter, Patricia Ann Jensen Schlindler. The print run was limited to 500 copies and were distributed mostly to family, friends, and a few libraries and universities. This autobiography was also published in Denmark under the title of: **Jensen**.

How I came upon a copy is an interesting story. At the first California Historical Radio Society regional meet in San Francisco, a fellow came up to me and asked if I know of anyone who might have a Magnavox speaker for sale. He had asked quite a few people, none of whom had much interest in helping him. Someone referred him to me because I was the President of the Society at that time. He told me that he knew nothing about vintage electronic equipment, but wanted a Magnavox horn speaker because his family was involved with Magnavox. I knew that John Wentzel of Aladdin Antique Radio Repair in San Francisco had an extra one, so I brought the two together.

John sold him a speaker and he was so grateful that he gave John and me each a copy of *The Great Voice*, telling us how his mother self-published the book because she felt that the memoirs were worthy of historical preservation. Since there is little chance that many readers will have a chance to acquire a copy of *The Great Voice*, I will present a synopsis of the contents rather than a review.

The book begins with a Preface written by his daughter giving a bit of background about Jensen and his family. While he is remembered for his scientific accomplishments, he was also a gifted and respected historian and violinist. He had a passion

for sports and philosophy. He had five children and was married twice. Towards the end of his life, he spent much time in Denmark, was knighted by the Danish King and was offered the position of cultural attache for the United States in Denmark (a position he declined).



The first chapter covers the first public use of amplified speech through loudspeakers. This was on Christmas Eve, 1915. A speech was given by San Francisco Mayor James (Sunny Jim) Rolph from the balcony of City Hall to a crowd of approximately seventy-five thousand people in Civic Center Plaza. While some had come for the Christmas Eve celebration and to hear the Mayor's speech, many had come to hear the miracle of amplified speech. Peter Jensen and his partner, Edwin Pridham, were quite nervous about their invention, the Magnavox, and to whether it would work properly. When the time came, it worked perfectly and ushered in a new age, the age of amplified sound. Unlike other inventors, who were rushing to beat oth-

ers to success, Jensen and Pridham knew of no one else attempting to do what they had done.

The Early Years In Denmark

Peter Jensen was born on the island of Falster, Denmark on May 16, 1886. He was born to a family of seafarers and was expected to follow tradition. His family was quite poor and depended upon their small farm to supplement his father's income from working as a pilot. It was expected that Peter would go to sea at fourteen and then be on his own. Thus, Peter Jensen spent the early years of his life, fishing, farming and helping his father with his pilot boat.

He loved to read and spent much of what little free time he had reading novels; many of them were about the American West. He did so well at school that his teacher recommended that he continue his education and enter a college preparatory rather than go to sea. After much family discussion, his father permitted him to continue his schooling. While he was at boarding school, his father died, causing much grief and hardship to Peter's family. Fortunately he finished four years study in two and a half, so he graduated.

He took a job in a saw mill to support himself. His boss at the mill realized that Peter's education highly overqualified him for the menial work he was doing and that he should go to the city to seek his fortune. Peter's mother finally relented and off Peter went to Copenhagen.

An acquaintance of the family, Lemvig Fog, a prominent man in Copenhagen, convinced Peter to pursue a career in the technical field. Lemvig Fog was a backer of Valdemar Poulsen who had recently invented the Telgraphone wire recorder. While hailed by scientists as an invention of high significance, the Telegraphone was impractical because electronic amplification had not been invented.

A New Career In Electronics

Peter was quite poor working for Poulsen as an apprentice machinist. Poulsen was working on the Poulsen Arc radio transmitter and in 1904 Peter started helping with the project. The arc was temperamental and Peter was the only one who could keep it going reliably. There was much speculation amongst the engineers concerning how much better the arc was compared to Marconi's spark transmitter and the arc's range.

In 1905, Poulsen built a station in Lyngby, Denmark and Peter was told to assist in the building of the station. He

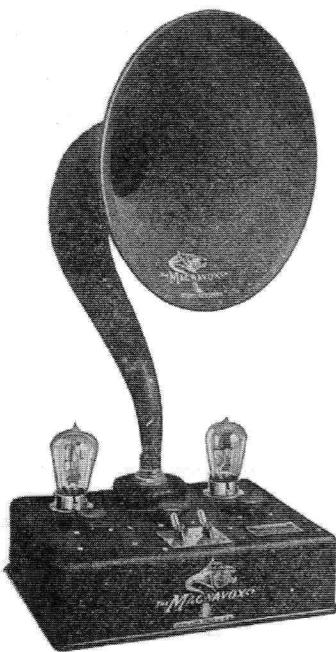
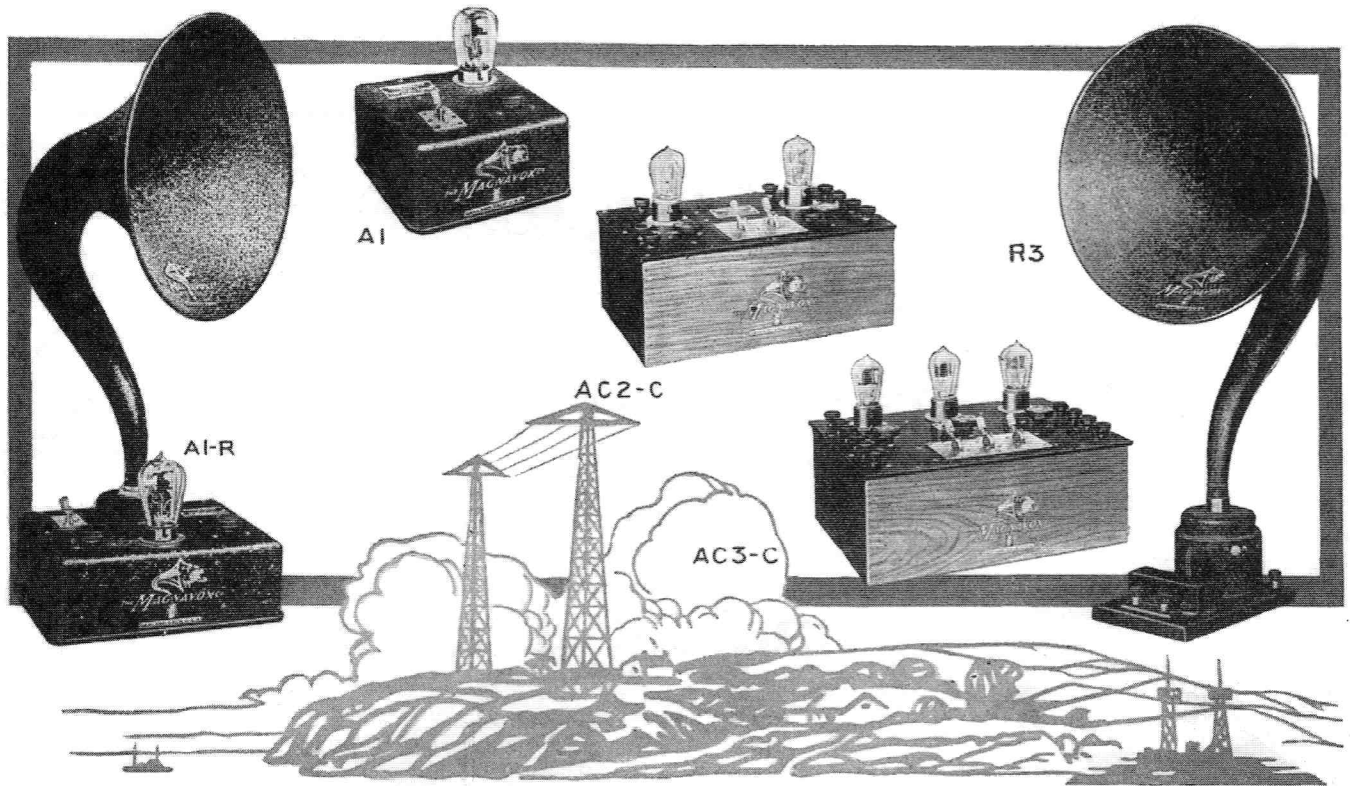

*New Magnavox
Combination Set*

A2-R Insures convenient and perfect Radio reproduction. Consists of Magnavox Reproducer with 14-inch horn and 2-stage Magnavox Power Amplifier, as illustrated \$85.00

Radio takes another step forward with these wonderful new Magnavox devices

THE new Magnavox models here shown extend and supplement the already famous Magnavox line of Reproducers and Power Amplifiers. There is a Magnavox for every receiving set.

Magnavox Reproducers

- R2 with 18-inch curvex horn in new acoustic finish . . . \$60.00
- R3 with 14-inch curvex horn in new acoustic finish . . . 35.00
- M1 new Magnavox Reproducer requires no battery for the field, thus meeting requirements of dry battery receiving sets. With 14-inch curvex horn in new acoustic finish . . . 35.00

Magnavox Combination Sets

- A1-R consisting of Magnavox R3 Reproducer with 14-in. horn and 1-stage Magnavox Power Amplifier . . . 59.00
- A2-R consisting of Magnavox R3 Reproducer with 14-in. horn and 2-stage Magnavox Power Amplifier . . . 85.00
- A1-M same as A1-R but with the new Magnavox Reproducer M1 . . . 59.00

A2-M same as A2-R but with the new Magnavox Reproducer M1 . . . \$85.00

Magnavox Power Amplifiers

- A1 meets the demand for a 1-stage Power Amplifier. Special finish metal case. . . 27.50
- AC-2-C Magnavox 2-stage Power Amplifier with Bakelite panel in highly finished hardwood case . . . 55.00
- AC-3-C Magnavox 3-stage Power Amplifier . . . 75.00

Ask your dealer for a demonstration. Interesting booklet will be sent on request.

The Magnavox Company
OAKLAND, CALIFORNIA
370 Seventh Avenue, New York
World pioneers in the development and manufacture of sound amplifying apparatus

MAGNAVOX PRODUCTS

Magnavox Reproducers and Amplifiers

Tell them that you saw it in RADIO

1920 Magnavox Ad

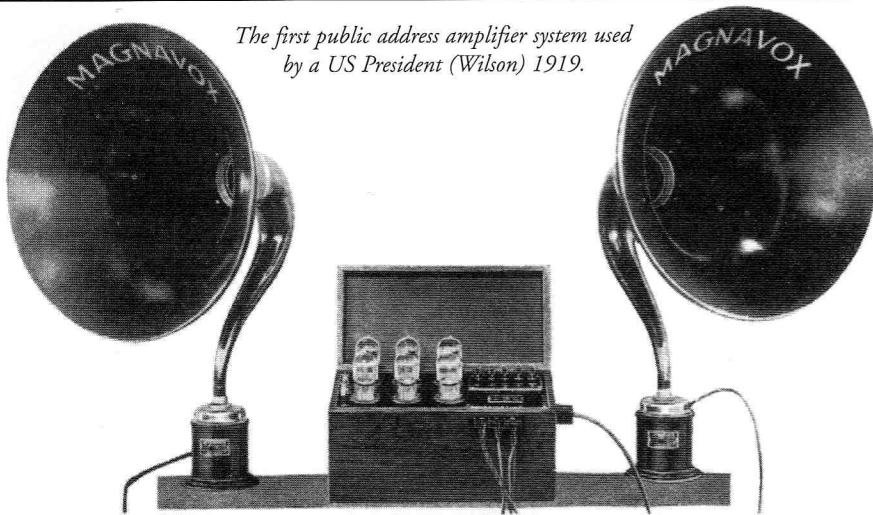

The first public address amplifier system used by a US President (Wilson) 1919.

was also the only one who knew Morse Code. This earned him a promotion and he began to fare much better.

The Poulsen Arc permitted much sharper tuning than spark transmitters. Poulsen invented a system with a transmitter and receiver tuned to twenty-eight frequencies corresponding to the twenty-eight letters in the Danish alphabet. Typing on a specific key on the transmitter's typewriter would operate a corresponding key on the receiver's typewriter. A radio controlled boat was also invented. These were probably the first experiments of this type because the Poulsen arc was the only system that could tune that sharply at that time.

Range was, at first, limited by the touchy coherer, but when Poulsen invented the ticker, the range increased considerably. Attempts were made to attach a microphone to the various circuits to permit the transmission of speech. For a while, all attempts failed. One day, Peter got the idea to hook up the microphone to the ground circuit and use the ticker in series with a crystal detector. The crystal detector had been previously rejected because it was not as sensitive as the ticker, but Peter thought it might help with voice transmissions. The circuit did not work, but, when he removed the ticker, it did! Peter managed to transmit voice, song and music for the first time with the Poulsen arc. Other than McCarty's voice transmissions using modulated spark in San Francisco and Fessenden's alternator experiments, this was probably the first voice transmission by radio.

While operating the arc transmitter, they would play records and the few people with radios sets would be astounded to hear music. Einer Diseau was the only civilian in Denmark to listen to these

broadcasts because radio was monopolized by the Danish government and Peter had helped him to build an illegal set. He sent a post card to Peter thanking him for the broadcasts--possibly the first fan mail. Peter then joined the Navy as a wireless operator to complete his required military service. While in the service, Poulsen contacted him and asked him if he would be interested in going to the United States and help with the setting up of two radio stations.

Jensen Comes to California

Coburn and Elwell had purchased the American rights to the Poulsen Arc system and needed someone to supervise the construction of the stations. Peter was very glad to have the opportunity to visit the United States. So in December 1909 he left for America. The first use of the transmitters was that of stock promotion.

At the Sacramento station Jensen met Edwin Pridham and they became fast friends. Pridham, an American from the Chicago area and Stanford graduate, helped the immigrant learn the ways and the language of America. Again, amateurs enjoyed their test broadcasts. When they built the station in San Francisco, many more people heard them, yet it did not occur to people associated with the Poulsen Wireless Telegraph and Telephone Company that broadcasts of music, entertainment and news would be significant. Most of the radio communication at that time was ship-to-ship and ship-to-shore. They were interested in promoting the system as a replacement for the telephone.

Eventually, in 1910, continuous radio telegraphic communication was established between the transmitters in Northern California and the one in Los

Angeles and radio telephony was possible at night. When the Federal Telegraph Company purchased The Poulsen Wireless Telegraph and Telephone Company, Coburn asked Jensen and Pridham to quit Federal and join him in a venture to get the world-wide rights to the Poulsen Arc and start a world-wide radio system. When they got to Denmark, they found that Poulsen had already sold the rights to an Englishman. They returned to America and Jensen realized that he was a real American and this would be his home forever.

Jensen and Pridham returned to San Francisco, where Coburn introduced them to Richard O'Connor, a prominent San Franciscan. He became their financial backer. Jensen, Pridham, Coburn (temporarily) and O'Connor formed the Commercial Wireless and Development Company to support, patent and exploit the radio inventions of Jensen and Pridham. They purchased a house and lot in Napa, (north of San Francisco) where they could work undisturbed. They built a Poulsen Arc radio station and proceeded to experiment with it and de Forest's vacuum tubes. They may have discovered the oscillating and amplifying characteristics of the tubes, but, instead, took another tack.

One of the devices that they brought over from Denmark was a radio telegraph recording device that photographically recorded the dots and dashes by photographing the movement of a galvanometer needle connected to a moving coil. It occurred to Jensen and Pridham that this rapidly moving needle could, perhaps, follow the vibrations of sound and therefore, be made to work as a form of telephone receiver. By attaching the vibrating wire to a diaphragm and hooking up the device to a telephone circuit, they were able to reproduce sound quite well. They were astonished that no one else had invented such a simple device. With much enthusiasm and high hopes, they named their device the "electro-dynamic principle" and applied for a patent. They were quite disappointed to find out that their device had been well covered by previous patents and that their application had been rejected. The devices produced by others existed only in their laboratories and no commercial version was ever produced.

For two years, they worked to improve their invention and reduce its size. Along the way, they invented the output transformer and the "Bucking coil." They could only envision the device as a telephone receiver, and could make it as

small and light as the ones in current use. Although their method was already patented, they were finally able to obtain patents on their particular device. In 1914, they took their invention to the Western Electric Laboratories in New York in an attempt to sell the patent rights to them. At the same time, Western Electric was examining de Forest's triode vacuum tube. Thus, they had two of the seminal inventions of the electronics industry in their lab at the same time.

They did not realize that before them were two devices, if put together, would have given them control of most of the electronics industry. Western Electric bought de Forest's patent for a fraction of what it turned out to be worth and rejected Jensen and Pridham's offer to sell them their patent. Jensen felt that he got the better deal because he finally got what his invention was worth. Jensen and Pridham returned to Napa wondering what they were going to do.

The First Electrical Loudspeaker

Jensen and Pridham were at the end of their rope. They were still thinking along the lines of wired or radio communication. They had just about run out of ideas. Early in 1915, Ray Galbreath (uncle of Jensen's wife Vivian), a blacksmith visited their laboratory and saw the electro-dynamic telephone receiver. After the demonstration, Ray said, "If you can't sell it to the telephone company, what chance have you? But now, if you can make it talk a little louder and put a horn on it, like Foghorn Murphy's, and if you put enough of them around a ball park, maybe we can understand what is being said a little better, and maybe they don't need Foghorn Murphy any more. That's the only chance I can see for you."

Foghorn Murphy was a San Franciscan who rode around the area on horseback with a megaphone announcing the time and place of the next ball game and then announcing the play-by-play during the game. True, they thought, the loud speaking telephone would not be as commercially important as telephone receivers but, it might give them some reward for their efforts. At least, the field was not monopolized by a few companies.

They started working on the loud speaking telephone that night. They had, in their laboratory, a goose-necked Edison phonograph horn. They designed a fitting to allow the

connection of the electro-dynamic telephone to the horn. The next day, Albertus made the fitting, attached six German microphones to a single mouth-piece, attached a transformer and twelve volt battery to the circuit. They hoped that they could hear it across the room. When the battery was connected, they heard a loud crack followed by terrible howling. The first sounds were that of feedback! They had experienced feedback before, in telephone work, and knew that the cure was to separate the transmitter (microphone) from the receiver (loud speaker).

They decided to try again, howl or no howl, and the voice came thundering out in spite of the howl. Excited by the possibilities of their invention, they disconnected the system and put the horn on top of the chimney with Peter's brother Karl, holding on to the horn. Pridham started talking into the microphones. This time his voice was quite clear, but extraordinarily loud. Albertus and Jensen ran across the fields to find out how far the sound would carry. It was quite loud a quarter mile away, and finally died out a mile away with a slight crosswind! There must have been less background noise then.

Jensen later figured that their output was about ten to twenty-five watts. They repeated the experiment then called their backer, Dick O'Connor, with the exciting news. He could not believe what he was told; finally he agreed to bring some of the shareholders to Napa the next day. Everyone thought they were crazy. Most other inventions had been alluded to prior

to their successful completion; this invention seemed to come out of the blue.

Magnavox or Telemegaphone?

After hearing the device, the shareholders told Jensen and Pridham that they would not have to worry about financial backing. This was important because they were in a serious financial condition at the time. The next problem was to give the device a name. "Dynamic loud-speaking telephone" was not practical. Telemegaphone was considered, but rejected. They tried Latin instead of Greek and thus was born Magnavox, meaning great voice. During 1915, they continued to perfect their speaker.

They redesigned their dynamic telephone to give the device a better appearance. They improved their microphones, which were the limiting factor at that time, by using four elements in a hand-held unit. A phonograph "pick-up" was invented. It consisted of an attachment that connected to the phonograph, containing a diaphragm and a microphone.

It should be noted that in 1916, Jensen and Pridham patented an electric phonograph. They often gave concerts to the residents of Napa by attaching their speaker to the chimney, pointing it toward town, and playing records. Similar events occurred when early commercial Magnavoxs were available in the Sunset District of San Francisco. A radio enthusiast would point his speaker out his window and make early radio broadcasts available to residents within several

1921 Telemegaphone Ad



CONNECT "AA" to your detector or amplifier, and "BB" to a 6-volt battery

MAGNAVOX

RADIO TELEMEGAFONE

When used with one or more stages of amplification will reproduce signals with great volume. For the small fraction of a watt output of your receiver that is available for the production of signals, the MAGNAVOX TELEMEGAFONE will produce the greatest volume of sound

With Small Horn, as Illustrated \$75.00
With Large Music Master Horn 93.00

WRITE FOR BULLETIN NO. 21020



THE MAGNAVOX CO.
PATENTED IN U.S.A. AND FOREIGN COUNTRIES
2701-2765 EAST 14TH STREET
OAKLAND, CALIFORNIA

blocks. [One wonders what would happen if this were done today!] Jensen documented events which showed the fidelity and strength of the sound emanating from their speaker. Apparently it could be heard as far as seven miles!

They were concerned about exhibiting their apparatus at the 1915 World's Fair in San Francisco because they were not sure of the strength of their patents (yet they were not bothered for five years). However, they did play a few phonograph concerts from the Tower of Jewels that were even heard by ships on the Bay. Finally they were pressed to demonstrate the system to the press. This occurred on December 10, 1915 from Strawberry Hill, in Golden Gate Park, San Francisco. Witnesses were impressed by the fact that the sound did not appear to be that loud, but carried extraordinarily well. People could stand ten feet away from the speaker and be comfortable, yet hear the sound over great distances.

It was customary in San Francisco to have a large civic celebration on Christmas Eve. Jensen and Pridham were asked to provide their equipment for this event planned to occur at Civic Center Plaza, a larger venue than in previous years. It was so successful that they were invited to provide sound reinforcement for the opening of the Civic Auditorium on December 30, 1915. This event was the first time amplified speech was used in a building and the first time that it was used for a speech from a remote location. The organizers wanted a speech made at the Governor's house to be heard at the event and Jensen and Pridham had the only way possible to accomplish this. The use of telephone lines was not possible because of the weak signal strength (remember, this had to be done without the aid of vacuum tube amplification). They found out that there was a very heavy cable used for street lighting running down Van Ness Ave. Since both locations were close to Van Ness Ave., this made the transmission possible. They hooked their microphone and receiver to this cable and used a water pipe for a ground. Except for a slight hum, the hook-up worked perfectly and provided plenty of sound. Even though this event was a success, Jensen and Pridham knew that they would need vacuum tube amplification to make their device practical.

Late in 1916, they moved their laboratory to San Francisco. They found that there was a limited market for their equipment for the amplification of voice,

but there was much interest in the amplified phonograph. In 1917, the Commercial Wireless and Development Company merged with the Sonora Phonograph Company of the Pacific Coast to form the Magnavox Company. This allowed them to expand without having to depend on capital infusions from shareholders.

Jensen's Contributions in WWI

Soon the United States entered into World War One and Magnavox went into war work. They first tried to make a system that would allow people in airplanes to talk to people on the ground. This was unsuccessful because the microphone picked up all of the loud noise from the airplane. They also wanted to make an intercom system for airplanes. Again they had the same problem. They tried many ways to block the stray sounds from entering the microphone, without success.

Pridham came up with the idea of leaving the structure of the microphone as open as possible. Since the offending sounds would hit both sides of the diaphragm at almost the same time, the words spoken into the microphone to be heard. This was quite successful and was adopted by the Navy and others to be used throughout the War. After the war, they continued to produce microphones, including a waterproof type, for use on ships. The loudspeaker business was not at all developed, but they continued to work on it.

The Presidential PA

They developed the vacuum tube amplifier to use with their equipment. This made it much more useful. At last their break came. An ailing President Woodrow Wilson was slated to speak in San Diego about the League of Nations. He needed to be protected from the weather, so the Magnavox was an ideal solution. Pridham set up the equipment and it worked perfectly. Suddenly, a few seconds before the speech was due to begin, the system went dead. Smoke rose from the amplifier. He pulled out a tube and the smoking stopped. He inserted a new tube and all worked well--just in time. This installation in a stadium portended things to come. Even though this and other events occurred successfully, they worked in relative isolation. They had no competition until 1920. At that time, AT&T entered the field. Still, business was good and much of it came from radio amateurs who bought speakers for their stations. By 1922, broad-

casting became fairly well established and there was a huge demand for speakers.

Since things were going well, Jensen decided to go to Europe to visit his mother, see European speaker development, and market Magnavox equipment. He was approached by Guy Burney of the Sterling Telephone Company who wanted exclusive rights to the Magnavox in England. Burney was granted the rights. A problem existed in marketing radio in England.

The wealthy thought the phonograph and radio were for the lower classes and refused to purchase them. However, radio's popularity throughout the world finally convinced the wealthy English to acquire sets. Jensen demonstrated his equipment as he had done in America. He met Marconi and talked with him at length about the early days of radio.

Jensen went to Denmark and demonstrated his apparatus. He visited his mother and enjoyed seeing his old home and haunts. He realized that he should keep his pride in his Danish heritage.

Jensen returned to California in September 1922 to see the great radio rage at its full height. He saw the speaker used to make talking pictures in 1927 and become universally used in phonographs in 1930. The uses far exceeded what he had expected when he first heard The Great Voice. He wondered, "How did we get along without it?"

Paul J. Bourbin is a San Francisco, California based radio and phonograph collector and historian. He is Past President of the California Historical Radio Society and has written articles for several related publications including Antique Radio Classified, Radio Age and others.

Peter Jensen sold his portion of Magnavox stock to a group of investors in 1925. In 1927, he founded Jensen Radio Manufacturing Company. By 1929, the company had grown so large that he moved the company and key employees to Chicago. He remained President of Jensen Radio Manufacturing Company until 1940 when he resigned. Many improvements to loudspeaker design and performance were accomplished by Jensen this period and are reflected in the 1950s advertisement on the next page. **VTV Editor**

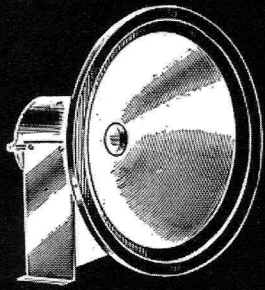

1928 Model DA-4
First high efficiency auditorium speaker

Jensen

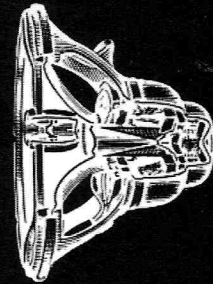

1950 Model G-610
First 3-way integral speaker

Precedents are a habit with Jensen

Since 1927, world's foremost manufacturer of fine loudspeakers

1st

The Jensen organization came into being a quarter-century ago, based on a new concept in loudspeakers. Since then Jensen has made history by consistent contributions to better sound reproduction through improved speaker performance. This record of achievements means that the Jensen speaker you buy today is a product of distinguished experience . . . your assurance that Jensen speaker performance is *always* way ahead.

Jensen Manufacturing Company—6601 South Laramie Avenue, Chicago 38, Illinois
Division of the Muter Company—In Canada: Copper Wire Products, Ltd., Licensee

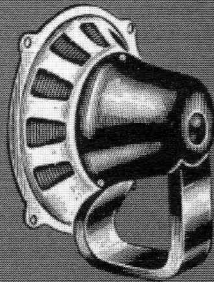

1931 Model PM-1
First PM speaker in USA

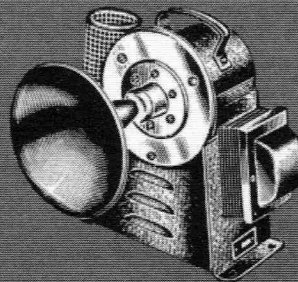

1933 Model Q
First H-F unit "tweeter"

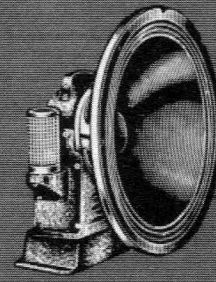

1935 Model L-18
First 18" speaker

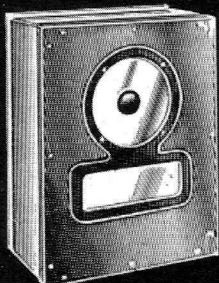

1937 Model KM-15
First "bass reflex" cabinet

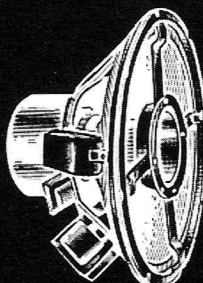

1940 Model JHP-51
First commercially available coaxial speaker

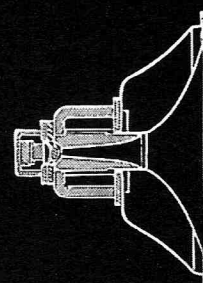

1946 Model HNP-51
First articulated compression driver coaxial

Burton Browns Advertising

Build A Comparison Preamp

By Eric Barbour ©1997 All Rights Reserved

If you get some kind of idea that listening to different tubes for VTV is a load of monkeys, think again. We sit there for hours, doing the same things over and over.....plug in tube, wait for warmup, hit mute switch, hit pause on CD player, listen and take notes, hit pause, hit back-space, hit mute, remove tube, repeat.

We do this because nobody has ever conducted such tests in a systematic fashion. And they certainly haven't published the results! Anyone who previously did this promptly started a manufacturing company. That's where the gorgeous mega-buck stereo preamps come from. And usually, these guys don't even invite the opinions of others, and may use parts of mediocre quality. You don't need to spend over \$5000 to get a good sounding preamplifier.

So, in the interests of freedom of choice and of honesty, we don't mind at all sharing the results of our listening tests. Nor do we mind sharing the preamp circuit we used for these same tests. Using a commercial modern design is not workable--nearly all of them use 6DJ8/6922 types. If you want to listen to, say, 6C4s, what then? The preamp shown here is one that I constructed specifically to listen to the differences in the sounds of medium-mu miniature triodes. It's simple (although not recommended as a construction project for beginners; space is tight in this box) and it is repeatable and reasonably easy to use.

This is the minimum scheme for a line stage. All the sockets are wired in parallel, so as to dispense with complex switching. I did that for the preamp in GLASS AUDIO 3/97, and it worked but was (ahem) less than optimal. Since we are doing medium-mu triodes only, the only plate load is 47k ohms, shared among all the sockets. Only ONE type of tube can be plugged in at once, and both sides of the dual triodes are used for the stereo channels.

The exceptions are a pair of 7-pin sockets to accept 6C4s or 9002s, and a pair of 9-pin sockets to accept triode-connected EF86s. The only other sockets are wired for 12AU7 types, 5687 types, 2C51

types, and 6BQ7/6DJ8 types. That covers the vast majority of medium-mu duo-triodes used in audio to date.

The cathode bias resistors are fixed 1.5k ohms with Black Gate bypass capacitors. Previous experiments had involved an adjustable grid-bias supply and grounded cathode, to allow nulling of second harmonic distortion. That's the best way to test a tube on the bench to develop distortion charts. But in listening, I found that fixed bias was adequate. Because small tubes like this vary all over the place in bias point, you'd have to adjust the bias with a distortion analyzer. Listening to them, however, showed that this was not necessary.

Individual tubes of the same brand and type tended to have the SAME sound quality, regardless of individual bias variations. So we chose 1.5k ohms, a common value. Believe me, hundreds of hours of tests have verified that fixed bias does not affect the sound markedly over self-bias. I suspect that cathode materials have FAR more effect on the sound character than biasing arrangements. Every manufacturer had (or has) their own recipe for cathode oxides for each tube family, and that is the quality that you hear most of all. Except for real junk tubes, each brand tends to sound consistent with itself.

The input is just a 100k stereo volume control. No input switching, just one pair

of input jacks and one pair of output jacks. We DO have a mute switch, which disconnects the output from the output jacks. The resistor R3 provides a "bleed" for any DC levels that appear on the coupling capacitor, so when the tube is plugged in (muted) and allowed to warm up, by the time you hit the mute switch, no DC means no thump to the power amp. So long as you let the tube stabilize, there is no danger of damaging your amp.

Coupling capacitors have an effect on sound; dielectric, foil, winding method all have their sonic artifacts. Since the sound of the tube is what we are listening for, we chose a neutral-sounding 0.22 uF Mylar capacitor for this preamp. It's an Illinois Capacitor unit we use here at VTV for restorations and general work. Charlie bought a large batch of them at OEM prices. They are excellent for all kinds of tube amps and preamps, and they are very affordable, unlike the exotica. Depending on your taste and budget, you may want to try some of the audiophile grade capacitors in this circuit.

The power supply is in a separate plastic box, with wires and banana jacks connecting to the preamp. The 150v plate supply and filament supply are each heavily filtered, so the preamp is very quiet. No regulation is used, and none is needed. I tried all kinds of tube and solid-state regulation, and was unable to verify that these kinds of small-signal tubes really benefited from regulation at line levels, perhaps 1-2 volts p-p output. If you are really anal, a low-dropout regulator for the 6.3 volt filament supply would insure accuracy.

The filament circuit shown varies about 0.3 volts depending on the load; a 6CG7 draws the voltage down a bit more than a 5670, for example. It hardly matters, since the sound quality changes only slightly with such filament variations, and

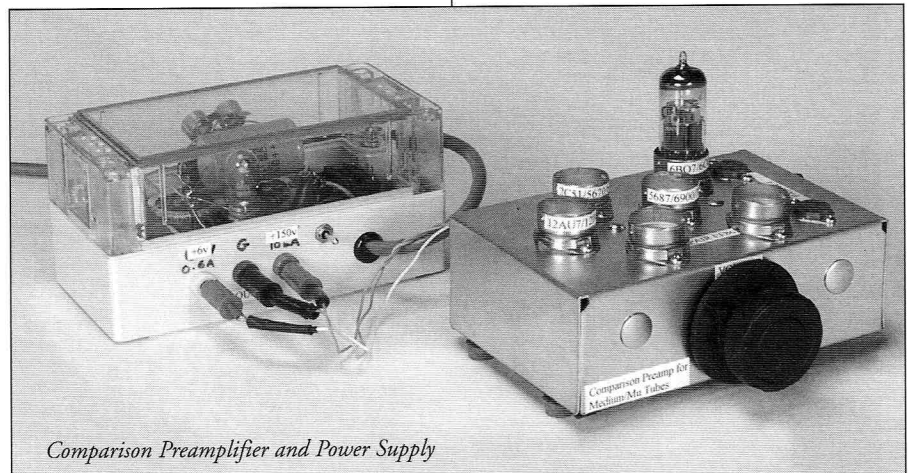

Comparison Preamplifier and Power Supply

BUILD A COMPARISON PREAMP

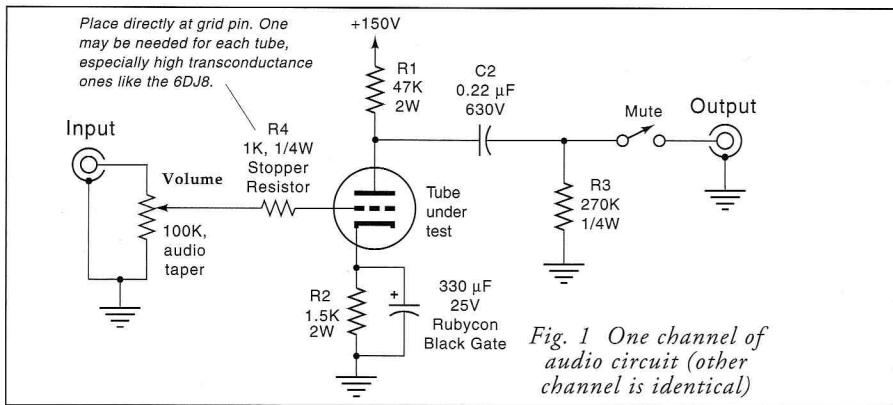

Just show it to your favorite audio guru, and watch him flap his arms hysterically. It doesn't look impressive, but it shows that you actually COMPARE tube brands on your own, and are SERIOUS about finding the best tube. No guru can deal with that. Amazing that such a tiny box can have such power! It may even result in a paradigm explosion. Don't be surprised if you dump your frame-grid triodes and start listening to 12BH7s.

Table 2:

Types Usable in Each Socket

Note: these types vary in gain, so levels must be reset when changing to a type with different gain. Validity of listening tests can be assured by keeping the same listening level throughout. Some types listed are remote-cutoff or otherwise not intended for audio. This list may not be exhaustive.

12AU7:

12AE7, 12AT7, 12AU7, 12AU7A, 12AV7, 12AZ7, 12AZ7A, 12BH7, 12BH7A, 12FV7, 5814, 5814A, 5963, 5965, 5965A, 6189, 6201, 6211, 6211A, 6414, 6679, 6680, 6829, 6913, 6955, 7062, 7318, 7728, 7730, CV455, CV491, CV2007, CV2011, CV2016, CV4003, CV4016, CV5212, CV8154, CV8155, CV8221, E81CC, E82CC, E180CC, E2157, E2163, ECC81, ECC82, ECC186, ECC801, ECC802, QA2406, M8136, M8162, QA2407, QB309, QS2406.

(12AX7, AY7 high- μ types can be tested by making the plate resistors R1=150k ohms.)

2C51:

2C51, 396A, 5670, 6385, 6386, 6854, 7861, 6CC42, CV2575, CV5894, CV8247.

5687:

5687, 6900, 7044, 7119, 7370, 7892, CV2578, E182CC.

6DJ8:

6AQ8, 6BC8, 6BK7/A/B, 6BQ7/A, 6BS8, 6BX8, 6BZ7, 6BZ8, 6CC43, 6CG7, 6DJ8, 6DT8, 6ES8, 6FW8, 6JK8, 6KN8, 7057, 7308, 7803, 8223, 8431, CcA, CV2492, CV5231, CV5358, CV5331, CV5365, CV8065, ECC85, ECC88, ECC180, ECC189, E88CC, E188CC, E288C, X155.

6C4:

6AB4, 6C4, 6100, 6135, 6664, 9002, CV133, CV852, CV2842, EC90, EC92, QL77.

EF86 in Triode:

6267, EF86, CV2901, CV8068, Z729.

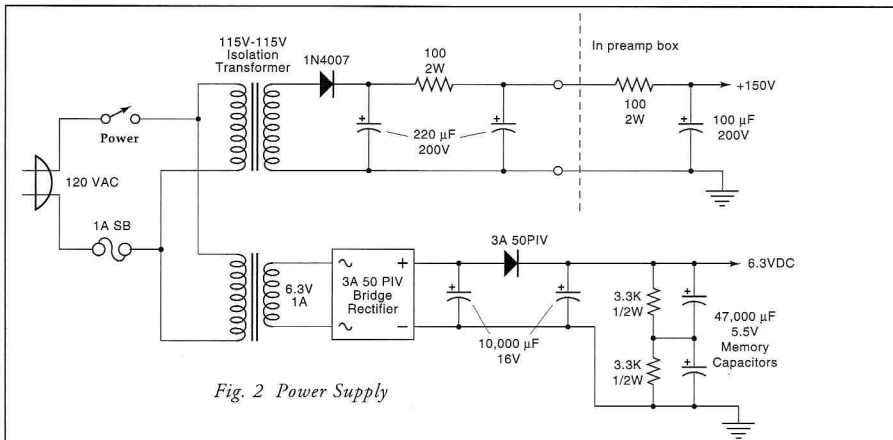

we are comparing similar tube types anyway.

The preamp is in a plain aluminum chassis box with a thin aluminum bottom. The 9-pin sockets are Svetlana SK9As, which are very tight and can be difficult to insert some tubes into; but they grip the pins VERY tightly and give excellent contact. The plate and cathode resistors are good old Allen-Bradley 5% carbon comps, which I matched channel-to-channel. A-B stopped making them recently, so get yours quick. For VHF tubes, grid-stopper resistors are necessary. Try 1K, 1/4W resistors directly attached to the socket pins. This is recommended

for the 2C51 and 6DJ8 sockets to prevent possible RF oscillation. 12AU7 types don't seem to need them, nor do 6C4s or EF86s. The safest way is to put stoppers on the grid pins of ALL the sockets. Some gurus claim that stoppers are extremely critical to the sound; don't believe them! Remember, we are comparing tubes to each other, not changing stopper resistors. Keep the other components the same and concentrate on the sound of the tube.

Once your preamp is built, you can sit down and try NOS and current tubes against each other. This is also a great conversation piece.

Table 1: Pin Wiring To Sockets

	12AU7	2C51	5687	6DJ8	6C4	EF86
Triode, left side, grid	2	3*	2*	2*	6*	9
Triode, left side, plate	1	4	1	1	1	1,6
Triode, left side, cathode	3	2	3	3	7	3,2
Triode, right side, grid	7	7*	7*	7*	6*	9
Triode, right side, plate	6	6	9	6	1	1,6
Triode, right side, cathode	8	8	6	8	7	3,2
Filament, +6.3v side	9	1	4	4	3	4
Filament, ground side	4,5	5,9	5	5,9	4	5

*= stopper resistor recommended



Antique Sound Lab AQ-1002 Kit One Amplifier

A review by John Atwood © 1997

A new wave of low-cost tube hi fi equipment is reaching America. Parts costs are reduced by being fabricated in places like Taiwan and China. One might expect that these cheap units would be lacking in sonic quality or reliability, but in general, this is not the case. By being a factory direct dealer, Antique Sound USA has some of the lowest cost tube equipment available. Their power amps are Chinese, their preamps are U.S. made and most of their products are available in kit form. We review here the model AQ1002K 50 watt/channel push-pull amplifier kit.

The AQ-1002 initially appears to be yet another push-pull 6550/KT88 stereo amplifier in the tradition started by the Scott LK-150 and Harmon-Kardon Citation II. It, in fact, bears a visual resemblance to the Citation II with its clean layout and three potted transformers. The external physical appearance is quite nice. A heavy gold-colored plate is fastened to the front of a chrome-plated steel chassis. Good-quality gold-plated RCA phono jacks and speaker binding posts are used. From a circuit point of view, it is similar to the Acrosound UL-2 or Stereo 120, with direct-coupled differential phase splitter and driver amplifier using 12AU7s. The output tubes are run in the ultra-linear mode with about 465 volts on the plates. Enhancements over the classic designs are discrete transistor

regulation of the driver B+ voltage and negative supply to the first differential (long-tailed) stage. Individual emitter followers buffer the bias voltage to each output tube – helping bias stability. The only real complaint I would have about the basic topology is that both channels share the same power supplies, allowing slight interaction between channels.

There are some deficiencies in the power ratings on some of the resistors used in the AQ-1002 amplifier. R6 and R30, 24K resistors, were measured to be dissipating a solid 1.4 watts, despite being what looked like 1/2 watt metal film resistors. Their bodies are getting discolored. The 10 ohm cathode resistors and 150 ohm screen resistors on the 6550 output tubes are just 1/4 watt metal film resistors. Under normal operation, little power is dissipated in these resistors, but if a tube got gassy or shorted, these resistors would definitely go up in flames. One or two watt flame-proof resistors are the norm in these locations.

The AQ-1002 we built was supplied with the optional Svetlana 6550C output tubes, although Chinese KT88s are also available. The driver tubes were Philips ECG 5814As, clearly from the recent US military tube disposal. These are ruggedized 12AU7s, and have reasonable sound, although when vintage Telefunken were substituted, the sound was clearer.

just 50 watts RMS (one channel operating, 120V line). Biasing the tubes to a more normal 65 mA (30 watt/tube dissipation) raised the maximum power level to 55 watts, and reduced the distortion somewhat, at the cost of shorter tube life (especially for the Chinese KT88s).

The frequency response is good: -3db down at 5 watts from 6Hz to 67KHz. The overall square-wave response is quite good, especially for an amplifier with such low feedback.

Since the driver stages are direct-coupled, exact balance is critical to achieving good performance. The manual's instructions for adjusting the driver balance including balancing the plate voltages of the first stage. When this was done, the amp had fairly high 2nd harmonic distortion in both channels: about 4% at 5 watts, rising slowly to 10% at 50 watts. Adjusting the driver balance for lowest distortion brought the distortion figures down to .15% at 5 watts and 4.7% at 50 watts. Without a distortion analyzer, adjusting for DC balance on the second driver stage brought the performance much closer to optimum than balancing the first stage. The driver circuit is conceptually good, but in this amplifier contributes more distortion than it really should; thus, its adjustment is critical.

While the exterior finish and basic circuit topology are good, the internal mechanical design, especially regarding the PC board, is deficient. With the exception of a pre-assembled bias board, all the circuitry is mounted on a single-sided fiberglass PC board, which is in turn mounted on a steel sub-chassis, apparently to eliminate screw heads on the top of the chassis. There are 12 stand-offs between the PC board and the sub-chassis, but the flimsiness of both lets the board flex excessively when tubes are inserted or removed. The bias test points are kind of a joke: power plugs (like on an AC adapter) that are supposed to be silicone glued into snap-in LED retaining rings. Since these don't even fit together, and if glued, looked likely to come apart,

Unusual for an amplifier of this type is the relatively low amount of feedback – about 3.5 db. This gives the amplifier an appealing dynamic sound, but the distortion is fairly high. At the recommended output tube bias current, 50 ma per tube, the amp started to clip at



AQ-1002 circuit boards, parts and tubes

these weren't installed, and biasing was done with the bottom cover removed.

The PC board had some problems from both a construction and a reliability point of view. It is a single-sided board with all components except the tube sockets and bias trimmers on the bottom. The board is arranged with the copper foil on the opposite side of the components, which is conventional, but in this case leads to two problems. The trim pots and tube sockets are very hard to solder, because their bodies block access to the foil. It is also impossible to change components without removing the board - a difficult procedure.

In order to allow wires to be soldered to the main PC board without removal, small copper eyelets were installed in all holes where wires connect, as well as around each pin of the octal tube sockets. This is a nice concept, but on power-up, it was found that several of the eyelets were not making electrical contact with the traces under them, especially on the filament connections to the tubes. After lots of fussing and resoldering, separate wires running from pin to pin of the tubes solved the problem. However, after a few weeks of use, another filament connection opened up, requiring more bypass wires. It seems stable now, but

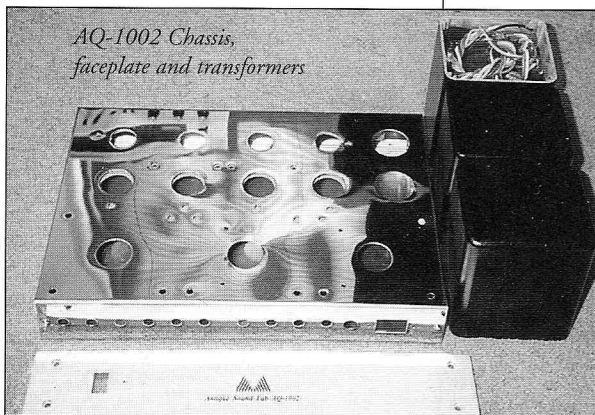

*AQ-1002 Chassis,
faceplate and transformers*

such poor electrical integrity is unacceptable. Antique Sound USA is now having better boards built, but the best solution, although a bit more expensive, would be to use a double-sided board with plated-through holes.

The kit's assembly manual was obviously written and produced in America, which eliminated the odd English present in the small "Instruction Manual". In addition to assembly instructions, the assembly manual gives resistor color codes, initial testing, technical specs, a parts list, and the schematic diagram.



*New, updated
A-102 Amp*

However, this is no kit for beginners! There are no diagrams identifying parts, no diagrams showing mounting details, no diagrams showing wiring, no diagrams showing adjustment locations, in short, no diagrams! When the instructions say "Install eight (8) test point insulators (sic) retaining rings," "Install D9, Zener diode 100V observe polarity," or "Mount the assembled main PC board" (how????), you better know your components and be resourceful in identifying which hardware is needed to mount things. This kit is recommended for "a reasonably experienced person," but our review unit was built by a highly experienced tube amp constructor who had numerous confusions and complaints due to the terse instructions. Extra explanations and descriptions can only help. And, please, add some diagrams!

We auditioned the amplifier with a wide variety of music through both large, efficient speakers and smaller, less efficient speakers. The AQ-1002 was dynamic and powerful sounding. It performed especially well with jazz, rock and orchestral music. The overall presentation of the AQ-1002 was balanced, with strong bass, smooth mids and extended highs. It works well with both high and low efficiency speakers, which is a plus.

Antique Sound has made improvements to the design of the AQ-1002 to address some of the problems in the earlier units. The updated amp, model A-102, has a switchable bias meter on the front

panel that now makes bias adjustment much easier. A new circuit board without the problematic eyelets is being used. These changes are a good sign that the manufacturer is responsive, and is interested in putting out a quality product.

The Antique Sound Lab AQ-1002K kit as built and tested was marred by insufficient assembly instructions, a marginal quality PC board, and critical adjustments. Most of these problems have already been fixed in the A-102. The finished unit is quite a decent performer, with good, powerful sound, and for the money, is an excellent buy.

A102 50W/channel Stereo amplifier.
Kit price: US \$899 Assembled: \$1195

Antique Sound USA
6717 NE 181st St., Seattle, WA 98155
USA
Tel: 206-481-8866, FAX: 206-485-3836

email: franklab@ix.netcom.com

website:
<http://www.amemura.com/sound/>

Tube Amplifiers Lab

Tubes are back! Learn how electron tubes work and some basic things about audio electronics. We will build a superb stereo amplifier from scratch using a step by step approach. This is a unique opportunity to build your own state-of-the-art audio equipment.

John Atwood - Instructor

**Contact The Randall Museum,
San Francisco (415) 554-9600**

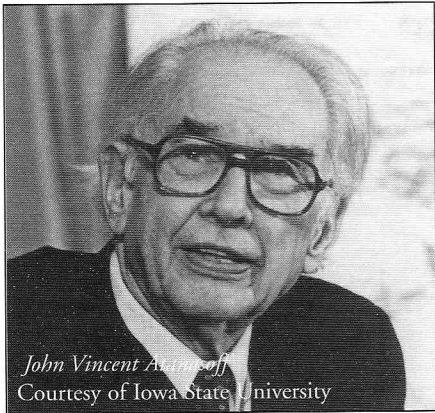

John Vincent Atanasoff
Courtesy of Iowa State University

Entry

Every age has tried to rewrite history to suit its leading citizens. So it is with the computer industry, today and all through its brief existence. People with power and money manage to uncreate the past, even while they feed upon its foundations. Very, very few "innovators" manage to create an entire new universe with their first major invention. Indeed, "innovator" is a word which is tossed around lightly today, and affixed to all kinds of personalities. Virtually none of them can claim to have made a real change to our civilization, as they merely offer some small improvement to an existing body of knowledge.

I am going to introduce you to two men who really DID change the world.



Clifford Berry
Courtesy of Iowa State University

And yet, they are virtually forgotten today. Don't listen to those who claim that the basic units of today's computers were invented by the ENIAC team, or by

Babbage, or by Claude Shannon. If you feel like confronting somebody about this, grab a few computer-industry professionals, and ask: who were John Vincent Atanasoff and Clifford Berry? If the ignorance machine is working at its usual level, those "professionals" will be unable to recognize those two names. And they should know the names, as they owe their careers to Atanasoff and Berry.

For these two obscure men, working

COMPUTING WITH TUBES-THE SAVAGE ART

By Eric Barbour © 1997

1. ABC, THE FATHER OF EVERYTHING

on a small budget in a small lab at Iowa State College (ISC) between 1939 and 1942, made the first electronic digital computing machine. And I mean the FIRST one. Not only that, they created many of the things that logic designers take for granted today, from the NOT gate to the dynamic memory.

Concept

In 1935, Atanasoff was an associate professor of physics at ISC. He wanted to find an automated way of solving simultaneous linear equations, of the type often found in areas such as vibration or elastic structures. He had the idea of looking into the possibility of doing it with the new thing called radio circuitry. By combining electronics with a mechanically-scanned memory using charged capacitors, Atanasoff hoped to solve up to 29 equations of 29 unknowns, using the standard Gaussian elimination method. Since this required multiplication, a difficult thing to do electronically at the time, he opted to subtract one row of coefficients from their counterparts in the other equation, and then shift the first coefficients. When the coefficient was removed, a change of sign would occur and the machine would stop. The operator would watch for this and read off the results. This reduced most multiplications and divisions to add-subtract-shift operations, keeping the machine relatively simple.

Atanasoff read up on the previous work by pioneers such as Babbage, Merrifield, Jevons, Peirce, Marquand, Hollerith and Bush. Unfortunately, nearly all of what we call

"computing" had previously been done with mechanical devices, and the limits of "digital" electronics were described by the bistable multivibrator, or "flip-flop," invented by Eccles and Jordan in 1919 (and used very little until the late 1940s). The things we now call "gates" were unknown, and even though Claude Shannon published a paper in 1938 on ways of doing Boolean algebra with relays, Atanasoff was not aware of Shannon's work.

When he finally had a starting point, in September 1939 he hired a physics grad student named Clifford Berry as an assistant, and within four months they had constructed a small prototype of the basic arithmetic-memory device. In a

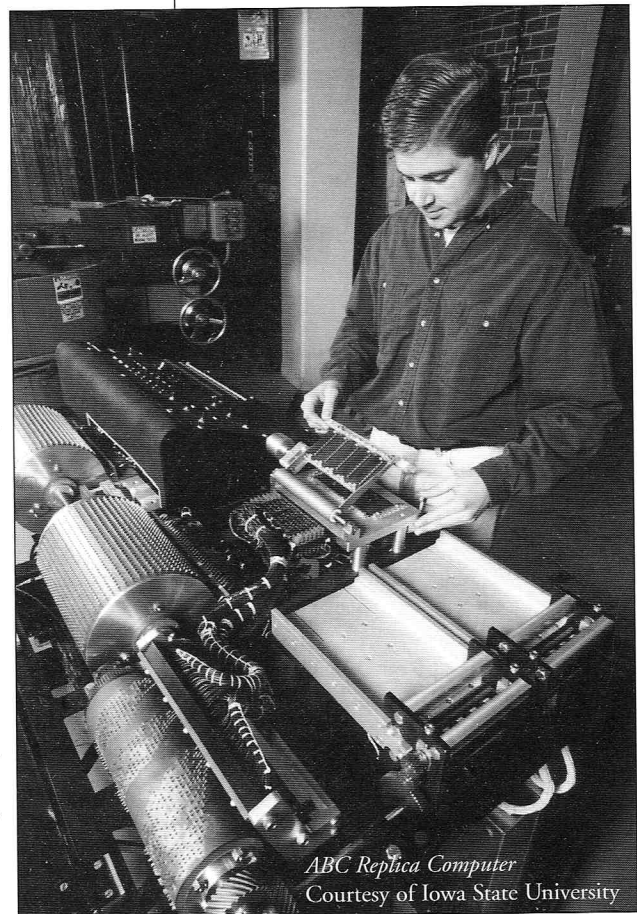

ABC Replica Computer
Courtesy of Iowa State University

major and convulsive step, Atanasoff decided that base-two arithmetic was simple, efficient and suitable for his computer. The ENIAC, which came along in 1946, still clung to decimal one-of-ten arithmetic. And the IBM 603 electronic multiplier, which was also announced in 1946, used BCD (Binary Coded Decimal) rather than straight binary.

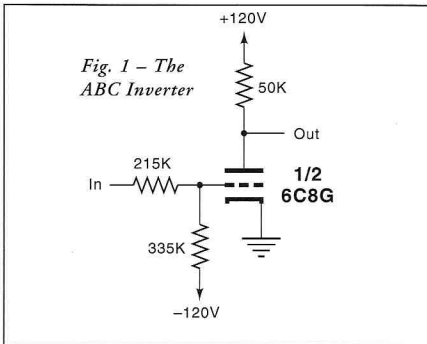

Fig. 1 - The ABC Inverter

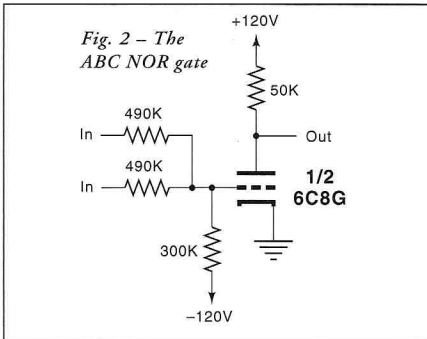

Fig. 2 - The ABC NOR gate

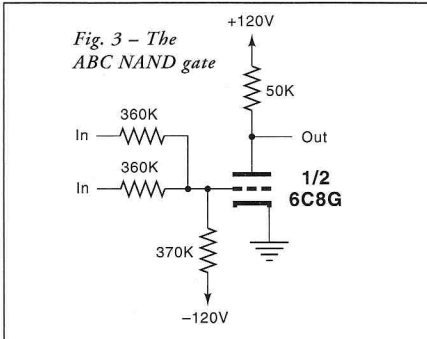
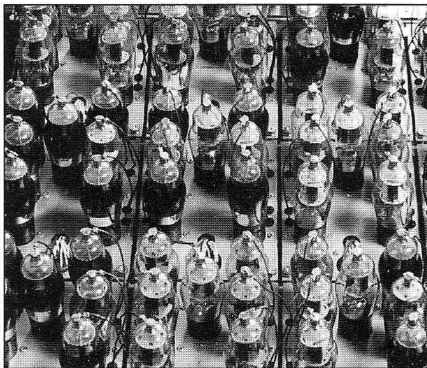

Fig. 3 - The ABC NAND gate



Bank of add-subtract circuits in the ABC computer

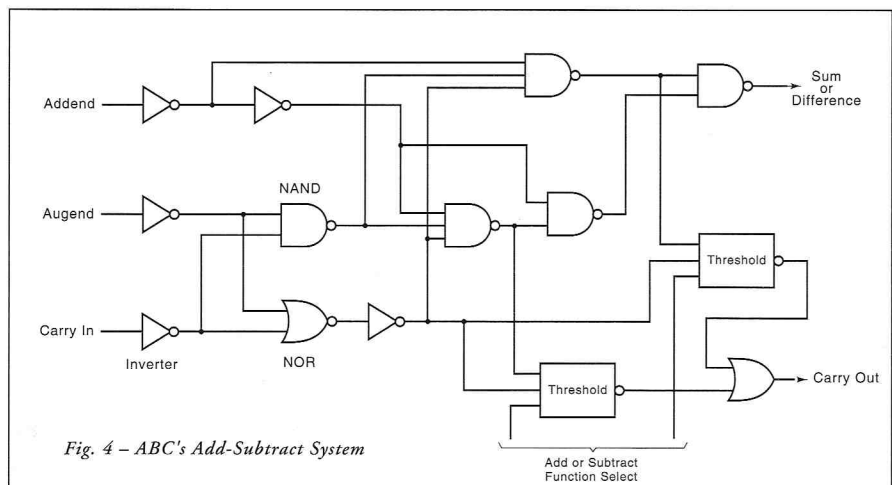

Fig. 4 - ABC's Add-Subtract System

Basic Blocks

Because Atanasoff and Berry were working in relative isolation, they devised their own jargon and notation for the logical systems in the ABC. The simplest one was what Atanasoff called, in his own logic shorthand, a (1,1) circuit in Figure 1. This means a single-input circuit having a high input to lower the output. Today, we call this an inverter. Or, a NOT gate. The concept was not original with ABC, but this was the first time it was done with electronics and not relays or mechanical devices.

In Figure 2 is what Atanasoff called a (2,1) circuit. We call it a NOR gate. As you can see, the resistor inputs limited the fan-in of these circuits. They were optimized for one, two or three inputs by adjusting the grid resistors. And in Figure 3 we have Atanasoff's (2,2) circuit, better known as a NAND gate. It is identical to the NOR, except for the grid resistors. All of the logic in ABC was implemented with 6C8G dual triodes, which are akin to 6SN7s except for a higher mu and a grid cap for one triode.

Memory in ABC was not done with Eccles-Jordan multivibrators. Atanasoff had the bright idea of using a mechanical-electrical memory scheme instead, to minimize the number of tubes. So he had Berry make large phenolic drums, covered with brass studs. Each stud had a .0015 uF paper capacitor attached to it, with the other ends of all the capacitors connected to a common slip-ring for pickup by a brush. A row of smaller brushes contacted the studs, allowing a regeneration circuit to read the charge on each capacitor, then rewrite the charge. This is basically the same concept used in today's solid-state DRAMS. ABC used two large drums, holding thirty numbers of 50 bits each. A smaller drum held thir-

ty capacitors for the carry memory function, used during addition/subtraction. And a drum with only a set of simple contacts, lined up with the studs on the memory drums, provided the system clock signal. All this was driven from an ordinary AC motor. As a result, ABC managed to do all the logic with only 255 tubes.

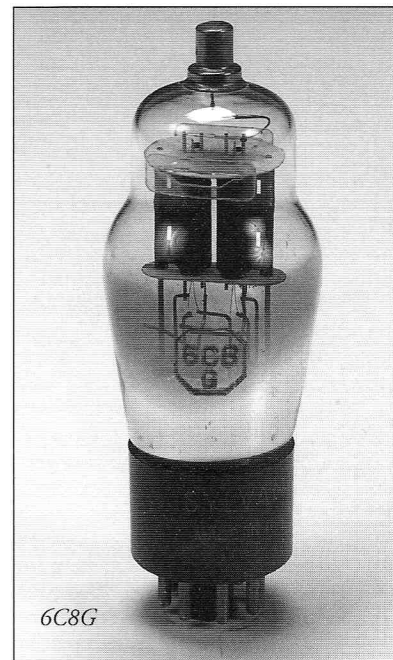

6C8G

The add-subtract circuit was made of logical primitives like the above, plus a "threshold" circuit, which gave a low output if at least two inputs were low. Figure 4 shows the ABC add-subtracter, drawn with modern Boolean gates where possible. ABC did this in a bit-serial manner for each binary number, with carry/borrow remembered in its separate capacitor drum. The addend was on the "counter" drum, the augend or subtra-

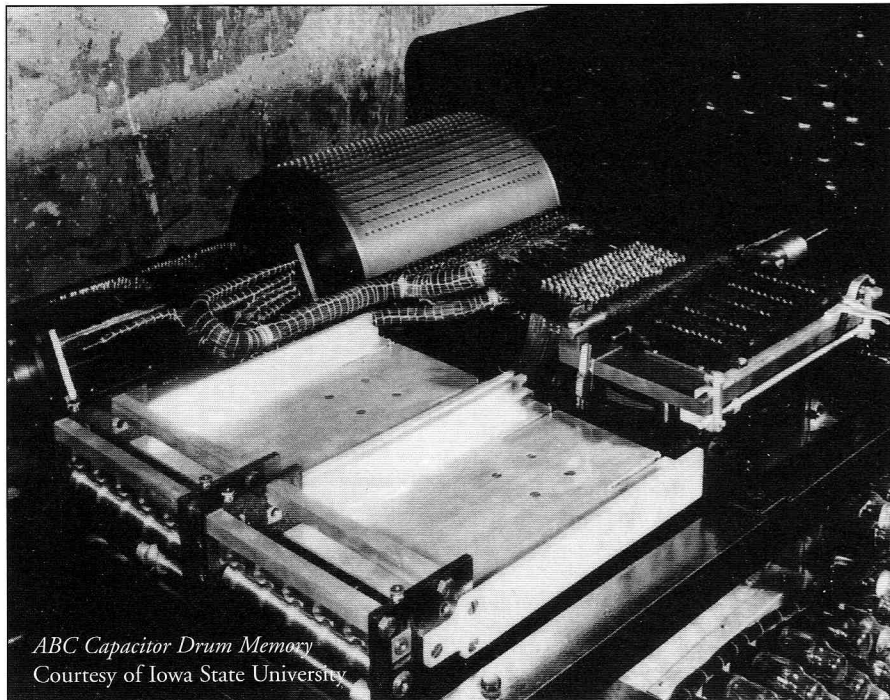

ABC Capacitor Drum Memory
Courtesy of Iowa State University

hend on the "keyboard" drum. Results went onto the counter drum. When a variable in the linear equation set had been subtracted out, a shift circuit moved other variables over one space on the drum. When the machine was finished, it left one variable to be calculated by long division.

Input/Output

To make operation easier, Atanasoff provided a device to convert decimal numbers on cards into binary. This was done with a drum on the same shafts as the memory drums. It simply had a stud wherever a 1 was to be written, no stud for a 0. The decimal number was fed into the decimal card reader, and the resulting binary number was sent to the counter drum. Obviously, the world's first read-only memory. The decimal cards were punched by hand with an IBM 0010 punch, a simple gadget with 12 keys for the 12 columns of a standard 80-column card. (Tedious as all this sounds, it apparently was much faster and less error-prone than a human being operating a hand-cranked adding machine.)

The card "punch" of ABC was a truly fearsome thing. Because Atanasoff figured that a regular mechanical punch would be too slow (1500 bits per second), and because funds were limited and IBM punches were expensive, he decided to do something gonzo. Two mechanisms were built, one to write to a paper card, the other to read the card. And writing

was done in a brute force way--holes were BURNED into the card by a row of pointed wire contacts on either side of the paper.

An OA4G thyratron for each of 12 columns would pulse a 5000-volt power supply across the electrodes, thus sparking and burning the paper. It turned out to be fast enough, so that the ABC's drum could rotate at 60 rpm and still give accurate results. The reader applied 1600 volts across rounded wire contacts, thus current would be conducted when carbon in a burned area bridged a contact pair. What the hell, why not?

Apparently, ABC never got a full 29-equation run-through, though it did successfully solve as many as 5 unknowns. Its creators were called up for war work, and the head of ISC's physics department ordered the machine scrapped. The only surviving piece is one memory drum. It is in the Smithsonian, basically forgotten and overshadowed by ENIAC until recently.

EXIT

Everything that we call "digital" today owes its very existence to Atanasoff and Berry. They invented most of the common logic primitives used to design modern digital electronics, while working alone and with very little support. Berry was an electrical engineer, yet much of what they did was in terra incognita. They knew nothing of Boolean algebra or Shannon's work, and they devised their

machine with very, very little previous art to build upon. And like many true pioneers before and since, they have been rendered non-existent by ignorance of the sort that financial empires and Internets are built upon. So where is the giant stone monument to the REAL innovators?

Final notes: For those who want to learn more about the ABC and the 1964 lawsuit that established it (not ENIAC) as the first digital computer, the Burks book is highly recommended. It is jammed with basic information, including enough to allow a smart engineer to reproduce ABC exactly.

And, starting in 1994, staff at the Ames Laboratory at Iowa State University decided to construct a fully operational replica of the ABC. Their machine was finished in 1996 and displayed at the Supercomputing '96 show in Pittsburgh in November 1996. You can examine it in detail at the Ames Lab web site, www.scl.ameslab.gov/ABC/.

Many thanks to the staff of The Computer Museum for their invaluable assistance with researching this article. Special thanks to John Gustafson of the Ames Lab ABC team and Skip Derra of Iowa State University for their help with the photographs and fact checking.

Bibliography

1. Alice R. Burks and Arthur W. Burks; **The First Electronic Computer: The Atanasoff Story**, University of Michigan Press, Ann Arbor, Michigan, 1988.
2. Clark Mollenhoff, **Atanasoff: Forgotten Father of the Computer**, Iowa State University Press.
3. Howlett and Rota, **A History of Computing in the Twentieth Century**, ed. Metropolis, Academic Press, New York, 1980.
4. Charles J. Bashe, Lyle Johnson, John H. Palmer, Emerson W. Pugh, **IBM'S Early Computers**, The MIT Press, Cambridge, Massachusetts, 1986.
5. *Computer Pioneers and Pioneer Computers*, Hosted by Gordon Bell. Videotape, 1996. Produced for The Computer Museum and the Association For Computing Machinery by Larry Mondri Productions.

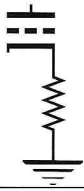

Cathode Bias

by
John Atwood

Ceramic Capacitors

Engineers are familiar with the peculiarities and non-linearities of iron-cored inductors and transformers. The advantages of ferromagnetic materials such as iron, nickel, and various alloys are so important that ways are found to work around their non-ideal properties. But did you know that there is an electrostatic equivalent to ferromagnetism that is the basis of many ceramic capacitors? As with ferromagnetic materials, ferroelectric materials allow much smaller devices, but they also share other less desirable properties such as nonlinearities, temperature sensitivity, microphonics, and aging effects.

Ceramic capacitors originally were made from ceramic or porcelain, the same as used for insulation, for low-value RF uses. It was found that different mixtures would give different controlled temperature coefficients, examples being NP0 (zero change with temperature) and N750 (negative 750 parts per million per °C). These capacitors find use in RF resonators that must stay tuned with temperature variations. Still made today, these capacitors range from 1pF to over 1000pF, and have very good characteristics: low loss, low drift, low dielectric absorption.

In the 1920s, crystals were discovered that could hold an electrostatic charge. In addition, they were piezoelectric (could translate mechanical energy to electrical energy and vice-versa). The most common type, Rochelle salt ($\text{NaKC}_4\text{H}_4\text{O}_6 \cdot 4\text{H}_2\text{O}$) was soon being used in the first "crystal" microphones and phono pickups. Rochelle salt is water-soluble and has a Curie point of only 23°C. The Curie point is the same as in ferromagnetic material: the temperature above which the material's special properties are lost. Thus Rochelle salt could only be used in benign consumer environments.

In 1943, a new ferroelectric material was discovered that was very stable, could be formed as a ceramic, and had a relatively high Curie temperature of 120°C: Barium Titanate (BaTiO_3). Barium titanate has a very high dielectric constant, and in its

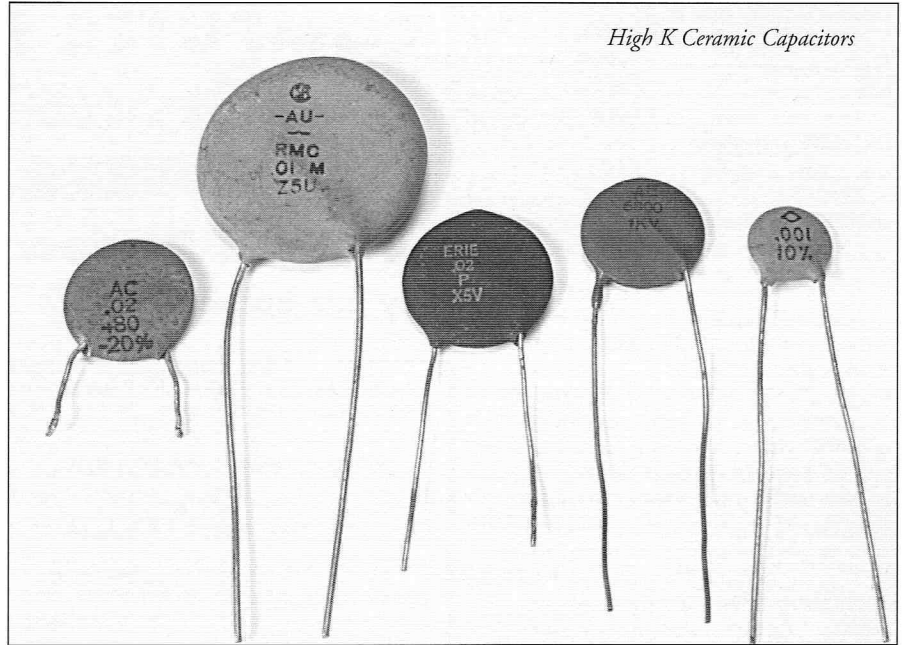

High K Ceramic Capacitors

polycrystalline form, could be used to make ceramic capacitors with much higher values than the traditional NP0 types. Their compact construction (either tubular or disk) made them very useful for RF applications, and they could be made very cheaply. They were also much more reliable than the mica or paper capacitors they replaced. By the early 1950s, so-called "High-K" ceramic capacitors were ubiquitous in electronic equipment.

These High-K ceramic capacitors had a host of electrical problems, though. They have relative high dissipation factor (1 to 2%, much worse than mica, polystyrene, or NP0 types), had very significant temperature drift, change with age, and can be microphonic.

High-K ceramic capacitors come in several grades, including X7R, Z5U, and Y5V, with Z5U being the most common. From 25°C to 50°C, Z5U capacitors decrease in value by about 15%, while Y5V decrease by about 50%! These types also change their capacitance with applied DC voltage, with up to a 25% decrease as the maximum voltage is reached. One of the most interesting effects is aging. The Z5U and Y5V types lose 5% of their value for every decade increase in time. For example, at 1 hour, it is 5% less, at 10 hours it is 10% less, at 100 hours it is 15% less, etc. Assuming that the manufacturer accounts for the first 100 hours or so, a tolerance of 10% can only be held for about 2 years. With much vintage equipment using ceramic capacitors being 20 to 40 years old, capacitance shifts of up to 20% can be expected. If

the ceramic is heated above the Curie temperature, the capacitance resets to its original value.

With this aging phenomenon in mind, I decided to check a few old capacitors. I noticed that the de-emphasis in a Fisher 100B FM tuner (from about 1962) was off. I carefully clipped two capacitors out of the circuit, each marked: "RMC JF .0022 10% Z5F," Using a General Radio 1650A impedance bridge, the following capacitances and dissipation factors (DF) were measured:

Capacitor A		Capacitor B	
Cap.	DF	Cap.	DF
As clipped from circuit:			
1820pF	0.6%	1645pF	0.55%
After leads heated by soldering iron:			
1880pF	0.8%	1810pF	0.75%
After capacitor heated by match flame:			
2110pF	1.0%	2040pF	1.0%

Re-heating the capacitors raised the capacitance from 16% to 24%, but nearly doubled the dissipation factor. The use of a 10% part in something critical to the sound of the tuner is questionable, but with the aging effects of ceramic capacitors, the impact on frequency response is especially bad. Needless to say, I replaced these capacitors with mica capacitors.

Another interesting characteristic of high-K ceramic capacitors is the piezoelectric effect. Normally, if a capacitor is cooled-down below its Curie temperature with no DC voltage applied, no piezo

electric activity occurs. However, if the capacitor has high-voltages applied at high temperatures, which can sometimes occur during device burn-in and testing, a permanent charge can be trapped in the dielectric and the capacitor becomes microphonic. This is more than just an academic problem; I have encountered a significantly microphonic disc ceramic capacitor in the signal path of an Ampex 351 tape recorder electronics.

Ceramic capacitors are used in the signal path of a lot of old audio equipment. Aside from the problem of high loss, which usually translates to a degraded sound, their use in frequency-critical applications, such as tone controls, filters, and de-emphasis circuits should be avoided due to the problems of capacitance drift. Good replacements would be polystyrene, polypropylene, or mica capacitors. Ceramic capacitors used in RF or IF applications should probably not be replaced though, since, in most cases, they are being used in bypass applications, where the exact value is not critical. Also, the parasitic inductance of the capacitor and its leads is often accounted for in the design of the RF circuit, so arbitrarily changing a ceramic capacitor to another type in these circuits can lead to unexpected problems. In the case of N750 or similar ceramic capacitors, the controlled temperature coefficient may be an important aspect of the circuit.

As with all components, ceramic capacitors are not always what they seem. They can be quite useful, but sometimes were used inappropriately. Knowing that they are based on special ferroelectric materials, with all their pros and cons, will help you use them correctly in new designs, and handle them in old equipment.

Bibliography (thanks to Wally Chan for these):

1. Johanson Dielectrics, Inc., **Understanding Chip Capacitors**, 1975.
2. F. Jona, G. Shirane, **Ferroelectric Crystals**, originally published by Pergamon Press, Oxford and Macmillan, New York, 1962, republished by Dover Publications, 1993.
3. Suchital, Payne, **Piezoelectric Measurements on Ceramic Multilayer Capacitors**, IEEE Trans. on Components, Hybrids, and Manufacturing Technology, Vol. CHMT-8, No. 2, June 1985. pp. 283-288.

COMPUTER PIONEERS AND PIONEER COMPUTERS

A Video Review

By Eric Barbour © 1997

COMPUTER PIONEERS AND PIONEER COMPUTERS

Package containing two VHS tapes:

Tape 1, "Dawn Of Electronic Computing, 1935-1945", 53 minutes;

Tape 2, "The First Computers, 1946-1950", 54 minutes.

Produced for The Computer Museum and the Association For Computing Machinery by Larry Mondt Productions.

Price: US \$50.00. Available from: The Computer Museum, 300 Congress Street, Boston MA 02210 (617) 426-2800, store@tcm.org, www.tcm.org.

Learning more about the early days of digital computing is difficult. Textbooks on the subject seem to be very scarce. The only one I ever recall seeing (until recently) was published by IBM in 1986 and has been out of print since then--it must have been a sales disaster.

How little people care nowadays. The big machines of the 1939-1950 period were the foundation of today's PCs and Internet. All of the basic concepts in such routine daily use, from peripherals to programming to Boolean primitives, were originated when transistors weren't even science fiction. Finally, a video is available. Hosted by Gordon Bell of The Computer Museum, the two-tape set covers the first machines to use electricity and electronics to perform calculations. Before 1939, this world was all-mechanical, and a "computer" was a young woman being paid 50c per hour to work a lever-cranked machine. This changed around World War II. Like television, there were many inventors of the programmable computer, and they arrived at the same concepts semi-independently.

It started with telephone relays. A 1980 lecture by George Stibitz of Bell Telephone Laboratories covers the STL-1, the first machine to use binary Boolean

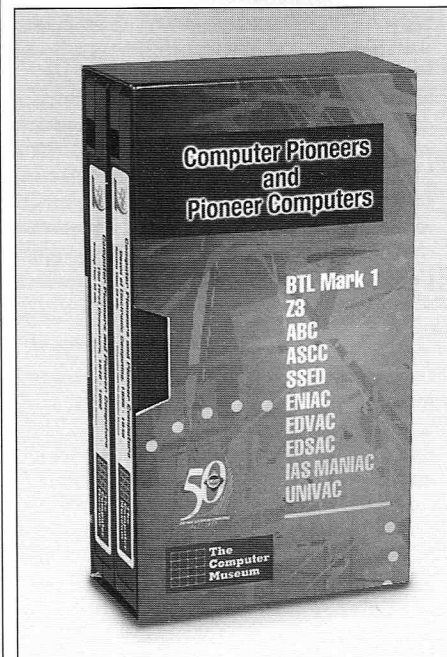

logic in some functions. It was developed in 1937 and built in 1939. Being a telephone-relay calculator for complex numbers, the STL-1 had no real programming capability. Think of it as a huge HP-35 hand calculator with a teletype machine.

Konrad Zuse developed the first programmable calculator in Germany. His idea in 1935 was for a relay system that could perform a sequence of operations read off a punched 35mm film strip. Zuse himself tells some of the story in a 1981 lecture. Many of these pioneers have died since the lectures were given, so this video is a piece of history in its own right.

Electronics appeared in 1939-42. Iowa physicist John Atanasoff, with assistant Clifford Berry, built a machine for solving linear equations. It was full of firsts: electronic AND and OR gates (made of 6C8G triodes), and an amazing memory made of spinning drums full of capaci

IBM AUTOMATIC SEQUENCE CONTROLLED CALCULATOR

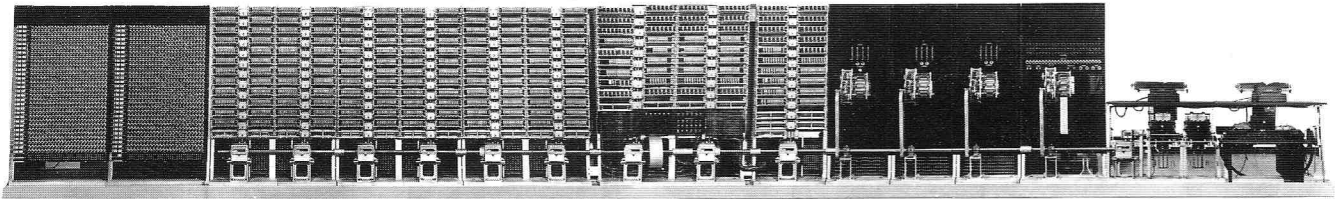

60 CONSTANTS 72 STORAGE COUNTERS MULTIPLY-DIVIDE UNIT FUNCTIONAL COUNTERS INTERPOLATORS-1,2,3. SEQUENCE CONTROL TYPEWRITERS - CARD FEEDS - CARD PUNCH

DESIGNED BY—
 Genl. Howard Aiken, USNR
 Mr. F. D. Love, IBM Corp.
 Mr. F. E. Hottelstein, IBM Corp.
 Mr. E. W. Burkes, IBM Corp.

PRESENTED TO HARVARD UNIVERSITY BY INTERNATIONAL BUSINESS MACHINES CORPORATION

Photo courtesy of The Computer Museum

AUG. 7, 1944

tors. See this issue's installment of THE SAVAGE ART (page 28) for more about the "ABC".

The ASCC, or Harvard Mark I, became the first really large computing device. A joint Harvard/IBM project, ASCC used relays, punched cards for input/output, and plugboards for configuration control. Grace Hopper, an assistant to project leader Howard Aiken, tells how the ASCC was operated.

SSEC was developed by IBM at the prodding of Thomas Watson Senior, who demanded a machine to compete with ENIAC in 1946. IBM engineers had it working by 1948. Herb Grosch gives the lecture about the SSEC, which was a hybrid of relays and tubes and used punched tape loops for on-line storage.

Tape 2 proceeds to electronic-only machines, starting with ENIAC. Developed at the Moore School of Engineering at the University of Pennsylvania by J. Presper Eckert and John Mauchly, ENIAC was all-tube except for IBM punch-card machines used for some input and output. Eckert describes a decimal accumulator digit plug-in, containing 28 octal base tubes (mostly 6SN7s and 6SJ7s). Arthur Burks, one of the ENIAC operators, narrates an old newsreel film of its use. Mauchly was influenced by Atanasoff's work, but ENIAC was quite unlike the ABC. John Von Neumann came to the ENIAC project in 1945 and thought up the idea of a control program in the same memory as the numeric data. ENIAC did have limited forms of stored programs, even with simple conditional branching. Mauchly explains, in a 1976 Los Alamos lecture, how they thought up these stored programs, which were read off a bank of rotary switches.

This team moved on to the EDVAC in 1951. It had main memory stored in mercury delay lines, while a magnetic drum held long-term data. ENIAC and EDVAC led to three major branches of

the nascent computer industry: the EDSAC of Cambridge University, which led to the development of all British computers; the IAS design; and the Eckert-Mauchly Computer Corporation.

The British branch of the story is described first by Maurice Wilkes, creator of EDSAC in 1948. It was the first electronic computer in Europe, and was intended to test a novel memory device based on an ordinary CRT: the Williams tube. It was not as reliable as desired, so Wilkes and his team used mercury delays. Manchester University had its Manchester Computer or British Mark I at about the same time. F. C. Williams and Thomas Kilburn were veterans of the secret Colossus code-breaking project and responsible for the Manchester machine, mostly made of war-surplus parts. It used the first successful Williams tube memory, which we will discuss in a future issue of VTV. EDSAC led to Lyons Company Ltd. devising one of the first business computers, LEO. A 1955 promotional film is shown, with the prototype LEO being used to run Lyons' main business, supplying tea shops with baked goods.

The IAS machine was invented in 1952 at Princeton University by some members of the ENIAC team. IAS pioneered parallel bus communications, unlike previous designs. Many institutions built their own IAS machines: AVI-DAC, ORACLE, MANIAC, ORDVAC, ILLIAC, SILLIAC, WISEAC, JOHNNIAC et cetera. A 1953 film about MANIAC shows the standard components of a computer, then and ever since: memory, control, arithmetic unit, input and output. The typical MANIAC register flip-flop is shown, a 6J6 dual triode with a neon lamp for display.

The amazing Whirlwind of 1950 is briefly covered. Built at MIT to run a flight simulator, this enormous beast could qualify as the first "supercomputer." It pioneered the magnetic core memory, which dominated computing until the 1970s.

In 1948 Eckert and Mauchly started their own company, and made BINAC in 1949 for a fire-control system (most early machines were used by the military). Then came UNIVAC I of 1951, delivered to the U.S. Census Bureau. Eckert-Mauchly sold out to Remington Rand, resulting in what is now Unisys.

Gwen Bell, founding president of the Computer Museum, is trying to establish a branch of the museum in Silicon Valley, and has encountered some charming apathy. Much of the collection (including pieces of Whirlwind and other bits of history) sits in visible storage at Moffett Field, Mountain View, CA. VTV readers can help support the museum and remember the tubed origins of computing by buying this video. We realize that this has nothing to do with audio, but it's time to free your mind. Besides, so much of this stuff is nearly forgotten.....and some of it is very, very weird. Brace yourself, as we explore a parallel universe in future issues.

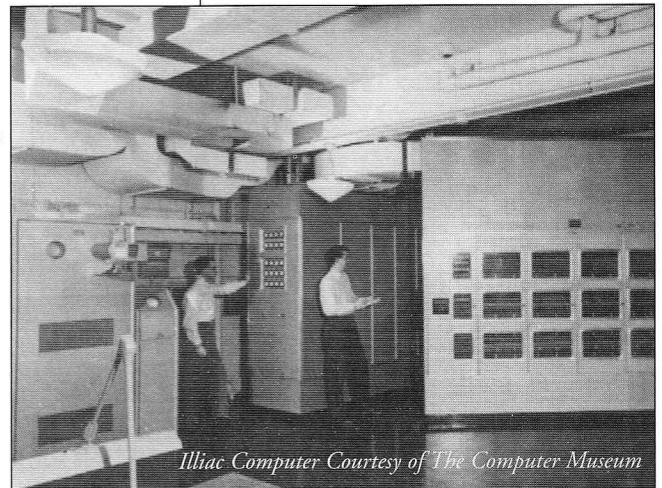

Illiac Computer Courtesy of The Computer Museum

VTV at the Winter 1997 CES in Las Vegas

By Charles Kittleson ©1997



Every year, right after the Christmas holiday blitz, electronics manufacturers, buyers, dealers, enthusiasts and the press show up in Las Vegas and take over the town for a week. At the 1997 CES, it was reported that over 120,000 people showed up for the show. No less than five major hotels and the Las Vegas Convention Center were jammed with everything from digital watches to home theater to high-end vacuum tube audio amplifiers.

The high-end specialty audio event was held at a new venue this year, the Alexis Park Hotel. Most of the major players were there and many not-so-major players as well. As usual, tube equipment dominated the specialty audio scene again with at least 60 percent of the rooms using some type of tube equipment. Tubes are no longer a fringe product, but are now the de-facto standard for the best sound.

At the Alexis Park, we met Joe Roberts, Editor of Sound Practices Magazine. Joe was with Harvey "Gizmo" Rosenberg, plus Ron Welborne of

Welborne Labs, as they were discussing the fine points of the VAIC VV30B triode. Since this was the first time Joe and I met face-to-face, he said - "You don't look like I thought you would." I told him the feeling was mutual.

Harvey Rosenberg was in his full-dress "Thermionic Techno-Shaman" regalia featuring a 300B headband, a "The Triode Father" T-shirt, Scottish kilts and hiking boots. Eric, Steve and I were dressed in normal street clothes and Harvey said we looked like "A bunch of Fuller Brush salesmen." Needless to say, Harvey attracted a significant amount of attention in his salesman's costume.

Harvey talked us into attending "The Triode Summit" being held in the WAVAC suite in which Nobu Shishido, the famous Japanese audio designer was holding court. The crowd in the room numbered about 25 or so, but included Arthur Loesch, Ron Welborne, Scott Frankland, Frank Garbie, Joe Roberts and others. Nobu did a mini-bio on his background in audio and design approach to single-ended amplifiers. He also dis-



cussed his spectacular SE833A 100 watt Class amplifier. The group fielded questions about Japanese transformer designs, the use of transformer coupling and exotic circuit designs. The "Triode Summit" was, without a doubt, one of the high-lights of the show.

The equipment on display was indeed an international extravaganza. We stopped in and chatted with Dennis Had of Cary Audio, discussing the finer points of 300Bs and 845s. Dennis keeps coming up with even more varieties of tube amps each year to add to his already impressive stable. Then we met Kevin Hayes of VAC and checked out his beautiful gear including the new push-pull 300B amps.

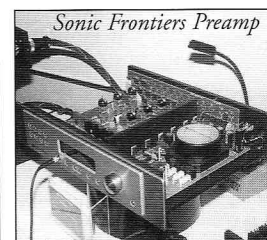

Some of the newer amps from foreign manufacturers featured KR Enterprise triodes including the VV30B and VV300B. AudioNote presented the new Ankoru parallel-single-ended 845 transmitting triode amplifier which used a single 300B as the driver tube. The Ankoru also featured dual 5R4WGT tube rectifiers!

Sonic Frontiers from Canada displayed an incredible amount of their tube gear, including remote control tube preamps,

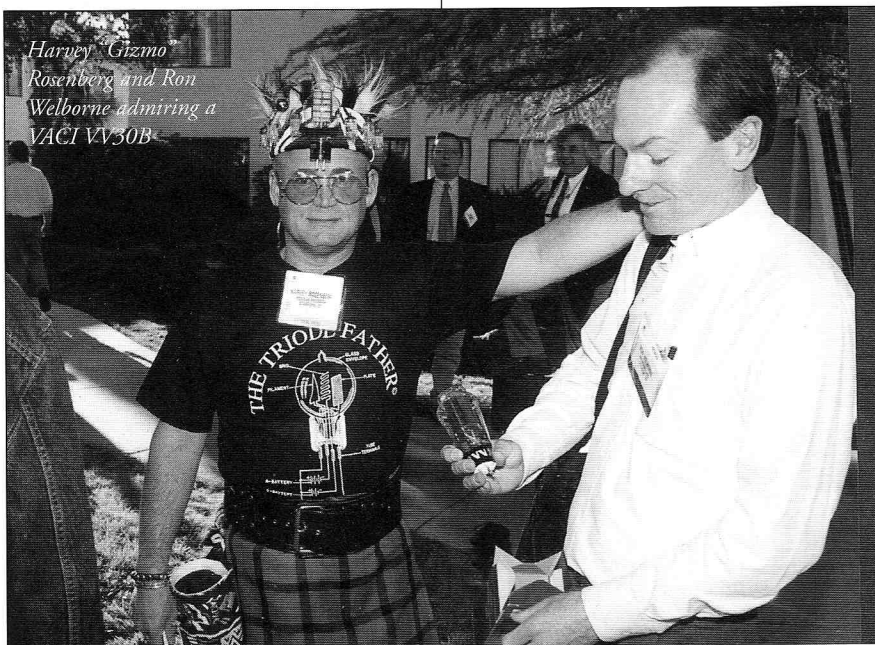

Harvey "Gizmo" Rosenberg and Ron Welborne admiring a VACI VV30B

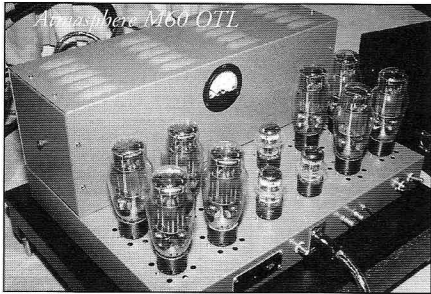

tube amplifiers and the Assemblage D/A converter. Their products were well designed and beautifully executed. Graaf of Italy displayed their delicious-looking gloss black and chrome GM100 and GM200 OTL stereo power amplifiers.



Cary SE 845 Amp

facturers displayed this year with an impressive array of amps, preamps and speakers. They also had a "tube city" display of all the Chinese audio tube types available including KT66, KT77 and KT100 types.



Acrylic Turntable

Consequently, a number of manufacturers who normally would not exhibit at the CES, were able to because of more affordable rates.

Steve Parr and I had the same complaint this year as last. Use larger speakers in your demo rooms! The use of high-priced shoebox size speakers with six or eight inch drivers just does not give the most dynamic and realistic sound. Hey guys, try using bigger speakers for maximum effect next time.

One of the surprises of the show was the 43 watt Minnesota Audio Labs MAL6550 push-pull 6550 amps driving Von Schweikert 4.0 speakers. This system sounded musical, balanced and just right to our tired ears. Probably the most impressive equipment from an engineering and quality standpoint was the WAVAC gear. I can't think of any tube freak who wouldn't drool over any of the WAVAC equipment.

Well, off we go to the May Stereophile show in San Francisco which we will cover in VTV #8.



Collection of Chinese audio tubes

One of the more innovative amps at the show was the MONS 300B single-ended triode tube amplifier using an EL34 as the load. The amp uses no output transformer, but has a coupler network for either single or bi-amping. The MONS amps were hooked up to the new Series 200 Edgahorns by Bruce Edgar.

The GM200 is a 200 watt per channel hunk using 16 PL504s per channel! Another Italian firm, Viva Audio Devices, displayed their new amplifier using four Svetlana SV572-10s. Two of the SV572s were push-pull output and the other two were used as rectifiers. The styling of the Viva amps and their speakers was, to say the least, unique. Chinese audio manu-

An added feature to the electronic festivities was "The Alternative High-End Audio Show" held at the Debbie Reynolds Hotel located near the Las Vegas. Convention Center. Lots of exhibits featuring smaller, but high quality amp, speaker, cable and related manufacturers. This venue was less expensive for exhibitors to display than the regular CES.



WAVAC SE833A

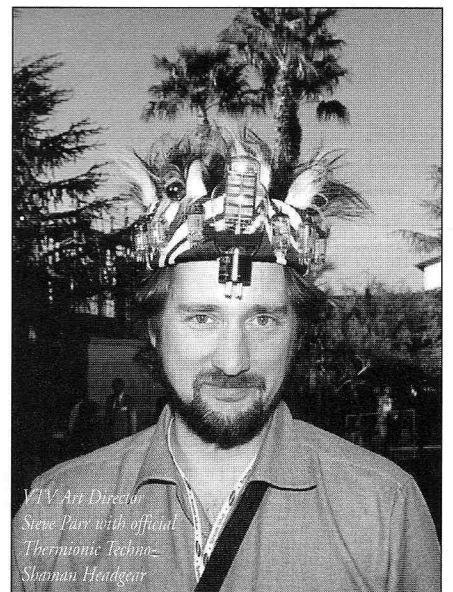

VTV Art Director Steve Parr with official Thermionic Techno-Shaman Headgear

UNCLE ERIC'S DUMPSTER

The 417A/5842

BY Eric Barbour © 1997

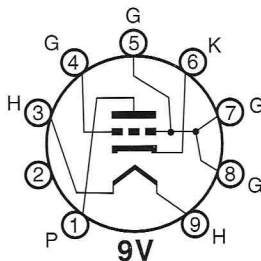

Reading this magazine makes you something of an elite, because you are aware of the advantages of thermionic vacuum tubes. Yet even today, some very smart people just don't get it. A recent example is the 2/97 issue of *Glass Audio*, page 32. Erno Borbely, a well-respected engineer and longtime contributor to *Audio Amateur*, is trying to ease his way into the tube-design game. Yet in this GA article, foot is inserted into mouth. Erno is doing a phono preamp, and starts off this feature with the blunt statement that it is "practically impossible" to obtain noise figures as low as semiconductors with tubes. He gives the EC86 as an example of a "lowest-noise" tube--and it's only middling-fair. Apparently, Erno never tried a WE 417A.

The 417A was introduced in 1948 by Western Electric. Intended as a low-noise first stage for broadband RF preamps, it eventually became something of a standard for receiver front ends. Often seen in 2-way equipment, it gave worldshaking performance in early 2-meter amateur radios. And much of the AT&T long-distance system of the 1950s was made possible by microwave multiplex equipment using 417As. It was relatively inexpensive to make, came in a standard 9-pin miniature bottle--and was QUIET.

A good way to approximate the inherent noise of a triode is by treating it as a resistor. All resistances have inherent wideband noise, which depends on the

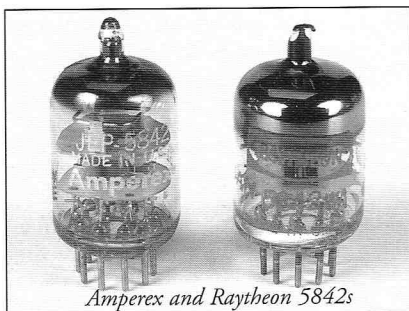
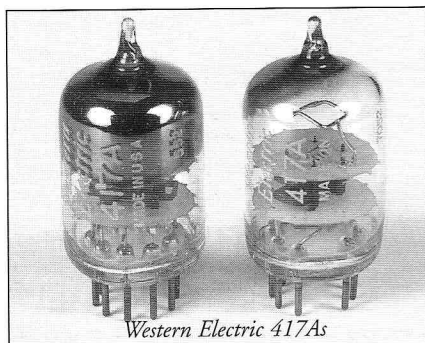

value of the resistance as well as the material or construction of the resistive material. Generally, more resistance means more thermal noise voltage, appearing across the resistor. This applies to triodes in a similar way--each one has an equivalent noise resistance, which appears to be connected from grid to cathode. The noise is then amplified and appears in the plate circuit.

Triode noise resistance is roughly equivalent to 2.5 divided by the transconductance of the triode. So, higher transconductance means lower noise. (There are other factors, such as ionization noise and leakage currents. These are usually very small in well-made triodes. Pentodes have another noise source, but are capable of performance similar to the best triodes. They will be considered in a future issue.)

The 417As transconductance is 24,000 micromhos. Thus, the noise resistance is 104 ohms. This is extraordinary for a 1948 vacuum tube--even the best current MOSFETS are only slightly better. And they tend to have other non-broadband noise sources, distinct from tubes. So, for preamp applications, the 417A is world-class in any year.

WE originated it, yet many other companies made it also, usually under the JEDEC designation 5842. GE, Sylvania, Amperex, Raytheon and CBS-Hytron all produced it (Sylvania until 1988). Old stock is very common. Usually found in receiver front ends, it was never used for

audio until the more extreme elements of the audiophile world discovered it in the 1990s.

Although its distortion is reasonably low, the 417A/5842 really shines in the first stage of phono or microphone preamps. It likes to run at substantial plate current, so by keeping the plate voltage to 100v or less, it can give the cleanest tonality possible along with its low noise floor.

Even with only 100v, a 417A gives a dynamic range more than an order of magnitude greater than an equivalent semiconductor. Low noise transistors tend to die when such voltages are applied. And a low plate resistance makes it possible to even use the 417A as a power tube--it can handle 24 mA current from its cathode, and has a plate resistance of 1800 ohms.

As with any high-gain RF tube used for audio, microphonics can be a problem. In low-level applications shock mounting may be needed.

A shame that nobody is using this tube in high-end preamps today. It's easy to find, yet manufacturers prefer to slap cheap, nasty Russian 6922s in expensive preamps instead. So beat the "gurus" of the world and try it. I guarantee state-of-the-art noise figures, with nary a transistor in sight.

SOUND PRACTICES MAGAZINE

featuring

Cool DIY Projects
History and Classics
Future Perspectives
International News
Wild Entertainment
Refuge for Audio Nerds
and much more!!

SUBSCRIPTION RATES

1 year (4 issues) \$20 US, \$24 Canada, \$30 Europe, \$35 elsewhere.

Sample \$5. MC/Visa accepted.
Money back if not delighted.

PO Box 180562 Austin TX 78718
512-339-6229 voice/fax
www.soundpractices.com

UPDATES AND RECTIFICATIONS

VTV #2 - The EL34 Report, Page 8, 1st column, The EL34 was actually introduced by Phillips in 1949, initially in England. It became available for use in America in 1953. 1st column, 2nd and 3rd paragraphs - Mullard EL34 Types 1 and II had welded plates. The Type III Mullards had crimped plates. Type I Mullard EL34s had no top getter ring, Type IIs had two small round getter rings and Type IIIs had versions using either two small getter rings or a single large top getter ring.

1927-34 Western Electric Large Theater Sound System, Page 24, 1st and 2nd paragraphs - The WE-203 dual 78 rpm player pictured in the article was actually used in an earlier era for in-theater scoring of silent films and for background music at intermission. Western Electric theater equipment used from 1927 starting with the showing of "The Jazz Singer" used a turntable mounted at the rear of the film projector driven in sync by the same motor that powered the projector. In this era, all the sound-on-disc records were 16 inch 33 1/3 rpm center start recordings that were labled with the start of the groove. These records were pressed with a very smooth shellac compound, ensuring a quiet playback. The records were only good for a certain number of playbacks, which were checked off on the record label at each showing.

Page 25, 1st paragraph - The light-valve optical soundtrack was actually demonstrated before the sound-on-disc system showed up in 1927. The light-valve system was actually developed earlier by both DeForest and Case-Sponable. The Fox Movietone optical sound-on-film system was concurrent with the Vitaphone sound-on-disc system, as developed by Western Electric. The very first sound newsreel was "Charles Lindberg's Flight," taking off on his transatlantic trip to Europe. This actually predates "The Jazz Singer's" release.

In 1929, theaters began to show films that used both types of sound films. Western Electric, Pacent and other produced equipment that could reproduce both types of product. Thanks to George McCluney.

VTV #3 - The Quest for the Ultimate - MI 200 McIntosh, Page 18, 2nd column, 2nd paragraph - Figure 1 was not included in this article. It was a hand-drawn schematic of Dave Wolze's modification.

Vintage Bookshelf Speakers, Page 30, 3rd column, 2nd paragraph - The AR-3 speaker was rated for a minimum of 25 watts continuous, not 35 watts minimum as stated.

VTV #6 - The Fisher 500, Page 6, 3rd column, 1st paragraph - Fisher 400 receivers with the Golden Syncrode front-end did not use Nuvistors as stated. They used a 6HA5 and a 6AB4 tubes.

6550 article, Page 23 - MPD ended production of 6550As in 1993.

VTV Back Issues and Subscription Order Form

Cash, US Bank Check, AMEX, MC or VISA Accepted

VTV 1 - Early tube amps, Dynaco History, Tube Testing, Audio Test Bench Set-up and 12AX7/ECC83 History and Tests **\$8 US-\$10 Foreign PPD**

VTV 2 - EL34/6CA7 History and Tests, Heathkit WM Series Tube Amps, Western Electric Theater Sound 1934, Best Guitar Amps , Tube Matching, Magnum SE Amp Project **\$10 US-\$13 Foreign PPD**

VTV 3 - WE 300B History and Tests, SE Transformer Tests, EICO Tube Hi Fi, EH Scott 48 tube radio, McIntosh MI 200 modification, Dynaco Stereo 70 Project **\$12 US-\$15 Foreign PPD**

VTV 4 - 6L6 History and Tests, HK Citation I and II, Classic Bookshelf Speakers, Designing for Sound, Tube Manuals from the Golden Era **\$12 US-\$15 Foreign PPD**

VTV 5 - Bendix Red Bank Tubes, FM Tuner Shoot-out, Vintage Hi If in Hong Kong, Guitar Amp Book Review, Audio Signal Generators, Uncle Eric's Deluxe SV8II SE Amp Project, The Birth of the Marantz 10B, Guitar Amp Rectification **\$12 US-\$15 Foreign PPD**

VTV 6 - The Story of the Fisher 500, A Tribute to Avery Fisher, The Randall Amplifier Project, Loftin-White Amplifier History, Power Kings 6550-KT88, Audio Test Bench - Oscilloscopes, Uncle Eric's Dumpster - The 5687 **\$12 US-\$15 Foreign PPD**

VTV Annual Subscription (Four issues) Rates (6/97)

\$32/yr US, \$40/yr Canada (Starts with current issue)
\$50/yr Europe and \$60/yr Asia and rest of Globe (Sent Airmail)

Send Name, address, City, State, Country and Mail code/Zip.

Enclose payment for number of years in either US check, cash, or credit card.
AMEX, Master Card and VISA Accepted.

Please print credit card number and expiration date legibly!

VACUUM TUBE VALLEY, 1095 EAST DUANE AVE, SUNNYVALE, CA 94086 USA - 408-733-6146 PH/FAX email: triode@aimnet.com

one electron™
Single-Ended Output Transformers
High Quality for a Reasonable Price
Designed and Built in the USA

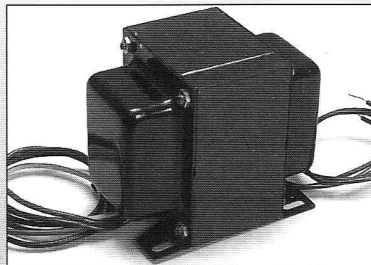

UBT-1 Designed for parallel operation of:
1.6k primary 15 watts 160 mA **\$90.25** 2A3s, EL34s, 300Bs 6AS7s, etc. or Sweep-tube in "enhanced triode" mode

UBT-2
4.8k primary 15 watts 110 mA **\$112.10** Can be used with: 300B, 50, SV811-3, etc.

UBT-3
3k primary 15 watts 110 mA **\$121.60** Good for single ended 2A3 or 300B

Quantity discounts available

ANTIQUE ELECTRONIC SUPPLY™ LIMITED PARTNERSHIP
6221 S. Maple Ave. • Tempe, AZ • 85283
Phone (602) 820-5411 • FAX (602) 820-4643 or 800 706-6789



VACUUM TUBE VALLEY
SUNNYVALE, CALIF. U.S.A.

Be the first in your neighborhood to have the official VTV "BIG TONE" T-shirt.

2 color heart print available in either **Blue Spruce** or **Desert Sand** colors. (Please Specify when ordering)

100% cotton shirt. Only extra large available.

Only \$14.50. plus \$3.00 postage US,

CA residents add \$1.12 Sales Tax

Canada and Mexico add \$7.00 postage

Europe and Asia add \$12.00 postage

Cash, Check or Money Order

Credit Cards OK

Vacuum Tube Valley
1095 E. Duane Ave., Suite 106
Sunnyvale, CA 94086 USA

Design In the "Real McCoy"

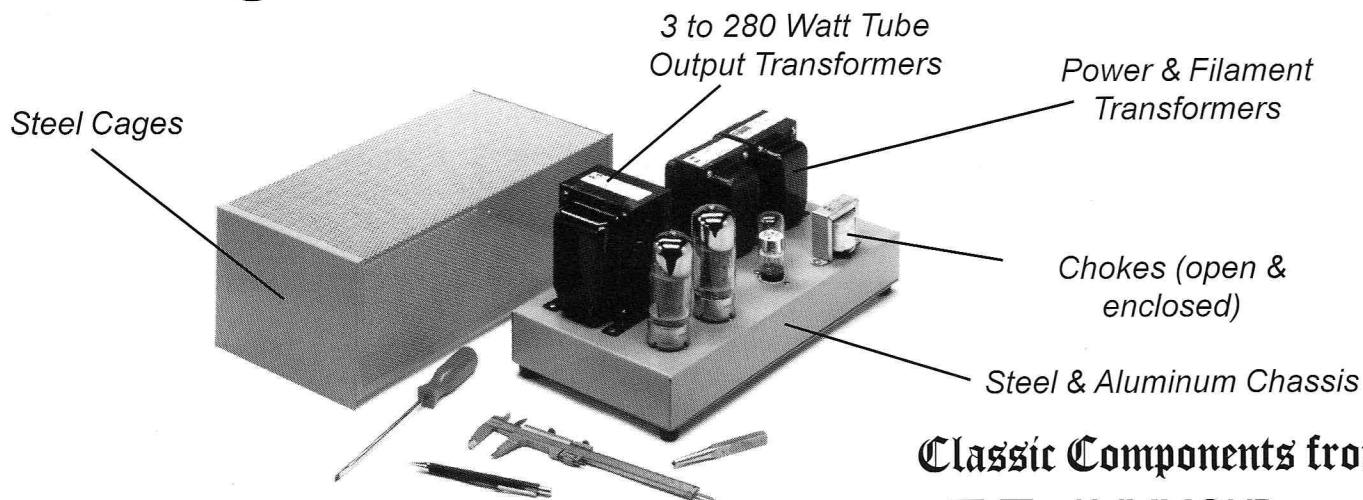

We've been in the transformer & enclosure business for over 70 years. In fact, most of the components shown here have been in continuous production since the 1950's! Trust your design with our experience...

Classic Components from:



4700 Genesee St., Cheektowaga, NY 14225 Phone (716) 631-5700 Fax (716) 631-1156
394 Edinburgh Rd. North, Guelph, Ontario N1H 1E5 (519) 822-2960 Fax (519) 822-0715

Tube Lore

A REFERENCE FOR USERS AND COLLECTORS

For serious users, a new look into tubes from 1920 to the present: history of design trends, "where used" information, tech data, equivalencies, "user's guide," even auction prices. See review by Eric Barbour in the Winter 1997 *VTV*. Contains 186 pages, 8-1/2" x 11" softbound. Orderable from:

- Antique Electronic Supply, (602) 820-5411
6221 S. Maple, Tempe, AZ 85283
- Antique Radio Classified, (508) 371-0512
PO Box 2, Carlisle, MA 01741
- Museum of Radio & Technology Bookstore
4204 Thorn Apple Ln., Charleston, WV 25313
- W7FG Vintage Manuals, (800) 807-6146
3300 Wayside Dr., Bartlesville, OK 74006

Or order directly from the author:

Ludwell Sibley
44-V E. Main St.
Flemington, NJ 08822

Price if ordered direct, postpaid: \$19.95 in US or Canada, \$24.95 ppd. elsewhere.

Discounts available to groups on orders on quantity purchases.



ELECTRA-PRINT AUDIO

QUALITY HANDWOUND S.E. OUTPUT TRANSFORMERS

- Primaries from 1.8K to 10K
- Exclusive wideband design
- 16, 8, 4, or 2 ohm secondary
- Gold plating

CUSTOM-BUILT POWER TRANSFORMERS/CHOKES

- Wound to your requirements
- Heavy-duty design for Class A use
- DC filament supply windings
- HV chokes to 15H, 300ma
- Low voltage, high current filament chokes

Component pricing and specifications catalog available

ELECTRA-PRINT AUDIO

4117 Roxanne Drive Las Vegas, NV 89108
702-396-4909 FAX 702-396-4910

It's Like Music to Your Ears...

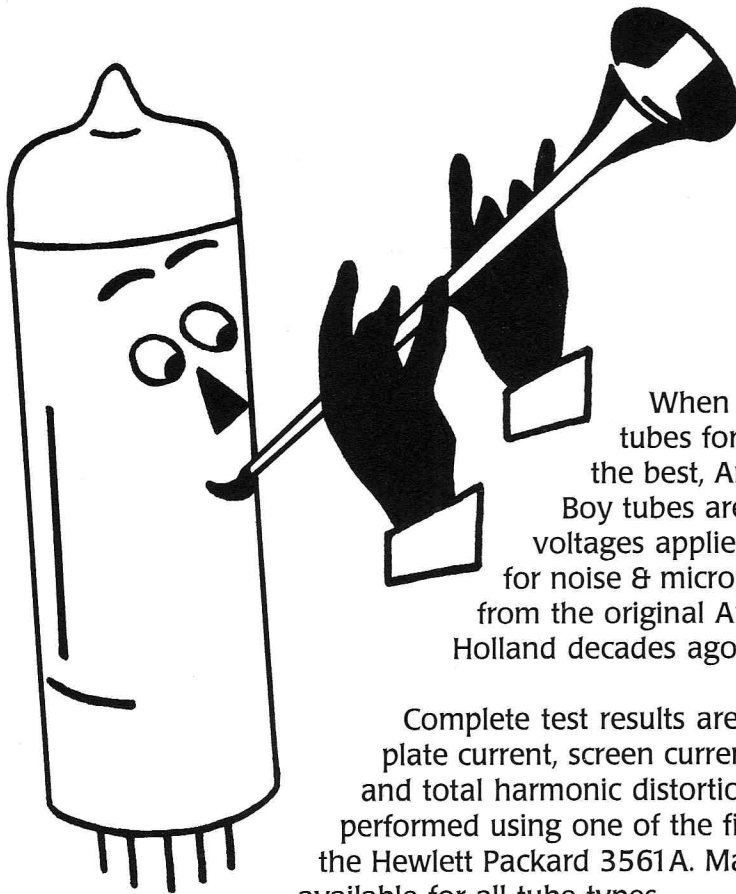

Amperex Bugle Boy audio tubes are back and they're better than ever!

When it comes to selecting premium audio tubes for your amplifier, accept no less than the best, Amperex Bugle Boy! Amperex Bugle Boy tubes are burned in under full load with all voltages applied for 24 hours before being tested for noise & microphonics. The aging racks used are from the original Amperex production line built in Holland decades ago.

Complete test results are supplied with each tube, including plate current, screen current, grid one current, filament current, and total harmonic distortion (THD). The THD measurement is performed using one of the finest spectrum analyzers available – the Hewlett Packard 3561A. Matching in pairs, quartets & octets is available for all tube types.

Special test requirements? Not a problem. For a slight additional charge we will test and match to your specified operating conditions.

Types available: 6DJ8/ECC88, 12AU7A/ECC82, 12AX7A/ECC83 and many more!

So if you haven't dealt with a source capable of meeting your demands, call us at **1-800-TUBE USA** or call **630-208-2200** today for information on additional products and the worldwide locations nearest to you. You'll like what you hear!

APD **Audio Product Division**

a division of Richardson Electronics, Ltd.

You can also visit our Classic Components site on the Internet at:

<http://www.tubes-r-us.com>

 **Richardson
Electronics, Ltd.**
ISO9002 Registered

40W267 Keslinger Road
P.O. Box 393
LaFox, IL 60147-0393
(630) 208-2200

Vacuum Tube Stereo Line-Preamplifier

Designed and Made in USA

- 7-50,000Hz within 1dB
- Low Noise & Distortion
- Contains no Feedback
- Accepts five Stereo Inputs
- Stereo Recorder Outputs
- Gold plated RCA
- 5 00VA Switched AC Outlets
- Designed & Made in USA
- Superb Quality and Sound
- Operates on 100/115/230VAC
- With or without Tone controls

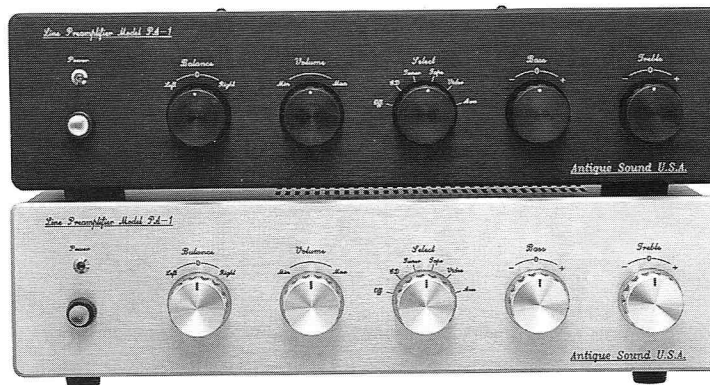

Technical Specifications

	<u>Model PA-1</u>	<u>Model PA-2</u>
Line Inputs (five)	CD, Tuner, Tape, Video, Aux	CD, Tuner, Tape, Video, Aux
Frequency Response	1dB from 15-25,000Hz	1dB from 7-50,000Hz
Voltage Gain	+6dB maximum	+6dB maximum
Volume Control Range	80dB continuously variable	80dB continuously variable
Tone Control	Bass and Treble variable	None
Tone Control Range	From +10dB boost to -15dB cut	Not applicable
Channel Separation	-43dB minimum at 1kHz	-50dB minimum at 1kHz
Hum and Noise	(-80dB) .2 millivolt maximum	(-80dB) .2 millivolt maximum
Input Impedance	250K Ohm all inputs	250K Ohm all inputs
Output Source	1K Ohm cathode follower	1K Ohm cathode follower
Tube Compliment	4 each 5814A low noise dual triode	4 ea 5814A low noise triode
Front Panel Controls	AC, Select., Vol., Bal., Bass, Treble	AC, Selector, Volume, Balance
Rear Panel Connectors	5 stereo inputs, P/A output, Recorder out, AC line, 2 ea Aux. AC out	5 stereo inputs, P/A out, Recorder out, AC line, 2 ea Aux. AC out
AC Power Required	100/115/230VAC 50/60Hz 12VA	100/115/230VAC 50/60Hz 12VA
Size W x D x H	15 x 7 x 3.5" (38 x 18 x 9 cm)	15 x 7 x 3.5" (38 x 18 x 9 cm)
Weight (net)	6 pounds (2.7 kg)	5.5 pounds (2.5 kg)
Enclosure	Aluminum black powder paint	Aluminum black powder paint
Front Panel (machined)	3 Choices: black, gold, natural	3 Choices: black, gold, natural
List Price (assembled)	\$995.00 (\$795.00 Kit)	\$899.00 (\$699.00 Kit)

“Our world-wide dealer network is now being formed, apply now!”

Antique Sound USA

6717 NE 181st Street, Seattle WA 98155 USA, Phone 206-481-8866, Fax 206-485-3836

TESLOVAKtm

VACUUM TUBES...from the Heart of Europe!

Introducing three totally new vacuum tubes from **TESLOVAKtm**: the KT88s, the E34Ls and the E83CCs. These new vacuum tube designs are the product of years of research, development, and hard work by our USA based engineering staff of Groove Tubes and Penta Labs in a joint venture with the staff of the newly reorganized Tesla factory recently relocated in the heart of Europe: the Slovak Republic.

These tubes are being handmade in limited quantities exclusively for Penta Labs and Groove Tubes in the classic European tradition. This legendary tube factory has manufactured many OEM tubes under the brand names such as; Telefunken, Siemens, Amprex, Mullard, and Brimar, to name a few.

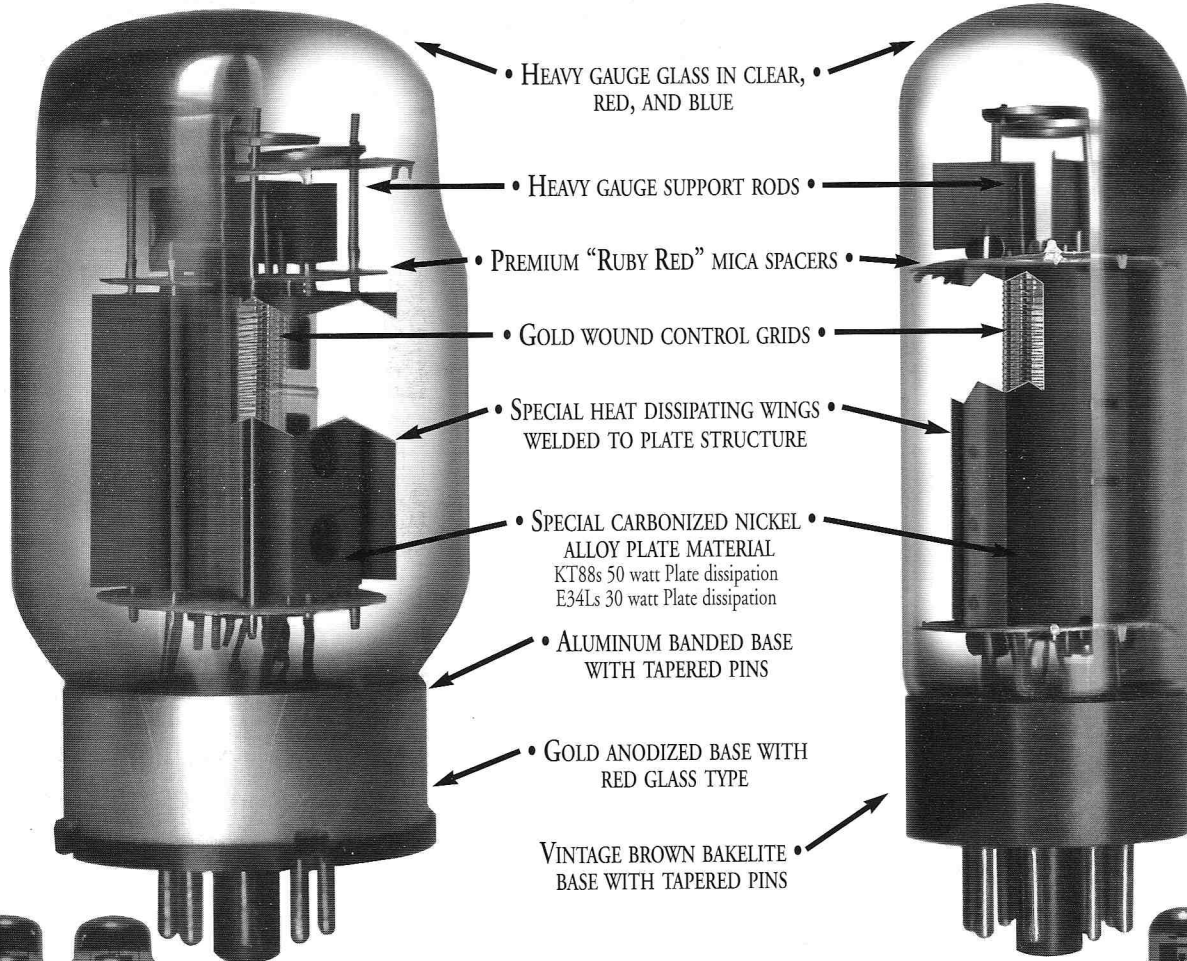

• HEAVY GAUGE GLASS IN CLEAR, RED, AND BLUE

• HEAVY GAUGE SUPPORT RODS

• PREMIUM "RUBY RED" MICA SPACERS

• GOLD WOUND CONTROL GRIDS

• SPECIAL HEAT DISSIPATING WINGS WELDED TO PLATE STRUCTURE

• SPECIAL CARBONIZED NICKEL ALLOY PLATE MATERIAL
KT88s 50 watt Plate dissipation
E34Ls 30 watt Plate dissipation

• ALUMINUM BANDED BASE WITH TAPERED PINS

• GOLD ANODIZED BASE WITH RED GLASS TYPE

VINTAGE BROWN BAKELITE BASE WITH TAPERED PINS

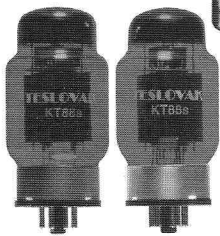

Our new **TESLOVAKtm KT88s**

The first legitimate European KT88 made in over 30 years. This new beam power tube has our unique and specially developed heat dispersion wings welded to the plate structure to help keep the tube's audio

performance stable at higher power handling levels. It also has gold wound grids for improved fidelity and lower noise. Additionally, our new KT88s is now available in blue and red glass.

Our new premium **TESLOVAKtm E83CCs** preamp tube with special frame grids, wound with gold wire, help to reduce microphonic interactions, lower noise, and improve both transient and frequency response.

Selected preamp tubes and matched power tubes available from:



Groove Tubes
12866 Foothill Blvd., Sylmar
California 91342 USA
Tel: (818) 361-4500 Fax: (818) 365-9884
e-mail: GrooveTube @ AOL.com



Our new **TESLOVAKtm E34Ls**

This totally new Pentode design upgrades and replaces all EL34 applications, producing more power and wider frequency response and dynamic range than any other EL34 past or present! This new tube also has special heat dispersion wings to improve the audio response at higher power levels and gold wound grids for improved fidelity. Available in blue and red glass.

Great attention is given to materials and assembly with over 30 hand welded contacts in this single dual triode! This great sounding new tube replaces the 12AX7/7025 in all applications.

(Tube pictured is the GT selected version, GT-ECC83)

Call for Design Engineering data sheets and OEM price schedule:

Penta Laboratories
21113 Superior Street, Chatsworth CA 91311 USA
Tel: (800) 421-4219 or (818)882-3872
Fax: (818) 882-3968
e-mail: PentaLab1@ AOL.com



KR ENTERPRISE VV VALVES

Power Triodes Without Output Limit

The KR Enterprise VV Valves are the first new directly heated triodes to be manufactured in over three decades. Hand built in the Czech Republic with their patented 32 cathode and ribbon filament structure, the VV300B valves will provide more power, lower distortion and better tonal fidelity than is available with any other 300B tube.

Enter the KR Enterprise VV300B contest. Win one of three pairs of KR Enterprise VV300B tubes valued at over \$600.00 to be given away on July 1, 1997. Send us your name, address and a photo of your 300B amplifier. No purchase necessary. For rules and regulations call or fax Welborne Labs or visit our website at: <http://www.welbornelabs.com>

If you can't wait until July 1st, contact us now for details on our guaranteed in home audition offer.

Welborne Labs P.O. Box 260198 Littleton, CO 80126 USA
Voice: 303.470.6585 Fax: 303.791.5783 E-Mail: wlabs@ix.netcom.com

OEM and dealer inquiries invited. The VV Valves are warranted for one year or 2000 hours.

Listen to the VV Valves today and experience a whole new horizon of musical pleasure.



This is the same amplifier built in the "Audio From Tubes" class taught by John Atwood at the Randall Museum in San Francisco. Available either completely assembled or as a partial kit for the serious constructor.

- Stereo, single-ended amplifier, with 13 watts (RMS) per channel
- 3 db of feedback balances dynamic sound and good speaker damping
- Power supply distribution isolated between channels, with choke filtering
- All tube design (no semiconductors anywhere)
- All point-to-point wiring (no PC boards)
- Wrinkle powder-coat finish in either dark gray or black (other finishes available by special order)

**Special Introductory
Price: \$1395 (assembled)
\$595 (partial kit)**

F.O.B. Sunnyvale, CA
Contact One Electron
for more details

one electron™

65 Washington Street, Suite 137
Santa Clara, California 95050 USA
FAX: 408 985-2006
<http://www.one-electron.com>

GO AHEAD

Ask top engineers and music lovers worldwide what capacitor they choose for their ultimate designs.

— H O V L A N D —

MUSICAP®

"After auditioning a wide variety of caps, I find these film-and-foil capacitors to be the most musical performers—and by a large margin. The MusiCap specializes in textural liquidity (lack of grain) and delicacy of treble nuances." **Dick Olsner**, Reviewer and Designer;
November 1996 Samadhi Acoustics white paper

COMPARE NOW

The most naturally revealing capacitor. Film and foil polypropylene construction. Optimized for fine speakers and vacuum tube electronics. Silver-plated leads. Precision made in the USA. Values from .01 to 10µF.

To audition MusiCaps for yourself, call these quality distributors:

- Welborne Labs, USA 303-470-6585
 - The Parts Connection, Canada 800-769-0747
 - Michael Percy Audio Products, USA 415-669-7181
 - Madisound Speaker Components, USA 608-831-3433
 - Just Speakers, USA 916-373-6777
 - Handmade Electronics, USA 610-432-5732
 - American Audio Import, Netherlands 31-78-6510567
 - Anchor Cross Co., Tokyo, Japan 81-3-3203-5606
 - Bina Putra Datamas, Indonesia 62-21-8209126
 - Octave Electronics, West Malaysia 603-793-793-9
 - SJS Electroacoustics, England 44-1706-823025
 - Tang Hill International Ltd., Taiwan 886-2-5813605
- OEMs and international distributors may contact
HOVLAND COMPANY at 209-966-4377 Fax 209-966-4632

Svetlana Audio Tubes

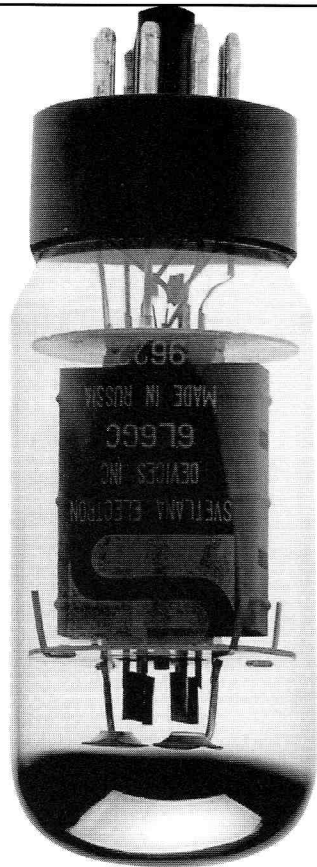

◀ *"...Svetlana's (SV)6L6GC showed up...and were easily the best-sounding new 6L6s we've heard..."*

*Power Tube Taste Test
Guitar Player Magazine
November, 1996*



▲ *"The Svetlana (SV)6550C beat the pants off my treasured Tung-Sol coke bottles, bass was tighter and more defined. The Tung-Sols had a little too much bass, they were too chesty and tubby by comparison"*
Dan Schmalte
Publisher, Valve Magazine

"To our ears, the best sounding EL34 of the group was Svetlana's Gold Top EL34."

*Power Tube Taste Test
Guitar Player Magazine
November, 1996*

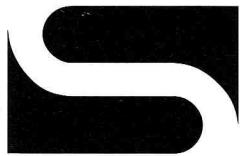

Svetlana
ELECTRON DEVICES

Visit our web site or call for a distributor near you!

Headquarters: 8200 S. Memorial Parkway • Huntsville, AL 35802 • phone (205) 882-1344 • fax (205) 880-8077
Marketing & Engineering: 3000 Alpine Road • Portola Valley, CA 94028 • phone (415) 233-0429 • fax (415) 233-0439

www.svetlana.com

WE HAVE ENOUGH COMPONENTS TO BUILD A SMALL CITY

TUBES:

Over 3500 audio, receiving, transmitting and industrial types in stock, including many foreign and early types. We offer the complete line of Svetlana audio, amateur radio and industrial power tubes.

TRANSFORMERS:

Hard to find power, filament and output transformers as well as filter chokes for tube equipment. We feature HAMMOND, One Electron, MagneTek and Thordarson as well as many new old stock transformers.

CAPACITORS:

High voltage electrolytic and mylar capacitors, multi-section capacitors and more for tube circuits.

PARTS:

Resistors, tube sockets, potentiometers chassis boxes and aluminum enclosures, knobs, dial belt, lamps, diodes, speakers, wire, phonograph needles and cartridges and much more.

LITERATURE:

Extensive selection of literature and books and tubes, hi-fi equipment, circuits diagrams, communication gear and antique radios. Some items not available elsewhere!

SUPPLIES:

Grill cloth, cabinet restoration supplies, batteries, chemicals, tools, test meters, gifts and kits.



HAMMOND
MANUFACTURING™



one electron™

CALL OR FAX FOR OUR FREE 40 PAGE CATALOG

ANTIQUE ELECTRONIC SUPPLY™

Limited Partnership

6221 S. MAPLE AVE. • TEMPE, AZ 85283 USA
(602) 820-5411 • FAX (602) 820-4643