

VACUUM TUBE VALLEY™

Issue 8
Fall/Winter 1997

The Classic Electronics Reference Journal

Published Quarterly
Price \$8.00

EL84 - The Baby With Bite

300B Evaluation

A Music Lover's Triode



Sweep Tube OTL Project

200 Watt EL509 Amp

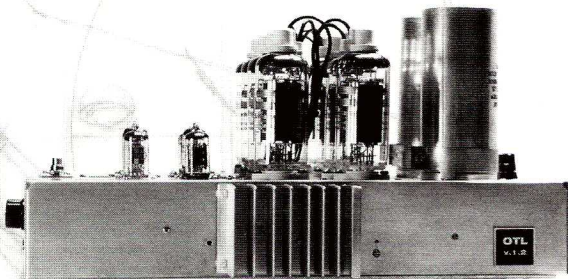

RCA Tube Manufacturing

46 Years of Innovation



Cunningham
Radiotron

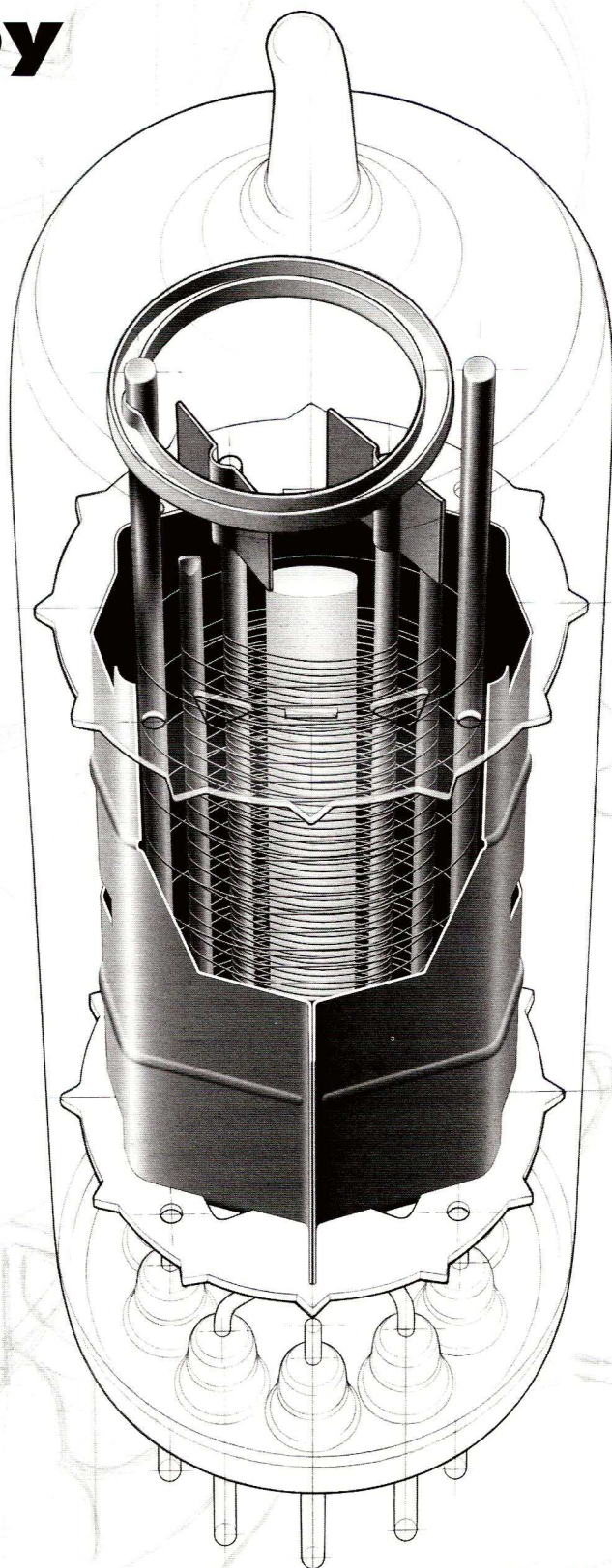

Illustration by Kent Leech

**VTV Issue # 8
Table of Contents:**

EL84: The Baby with Bite..... 3
Listening to the EL84.....8
Sweep Tube OTL Amp..... 10
RCA Tube Manufacturing....15
Radiotron Handbook..... 18
Radiotron CD-ROM.....19
Inside ENIAC.....20
300B Evaluation..... 22
AudioNote Kit One..... 24
Tube Dumpster - 12SX7..... 25
Bruce Moore Interview.....26
Distortion Analyzers..... 30
VTV Visits AES in Tempe.....32
Advertiser Section.....34

Update: Tubes on the Internet

Although the internet is useful and a source for lots of information, audio surfers on the WWW need a reality check. Popular news groups such as **rec.audio.tubes** are becoming "*rec.tubes.wanted.and.for.sale.*" Recently, we checked this newsgroup and noted that over 50% of the postings were for tubes wanted and for sale. In addition, there are several aggressive "instant experts" who are giving out misleading information. Some of these fellows do not even use their real names! These web mongers seem to have lots of time on their hands to give spurious

advice to unsuspecting beginners. We would advise these "experts" to do some more research before spreading misinformation.

This situation is even worse on **rec.audio.tech**, **rec.audio.high-end** and **alt.guitar.amps**. And the World Wide Web with its seemingly millions of commercial websites has become the ultimate last resort for charlatans and rip-off-artists. There are no controls, regulations or second opinions. At least with newsgroups, anyone spouting crap will be called on it by others. If you plan on buying anything off the web, be extremely cautious!



Japanese Tube Group Visits VTV

On June 12-14, MJ, the premier Japanese audio magazine, sponsored a tour for 14 tube enthusiasts from Japan. The group along with the editors of MJ visited the VTV office, several collectors, equipment dealers, surplus stores and the Foothill Electronics Fleamarket in Los Altos, CA. Members of the group found lots of tube-related goodies, made new friends and had fun.

Make Your Fisher Beautiful!

You can now replace those troublesome brass Fisher knob caps! Al Pugliese, The Fisher Doctor, has excellent quality reproduction machined and lacquered knob caps in either plain or with indicator line for \$3.50 each. He

also has sets of replacement indicator light jewels for \$4.25/set of five.

The Fisher Doctor
 27 Daleham Street
 Staten Island, NY 10308
 (718) 948-7489

Counterfeit NOS Tube Boxes

Steve Martin of Antique Electronic Supply notified us of an individual in Hong Kong who is producing fake NOS-type tube boxes. The company in question is producing boxes with: Amperex, RCA, Tung-Sol, Telefunken and Mullard brands. The boxes were in the miniature nine-pin size and have no tube numbers printed on the box flap. Watch what you are buying out there!

Vacuum Tube Enthusiast Weekend and VTV Tube School

On November 8 and 9, 1997 a special Tube Enthusiasts Weekend will be held in Tempe, Arizona. The events on the 8th will include two free electronics swap meets and open houses at Antique Electronics Supply and Arizona Tube Audio. Vacuum Tube Valley will present Tube School for Audio and Guitar Amplifiers (two separate classes) on the 9th with John Atwood, Charlie Kittleson, Evan Aurand and Ritchie Fliegler as instructors. Cost for the eight hour event is \$99 prepaid and \$129 at the door.

Contact Vacuum Tube Valley for a flyer on the event: FAX (650)654-2065, website: www.vacuumtube.com

Technical Questions

VTV appreciates all the interest in our journal and vacuum tube electronics, however, we are unable to answer all the telephone inquiries regarding technical questions. Please send your questions via our website email: **triode@vacuumtube.com**. You can also FAX or send questions via US mail.

EDITORIAL STAFF

- Charles Kittleson** - Editor and Publisher
- John Atwood** - Technical Editor
- Eric Barbour** - Staff Editor
- Terry Buddingh** - Guitar Editor
- Steve Parr** - Art Director
- Julie P. Werner** - Copy Editor
- Website** - www.vacuumtube.com

Vacuum Tube Valley is published quarterly for electronic enthusiasts interested in the colorful past, present and future of vacuum tube electronics.

Subscription US\$32.00/year (4 issues)
 \$43/Canada and \$63/Asia, \$53/Europe

Cash, US Bank Check, or Credit Cards are accepted for payment

Phone - (408) 733 - 6146
FAX - (650) 654 - 2065

Copyright 1997 **Vacuum Tube Valley™** and **Big Tone™** All rights reserved.

No part of this publication may be reprinted or otherwise reproduced without written permission of the publisher.

Send circulation and editorial correspondence to:

Vacuum Tube Valley
 1095 E. Duane Ave., Suite 106
 Sunnyvale, CA 94086 USA
 e-mail **triode@vacuumtube.com**
ISSN # 1095-4805

EL84: The Baby With Bite

By Eric Barbour

© 1997 All Rights Reserved

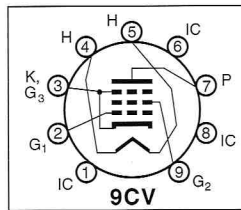

Intro

It is getting routine to speak of popular audio tubes as having little or no history. Whereas truly innovative tubes such as the 6L6 started an electronic revolution, there are many types which hardly rated mention—until recently, when they became essential to musical sound. The development of such popular tubes was more-or-less accidental, or at least of little importance at the time.

A fine example is our present subject. The small power pentode EL84 is now regarded as a leading guitar tube, and as a classic for high fidelity. Yet it was developed from an undistinguished series of audio-output pentodes, used in low-power hi-fi, tape recorders and many AC powered European radios. One small change in the screen grid, to allow its operation at voltages similar to the plate (300 volts), made a low-cost radio tube into a high-fidelity audio device.

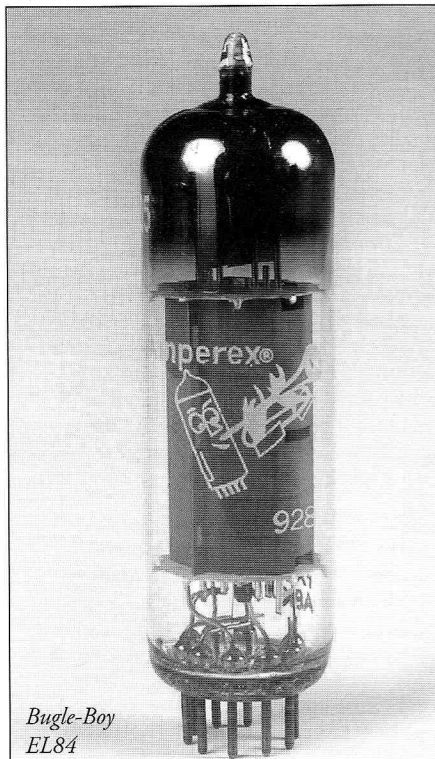

Bugle-Boy
EL84

Like many audio tubes of today, EL84 originated with Philips BV in Eindhoven. This highly productive R&D operation could fill up a book with just their better-known electron tube developments. All from the minds and hands of nameless engineers in Holland. This popular 9-pin miniature tube was derived from the very different Rimlock base tube found in most countries where Philips had a presence.

History

Just after World War II, much of northern Europe was in ruins. Populations were utterly weary of war, and now that it was over, they got on with their lives. And they started buying radios again. As a result, more new electronic tubes were introduced in the 1946-1950 period than in any other time.

The tube manufacturers were well-acquainted with the new glass-base miniature tubes from the USA, first introduced by RCA in 1939-1941, and it was obvious that the future was in miniature types. So, starting in 1947 with the British MOV Z77 pentode, a rush of types appeared. Known as B7Gs in Britain, they were usually identical to American types already existing.

Except, that is, for a new line. Produced by Mullard and Mazda, later by Philips (Mullard's owner) and Telefunken, the Rimlock series of tubes were essentially like 9-pin miniatures, except that their bases had 8 pins. And early examples were equipped with a large metal ring on the base, with an alignment pin to allow use in twist-and-lock sockets. The appearance was like a small Loktal base, minus the center locating bung. A major introduction in the Rimlock types was the Mullard/Philips UL41, one of the first audio output pentodes with a miniature base and the precursor of an entire family.

The UL41 was intended for 100-mA series heater strings in AC-DC radios and televisions. It led directly to the EL41, identical except for the more conventional 6.3v heater. The EL41 begat the EL81,

for

17 WATTS PUSH-PULL POWER at 300V. B+

with a pair of
MINIATURE tubes



the
**Amperex®
EL84/6BQ5**

LOW-DISTORTION,
HIGH-GAIN POWER PENTODE

- True pentode characteristics for low distortion and high peak power.
- High gain and sensitivity resulting in reduced driver stage distortion.
- 12 watts plate dissipation in a miniature envelope.
- At 300 volts, capable of 17 watts at 4% distortion (without feedback) in Class AB push-pull pairs.
- 5.7 watts output at 10% harmonic distortion (without feedback) as a single-ended output stage.

OTHER **Amperex TUBES** FOR
HIGH-FIDELITY AUDIO APPLICATIONS:

- | | |
|--------------------|---------------------------------------|
| 6CA7/EL34 | High-power pentode; 100 W PP |
| EF86/6267 | Low-noise high- μ pentode |
| ECC81/12AT7 | Low-noise medium- μ dual triode |
| ECC82/12AU7 | Low-noise low- μ dual triode |
| ECC83/12AX7 | Low-noise high- μ dual triode |
| ECC85/6AQ8 | High- μ dual triode for FM tuners |
| 6Z34/5AR4 | Cathode-type rectifier; 250 ma. |
| EZ80/6V4 | 9-pin rectifier; cathode; 90 ma. |
| EZ81/6CA4 | 9-pin rectifier; cathode; 150 ma. |

At All Leading Electronic
Parts Distributors

**Amperex
ELECTRONIC CORP.**
230 Duffy Ave., Hicksville, Long Island, N.Y.



EL84: THE BABY WITH BITE

1950s, Early 1960s, Late 1960s and 1970s Amperex EL84s

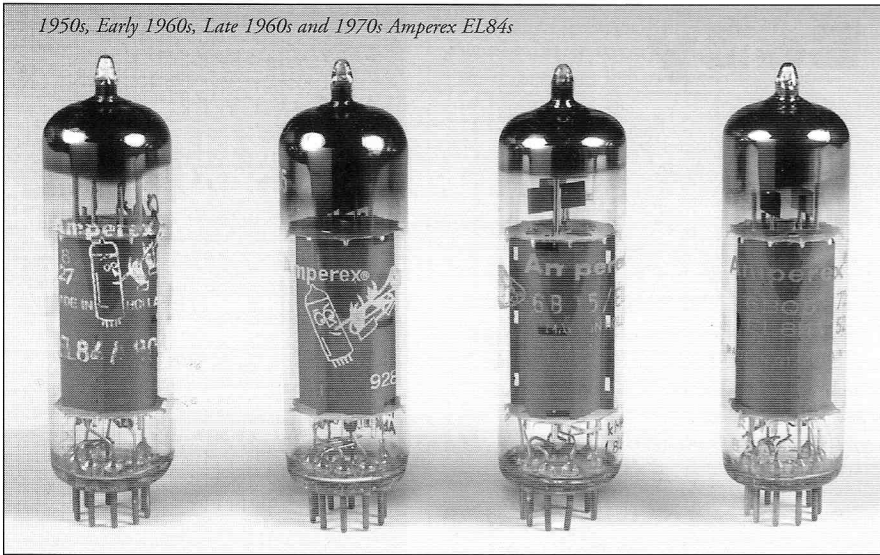

1970s and 1960s Mullard EL84s, Svetlana SV83

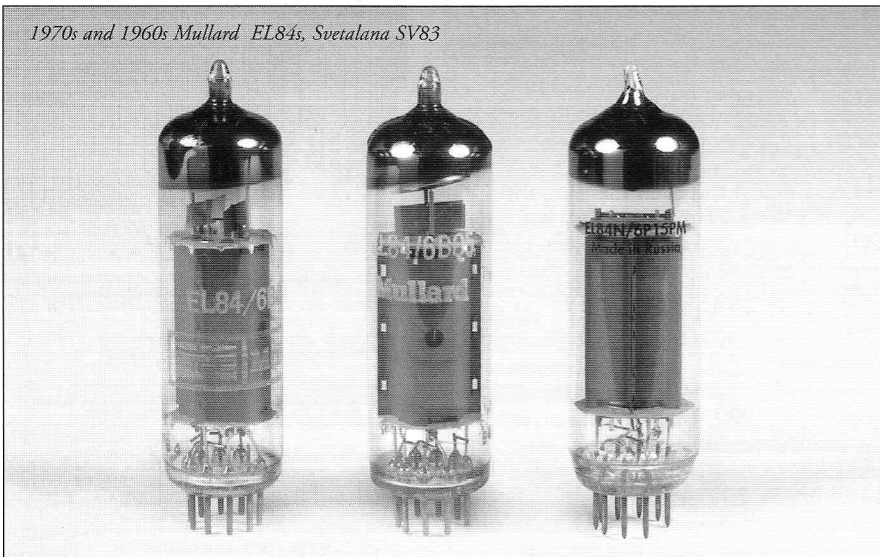

1959 H H Scott Model 299A Integrated Amplifier

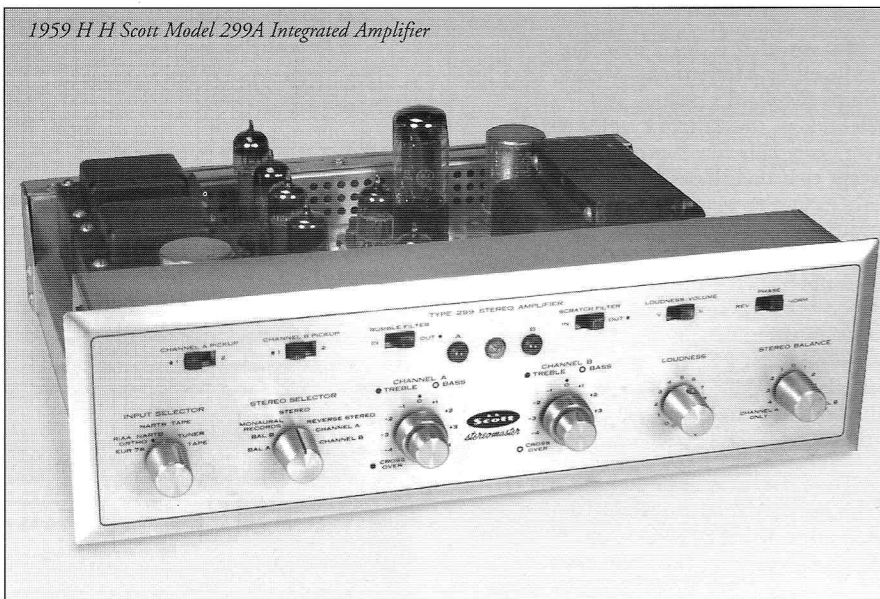

which bore a newfangled 9-pin miniature base in the American style. The EL81 was a very different tube, intended for early TV horizontal-sweep applications and possessing a plate cap and much lower transconductance than the UL/EL41.

From the EL81 came the EL82, designed especially for audio output. From the EL82 came the EL83, similar except for an internal shield and intended for video amplification. And from the EL82 came the demand, circa 1952, that output tubes should have screen-grid ratings allowing their use in triode or in the Hafler-Keroes ultralinear connection. All these tubes up to this point were rated for screen operation at 250v maximum. It seems that Philips had already produced a pentode with a screen voltage rating equal to the plate rating, the obscure developmental type BA9 of 1950. Now that there was a demand for its use in the burgeoning hi-fi market, Philips made it into an official type: EL84. (There was one "final" entry, the EL86, which was very similar to the EL82 except for a higher plate dissipation rating, and thus was not suitable for ultralinear connection due to its low screen grid voltage rating.)

The EL84, believed to first appear in Philips data books in 1953, was the start of an industry--small, inexpensive hi-fi amplifiers for the average person. Mazda introduced their 6P12 equivalent to the EL84 in 1955. Previous American 10-watt amps usually used the prewar 6V6 beam tube, which was relatively low in transconductance and required additional driver stages. The EL84 seized this market from the 6V6 and its kin within a scant two years. Not only were EL84s smaller than 6V6s and required less-expensive miniature sockets, they had much higher transconductance. A push-pull pair of EL84s could be driven with a very simple circuit, using a high-gain pentode for voltage gain, followed by a triode as a split-load phase inverter. The standard EL84 driver circuit quickly became a 7199 or other triode-pentode, pushing a pair of EL84s into an 8000-ohm-primary transformer, biased with a common 130-ohm cathode resistor. Officially, this combination gave 11 watts into a speaker.

Early UK application of the type EL84 were early circuits/kits including the GEC 912 (1954) and the Mullard 5-10 which was used by many early radio/hi-fi businesses, including Radford. Leak used the EL84 in push-pull for their Leak TL12+ in the mid-fifties. The first production US hi-fi amplifier believed to use the EL84 was the Fisher CA-40 of

EL84: THE BABY WITH BITE

RCA, GE, Sylvania and ECG/Philips 6BQ5s

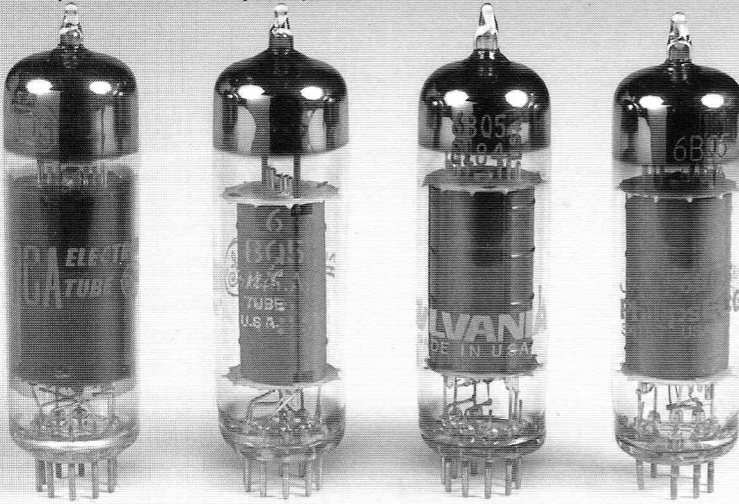

Tungsvam, Telefunken and Yugoslavian EL84s

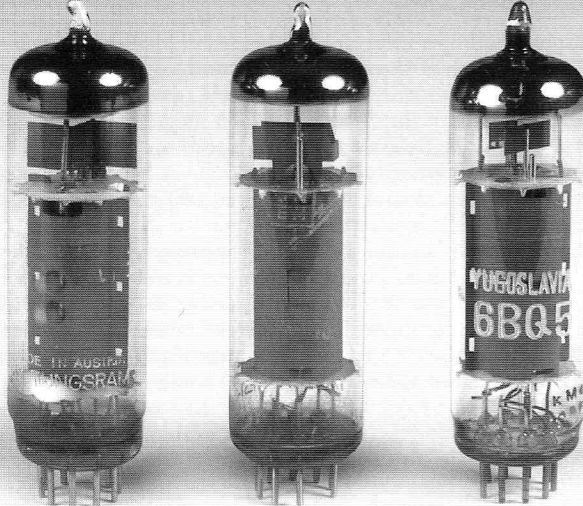

Sovtek EL84, Sovtek EL84M, Matsushita EL84

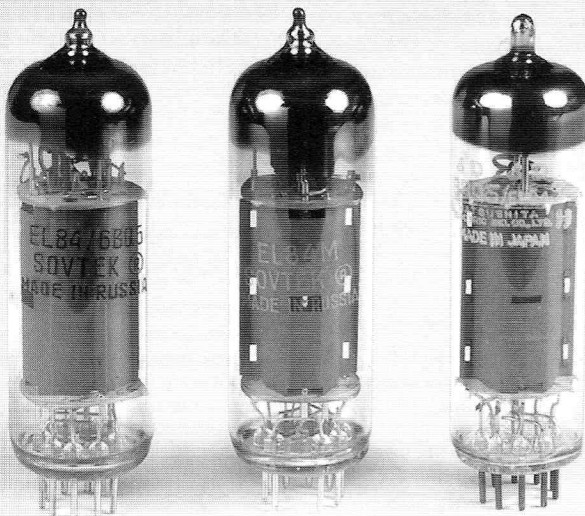

1955. It used four tubes to give (optimistically) 40 watts. At the time, the CA-40 caused a stir. Here was a small monophonic integrated amplifier, designed to look good, designed to be easy to use (its unique tone controls displayed the frequency response with a small illuminated graph--the green line, made of flexible plastic, was distorted into the actual response when the bass and treble knobs were operated). Suddenly, hi-fi wasn't just an obscure hobby for the technically sophisticated.

The number of high-fidelity amplifiers using EL84s, introduced between 1955 and 1965, is considerable. They include giant sellers like the Dynaco ST-35 and SCA-35, the EICO HF81, the Fisher SA-100 and X-202A, the Scott 222 series and 299A and 299B, and a vast array of models by Bogen, Eico, Fisher, Heathkit, Pilot, Sherwood, Lafayette and too many others to count. Most were mono or stereo integrated amplifiers, rated for anything from 8 to 25 watts per channel, always from a pair of EL84s. Since the American hi-fi market was driving this design, Sylvania introduced American-manufactured EL84s in 1956 under the standard name 6BQ5. All large U.S. tube factories either produced 6BQ5s, or imported and relabeled European-made EL84s. Most of their other UL41-series tubes (with 9-pin bases) were also offered in America under standard EIA designators, yet none approached the popularity of the EL84/6BQ5.

The power-rating uncertainty above shows how vague the audio business was getting in the late 1950s. Amplifier designers wanted ever-more power and dissipation from the same low-cost tubes, which resulted in some unreliable designs. It also resulted in semi-chaos in the EL84 market. Since designers (and therefore, supposedly, consumers) wanted and needed more power, RCA and GE introduced the 7189 in 1958. Although the original 6BQ5 was supposed to be a true pentode, with suppressor grid, the 7189 was a beam tetrode. It was intended to be an exact plug-in replacement for the 6BQ5/EL84, except having higher ratings for dissipation and plate voltage. This was followed by the 7189A of 1960, with a plate voltage rating of 440 volts. Some later amps, such as the Scott 299B, were designed for such voltages. Although a good-quality EL84 pentode might work in a 299B, it really requires a beam-type 7189. During this period came the premium version E84L, apparently intended for "mobile" applications (perhaps in two-way radios) and offered in America under the obscure number 7320.

Since beam tubes suffer from less screen-grid heating than true pentodes, some smart-aleck tube factories made and sold beam tubes labeled 6BQ5 or EL84. Often you will see old-stock EL84s which are really beam types. It is difficult to tell which are which, since many EL84s don't have holes in the sides of their plates, to allow inspection of the tube structure. GE's popular 1973 tube manual refers to the 6BQ5 as a "beam power amplifier" and to the 7189/A as a "beam pentode," further muddying the waters. All this, plus the perennially-popular sport of re-labeling, make determination of the identity and capabilities of an NOS EL84 type more difficult.

Table 1

Escalation of miniature output pentode/beam tube ratings in the UL41 family:

| Type | Plate Diss. | V _{plate} | V _{screen} | g _m |
|---------|-------------|--------------------|---------------------|----------------|
| UL/EL41 | 9 watts | 250V | 250V | 10,000 uS |
| EL81 | 8 watts | 300V | 250V | 4600 uS |
| EL82 | 9 watts | 300V | 250V | 9000 uS |
| EL83 | 9 watts | 300V | 250V | 10,000 uS |
| EL84 | 12 watts | 300V | 300V | 11,300 uS |
| EL86 | 14 watts | 275V | 220V | 10,000 uS |
| 7189 | 12 watts | 400V | 300V | 11,300 uS |
| 7189A | 13.2 watts | 440V | 400V | 11,300 uS |

Today's scene is much simpler. Although there is a Shuguang EL84, it has a very poor reputation for reliability. The major producers of EL84s are the Reflector Saratov factory in Russia (usually sold under the Sovtek brand), Teslovak in Slovakia, and Ei in Serbia. Also, an EL84-like tube is sold by Svetlana. Their "new" SV83 is a unique Russian type roughly similar to the EL82 or EL83.

The applications for EL84s have also simplified. High-end audio amplifiers using EL84s are not common now. The only high-end EL84 amp currently available from a US manufacturer is the Mesa Engineering "Tigris." Admittedly, EL84s have been overshadowed in hi-fi by larger tubes. It is because of the distinctive distortion behavior that the vast majority of EL84 amps made today are guitar amps.

Guitar Amplifier Applications

First use of the EL84 started in the late 1950s with Vox. Created by Jennings Musical Instrument Co. to manufacture and market musical-instrument amplifiers, Vox made mostly smaller amps for the amateur and low end of the professional trade. Their AC4 used one EL84 in single-end Class A, the AC15 had two in the typical 130-ohm cathode-resistor circuit, and the AC30 ran four tubes in

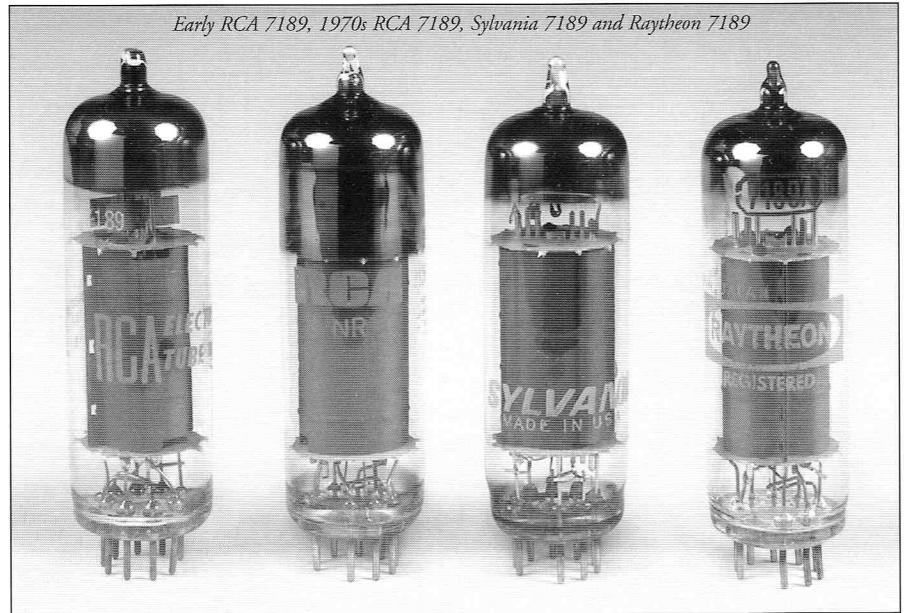

close to Class A push-pull operation. It was the "Top Boost" version of the AC30 which became a standard, primarily because it was the amplifier of the Beatles (as well as most other British Invasion groups). Although Selmer, Hohner and other European firms produced similar amps, the Top Boost AC30 enjoyed the blinding star power of John Lennon, Paul McCartney and George Harrison. And furthermore, the Top Boost was apparently the first guitar amp to incorporate extra gain stages, allowing the amp to distort easily. The Vox name, idle for many years, was recently revived by Korg USA and Marshall. So the AC30 and AC15 are available once again in music stores.

Not that they were really missed--the Top Boost was one of the most copied amplifiers of all time. In the pre-1970 era, EL84s were usually used in inexpensive "student" amps, bearing brand names such as Silvertone, Harmony and Kay. The only other American guitar amps with EL84s from this period were a single unusual Fender model and the Gibson Skylark.

Yet long after this period, starting in the 1970s, custom amp makers such as Trainwreck Circuits (Colonia, NJ) made a name by producing EL84 amps that were capable of the distinctive Vox sound. This is usually described as very distorted and bluesy, changing tonal characteristics over a wide range with changes in picking force--a "British blues" sound.

Since 1985, numerous firms have made a big dent with AC30 or AC15-like amps. The biggest is currently Matchless Amplifiers (Santa Fe Springs, CA), fol-

lowed by smaller outfits like Bruno, Hound Dog, Budda and others. Even big factories are getting into it: Mesa-Boogie, which made their name with big 6L6GC "hot rod" amps, now has EL84 amps like the Subway Blues combo and the 20-20 Stereo rack-mount unit. Crate, better known for their low-cost solid-state amps for beginners, now sells the E112 combo amp with two EL84s in the classic circuit, with an all-tube preamp section. Hiwatt, recently revived by Japanese guitar manufacturer Fernandes, has a small EL84 combo amp. The unique distortion of the EL84 has become a major paradigm of rock guitar sound.

Tests

As usual, we subjected a wide array of EL84 types to both electrical and listening tests. In this case, because the EL84 is now nominally a guitar tube, we place extra emphasis on the guitar-amp tone tests. Even so, past VTV tests have shown unexpected correspondences between guitar tones produced by certain tubes, and their measured distortion. Peak power was checked but proved to be very similar for all the tubes listed below.

Table 2 - DISTORTION OF EL84s AT ONE WATT RMS

Tests were done at 300v plate, 300v screen, 50 mA idle current, into a 3200-ohm load, using the same test amp and distortion analyzer as in previous VTV tests. All tested tubes bore EL84 or 6BQ5 markings except as noted. Used tubes were verified for transconductance on a tube tester beforehand.

PHILIPS EL 84

OUTPOT PENTODE
PENTODES DE SORTIE
INDEPENTODE

Heating: indirect by A.C. or D.C.; parallel supply
 Chauffage: indirect par C.A. ou C.C.; alimentation en parallèle
 Heizung: indirekt durch Wechsel- oder Gleichstrom; Parallelspeisung

$V_f = 6.3 \text{ A}$
 $I_f = 0.76 \text{ A}$

Dimensions in mm
 Dimensions en mm
 Abmessungen in mm

Base, culot, Sockel: NOVAL

Capacitances
 Capacités
 Kapazitäten

$C_{g1} = 10.8 \text{ pF}$
 $C_{g2} = 6.5 \text{ pF}$
 $C_{g3} < 0.5 \text{ pF}$
 $C_{g4} < 0.25 \text{ pF}$

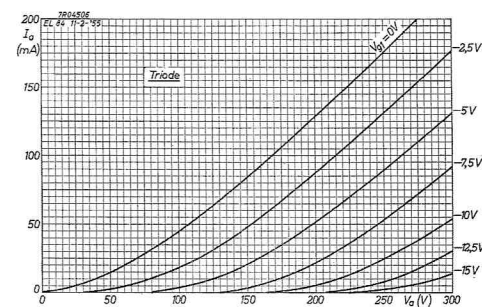
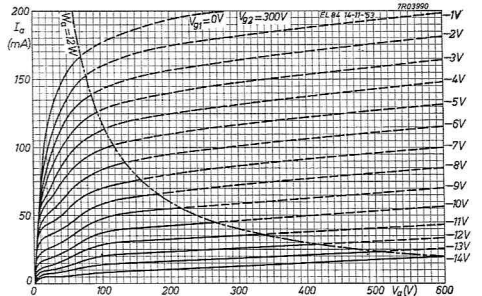
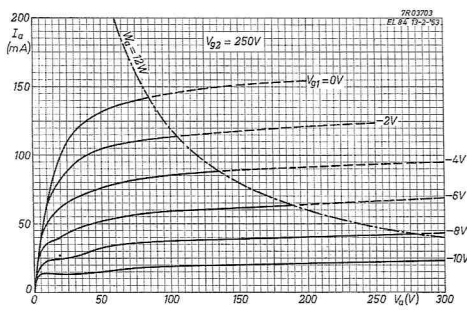

Original Philips EL84 data sheet and curves

| Type | Dist. | Samples |
|----------------------------|------------|---------|
| Tungram Hungary 1970s |052 % | 2 used |
| RCA 7189 1960 |0.60 | 2used |
| Raytheon "Uniline" 1970s |0.60 | 2 used |
| Amperex Globe 1973 |0.65 | 2 used |
| Ei current production |0.65 | 2 NIB |
| Telefunken 1960s |0.65 | 2 used |
| Amperex Bugle Boy 1968 |0.70 | 2 used |
| Sovtek current production |0.72 | 7 NIB |
| Sylvania 1980s JAN |0.73 | 2 used |
| Amperex Bugle Boy early |0.75 | 2 used |
| Sovtek/Reflector early '90 |0.75 | 2 NIB |
| Mullard 1960s |0.76 | 2 NIB |
| Philips/Syl 7189 1970s |0.77 | 2 used |
| Raytheon 7189 1960 |0.79 | 1 used |
| Matsushita 1970s |0.86 | 2 used |
| Philips/Syl 7189A 1980s |0.86 | 1 used |
| Tung-Sol 1960s |0.87 | 2 NIB |
| GE 6BQ5 1970s |0.92 | 2 NIB |
| Sovtek EL84M current |0.92 | 1 NIB |
| RCA 7189A 1970s |0.95 | 1 NIB |

Note: NIB = "New In Box"

The Raytheons above were physically identical to the Amperex globe EL84s, so it's safe to assume they were made by Philips and rebranded. We already had discovered that the low-cost Sovtek EL84 is a good sounding tube, making it a best buy (and better-sounding than the premium EL84M).

Compare these figures to the listening tests in the sidebar, and draw your own conclusions. Since many, many EL84s have been made all over the world in the

last 40 years, it was impossible to get samples of them all. We have tried to concentrate on versions that are often seen in today's marketplace. Of course, that doesn't count tubes (or, should I say, the tube) that is similar to the classic EL84 yet not compatible with it.

Since the Svetlana 6BM8 is not really close to the EL84 in its basic ratings, we left it out of this test. However, Svetlana recently introduced a new tube, the SV83, which might be called a brother of the EL84. The SV83's pinout is similar to the EL84, except for a built-in shield. (The tube was intended for video amplifiers, like the old EL83; it could not be called an EL83 because the pinout is unique). The SV83 can NOT be used in most EL84 amps! The screen grid of the SV83 is rated 200v maximum. As we verified, plug this tube into a typical EL84 guitar amp with 350+v on both screen and plate, and its plate current will run away. We used the same equipment as before to test sample SV83s versus Sovtek EL84s, with one change: regulated 150v was attached to the screen grid, rather than 300v.

Table 3 - SV83 vs. EL84

Test parameters as in Table 2, except regulated +150v on screen grid.

| Type | Dist. | Samples |
|---------------|-------------|---------|
| SV83 Svetlana |0.69 % | 4 NIB |
| EL84 Sovtek |0.72 | 4 NIB |

The SV83 is NOT USABLE IN

MOST GUITAR OR HI-FI AMPS. Do not attempt to use it unless you are certain that the screen voltage is 200v or less. One interesting discovery was that the SV83 was much more sensitive than any of the EL84s tested. So, if properly operated, it has great potential for new applications in guitar or hi-fi amplifiers.

Exit

Accident has determined the basis of tube sound at the end of the 20th century, although some engineering went into the equation. More worthy tubes, such as big TV sweep tetrodes, have been elbowed into history by tiny, inexpensive things like the EL84. Its continued manufacture in several locations, and its continued popularity as a music maker, will take it into the next century.

Bibliography

1. **Illustrated History of Philips Radio Valves to 1935**, Fin Stewart, 1983.
2. **70 Years of Radio Tubes and Valves**, John Stokes (Vestal Press, Vestal, NY, third edition, 1992), p. 140-141.
3. **MiniWatt Pocketbook**, Electron Tube Division, Philips Gloeilampenfabriken BV, Eindhoven, Netherlands, 1957.
4. **Tube Lore**, Ludwell Sibley, Flemington NJ, 1997.

A special thanks to British tube collector Phil Taylor for his assistance.

EL84 Listening Evaluations

Guitar and Hi-Fi Amplifiers

By Charlie Kittleson and Terry Buddingh

© 1997 All rights Reserved

Guitar Amplifier Performance

The 6BQ5 tube is a sweet, but full sounding tube used in many modern and vintage combo guitar amplifiers in the ten to 50 watt power range. This tube breaks up into distortion easily with musical "sing" and good sustain. It is also smaller than most other power tubes, less expensive and readily available.

In order to get an idea of what various types of EL84s sounded like, we scheduled a listening session to try all the types of this tube we had at our disposal. The test amp was a 1970 Marshall PA20 with push-pull EL84s. The amp was modified to the Lead 20 circuit. The plate voltage on this amp is about 370 volts. The speaker was a Buzz Feiten with two-twelve inch Celestion GreenBack reissues. Preamp tubes in the amp were original Mullard 12AX7s. Guitars used included a 1983 Fender Telecaster Standard (US) and a 1957 reissue Fender Stratocaster (made in 1988) with Van Zandt pickups.

Sovtek/Groove Tubes EL84 (1990):

A current-production Russian tube made by Reflector. It had high gain with a nice chime. It also exhibited deep bass and sounded heavily compressed when driven hard. It had thick midrange with a woofy bottom. A very British Marshall sound.

Sovtek EL84 (1990s):

A Russian tube with good chime, not as much bass as old stock, with a less refined but aggressive rock sound.

Sovtek EL84 (different variant) (1990s):

This tube is the same as above but has a different cup getter. The sound is slightly fuller, but otherwise similar to the one listed above.

Svetlana SV83 (1990s):

This tube has a lower screen grid rating than the EL84 version. The SV83 arced and was non-functional in the amp.

Telefunken EL84 (1960s):

Very "Euro" sounding, distorted, sags easily. It sounds like a sick Bugle Boy.

Tung-Sol 6BQ5 (1960s):

This is actually an Amperex/Philips type branded Tung Sol. It sounds just like an old Bugle Boy, with that big Marshall sound.

Tungram EL84 (1970s):

A very mean, harsh, growling and vicious sounding bottle. Harmonically rich with a nice hard-rock sound.

GE 6BQ5 (1980s):

The GE had a balanced presentation. It had thick body and was meaty sounding. It appeared to be more responsive (sensitive) than some of the others.

Sylvania JAN 6BQ5 (1980s):

A tube with very thick sound. Lots of bottom, but more distorted sounding than some of the others. Otherwise, very similar to the GE listed above.

Matsushita 6BQ5 (1970s):

This tube was made in Japan and was 1970s vintage. When put in the amp, it didn't work and actually arced (flashed) internally.

Amperex Bugle Boy EL84 (1960s):

A fine vintage tube with the thickest body and with considerably more gain than the others. It had very little chime and gave a very big and dense tone.

Amperex 6BQ5 (1973):

Thinner sounding than the 1960s version. It didn't have as much body, but was similar sounding, balanced and musical.

Ei Yugoslavia EL84 (1980s):

This is a tight, very chimey tube but not as good as the Bugle Boy. Overall, not bad.

Philips 7189 (1980s):

This type is not as sensitive or loud as the Amperexes. It is not as musical or complex-sounding.

RCA 6BQ5 (1960s):

A very chimey sound, similar to JAN-Sylvania. A loud, but less detailed sound when compared to the Amperexes.

RCA 7189 (1960s):

This tube is the higher voltage rated version of the 6BQ5. It has somewhat lower gain, but is cleaner and sweeter than some of the other tubes. It also has less edge, less compression and is less complex. This would make a good vintage hi-fi tube.

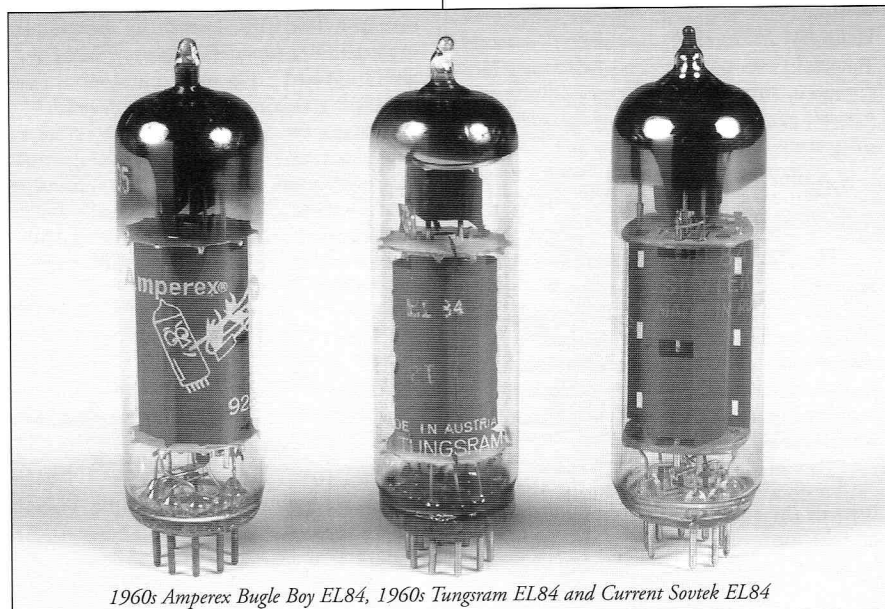

1960s Amperex Bugle Boy EL84, 1960s Tungram EL84 and Current Sovtek EL84

Mullard EL84 (1960s):

A thin sound with some distortion and mush in the mids. The sound sags easily with no heavy bass.

Raytheon - Uniline 6BQ5 (1960s):

This tube is actually a rebranded Amperex with a good detailed sound. Very balanced, no mush and very strong sounding.

The Winners Are:

For best overall sound in a guitar amp, the 1960s Amperex Bugle Boys were a clear favorite. They had a thick body, with a complex-full sound. They sounded bigger than they really were, almost like the larger EL34 types. Be sure the Bugle Boys you buy have the white Bugle Boy logo in the green and yellow boxes. The tubes have the date codes stamped on them in white ink. Expect to pay up to \$40-50 each for NOS versions of this tube.

The runner-up was the East European Tungstram from the 1970s. It gave a more aggressive hard-rock sound and somewhat more growling, mean presentation than Amperexes. This make may be more difficult to find as it was not widely distributed in the US.

The best buy is the Sovtek EL84. An aggressive tube with thick midrange and a very British (Marshall) sound. Although thinner sounding than the original Bugle Boys, it still had good headroom and chime. A perfect "trash rock" tube.

Hi-Fi Amplifier Performance

For our EL84 test amplifier, we decided to use a rebuilt Dynaco ST35 basic, using push-pull EL84s driven by a single 7247 per channel. The output transformer on the ST35 is the famous Dynaco Ultralinear Z-565 (8K), which has an incredibly wide bandwidth.

Some of the tubes used in this test had lower screen grid ratings than others, so we used a separate, regulated screen supply to vary the screen supply voltage. This supply was used on all of the tests for uniformity in performance. Except where noted, screen voltage was set at 250 volts.

Remember, your amp, tubes and speakers may sound different from our results, so keep an open mind.

Test Results

The tubes used in the test were either NOS or good used, and were run in matched pairs for best performance. The results are as follows:

Amperex

EL84 Bugle Boy (1960s) - A very musical tube with a warm, punchy sound. Good bass and lots of air. A very nice tube to listen to.

EL84 Orange Globe Logo (1973) - The sound is very similar to the Bugle Boy except the highs were a slight bit harder sounding.

General Electric

6BQ5/EL84 (1979) - When compared to the Euro EL84s, this tube had a lumpy, woolly bass with brassy 2-dimensional highs. The midrange was mediocre and not very detailed sounding.

EI/Yugoslavia

EL84 (1989) - A detailed, but edgy sound, with irritating highs. It was also lacking in bass and the mids were nothing special.

Matsushita

EL84 (1970s) - This Japanese EL84 had decent bass, warm mids, but was not as extended on the highs. Its not as punchy sounding as the Amperexes and is kind of flat sounding.

Mullard

EL84 (1960s) - A classic tube with good bass, warm mids and sweet highs. It also had lots of air and detail, almost 3-dimensional sounding. Overall, the Mullard EL84 is a great tube!!

Philips

JAN 6BQ5 (1986) - Obtained from recent US military disposal, this tube is currently available from many tube suppliers. It had a nice, clean sound, but the mids were slightly mushy. Overall, this is a warm sounding and musical type.

JAN 7189 (1970s) - This one has lots of bass, but lacks midrange depth. It is not very balanced sounding and has a two-dimensional sound.

RCA

6BQ5 (1960s) - A tube with good bass, glassy highs and an almost 3-dimensional sound. This tube has that good old American sound.

7189 (1960s) - A tube with shouting,

in your face, rock and roll sound. It's big and thick with not a lot of detail. It would be great for heavy metal rock.

SOVTEK

EL84 (1990s) - A detailed sounding, but edgy tube with irritating, solid-state type highs. The bass and the mids are not very prominent. An OK substitute when you can't find Amperexes or Mullards.

Svetlana

SV83 (1990s) - This tube has a lower screen rating than the others in this test do. For best performance in the Dyna ST35, we set the screen voltage at 200 volts. We found the SV83 very sensitive and detailed, a very musical little tube at a bargain price. Note: Do not use the SV83 in Ultralinear type amplifiers, including the Dyna ST35 and SCA-35, ACRO 20-20 and all Heathkit EL84 amps.

Tungstram

EL84 (1960s) - A somewhat scarce tube in the US, it was actually a great performer. This EL84 had lots of air and was very 3-dimensional sounding. It also had lots of punch and great tonal balance. The Tungstram EL84 was very enjoyable and musically involving.

Telefunken

EL84 (1960s) - This tube was a detailed, but thinner sounding than the Amperexes. Otherwise, it was very similar sounding. Overall, this is a very fine tube.

The Winners Are:

For the best performance in a hi fi amplifier, the Amperex Bugle Boys from the 1950s and 1960s are hard to beat. They are still available, but can be costly, due to their relative rarity. Matched pairs of Bugle Boy EL84s can cost up to \$100 or more. The Bugle Boy EL84s are very musical and have a great deal of air. This is just what you want for a smaller amp.

The runner-ups are a tie between the Mullard and Tungstram EL84s. Both tubes are dynamic and musical sounding, but are even rarer than the Bugle Boys. Single Mullards can cost \$50 and up.

The best buy EL84s for hi fi are the Philips/JAN 6BQ5s due to their current availability, clean sound and warm midrange. Most of the tube dealers have this tube in their inventory for prices ranging from \$8 to \$15 each.

Sweep Tube OTL Monoblock Amplifier

By Alan Kimmel

© 1997 All Rights Reserved

We know that tube amplifiers with transformer coupled outputs can sound great, typically better than solid-state amplifiers that need no output transformer. It is also possible to make tube amps with no output transformer, as the name OTL (Output Transformer-Less) indicates. These can sound great too. For some of you who have inefficient speaker systems (including electrostats) that you just can't part with, this is a project you can warm up to.

The earliest commercial OTL amplifier was made by the Stephens Manufacturing Company. Their OTL used 2A3 output tubes. The main drawback of that OTL was that it required a special speaker of 500 ohms impedance. Although that OTL was a commendable early step, it cannot compare with OTLs that can drive 8 ohm loads. This was the real breakthrough in OTL development.

Vacuum tubes were never intended to drive such a low impedance directly; theoretically it should not be possible or practical. But a good OTL can do so nonetheless, and do it well. It is these two characteristics of OTLs that distinguish them from all other amplifiers and make them seem almost magic:

- 1) Their superb sound potential
- 2) No problems associated with output transformers.

The next and most famous OTLs were produced by the brilliant Julius Futterman. He manufactured several different models. His OTLs work fine with standard 8 ohm loads. Later, companies like New York Audio Labs and Fourier Components manufactured derivatives of Futterman OTLs. There will probably always be companies that will carry the Futterman torch.

Currently the most well known OTLs are the Atma-Sphere OTLs. These are the first commercially produced OTLs to utilize the Wiggins "Circlotron" output topology. An important advantage of the

Circlotron is that it allows the output stage to be fully balanced-- both halves of the output stage are identical. This allows direct coupling to the speaker with no DC flowing through the speaker.

Design Decisions

First I had to determine which is the best and most efficient output tube for the task. Julius Futterman's work led me to feel that sweep tubes would be ideal outputs. At the time the sweep tube of choice was type 6LF6. Also at that time the most available triode candidate was type 6AS7/6080. It was no contest-- the 6AS7 could not compete with the power and efficiency of the mighty 6LF6. I suppose I could have gotten comparable results with enough 6AS7s but I didn't want to use a "zillion" output tubes. (Plus, the 6LF6 requires only 2A of heater current vs 2.5A for the 6AS7.) Sweep tubes have low voltage screen grids; 150V is adequate for the screens of most sweep tubes. Julius Futterman obtained the greatest efficiency from the 6LF6 when its screen voltage was raised to approach the maximum screen voltage rating of that tube (which is about 270V).

When I built this OTL several years ago, 6LF6 tubes were available. That tube works great in this OTL but now it is too expensive and scarce; so I converted the OTL to use type 6KG6 output tubes

instead. This type is very similar to type 6LF6, the main difference being that the 6KG6 has a large 9 pin "MAGNOVAL" base rather than 12 pin. The 6KG6 is currently manufactured by two companies-- Svetlana and EI. I am using Svetlana's EL509/6KG6, priced at \$33 each. (In Russia, Svetlana's 6KG6 is known as type 6P45S.) EI's 6KG6 is distributed by New Sensor as type EL519/6KG6. I haven't yet tried EI's 6KG6 in this OTL but my previous experience with their 6KG6 suggests that it, too, is an excellent performer. The Svetlana EL509's heater draws 2.5 amps while the other versions draw 2.0 amps.

My next task was to find the best circuit topology. As always, I wanted something innovative-- why duplicate existing designs? I wanted this OTL to have excellent efficiency and performance; balanced output; ability to accept balanced or unbalanced inputs; and above all, uncompromising fidelity. I wanted an amp that would reach out and grab me with you-are-there realism; this OTL does that.

It was clear that the output stage would have to be some kind of cathode follower (CF) circuit to have the best chance of directly driving a typical loudspeaker impedance such as 8 ohms. Julius Futterman's OTL output stage topology is the "totem-pole" type, but I chose an output stage named after Mr. A.M. Wiggins called the "Wiggins Circlotron" because it met all my preferences for the output stage. [See "New Amplifier has Bridge-Circuit Output" by D.J. Tomcik and A.M. Wiggins, *AUDIO*, November 1954, p.17] However, all the well known OTL output stage topologies can be made to sound great and perform well.

At first I was going to operate the output tubes in standard pentode mode by supplying the screens with a DC supply that follows the cathodes. But this might

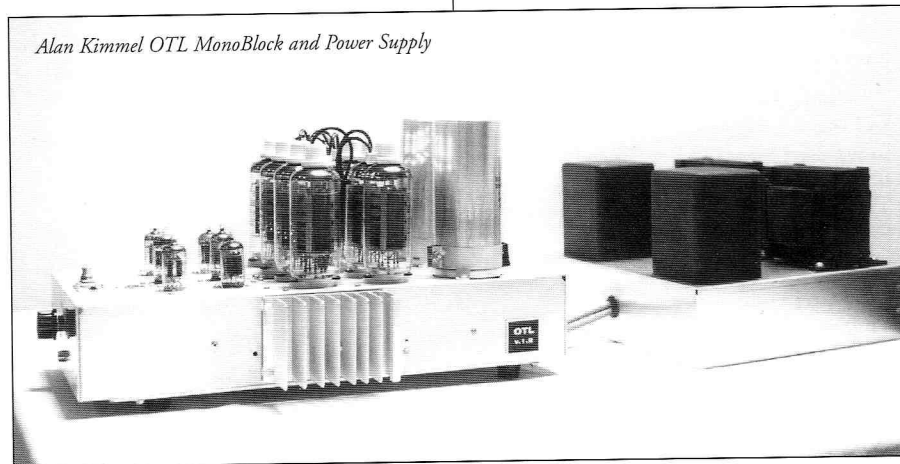

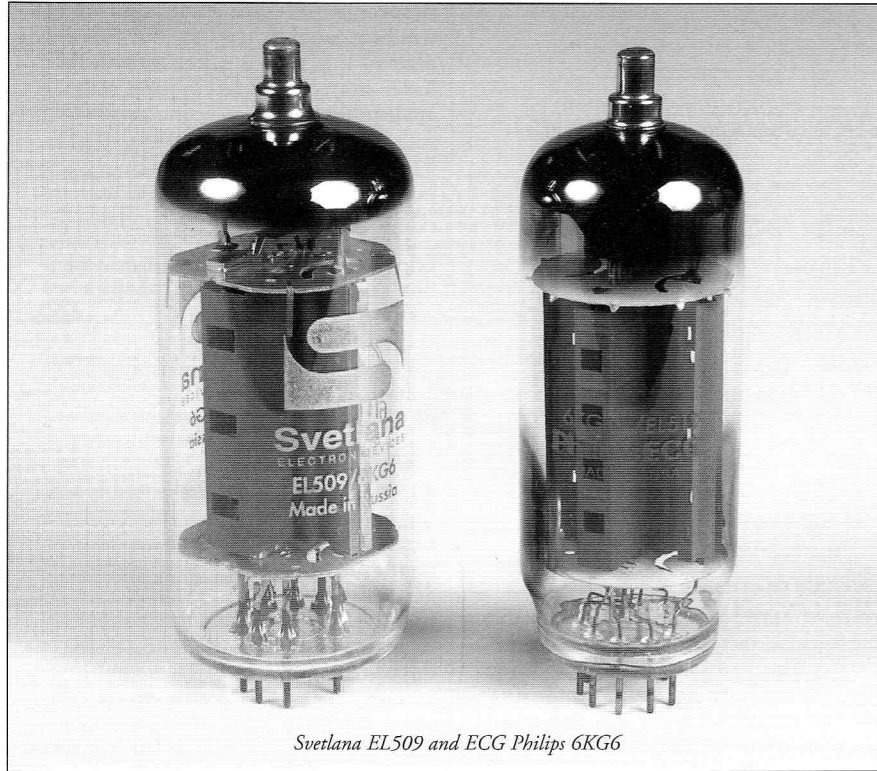

Svetlana EL509 and ECG Philips 6KG6

have required a somewhat higher DC screen voltage to get good efficiency. Instead, I chose to operate the output tubes in a more efficient manner: the pass device for the screen grid supply is modulated with the same drive signal as the control grids of the output tubes. This boosts efficiency further, transforming the output tubes into Super CFs. You can call it the "Augmented Mode" if you want. The Augmented Mode provides very good efficiency with a relatively low 225V on the screens. So I chose pentode CFs which, by the way, is what the original Wiggins Circlotron amplifier used in its output stage. Thus I ended up with a balanced Wiggins Circlotron output stage using sweep tube CFs operating in this "Augmented" mode.

That, plus the fact that the output tubes are idled at about 1/3 their total plate dissipation rating, means that they are operated conservatively, and efficiently. Tube life can be extended further by switching the function switch (S-1) to "MUTE." Besides muting the signal, this switch also increases the negative bias voltage to the output tube control grids, reducing the cathode current to a fraction of the operating current. Therefore "MUTE" is actually "MUTE / STANDBY."

The next task was to get the best front end and driver circuits. I wanted it to be

able to accept balanced or unbalanced inputs. The best input stage would therefore be a Mu Stage that can accept both types of inputs. Almost any dual triode that can handle several mA will work for V1. I recommend type 6SN7 (my prototype has a 12AU7 for V1). Though not required, it would be good to operate V1's filament with regulated DC. For the pentode cathode-follower atop V1 I chose type 6U8, a triode-pentode (V2). V2's triode is the phase inverter for the push-pull stages. I wanted a phase inverter

whose AC balance never changes because this OTL is somewhat sensitive to its internal AC balance. If the internal AC balance is off, it creates a slight DC output offset. When this problem occurred with other phase inverters I tried, this effect was apparently inaudible but it did push a little extra wasted DC current through the output stage and speaker. The solution was to use the split-load cathodyne (a.k.a. "Concertina") phase inverter. (Incidentally, this was Julius Futterman's favorite phase inverter.) Its AC balance is determined solely by the ratio of the values of its plate and cathode resistors, and not by tube gain, tube aging, or anything else.

About negative feedback (NFB) in amplifiers: The combination of an output transformer with NFB can be problematic due to transformer phase shifts at both frequency extremes. Without an OT, NFB need not be the bogeyman that some believe it is. Someone will say that solid-state amplifiers have NFB and no OT yet they can sound harsh or unpleasant. To that I would say this: The open-loop gain of a typical solid-state amplifier is enormous and this is much of the reason why many solid-state amps sound as they do. All of these negatives are avoided in OTLs.

This OTL's output stage is actually a balanced pair of buffers. Each is fed by its own diff amp (V3 & V4, respectively). The drive signal is applied to the non-inverting input of each diff amp and 100% NFB is applied to the inverting inputs. The V3/V4 diff amp pair has an additional feature: a modified, so-called "phase compressor" is built into this

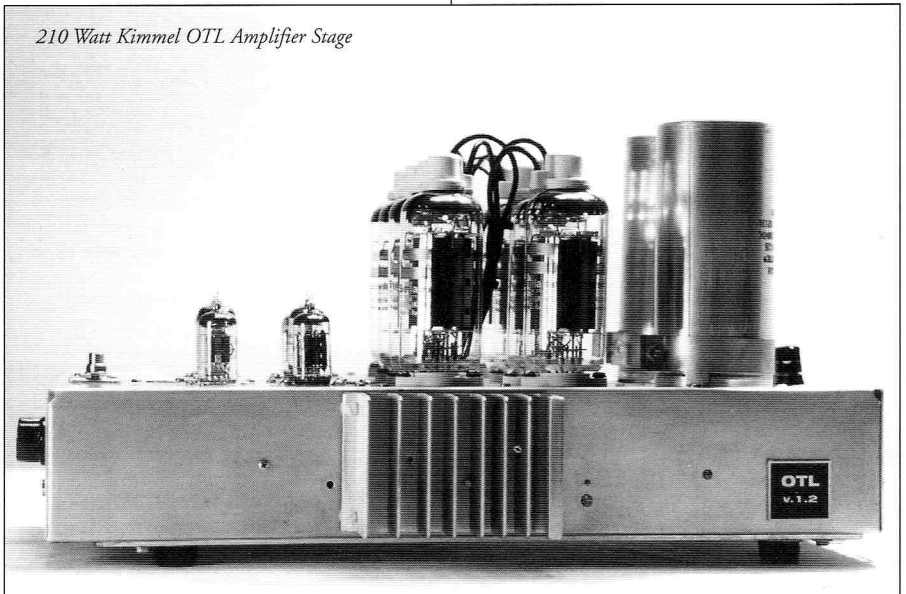

210 Watt Kimmel OTL Amplifier Stage

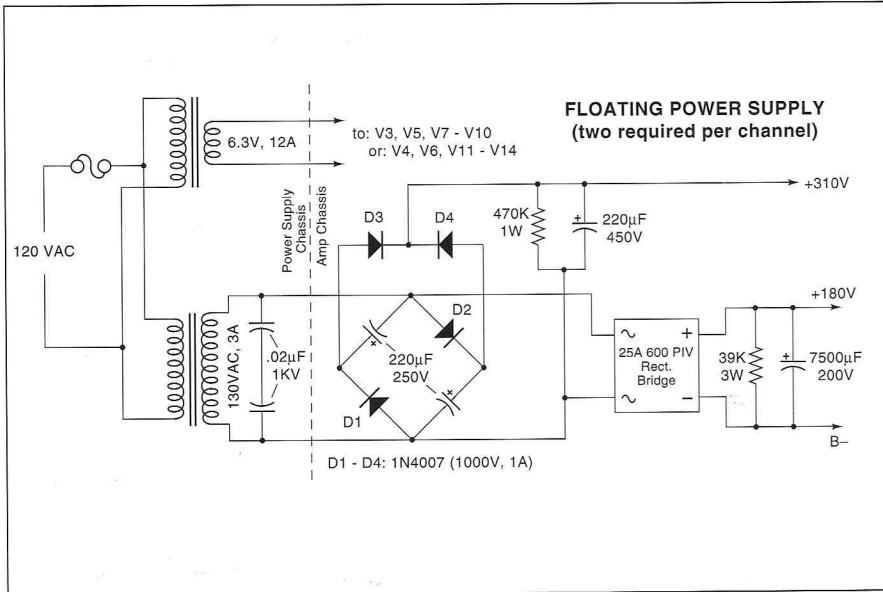

stage, reducing the output impedance of this stage and the overall noise level. (For more on the "phase compressor" see Langford-Smith's Radiotron Designer's Handbook, p.528.) The B+ for V3B, V4B, V5, & V6 is bootstrapped to approximate a higher B+ voltage so that these stages can provide large voltage swings when called upon to do so. This bootstrapping is accomplished simply by taking the B+ for these stages from the floating supplies.

Next is the pair of cathode followers, V5 & V6, which drive the output tubes.

For maximum output it is necessary to be able to drive the output tubes into grid current. This requires a cathode follower with its output directly coupled to the grids of the output tubes. For this stage you want a pair of triodes that have good current handling ability, plenty of transconductance (gm), and which can tolerate 300V. A pair of 5687s gave excellent performance, as did a pair of 7119s. Actually, a single 5687 (or 7119) is enough. (If you use just one tube here, its filament should be powered by a filament winding other than those of the floating

supplies. In this case, either a 6V or 12V winding could be used for this tube.) The plate of this V5/V6 triode cathode follower stage follows its cathode, which is analogous to the screen of a pentode cathode follower following its cathode. This causes a triode cathode follower to perform like a pentode cathode follower.

A footnote about grid current: when grid current will be encountered you don't want large value grid stopper (gs) resistors at the output tube grids, as this could limit their grid current a bit much; for most tubes (except the few so-called "zero-bias" types) I've found 150 ohms to be a good universal value for gs resistors.

The bias voltage is derived from both regulated and unregulated sources, yielding a semi-regulated bias voltage. If the bias voltage for the output stage is 100% regulated, output tube plate current rises and falls as the AC line voltage rises and falls, respectively. If the bias voltage is not regulated at all, the plate current does the opposite-- it falls and rises as the AC line voltage rises and falls, respectively. (One situation or the other probably applies to most tube amps.) I found that a semi-regulated bias voltage keeps the plate current of the output stage fairly constant despite changes in the AC line voltage.

Construction

Each monoblock OTL should be built on two chassis-- one for the amplifier circuitry and one for the power supply. This is the best way to build most amps, a technique made famous by classic McIntosh amps from tube audio's first

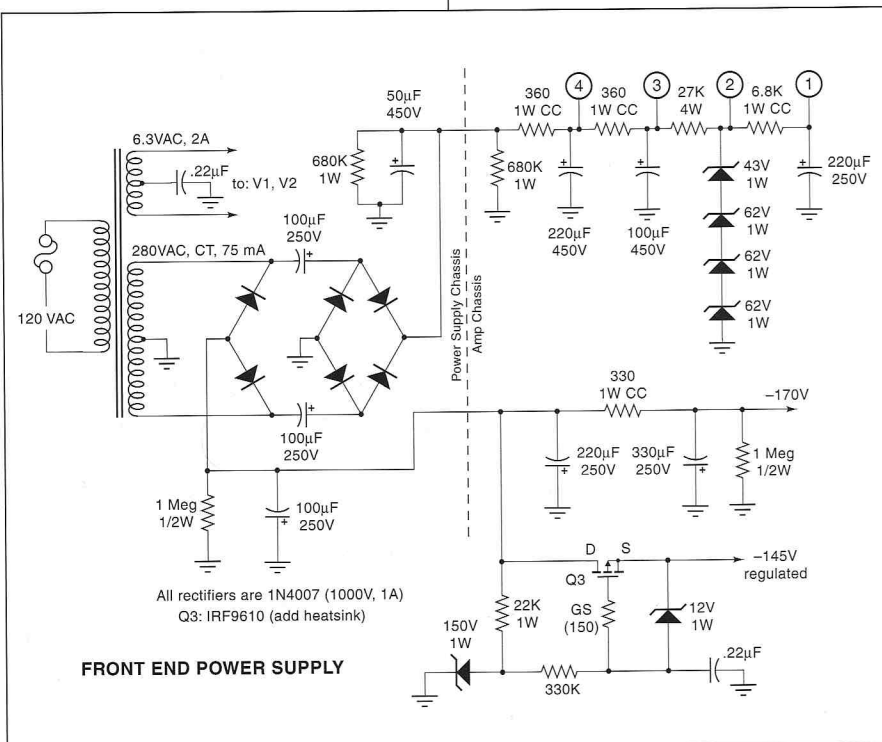

Check Out VTV On The Web!

- Free Buy-Sell Tube Ads
- Free Articles to Download
- Cool Pictures of Tubes and Vintage Gear
- Cool Links to Other Sites
- Buy T-Shirts, Back Issues
- Technical information and announcements about VTV and tube related events across the country

We now get over 1200 visits to the VTV site each week!
www.vacuumtube.com

S W E E P T U B E O T L

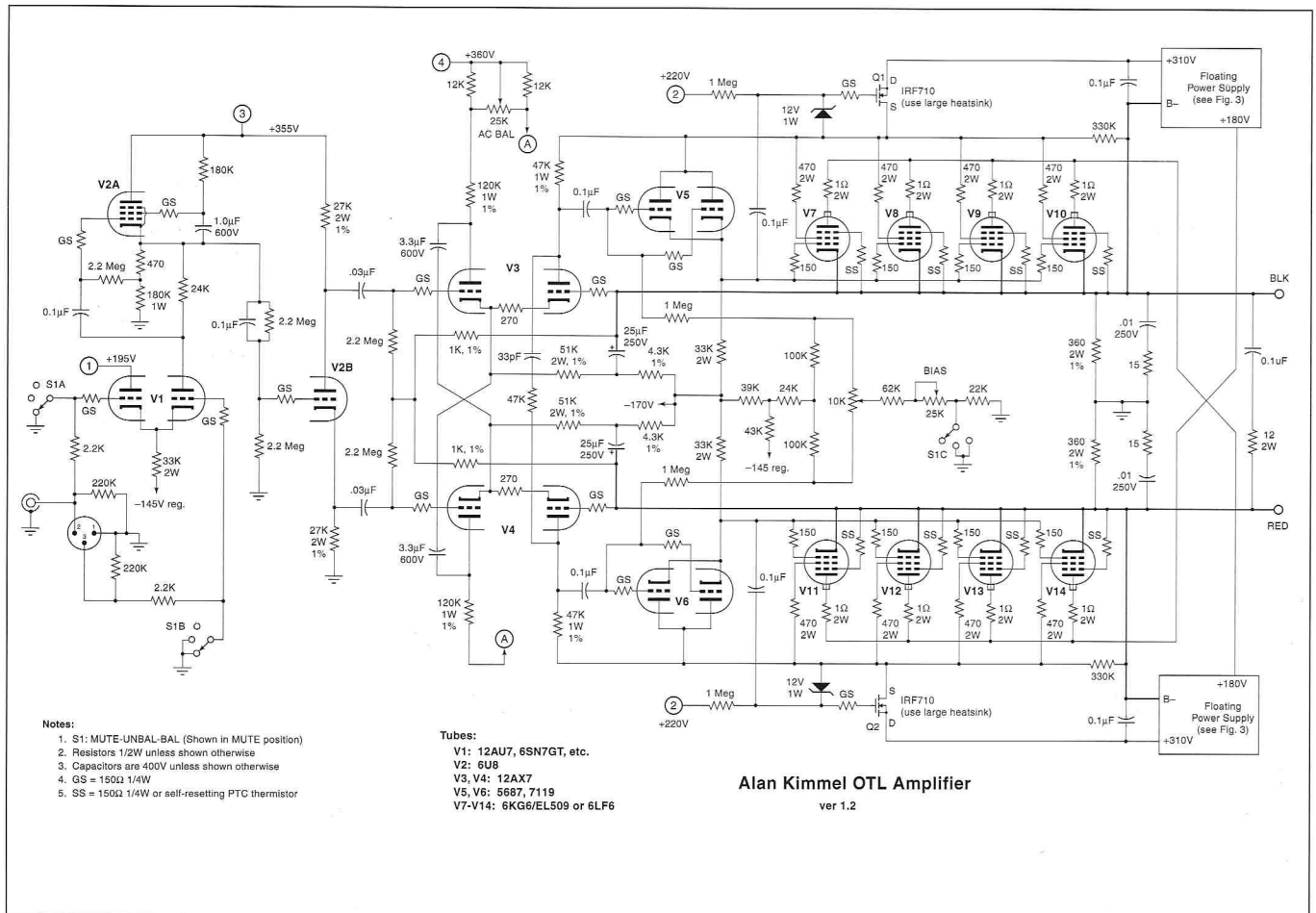

Golden Age. This two-chassis technique minimizes noise, makes for easier construction and easier handling of the amp. Use connectors to connect the power supply chassis to the amplifier chassis; for safety, use female connectors for the power supply and male connectors for the amplifier, so that no exposed pins carry high voltage. Use a high current connector to supply power to the output stage filaments and plates (i.e., the floating supplies). A lower current connector can feed the driver circuits.

Most of the power supply capacitors should be located in/on the amplifier chassis. The dotted lines on the power supply schematics show this division, i.e., the components to the left of the dotted line should be in the power supply chassis while the components to the right of the dotted line should be in the amplifier chassis.

The floating supply for the output stage is shown as Fig. 3. Two of these supplies are required per monoblock. Each 130VAC winding is provided by an isolation transformer rated at 3A (a high-

er current rating would of course make for a stiffer plate supply and higher power output from the OTL). Or, instead of two separate isolation transformers per monoblock a single transformers exist with 130V secondaries. After rectification and filtering 130VAC yields about 180VDC for the plates of the output tubes. Because the secondaries of the isolation transformers track the OTL output in a Circlotron output stage, it would be ideal to use isolation transformers that have low capacitance from primary to secondary, i.e., "high isolation" transformers. But the low output impedance of the amp should enable it to work well with ordinary isolation transformers.

(Tech Editor's Note: If a slight buzz is encountered with this type of Circlotron circuit, it may be caused by the switching noise of the rectifiers in the floating supplies. High speed rectifiers can help reduce this, as can an R-C snubber network across the transformer secondary)

The raw B+ for the two screen supplies is derived from a full-wave voltage doubler which takes its power from, and

is referenced to, each corresponding plate supply. The pass devices of each screen supply are attached to large heatsinks, as they must dissipate a lot of power (one such heatsink is visible in the photo of the prototype). I chose an IRF710 as the screen supply pass device because of its low input capacitance (C_{iss}).

I recommend one 7A or 8A SLO-BLO fuse to feed AC to all the power supplies in one monoblock. Another small fuse (3/4A to 1A) is recommended to feed the front end power supply.

The primary windings of each transformer should be "polarized." This is done as follows:

- Connect a Hi-Z AC voltmeter between Earth Ground and the p.s. chassis.
- Connect an AC test cord to one of the transformers. Plug in the line cord and note the voltmeter reading.
- Reverse the polarity of the test cord and repeat step B.
- One of the two polarities will provide a lower voltage reading. That is the preferred polarity for that transformer. Mark the primary leads of that

transformer accordingly.

E. Repeat steps A thru D for each transformer. While testing the polarity of each transformer, the other transformers must not be connected to the AC line.

Exercise the utmost care and safety precautions while doing this! The benefits gained by this "primary polarization" are twofold:

1. Improved reliability and safety.
2. Improved sound may also result.

This procedure, first shown to me by Tom Tutay years ago, is a good idea for all amplifiers.

To be conservative I call this a 150W amplifier. Though I built the prototype with 8 output tubes you can use 2, 4, 6, 8, 10, 12, or 14 depending on how much power you want. Both sides of the output stage should have an equal quantity of tubes of course. Be aware when using fewer output tubes that the output impedance will be somewhat higher.

I recommend placing the output tube sockets about 3 inches from each other and from everything else for proper cooling. MAGNOVAL tube sockets are required for these output tubes. Note that Magnoval pins are larger than the more common "Novar" pins. Chassis mount Magnoval sockets are sold by Svetlana as their part # SK509 for \$2.00 each as of this writing. Antique Electronic Supply also carries this socket as part # P-ST9-509. It is 100% ceramic and requires care in mounting to avoid breaking it. I mounted the sockets on top of the chassis with a thin fiber washer between each screw head and the socket. Panhead screws are recommended. Billington Export Limited of England is another source of Magnoval sockets.

About the plate caps, a.k.a. top caps: The top cap of type 6KG6 is 1/4 inch in diameter. This is the smallest size, as used by 6J7 and 6K7 tubes. Svetlana now carries a suitable plate cap, model PC509 for \$8.50 each. Billington Export Ltd has one as part # TC12E1. Yet another option is to use the end clips from fuse holders. Some people have been known to simply solder the plate lead to the tube's top cap (though this may void the tube warranty). In any event, ensure that the top cap connection is well insulated.

It is strongly recommended that you place a fast-blow fuse in series with one lead of the speaker. This OTL prototype has been reliable and trouble-free but the speaker fuse provides an added margin of safety.

Another margin of safety is provided by the small 150 ohm 1/4 W film resistors that go to the suppressor grid (grid #3) of each output tube. The suppressor grid resistor's only function is to act as a fuse in the unlikely event of a short from the suppressor grid to the plate of the tube. As a group, sweep tubes were more susceptible to this type of short than other tubes. I call these disaster-prevention resistors "short-stoppers" (ss). Do not substitute higher power or non-film resistors for them.

Because there is only one bias adjustment it is necessary to use a matched octet of output tubes per monoblock. If you cannot find a matched octet, the next best thing would be two matched quartets.

Adjustments and Operation

Set the BIAS pot to maximum resistance, and the DC and AC BAL pots to center position. Do not connect a load to the OTL yet. With the function switch turned to UNBAL, set the bias so that an average of about 77 mA flows through each output tube plate, producing about 77 mVDC across each 1 ohm plate resistor. You can install pin jacks to monitor the 1 ohm resistors. I installed a simple meter circuit in the prototype to monitor the drop across the 1 ohm resistors.

If it ever becomes necessary to change the bias voltage range, change the value of the bias range resistor "Rbr," shown as 62K in Fig.2: a larger value gives a larger bias voltage, and vice-versa. Situations that would require a different bias voltage are:

1. Using triodes other than type 5687 for V5 & V6.
2. Using different types of output tubes.

Next, adjust DC BAL for minimum output offset. Next, connect a dummy load to the OTL. Then feed a 1 kHz sine wave into the OTL giving an output of about 10Vrms and adjust AC BAL for minimum DC output offset. Then recheck BIAS and DC BAL. When the output tubes or V5 and V6 are changed, the BIAS and DC BAL must be re-adjusted.

Caution: When bench testing any OTL, especially with steady-state power output tests, do not run a sine wave or other repetitious waveforms through the OTL any longer than absolutely necessary to minimize wear on the output tubes.

This OTL will drive a 4 ohm load but it's not an ideal match. Driving 8 ohm

loads directly is quite an accomplishment for tubes but asking tubes to directly drive 4 ohm loads is excessive.

I recommend soft-starting devices for most amplifiers (including this one), especially for amps that have an expensive output stage. It is good practice to have the OTL in the MUTE/STANDBY mode while it is warming up. It is also a good idea to install separate AC lines for power amplifiers, especially if the amplifiers can put out some power. *(However, make sure there is no ground noise between the two lines - Tech Ed.)*

Audiophiles report that listening to music through this OTL reveals a clean, tight, effortless, and above all, very musical amplifier across the entire sound spectrum.

A Few Specifications

Measurements made from the prototype @ 1kHz and with 8 ohms load except where shown otherwise.

Performance with 8 output tubes

Frequency Response (referred to 10W @ 1kHz): 16Hz to 26kHz within 0.3dB

Continuous Power Output: 230W rms into 16 ohms, 210W rms into 8 ohms, 140W rms into 4 ohms (power supply limited)

(Note: When I made the maximum power output measurements the plate supplies of the output stage were pulled down quite a bit. The screen supplies (which take their power from the plate supplies) were also pulled down somewhat.)

Total Harmonic Distortion:

- 0.08% @ 5W rms
- 0.3 % @ 50W rms
- 0.35% @ 150W rms

Output Impedance: 0.5 ohms

Input Sensitivity, Unbalanced Input: 1.7 Vrms input for full output

Input Sensitivity, Balanced Input: 2x 0.85 Vrms input for full output

Combined total idle dissipation of all the tubes including heaters: 240 W.

Notice:

Private individuals may build this project for their own personal use. If you want to use this proprietary design for commercial purposes VTV can put you in contact with Alan Kimmel for licensing, which includes consultation, improvements and updates, and more.

RCA Tube Production Harrison, New Jersey

1930-1976

By Charles Kittleson

© 1997 All Rights Reserved



Early 1930s RCA Tube Manuals (RC 11 and RC 12)

At one time, Radio Corporation of America (RCA) was the largest and most powerful electronics company in the world. They were involved in many of the early developments in radio, broadcasting, movie theaters, sound reproduction, television and countless other electronic innovations. This article covers vacuum tube manufacturing at their Harrison, New Jersey facility and is only a small part of the vast history of this technological giant.

The Forming of RCA

Radio technology played a major role in the Allies winning World War I. Radio was also instrumental in ship navigation and communication. The government had taken over all of American Marconi's coastal and inland stations for wartime use but did not want a foreign company to manufacture all the wireless equipment. In 1919, Radio Corporation of America (RCA) was formed and it took over the assets of the American Marconi Company. Patents relating to vacuum tubes, transmitter design and receivers were held by AT & T, GE and RCA. In July 1920, an agreement was reached between the three companies to permit RCA to use the radio patents of all three companies. The first popular tube developed and marketed by this group was the UV-201 triode. GE originally developed the UV-201 and RCA began marketing it in December 1920. It was distributed under the Radiotron name in the east and under the Cunningham label in the west. In 1921, Westinghouse, which held some of the Armstrong and Pupin patents, joined the RCA group as a cross-licensee.

In the early days of radio after World War I, RCA acted as a research and development and selling agency for radio related products and vacuum tubes. Before 1930, RCA was merely a vendor. The actual manufacturing was done entirely by other electrical manufacturing companies. General Electric of Schenectady, New York and Westinghouse of East Pittsburgh, Pennsylvania manufactured RCA radio receivers and receiving tubes. RCA-branded tubes were also manufac-

tured by General Electric at the old Thomas Edison lamp works in Harrison, New Jersey. Some of the first receiving tubes marketed by RCA were the types UV-200 and the UV-201. Later RCA-branded types included: WD-11, UX-201, UX-120, UV-199, etc.

AT&T, RCA, GE and Westinghouse (the Big Four) had a monopoly on the electronics and tube business in the USA. They were the holders of most of the important patents, and other companies were promptly sued and put out of business if they tried to put up a challenge. RCA had hundreds of industry "watch-dogs" and spies who reported patent violators to their army of corporate attorneys.

In the late 1920s, the "Big Four" agreed to consolidate their efforts to

reduce duplication of R & D and manufacturing efforts. RCA concentrated on radios and receiving tubes, GE and Westinghouse concentrated on transmitters, industrial and transmitting tubes.

This arrangement lasted until May 1930, when the government sued RCA claiming their arrangement was a "restraint of trade." The litigation lasted until November 1932 when the consent decree was issued by the courts. The judgment permitted the companies in concern to engage in open competition after May 1935.

RCA At Harrison

On January 1, 1930, RCA completed the consolidation of RCA Victor (Camden, NJ) and Radiotron (Harrison, NJ). RCA then began to manufacture tubes under the Radiotron brand at

MISCH METAL • NIGROSINE • PORCELAIN • PETROLEUM JELLY • ZINC
CALCIUM ALUMINUM FLUORIDE • RESIN (SYNTHETIC) • ETHYL ALCOHOL

MATERIALS USED IN RCA RADIO TUBES

LEAD ACETATE • MALACHITE GREEN • GLYCERINE • ZINC CHLORIDE • IRON
MARBLE DUST • WOOD FIBER • STRONTIUM NITRATE • LEAD OXIDE • ZINC OXIDE
LAVA • MICA • TIN • SODIUM CARBONATE • SODIUM NITRATE • SILVER OXIDE

| | | |
|---------------------|--|---------------------|
| BARIUM CARBONATE | | CALCIUM CARBONATE |
| ARSENIC TRIOXIDE | | AMMONIUM CHLORIDE |
| STRONTIUM CARBONATE | | POTASSIUM CARBONATE |
| ISOLANTITE | | BAKELITE |
| MOLYBDENUM | | PHOSPHORUS |
| ALUMINA | | SILICON |
| BORAX | | SHELLAC |
| BARIUM | | TUNGSTEN |
| COPPER | | TITANIUM |
| CARBON | | SILICA |
| CHROMIUM | | GLASS |
| CALCIUM | | MAGNESIA |
| CAESIUM | | PLATINUM |
| COBALT | | STRONTIUM |
| IRIDIUM | | MAGNESIUM |
| MONEL | | ROSIUM |
| MERCURY | | NICKEL |
| CALCIUM OXIDE | | COBALT OXIDE |
| BARIUM NITRATE | | THORIUM NITRATE |

| | |
|---|--|
| GRIDS Diameters measured to 0.001 inch | PLATE Diameter gauged to 0.002 inch |
| CATHODE-SLEEVE WALL Approximately 0.002 inch thick | CATHODE COATING Weight variation less than 0.00007 oz. |
| AIR PRESSURE 1/100,000,000 that of atmospheric pressure at sea level | GRID WIRE Diameter does not vary more than 0.00009 inch |
| BULB Inspected under polarized light for strains | HEATER WIRE Diameter does not vary more than 0.00002 inch |

RCA TUBE PRODUCTION



Harrison. Elmer T. Cunningham was the RCA representative on the West Coast from the very beginning. Cunningham had a great reputation for his tube products and in 1931, the Cunningham Company of San Francisco, California was taken over by RCA and consolidated into the RCA Radiotron Company. In 1933, Cunningham became president of the RCA Radiotron Company. Because of Cunningham's great reputation, he was able to convince RCA to have their tubes branded with his name to be sold on the West Coast until the late 1930s. In 1934, RCA purchased the then defunct De Forest Radio Company. This gave

them an avenue to begin the manufacture of transmitting tubes in Harrison and other locations.

An Inside Look at Tube Manufacturing

From the beginning, RCA's goal was to dominate the tube market. This driving force allowed them to be successful in the tube business for 46 years. Let's look at what went into the manufacturing of RCA Tubes.

Raw materials obtained for manufacturing tubes were of high purity. There were sixty-five various types of metal, chemical compounds and gases used to

manufacture tubes. This is in addition to up to forty separate and distinct parts, which were assembled with the utmost care and precision.

Samples of raw materials were pre-tested for purity by the Inspection Service Department. Materials that passed the inspection were then processed, built into parts and assembled into sample tubes. The sample tubes were then tested and retested to reduce potential for failure in the field.

Spot checks were made on each individual operation and part. In the Quality Control Laboratory, a double check was made on all spot checks to insure only the best tubes were sold to customers. Tubes were then placed in life test racks and operated for a period of 500 hours under extreme conditions. These tubes were then checked for changes and a detailed report was compiled.

When finished tubes passed the rigid inspections of the QC department, they were packed in sealed cartons. Before actual shipment, they were checked again to prevent tubes damaged in storage from being shipped out.

In the development laboratory, engineers were busy improving existing designs and researching new types. In Harrison, the research and development department occupied the largest section of the entire Radiotron Laboratory. According to company literature, only the



Tube Girls Burning in receiving tubes at Harrison in 1932

most skilled and talented engineers were employed in the lab.

Tube Types Developed by RCA

Even in the early days, many tube companies legitimately rebranded other manufacturer's tubes to sell under their name. RCA was no exception; they bought and rebranded tubes from GE, Westinghouse, Sylvania and Tung-Sol. However, RCA was responsible for introducing several popular audio tubes. By RCA's request, GE designed the 210 transmitting tube in 1922, which was put into production in 1925. The 210 was also used as an audio output tube in some radio receivers in the late 1920s.

Also, at RCA's request, Westinghouse developed the type 250 triode in 1928 for use as a high power audio section in expensive radios. Westinghouse introduced the type 245 triode in 1929 as a low cost, low power alternative to the 50. Although Westinghouse developed these tubes, literally all of them were branded RCA before 1930. The first RCA tubes made at the Harrison facility were the 2 volt filament types: RCA-230, RCA-231 and RCA-232.

In 1933, RCA in Harrison introduced the 2A3 triode power amplifier in single-plate version. Later it was manufactured in the more common double plate version. In 1935, RCA introduced the first successful metal tubes, initially developed by GE. Also in 1935, the first US" eye tube," 6E5, was introduced by RCA. In 1936, they introduced the famous 6L6 (metal version) and in 1937, the 6L6G glass version. RCA also came out with the 6V6 (metal) in 1937 and the 6V6G glass version in 1938.

In the mid-thirties, after De Forest was out of the tube business, RCA went into the transmitting business in a big way. Some of the more famous develop-

Original Thomas Edison light bulb plant (lighter building) and remaining RCA structure (1996)



ments in this period were: RCA types - 805, 807, 810, 811, 813, 833 and countless others. These types were used in radio transmitters during the war and in civilian use afterwards in civilian applications.

During World War II, RCA was on the forefront of tube development for communications, radar, sonar and related defense electronics. Several additions were added to the six square block facility in Harrison. To supply the tube needs for the ever-demanding war effort, RCA ran production shifts around the clock, seven days a week. At one point, they

were in constant development after the war. In 1950, RCA developed the very first color television picture tube in Harrison. Through the 1950s, hi fi was all the rage and RCA again got into the fray. The 6L6GC, a higher power version of the 6L6GB, was introduced by GE in the late 1950s. RCA introduced their famous "black plate" version of this tube shortly thereafter. Westinghouse introduced the 7591, a popular integrated amp and receiver tube in 1961. RCA sold their rebranded version of this tube and later made their own version. RCA never made an EL34 or 6CA7; they either rebranded European Philips EL34s or GE 6CA7s. RCA never made a 6550 type. Their 6550s were rebranded Tung-Sols or GE 6550As. Other hi-fi types introduced by RCA included: 6973, 7025 7199 and 7027A.

Television was in a major growth mode in the 1960s. RCA developed hundreds of television receiving tubes, Novar types and countless others. The Nuvistor, a small metal-ceramic tube resembling a transistor, was introduced by RCA in 1960.

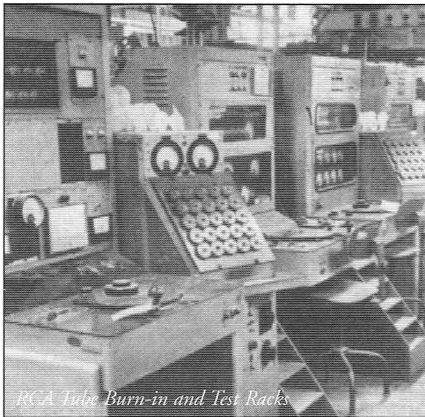

employed 20,000 workers at the Harrison facility and were churning out tubes by the millions. This facility was, without a doubt, the most prolific producer of vacuum tubes in the United States.

After the war in 1948, RCA introduced versions of the 12AX7, 12AU7 and 12AT7 series of miniature dual triodes. In 1950, they introduced the 6146, a powerful and compact beam tetrode for amateur radio transmitters. Black and white and color television picture tubes

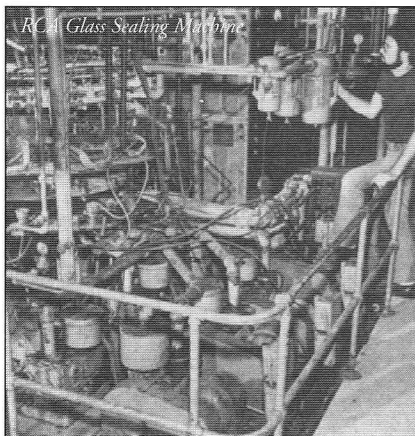
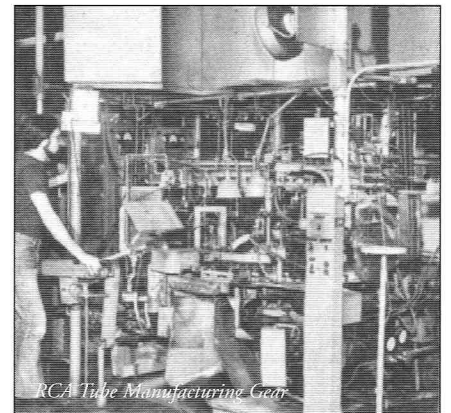

RCA Glass Sealing Machine

RCA Tube Burn-in and Test Racks

RCA Tube Manufacturing Gear

The Giant Begins to Die

Throughout the 1960s, RCA continued to be a major player in electronics. However, things started to slow down in the early 1970s. In mid-1974, RCA announced that its newly introduced line of radios, phonographs and tape players would be its last. At that point, audio products had declined to less than 5% of RCA's consumer electronics business. This business sector was becoming crowded and there was continual downward pressure on prices.

In 1975, RCA dissolved its Electronics Component Division at Harrison and created two new divisions: Picture Tubes and Distributor and Special Products (D & SPD). D&SPD were responsible for worldwide distribution of replacement parts and tubes. Due to an industry shift to solid-state for nearly everything electronic and the steady decline in its receiving tube business, RCA closed its receiving tube plant in April 1976.

In November of 1976, the David Weisz Auctioneer Company held a 12-day public auction to liquidate all of the machinery, equipment, instruments and supplies at Harrison. This included all of the tube manufacturing equipment such as grid winders, cathode sprayers, test consoles, glass sealing machines spot welders, tube aging racks, etc. Also up for grabs were 650,000 square feet of buildings in one complex and 147,000 square feet at another site.

During August of 1996, John Atwood and I visited the Harrison site and observed only two buildings that remained from the original complex. The original Thomas Edison Lamp Works building still stands at South 5th and Bergen Streets, occupied by a clothing manufacturer. Another large building right next to it is occupied by Vo Toys, an importer of toys. The rest of the buildings were razed and an auto repair facility and a strip mall occupied their land.

Bibliography:

1. John Stokes, **70 Years of Radio Tubes and Valves**
2. Gerald F. J. Tyne, **Saga of the Vacuum Tube**
3. Bro. Patrick Dowd, *History and Development of the All-Metal Radio Tube*, AWA Old Timer Bulletin, June 1992
4. RCA Promotional materials from the 1930s through 1960s

Radiotron Designer's Handbook

A Vintage Book Review

By Paul Joseph Bourbin © 1997 All Rights Reserved

Radiotron Designer's Handbook;

Edited by: F. Langford-Smith; Fourth Edition; Published by: The Wireless Press for Amalgamated Wireless Valve Company Pty, Ltd., Australia; Reproduced and Distributed by: RCA Victor Division, Radio Corporation of America, Harrison, NJ. 1952. 1482 pages. Hardbound. (\$7.50 original price)

The fourth edition of the Radiotron Designer's Handbook has long been looked upon as the "Bible" for those interested in vintage tube electronics. It is probably the most comprehensive book ever written on vacuum tubes and their circuits. With the current interest by audio enthusiasts in designing and building new tube audio equipment, this book has achieved a status almost equal to the Holy Grail (and almost as hard to find!).

The Radiotron Designer's Handbook consists of thirty-eight chapters in seven parts. While most books have one Table of Contents, this book has two. The first is called "Chapter Headings" and lists the parts and the titles of each chapter within each part. The second, called the "Contents," covers the sub headings within each chapter. It is as detailed as some indices in lesser books. The first part dis-

cusses Radio Valves and is a general, but thorough introduction to vacuum tubes: their types, characteristics and methods of testing. The second part covers the general theory and components: networks, inductors, feedback, modulation and tuned circuits. The third part is devoted to audio frequencies and does so through every part from input to output and includes circuits to modify as well as amplify audio signals. There is a chapter devoted to loudspeakers and one for audio measurement. The fourth part handles radio frequencies in the same thorough manner and covers all of the related circuits. Part five deals with rectifiers, rectification, filtering and hum. All types and components of power supplies, regulators and filters are covered in great detail. Finally the sixth part brings it all together and goes through complete receivers: the types of AM receivers, design of FM and superhetrodyne AM receivers and the testing and measuring of receivers and amplifiers. Sundry Data is the title for the seventh part and indeed it is! There are nearly 100 pages of tables, charts and other information of interest to anyone who works with electronics. The Index is extremely thorough and makes looking up a specific topic quite easy. After the index, there is a supple-

Radiotron 4th and 3rd editions

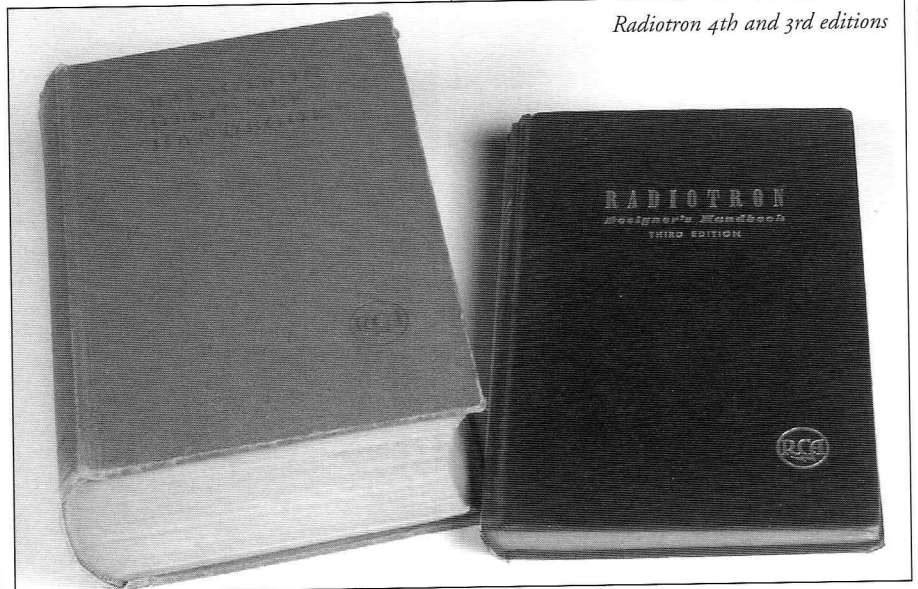

ment containing additional references for each chapter.

This book is not light bedtime reading. It was written for electronic engineers and is quite complex. Despite its great girth, the type is quite small. The book is filled with many drawings and huge piles of formulae! This book requires a strong grasp of mathematics to be understood. Each chapter concludes with a reference section so that the reader can search for even more detail. Although the Radiotron Designer's Handbook seems to be oriented towards radio, it is one of the most detailed books available for those who want to understand and design circuits used in High Fidelity equipment. Although dated 1952, there is no information on use of vacuum tubes for computers, industrial uses (like machine control) or television.

For those who have the ability and desire to use what this book has to offer, there is no better. For those who want a more general discussion on vacuum tube electronics, have little interest in designing equipment or who are not interested in solving an equation on almost every other page, there are better books. The neophyte should read other books first if he or she has the background to understand the material in this book. The book was written for a relatively small audience, engineers and designers, so large numbers were not available to the general public. Many were discarded with the advent of the transistor. Several people are now getting back into designing their own audio equipment. Therefore, this book has become scarce and fairly expensive. For those who really need it (and you know who you are), this book is a must and is well worth the expense and the search.

Please note that the above review is for the FOURTH Edition of the Radiotron Designer's Handbook. It is quite thick with a light red cover. The Third edition is thinner, has black or blue covers and a slightly larger page format. The two books are very, very different. The preceding, third edition, is a very good reference for vintage radio enthusiasts. In fact, it is in many ways better, and a lot cheaper. The third edition is not of much use for the audiophile. When purchasing a copy, especially through the mail, make sure which edition you are getting.

Copyright 1997 Paul Joseph Bourbin - All rights reserved.

Radiotron Designer's Handbook on CD-ROM

By John Atwood

© 1997 All Rights Reserved

A true sign of the current tube renaissance is the recent reissuing of the Radiotron Designer's Handbook (4th Ed.), often referred to as the tube designer's "bible." A current reissue uses the new medium of the CD-ROM.

The CD-ROM has the potential for being a superior storage medium to a conventional book: it is extremely dense, computer access to text can allow quick searches, and the use of hypertext links can greatly improve the perusing process. The Radiotron Designer's Handbook by F. Langford-Smith (Audio Amateur Press) CD-ROM, however, falls short in many of these areas.

Basically, the fourth edition of the classic Radiotron Designer's Handbook was scanned (all 1498 pages!) and put into Adobe Acrobat "pdf" files. Acrobat is a powerful text and image browsing tool that is designed to allow documents to be read across different computer platforms. It has been around for several years, but is just beginning to become widespread, since it is ideal for browsing Internet documents that are too complex for conventional "html" formatting. However, Acrobat is optimized for formatted ASCII text and PostScript™ (EPS) images. It does handle scanned bit-mapped images, but not very well.

There are a limited number of hypertext links - from a table of contents file to chapters, and from the chapter summaries at the beginning of each chapter to subchapter headings. However, the rest is all scanned images. There is no ASCII text to search on, eliminating one of the best advantages of computer-based documents. To be fair, it might be considered unreasonable to convert all the scanned text to ASCII (although OCR technology is steadily improving), and then re-assemble the text with the pictures. This process is time-consuming and error-prone, but for a reference work such as this, it really should have been done.

If you are not worried about search capabilities, then the most obvious problem in using the Radiotron Designer's Handbook CD-ROM is the poor resolution while using the Acrobat reader. On a conventional 13" VGA monitor (640 x 480 pixels) only less than half a page at a time could be viewed with decent readability. Even on my big 20" monitor at high resolution (1280 x 1024 pixels), fitting an entire page on the screen resulted in a document as easy to read as a low-resolution FAX. Fine lines in diagrams often got lost. This is partially the fault of the Acrobat Reader version 2.0 reader supplied with the CD-ROM, which does not "anti-alias" (i.e. smooth-out) the scanned text. Acrobat Reader 3.0, which is available for free (<http://www.adobe.com/prodindex/acrobat/readstep.html>), makes the text easier to read, but doesn't really solve the problem of needing a big monitor to see one page at a time.

An interesting aside is that although the CD-ROM only mentions use in a PC-based Windows system, I fired up the Acrobat reader on my Macintosh, and read the CD-ROM pdf files just fine. Audio Amateur Press could somewhat enlarge their market by publicizing the fact that it is usable on Mac, an Acrobat reader had already been installed.

As a compact and cost-effective way of archiving, CD-ROMs are very attractive. However, the current Radiotron Designer's Handbook CD-ROM is just too difficult to use easily. If the time was spent in OCR'ing it, and converting to real text (essentially re-typesetting it), it would be a much more valuable CD.

The Radiotron Designer Handbook on CD-ROM (\$29.95), is available from Old Colony Products, P.O. Box 576 Peterborough, New Hampshire 03458-0576

Computing With Tubes The Savage Art

By Eric Barbour © 1997 All Rights Reserved

2. INSIDE ENIAC

During World War II, a top-of-the-line radio contained 20 tubes. Early television sets, with their 25 to 35 tubes, were thought to be large and complex devices. Telephone exchanges might have hundreds of tubes in their repeater amplifiers and other circuits, requiring round-the-clock service and preventive maintenance by several technicians. The very thought of putting 17,468 tubes together in one room and using them as a digital computer was considered by some to be outrageous. It didn't help that the octal-base tubes of the era were not very efficient or reliable, compared to later miniature tubes.

Despite these massive problems, J. Presper Eckert and John Mauchly of the University of Pennsylvania's Moore School of Engineering were able to pull it off. ENIAC, Electronic Numerical Integrator And Computer, required a staff of 14 to construct during the 1943-45 period. And even then, considering the staggering complexity and interconnected nature of the circuitry, and the fact that it was essentially a dynamic-only system, with most functions performed in a serial-synchronous fashion (like most tubed computers of the 1950s), it is plain to see that Eckert and Mauchly's team spent a lot of evenings and weekends in that sweltering room. Air conditioning was

not provided until ENIAC was moved to the Army Ballistics Research Laboratory, Aberdeen Proving Grounds, Maryland, in 1947.

When it was announced in February 1946, ENIAC consisted of forty racks arranged in a U shape. The first four were the control, cycling, and master programmer circuits. These provided serial pulses to other systems via two major buses; the Program Lines and the Digit Trunks.

There were twenty accumulators, each having 10 decimal digits of flip-flop memory; a multiplier, also 10 decimal digits wide; a divider and square rooter; and three "function tables", which are essentially large patch panels using banks of rotary switches to route sig-

nals. A set of three "constant transmitters" was provided to generate presettable pulse trains over and over from an IBM card reader. An IBM printer was available for numeric output.

Programming the ENIAC was done partly with patch cables, partly with rotary switch settings. By comparison with later machines, this process seems byzantine. The designers opted for a high level of generalization, both to insure maximum usefulness and to minimize the number of tubes used.

This is also why the machine is one-of-ten decimal, rather than binary. Eckert thought that decimal would require fewer tubes (he turned out to be wrong). All

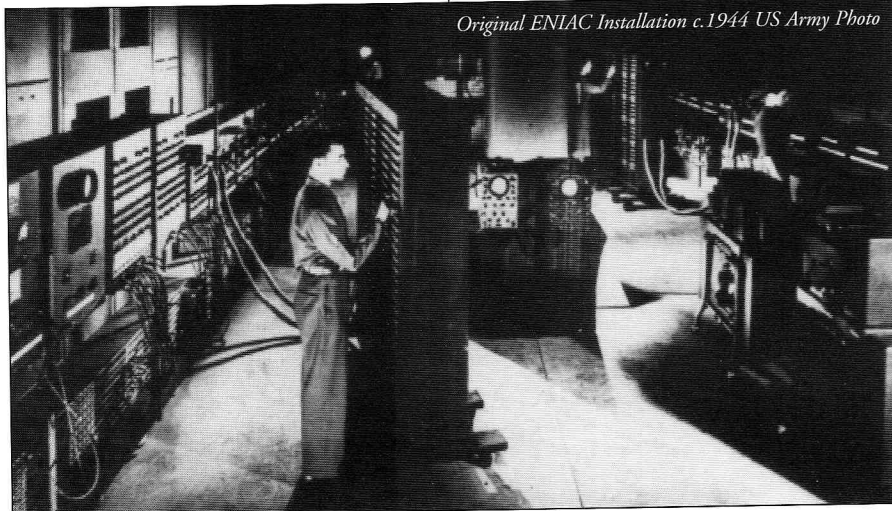
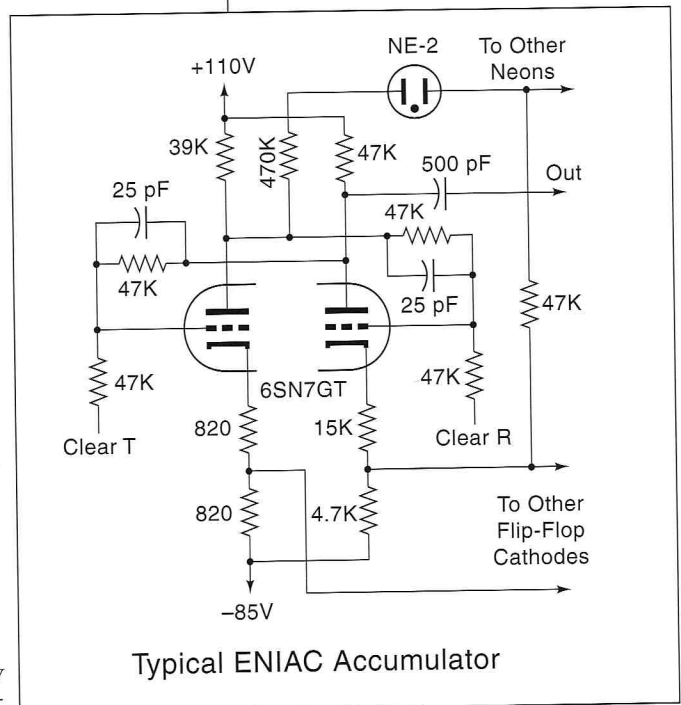

Original ENIAC Installation c.1944 US Army Photo

the active circuits were equipped with neon lamps to show the current state and results, although reading these lamps was a job for an experienced operator. Press relations were considered a major part of the project, and so a special lamp panel was built to display the contents of an accumulator for newsreel film crews.

Describing the accumulator would use up most of the space in this magazine, so we will cover it in very general terms. Each of the ten digits is a plug-in module containing ten 6SN7 flip-flops plus some control logic, for a total of 28 tubes. Performing integer multiplication, integer powers and other basic functions is possible due to the complex gating and control logic. Each accumulator has ten

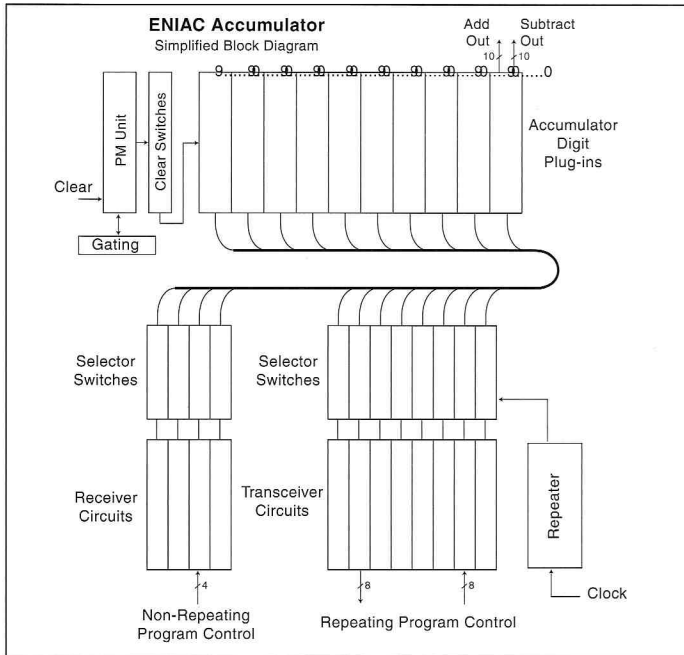

left on overnight, and if the tubes tolerated the morning switch-on. This kind of story has tended to color the layperson's view of tube computers as being hopelessly unreliable, even though later machines were more carefully designed and could run for months without tube failures.

If the accumulators seem complex, consider the multiplier. It used the add-and-shift technique, complicated by the one-of-ten decimal system.

A pair of accumulators communicated with the multiplier via transceiver circuits similar to their own. An input selector drove an encoding array of resistors,

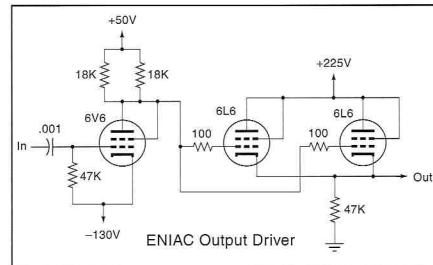

which fed a decoder gate matrix, which then went to the dual shifters. The logic consisted of oceans of 6L7 pentagrid converters, buffered by ranks of 6L6s, with some functions performed by 6AC7s. The fact that this circuit did not use 6SJ7s and 6SA7s seems to indicate that the multiplier (and the similar divider/rooter) were designed by someone other than the accumulator designer. Power used a scheme similar to the accumulators, with numerous DC plate voltages to provide level shifting. Three selectors, two tables, two shifters, two gate panels add up to 902 tubes, not counting the transceivers and buffers.

Operating ENIAC kept numerous engineers, programmers and clerks busy 24 hours a day. It ran for 10 years, performing everything from the world's first nuclear-weapons simulations before its 1946 public announcement, through

artillery trajectories and assorted scientific calculations after it was moved to Aberdeen in 1947, through many modifications and improvements (including some core memory in 1953), until its final shutdown in 1955. Today the Smithsonian owns part of ENIAC, while much of the remainder is in storage at the Moore School. One accumulator was powered up for the 50th anniversary celebration in February 1996. Yes, it added two numbers accurately.

Between 1945 and 1950, it was the only general-purpose digital electronic computer in regular use in America. The few other pre-1950 machines tended to be experimental and specialized in nature. ENIAC solved a wide range of numerical analysis, from artillery ballistics tables to supersonic airflow studies to weather forecasting models. All this from a machine that today would be considered a very unreliable programmable calculator, with only 20 memory locations. The vast and complex "digital culture" owes its existence to ENIAC.

References

Information on the basic logic elements of ENIAC was derived from a set of copies of original schematic drawings, depicting the wiring and signal flow of ENIAC. Drawings of the accumulator circuit (series 5) and multiplier (series 6) were consulted.

There is considerable information about ENIAC on the Internet. The official University of Pennsylvania Moore School site, containing a lengthy description of the machine's operation (though with little tube-level circuit detail), is at: www.seas.upenn.edu/~museum A site with many photos and historical data about ENIAC, as well as other early computers, is at: ftp.arl.mil/~mike/comphist

ENIAC's operation is so complex and arcane (and unlike the standard Von Neumann architecture which prevails today) that persons wishing to learn more about its programming are advised to examine the Moore School web site.

1. Fritz, W. Barkley, "ENIAC--A Problem Solver," **IEEE Annals Of The History Of Computing**, Vol. 16, No. 1, 1994, p. 25.

Many thanks to James M. Duffin, ENIAC Project Archivist, University of Pennsylvania, and to his staff. Also to Sandy Smith of the Public Affairs Office of the University of Pennsylvania.

decade modules, one PM-and-clear module, one repeater module, eight pulse transceivers, two program-pulse receivers, and one gate module, all adding up to more than 500 tubes. Gating is done with 6SJ7s or 6SA7s, with their various grids receiving various pulse signals. The many gating functions require many interface arrangements, since various tubes and grids within tubes are used, all of different sensitivities.

Each accumulator is provided with the following DC supply voltages: +225, +150, +110, +75, +50, +25, +20, - 10, - 40, - 80, - 85, - 105, - 115, - 125, - 130, - 170, - 180, - 200, - 235, - 240, - 245, - 295, - 315, - 320, - 345, - 360, - 375, - 385, - 415, - 425, - 450, - 470, and - 555 volts. Level shifting made this necessary. Drivers usually consisted of 6L6s in triode-connected cathode followers. Lots and lots of 6L6s, in fact--usually driven by 6V6s. Presumably they were available very cheaply in 1944, when work started in earnest.

Only six filament transformers ran the heaters of all the tubes in each accumulator, and even though the heater supplies were floating, the fact that they were shared among tubes with widely varying quiescent cathode voltages would tend to indicate why ENIAC had such problems with "unreliable" tubes. Special types for this service did not exist yet, so ENIAC was made out of common, cheap radio tubes, with not much heater-cathode voltage capability. Legend has it that ENIAC could be kept running for as much as 3 days if the heater power were

VTV Listens to the New WE 300B Types

By Charlie Kittleson ©1997 All Rights Reserved

It has been over a year since VTV evaluated 300B tube types (VTV #3) and the output transformers available for SE 300B operation. For this test, we used two amps, including the AudioNote Kit One (reviewed in this issue) and a SE 300B project amp built by Eric.

The project amp uses One Electron UBT-3 3K-output transformers with type 76 first audio tubes for each stage and a 6BL7 driver stage. Speakers used were either B & W DM110s or Klipsch Chorus 1s. The listening room was the VTV office in Sunnyvale.

Program material covered a variety of new jazz and classical releases on CD. We either went direct to the amps from the CD player or we used Eric's tube line stage described in VTV #7.

VTV does its component reviews a little differently from most other audio magazines. We use the Japanese audio review method by inviting a number of local audiophiles and tube enthusiasts to listening sessions up to three or four different times. Opinions expressed are those from the group, as opposed to a single reviewer. Advertisers do not influ-

ence our opinions by how much they spend on ads. If a product does not perform well, VTV readers will know about it, even if the product is advertised in VTV. Our ultimate goal is to find the most compelling, involving and musical sounding components.

Cetron 300B

Richardson Electronics has been making this tube for several years now, with their primary market being Asia and a few American OEMs. In our first 300B test in VTV #3, the Cetron 300B had grid windings that appeared uneven and when tested for distortion, it was a little on the high side. Since then, Richardson has made significant quality and materials improvements in this tube.

The Cetron 300Bs we tested were very smooth and musical with very good low bass when compared to other 300Bs in this test. This 300B does not have a center-tapped filament, so some amps using AC on the filaments may generate a little hum with this tube. This hum can be eliminated by proper power supply design. VTV rates this tube as very good, its only weakness being a slightly less involving mid-bass than the top rated tubes.

Chinese 300B (Shuguang - metal anode)

This tube comes standard in many contemporary 300B push-pull and SE amps, primarily due to its cost - under \$50 in quantity. In the AudioNote Kit One, the tubes were exceptional, with involving mids and a lot of air. However, the bass response was not very strong and the highs were significantly rolled off

when compared to the other 300Bs. Chinese 300Bs are relatively short-lived with an average service life of 500 to 1,000 hours.

Chinese 300B (graphite plate)

This tube has been available for several months now through certain importers. It is beautifully made tube with a very interesting anode structure, brown base and gold pins. When listened to, however, the tube had sizzly, sibilant highs, and a congested midrange. The sound was not balanced and was slightly distorted.

Sovtek 300B

This tube was introduced to the American market almost a year ago. Since the first version, another variant was introduced about two months ago. Available from New Sensor or other tube distributors, this tube is priced in the bargain range of \$59. The shape of the glass envelope on the Sovtek 300B is a little narrower than the original WE300B and is taller, overall. We noted that the tube had good tonal balance, was musical, but the midrange was less involving than the Chinese 300B. The sound quality had less air and was 2D sounding when compared to the Svetlana 300B.

Svetlana 300B

Even though this tube is not available to the public yet, we were able to evaluate the yet-to-be-introduced Svetlana 300B. According to Eric Barbour, this tube is supposed to be a direct copy of the original item. The tube has an open, airy

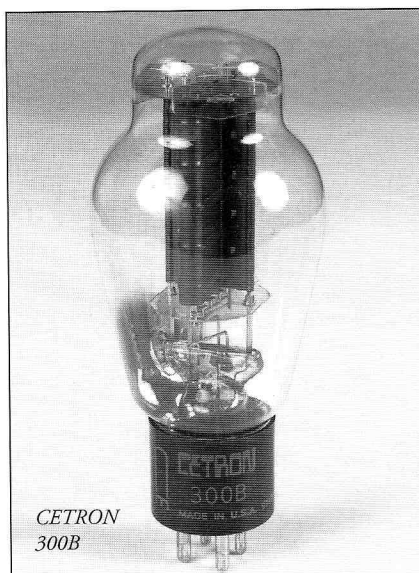

CETRON
300B

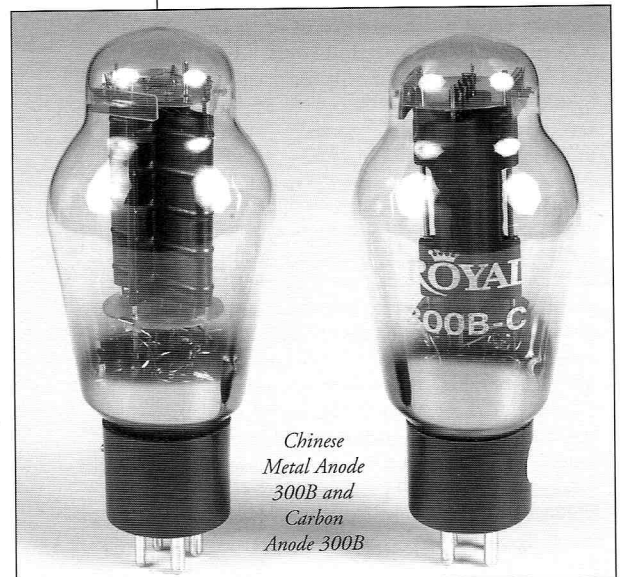

Chinese
Metal Anode
300B and
Carbon
Anode 300B

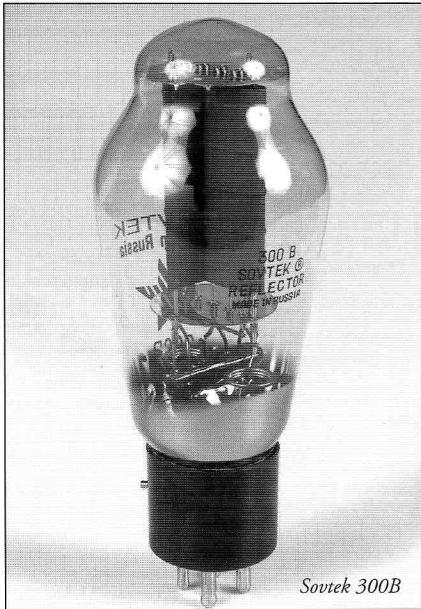

Sovtek 300B

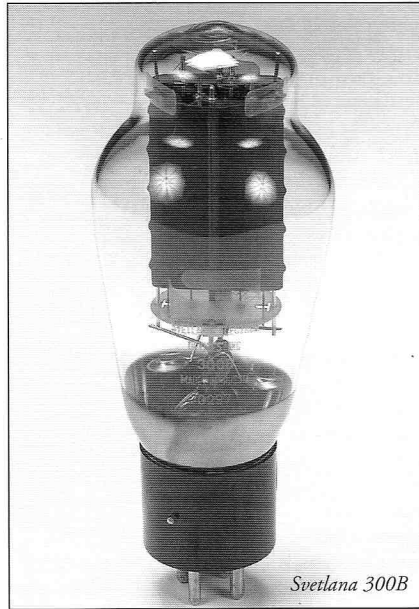

Svetlana 300B

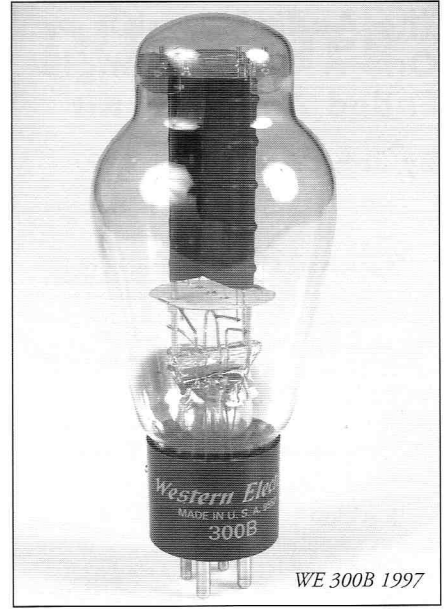

WE 300B 1997

sound. The midrange is thick, rich and very musically involving. However, the highs were a little more up-front than the WE300B. The tube had a bit more treble and was lively sounding, great for speakers with some high frequency roll-off.

Eric tells us that this tube will be available sometime in 1998 and will be priced at \$152 retail. Don't bother calling Svetlana about their 300B until early 1998.

Western Electric WE300B (1997)

Charles Whitener has finally done it! After almost two years in development, the new WE300B is finally available. It looks like the original item, right down to minute details such as the carbon-black coated nickel anode, center-tapped filament and mica clips. The filament has been very carefully engineered to have the same chemical composition and long life as the original item. Each tube has a serial number engraved in the base and is packaged in a beautiful box, complete with an owner's manual, data sheet and individual response curves for each tube.

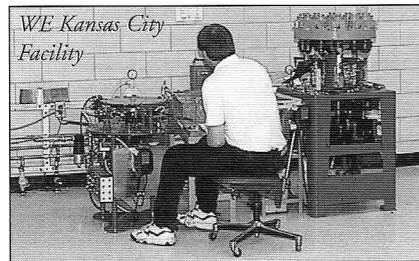

The wait was worth it, as the tubes performed just like the original vintage WE300Bs from the 1950s and 1960s we listened to. The new 300B had excellent imaging, was smooth and balanced sounding. It had convincing low and mid-bass response to boot. The new WE300B is very musically involving and



does everything right. Whitener has priced it at \$350 retail and \$800 for a matched pair in classy walnut wood presentation boxes. With a price like that, the question is - will it have the same long service life as the original WE300B?

The Winner Is -

Since the 1970s, most of the vintage 300Bs have been exported to Japan and other Asian countries, creating a shortage of this once fairly common tube. 1997 retail prices of vintage NOS 300Bs start at around \$750 each in the US and are about \$1250 each overseas. With the new WE300B now available and guaranteed for a year, the winner was not too hard to determine. If you have the bucks to spend and want the finest and most musical 300B, go with the new Western Electric 300B. It is a most satisfying tube to listen to for long periods of time. When you plug a pair of these into your amp to replace Chinese 300Bs, the sonic improvement will be astounding. You will want to listen to all your favorite tunes again and again.

An extremely close runner-up is the Svetlana 300B. Although production has just begun, this tube is very involving and three-dimensional sounding. We certainly encourage Svetlana officials to get this tube to market as we think it is definitely a top performer.

The second runner-up is the Cetron 300B. Since our first evaluation of this tube, we have noticed a significant improvement in the quality and sound. It is priced at roughly half of the new WE300B and will last significantly longer than the Chinese tubes.

A special thanks to: Charles Whitener, Western Electric; Jerome Czakowski, Richardson Electronics; Eric Barbour, Svetlana; and New Sensor Corporation.

The AudioNote Kit One-A Quality Single-Ended Amplifier Kit

By John Atwood © 1997

AudioNote UK, one member of an international group of companies making esoteric audiophile equipment, has come out with a reasonably-priced 300B-based stereo power amplifier, the Kit One. At a list price of \$1395, it is not the cheapest 300B kit on the market, but its design is sophisticated and its sonics are quite good.

It is clear that the Kit One's designer knows amplifier design well. The driver circuit is unconventional: a single section of a 6SN7GT drives the volume control, which then drives a 5687 (dual triode) SRPP active plate-loaded stage. This then drives the 300B. No feedback is used. The fact that the volume control is after the first driver stage is unusual, and could cause overloading if an especially high output device drives the amp, but no problems were encountered in any of the systems tested. Paper and copper foil oil-type AudioNote coupling capacitors are used. The output transformer is an AudioNote proprietary type with 4 and 8 ohm outputs.

The power supply uses a 5U4G rectifier tube. A capacitor-input pi-filter with a nice large choke is used for the B+ supply. With the exception of the main filter capacitor to the 300Bs, each stage uses separate filter capacitors. These filter capacitors are bypassed by small Danish paper-oil type capacitors. The only semi-conductors are in the filament supplies for the 300Bs (one for each tube). These

are regulated using 7805-type three-terminal regulators. The filaments for the driver tubes are AC and are distributed by twisted pair wires kept away from the main circuit board.

In general, the design quality and component quality is good. As noted above, audiophile-grade paper-in-oil capacitors are used, as are metal film resistors in all critical locations. Three fiberglass PC boards are used, and are of reasonably good quality. The 5U4G and 300B sockets are mounted directly on the chassis, while the driver tubes are on the main board, but quite securely fastened. The 5U4G and 6SN7GTs are surplus Russian types that are the same as today's Svetlana 5U4G and Sovtek 6SN7GT. The 300Bs are metal-plate Chinese, stamped "AudioNote." The 5687 is a US military surplus (Philips ECG, formerly Sylvania) JAN type. The chassis is textured black powder-coated and nicely made. A perforated cover is available as an option, although our unit came without it. Gold RCA input jacks and AudioNote-branded binding posts are used.

The overall external appearance of the Kit One can best be described as "English Industrial." The transformers and choke are of an open-frame type unique to the

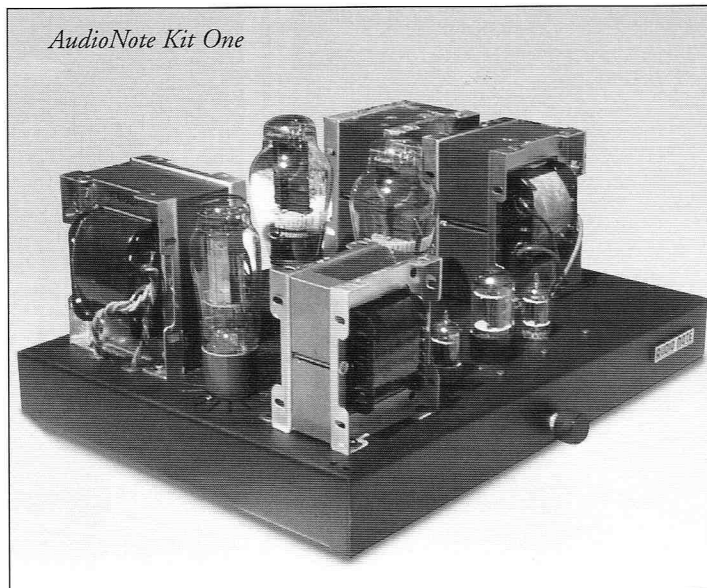

AudioNote Kit One

British empire. I find them fairly unattractive, but some people like them.

A key to any kit is the quality of the instructions. Only a seasoned technician can make a bag of parts without instructions into a working unit, while with good enough instructions, nearly anyone can be successful. The Kit One's instructions are better than many on the market today, but don't match the level of, say, Heathkit's. There is a good explanation of the circuit and design philosophy, followed by step-by-step instructions. While reasonably complete, the instructions can be vague on things like mechanical mounting techniques. This is not a kit for the absolute novice or someone with poor mechanical skills. There are a few places in the mechanical design that are deficient; an example being the hand-modified phenolic terminal strip clamped under screw heads near the 300B sockets that hold the 300B cathode resistors and bypass capacitors.

The Kit One's schematic and parts list is fairly confusing. Each board has its own parts list, and reference designators (i.e. R1, R2, etc.) are reused on each board. As a result, there are multiple R1s, R2s, etc. Tracing the circuit out is more difficult than it should be.

Once the kit was put together, it worked right away. It has plenty of sensitivity and it has essentially zero hum. This is a good example that careful filament wiring can allow AC to be used on driver tube filaments. The DC on the output tube filaments is important here, too.

The consensus on the sound of the Kit One is that it is very listenable, with a

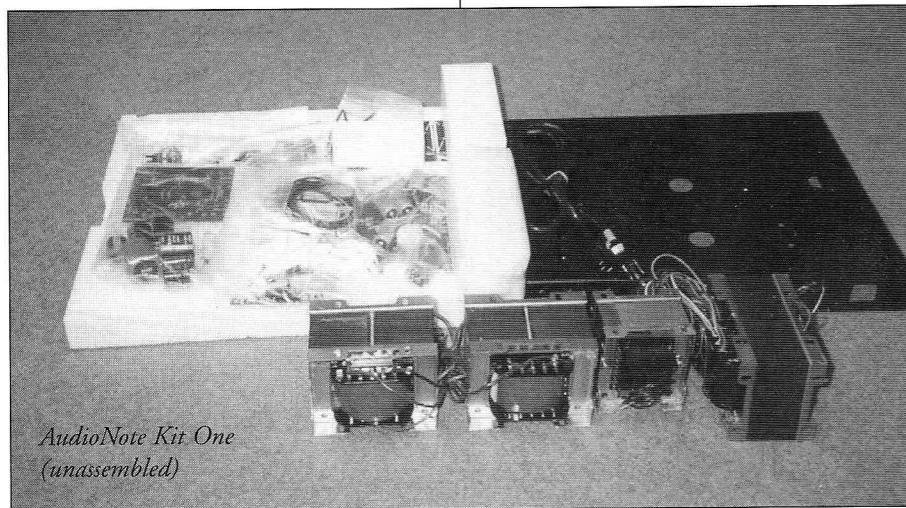

AudioNote Kit One (unassembled)

UNCLE ERIC'S DUMPSTER #3: 12SX7

By Eric Barbour © 1997

romantic mid-range. Some people thought it was the best single-ended amp they had heard, but others, including myself, felt that the frequency extremes - deep bass and highs above 10KHz - were somewhat lacking or unclear. However, the tonal balance is appropriate, and any defects tend to make the amp more rather than less listenable. Being a no-feedback amplifier with a resulting low damping factor, matching to a speaker can be a little tricky. It worked well with our B&W 110 and Klipsch Choruses, as well as an Altec "Voice of the Theater" at the Randall Museum. However, one listener with a Lowther speaker reported insufficient bass.

A few minor quibbles on the Kit One: there is a 100 ohm resistor isolating the signal ground from the chassis/power ground. This may cause noise or low frequency oscillations in the signal in some systems with poor grounding. Shorting out this resistor is worth trying. The volume control is a small Asian dual log pot that has tracking error at low settings - which results in poor balance at these settings. Unfortunately, there is no room under the chassis to replace it with a larger pot.

We did have one reliability problem: after about one month of use, the main filter capacitor, a 220 µF, 500 volt electrolytic marked "AudioNote Audio Grade," started making loud snapping sounds, and blowing fuses. Eventually, the capacitor became a dead short. I replaced it with a British LCR-brand capacitor (2 x 100 µf, 500V, with the sections paralleled), paralleled with a 0.47 µF polypropylene capacitor. This did not appreciably change the amp's sound. The original capacitor was surprisingly small for its ratings (about one third the size of the LCR capacitor).

Despite some minor problems, we can recommend the AudioNote Kit One to serious constructors. It showcases the good aspects of the 300B output tube in a compact, reasonably-priced, well-designed amplifier.

Note: On August 14, 1997, AudioNote UK Ltd. underwent a financial restructuring and is now a stronger organization to handle the growing tube audio market.

US Dealer: Angela Instruments,
10830 Guilford Rd., #309, Annapolis
Junction, MD 20701 - (301) 725-0451

Thanks go to David Wilner and members of the Bay Area Tube Enthusiasts for critical listening and feedback.

The 6SN7 was a major introduction in 1939, and became a standard for medium-mu dual triodes. Many types that were popular in audio were directly derived from it: 6CG7, 6FQ7, 12BH7, 6BX7. Yet the early history of this family was more concerned with war than with good sound.

In 1946, RCA introduced a version with a 12-volt heater intended for use in 26-volt military aircraft radio equipment. Although similar in physical construction to a 6SN7, the 12SX7(VT-207) was specially processed and characterized to run with a plate supply of 28 volts. The 12SX7 was used in a few radios and was obsolete by 1955. Very few audio experts have even heard of it.

This is one of the cleanest-sounding dual triodes in existence. It is never found in any kind of box other than military JAN tan. Any 12SX7 can beat even the best 6SN7s. It was made by Ken Rad and RCA, although GE is said to be an original manufacturer. (This appears to be one of those types that was made by GE under contract to RCA.)

New-in-the-box 12SX7s are often discarded as "useless," because there are foolish people who like to claim that 12-volt heaters have some kind of mysterious sonic penalty that 6-volt heaters don't

have. Operation of the heater on DC will take care of this peculiar claim, as the gurus babble that hum induction into the cathode becomes "uncontrollable" above 7.5 volts.

This bizarre statement is made more often than you would think, and it automatically condemns classic tubes like the 12SX7 to the landfills. The same goes for the neglected 12SN7, although the 12SX7s that I have tried were superior to any SN7 type. Another reason for discarding them is visual inspection; most 12SX7s were heavily burned in before shipment, resulting in shiny "getter spots" on their tops, directly over the cathode ends. This is also seen in some old 6SN7s, 6SL7s, 6J5GTs and other tubes.

It is often assumed by the ignorant that these spots indicate an old, used tube which will test weak. It is an amusing trick you can play on radio collectors, in order to coerce them into parting with their fine NOS 12SX7s at a low cost.

This series of articles is intended to focus a spotlight on tube types which are commonly ignored today. Many things were made over the last 60 years which were well-suited for audio use, but are rarely or never seen in audio. I hope that my series will prevent valuable NOS tubes from being discarded before they bring beautiful music to someone's ears.

12SX7s - Ken Rad, RCA VT-207 and RCA (mid 1940s)

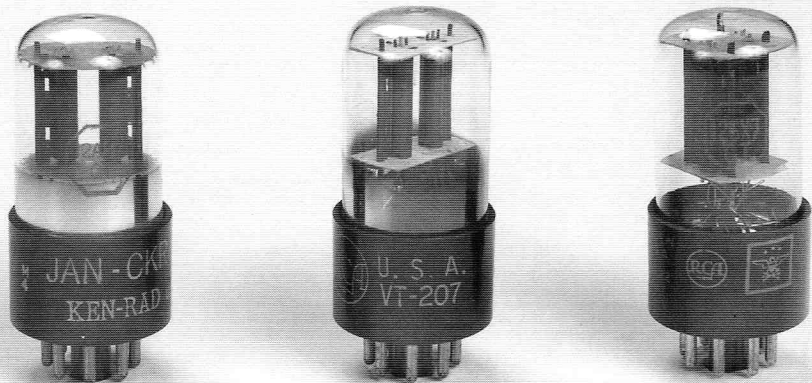

An Interview with Bruce Moore

A Tube Hi-Fi Pioneer and Renowned Audio Designer

Part 1 of a 2-part interview

By Charles Kittleson © 1997 All Rights Reserved

In the early 1970s, Bruce Moore and Audio Research were the only two companies manufacturing high-end tube audio equipment in the US. This interview covers the various companies Bruce worked for including Precision Fidelity, Paragon, Audible Illusions, MFA, etc. It also covers his design approach and component preferences. Bruce has a new tube electronics company called Bruce Moore Audio Design (BMAD) and he will be an exhibitor at the Winter 1998 Consumer Electronics Show in Las Vegas. (VTV ed.)

Bruce, when and how did you first become interested in electronics?

It was in 1962. A friend of mine had an older brother who built a mono system with a Grommes 10 watt amplifier and a twelve inch speaker. My friend played it for me one day and I was blown away with the sound. Then he cranked it out and it played real loud and sounded a hundred times better than the system I had at the time. We used to ride our

bikes down to the big hi-fi store after school. It was called IHF Electronics. They had Citation kits, stuff from H.H. Scott, Empire, Fisher and others. We were like kids in a candy store-only that it was hi-fi and definitely out of our price range. It was then that I decided to buy one of these amplifiers.

Where were you living then?

In Southern California, Van Nuys. In 1963 I bought my first tube amp kit by mail order for \$19.95! It was a 6V6GT 12 watt push-pull open chassis design. The cover and bottom plate were optional. In 1965, I thought I would try to scratch build an amplifier. I purchased a few Greenlee chassis punches and a Bud radio chassis. I copied a circuit from a 1945 Sams Photofact. It was push-pull 6V6 with 6J5 drivers. At this time, I wanted to try to understand how this electronics "stuff" worked. I read a few books on audio electronics and started to purchase Sams Photofacts on amps and

preamps by McIntosh, H.H. Scott, EICO, Fisher and a few others. I was really influenced by the commercial ads in hi-fi magazines, searching specifications and comparing them. Solid-state hi-fi was starting to replace the

tube gear, but it was too expensive for me, so I stayed with tubes. Later on I listened to some solid-state hi-fi and it had a negative impact on me. It sounded more "controlled," but lacked any emotion. Around 1967 I purchased a used Dynaco Mark II because I wanted more than 12 watts of power. I wasn't happy with the sound so I decided to build a new amp using the Dyna transformers. I scratch-built the amplifier using the Harman-Kardon Citation II circuit with Dyna iron. It sounded much better.

So that was really your first amplifier design?

Yeah, but it was basically one channel of a Citation II.

Bruce, what was one of your favorite commercial vintage tube amplifier?

Well, believe it or not, I like the McIntosh power amps - probably because they looked great and the circuit was very unique.

Did you ever attend college?

Yes, I went to Cal Poly in San Luis Obispo, California in the late 1960s and early 1970s.

What was your major?

Electronics of course.

What was your first job after you graduated from college?

I went to work as an engineer for an aerospace electronics company in Palo Alto, California.

When did you get back into tubes again?

One day, I think it was in 1974, I stopped by a hi-fi store in Palo Alto on my lunch hour. I noticed they had a rack of equipment and then I noticed something glowing. It was new tube equipment from a company called Audio Research. I couldn't believe it. And I was thinking to myself, maybe some guy thinks like I do. I took a color brochure back to work and showed it to a couple of engineers that I worked with. They were a bit older than I was and they were on the floor laughing!! They said this guy, whoever he is, must be some TV repairman who didn't know anything about transistors. This got me thinking-if somebody is building and selling this stuff, maybe I could too.

When did you first get into the tube audio business?

Bruce Moore M125 Power Amplifier



Paragon Model 12 Preamp



facturing. I had a little business called Alien Audio and made some custom line stages and phono stages for customers. Some of this stuff ended up in Europe.

So, I quit my job and started working for Precision Fidelity of Foster City, California. The Precision Fidelity pre-amp designated C-4 was a cascode circuit with active loads, current sources and a regulated B+ supply. The C-4 used 12AX7s, 12AU7s and 12AV7s whereas the Paragon 10 was all 12AX7s.

In 1978 Joe Bermudez was hired to do sales. He used to be with Threshold. I designed a less expensive preamplifier and called it the C7. It was just a high gain C4 phono stage with a passive line section. They made a lot of these and sold quite a few.

What else was going on at Precision Fidelity?

Well, that's an interesting thing. I just met Scott Frankland at this time. He just came in one day. He had a Paragon pre-amp with him. He wanted somebody to work on the Paragon, to update it, and maybe modify it. This was in the Spring of 1979 and I had the urge to start my own audio company. So I left Precision Fidelity and with two other partners started Audio Illusions in Santa Clara. However, it turned out that there was a guy in San Diego building speakers using the same name so we had to change the name to something else. So one of my partners came up with the Audible Illusions name. Our first product was called the Dual Mono Preamp. It was a constant current phono section with a simplified line section. It used 12AX7s and 6DJ8s. This was the first time I used 6DJ8s in a production piece.

What other Audible Illusions products were sold at this time?

We came out with a power amplifier called the Mini-Mite II. This thing put out 45 watts per channel and used EL34s. Also, going back to 1979, we built a three tube Mini-Mite preamplifier that was available in kit form as well for \$399!

Were you working with Scott Franklin at Audible Illusions?

No, that came later. But we did the Duo-Mono, and then we did an amplifier that I called the M80, which was an 80-watt, nearly Class A, for 6550s. They were mono-block amplifiers. I didn't make very many of those. They were \$2500 retail; which isn't much today, but back in the early 80s, it was quite a bit of money.

Who was making your transformers back then?

What other things were you doing at Alien Audio?

I did mods on vintage tube gear. This included widening the bandwidth of line stages, improving the power supplies, etc. Alien Audio wasn't really a company, it was kind of a name. Kind of a funky little anecdote to Paragon.

But in 1977 I was back in aerospace electronics and some interesting things started to happen. I was starting to experiment with more sophisticated type circuits using active loads as well as tubes used for constant current sources. I also experimented with cascode topology. Also, at this time, I built my first direct drive amplifier for the Stax SRX series electrostatic headphones. I sold a few to some friends and some to the Threshold Corporation in Sacramento. I built my first high power tube amplifier which was a 200 watt unit using 8068 television sweep tubes. Also, I built several octal base tube line stages and phono stages for select customers. 1977 was the year I built an all Nuvistor phono stage--it was very quiet!

In the summer of 1977 I put together a prototype twelve tube preamplifier. Later, I was introduced to a man named Johnny Fong by Joe Bermudez. Johnny Fong wanted to start an audio company and manufacture my twelve tube preamp.

I answered an ad from some guy who was selling some audio transformers. I went over to his place and since audio was his hobby also, we talked. We discussed tube audio and Audio Research. He asked me if I could design a tube pre-amp better than the Audio Research SP3A. I said, if you can get me a schematic I'd look into it. He did and I looked it over and studied it. I told him I thought that I could design something better. This was in 1975. I ended up building a prototype using cascode circuitry. The unit had a complete set of tone controls as that was the way it was usually done at the time. He started a business to build the preamplifier I designed, calling it the Paragon Audio Model 10. The first Paragons were hand wired. The later edition, Model 12, used a circuit board.

The first ones were pretty crudely made, but they sold. The first Paragon dealer was Dynamic Specialties in Redwood City, California. Anyway, at this time, to the best of my knowledge, there were only two companies in the US building tube hi-fi: Audio Research and Paragon.

What happened after that?

Well, I was not an employee of the Paragon Company as I was working in aerospace. In 1976 I left the aerospace industry to pursue custom audio manu-

Precision Fidelity Preamplifier





Audible Illusions Preamplifier

Actually the same people that make them for my current company. Excel Transformer in Oakland, CA makes the power transformers and Zambre & Co. in Mountain View, CA makes the output transformers.

I have never heard of these companies.

No, you probably wouldn't. Although, I think Dick Brown introduced me to Excel transformers in the late 70's when I had Audible Illusions going. I think he used them for the transformers for the Bell 2001. The thing about his transformers is that they don't buzz like a lot of them do, and you really can't sell high-end equipment with buzzing transformers. They just won't put up with it, especially overseas. Well, anyway, as far as Audible Illusions goes, a man introduced himself to me or somebody introduced him to me. In 1982, I was doing it alone; my partners had dropped out of the business. 1982 was a terrible year for audio. There was a recession going on. Sales dropped way off for me. I even had to take another job for most of that year. I was getting up at 5:30 in the morning, going over to Audible Illusions, working until 8:30, going to my regular job, coming back on my lunch hour to take phone messages, going back to work, and then coming back after work, and working at Audible Illusions till 6:00 or 7:00 at night, and then going home. Actually, it worked out pretty good, because there wasn't

enough work really at that time for me to be full time. And since I had another job, I had a paycheck, so I could pay my bills. So anyway, in the Spring of 1982, I was introduced to a gentleman named Mr. Art Ferris, who at that time was apparently exporting vintage McIntosh and Marantz equipment to Japan and Asia, at least that's what he told me.

I met him at his house where he had a really lavish display in wooden cases with glass doors and all of the classic Marantz stuff; and in another case was the McIntosh stuff; and he had one of those Micro-Seki turn-tables with the three tone arms. It was really an impressive-looking display. Anyway, he wanted to do the marketing for Audible Illusions.

So he kind of took over the company. He had a way of wanting complete control over everything with the company, including myself. I am just not the kind of person that wants to be controlled; you know, to be told when and where I can go to lunch, or something. It's crazy. Anyway, we went to the CES show in Chicago in 1982. We exhibited with the Acoustat, and Barry Streets, who had a solid-state electronics company, was also represented by Mr. Ferris. And Scott Frankland was there, selling Leo Kulka's records. I left the company shortly thereafter.

When was MFA formed?



MFA Luminescence Preamplifier

I teamed up with Scott Frankland and we formed MFA in the late Spring of 1983. At MFA we came up with the Luminescence preamp which was our first product. The Luminescence has some history behind it. Back in 1976-1977, I was building custom stuff. The customer would require octal base tubes. This was before this craze that's going on now for octal tubes. I was doing that even in the 60s. I was selling equipment to select customers with 5691s and 92s and L7s and 6SN7s and 6BL7s, which is one of my favorite tubes for a driver tube for a power amplifier. And of course, the miniature equivalent of that is the 5687. I've been using it for a long time. The plate dissipation of the 5687 is downrated because of its smaller bulb size, but it is basically the same thing as the 6BL7. So the Luminescence was sort of an evolution of this preamp that I was building in the 1970s which was called the Venusian.

Some of my custom stuff, I gave real quirky names to. I had a political series-- I had one called the Tricky Dick. And one was called the Ayatollah. And another one was the Reverend Jim and on the back it said, "Made in Guyana." I guess I mentioned the Ayatollah. And then there was one called the Planet Xenos. There were a few others, I can't remember the names.

These were individual ones, or designs that you've done?

They are one-of-a-kind preamps. Each one would be a little different; I would want to try some new idea. So, now you can breadboard something, but you can't tell what it sounds like from the breadboard. All you can get are the technical specs off of it. So I would build them up with a decent faceplate. They would all be different, and they would look different. And they were all sold off as prototypes. There were only a few years that we were doing this.

This was, of course, during the early 1980s?

Well, this was actually Audible Illusions. We did a couple of prototypes with MFA, but the Luminescence preamp was really the result of the Venutian, but it wasn't duo-mono. The Venutian was actually a quad-mono preamp. It had a separate phono stage and a separate line stage and they were duo-mono in themselves.

Was this the era when you had the separate power supply?

Yeah, that's the way--well, some of the Venutians had the power supplies built in. Some of them were separate. But the Luminescence had its own separate power supply. It always did, from the very beginning. Because it was a high-gain preamp that was supposed to work with a .3 mV moving coil cartridge straight in. Luminescence sold pretty well over the years; there were several different versions of it; there was a B and a C. I don't even know exactly what the B and the C version is; they never told me.

What was the year of introduction for the Luminescence preamp?

1983.

What did it sell for?

It was under \$2500. And then we made the power amp. At that time we were making 75-watt monoblocks with Dynaco Mark III transformers which we scrounged up--we would go with about a pair a week or so. We sold off quite a few of those. Then later on we had custom transformers made when we could afford to do that. The early M120s were built with Citation II transformers; and the M200s were custom transformers; and the later M120s were custom transformers. Then we built this 75-watt per channel stereo amplifier also. This was all going on during the period from about 1984 until 1990, 1991.

Tell us a little bit about the Luminescence circuit, the tubes, and so forth.

Well, the Luminescence, in the first stage, used two 5691s per channel, and they were all in parallel, so you got four triodes in parallel to get the noise down a little bit. I used the dissimilar triodes the 6EM7s in the phono, which was like one-half of the 6SL7 and it had a low mu power triode as the other half. And the line stage used a 6SN7 or 5692. They

were a little hard to get at that time. It was kind of sporadic. But we used, I think, a 6DN7. That is another dissimilar twin triode. The low-mu triodes we used as cathode followers. They make pretty good-sounding followers.

Did you find any--of those tubes, were there any specific brands that you liked better than others, in terms of sound?

I liked the RCAs, GE's were okay. Sylvania's were terrible sounding. I've never liked Sylvania tubes, except for perhaps some of their 6550s.

So, talking about small signal tubes, do you prefer RCA over, like GE or Tung-Sol?

Well, the Tung-Sol tubes were hard to find, even back 10-12 years ago. I think that company went out of business in the early 1970s. There are a lot more Sylvania, RCA, and GE surplus NOS type tubes available than the Tung-Sol.

Where were you getting your tubes back in the MFA era?

Some from Richardson; some of them were from specialty-supply houses that dealt with hard-to-find tubes. We found a box of 5692s, a bulk pack, up in a loft in a surplus store in the Bay Area one day--just a random find, which was a shock. I think they wanted a buck apiece for them, when the going rate was about \$20. We really made out like bandits on that one.

What is better about a 5692 or a 5691 as compared to a 6SN7 or a 6SL7?

Well, the 5691-5692 are supposed to be a 10,000-hour tube. They are a ruggedized military version. They have metal struts between the mica wafers which are supposed to help with vibration and stuff and I think they are shock-rated, too. Actually, they are tubes that were developed in the late 1940s for airborne-type

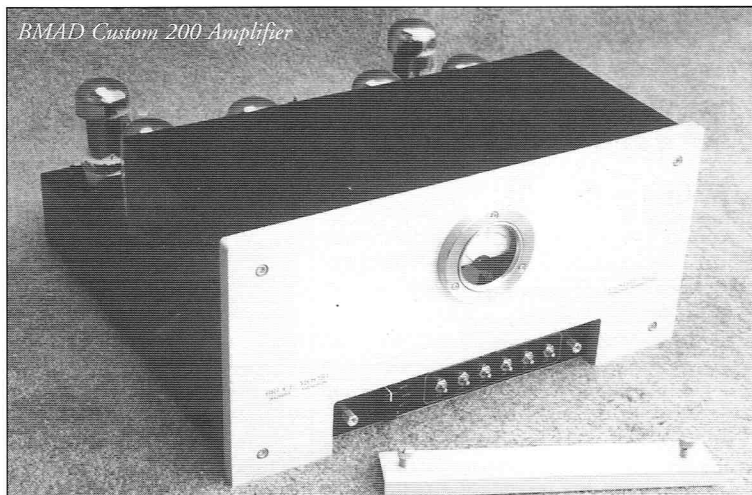

BMAD Custom 200 Amplifier

military applications. They have to be subject to a lot of stress in an airplane--vibration and whatnot. They also had a higher filament current.

Did you ever use any import tubes such as Telefunken, Amperex Bugle Boy or Mullard?

Well, back in the Precision Fidelity days, we used Mullard tubes. You could still buy those from Richardson Electronics. We used Mullard 12AX7s and 12AU7s and GE 12AV7s as cathode followers. And at Audible Illusions we used a combination of Mullard and Dutch Amperex tubes. That is sort of a magical combo. This was the way we fine tuned the Audible Illusions products.

When did you leave MFA?

In 1991 I was notified by MFA management that they no longer needed a full-time engineer. So I left the company and started BMAD in early 1992. BMAD products consisted of a two tube line stage preamplifier and a 60 watt per channel tube amplifier. Later, I came out with 125 and 225 watt monoblock power amplifiers. Then I made a deluxe 10 tube preamp, called the Dual Mono. It used the usual 12AX7s, 12AU7s, 6922s and 5687s. The circuits I use are basically improved versions of earlier circuits. I stress a very wide frequency response to minimize or eliminate phase shift in the 20-20,000 cycle range; reasonably low THD and IMD. The amplifiers all have a damping factor greater than 10. I will be introducing a new line of electronics at WECS, 1998. Of interest, I will have a 20 watt push-pull, Class A 300B amplifier on display.

Part 2 of interview to be Continued in VTV #9



MFA M200 Power Amplifier

The Audio Test Bench Distortion Analyzers Part 1

© 1997 All Rights Reserved

The Audio Test Bench

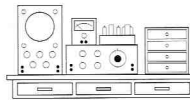

by
John Atwood

Up until now, the instrumentation described in this series has been fairly general and could be used in many fields aside from audio. In this issue we will look at equipment specifically designed to design and test audio devices: distortion analyzers and related equipment. The issue of distortion measurements is controversial: to some it is the only way to judge equipment, to others it is the single thing that has taken musicality out of contemporary audio. Given the importance and complexity of this area, the article on distortion analyzers will be broken up into three parts: 1. History and philosophy, 2. Descriptions of representative analyzers, and 3. Interpretation of results.

Distortion is any alteration of a signal and can include changes in frequency response, uneven level and non-linear behavior. In the audio community the term "distortion" generally means non-linear distortion. Sometimes called amplitude distortion, this type is characterized by curved transfer curve (hence the term non-linear), i.e. the gain from input to output varies instantaneously with signal level.

The Types of Distortion Analysis

Scientists realized, even before the advent of electronics, that non-linear devices would take a pure sine wave and generate harmonics from it. Engineers who studied early electronic systems used instruments called "Wave Analyzers" (named because they isolated different wavelengths) which were basically very sharp tunable filters connected to a sensitive AC voltmeter. Later versions were implemented as superheterodyne receivers that converted the audio signals up to an intermediate (IF) frequency, typically 100 KHz, where very sharp crystal filters would isolate the the desired frequency. While useful for checking the amplitudes of various harmonics, using a wave analyzer is tedious, requiring constant manual tuning.

For field service and general testing, a simpler system was needed. One technique is to simply take the amplitude of all the harmonics together, and subtract out the fundamental. What is left is the Total Harmonic Distortion or THD. Actually, these measurements are typically THD+N or THD plus noise, since the background noise comes along with the measurement. At low signal levels, residual noise is often higher than the distortion products.

Harmonic distortion analyzers use a very sharp notch filter to remove the fundamental. Early harmonic distortion analyzers were typically just a tunable notch filter followed by an AC voltmeter. The user would have to supply the sine wave oscillator, and manually tune the oscillator and very carefully analyze for a notch at the fundamental frequency. The oscillator would have to have very low distortion, since any residual oscillator distortion would show up in the THD reading (see VTV #5, p. 20 for a discussion on low distortion sine-wave oscillators). By the 1960s, most THD meters had built-in low distortion oscillators, and the better ones included auto-null circuits that eliminated the tedious manual nulling procedure.

The intermodulation (IM) distortion analyzer (sometimes called a cross-modulation analyzer) measures distortion by an entirely different means. It measures the ability of a non-linear circuit to modulate one frequency by another to create non-harmonically related distortion products. Another way of looking at this is by realizing that a perfectly linear system will pass two different frequencies unaltered, with no interaction between them.

Non-linearity will cause the two signals to modulate each other, producing a series of sum and difference frequencies. The intermodulation distortion analyzer generates two frequencies, passes both through the system under test, then filters out one or both of these frequencies. If intermodulation occurs, it will generate frequencies outside of the filtered-out frequencies, which are then measured by an AC voltmeter.

Intermodulation testing was very useful in the optical sound film industry. Some people also feel that intermodulation distortion measurements more accurately reflects the ear's sensitivity to distortion. Tradition has kept THD as the primary distortion measurement, but IM measurements are a close second. There are two main types of IM distortion measurements: the SMPTE (Society of Motion Pictures and Television Engineers) method and the CCIF method. The SMPTE method uses a high frequency and very low frequency in a 1:4 amplitude ratio. Typical frequencies are 7 KHz and 60Hz. The CCIF approach uses two high frequency signals with a fixed difference in frequency, say 13KHz and 14KHz. The primary intermodulation product will be the difference between the two, or 1KHz. The CCIF measurement is the level of this 1KHz signal.

SMPTE measurement primarily tests for IM at low frequencies, while the CCIF tests for IM at high frequencies. The CCIF method has the disadvantage of not responding to symmetrical (odd-order) distortion, such as generated by magnetic tape recording.

The next level of sophistication beyond simple "one-number" measurements is the spectrum analyzer. This is basically an automated wave analyzer that plots that amplitude of a signal versus frequency. Such a visual presentation gives a quick way of seeing the nature of the signal, whether it is noise or the harmonics of a sine wave. The first audio-fre-



Heathkit IM 5248 Intermodulation Distortion Analyzer

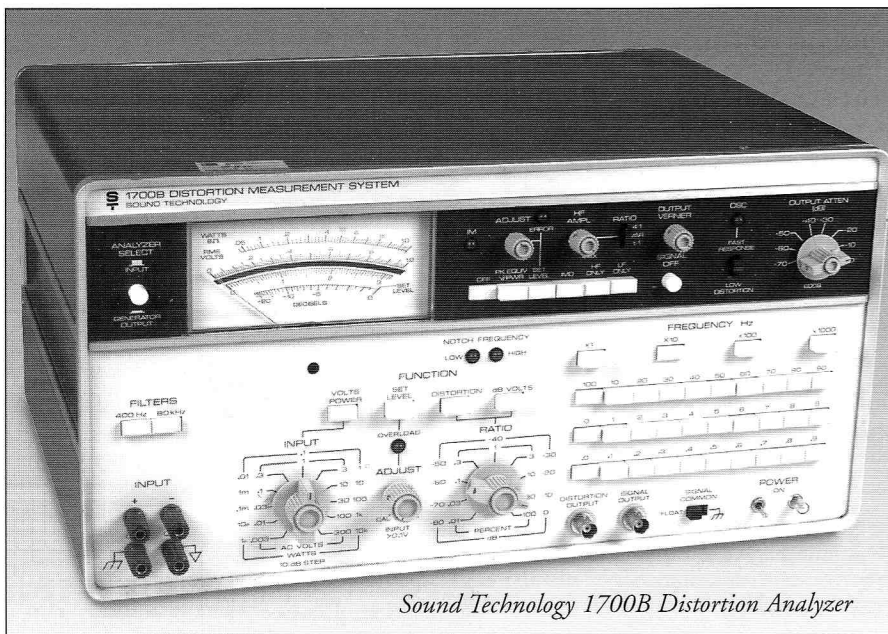

Sound Technology 1700B Distortion Analyzer

quency spectrum analyzers were based on early RF analyzers (sometimes called Panadapters), with the frequencies and bandwidths scaled-down. A big problem with this is that a receiver with a very narrow filter (typically 1 Hz or 10Hz in an audio spectrum analyzer) has to be swept very slowly. Sweeps could take many minutes, requiring a special long-persistence oscilloscope screen or a storage scope, both of which have hard-to-see screens. Another alternative was a pen plotter. By the late 1970s, digital storage could provide the screen refresh, but the long sweep times were still a problem.

An alternate way to look at the frequency spectrum is to apply a signal that stimulates all frequencies in a system (such as a step function), then convert the result from the time domain to the frequency domain. This technique, called the Discrete Fourier Transform, allows conversion between the time domain (what you would see on an oscilloscope screen) and the frequency domain (what you would see on a spectrum analyzer), but the math required is very tedious. In the 1950s, a computational technique was developed that greatly shortened the time needed to do the Fourier Transform. Called the Fast Fourier Transform (FFT), it became a cornerstone in the art of digital signal processing. FFTs were initially mainly used in military projects, but by the 1970s, computational power was getting cheap enough where commercial instruments could start to use FFTs. Companies such as Spectral Dynamics Corp. and Hewlett-Packard introduced FFT-based analyzers that could take spectrum readings almost instantaneously.

Equipment History

In the early era of audio amplification, it became clear that non-linearities in tubes could cause undesirable distortion. Outside of a research lab, most people treated this distortion qualitatively, for example, rating an amplifier in watts of "undistorted output." However, two commercial developments during the 1920s created the need for distortion test sets. The first was the advent of carrier phone line multiplexing, where multiple phone conversations were carried on a single line by modulating them at different ultrasonic frequencies. Amplitude distortion could cause leakage between phone conversations. For field maintenance and testing, distortion tests were needed on a large scale.

The other big development during the 1920s needing distortion analyzers was the advent of recording sound optically on film. It was found that incorrect film processing resulted in very distorted or garbled sound. Testing for intermodulation distortion was a good way to spot check that the film had been processed correctly.

In the 1930s, the radio broadcast industry matured and the Federal Communications Commission (FCC) began to set down broadcasting standards that included maximum allowable harmonic distortion. Soon every radio station had to have an accurately calibrated distortion analyzer. By the late 1930s, audio engineers were being concerned about the measured distortion of their equipment. Typical maximum harmonic

distortion requirements were 1%. From the 1950s to the late 1970s, analog distortion analyzers became more sophisticated and sensitive, cumulating in analyzers capable of measuring to 0.001% and below.

During the 1970s, advancements in distortion analysis began to get out of the reach of hobbyists and commercial shops. Spectrum analyzers covering the audio range – something always difficult to do with conventional analog technology, started being replaced by digital FFT - based analyzers. At \$50,000 or more, these could only be afforded by well-funded industrial or government labs. However, they set new standards in analysis, permitting a much better look at the nature of non-linear distortion.

In the 1980s, the spread of cheap and ever more powerful personal computers brought significant computational power to individuals and shops. Audio input boards allowed rudimentary FFT analysis to be done on the PC. By the 1990s, even the best analyzers were PC-based, although usually with an outboard box containing high-quality analog front-end circuits and digital converters.

The Evils of Distortion Analysis

With all the commercial needs for distortion test sets, and as one of the main ways of distinguishing consumer hi-fi equipment, why would anyone consider distortion analysis evil? Many esoteric audiophiles reject distortion measurements out of hand, and they are reacting for valid reasons. A simple harmonic or intermodulation distortion figure is a crude way of evaluating a complex system. However, without anything better, it is one of the few numbers people can use to characterize a system. Many people get fixated on such numbers, and soon the art of audio system design begins to degenerate into a quest for better and better numbers. The linkage between distortion measurement as a means of measuring perceived sound and an arbitrary figure of merit for a system became broken. How did this happen?

Before World War II, a general rule of thumb for consumer radios and phonographs was that 5% harmonic distortion was the maximum "acceptable" distortion. This was reflected in the power ratings of tubes up through the 1950s.

With the advent of commercial high-fidelity after the war, low distortion was recognized one of the requirements of a "hi-fi" system. For the 1940s, 50s, and

early 60s, maximum distortion figures of 1%, equivalent to professional standards of the time, were considered good, and very few engineers were concerned with distortion of less than 0.1%. However, as consumer hi-fi became more of a game of "specsmanship," manufacturers continued to try to reduce distortion numbers, typically by increasing negative feedback. Despite heroic efforts, such as the Harmon-Kardon Citation II, transformer-coupled tube power amps resisted high feedback.

The big breakthrough in lowering distortion numbers came with the advent of transistor power amplifiers. Without the troublesome output transformer, with both PNP and NPN polarities available, and with the availability of relatively high-speed silicon power transistors, feedback could be increased dramatically - typically to 60 db or more. By the 1970s, ultra-low distortion amps with numbers like 0.001% became a reality. These low numbers were obtained by a new generation of very sensitive distortion analyzers.

It took up to a decade for some audio-philosophers to realize that the ultra-low distortion amps were unsatisfying. Some began going back to the classic tube designs, with their 1% distortion figures. In the 1980s in Japan, and in the 1990s elsewhere, the search for more listenable sound led some to the no-feedback single-ended amplifier. Despite the use of inherently low distortion tubes such as the 2A3 and 300B, these amplifiers typically had distortion figures of 2% to 7% or more. Since numbers like these are an embarrassment by conventional standards, distortion figures are usually not given for these amps.

In some audio circles, low distortion figures are still king. In pro-audio, low distortion is desired to deliver an unmodified sound to the end user. However, a fixation with a one-dimensional measurement such as distortion draws attention away from the multi-dimensional aspect of sound.

The Sane Use of Distortion Analysis

THD or IM distortion figures are one-dimensional measurements of complex systems. To rely on them heavily would be like choosing a car based purely on horsepower or interior noise level. On the other hand, these figures do represent sonic aspects of the system, so they cannot be completely ignored. Instead of throwing out the tool completely, as some in the esoteric audio community have done, knowing when to use it intelligently makes it a valuable tool.

One of the safest uses of distortion analysis is in comparing the performance of similar equipment. As an example, the Randall Amplifier (single-ended parallel, triode-connected EL34s) has between 2.5% and 3.5% THD at 5 watts output (depending on the tubes used). When bringing up an amp for the first time, a deviation from this distortion range is a sign of a problem.

Looking at distortion versus other parameters, such as power output or frequency, can reveal circuit characteristics not readily apparent from simple measurements or waveforms. Part 3 of this article will explain how to interpret "two-dimensional" distortion measurements.

Looking at actual distortion products on a spectrum analyzer reveals distortion in yet another dimension. The ear is very sensitive to certain higher-level distortion products, and a spectrum analyzer or FFT analyzer can show these. Again, part 3 will explain how to interpret these.

By realizing that distortion analysis is really a crude tool compared to the subtleties that our ears can hear helps put this tool in perspective - useful for basic design, but not the final design criteria.

In the next Audio Test Bench: Distortion Analyzers, part 2 (a look at actual distortion analyzers).

Bibliography

1. Bob Metzler, **Audio Measurement Handbook**, Audio Precision, Inc., 1993. A good description of contemporary audio test procedures using the Audio Precision System One. The front and back covers have a great montage of past and present distortion analyzers.
2. Frederick E. Terman, **Radio Engineers' Handbook**, McGraw-Hill, 1943, pp. 939-947. A good overview of wave analyzers.
3. Howard Tremaine, **The Audio Cyclopedia**, Howard Sams & Co. 1959 and 1969. Descriptions of cross-modulation tests for optical film recording as well as descriptions of general distortion tests and analyzers.
4. Howard Tremaine, **Intermodulation and Harmonic Distortion Handbook (INT-1)**, Howard Sams & Co. 1963. Concentrates mainly on intermodulation analyzers.

VTV Visits Antique Electronics Supply in Tempe, Arizona

By Charles Kittleson

John Atwood and I visited Antique Electronics Supply (AES) in Tempe, Arizona in late July of this year. It was great to be able to see their vast inventory of vacuum tubes and all the goodies that are not listed in their catalog due to limited availability. It was like being a kid in a candy store, so we naturally searched out our favorite tubes, books and parts.

Antique Electronic Supply is a leading supplier of N.O.S. vacuum tubes as well as currently manufactured tubes. According to Greg Cravener, one of the owners, they have over 750,000 tubes in stock! AES also supplies many hard to find parts and supplies for the audio, guitar, amateur radio and antique radio restoration markets. They have an excellent variety of books and literature for any tube gear enthusiast at reasonable prices.

Antique Radio Supply was originally founded in 1982 by George Fathour who, at the time, was having difficulty finding tubes to restore an old radio. During the early years, AES's market was primarily the vintage radio field. The company grew at a fast rate over the next several years due to its uniqueness and ability to supply a wide variety of tubes.

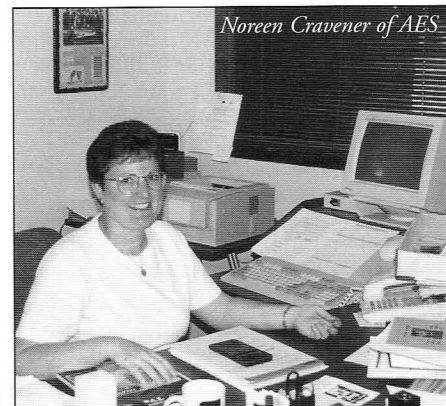

About four years ago, Greg and Noreen Cravener bought the business from George Fathour. Since then, the business has expanded into the growing

audio, guitar amp and do-it-yourself electronics markets. Greg and Noreen are constantly looking for new and unique products and components to satisfy the needs of vacuum tube enthusiasts all over the world.

Antique Electronic Supply is dedicated to maintaining its reputation for quality service at reasonable prices. Their staff is available to take telephone orders and the counter is open for walk-in business Monday through Friday from 8:00 am to 5:00 pm (MST) and on Saturday from 9:00 am to 1:00 pm. Their fax line is always open at 1-800-706-6789.

New to AES is their website! Now you can order tubes, parts, books, etc online using their well-designed and easy to use website. They have a security-encrypted site so that you will have complete credit card security. Check out their site at:

www.tubesandmore.com

AES currently employs 25 people. The work atmosphere is fun, yet the staff is dedicated to doing a quality job. Their employees are always looking for ways to improve their service to the customers. AES's inspection and testing of incoming tubes was of interest to John and I. This process has been improved with additional equipment and more "know-how." Their tube receiving department processes about 7,500 tubes per week with five employees. AES ships about 200 orders per day all over the world. They typically ship orders within 24 hours of receipt.

Their 1998 catalog has just been sent out and is now 60 pages! AES has the very best selection of books and other literature on all phases of vacuum tubes, vintage equipment, guitar amps and related topics. In addition their selection of capacitors and resistors has broadened and several new brands and values are available. Quarterly sales flyers are issued featuring new products and sale items. AES is also a full-line distributor for a number of manufacturers including: One Electron, Svetlana, Sovtek and Hammond.

Don't just rely on the ham swap meets and your local TV repair shop when you need that unusual tube for your tuner, a new set of output tubes for your amp or new coupling caps. Finding these items and much more is as easy as picking up your phone and calling AES.



Racks of Tubes in the Antique Electronic Supply Warehouse

Atma-Sphere™ Amplifier Kits: Musically Authentic!



M-60 Mk. II Kit \$2295 (Pictured)
60 Watts of Tubed, OTL Purity

*"...Breathe in and out
like the music..."*

—Art Dudley
Listener, Spring '97

Authentic? Now there's a word rarely associated with audio gear. By definition "authentic" means **genuine, pure, real, accurate**. Exactly the words describing the true note-by-note musical presentation of all Atma-Sphere audio gear. Musical authenticity begins with the designer.

Ralph Karsten, our Chief Designer, could have easily built solid state amps. Karsten, however, has the true desire to build genuinely accurate and purely transparent gear. Solid state cannot do it! Output transformers cannot do it! So Karsten engineered and patented a totally new design combining, **within each chassis**, the musicality of two singled-ended tube amps with more authoritative bass power than a single push/pull amp and with **no** output transformer to snub the music.

"...making fires in my soul..."

—Harvey Rosenberg
Positive Feedback
Vol. 6, No. 6 - April '97

* **CALL NOW** for information about our kits and full line of factory-built Class A, All Triode, Zero Feedback, OTL Amps and Preamps!

Quietly Producing The World's Finest Audio Gear!



Atma-Sphere Music Systems, Inc.

The OTL Leader, featuring Balanced Differential Design™

160 So. Wheeler, St. Paul, MN 55105 • Phone 612-690-2246 • Fax 612-699-1175
www.atma-sphere.com

Next Time in VTV #9 TRANSMITTING TUBE ISSUE!

211/845 History and Tests; SE 10K Transformer Tests; Altec 287W Monster Theater Amp; 572-3 PP 40W Amp Project; Ten Best Vintage Hi-Fi Buys; Ampeg SVT History; Vintage Hi-Fi In Japan; Distortion Analyzers Part 2; Eric's Tube Dumpster and much more!!!

Due out in February 1998

Look for VTV in Tower Books and Records, Antique Electronic Supply and other locations

All Tube Equipment Repaired



"The Fisher Doctor"
Al Pugliese
718-948-7489

VINTAGE FISHER PRODUCTS
Bought • Sold • Traded • Repaired

Howard Bardach, CET
Service Provider



AUDIO
specialist

13251 #D Ventura Blvd.
Studio City, CA 91604
Bus. (818) 995-8648
Fax. (818) 995-8647

The Eclectic Audio/Video Service Center

Tube Lore

A REFERENCE FOR USERS AND COLLECTORS

For serious users, a new look into tubes from 1920 to the present: history of design trends, "where used" information, tech data, equivalencies, "user's guide," even auction prices. See review by Eric Barbour in the Winter 1997 VTV. Contains 186 pages, 8-1/2" x 11" softbound. Orderable from:

- Antique Electronic Supply, (602) 820-5411
6221 S. Maple, Tempe, AZ 85283
- Antique Radio Classified, (508) 371-0512
PO Box 2, Carlisle, MA 01741
- Museum of Radio & Technology Bookstore
4204 Thorn Apple Ln., Charleston, WV 25313
- W7FG Vintage Manuals, (800) 807-6146
3300 Wayside Dr., Bartlesville, OK 74006

Or order directly from the author:

Ludwell Sibley
44-V E. Main St.
Flemington, NJ 08822

Price if ordered direct, postpaid: \$19.95 in US or Canada,
\$24.95 ppd. elsewhere.

Discounts available to groups on orders on quantity purchases.

Your Volume Control *makes* a difference.

the **goldpoint™** series

Ladder-Type Stepped Attenuators • Low Turning Torque
Precision Level Control • Low Noise • The Best

New!

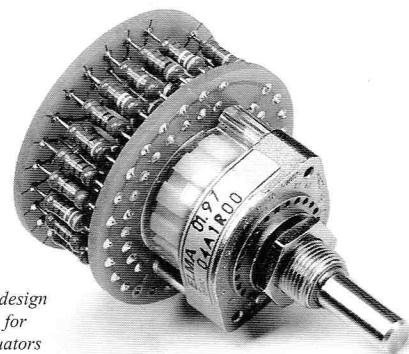

a new switch design
exclusively for
ladder attenuators

Mono - 1 deck, 24 position (shown) ----- \$137.

Stereo - 2 decks, 24 position ----- \$252.

off-the-shelf values: 600 ohm, 10K, 25K, 50K, 100K, 250K

call: **Arn Roatcap, Inc.** (408) 737-3920

1248 Valerian Court #4, Sunnyvale, CA 94086-9155

e-mail: arinc@slip.net web site: http://www.slip.net/~arinc

Small Package. **BIG SOUND.**

Alix-Anne II

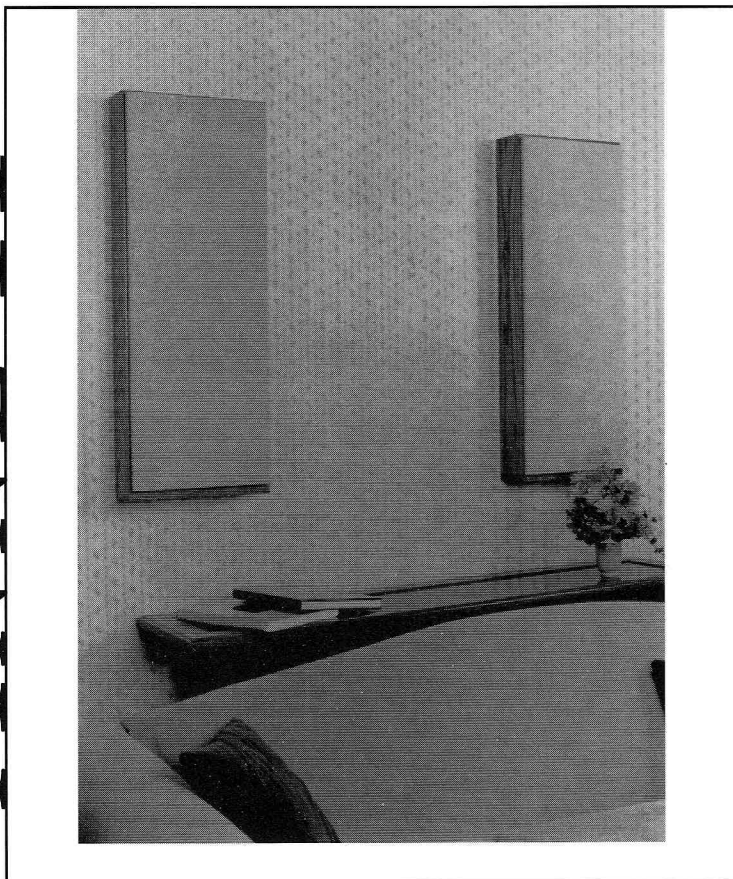

96 dB SPL 2.83v/1 meter sensitivity in a true high fidelity transducer utilizing a patented, pure first order, complimentary symmetry crossover. Suitable for solid state amps to 300WPC: or experience the magic of uncompromised performance with the SE 300B. The stable resistive load that the Alix-Anne II presents to a single ended amplifier results in a near perfect match.

Designed for operation on or in the the wall pressure zone, this wall-mounted speaker uses zero floor space. Dimensions: 37" x 14.25" x 3.875"

Constructed of beautiful, solid, non-endangered hard woods.

Manufactured exclusively by

AMERICAN APPLIED ACOUSTICS
under license from American Power and Light, Inc.

Phone: 916.666.1873

Fax: 916.666.6272

Dealer Inquiries invited

Suggested Retail Price \$3,995.00 per pair

This is a music lover's speaker - the listener is brought closer to the musical event through the window of the Alix-Anne II. There is a seamless integration of the voice of the speaker which leaves the impression of a single perfect driver - no part of the spectrum is favored over another. It has the agility to accurately recreate the transient nature of a piano, a plucked string or a struck instrument. At the same time, it lacks any sign of stored energy of its own so that the natural modulated decay of an instrument sinks into silent blackness in proper time. Another important characteristic is that the speaker neither diminishes nor exaggerates the scale and size of a musical instrument or voice. This is a rare accomplishment in a speaker system. The Alix-Anne II brings the performance to the listener and then disappears so that the connection of listener to performing artist is direct.

Walter Davies, The Last Factory

It's Like Music to Your Ears...

Amperex Bugle Boy

audio tubes are back and they're better than ever!

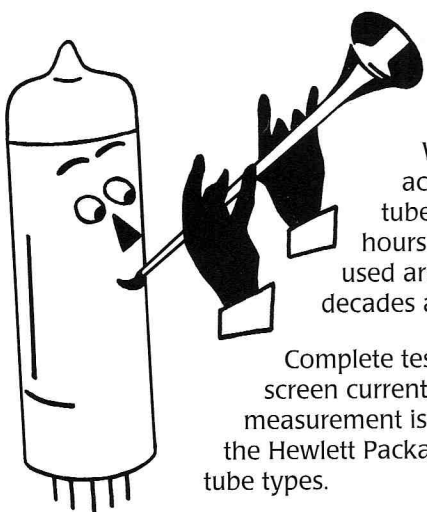

When it comes to selecting premium audio tubes for your amplifier, accept no less than the best, Amperex Bugle Boy! Amperex Bugle Boy tubes are burned in under full load with all voltages applied for 24 hours before being tested for noise & microphonics. The aging racks used are from the original Amperex production line built in Holland decades ago.

Complete test results are supplied with each tube, including plate current, screen current, filament current, and total harmonic distortion (THD). The THD measurement is performed using one of the finest spectrum analyzers available – the Hewlett Packard 3561A. Matching in pairs, quartets & octets is available for all tube types.

Special test requirements? Not a problem. For a slight additional charge we will test and match to your specified operating conditions.

Types available: **6DJ8/ECC88**, **12AU7A/ECC82**, **12AX7A/ECC83** and many more!

So if you haven't dealt with a source capable of meeting your demands, call us at **1-800-TUBE USA** or **630-208-2200** today for information on additional products and the worldwide locations nearest to you. You'll like what you hear!

APD is pleased to announce the addition of **Hammond Manufacturing's** complete line of Classic Transformers and Enclosures to our product offering. Call today for a Hammond catalog or download it from our WEB site at www.tubes-r-us.com/classic.html.



Thinking
about building
your own
amplifier?
Call 1-800-
TUBE USA

BLUENOTE Midas Dampers are now available, along with other quality audio accessories - such as, equipment isolators and CD/LP treatments. The Midas Dampers (as reviewed in *Stereophile Magazine*, February, 1996) are made of the highest quality materials available. They reduce microphonics in your preamp tubes thereby enhancing the music you hear.

Call **1-800-TUBE USA** or **1-800-882-3872** today for your copy of our **NEW APD brochure featuring Audio Tubes, BLUENOTE and Hammond products.**

APD Audio Product Division

a division of Richardson Electronics, Ltd.

You can also visit our Classic Components site on the Internet at:

<http://www.tubes-r-us.com>

 **Richardson
Electronics, Ltd.**
ISO9002 Registered

40W267 Keslinger Road
P.O. Box 393
LaFox, IL 60147-0393
(630) 208-2200
(800) 882-3872

SOUND PRACTICES MAGAZINE

featuring

Cool DIY Projects
History and Classics
Future Perspectives
International News
Wild Entertainment
Refuge for Audio Nerds
and much more!!

SUBSCRIPTION RATES

1 year (4 issues) \$20 US, \$24 Canada,
\$30 Europe, \$35 elsewhere.

Sample \$5. MC/Visa accepted.
Money back if not delighted.

PO Box 180562 Austin TX 78718
512-339-6229 voice/fax
www.soundpractices.com

one electron™

Single-Ended Output Transformers
High Quality for a Reasonable Price
Designed and Built in the USA

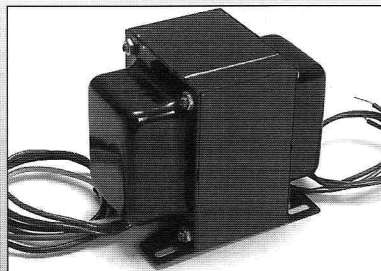

UBT-1 Designed for parallel operation of:
1.6k primary 2A3s, EL34s, 300Bs 6AS7s,
15 watts \$90.25 etc. or Sweep-tube in
160 mA "enhanced triode" mode

UBT-2 Can be used with:
4.8k primary \$112.10 300B, 50, SV811-3, etc.
15 watts
110 mA

UBT-3 Good for single ended
3k primary \$121.60 2A3 or 300B
15 watts
110 mA

Quantity discounts available

ANTIQUE ELECTRONIC SUPPLY™
LIMITED PARTNERSHIP

6221 S. Maple Ave. • Tempe, AZ • 85283
Phone (602) 820-5411 • FAX (602) 820-4643 or 800 706-6789

VTV Back Issues and Subscription Order Form

Cash, US Bank Check, AMEX, MC or VISA Accepted

VTV 1 - Early tube ams, Dynaco History, Tube Testing, Audio Test Bench Set-up and 12AX7/ECC83 History and Tests **\$8 US-\$10 Foreign PPD**

VTV 2 - EL34/6CA7 History and Tests, Heathkit WM Series Tube Amps, Western Electric Theater Sound 1934, Best Guitar Amps, Tube Matching, Magnum SE Amp Project **\$10 US-\$13 Foreign PPD**

VTV 3 - WE 300B History and Tests, SE Transformer Tests, EICO Tube Hi-Fi, EH Scott 48 tube radio, McIntosh MI 200 modification, Dynaco Stereo 70 Project **\$12 US-\$15 Foreign PPD**

VTV 4 - 6L6 History and Tests, HK Citation I and II, Classic Bookshelf Speakers, Designing for Sound, Tube Manuals from the Golden Era **\$12 US-\$15 Foreign PPD**

VTV 5 - Bendix Red Bank Tubes, FM Tuner Shoot-out, Vintage Hi-Fi in Hong Kong, Guitar Amp Book Review, Audio Signal Generators, Uncle Eric's Deluxe SV8ll SE Amp Project, The Birth of the Marantz 10B, Guitar Amp Rectification **\$12 US-\$15 Foreign PPD**

VTV 6 - The Story of the Fisher 500, A Tribute to A very Fisher, The Randall Amplifier Project, Loftin-White Amplifier History, Power Kings 6550-KT88, Audio Test Bench - Oscilloscopes, Uncle Eric's Dumpster - The 5687 **\$12 US-\$15 Foreign PPD**

VTV Annual Subscription (Four issues) Rates (10/97)

\$35/yr US, \$43/yr Canada (Starts with current issue)

\$53/yr Europe and \$63/yr Asia and rest of Globe (Sent Airmail)

Send Name, address, City, State, Country and Mail code/Zip.

Enclose payment for number of years in either US check, cash, or credit cards. AMEX, Master Card and VISA Accepted.

Please print credit card number and expiration date legibly!

VACUUM TUBE VALLEY, 1095 EAST DUANE AVE, SUNNYVALE, CA 94086 USA (408)-733-6146 PH/FAX email: triode@aimnet.com

VACUUM TUBE VALLEY PUBLICATIONS

1. Vintage Hi-Fi Spotter's Guide #1 & #2 (450 illus) **\$18.95ea**

2. Ultimate Tube Substitution Guide (240p) 10,000 tubes **\$29.95ea**

3. Vintage Hi-Fi - The Golden Era Video 34 min, VHS **\$29.95ea**

4. List of hi-fi books, schematics, manuals and reprints **\$5.00ea**

5. VTV Tube School Manual, 120 pages - Binder **\$35.00 ea**

6. Tube Hi-Fi, Pro Audio, Tubes xfmers -Price Guide **\$30.00 ea**

Postage: **\$5.00** each book US

\$10 each book ASIA/Europe

Vacuum Tube Valley

1095 East Duane Ave., #106

Sunnyvale, CA 94086

(650)-654-2065 FAX

AMEX. MC, VISA accepted



VACUUM TUBE VALLEY
SUNNYVALE, CALIF. U.S.A.

Be the first in your neighborhood to have the official VTV "BIG TONE" T-shirt.

2 color heart print available in either **Blue Spruce** or **Desert Sand** colors. (Please Specify when ordering) 100% cotton shirt. Only extra large available.

Only \$14.50. plus \$3.00 postage US,

CA residents add \$1.12 Sales Tax

Canada and Mexico add \$7.00 postage

Europe and Asia add \$12.00 postage

Cash, Check or Money Order

Credit Cards OK

Vacuum Tube Valley
1095 E. Duane Ave., Suite 106
Sunnyvale, CA 94086 USA

TESLOVAKtm

VACUUM TUBES...from the Heart of Europe!

Introducing three totally new vacuum tubes from **TESLOVAKtm**: the KT88s, the E34Ls and the E83CCs. These new vacuum tube designs are the product of years of research, development, and hard work by our USA based engineering staff of Groove Tubes and Penta Labs in a joint venture with the staff of the newly reorganized Tesla factory recently relocated in the heart of Europe: the Slovak Republic.

These tubes are being handmade in limited quantities exclusively for Penta Labs and Groove Tubes in the classic European tradition. This legendary tube factory has manufactured many OEM tubes under the brand names such as; Telefunken, Siemens, Amplex, Mullard, and Brimar, to name a few.

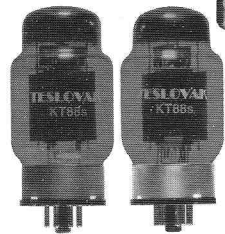
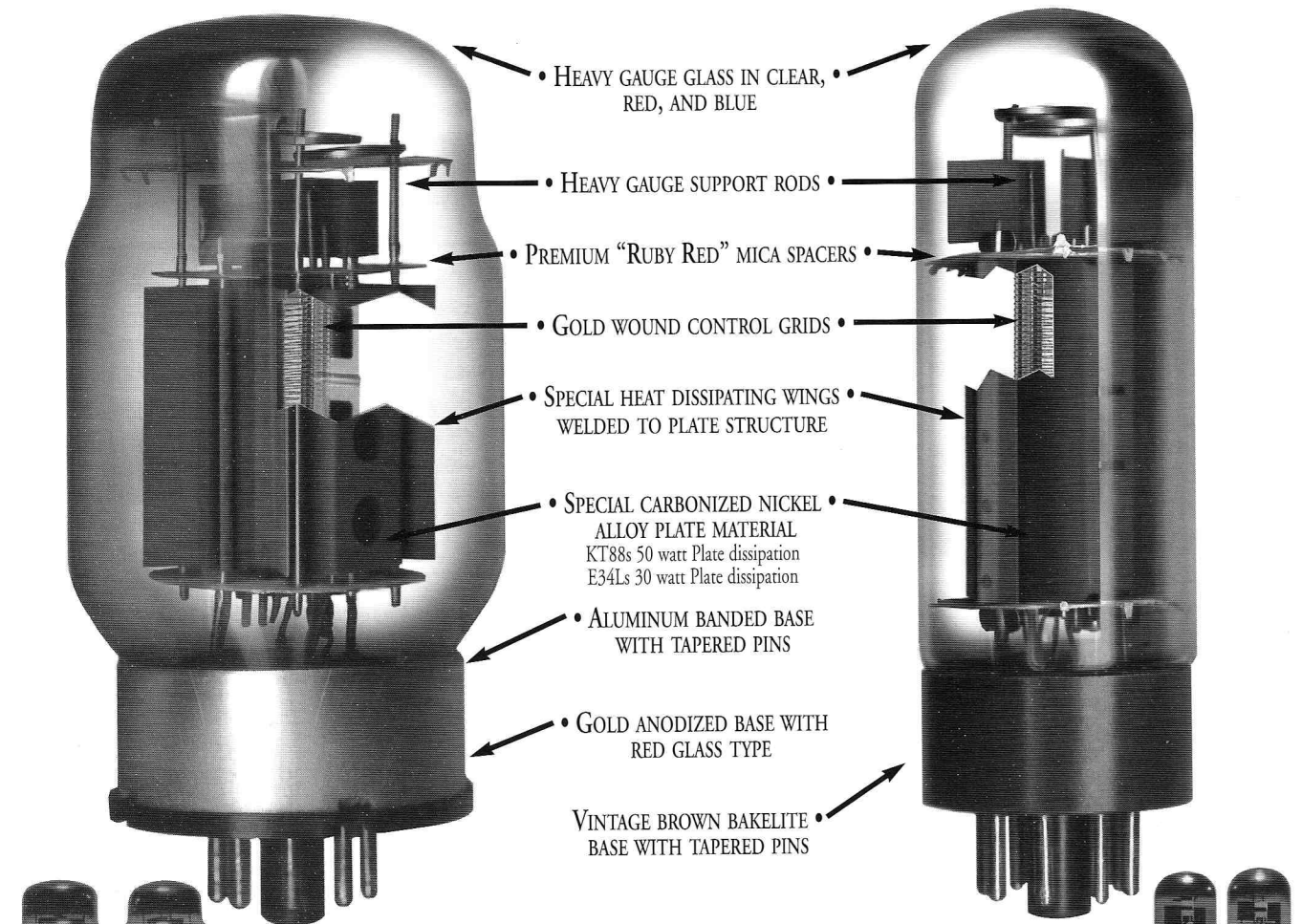

Our new **TESLOVAKtm KT88s**

The first legitimate European KT88 made in over 30 years. This new beam power tube has our unique and specially developed heat dispersion wings to help keep the tube's audio

performance stable at higher power handling levels. It also has gold wound grids for improved fidelity and lower noise. Additionally, our new KT88s is now available in blue and red glass.

Our new premium **TESLOVAKtm E83CCs** preamp tube with special frame grids, wound with gold wire, help to reduce microphonic interactions, lower noise, and improve both transient and frequency response.

Selected preamp tubes and matched power tubes available from:



Groove Tubes
12866 Foothill Blvd., Sylmar
California 91342 USA
Tel: (818) 361-4500 Fax: (818) 365-9884
e-mail: GrooveTube @ AOL.com



Our new **TESLOVAKtm E34Ls**

This totally new Pentode design upgrades and replaces all EL34 applications, producing more power and wider frequency response and dynamic range than any other EL34 past or present! This new tube also has special heat dispersion wings to improve the audio response at higher power levels and gold wound grids for improved fidelity. Available in blue and red glass.

Great attention is given to materials and assembly with over 30 hand welded contacts in this single dual triode! This great sounding new tube replaces the 12AX7/7025 in all applications.
(Tube pictured is the GT selected version, GT-ECC83)

Call for Design Engineering data sheets and OEM price schedule:

Penta Laboratories
21113 Superior Street, Chatsworth CA 91311 USA
Tel: (800) 421-4219 or (818) 882-3872
Fax: (818) 882-3968
e-mail: PentaLab1@ AOL.com



BRUCE MOORE AUDIO DESIGN

The COMPANION line stage preamplifier



1 Hz to 200 kHz.
THD < .05%.
2ea 6DJ8/6922.
\$1550. with pots.
\$2100. with ladder
attenuators.

*"I could have stayed
there all day, so pure
and intoxicating was
the music." M. F.*

70 watts/chan ultra.
37 watts/chan triode.
1 Hz to 200kHz.
THD < 0.1%.
4ea 6922, 6550/KT88
independent biasing
for each output tube.
\$3500.

Dealers Welcome!

The DUAL 70 stereo power amplifier

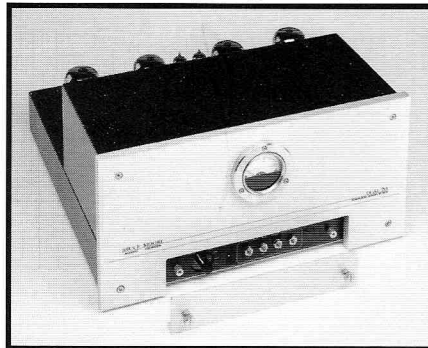

ACOUSTIC SYSTEMS OF SAN JOSE (408) 972-9114
web showcase: <http://www.slip.net/~arinc>

GO AHEAD

Ask top engineers and music lovers worldwide what capacitor they choose for their ultimate designs.

— H O V L A N D —

MUSICAP®

"After auditioning a wide variety of caps, I find these film-and-foil capacitors to be the most musical performers—and by a large margin. The MusiCap specializes in textural liquidity (lack of grain) and delicacy of treble nuances." Dick Olsher, Reviewer and Designer;

November 1996 Samadhi Acoustics white paper

COMPARE NOW

The most naturally revealing capacitor. Film and foil polypropylene construction. Optimized for fine speakers and vacuum tube electronics. Silver-plated leads. Precision made in the USA. Values from .01 to 10µF.

To audition MusiCaps for yourself, call these quality distributors:

- Welborne Labs, USA 303-470-6585
 - Michael Percy Audio Products, USA 415-669-7181
 - Madisound Speaker Components, USA 608-831-3433
 - The Parts Connection, Canada 800-769-0747
 - Handmade Electronics, USA 610-432-5732
 - American Audio Import, Netherlands 31-78-6510567
 - Anchor Cross Co., Tokyo, Japan 81-3-3203-5606
 - Bina Putra Datamas, Indonesia 62-21-8209126
 - Octave Electronics, West Malaysia 603-793-793-9
 - SJS Electroacoustics, England 44-1706-823025
 - Tang Hill International Ltd., Taiwan 886-2-5813605
 - Thai Audio Center, Thailand 66-2-226-0773
- OEMs and international distributors may contact
HOVLAND COMPANY at 209-966-4377 Fax 209-966-4632

Moth Audio Corporation

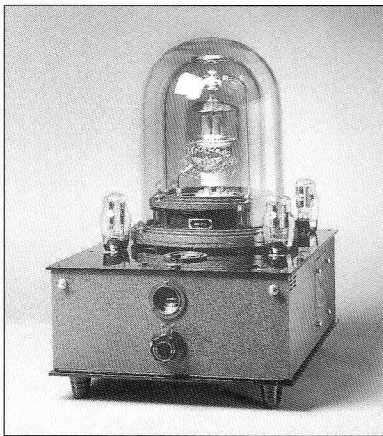

Hearing Is Believing

CES January 8-11 1998
Alexis Park # 1356



ELECTRA-PRINT AUDIO

QUALITY HANDWOUND S.E. OUTPUT TRANSFORMERS

- Primaries from 1.8K to 10K
- Exclusive wideband design
- 16, 8, 4, or 2 ohm secondary
- Gold plating

CUSTOM-BUILT POWER TRANSFORMERS/CHOKES

- Wound to your requirements
- Heavy-duty design for Class A use
- DC filament supply windings
- HV chokes to 15H, 300ma
- Low voltage, high current filament chokes

Component pricing and specifications catalog available

ELECTRA-PRINT AUDIO

4117 Roxanne Drive Las Vegas, NV 89108
702-396-4909 FAX 702-396-4910

KR ENTERPRISE VV VALVES

Power Triodes Without Output Limit

New Low Prices

The KR Enterprise VV Valves are the first new directly heated triodes to be manufactured in over three decades. Hand built in the Czech Republic with their patented 32 cathode and ribbon filament structure, the VV Valves will provide more power, lower distortion and better tonal fidelity than is available with any other power triode.

| | | |
|---------|-------|-------------|
| VV300B | clear | \$475.00/pr |
| VV300B | blue | \$575.00/pr |
| VV302BC | blue | \$575.00/pr |
| VV32B | clear | \$675.00/pr |
| VV52B | clear | \$775.00/pr |

For more information contact the North American Distributor:

Welborne Labs P.O. Box 260198 Littleton, CO 80126 USA
 Voice: 303.470.6585 Fax: 303.791.5783 E-Mail: wlabs@ix.netcom.com

OEM and dealer inquiries invited. The VV Valves are warranted for one year or 2000 hours.

Listen to the VV Valves today and experience a whole new horizon of musical pleasure.

Design In the "Real McCoy"

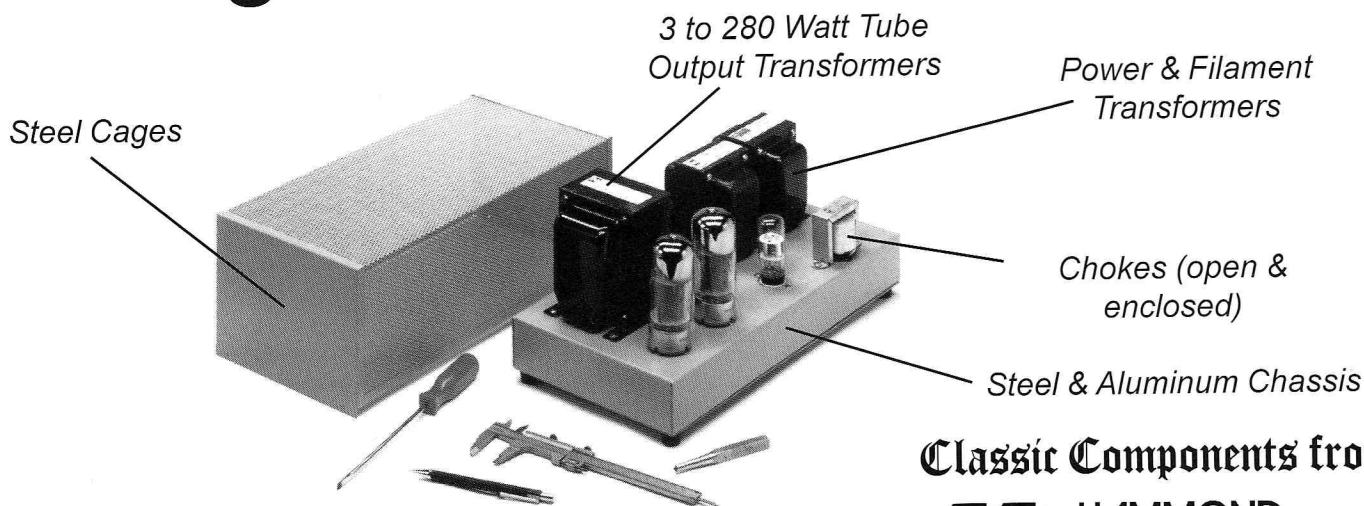

We've been in the transformer & enclosure business for over 70 years. In fact, most of the components shown here have been in continuous production since the 1950's! Trust your design with our experience...

Classic Components from:



4700 Genesee St., Cheektowaga, NY 14225 Phone (716) 631-5700 Fax (716) 631-1156
 394 Edinburgh Rd. North, Guelph, Ontario N1H 1E5 (519) 822-2960 Fax (519) 822-0715

Tough Enough.



The Svetlana EL509

Finally, a reliable and rugged sweep tube that's currently in production. The Svetlana EL509/6KG6 is manufactured by the world-renowned Svetlana factory in Russia. Massively built, the Svetlana EL509/6KG6 is tough enough to last longer *and* perform better. And unlike other sweep tubes, ours is still in production! You can count on Svetlana for incredible quality and an unbeatable warranty. So put us to the test. Try Svetlana's EL509/6KG6 and see for yourself just how tough it really is.

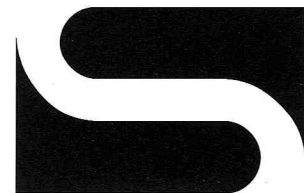

Svetlana
ELECTRON DEVICES

www.svetlana.com

Headquarters: 8200 S. Memorial Parkway Huntsville, AL 35802 Phone 205-882-1344 Fax 205-880-8077 • Marketing & Engineering: 3000 Alpine Rd. Portola Valley, CA 94028 Phone 415-233-0429 Fax 415-233-0439

*Though Heath-kits, Knight-kits and Eico-kits are gone...
still the Incredible Sound of the 50's is back!*

Easy-to-build Tube Hi-Fi Stereo Kits Made In USA



Call for your free Catalog now!

Many Models: Amplifiers * Preamplifiers * Phono Preamps
Documentation: Complete easy step-by-step Assembly Manual

ASUSA-Kit

6717 NE 181st Street, Seattle, WA 98155 USA

E-Mail: franklab@ix.netcom.com
Phone 425-481-8866 Fax 425-485-3836

Western Electric®
High Fidelity

WE300B

**The Standard In
Quality and
Long Life**



Matched Pair WE300B

Western Electric High Fidelity products are marketed worldwide by Westrex Corporation. Western Electric is a trademark of Lucent Technologies Inc., formerly AT&T Technologies, Inc., licensed to Westrex Corp., a company independent of Lucent. Developments of Bell Laboratories. Western Electric High Fidelity products are manufactured in the U.S.A.

Western Electric Audio Products

1230 Peachtree Street • Suite 3750 • Atlanta, GA 30309-3575 • (404) 874-4400 fax (404) 874-4415
e-mail: sales@westernelectric.com • internet: www.westernelectric.com



TUBES-PARTS-BOOKS-SUPPLIES

(602) 820.5411 FAX (800) 706.6789

FIND EVERYTHING YOU NEED
BUY IT FOR A SONG.

*Where can I find a 6BQ5
replacement tube?*



Call or fax today for our new 60 page **FREE** catalog of vintage tubes, hard to find parts, books and supplies. We have everything you need to build new or repair classic audio equipment at prices you haven't seen in decades.

6221 SOUTH MAPLE AVENUE
TEMPE, AZ U.S.A. 85283

VISIT OUR WEBSITE AT WWW.TUBESANDMORE.COM

