

VACUUM TUBE VALLEY™

Issue 9
Spring 1998

The Classic Electronics Reference Journal

Published Quarterly
Price \$9.00

Big Triodes... Big Sound!

The Ampeg SVT

300 Watts of Badass Bass

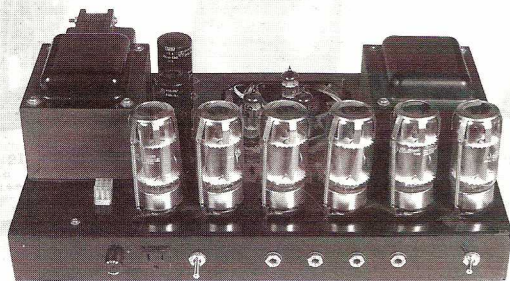

Bargain Vintage Hi-Fi

Great Tube Sound on a Budget



Waking the Gentle Giant

Restoration of an Altec 287W

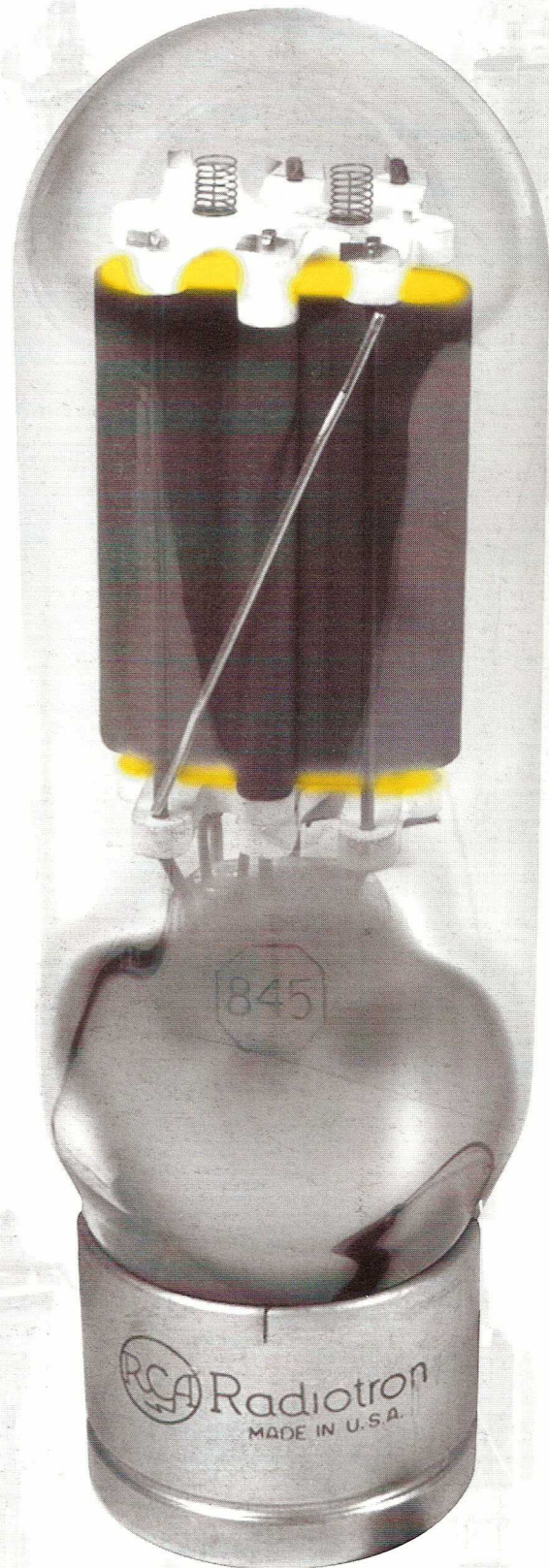

**VTV Issue # 9
Table of Contents:**

Legacy of the 50 Watter.....3
Transmitting Tube Test Amp.. 7
Dumpster: 2C51/5670.....10
Listening to SE 211/845s....11
Ampeg SVT History.....13
The First Tube PCs.....18
Winter 1998 CES Report21
Vintage Audio in Japan.....22
Distortion Analyzers II.....25
Altec 287W Giant Amp.....28
Bargain Tube Hi-Fi.....30
Metallic Rectifiers32
Advertiser Section35

Tube School Update

VTV has presented two Tube Schools since last November. We presented Tube School II in Tempe, Arizona with the assistance of Antique Electronic Supply. For the first time we included a four hour presentation on guitar amplifiers taught by Evan Aurand. In addition, Ritchie Fleigler, VP of Marketing for Fender Musical Instruments, gave a talk on the state of tube guitar amps at Fender Musical Instruments.

In February, VTV sponsored the first annual Bay Area Tube Enthusiast's Weekend. Even though the rains of

El Nino washed out the vintage electronics flea market on Saturday, a crowd of almost 500 new and familiar tube enthusiasts showed up for our tube trade show and display show. We also presented Tube School III with John Atwood, VTV Tech Editor, as class leader and Evan Aurand with Terry Buddingh handling the Guitar Amp School.

New York Tube School: Fall 1998

If we get at least 50 pre-registered sign-ups (by 8/15/98), VTV will present Practical Tube Audio School in the New York area during September or October 1998. This is an intensive eight hour class covering the basics of tube electronics, tube amp circuit theory, tube testing and grading, repair & troubleshooting techniques, equipment mods & upgrades and listening tests. *Tube School is designed for attendees at the beginner to intermediate level of skill.* VTV will also present a four hour Guitar Amp School in the afternoon, again, if there are at least 30 sign-ups.

John Atwood, MSEE and VTV Technical Editor, is Tube School class leader. John has over 20 years experience in vacuum tube amp design and repair. Additional speakers will include: Al Pugliesi, The Fisher Doctor; Charles Kittleson, VTV Editor and other notables in the field of tube electronics.

The cost for Tube School is \$149 prepaid (before August 15, 1998) and \$179 at the door. Price includes all class materials in a binder plus coffee and tea in the AM. To guarantee that this event will occur, please send or FAX us your name, address, telephone number, whether you want the hi-fi or guitar amp class and credit card information to reserve your seat in class. *If we do not get the required number of class sign ups by August 15, 1998, your payment will be refunded promptly.*

VTV In The News - Again!

As a result of our Tube Enthusiast's Weekend, most of the VTV editors were interviewed by the *San Francisco Chronicle* newspaper for a major article that appeared in the February 7, 1998 Business Section. VTV's Tech Editor, John Atwood, was pictured on the front page of the article.

Business Week Magazine also got into the act and was interested in the "tube audio" phenomenon. They interviewed yours truly and took a picture of me sitting in the VTV test lab. The final article was three pages in the subscriber edition of the March 30 issue.

Call for Articles

VTV is always seeking quality articles on audio and electronics history, good sounding tube hi-fi projects, pro-audio history and related subjects. We accept articles only in simple text format on 3-1/2 inch floppies. Any photos should be clear and sharp. Schematics should be clearly drawn with all component values listed. We do pay authors for their work if it is published in VTV. Share your knowledge and passion about tubes with the world community of tube enthusiasts-write for VTV.

VTV Subscription Price Increase

Due to increased rents, postage and printing costs, VTV is raising the subscription cost and per-issue cost of the magazine. Current issue news stand and distributor cost is \$9.00/issue, US subscription rate is now \$36/yr-four issues, \$43/Canada, \$56/Europe and \$66 Asia and world. This price increase is effective with VTV #9.

Changes in VTV #9

Due to space constraints Part 2 of the Bruce Moore interview and the 572-3 push-pull amplifier project will not be in this issue. They will be in VTV #10.

EDITORIAL STAFF

- Charles Kittleson** - Editor and Publisher
- John Atwood** - Technical Editor
- Eric Barbour** - Staff Editor
- Terry Buddingh** - Guitar Editor
- Steve Parr** - Art Director
- Julie P. Werner** - Copy Editor
- Website** - www.vacuumtube.com

**Copyright 1998
Vacuum Tube Valley™ and Big Tone™**

No part of this publication may be reprinted or otherwise reproduced without written permission of the publisher.

Send circulation and editorial correspondence to:

Vacuum Tube Valley
 1095 E. Duane Ave., Suite 106
 Sunnyvale, CA 94086 USA
 e-mail triode@vacuumtube.com
ISSN # 1095-4805

Vacuum Tube Valley is published quarterly for electronic enthusiasts interested in the colorful past, present and future of vacuum tube electronics.

Subscription US\$36.00/year (4 issues)
 \$43/Canada and \$66/Asia, \$56 Europe

**Cash, US Bank Check, or Credit Cards
are accepted for payment**

**Phone - (650) 654 - 2065
FAX - (650) 654 - 2065**

Legacy of the 50 Watter: 211 & 845

By Eric Barbour

© 1998 All Rights Reserved

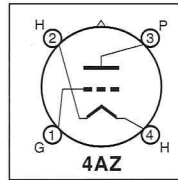

Intro

As usual, we have a story for you that doesn't unfold in a rational way. Once again, a tube family in common use today sprang from a line of industrial triodes, and became audio gold by sheer accident and random chance.

History

It begins with an experimental triode from 1917. General Electric had developed the "Type U Pliotron" for use in Navy radio transmitters; it was called CG-1144 when it was put into radios aboard seaplanes during World War I. After the war, the Type U became the UV-203. Introduced in March 1921 by RCA and made by GE, for use in AM radio transmitters, it had a mu of 25 and a pure tungsten filament. In short, it was primitive. Yet the 203 was one of the earliest

large transmitting tubes in mass production. The plain-tungsten 203 was also made under various proprietary numbers, such as PG132 and HW15.

Unlike most other power tubes of the era, it was equipped with a standard base for easy change-out; previous power triodes were usually mounted on frames and attached to their circuits with flying leads. This large bayonet-lock base with 4

Not many other types were so widely copied and modified. A smattering of versions include the 203H for medical diathermy, with plate and grid caps; 303A was the United Electronics version; Taylor's T-125 was a 150w version with mu of 20 and plate and grid caps; Taylor's 303C/HD203A had a plate cap and mu of 25; 295A was the Western Electric version from 1933; T-203Z was a Taylor version with mu of 85; and there were too many other versions from other firms to list here. This helped cement the 4-pin jumbo base as a major industry standard

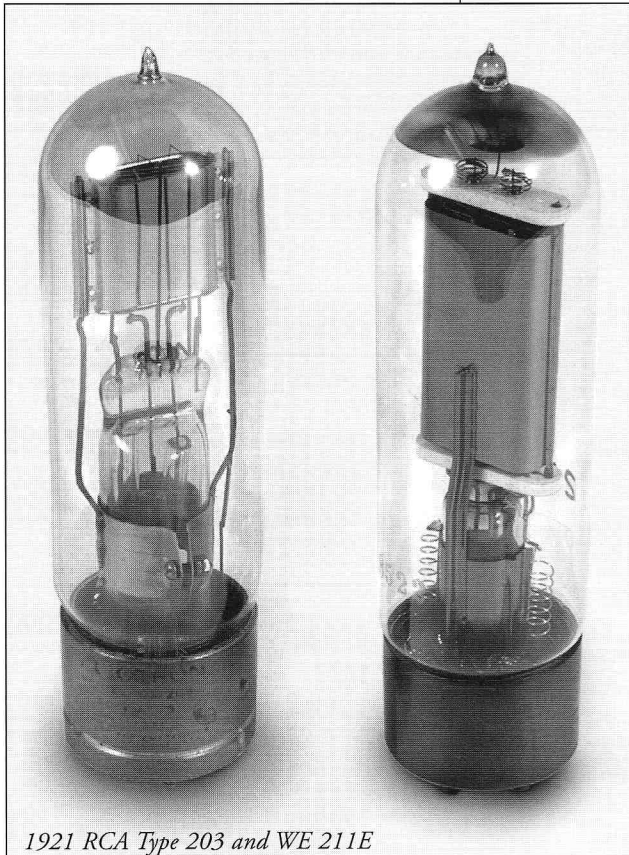

1921 RCA Type 203 and WE 211E



Early 845 & 211 cartons

stubby pins, originally developed by Western Electric and often called the "jumbo," became a standard for power triodes.

Thorium was a big improvement. The UV-203A, introduced in June 1923 by RCA and Westinghouse, was one of the first power tubes to be introduced with a thoriated filament. Its dissipation, rated at 100W, made it popular. Later it was cloned by Amperex, Deforest, GE, Sylvania and Taylor.

in the very early days of radio broadcasting. Note: WE's 203 series of tubes were much smaller than industry-standard 203 types and not compatible.

Eventually this led to the 211. It was developed by Western Electric from their experimental series G, with the first version 211A completed in late 1921, then copied in late 1923 by Westinghouse, and marketed by them and by RCA. With a mu of 12.5, it was intended for RF dielectric heating and audio modulators. A dull and pedestrian tube for dull everyday jobs. (If a radio engineer of the 1920s lived to see what old 211s are selling for today, he would probably die laughing.) 211 types were widely made by other firms, as they caught on in mundane industrial and medical applications.

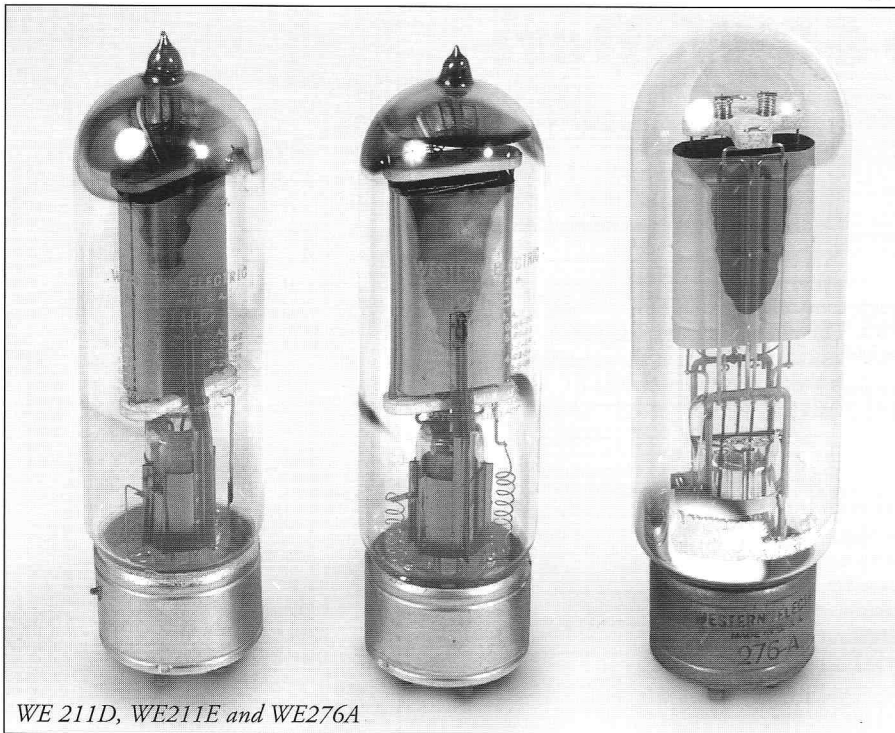

WE 211D, WE211E and WE276A

Western Electric's versions started with the 211A ; the 211B, C and D were just the same tube with different grades of filament. The 211E was notorious for its use in the WE 43A theater amplifier. A pair of small nichrome-wire inductors were installed in the filament circuit, inside the actual tube, to help stabilize it at high frequencies. This makes old 211Es highly collectible.

Some other versions of the 211 include the Western Electric 242A, used in WE's model 80A audio amp; 242B and C were aimed directly at audio equipment, especially the C, which found use in the D-90684 broadcast monitor amp; the WE 261A was used in early WE AM transmitters, while the WE 276A was a 100w-dissipation version; 214A, D and E were 211As without grids, for use as rectifiers; RCA's 217C from 1926 was like a 214E

with a plate cap; 211H was Amperex version with a plate cap; United made a 311 series (311CH with plate cap), mainly for RF heating; RCA's 835 of 1937 was a low-capacitance version for the low end of the VHF band; and RCA's 838 was a variable-high-mu version for zero-bias Class B use. (That's right, it has a variable-mu grid, making it high in distortion in SE connection.) And all those VT-4Cs made by GE from 1938 to 1945 for aircraft transmitters, which became common and cheap surplus after the war.

This led to RCA's 805 and WE's 331A, which had variable high-mu grids and were intended for Class B AF modulators. It also led to 810 types and to a long series of Taylor types: T-125, T-155, T-200, 814, and 822, plus many, many variations and special-duty types.

The last development was the 845, believed to have entered development by RCA in 1927 and not released until 1931 as the UV845. In an era when transmitting triodes were headed toward high-mu design and grounded-grid or Class B operation, the UV845 was an aberration: a 75-watt power triode with a mu of 4.8. Later it was up-rated to 100 watts. Ridiculously archaic and difficult to drive, by 1945 it was obsolete except for its continued use in older RCA BTA-series transmitters as the audio modulator final amp, in a Class A push-pull pair. Such transmitters were often pressed into service after World War II by small local broadcasters, many carrying "race" music and programming. Millions of Americans

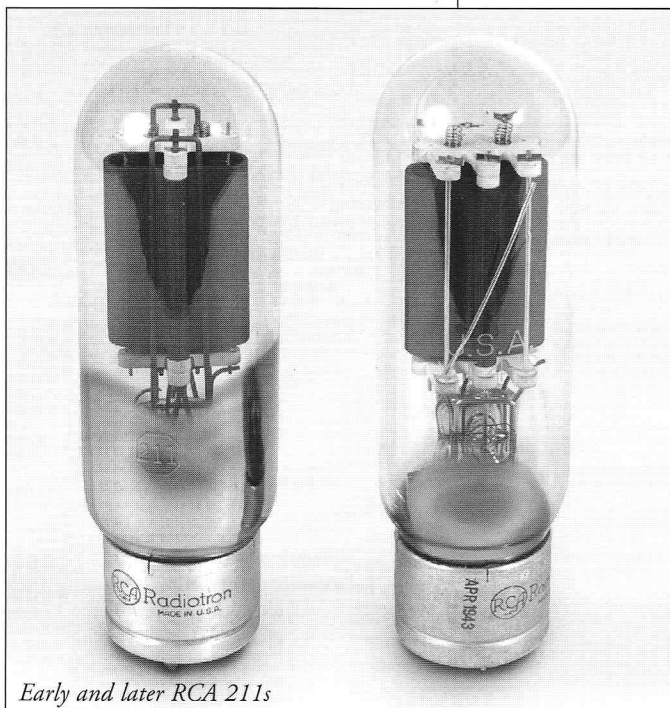

Early and later RCA 211s

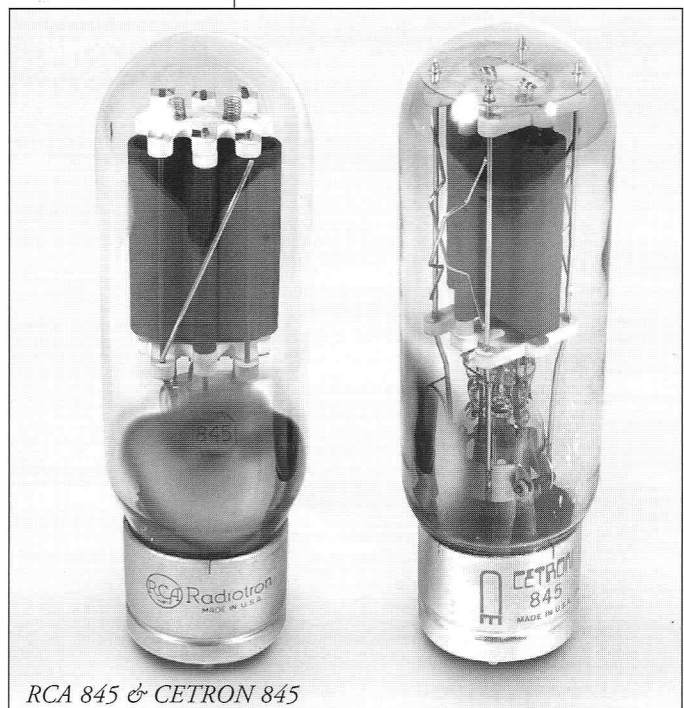

RCA 845 & CETRON 845

Original RCA 845 data sheet ca 1932

UV-845

RADIOTRON UV-845
TECHNICAL INFORMATION SHEET

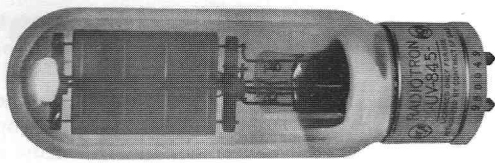

GENERAL	
Main Use.....	A-F Power Amplifier or Modulator
Number of Electrodes.....	3
Filament Voltage.....	10 Volts
Current.....	2.5 Amperes
Type.....	Thermostated Trianglen
Average Characteristic Values Calculated at E _b = 1000, E _c = 147 and E _r = 10 D-C	
Plate Current.....	1.5
Grid Current.....	0.075 Amperes
Plate Resistance.....	1800 Ohms
Mutual Conductance.....	2000 Micromhos
Approximate Direct Inter-electrode Capacities	
Plate to Grid.....	.15 mμf.
Plate to Filament.....	8 mμf.
Plate to Filament.....	7 mμf.
Maximum Overall Dimensions	
Length.....	7 3/4 Inches
Diameter.....	2 1/8 Inches
Type of Cooling.....	Air
MODULATOR	
Maximum Operating D-C Plate Voltage.....	1250 Volts
Maximum Plate Dissipation.....	.75 Watts
Normal Operation E _b = 1000, E _c = 147 and E _r = 10 D-C	
Peak Grid Swing.....	0.075 Amperes
Plate Current.....	1.47 Volts
Load Impedance.....	7500 Ohms
Output (5% Second Harmonic).....	.23 Watts
OSCILLATOR & RF POWER AMPLIFIER—CLASS C	
Maximum Operating D-C Plate Voltage.....	1000 Volts
Maximum Plate Current.....	0.175 Amperes
Maximum D-C Grid Current.....	0.175 Amperes
Maximum R-F Grid Current.....	7.5 Amperes
Normal Operation E _b = 1000, E _c = 250 (Approx.) and E _r = 10	
Output.....	.75 Watts

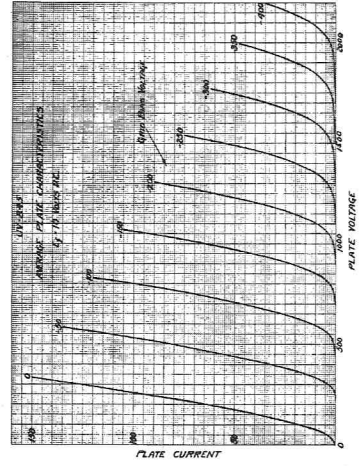
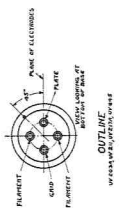
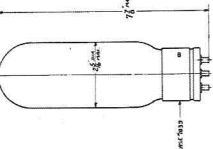

PLATE CURRENT vs. PLATE VOLTAGE (15)



As tubes are used under many widely different conditions these figures should not be used for design purposes without confirmation from the manufacturer

April, 1932

Original RCA 211 data sheet ca 1932

UV-211

RADIOTRON UV-211
TECHNICAL INFORMATION SHEET

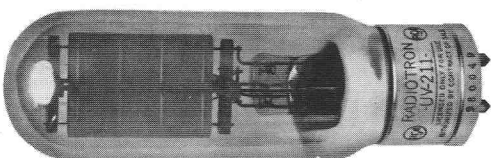

GENERAL	
Main Use—General Purpose.....	A-F Power Amplifier or Modulator
Number of Electrodes.....	3
Filament Voltage.....	10 Volts
Current.....	2.5 Amperes
Type.....	Thermostated Trianglen
Average Characteristic Values Calculated at E _b = 1000, E _c = 147 and E _r = 10 D-C	
Plate Current.....	1.2
Grid Current.....	0.075 Amperes
Plate Resistance.....	3400 Ohms
Mutual Conductance.....	3500 Micromhos
Approximate Direct Inter-electrode Capacities	
Plate to Grid.....	.15 mμf.
Plate to Filament.....	8 mμf.
Plate to Filament.....	7 mμf.
Maximum Overall Dimensions	
Length.....	7 3/4 Inches
Diameter.....	2 1/8 Inches
Type of Cooling.....	Air
MODULATOR	
Maximum Operating D-C Plate Voltage.....	1250 Volts
Maximum Plate Dissipation.....	.75 Watts
Normal Operation E _b = 1000, E _c = 147 and E _r = 10 D-C	
Peak Grid Swing.....	0.075 Amperes
Plate Current.....	1.17 Volts
Load Impedance.....	7500 Ohms
Output (5% Second Harmonic).....	.23 Watts
RF POWER AMPLIFIER—CLASS B	
Maximum Operating D-C Plate Voltage.....	1250 Volts
Maximum Plate Current.....	0.175 Amperes
Maximum D-C Grid Current.....	0.175 Amperes
Maximum R-F Grid Current.....	7.5 Amperes
Typical Operation E _b = 1000, E _c = 75, E _r = 10 D-C	
Carrier Output.....	0.130 Amperes
Carrier Output—Modulation Factor 1.0.....	.100 Watts
Carrier Output.....	.100 Watts
OSCILLATOR & RF POWER AMPLIFIER—CLASS C	
Maximum Operating Plate Voltage.....	1000 Volts
Unmodulated D-C.....	0.175 Amperes
Unmodulated D-C.....	0.175 Amperes
Maximum D-C Grid Current.....	0.175 Amperes
Maximum Plate Dissipation.....	100 Watts
Maximum R-F Grid Current.....	7.5 Amperes
Typical Operation E _b = 1000, E _c = 250 (approx.), E _r = 10	
Output.....	.100 Watts
Sockets.....	RCA Type 941

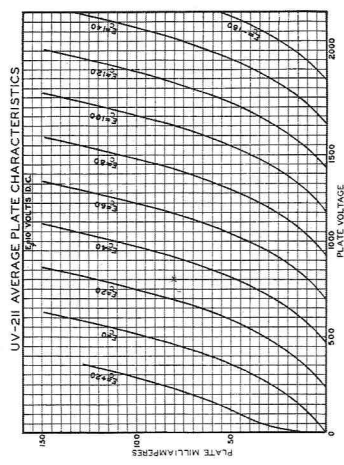
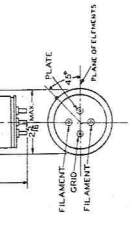
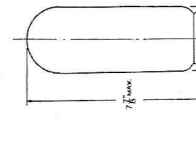
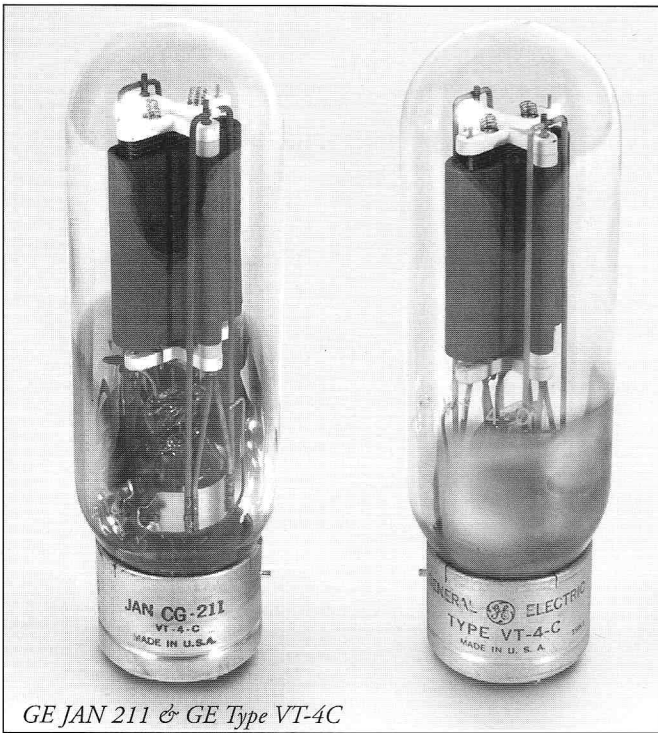

PLATE CURRENT vs. PLATE VOLTAGE (14)



As tubes are used under many widely different conditions these figures should not be used for design purposes without confirmation from the manufacturer

April, 1932



GE JAN 211 & GE Type VT-4C

were exposed to R&B and gospel music via the smooth sounds of push-pull 845s, driven by interstage transformers, with no negative feedback. Altec, RCA and WE also used the 845 in a few theater amps during the 1930s and 1940s..

Western Electric's 284 series was very similar to the 845 and enjoyed lengthy

use in AM broadcast modulators. There were other manufacturer's designations for the 845, although it did not enjoy nearly as much popularity or variability as the 203 or 211. Its mu was too low to make it suitable for RF-heating power oscillators, and any continued manufacture was just to keep pre-1950 AM transmitters retubed.

High mu was the overwhelming trend after the war, and grounded-grid RF amplifiers were the last frontier for glass triodes--power tetrodes and pentodes elbowed them out of most other

applications. The worm turned in the 1980s, and the last laugh is on the high-mu family. For although the 811A, 572B, 3-500Z and other high-mu types continue to be popular in RF applications, the large, crude 845 has become nearly a religious object to neurotic audiophiles, especially in Asia.

Today

Simply compiling a list of all the firms that made 211s in the past 70 years would be an impossible undertaking; 211s were astoundingly popular before 1950, then nearly became museum pieces. In spite of the wide manufacture of 50-watter tubes in their variegated forms, in the 21st century we are down to two manufacturers: a Chinese factory, and Richardson Electronics in Illinois. The Beijing "Sino" factory produces generic clones of the later GE 211/VT-4C and the late RCA 845, both with graphite plates and aluminum-shell bases. Richardson makes an 845, allegedly on the original RCA tooling, in small quantities and selling for a high price under the Cetron label. Manufacture of later relatives, such as the 805 and 810, continues in China and at Richardson.

Although the "true" 50-watter types have been reduced to two specialty manufacturers serving the high-end audio market, there is a similar tube from Russia: the Ulyanov GM-70. Its basing is unique and its mu is about 7, yet in many respects it is amazingly similar to the 211. This triode, made since the 1940s, is little-known outside of the Russian electronics industry.

Outro

So, it appears that the 50-watter is showing new life and continued manufacture into the 21st century. In spite of its sheer impracticality, the obsessive and demanding audiophile market continues to maintain its availability, and probably at prices that would shock our fathers. Remember, as recently as the early 1970s one could buy a WWII surplus VT-4C for as little as \$4.

Bibliography

1. **70 Years of Radio Tubes and Valves**, John Stokes (Vestal Press, Vestal, NY, third edition, 1992), pp. 127-132.
2. **Transmitting Tube Catalog and Guide**, Taylor Tubes, Inc., 1937.
3. **Tube Lore**, Ludwell Sibley, Flemington NJ, 1997.
4. **Saga of The Vacuum Tube**, Gerald F. J. Tyne (Howard W. Sams Publishing Co, Indianapolis IN, 1977), p. 150, 151, 287, 288.

Many thanks to Lauren Peckham of the Antique Wireless Association, Al Jones of the Transmitting Tube Museum, and Brother Pat Dowd for their invaluable assistance with the historical background.

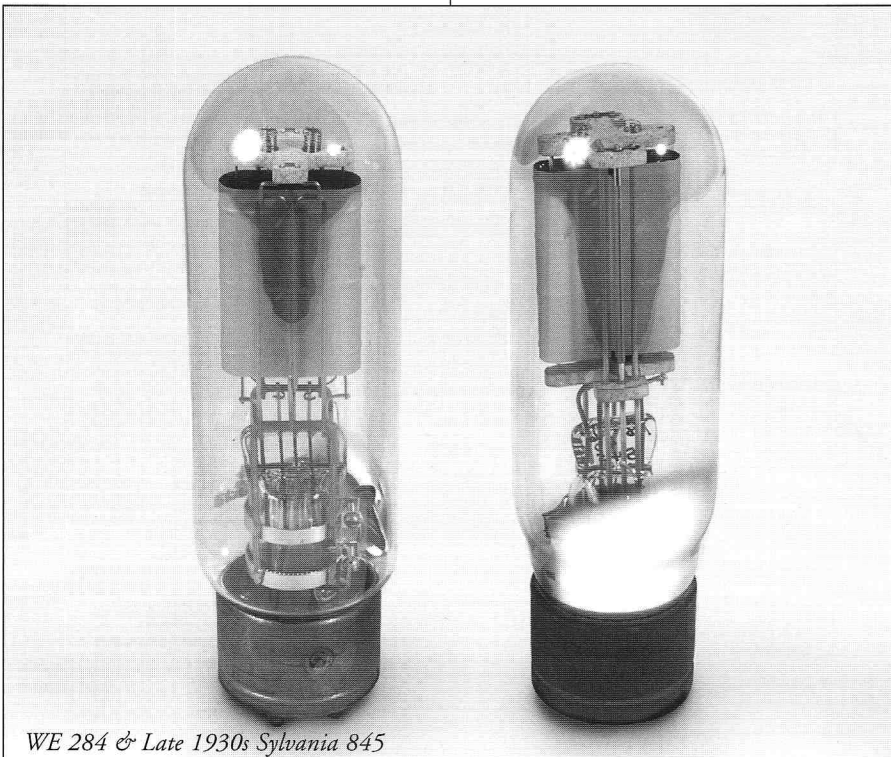

WE 284 & Late 1930s Sylvania 845

A Transmitting Tube Test Amp

By John Atwood © 1998 All Rights Reserved

Testing the audio performance of power tubes with plate voltages higher than 500 volts becomes more complex than simply dropping the tubes into a conventional amplifier - mainly because there are few amplifiers available for these tubes. Transmitting tubes also come with a variety of socket types and filament voltages. To help us evaluate transmitting tubes, a single-channel (mono) test breadboard was built with a large degree of flexibility in audio testing 211-class transmitting tubes. In addition to being a good "test-bed," it turns out that with good tubes and transformer, it sounds quite good, and could be the basis for a high-quality single-ended power amp.

CAUTION: *The amplifier described in this article is intended to be used only for testing components, and has deadly high-voltage points exposed! If you want to use the circuit for general purpose listening, it needs to be packaged so that all high-voltage points are safely enclosed!*

Test Amp Design

Being a "one-off" design, the 211 test amp was built around components on hand. Key to the amp is a good, high-quality high voltage power supply. A Fluke 3010 precision high voltage supply had recently been picked up at a ham radio swap. Its maximum ratings are 1011 volts and 500 mA. It would have been better to go up to 1250 volts (the maximum rating of the 211 and 845), but 1000 volts was still reasonable. Since both the output tube and output transformer would have to be easily changed, a wooden bread-board construction was used, with high-voltages enclosed where possible. Three tube sockets were ever installed, accommodating the jumbo four-pin 211-types (203, 211, 838, 845, etc.), the regular 4-pin types (SV811, SV572), and a specially-modified 829-type socket to hold the Russian GM-70 tube. A blank space was left for the output transformer, where either clip leads or wire nuts were used to attach to the transformer under test. A separate wood breadboard held an unregu-

lated DC filament supply, with its voltage adjusted by a desk-top Variac. The driver stage and bias supply were mounted on the main board.

A simple driver using an old pentode and a filamentary triode without feedback gives a good low-impedance drive with decent frequency response and distortion. The 6J7 pentode may look unfamiliar to tube purists, but the older low-transconductance types can sound very good. The 6B4G allows a low 10K plate resistor with high plate voltage while producing low distortion. To insure good voltage swing, a 600 volt power supply is used. This may seem high compared to the 325 volt maximum rating, but keep in mind that in a transformer-coupled amplifier, which this rating was meant for, the plate can have voltage peaks twice the B+ supply. Used as a resistance-coupled amplifier, the 6B4G runs conservatively in this application. While initially designed for driving just the 211-type tubes, the driver has enough head-room so that it can drive 845s. The regulated bias is not enough for the low mu of 845s, but simply pulling the 0D3 out of its socket allowed the bias to rise high enough for our tests.

The driver circuit is only meant for driving tubes in the negative-grid region (no grid current). This is the most common mode for medium and low mu triode output tubes. By adding a strong cathode follower, say a triode-connected EL34 or 6550, positive grid operation (class A2) of the output tube is possible, opening up the amp for use with high-mu tubes such as the 838, 811A, and SV572-160.

Running the 6B4G filament on DC is essential, since AC causes intolerable hum. A simple solid-state supply with choke filtering is used. The 0.6 ohm power resistor was picked to give 6.3 volts DC at the filament. The high voltage needed for the

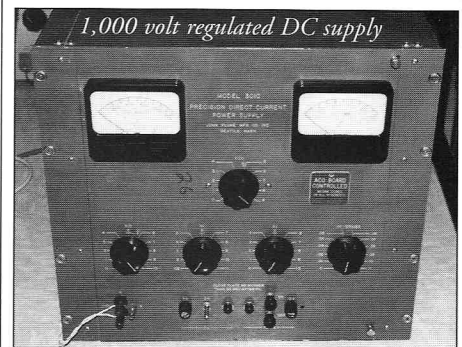

driver stage is obtained by using a standard radio-type power transformer running into a voltage doubler. The 6AX4GT damper tube rectifiers give a nice slow turn-on. The 6AX4GT is abundantly available in North America as a surplus TV tube.

The high voltage for the output tubes is run through a 0-100 mA meter mounted in an old sloping "meter" box. Also in the



Table 1 - Transformer Tests

Transformer	Pri. Res.	-3db HF response
Audio Note 50W/10K/211SE158Ω	33.9KHz, w/peak at 72.2KHz
Bartolucci #28249Ω	19.3KHz, w/peak at 53.9KHz
Electra-Print KL10KB-B122Ω	28.1KHz, w/peak at 79.0KHz
Tamura F-2013297Ω	23.6KHz, no peak
Tango XE60-10 SNF322Ω	92.2KHz, no peak

The transformers were bench tested with a sine wave oscillator driving the transformers through a 4.7K series resistors. The transformers were terminated into a non-inductive 8 ohm load. Primary inductance measurements were tried using the Freed 1011 inductance bridge, but there was difficulty in getting the bridge nulled. Later investigation showed that at the highest inductance range needed to test these high-impedance transformers (> 100H), bad paper capacitors in the bridge prevented it from nulling. The lower ranges used mica capacitors, which were OK. Even test equipment needs re-capping! *(The bridge was recapped before any testing was done. Ed)*

The Japanese transformers tested well, with good-looking 10KHz square wave response. Both the Electra-Print and Audio Note had reasonably good HF response, although were somewhat lumpy. The Bartolucci had the worst HF response of the transformers tested in this grouping— but interestingly sounded quite good!

Table 2 - Tube Tests (211 types only)

Tube Type	Condition	DC Vg	AC Vg	Power	THD
GE VT-4Cused	-52.4V	24.7V	5.0W	1.2%
.....	"	42.1V	13.5W	3%
GE JAN CG-211 #1used	-51.9V	24.6V	5.0W	1.05%
.....	"	43.2V	14.0W	3%
GE JAN CG-211 #2new	-53.9V	25.5V	5.0W	1.3%
.....	"	43.5V	13.5W	3%
National 211 (China) #1new	-49.4V	25.3V	5.0W	1.2%
.....	"	41.8V	11.2W	3%
National 211 (China) #2new	-50.2V	24.9V	5.0W	1.2%
.....	"	41.9V	11.2W	3%
United CUE 38111used?	-53.7V	24.2V	5.0W	1.1%
.....	"	42.3V	14.3W	3%
RCA 211 (prewar) #1new	-49.8V	24.0V	5.0W	1.25%
.....	"	40.3V	13.0W	3%
RCA 211 (prewar) #2new	-50.2V	23.6V	5.0W	1.25%
.....	"	40.1V	13.0W	3%
RCA VT-4Cused	-50.9V	24.6V	5.0W	0.95%
.....	"	42.8V	13.5W	3%
WE 211Dused	-45.0V	23.8V	5.0W	1.35%
.....	"	38.5V	11.0W	3%
Svetlana SV-811-10new	-66.4V	30.0V	5.0W	1.35%
.....	"	52.7V	14.5W	3%
Svetlana SV-572-10new	-75.0V	32.0V	5.0W	2.1%
.....	"	44.3V	9.2W	3%
Russian GM-70new	-91.8V	34.0V	5.0W	0.85%
.....	"	70.4V	22.0W	3%

(845 types were not tested because the test amp driver stage was designed specifically for 211s.)

box are a bypass capacitor (to help keep high-frequency audio currents local to the amplifier) and a neon HV indicator. Since a lab-type high voltage power supply was used for this project, a schematic for a stand-alone HV supply was not developed. A good reference for those interest-

ed in building high-voltage supplies is the Radio Amateur's Handbook, published yearly by the American Radio Relay League (Newington, Conn., USA). Editions from the 1960s and earlier are gold-mines of circuit and construction information for the tube amp builder.

Extensive metering was used to insure accurate and repeatable operating conditions. In addition to the calibrated HV supply and plate current meter mentioned above, VOMs and DVMs were used to measure grid voltage, filament voltage, and AC grid drive voltage.

Testing Philosophy

The goal of the transformer and transmitting tube testing was to run the unit in a similar environment to that of a real amp. However, due to fixed transformer impedances and different characteristics between tubes, comparisons between differently spec'd units (i.e.: 7K vs 10K or 211 vs 845) are not really valid since these have different optimum operating points. However, comparisons of like units are valid. Also, both electrical tests and listening tests would be done. As both forms of these tests were carried out over a period of several months, preferred operating points changed, and will be noted in the test results.

Tube Technical Measurements

Two different measurements were done on each tube to evaluate their inherent distortion and power output capability. Unlike earlier tests published in VTV, a standard harmonic distortion meter (Sound Technology 1700B) was used, which captures all harmonics and noise. To keep hum and noise problems down, a 400 Hz high-pass filter in the analyzer was engaged. The test signal was a 1KHz sine wave. Distortion tests were run at a constant power output of 5 watts (6.32 Vrms across a 8 ohm load). This is higher than the earlier VTV tests of 1 watt, but the low distortion of these tubes allowed noise to dominate at this low power level. For power output tests, a distortion level of 3% was arbitrarily picked as being well into clipping for all the tubes. The Electra-Print KL 10KB10K output transformer was used for these tests. The tubes were run with a 1000V plate supply biased to 60 mA.

The American tubes were remarkably consistent in biasing, gain, and distortion, with the RCA VT-4C having the lowest distortion at 5W. The Chinese 211s biased-up similarly to the American ones, but had significantly lower maximum power. This could be explained if their characteristic curves were non-linearities at the extremes. Several vintage WE 211Es (which have oxide-coated cathodes) were tested, and many had unstable bias currents. Even the one finally used for the test drifted a bit over time, whereas all the other thoriated-tungsten types were rock-

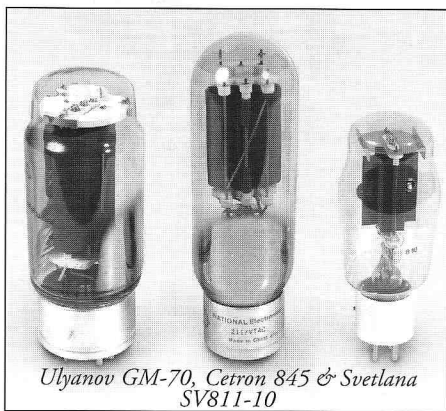

Ulyanov GM-70, Cerron 845 & Svetlana SV811-10

solid. The SV-811-10 was a like a bit lower mu 211 – with slighter higher maximum output power. The SV-572-10 was a marginal performer, apparently due to high distortion. The GM-70 was a killer tube, with low distortion and high power. This is to be expected from a lower mu tube, which is why the 845s were not tested against the 211s. As with all these tests, it should be noted that the statistical sampling of tubes is quite small, so be careful not to draw major conclusions from the data. Two old Western Electric 211D tubes from the 1920s were tested. One would draw normal plate current for about 1 minute, then would slump to a low value and distort heavily. Another used 211D (listed in Table 2) worked well, but still had a somewhat variable plate current. These old WE tubes use oxide-coated filaments, compared to the thoriated-tungsten of all the other tubes tested. The plate current on the thoriated-tungsten types was rock-solid.

Summary

Transmitting triode amplifiers raise the amp construction difficulty to a higher level than conventional low-impedance amps: more dangerous voltages, expensive high-impedance output transformers, strange tube sockets, lots of heat. However, good amps using these tubes have a distinctive “big” sound - open, spacious, and dynamic - that is appealing. These big triodes are definitely the starting point for the “ultimate” tube amplifier.

Atma-Sphere™ Amplifier Kits: Musically Authentic!



M-60 Mk. II Kit \$2295 (Pictured)
60 Watts of Tubed, OTL Purity

“...Breathe in and out
like the music...”

—Art Dudley
Listener, Spring '97

Authentic? Now there’s a word rarely associated with audio gear. By definition “authentic” means **genuine, pure, real, accurate**. Exactly the words describing the true note-by-note musical presentation of all Atma-Sphere audio gear. Musical authenticity begins with the designer.

Ralph Karsten, our Chief Designer, could have easily built solid state amps. Karsten, however, has the true desire to build genuinely accurate and purely transparent gear. Solid state cannot do it! Output transformers cannot do it! So Karsten engineered and patented a totally new design combining, **within each chassis**, the musicality of two singled-ended tube amps with more authoritative bass power than a single push/pull amp and with **no** output transformer to snub the music.

“...making fires in my soul...”

—Harvey Rosenberg
Positive Feedback
Vol. 6, No. 6 - April '97

* **CALL NOW** for information about our kits and full line of factory-built Class A, All Triode, Zero Feedback, OTL Amps and Preamps!

Quietly Producing The World’s Finest Audio Gear!



Atma-Sphere Music Systems, Inc.

The OTL Leader, featuring Balanced Differential Design™

160 So. Wheeler, St. Paul, MN 55105 • Phone 612-690-2246 • Fax 612-699-1175
www.atma-sphere.com

CORRECTION: VTV #8 - Page 12 This is the correct schematic for the Alan Kimmel OTL Amp. **Do Not** use the schematic shown in issue #8.

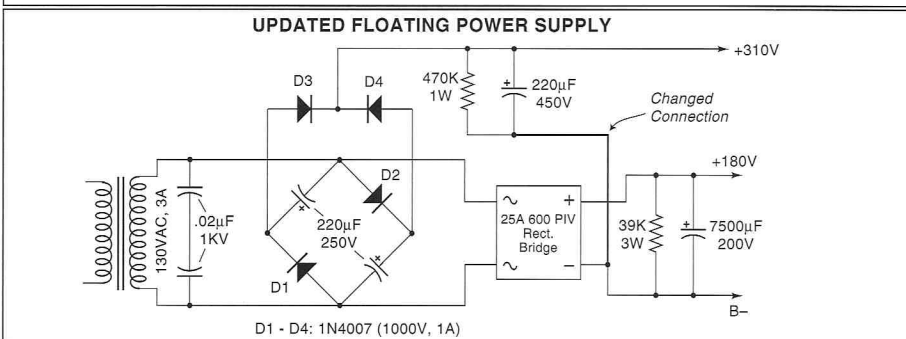

Howard Bardach, CET
Service Provider

AUDIO
specialist

13251 #D Ventura Blvd.
Studio City, CA 91604
Bus. (818) 995-8648
Fax. (818) 995-8647

The Eclectic Audio/Video Service Center

VTV #9 has an error on the transmitting tube amp voltage doubler power supply schematic on page 10. The 6AX4GT is wired wrong and must not short across the power transformer. John Atwood will be posting the corrected schematic in the next issue and on <http://www.vacuumtube.com> very soon. DO NOT BUILD THIS CIRCUIT WITH THE SCHEMATIC ON PAGE 10.

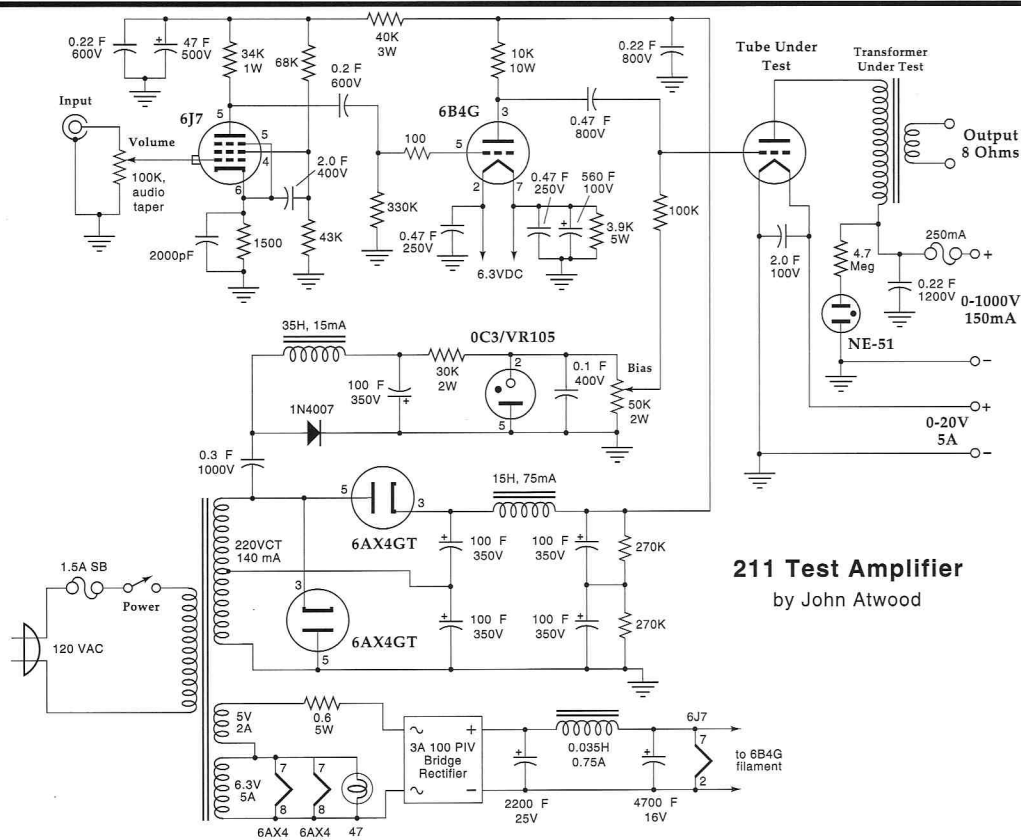

Uncle Eric's Dumpster Type 2C51/5670 By Eric Barbour

© 1998

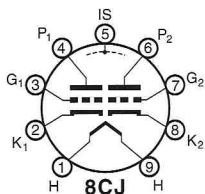

Introduced in 1946 by Western Electric, this miniature dual triode is allegedly an RF only device. Yet our distortion and listening tests seem to indicate high linearity at typical levels in an audio line stage. Later versions were introduced as type 2C51 by Sylvania and Tung-Sol. WE's in-house number for the 2C51 was 396A. The 407A is similar to the 396A, but has a 20/40V filament and was used extensively in Bell System carrier repeaters. If grid-plate capacitance worries you, the 2C51 is safer than common miniature triodes, as it is usable up to 800 MHz.

Since it was popular in VHF applications, many variations of the 2C51

appeared in the 1946-1960 period. Occasionally used in early computers, the premium version 5670 was once widely manufactured. It has controlled warmup and tight specifications on grid current, noise and microphony. The 5670W was used extensively in 1950s military equipment.

The much scarcer 6385 is the Bendix "Red Bank" version. Its heater draws 500 mA rather than 300, and it has an internal shield between the triodes. The 6385 is a super-premium, but not really a better audio performer than a common 2C51.

6386 is a variable-mu version commonly used as a gain-controlled cascode RF amplifier. Although not really suited for hi-fi use, it has a special audio application. The most valuable vintage electronic

device today may be the Fairchild 670 limiter, which can sell for up to \$25,000. The 670 is unusual in that it uses two gain control cells made from four 6386 triodes in parallel. Since it is not used in any other current application, and is out of production, old stock can only go up in price. If you want to invest in an NOS tube, the 6386 looks like a good bet.

6854 is very similar to the 6385, except in a ruggedized form with hard glass and extra bracing. And the 7861 is a GE "Five-Star" version with a 12.6 volt heater for mobile radio equipment.

This is a good time to use this family in audio, as 1980s military-surplus 5670s of good quality are readily available from dealers, at absurdly low cost. So don't ignore it.

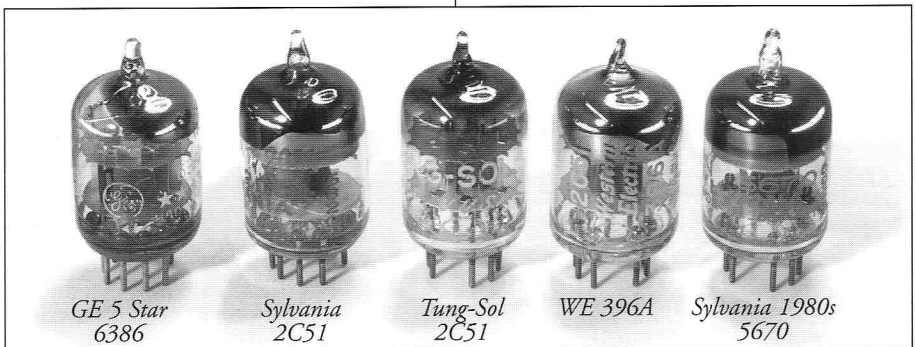

VTV Listening Tests: 211/845s and 10K SE Transformers

By Charlie Kittleson © 1998 All Rights Reserved

Over the last several months, the VTV staff and a number of local audio enthusiasts have been conducting listening and evaluation tests of both new production and NOS 211 and 845 tubes. The larger 50-watt triode SE amplifiers have more power and realism than the majority of 300B amplifiers, based upon opinions expressed during listening tests at VTV. For the audio enthusiast who simply must have the most compelling sound, 211/845 amps are the way to go. Manufacturers including AudioNote UK, Cary Audio, Bel Canto, Wavac and many others are offering 211/845 SE amplifiers, but the price typically starts at \$3500 and up.

The series of transmitting tube related articles in this issue will give the reader & home constructor detailed information, electrical test results and listening tests of new and vintage 211/845 types. The tube listening test was done in conjunction with our listening evaluations of new production 10K output transformers using John Atwood's test amp, described on page 7 of this issue. Additional equipment used in the test included an Elite Electronics CD player or the new Dynaco CDV-Pro tube CD player and either B&W DM-110 or Klipsch Chorus I eight ohm loudspeakers. Program material consisted of well-recorded female vocals, contemporary jazz and classical music including Beethoven's Symphony #5.

Tubes were typically run at anywhere from 760 to 1000 volts with plate current from 60-100ma. In addition, we also auditioned the Ulyanov GM-70, a huge, low-mu thoriated tungsten transmitting tube from Russia. Note that this test does not include all possible combinations of tubes and transformers. This is because we began to notice characteristics in tubes that made us gravitate towards the better sounding ones later in the tests. There are other 10K SE transformers available on the market, but these were not made available to us for this test.

In our listening tests at VTV, we have noted that several factors can have an

impact on sound quality and performance. For the driver stage in Atwood's test amp, we noted the 6B4 triode brand could change the overall sound quality. For example, the 1940s Sylvania 6B4 had a slightly congested midrange when compared to the Tung-Sol 6B4s; these were cleaner and more detailed in the mids. In addition, the metal RCA 6J7s were not as open sounding as the glass-type Sylvania 6J7GTs, which were lighter and had more "air."

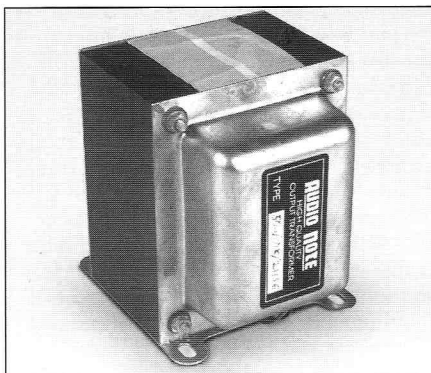

AudioNote UK #205 10K

The AudioNote 205 transformer is a beefy unit that is non-potted and uses the standard copper windings. Other, higher priced 10K units are available from them using superior materials, including silver wire. The transformers were first tested with a GE VT-4 (211) set at 980 volts running 60 ma. With this combination, we noted very good bass response and a smooth upper treble range. Next, we tried the AudioNote with a 1943 date code RCA 211, with the same voltage settings as above. This combination resulted in a similar sound to the VT-4, but with a little better midrange.

Next we tried a 1940s RCA 845 set at 760 volts and 60 ma plate current. This combination resulted in a clean, detailed sound with incredible depth. The lower plate voltage was needed to keep the tube within biasing range. In addition, the mid-bass had much better presence. The

845 gave much better integration to the sound and was very musical. Then we listened to a United Electronics 38111 (military number) set at 980 volts and 60 ma. This tube sounded clear and integrated, with a less aggressive presence than the GE VT-4s. The sound was well balanced with deep bass and excellent dynamics. With this transformer and setup, the United 38111 was the best overall sounding 211.

We obtained an early 1930's Western Electric 211D and noted the sound to be similar to the RCA 845, except the overall soundstage was a little smaller and the tube made less power. The old WE 211 had better balance than many of the other 211's and had good dimension and detail. The early 211s should be run conservatively (under 800 volts and 60 ma) to avoid any problems.

The last tube we tried with the AudioNote 10K was the Ulyanov GM-70 with its huge carbon anode. It was set at 980 volts and 100 ma. This tube (mu 7) has a big, authoritative sound, but still demonstrates intimate delicacy. The bass is big, but is not as integrated as some of the 211s and 845s in this test. With an optimized driver circuit, the GM-70 would make the ultimate heavy metal single-ended amplifier.

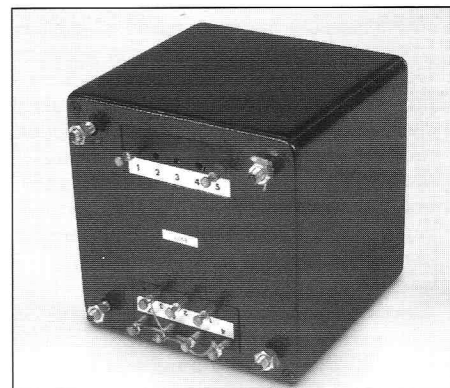

Bartolucci

The Italians are at it again with three 10K transformers from Bartolucci. These handsome, potted units are all very musical and will work very well with horn-type speaker systems. We listened to the Model #29 10K unit with a 32 watt rating using the GE VT-4C tube. The bass was big, solid and well controlled. Mid frequencies were smooth, lush and rich sounding, extremely musical. Next we tried the Bartolucci #58 10K SE unit with the United Electronics 38111. This combination gave a deep, convincing bass that was almost romantic sounding. The highs

and the mids with this combination were very engaging and rich sounding. The highs were not as extended as the other transformers in this test, but this could be a plus for those with sensitive horn speakers who don't want harsh highs. Overall, the Bartoluccis were very easy to listen to, but are not for the extreme high frequency detail freak. For those who want a romantic, "European" sound, go with the Bartolucci 10K units.

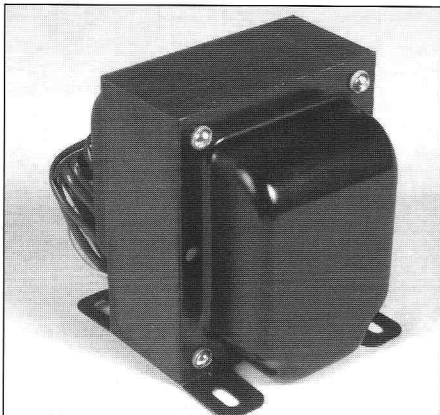

Electra-Print

For this test, Jack sent us two versions of his KL10KB, 10K SE output transformer. This hunk of iron is huge and appears to be extremely well-made. The second version has more extended high frequency response than the first prototype we reviewed. Again, settings on output tubes were 980 volts and 60-ma plate current, unless otherwise noted. The first tube we tried with the Electra-Print was the GE VT-4 that exhibited a big sound, but was somewhat forward when compared to the lower mu 845s. This tube has good attack, with super-extended mids. Next came a 1974 vintage, American-made Cetron 845 that turned out to be an excellent sounding tube (close to the RCA 845), very musical with a sparkly sound. The SV811-10 worked well with the Electra-Print, giving clean, balanced sound. The SV572-10 was similar in sound, but did not put out as much power in this setup. Then we tried the United Electronics 38111 with the Electra-Print; that resulted in a bigger bottom-end and a wider bandwidth. This "American" combination was a little forward sounding, but not harsh in any way. Then came the RCA 211 which proved to be musical and involving. This combination had good timing and sweet, seamless detail. Next, we plugged the RCA 845 into the socket and noted a similar performance to the RCA 211, but with deeper bass. Then came the Ulyanov GM-70 that we ran full-tilt at 1000 volts and 120

ma. This combination with the Electra-Print was excellent, very musical, but didn't have as much deep bass the RCA 845. *Note that the GM-70 is extremely difficult to get and is not available from any Russian tube vendors at the current time.*

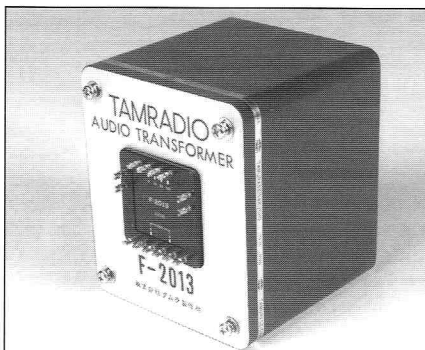

Tamura

We sampled the beautiful and huge Tamura F-2013 10K SE unit. Using the GE VT-4C, this transformer had the deepest bass, clean and accurate mid-frequencies and super-extended highs. However, the pace and timing were a bit slower than the AudioNote or the Electra Print units. Next was the 1943 RCA 211 that gave a crisper, fuller and more three-dimensional sound than the GE VT-4. Then we plugged in an RCA 845 set at 950 volts with 65ma plate current. This combination was detailed with very clear sounding instruments and voice reproduction. The bass response was extremely convincing and optimum. The next tube we tried was the SV572-10 which was powerful, clean sounding and had a low noise floor. The 572 did not have the power or bass response of the larger tubes. Then came the United Electronics 38111. This combination was accurate, involving and balanced sounding. The response was smooth and very detailed with great top end. Overall, a "real" sounding tube and transformer combination. Lastly, we used the Cetron 845 that gave a super balanced sound with clean powerful punch. The Cetron with the Tamura is very accurate and musical. The Tamura has more of a hi-fi tilt, but in some speaker systems with sensitive horns, this characteristic might sound a little sizzly. Overall, the Tamura appeared to be the best made and had the deepest low bass.

Tango

Many Japanese OEMs used Tango iron in their tube electronics products. We sampled the Tango XE-60-10, 10K SE unit. This transformer is beautiful, well

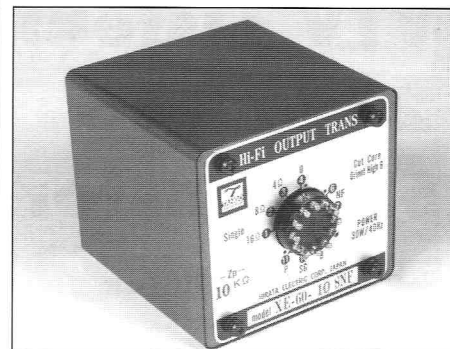

made and has excellent characteristics. With the GE VT-4C, the sound was refined and polite, almost courteous. Even though the unit was sweet and dynamic, the soundstage seemed smaller than many of the other transformers in this test. The Tango had excellent high frequency measurements. Sound improved with better bass, detail and balance using the 38111, RCA 211, RCA 845 and Cetron 845s.

Conclusions

After listening to all the 50 watter family transmitting tubes in this test, we came to some enlightened conclusions. The GE-VT-4 is the most common NOS type and works very well. Improvements are made by using the RCA type 211 and 845, however, these tube are now very rare and NOS examples can cost over \$300+ each! The United Electronics 38111 is an excellent 211 type, but is even harder to find in any quantity than the RCA types. The glass tipped WE types as well as the 242 and 284 types are extremely rare collector's items and can cost over \$500+ each in NOS condition. Svetlana SV572 and SV811 types are unique tubes that we know sound good in circuits optimized for them.

The best buys are the Chinese-made 211s and 845s which can be purchased for under \$50 each. The Chinese 211s had good mids, but the bass was softer and highs thinner than the others in this test. However, these tubes have an expected service life that is significantly less than any of the American types. The best new production 845 is the Richardson-Cetron 845 that is currently being made at their facility in La Fox, Illinois. According to Richardson officials, they have the original RCA tooling and equipment for the 211 and 845 types. If you want a new, reliable 845, the Cetron is the way to go. These tubes will last much longer than the Chinese types, are easier to source and come with a factory warranty.

The Ampeg SVT: History and Variations

By Terry Buddingh © 1998 All Rights Reserved

Ampeg History

In the late 1940s jazz bassist Everett Hull had a singular vision—to provide bass players with a quality means of amplification. He mounted a small microphone (made by Clevite) to the retractable end-pin of his bass and called it an “Ampeg” (short for amplified-peg). Hull teamed with Stanley Michaels to design an accompanying bass amplifier, and together they formed the short-lived Michaels-Hull Company. In 1949 Hull and Michaels dissolved their partnership and the Ampeg Company was officially born.

For historical perspective it’s important to know that Gibson’s brilliant innovator Lloyd Loar experimented with electrified bass in the late ’20s. Rickenbacher and Vega were selling electric upright basses and amps by the ’30s and Leo Fender introduced his first Precision bass in ’51 and his first Bassman amp in ’52.

The first amplifiers produced by the new Ampeg Company were designed with the assistance of the great Norman Crowhurst, who would become one of the most prodigious authors in the field of

audio electronics. (Many of his books were published by the notorious Hugo Gernsback.) Eventually there were four versions of the Ampeg Bassamp ranging from the 15” Jensen speaker equipped, single-channel model 835, to the monstrous 950C with three channels and two 15” speakers. In 1953 bassist/designer Jess Oliver (a.k.a. Oliver Jespersen) joined the Ampeg team and was instrumental in its growth from the small two-room factory in Brooklyn to the 40,000-square-foot modern facility in Linden, New Jersey. It was during this period that Ampeg began to develop a reputation for quality by enlisting endorsements from esteemed players like jazz virtuoso Oscar Pettiford.

To fully understand Ampeg it’s necessary to understand Everett Hull and Jess Oliver. They were both professional bassists that regularly performed the standard and jazz tunes of their day. They spent decades meticulously refining the nuances of their craft. They felt it was their responsibility to protect and defend the music they loved from the “crude, loud, and vulgar” rock music that was, to their dismay, becoming increasingly popular.

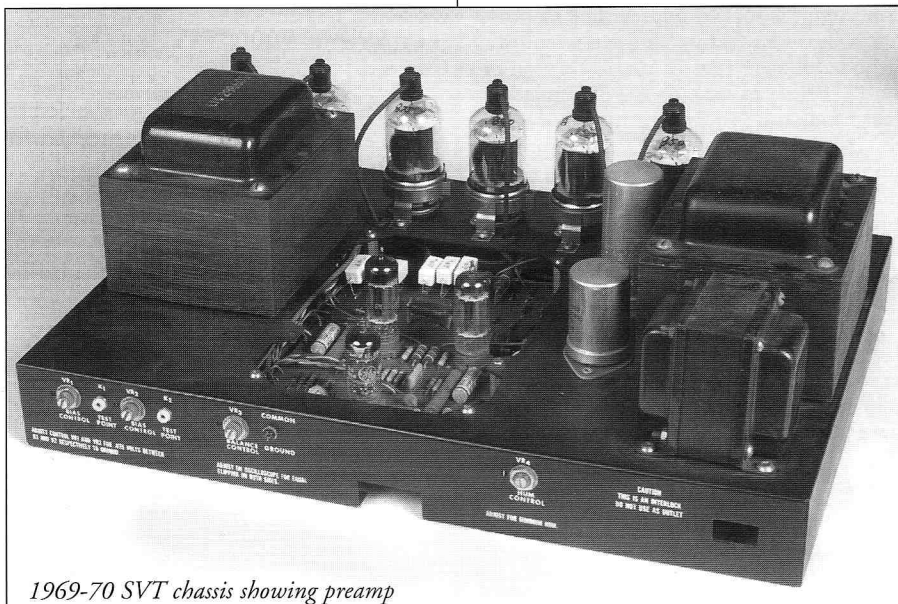

1969-70 SVT chassis showing preamp

The B-15 Portaflex

The move to Linden in February 1962 marked the beginning of the modern era—an era of change—for Ampeg. Their need for growth was propelled by the success of their first true classic—the Jess Oliver designed B-15 Portaflex (introduced in 1960). It incorporated an innovative “flip-top” configuration which concealed the amplifier’s chassis inside the closed-back speaker cabinet for safe transportation. This would eventually lead to the amazing Oliver amps with motorized electronics that would dramatically elevate from their cabinets. (Truly a sight to behold!) Over the years the B-15 would go through many stages of design evolution. The earliest versions were cathode-biased and used point-to-point wiring on eyelet boards similar to Fender’s (but narrower). These first versions were exceptionally sweet sounding, but not very loud. Later versions used fixed-bias and PC boards. My favorite is the B-15-N which employs three 6SL7s (I love their fat richness), a pair of 6L6s, and a 5AR4 rectifier. Other versions use 5U4s or solid-state rectifiers, 12AX7s, 7199s, and 7027s.

The B-15 would become the industry standard for recording in the ’60s. The role of the electric bass was redefined by the great James Jamerson, who played his ’62 Fender Precision bass through a B-15 on many gigs and some recordings. To clear-up a common misconception, however, it should be noted that on most of the Motown hits recorded at the famous “Hitsville USA” studio in Detroit, the bass and guitars were recorded direct through a one-of-a-kind six-channel pre-amp made especially for Motown. Jamerson’s contemporary at the Stax label—Donald “Duck” Dunn—amplified his ’58 Precision bass with a B-15 as well. The deep blossoming bloom of the B-15’s liquidly round and warm bottom, and exquisitely detailed, sweet and expressive midrange defined the very essence of great bass tone.

The B-15 sounded great in the recording studio, but as the ’60s progressed—and the volume levels increased—it became apparent that a pair of 6L6s was not sufficient to keep pace with the 100 watt guitar amps that were gaining in popularity with the rock players of the day. If Ampeg was to keep pace with the times, a higher powered version of the B-15 would soon be necessary.

The UNI Music Period

Hull and Oliver would stubbornly resist the need to acknowledge the changing



1969-70 Ampeg SVT



1974 Ampeg SVT



1977 Ampeg SVT



1980 Ampeg SVT (Japanese version)

times until 1967, when a group known as UNI Music began to purchase Ampeg stock. By 1968 UNI Music had acquired sole ownership of Ampeg. Fender and Gibson were dominating the marketplace with products that appealed to the rapidly growing number of rock players. Ampeg had an image problem—they were still building amps with accordion inputs! It was finally time for Ampeg to assert itself as an industry leader by producing a truly earth-shaking product—the biggest, baddest, most impressive bass amp ever seen.

The Ampeg SVT

In the late '60s the Acoustic 360 had established itself as the bass amp of choice for the discriminating player seeking the ultimate bass tone (and volume). It became an obvious target for the Ampeg design team. Their mission was clear—beat the 360 in every way possible. The 360 sounded dry and one-dimensional due to its all-transistor design, and its folded-horn speaker cabinet design sounded good in a big room, but sounded less than impressive up-close.

Ampeg's Chief Engineer Bill Hughes was responsible for the design of the SVT circuitry. The SVT's preamp was derived from the B-15. Channel 2 is nearly iden-

tical to a B-15 preamp, with a few changes in component values, and a few minor embellishments. The B-15 and SVT (as well as many other Ampegs) used the same tone control filter network which incorporated a primitive integrated circuit comprised of two resistors and four capacitors. Channel 1 can be thought of as an extremely embellished (or hot-rodded) B-15 preamp. The Ultra Low circuit is further embellished to provide a Bass Cut feature, and is driven by a cathode follower (the "12AU7" portion of the 12DW7/7247 which is a dissimilar dual triode tube equivalent to 1/2 of a 12AU7 and 1/2 of a 12AX7). The most unique feature of Channel 1 is its midrange control—it uses a tapped toroidal inductor to select the midrange center frequency. The choices are 220Hz, 800Hz, and 3,000Hz. It also uses two additional "12AX7" stages and one more "12AU7" stage derived from 12DW7s. The two channels sum into a 6C4 (similar to 1/2 of a 12AU7) used as a cathode follower. It's obvious Bill was fond of the low impedance drive characteristics of a 12AU7 (or equivalent) used as a cathode follower!

The prototype SVT (short for "Super Valve Technology") used four 811A thori-

ated-tungsten-filament power triodes running at 1250 volts! (It evolved from a record cutting amp that Bill built prior to the SVT's development.) It was decided that this was perhaps a little too dangerous for a consumer product and an alternative, lower voltage output tube would be used in the production models. 6146B/8298A beam power tubes had proven their ruggedness in taxicab two-way radio service. What environment could be more harsh than a New York City taxi?

Bill Hughes would accompany Ampeg's newest endorsers—The Rolling Stones—on their 1969 "Gimme Shelter" tour. Crude, loud, and vulgar, The Stones epitomized everything Everett Hull hated about rock music; his teeth are probably still grinding! The band torture-tested the new obscenely heavy, 82 pound, 300+ watt SVT (and its alias the V-9). Keith Richards and Mick Taylor plugged them into 4x12 guitar cabs, while Bill Wyman used the new 8x10 bass cabs. Their live album "Get Yer Ya-Ya's Out!" was recorded during this tour on November 27th & 28th at Madison Square Garden in New York City. Their rather clean guitar and bass tones were obtained at what were most assuredly excruciatingly loud volume

1969-70 SVT with 6146s

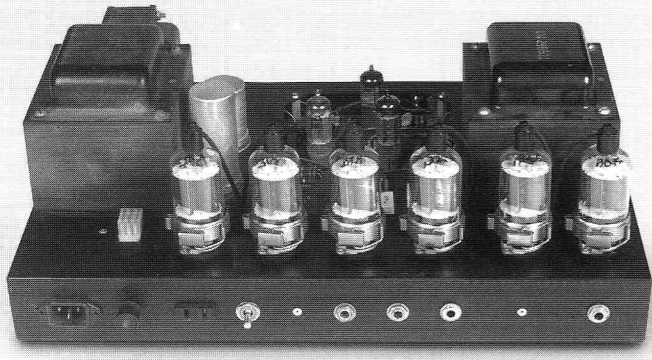

1980 SVT with 6550As (Japan)

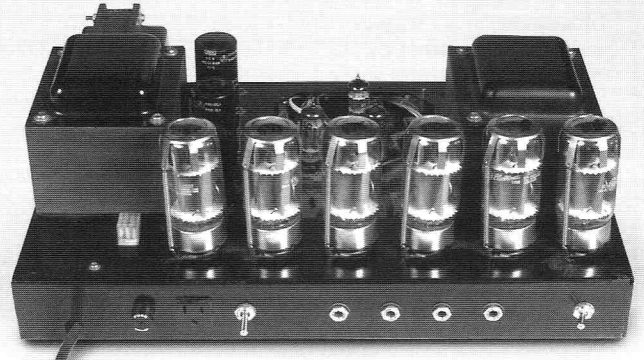

levels. While the 6146B/8298As held up to the mechanically abusive environment of taxi cabs, they were shown to be less tolerant of the abuse provided by the Rolling Stones—they would self-destruct when pushed into clipping for extended periods. Which, of course, the Stones did continuously. The SVT would soon be redesigned for six 6550 beam power tubes.

Roger Cox designed the 150 pound 8x10 speaker cabinet. It was intended that each SVT head drive two cabinets for a total of 16 speakers! In contrast to the Acoustic 360's long-distance focusing folded horn, the SVT cab was designed to pressurize your head at point-blank range. It was designed to blow away the Acoustic 360 where it mattered most—the music store! It used eight 32 ohm speakers wired in parallel for a total load of 4 ohms per cabinet. Each horizontal pair of speakers resided in its own sealed enclosure. Essentially, four 2x10s were stacked on top of each other. A totally revolutionary and unprecedented approach to bass speaker design! In head-to-head shootouts the SVT would annihilate the Acoustic 360. Bill Hughes and Roger Cox had accomplished their mission—to build the meanest and most impressive bass amp on the planet. It's still the standard by which all contenders must be judged.

SVT As A Hi-Fi Amp?

Just for kicks I set-up a pair of SVTs in my hi-fi room and accessed the power amp sections through their line-in jacks. It became quickly apparent that the gigantic-ness of the SVT's sound comes from, at least in part, the power amp. From a hi-fi perspective, the top is extremely rolled-off, but the bottom is huge! And over 300 watts per channel of tube power provides an incredible dynamic range. Victor Wooten's bass on Bela Fleck's "Flight Of The Cosmic Hippo" sounded like he was thumpin' away right in front of me! The notes on his low B string were

thunderous! OK, so the cymbals were practically non-existent, and the other instruments were more than a bit overshadowed, but from a bass player's point-of-view, this was hi-fi heaven. The SVT's monstrous dynamic range was apparent on Ahmad Jamal's "The Essence, Part 1". Ahmad's piano playing displays masterful dynamics, with gentle caresses swelling to out-right assaults, and the SVTs conveyed every ounce of his powerfully dynamic performance. The piano sounded as big as a house! Don't get me wrong, I'm not advocating SVTs as hi-fi amps; they really don't have anywhere near the kind of clarity, resolution, detail, or extended frequency response that you would expect from even an average hi-fi amp, but if you're a hard-core bass fiend, it's a sound you'll never forget.

Estimating Year Of Manufacture

The 6146B/8298A version would last until late 1970, when the output tubes would be replaced by 6550s. The earliest amps can be easily identified by their short black plastic toggle switches and blue lettering on the front-panel. The back panel reads: The Ampeg Co. Inc. Linden, N.J.. Rock bassists who prefer to use guitar picks rather than bare fingers find the 6146B/8298A amps have a particularly aggressive midrange grind that is especially enhanced by their pick attack. In 1971 Ampeg was sold to Magnavox and the manufacturing was moved to the Magnavox factory in Greenville, Tennessee. The early Magnavox amps can be easily identified by their metal toggle switches and the lettering "Division Of The Magnavox Company" on the back panel. Later '70s Magnavox amps can be identified by the plastic rocker power switch and rectangular pilot light. The Magnavox era amps are generally favored for their huge and deep bulldozing bottom end. More accurate estimating of the date of manufacture can always be accomplished by observing the date codes on potentiometers, filter caps, and the tone

control's primitive integrated circuit. Ampeg was sold to Music Technology Inc. in 1980. The electronics were assembled in Japan and the cabinets with spring-loaded handles and cut-away tops were made in the US. The most obvious electrical differences are in the foreign looking transformers. They also reduced the B+ voltages by about 5%. Perhaps not quite as beefy sounding as the Magnavox era amps, they're still capable of producing a sweet and pleasant tone, favored by some for that reason. The reduced voltages also increase reliability slightly. In 1986 Ampeg was purchased by St. Louis Music. They revived the SVT's waning prestige by reissuing a limited-edition run of 500 SVTs using the same parts vendors as the Magnavox-made Ampegs. Due to limited availability of 12DW7s and 12BH7s, the current SVTs have been redesigned to use the more readily available 12AX7s and 12AU7s. The preamp has been significantly simplified, but the power amp is very similar to the original. The output transformers are still manufactured by ETC of Paramus, New Jersey. The power transformers are provided by an off-shore source.

The new Fender Rumble-Bass amp has a preamp that's even less similar to an SVT, but the power amp design is almost identical. Bill Hughes now works for Fender and apparently he knows that the SVT power amp is a classic that can't be topped.

Care And Feeding Of An SVT

Most SVTs were shipped with Mullard made 12DW7s. These were extremely well-made and great sounding tubes. If you find an SVT with the original Mullards, chances are they have many hours of service-life left. They have a strong, muscular sounding midrange drive that makes them the perfect choice for the world's meanest bass amp. A Telefunken 12DW7 in the first stage of channel 1 can add a hint of subtlety and refinement, if

THE AMPEG SVT

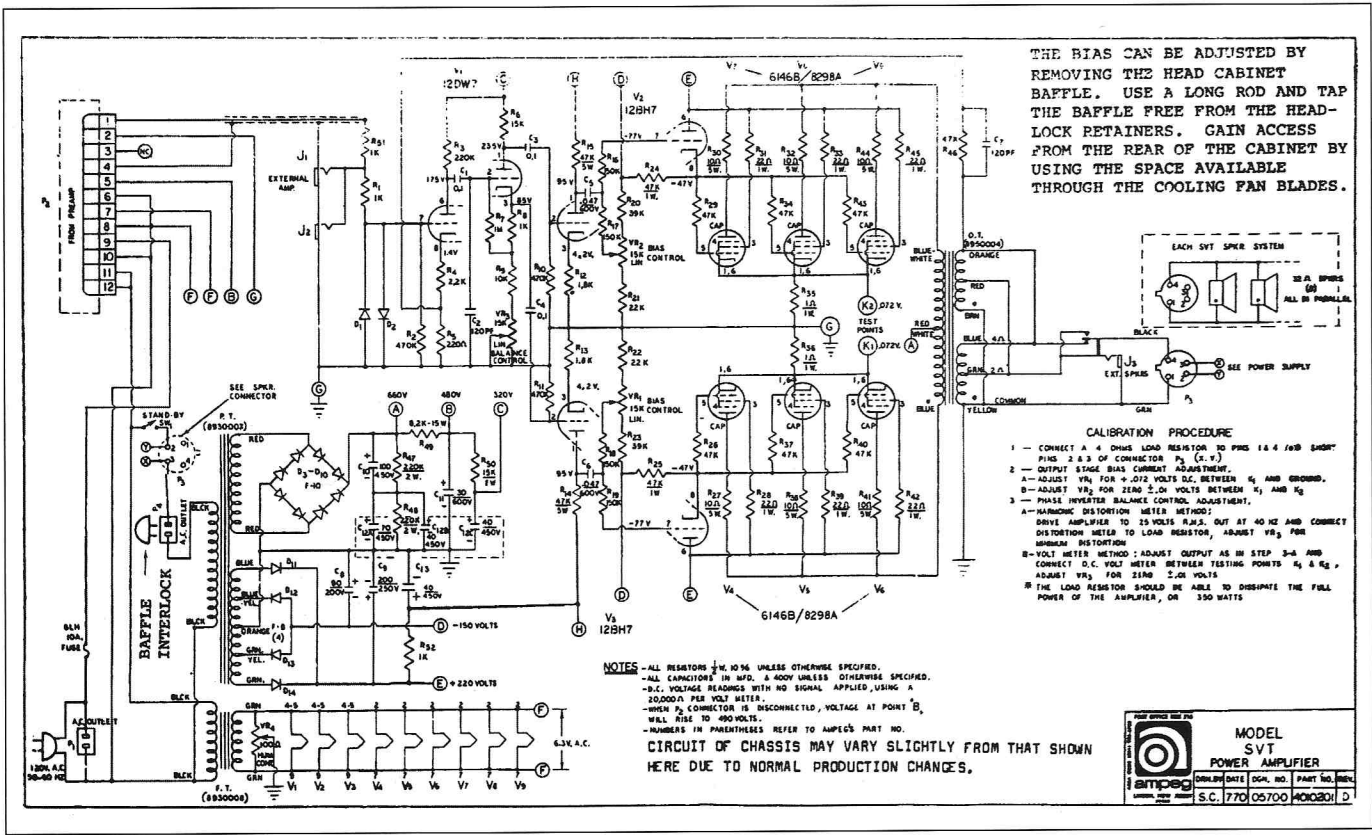
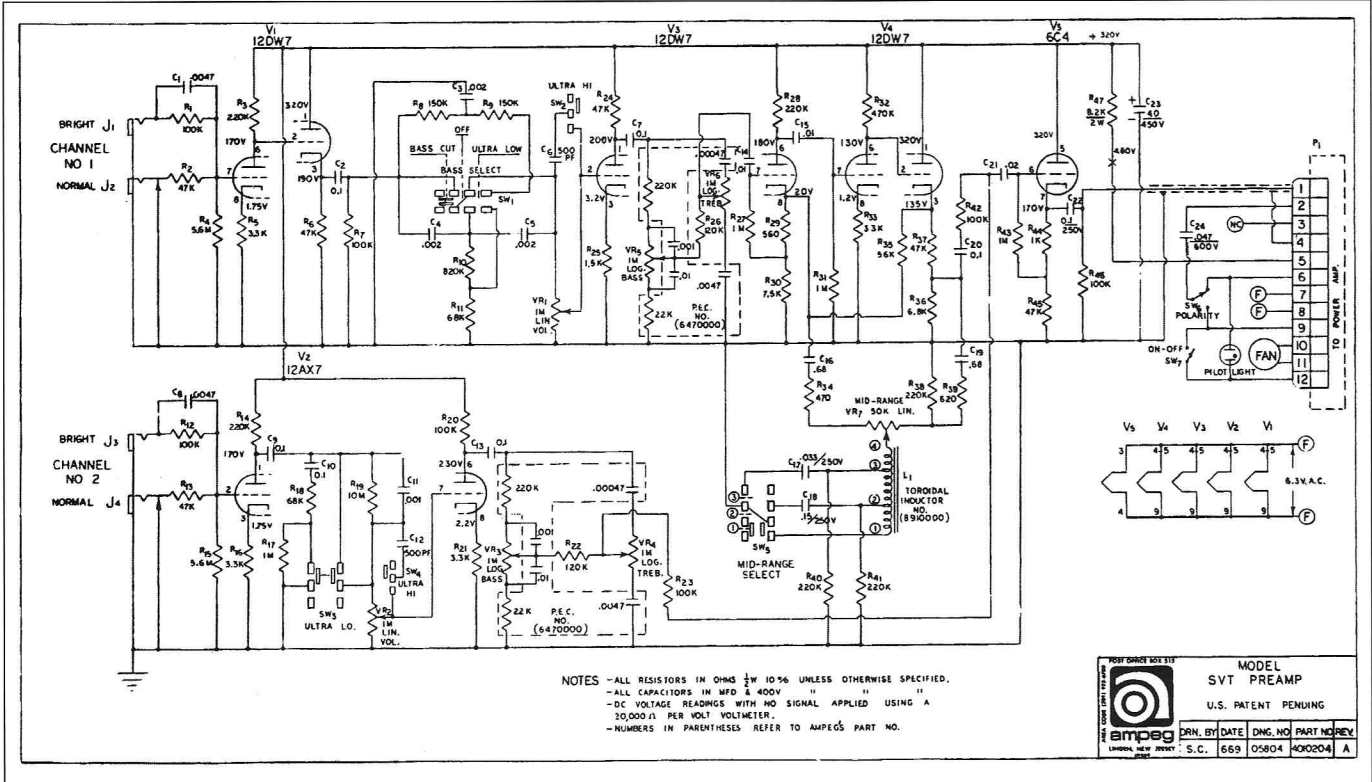

that's what you're seeking. I've tried the well-known 12AX7 conversion and found it changes the sound; I prefer the sound of 12DW7s. I find the General Electric 12BH7s to provide the fattest drive for the output stage. Try to find a matched pair—triode 1 should match triode 1 of the other tube in transconductance and cathode current. Triode 2s should also match.

You should try to match everything in the push/pull output stage: control grid resistors, screen grid resistors, and plate resistors. Previous tube failures can have a dramatic effect on the values of these resistors and the tone of the amp. I've seen 10 ohm plate resistors that measured over 4K ohms! Also check the hum balance pot and bias pots and resistors. On some amps the output transformer taps were incorrectly wired to the switch on the extension speaker jack. When the extension jack is not in use the normal output jack should be wired for 4 ohms. Check the color code on the schematic. The truly obsessive will probably want to replace the 15K bias and drive balance pots with 10 turn Heli-pots for less sensitive and more stable and precise bias and balance adjustments—the originals are quite touchy. Other mods have been implemented to reduce bias-pot sensitivity.

Speaking of bias, the originally specified idle current of 24 ma per tube could be considered a bit conservative. If you believe you have a sturdy set of output tubes (Chinese 6550s need not apply), you might be tempted to try a bit hotter bias. My richest, best balanced, and most refined sounding SVT has six Genelex KT88s idling at about 33 ma each. Some SVTs were shipped with Tung Sol 6550s—these have an incredibly detailed midrange and lacy top better suited for guitar amps and hi-fis than bass amps. Players seeking obscenely deep, ground-pounding bottom will be happiest with the GE 6550s. The sweet and clean sounding Svetlana 6550C compliments the sound of the Japanese built MTI amps especially well, just don't push the bias excessively hard—watch for hot-spots. I've found the Teslovak KT88's bias to be prone to instability and the tubes can arc unexpectedly. The GE 6146B/8298A (with the flat sides on the end of the plates) are the most trouble-free, but I wouldn't stray too far from the recommended 24 ma per tube idle current. Then again, sometimes biasing is a test of your bravery and faith....

The preamp's rocker switches can get dirty and intermittent and cause noise and volume loss; they should be checked and cleaned frequently. Pots and sockets

should be cleaned regularly as well. Early SVTs had the speaker cable permanently attached to the amplifier; this cable has seen lots of abuse by now and should be replaced with a speaker jack, since an intermittent load on an SVT can be quite spectacular! It's best to think of an SVT as a high performance = high maintenance machine, akin to the muscle cars spawned in the same era.

True tube amp connoisseurs will have no problem identifying with the sound of a properly set-up SVT: The unmistakably round and liquid warmth, the sense of multi-dimensional air and space, the powerful sense of breadth and depth, and the taut transient wallop that can be claimed only by the king of all bass amps—the Ampeg SVT.

Terry Buddingh is a performing bassist and a guitar amplifier expert. He is a frequent contributor and guitar amp reviewer for Guitar Player Magazine and related publications.

Tube Lore

A REFERENCE FOR USERS AND COLLECTORS

For serious users, a new look into tubes from 1920 to the present: history of design trends, "where used" information, tech data, equivalencies, "user's guide," even auction prices. See review by Eric Barbour in the Winter 1997 VTV. Contains 186 pages, 8-1/2" x 11" softbound. Orderable from:

- Antique Electronic Supply, (602) 820-5411
6221 S. Maple, Tempe, AZ 85283
- Antique Radio Classified, (508) 371-0512
PO Box 2, Carlisle, MA 01741
- Museum of Radio & Technology Bookstore
4204 Thorn Apple Ln., Charleston, WV 25313
- W7FG Vintage Manuals, (800) 807-6146
3300 Wayside Dr., Bartlesville, OK 74006

Or order directly from the author:

Ludwell Sibley
44-V E. Main St.
Flemington, NJ 08822

Price if ordered direct, postpaid: \$19.95 in US or Canada, \$24.95 ppd. elsewhere.

Discounts available to groups on orders on quantity purchases.

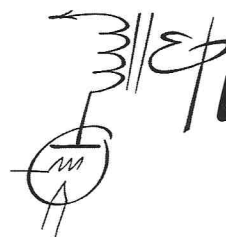

ELECTRA-PRINT AUDIO

QUALITY HANDWOUND S.E. OUTPUT TRANSFORMERS

- Primaries from 1.8K to 10K
- Exclusive wideband design
- 16, 8, 4, or 2 ohm secondary
- Gold plating

CUSTOM-BUILT POWER TRANSFORMERS/CHOKES

- Wound to your requirements
- Heavy-duty design for Class A use
- DC filament supply windings
- HV chokes to 15H, 300ma
- Low voltage, high current filament chokes

Component pricing and specifications catalog available

ELECTRA-PRINT AUDIO

4117 Roxanne Drive Las Vegas, NV 89108
702-396-4909 FAX 702-396-4910

Computing With Tubes: The Savage Art

3. The First PCs Were Not Made In 1975

By Eric Barbour © 1998 All Rights Reserved

The so-called "digital revolution" continues to steamroller on. Driven by hype and avarice, this movement is facilitated by the public maunderings of a gang of remarkably ignorant journalists and self-appointed visionaries. An excellent recent example was a special section in the *San Jose Mercury News* of March 2, 1997. In this supplement, called "Behind The Wave," various *MERC* scribblers were given plenty of space to blather about how the Internet has become essential to human existence, such that even looking for a job requires e-mail and the World Wide Web. Overall, it looks like a business-friendly puff piece, of the sort commonly seen in daily newspapers around the United States and intended to make local advertisers feel warm and happy inside. Yet this particular item simply regurgitated the long-held homilies about the development of computing--many of which are distorted, if not outrageously false.

Ask any Silicon Valley engineer: what was the first personal computer? Since there is no hard-and-fast definition of a PC, you will encounter as many answers as there are engineers in Silicon Valley. If the person being asked is knowledgeable, the most likely response will be the MITS Altair of 1975. This was the first PC to be "widely" available to hobbyists, at a "low cost"--whatever that means. (These folks usually fail to mention even earlier machines: IBM 5100, Scelbi 8H, Micral.) Yet one could make an excellent claim for the idea that "personal computer" is a fairly broad category, which immediately eclipses even the 5100, Scelbi or French-made Micral.

If we want to define a "personal computer" as physically small, generalized in design for a variety of scientific and commercial uses and intended for use by a single operator, then these early micro-computers are left in the dust. If you're picky, then the Digital Equipment Corporation PDP-8 was a personal computer.

Yet as horrible and heretical as this

sounds, the "personal computer" predates even the use of transistors! For by 1955, numerous small computers were in daily use in scientific and business data processing. All were intended for use by a single person, and most were no larger than a typical office desk. These machines tended to have a typewriter for input-output, usually the popular (and slow) Friden Flexowriter with paper-tape reader/punch. And nothing else. Some of the larger machines could support a pen plotter, a line printer, perhaps a magnetic tape drive or a simple CRT for primitive vector-based graphics. Yet these are all basically "personal." And most scandalous of all, not only did these machines contain no integrated circuits, they did not even use transistors!

Why? Well, the semiconductor devices of the early 1950s were very primitive. So little was known about this technology that early point-contact devices, commercially available (and expensive for many years), were in fact barely adequate for use in pocket AM radios. The *Mercury News* people claim that the invention of the transistor in 1947 changed computing, yet they seem not to know that transistors were awful until circa 1958. At first they were point-contact, had low gain and very high noise figures, varied enormously from sample to sample, and were anything but rugged. Junction devices, which started to appear in quantity

around 1954, had similar problems.

The first programmable computers to use transistors were experimental units, hybrid in construction: RAND Corporation's JOHNNIAC in 1954 and Lincoln Labs' TX-0 in 1955. The first all-transistor calculating machine to be demonstrated, a multiplier built by Bell Labs in 1951, used point-contact devices and was unreliable. Further, the first programmable all-transistor computer, Bell Labs' Leprechaun of 1956, was an experimental prototype only and was not manufactured due to reliability issues. Until the supply of junction devices was steady and consistent in quality, they had to be individually selected for computer use. Special computing tubes were far more consistent and more reliable.

So: up to 1958, building a computer meant using tubes. Luckily, the availability of decent germanium diodes made the logic circuits of computers smaller and simpler. Even so, switching and buffering were done with tubes. Despite misconceptions about tubes constantly "burning out," some machines ran for months at a time without failures. Nearly all the things we take for granted today in computers were developed with tube technology. If more proof is required, following are descriptions of the world's first personal computers. You won't find a single transistor in any of them.

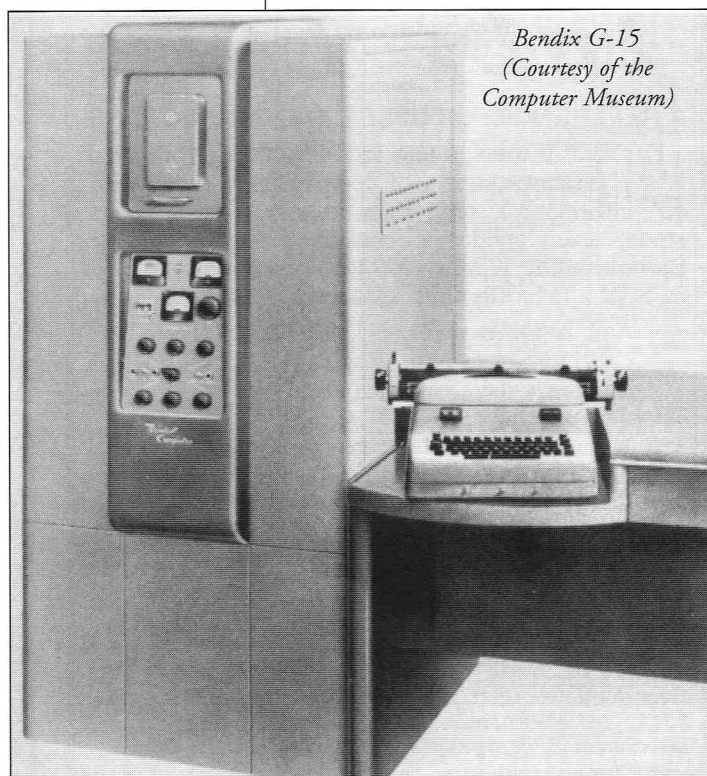

*Burroughs E101
(Courtesy of the Computer Museum)*

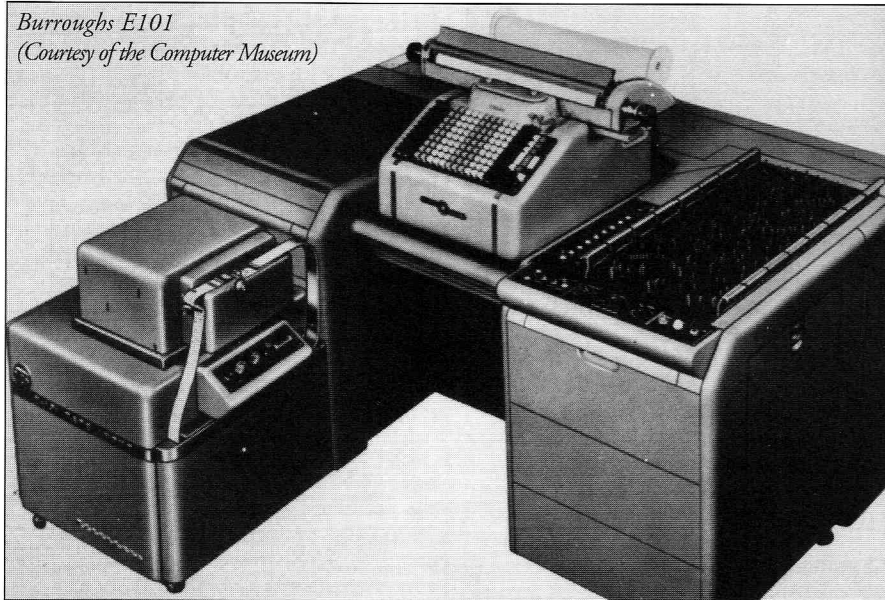

Bendix G-15

Imagine a big art-deco-like refrigerator from the 1940s, and you'd have the G-15, one of the most popular computers of the 50s. It was simple and small enough to use in a typical office. Memory was a magnetic drum, as usual for this period, holding 2160 words of 29 bits each. Registers were on a special fast-access part of the drum. Adding two single-precision numbers took a blinding 540 microseconds--slowed by the need to access the drum, typical for all drum-memory machines of the day. Even so, at the time this was a fairly fast computer.

Unlike the LGP-30 below and some others, the G-15 could accept various peripherals. Magnetic tape drives, paper tape and card punches, and even a plotter were available. A basic G-15 used 400 tubes, mostly 5967s, and 3000 diodes. Addition of peripherals required an external interface cabinet. Operating uptime was reported to be 90-98% for typical users, many of which were defense contractors or state highway departments. It is reported that the Nebraska Highway Department was using a G-15 until 1982. Considering that more than 200 G-15s were sold between 1955 and 1960, it's surprising that so few have survived.

Burroughs E101 and E102

One of the first desk-sized computers, the E101 was wildly popular with defense contractors and military agencies, as well as banks and other kinds of companies. More than 80 had been sold in the first 4 years after the 1953 introduction. It used "pulse-coded decimal," meaning it was not capable of static operation--pulse

length encoded each digit. A word was 12 digits wide plus a sign bit, and 220 words were stored on its magnetic drum. Adding took 50 milliseconds due to the time-division scheme of its logic, and due to the slowness of the drum memory.

It and the similar E102 had a plug-board panel, removable to allow exchange. Parts of program flow could be set up on a panel, so the program would refer to panel settings. This was thought to make the programs shorter and simpler. The keyboard and printer were a Burroughs "Sensimatic" console, modified from its normal business-accounting uses. Programs were read from a paper tape operating at 2 characters per second. The E101 consumed 3000 watts and weighed 1800 pounds. It should be easy to see why the E101 was quickly eclipsed by faster machines with more memory capacity.

Librascope LGP-30

This was unquestionably the coolest, hippest computer of the 1950s era. It was styled by professional industrial designers, and wrapped in a slick metal case with a chrome accent strip. Other small computers usually were sold in ugly grey or dark-green boxes, intended to impress the manage-

ment with their massive ugliness. By comparison, the Librascope computer had loads of STYLE. And it cost a mere \$39,600, a pittance at a time when typical mainframes were \$200,000 and required a staff of 3 to 10 people to keep them running.

The LGP-30 was remarkably advanced, in spite of the lack of transistors. Its ingenious design, by Dr. Stanley Frankel of Cal Tech, used a minimum of electronics and was totally serial-synchronous. Operating registers could be displayed on a small CRT. Main memory was 4096 words on a magnetic drum, and given that a word was 30 bits long, the LGP-30 had far more memory capacity than the early Altairs--in fact, about as much as the original Apple II. Only 112 tubes and 1500 germanium diodes were enough to do everything required. Sixteen machine instructions, and why have any more? Input and output was by Flexowriter, and adding peripherals was difficult at best. Add time was 8.75 milliseconds, very fast compared to similar machines like the Burroughs E101. This slick little gadget weighed 800 pounds, used 1500 watts and required only a small window-type air conditioner in warm weather.

Since the drum held data with the power off, there was little need to re-enter the operating software when power was switched back on. And a good thing too, since it had to be re-entered from a punched tape at 5 characters per second, which took more than an hour. The basic system had a simple console monitor and subroutines for computation. Reliability was apparently excellent, with no service

*Librascope LGP-30 and guest
(Courtesy Lockheed-Martin Librascope)*

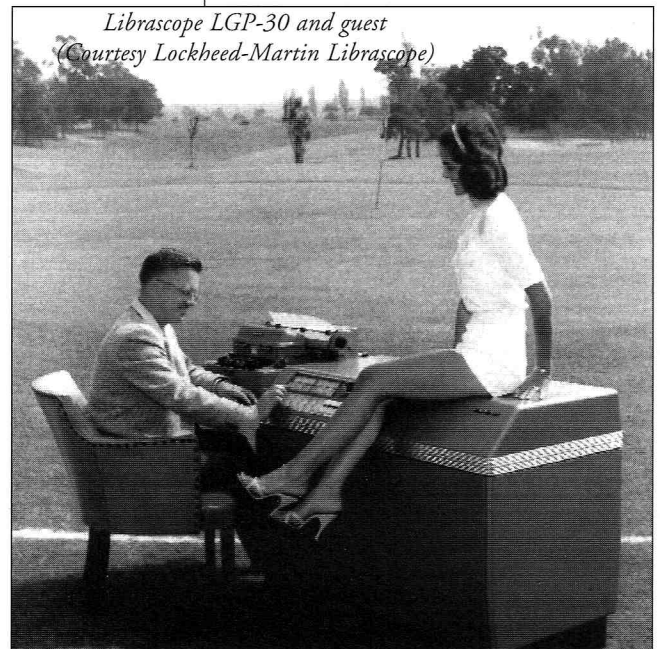

technician being needed on the company staff. Tube failures occurred only at intervals of weeks, comparable to that of many transistorized mainframe systems of the 1960s.

The LGP-30 sold until more powerful small computers, such as the IBM 1620 (which was apparently introduced specifically to compete with the Librascope), appeared in 1959-1960. A few LGP-30s, donated by the engineering firms that originally bought them, were being used to teach programming in California schools well into the 1970s. Librascope also sold these machines to companies such as Control Data and the Royal Precision marketing firm, who then stuck their own logos on it for sale. So, the LGP-30 was apparently the first "generic" PC. Royal ran ads for the LGP-30 in a variety of magazines.

The LGP-30 even got its own high-level language compiler in late 1959, called ACT-1. Unfortunately its transistorized replacement, the RPC-4000, was announced at about the same time. This, the 1620, and other frantically introduced transistor computers of the period sent the LGP-30 into the dustbin of history by 1960. Librascope later became a builder of computer systems for defense work, and is currently a division of Lockheed Martin.

Monrobot III

Monroe, a reputable maker of mechanical calculators, entered the electronics business with the Monrobot series. The smallest was the III, yet another desk full of tubes with a Flexowriter on top. The first sample was sold to the US Air Force Cambridge Computing Center in 1955. With 800 tubes crammed inside, it had a not-so-good uptime record of 80%, and outside of hard failures, Monroe required one hour of regular maintenance every day. Its drum held 100 numbers and 100 program instructions, in separate areas. Addition of two 20-digit decimal numbers required 0.12 seconds, including drum access. Just reading a location took 15 milliseconds, and the system ran on a 10-kHz clock. And it used 2500 watts and weighed 1000 pounds. Even the larger Monrobot V was just as slow and primitive. Interesting, that early computers made in-house by big business-machine companies tended to be poorly designed.

Readix

J. B. Rea Company was a "start-up" firm that did not survive the early days.

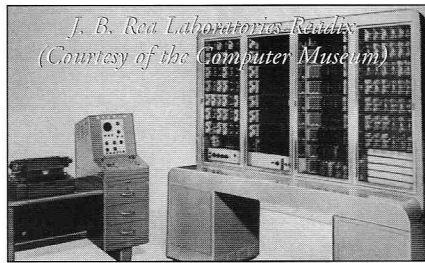

Their Readix machine was aimed at defense customers for engineering work, though it was also claimed to be suitable for business data processing. It had 260 tubes and 3000 diodes in a large cabinet with impressive-looking glass doors showing off all the circuit modules. Readix was expandable, with optional point plotter, magnetic tape drive, and an interim register for attaching IBM punch-card units. A word was 10 BCD digits, add time was 17 milliseconds including drum access, and the drum held 4000 words. A feature not often seen on these smaller computers, but standard with large mainframes of the era, was an oscilloscope for troubleshooting. Free, at no extra charge.

Underwood Elecom 50

All the business-machine manufacturers tried to jump into the computer world during the 1950s. Underwood, a venerable typewriter manufacturer, was no exception. Their Elecom 50 was first delivered in 1955, and it followed their successful Elecom 100 of 1952. Elecom 50 roughly corresponded to the Librascope machine, with 160 tubes and 2000 diodes. Words were 10 decimal digits, and the drum memory held 100 locations plus the 3 working registers. Apparently the I/O console was numeric only, while an alphanumeric printer was an extra option.

The Elecom 50 used 2000 watts, weighed 750 pounds, and cost a mere \$22,500--a real bargain. More than 50 had been sold by 1957, and the delivery time was 12 months. In spite of its tiny memory and limited console, the low price found it many applications. One ominous note: average running time between calculation errors was quoted at 6 hours. Like all these machines, the Elecom 50 had no error-checking systems. Calculations had to be re-run or checked by other means to ensure correct results, primarily due to bits being read incorrectly from the drum occasionally.

Exit

So long as instant experts continue to spread misinformation unchecked, the true nature and origin of computing will

be ignored and belittled. So it is with that *Mercury News* piece, a litany of self-service filled with corporate propaganda. One cannot take seriously a piece of "journalism" which claims that the only important thing to happen in computing between 1947 and 1957 was the birth of Bill Gates; which does not mention any of the important pre-ENIAC machines or any software developments of the 1950s, such as the first operating systems and FORTRAN; and which fails to cover milestone systems of the 1960s such as the IBM System/360 and the PDP-8. Still, all this is typical of today's computer journalism.

One final note: some VTV readers may have heard that early microcomputers like the Scelbi are so rare that they sell for \$8000 and up--yet the Scelbi is relatively common, compared even to popular tube computers like the LGP-30 or the G-15. Interesting, that computer collectors haven't discovered these machines yet. And this article does not even cover very specialized machines, like the Litton 20/40 differential analyzer or the Baird Atomic 580 autocorrelator.

Hopefully, this information about the earliest "personal computers" will help to dissipate the historic information void in which American computing currently wallows. And it should correct some false verities, repeated ad nauseum by people who should know better and are paid to know better.

Bibliography

1. **Logical Design of a Simple General-Purpose Computer**, IRE Transactions on Electronic Computers, Stanley Frankel, volume EC-6, number 1, March 1957.
2. **A Second Survey of Domestic Electronic Digital Computing Systems**, Martin H. Weik, Department of the Army Ballistic Research Laboratories, Aberdeen Proving Ground, Maryland, Report 1010, June 1957.
3. **IBM'S Early Computers**, Charles J. Bashe, Lyle R. Johnson, John H. Palmer, Emerson W. Pugh; The MIT Press, Cambridge, Massachusetts, 1986.
4. **Military Systems Design** magazine, November-December 1959, p. 311 and 318.

Many thanks to Richard Kennerknecht of Lockheed Martin Librascope and Dr. Leonard Shustek of The Computer Museum for their invaluable assistance in researching the facts in this article.

Winter 1998 CES Report

By Eric Barbour © 1998

It seems to get bigger each year. And every year, there are more and more vacuum-tube products. Not only was the Winter CES high-end exhibit at the Alexis Park Hotel in Las Vegas the biggest yet, the "alternative" International High-End Show was expanded to two hotels--the Debbie Reynolds and the Howard Johnson on Tropicana. And even though many listed exhibitors didn't make it, there were easily 60+ companies showing tube electronics, almost a 2-to-1 ratio over solid-state manufacturers.

It would be impossible to choose best sound, as there were so many excellent systems (and a few bad ones). And I didn't have time to hear even half of the demonstrations.

Best bass: No question, Dr. Bruce Edgar's new 35 Hz folded-horn subwoofer is one of the world's most efficient cinder-block pulverizers. And of course, his matching Series 80 horns are one of the best horn speakers available in the world today. End of discussion, and forget those old Altec or WE theater horns.

Imaging: The Sonic Frontiers amps were outstanding, as were the Lars-X and Viva displays. Still, the award goes to the new Hovland EL34 amp and matching tube preamp. Although it was heavily tilted in the treble direction, the stereo image seemed 100 feet wide and showed MAJOR front-back solidity plus height. Note to Mike Kerster: don't change anything! The SF amps imaged excellently and were more tonally accurate than the Hovland.

Best rock system: Demeter's 6550C amps, paired with Aerial Acoustics speakers, gave a powerful show without any glare or unnatural treble overtones. Not to forget Atma-Sphere's system, or Moth Audio's SV572 amp slamming into Von Schweikert speakers.

Best secret design: David Berning's new SV811 amp, using obscure RF switching power techniques to get 35 watts from one tube. Sounded great, also deserves to be in the Most Tonally Accurate category along with Sonic Frontiers.

Pleasant musicality: Mesa's new Tigris integrated amp, paired with the Samadhi Acoustics cube speaker. Not accurate, but damn nice to listen to and free of the

audiophile "screechies", while still delivering a credible 3-D image. Great for hours of casual listening. Very close second was the Thor Audio system, with tweaks courtesy of Mike Vans Evers.

Now for the part you're all waiting for, the WEIRDNESS:

a) Ralph Karsten of Atma-Sphere was showing off his newest invention: a 300B OTL amp. That's what I said, a 300B OTL. Only four 300Bs are suitable to drive a 16-ohm load to 20 watts. I heard it and can attest to its excellence.

b) Unfortunately, Moth Audio's huge 304TL SE amps weren't ready yet, and WAVAC Audio Labs did not have an exhibit of their giant 833A amps. Even so, there were plenty of companies that were totally unfamiliar to us. Audiomat, Musica Nova, Wyetech, plus the firm in the next item.

c) Lars-X Audio of Singapore showed their speaker system--a heavily modified Lowther driver in a transmission-line cabinet. Vastly better sound than ordinary Lowther setups. Driven by their prototype PSE 6AS7 amps. Great imaging, and some bass too.



de Paravicini 12AX7 amp

d) Tim de Paravicini outdid even himself by showing an amp that uses twenty 12AX7s as output tubes. Don't laugh, it sounded excellent. Ask our own John Atwood about this--he's been experimenting with 12AX7s as Class A2 power triodes recently, and reports great results. One watt output per tube....

e) A brief visit to the Sands Convention Center uncovered three car-amp manufacturers using tubes. Planet Audio, Powerammer, and Phaze Audio all used tubes as gain stages with conventional transistor outputs.

SOUND PRACTICES MAGAZINE

featuring

Cool DIY Projects
History and Classics
Future Perspectives
International News
Wild Entertainment
Refuge for Audio Nerds
and much more!!

SUBSCRIPTION RATES

1 year (4 issues) \$20 US, \$24 Canada, \$30 Europe, \$35 elsewhere.

Sample \$5. MC/Visa accepted.
Money back if not delighted.

PO Box 180562 Austin TX 78718
512-339-6229 voice/fax
www.soundpractices.com

one electronTM
Single-Ended Output Transformers
High Quality for a Reasonable Price
Designed and Built in the USA

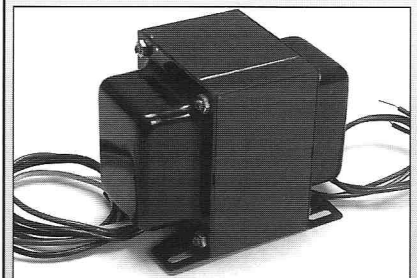

UBT-1 Designed for parallel operation of:
1.6k primary 15 watts 160 mA **\$90.25** 2A3s, EL34s, 300Bs 6AS7s, etc. or Sweep-tube in 'enhanced triode' mode

UBT-2
4.8k primary 15 watts 110 mA **\$112.10** Can be used with: 300B, 50, SV811-3, etc.

UBT-3
3k primary 15 watts 110 mA **\$121.60** Good for single ended 2A3 or 300B

Quantity discounts available

ANTIQUE ELECTRONIC SUPPLYTM
LIMITED PARTNERSHIP
6221 S. Maple Ave. • Tempe, AZ • 85283
Phone (602) 820-5411 • FAX (602) 820-4643 or 800 706-6789

Vintage Audio in Japan

1. Amplifiers and Preamplifiers

By Charles Kittleson © 1998 All Rights Reserved

Ever wonder why you can't find any of the good old audio gear anymore? Back in the early 1970's a few audio exporters, way ahead of the masses, were quietly buying up classic tube audio equipment and shipping it to eager buyers in Japan. Meanwhile, American consumers were getting misled into believing that Pioneer, Sansui and Sony audio gear with all the fancy features and switches was better than the old stuff. Sometimes I think most people were so out of it back then that they didn't realize solid state gear really sounded like crap. Even though I am writing this article now, it should have been published 20 years ago.

Back in the 1970s, dealer/exporters were running want ads that would offer to buy your old McIntosh or Marantz tube gear for \$100 or less so you would be able to buy the shiny, new black and silver plastic Asian audio boxes. The dealers would then double to quadruple their money by selling the tube gear to wholesalers and exporters or directly to retail shops in Akihabara, the electronics district of Tokyo. By the time gear was placed on the retail shelf, the price went up between five and ten times the original price. Many of these dealers unobtrusively made high six figure incomes by exporting our old audio "junk."

Japanese audiophiles were and are very picky about what they will spend big bucks for. They prefer Western Electric tubes, amps and speakers, McIntosh tube audio, Marantz tube audio, Tannoy loudspeakers, Altec Lansing tube equipment and speakers, JBL loudspeakers and RCA vacuum tubes. The Japanese are particularly obsessed with Western Electric. Capacitors, wire, resistors or anything marked WE demands premium prices. This is due, in some part, to reviewers in Japanese audio magazines writing exaggerated words of praise about the virtues of WE equipment. On the other hand, there is little or no demand for many other vintage audio brands, such as Scott or Fisher.

Condition is everything to Japanese

buyers. Equipment must be in excellent original condition with no upgrades or modifications. It is best to not recap or rebuild vintage tube equipment that will be sold to collectors, as this can reduce the value by over 50% in some cases. They are very sensitive to this condition due to past experiences of friends who purchased WE gear through the mail that turned out to be junk. Speakers must have the original cones, and vacuum tubes should be new in their original boxes, for best prices.

The vintage audio market in places such as Hong Kong, Taiwan, Korea, Singapore, etc. has recently been strong as well. However, these Asian buyers are often less particular about condition and also more open to other brands such as Fisher, Scott, Dynaco, EICO, Acrosound, etc. The prices they pay, naturally, are somewhat lower. This phenomenon has brought even more "dealer/exporters" into the fray, many of whom are after any type of tube audio gear and tend to work on much lower mark ups.

Today, there are dozens of would-be dealer/exporters advertising in the back of audio publications with a typical ad reading: "Wanted: Marantz, McIntosh, Western Electric, Tannoy....Cash Paid." Many of these fellows are purchasing the good stuff from junk collectors, garage sale pickers and unsuspecting older people who do not have a clue as to the value of this equipment. Unfortunately, most of the classic audio gear has already been exported.

If you have any of this gear and are thinking of selling it, shop around to get your best price. Some dealer/exporters have a direct connection to either a shop or distributor in Hong Kong or Tokyo and may be able to pay more. Other dealers may have to go through two to three "middlemen" or wholesalers. Of course, each middleman has to take his "cut." Some individual sellers have been successful dealing directly with buyers from retail stores, but this can take time

in order to build up trust. The Internet will certainly change the way vintage audio gear is sold worldwide. There are already dozens of audio classified sites, auction sites and newsgroups that cater to collectors and tube enthusiasts.

This article and others that follow will review classic equipment and related components that are in demand in Japan and other places. What most people would throw out as junk could be worth the price of a new car and more. The prices listed on pp. 23-23 are from Japanese retail audio shops advertisements found in John Atwood's 15-year collection of the top Japanese audio magazine, *MJ Audio Technology*. Prices are quoted in Yen and you must convert to US dollars. **Current (April 1998) value of the Yen is about 130 Yen per US dollar.** The wide variation in prices is due to equipment condition and to individual shops that price items more expensively. In the high-priced shops, buyers in Japan can negotiate 10 to 30% off asking prices.

Remember that you will **not** be able to fetch these prices in the US. What you can expect is anywhere from 25 to 40% of the prices quoted here when dealing with reputable dealers. Also remember that demand and prices for any of this equipment are extremely unstable and subject to wild fluctuations, either up or down. What is hot today may be a boat anchor tomorrow. It is not easy finding buyers that will pay you top dollar, so you may have to settle for what is offered if you are in a hurry to unload the gear.

The Asian economy is in turmoil right now, due to the economic bubble which burst a few months ago, so demand on many items may be soft. In addition, younger engineering-oriented Japanese audiophiles are not as eager to collect WE and other vintage gear as the older 45 + year old crowd. However, well-to-do Koreans and Taiwanese have become more active in collecting vintage audio now so the demand is still there.

NOTE: Only selected vintage gear is listed on pp. 23-24 due to time and space considerations. A more detailed *Vintage Hi Fi Price Guide* (\$30) is available from VTV, and is advertised elsewhere in this publication.

This article is Part 1 of a three-part series related to collecting and pricing vintage audio equipment and related accessories.

A special thanks to Hisashi Ohtsuka, Senior Editor, MJ Magazine, for his assistance with this article.

Amplifiers and Preamplifiers Low Value High Value

Altec

126A (push-pull 6L6 amp)	¥250,000	¥350,000 pair
128B (push-pull EL34 amp)	¥200,000	¥250,000 pair
256C (push-pull 807 amp)	¥250,000	¥350,000 pair
1520A (push-pull 6L6 amp)	¥250,000	¥300,000 pair
1530A (push-pull 6146B amp)	¥275,000	¥350,000 pair
1567 (tube preamp)	¥250,000	¥350,000 pair
1568A (push-pull 6CA7 amp)	¥140,000	¥190,000 pair
1569A (PPP 6CA7 amp)	¥160,000	¥225,000 pair
1570B (push-pull 811A amp)	¥280,000	¥350,000 pair
287 (push-pull 845 amp)	¥440,000	¥1,000,000 pair
287W (push-pull 805 amp)	¥450,000	¥1,500,000 pair

Ampex

807 push-pull theater amp	¥150,000	¥200,000 pair
6550 push-pull theater amp	¥200,000	¥250,000 pair

Audio Research

SP-3 (tube preamplifier)	¥150,000.....¥200,000
--------------------------	-----------------------

Brook

12A3 (push-pull 2A3 amp)	¥250,000.....¥400,000 pair
Model 10 series (PP 2A3 amp)	¥300,000.....¥600,000 pair

DYNACO

MK III (push-pull KT88 amp)	¥90,000.....¥130,000 pair
MKIV (push-pull EL34 amp)	¥100,000.....¥140,000 pair
PAS-3 (tube preamplifier)	¥50,000.....¥75,000
SCA35 (EL84 integrated amp)	¥50,000.....¥110,000
ST70 (tube stereo amp)	¥75,000.....¥130,000

Fisher

SA300 (stereo EL34 amp)	¥80,000.....¥100,000
400CX (tube stereo preamp)	¥120,000.....¥150,000
80C (mono tube preamp)	¥100,000.....¥120,000

Harman-Kardon

Citation I (tube stereo preamp)	¥135,000.....¥160,000
Citation II (6550 push-pull amp)	¥160,000.....¥250,000

International Projector Corporation (IPC)

1001 (push-pull 6L6 amp)	¥175,000.....¥350,000 pair
1011 (push-pull 6L6 amp)	¥200,000.....¥250,000 pair
1026 (push-pull 807 amp)	¥225,000.....¥300,000 pair
1027 (push-pull 6L6 amp)	¥250,000.....¥300,000 pair
1029 (SE 6L6 amp)	¥150,000.....¥235,000 pair

Langevin

101D (6L6 push-pull amp)	¥250,000.....¥380,000 pair
138 (6V6 push-pull amp)	¥140,000.....¥200,000 pair

Marantz

Model 1 Console (mono preamplifier)	¥300,000.....¥500,000 pair
Model 2 (push-pull EL34 amp)	¥440,000.....¥750,000 pair
Model 3 (crossover)	¥300,000.....¥350,000 pair
Model 5 (push-pull EL34 amp)	¥380,000.....¥600,000 pair
Model 6 (stereo adapter)	¥150,000.....¥180,000
Model 7C (stereo preamplifier)	¥350,000.....¥600,000
Model 8B (stereo push-pull 6CA7 amp)	¥280,000.....¥400,000
Model 9 (PPP EL34 amp)	¥1,200,000.....¥1,800,000 pair
Model 10B (FM tuner)	¥280,000.....¥650,000



Altec 256C Amplifier

Altec 1570B

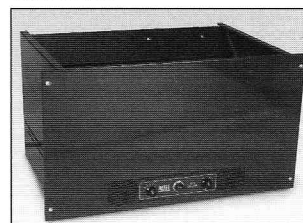
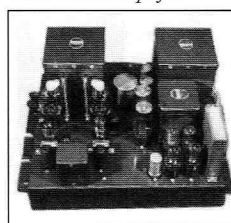

HK Citation II Amp

Dynaco Mark III

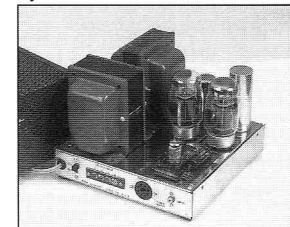

Marantz Model 9



Marantz 10B FM Tuner



Amplifiers and Preamplifiers Low Value High Value

McIntosh

A116 (push-pull 6BG6 amp)	¥190,000.....	¥250,000 pair
C11 (tube preamp)	¥150,000.....	¥300,000
C20 (tube preamp)	¥150,000.....	¥325,000
C22 (tube preamp)	¥250,000.....	¥560,000
MA230 (tube integrated amp)	¥150,000.....	¥180,000
MC30 (push-pull 6L6 amp)	¥180,000.....	¥275,000 pair
MC40 (push-pull 6L6 amp)	¥250,000.....	¥280,000 pair
MC60 (push-pull 6550 amp)	¥250,000.....	¥350,000 pair
MC75 (push-pull KT88 amp)	¥255,000.....	¥410,000 pair
MC225 (stereo push-pull 7591A amp)	¥180,000.....	¥250,000
MC240 (stereo push-pull 6L6 amp)	¥225,000.....	¥375,000
MC275 (stereo push-pull KT88 amp)	¥400,000.....	¥800,000
MI200 (push-pull 8005)	¥1,200,000.....	¥2,500,000 pair
MI350 (350 watt sweep tube amp)	¥1,500,000 and up	per pair
MR65B (FM tuner)	¥80,000.....	¥135,000
MR66 (AM/FM tuner)	¥140,000.....	¥180,000
MR67 (FM MPX tuner)	¥130,000.....	¥175,000
MR71 (FM tuner)	¥150,000.....	¥200,000
MX110 (tuner-preamp)	¥180,000.....	¥275,000

QUAD

22 preamp, II power amp	¥300,000.....	¥400,000 pair
-------------------------	---------------	---------------

HH Scott

250 (push-pull EL34 amp)	¥110,000.....	¥130,000 pair
130 (tube preamp)	¥110,000.....	¥120,000

Western Electric Amplifiers

41 and 42 (rack mounted amp)	¥2,000,000.....	¥3,000,000 pair
43A (push-pull 211 amp)	¥700,000.....	¥1,500,000 pair
46 (push-pull 205D amp)	¥800,000.....	¥1,800,000 pair
57-A (push-pull 252A amp)	¥900,000.....	¥1,500,000 pair
86, 86-A (push-pull 300B amp)	¥1,500,000.....	¥2,500,000 pair
86B (push-pull 300B amp)	¥2,000,000.....	¥3,000,000 pair
87B (push-pull 845 or 284-C amp)	¥1,500,000.....	¥2,500,000 pair
TA 1086 (push-pull 300B)	¥1,500,000.....	¥2,500,000 pair
91A (single-ended 300B)	¥1,600,000.....	¥2,000,000 pair
500A (91, power supply and speaker)	¥2,000,000.....	¥2,500,000 pair
92A, B (push-pull 300B)	¥1,500,000.....	¥2,000,000 pair
94A (push-pull 6V6/WE349 amp)	¥750,000.....	¥900,000 pair
109B (push-pull 6L6 amp)	¥800,000.....	¥900,000 pair
118A (PPP 6L6 amp)	¥500,000.....	¥750,000 pair
124A-D (push-pull 350B amp)	¥1,000,000.....	¥1,450,000 pair
142A (PP 350B amp)	¥700,000.....	¥1,000,000 pair
143A (PPP 6L6 amp)	¥550,000.....	¥680,000 pair

Western Electric Preamplifiers

105A (high-gain program amplifier)	¥1,300,000.....	¥1,700,000 pair
106A (line amplifier)	¥1,200,000.....	¥1,500,000 pair
120B (low-level pre-mixing amplifier)	¥900,000.....	¥1,250,000 pair
121A (fixed-gain amplifier)	¥1,000,000.....	¥1,650,000 pair
129B (mic preamp)	¥1,000,000.....	¥2,000,000 pair

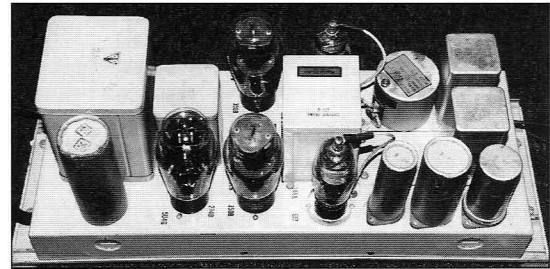

WE Type 124 Amplifier



WE Type 57A Amplifier



WE Type 87B Amplifier



WE Type 86B Amplifier

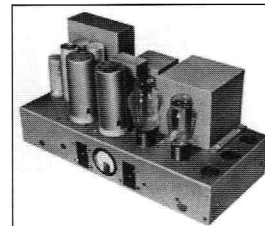

WE Type 91A Amplifier

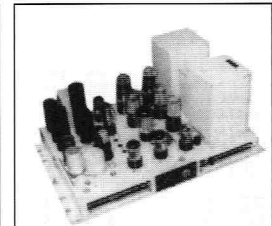

WE Type 143 Amplifier

The Audio Test Bench: Distortion Analyzers Part 2

© 1998 All Rights Reserved



In part one of this series (VTV #8, page 30) the general concept of distortion analysis was presented, a short history of analysis was given, and the philosophy of distortion analysis was discussed. In this article several actual distortion analyzers will be discussed in detail. In the next and last article the interpretation of the measured results will be covered.

To give a good idea of the methods of use and capabilities of distortion analyzers, a detailed description of several distortion analyzers that I have had experience with will be given. This will be given in chronological order, based on my experience. The personal history serves to put the use of these analyzers in perspective, and shows the growth in sophistication of audio measurements, both due to experience and more capable technology.

The Heathkit Years

While an undergraduate, I worked as a technician for the Columbia-Princeton Electronic Music Center in New York. The first audio analyzer I was exposed to was an old Heathkit IM-48 intermodulation distortion analyzer. Many amplifiers, line amps, and tape recorders were tested on this unit. We were never really sure that the numerical readings correlated to the rest of the world, but the unit was stable and we could trust it for repeatable readings on our own equipment. This type of analyzer was limited to the 60Hz/7KHz SMPTE test, which primarily exercised the equipment at 60Hz – but

this generally worked well in showing tube power amplifier distortions. Excessive hum in the equipment under test could give erroneous readings, though. The fact that the analyzer was completely self-contained was convenient.

On graduating, moving to California, and making good money as an engineer, I could finally buy a distortion analyzer of my own – this time the newer Heathkit IM-5248 intermodulation analyzer. This was solid-state, and had lower residual distortion – but was the same concept as the older tube-type IM-48. This analyzer gave very good results during my early tube amp experiments, and is still on the shelf as a back-up analyzer. Fig. 1 shows the signal flow in the Heathkit IM analyzers.

To use the analyzer in testing a power amplifier, the two-tone output is connected to the amp input, a suitable dummy load (typically an 8 ohm power resistor) is connected to the amp, and the analyzer input is connected across the dummy load. After making sure that the low frequency signal (60Hz) is exactly four times the amplitude of the high frequency signal (7KHz), the two-tone output is brought up until the desired power output is reached. The analyzer is then switched to the “Level Set” mode, and the input level of the analyzer is adjusted for a full-scale reading on the meter. The analyzer is then switched to the “IM” mode, and the input level switch is set to give a

meter reading in the top 2/3rds of the meter scale. This number, multiplied by the level switch setting, is the IM distortion.

A very helpful modification to the Heathkit IM analyzers is to add an output jack after the demodulator stage, before the amplitude detector. Connecting this signal to an oscilloscope shows the distortion waveform. This is not the same as the residual distortion waveform from a harmonic distortion analyzer, but is very handy in seeing what part of the 60Hz waveform is distorting, catching overloads and clipping, and in seeing high frequency parasitic oscillations.

A Brief Hewlett-Packard Affair

Most published distortion measurements are for THD (Total Harmonic Distortion). Having only an IM analyzer kept me from comparing my measurements to the rest of the world. At a ham radio swap meet, I picked up a Hewlett-Packard 330B harmonic distortion analyzer. After getting a copy of the manual, I discovered I had only half an analyzer - it needed an external low-distortion sine-wave oscillator! Some scrounging brought a solid-state Krohn-Hite oscillator with good specs. The lowest distortion reading on the 330B was 1% full-scale, but the residual distortion inherent in the analyzer was about 0.4%. After lots of tweaking (upgrading capacitors, selecting tubes, adjusting pentode screen voltages, etc.) I could only get the residual distortion down to about 0.15% – not very good, even for testing tube amps. Another annoyance was an odd band of distortion at low levels – almost the opposite of cross-over distortion – in the distortion output waveform. This is caused by H-P's use of an AC meter circuit that places the meter rectifiers inside the overall feedback loop. This gives a nice linear meter scale, but the signal output is not linear at low levels.

To use this type of THD analyzer, the sine-wave oscillator is connected to the amp input, and the analyzer is connected across the dummy load connected to the amp output. The oscillator level is adjusted to give the desired output from the amp. As with the IM analyzer, the input level is adjusted to give a full-scale reading in the “Set Level” mode. At this point, the analyzer is switched to “Distortion,” and the frequency dial is tuned to give a minimum meter reading. Adjust the Balance control for minimum reading. Repeat both adjustments for the best null. The reading remaining on the meter is the THD.

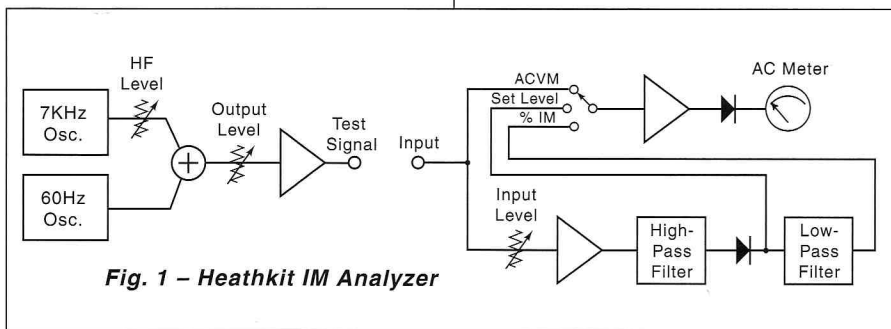

Fig. 1 – Heathkit IM Analyzer

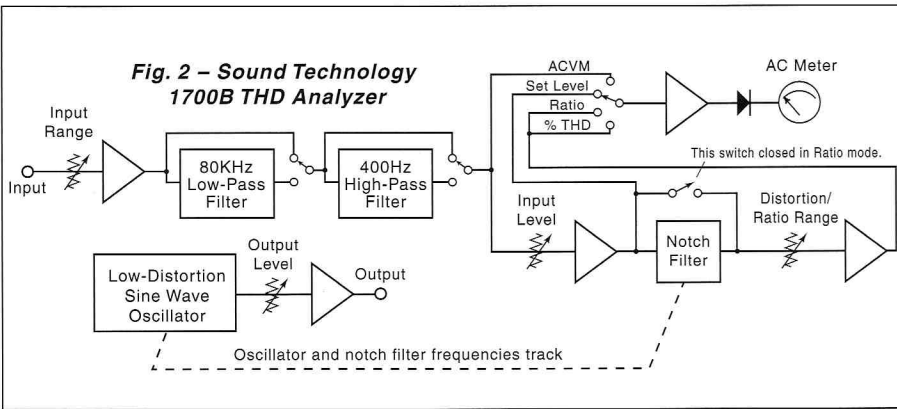

Fig. 2 – Sound Technology 1700B THD Analyzer

Given the size, limited performance, and tedious adjustments of the 330B, I considered getting the newer H-P 331A or 334A. The 331A/332A is functionally similar to the 330B, but has much lower residual distortion. The 333A/334A adds an auto-nulling feature, greatly reducing the tedium. The even newer 339A finally adds a built-in oscillator! However, even on the used market these analyzers were quite expensive. I decided to stick with the Heath IM analyzer.

The Jump to Sound Technology

By the early 1990s, I had started doing some serious audio consulting work on the side, and realized I needed a better analyzer than the Heathkit. I had noticed that many audio professionals had a beige and brown box on their benches – an analyzer by Sound Technology. A Silicon Valley company started by ex-Hewlett-Packard engineers, their first product was a FM stereo multiplex generator. When their state-of-the-art distortion analyzer, the 1700, came out in the mid-1970s, their timing was perfect: the ultra-low distortion wars were underway. From the late 1970s to the late 1980s, Sound

Technology was the analyzer to have. I had been keeping my eye out for a used one, but as with any desirable piece of equipment, the used price was high – several thousand dollars. I finally found one for \$1200—a lot, but justifiable for my audio consulting work.

My new acquisition basically worked, but was not working to spec, and was somewhat erratic. It apparently had been used on the test bench at Pacific Stereo - and had seen a lot of hard use. Fortunately, Sound Technology still exists, although at a smaller size, in Campbell, California. I brought my unit over, and submitted it to their standard \$750 overhaul. Judging from the number of components replaced, it was more like a \$3000 overhaul, but they still only charged the basic rate. I finally had a high-performance analyzer!

The Sound Technology 1700B is a very finely-tuned, all-analog design. It is basically a THD analyzer, but my model also had the IM analyzer option. The residual distortion is less than 0.002%. The frequencies are push-button selectable, with

the generator and analyzer ganged together. The oscillator output is automatically leveled, so you don't get errors when running frequency response plots. The THD tester has good auto-nulling, and has a very handy auto-level circuit that eliminates the need to do the "Set Level" adjustment each time. My particular model even had the meter calibrated to directly read power into an 8-ohm load!

The operation of the Sound Technology 1700B is the simplest so far: set the output for the desired power level, set the input level switch for a reading in the upper 2/3rds of the meter scale, then switch to distortion, and read out the THD. IM measurements use a similar process. As with most newer analyzers, the 1700B has a switchable 80KHz low-pass filter and 400Hz high pass filter. The first is handy in removing high-frequency "junk" from the signal – which can often occur at the output of CD players or PC sound cards. The 400Hz filter is good in removing hum and its harmonics when running THD tests above 500Hz.

Although considered obsolete for production testing, the Sound Technology analyzers are still close to the state of the art in performance, and are very good for R&D and service work. Sonny at Sound Technology told me that they still make a few 1700s for the U.S. Navy, where the lack of digital circuits makes them suitable for use in ultra low-noise environments.

Audio Meets the Computer Age

While the Sound Technology unit has the precision, doing frequency response curves was tedious, and I realized that there was more to audio measurement than just IM, THD, noise, and frequency response. In the search for understanding sound and how electronics affects sound, it became clear that more different ways of looking at sound were needed. Spectrum analysis gives a whole different view of a signal, and is especially good for looking at the harmonic structure generated by amplifiers. It is now increasingly necessary to deal with audio in a digital form. In short, I was looking for the next level of performance in audio analysis.

The first exposure to the next level in state of the art audio testing came about six years ago when Mike Hogue, the local Audio Precision rep, gave a presentation to the Bay Area Tube Enthusiasts on their System One analyzer. This is an analog analyzer that is fully computer controlled. By using a DOS-based program running on a PC-compatible computer, the control interface and computational features

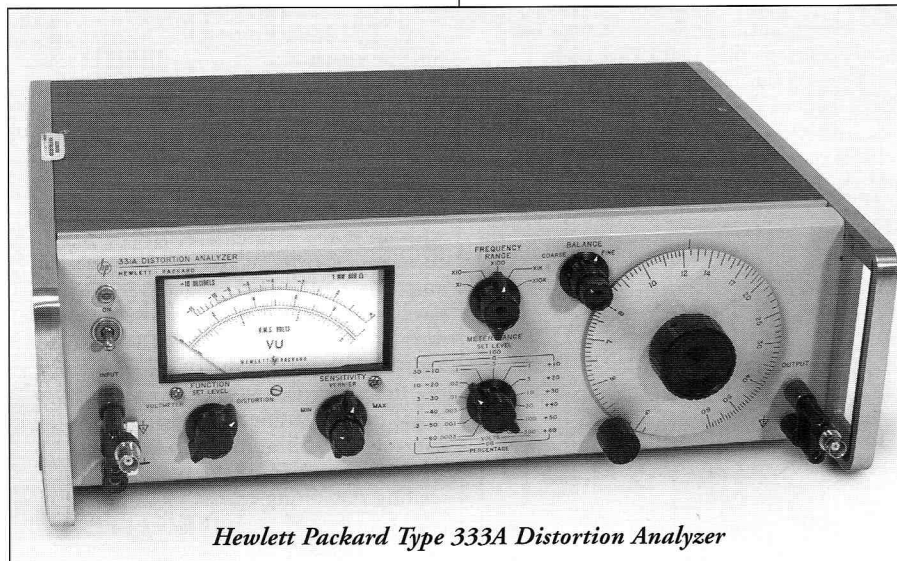

Hewlett Packard Type 333A Distortion Analyzer

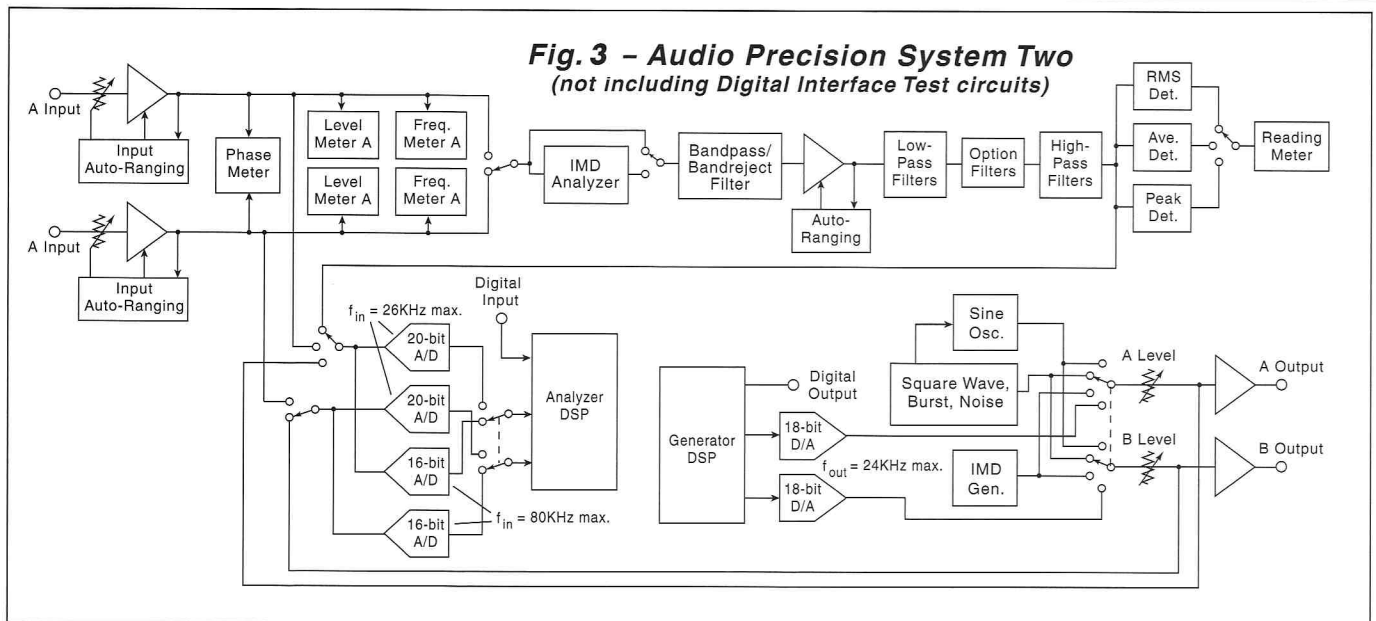

Fig. 3 – Audio Precision System Two
(not including Digital Interface Test circuits)

could be updated without changing the basic analyzer hardware. There were even options for adding a DSP (Digital Signal Processor) which could do FFT spectrum analysis, multi-tone testing, and other sophisticated tests. The only problem was that a fully loaded system cost as much a good car.

During the late 1970s and early 1980s, Tektronix made a line of high-quality audio test gear – most designed to fit in its DM500-series modular test equipment racks. However, as part of an MBA-inspired “refocusing,” Tektronix dropped their audio line. The key engineers involved then started their own company, Audio Precision, Inc. in 1986 to continue their audio work. A trend in instrumentation design at that time was the incorporation of microprocessors to automate and calculate. However, equipment with “embedded” processors could easily become obsolete as newer processors and better software techniques were developed. Audio Precision decided to use the ever-cheaper IBM-PC as their control processor. The result was a box that just had connectors. All switching and adjustments were done through the interface program. By using the computational power of the PC and its storage and printing capabilities, sweeps, graphs, and automated test procedures could now be done. It should be noted that the GPIB bus (IEEE-488), originally developed by Hewlett-Packard in the 1970s, allowed similar computer control and computation, but tended to be expensive, and little high-performance audio-specific hardware was available for the GPIB.

My interest in Audio Precision was whetted by my consulting work for Summit Audio, where a System One, and later a System Two was regularly used for production testing and repair of their pro-audio products. The ease of doing automated tests, as well as the availability of spectrum analysis, multi-tone analysis, and digital interface analysis, were really attractive. After saving up some money, and with an assist from the booming stock market, I decided to take the big plunge, and get an Audio Precision System Two, complete with dual domain (analog and digital) analysis. At the time this was written, I’ve had the analyzer for two weeks and am just getting familiar with all its power. Its capabilities are so extensive, that I can only cover the basic analysis functions here. In the last article, some of the more advanced features will be explained.

The System Two has basically the same signal path as a regular harmonic distortion analyzer, but with all switching and level setting under computer control. It has an extremely low distortion analog oscillator (typically 0.00003% or less at 1KHz) and an analog analysis section with state variable filter and notch filter with matching specs. For those who put down audio transformers in a signal path, it is interesting to see that Audio Precision uses transformers in their analog output stage. To provide “Dual Domain” capability, a DSP can also provide D/A-generated analog signals as well as SPDIF (consumer), and AES/EBU (pro) digital outputs of all the signals available from the analog section, as well as some arbitrary and special waveforms.

Several different high-performance A/D converters are available, connected to a DSP that can perform standard analog tests (IM, THD, noise, cross-talk, phase, etc.), FFT spectrum analysis, and MLS analysis, the latter useful for speaker testing. In addition, the actual SPDIF or AES/EBU digital signal itself can be perturbed and analyzed!

The System Two is run from a Windows-based program, APWIN, which gives the user separate windows for controlling each subsystem and function. The most common method of using the System Two is by running “sweeps,” which generate graphs or tables of one parameter versus another. It can also do single-point measurements displayed on a bar graph or numerical readout on the screen. Set-ups and captured data can be saved to disc. All settings and commands available to the user are also available in a language called APWIN BASIC, which is based on Microsoft’s Visual Basic for Applications (VBA). This is a fully-capable programming language which allows sophisticated automated tests to be run.

If this sounds like an enthusiastic marketing testimonial, it is just because I am an excited new owner! I’m sure that some bugs and flaws will become apparent. However, I look forward to probing the outer limits of sound design!

In the next and last article on distortion analyzers, some typical results will be given from various distortion tests. Some insights on the interpretation of the results will also be discussed.

The Gentle Giant: Altec 287W

By Natalie J. Stone © 1998 All Rights Reserved

It was just over a year ago that I acquired the pair of Altec 287W amplifiers. I had been reading about large triode amps for quite some time and having played out several scenarios on a pair of 1570Bs, was ready to move on. I had been talking to Sonny Goldson about older theater equipment when he said he had something I might be interested in. I was, and when they arrived I thought I may have gotten in over my head. They were pretty raw so I set out on the job to restore them. After a week or so I powered up one and had just finished the second when it was discovered that the output transformer was shorted. I called Sonny back to ask if he had any ideas. Out of pure luck he had a source who had a set of transformers to a 287W. I obtained the spare set and was back in business. It didn't take long to realize that these giants had a wealth of unadulterated triode power. Their circuit design was as simple, if not more so, than a single-ended amp. Two things were immediately visible here. There is no feedback and there are no coupling capacitors. This leaves the input transformer - T5 - as the most critical component.

T5 has two jobs: first as an impedance matcher, and second as a phase inverter. I've been unable to track down an original Altec T5 part number TL 216, so I tried a dozen or so transformers until I found a Triad HSM-94. This transformer

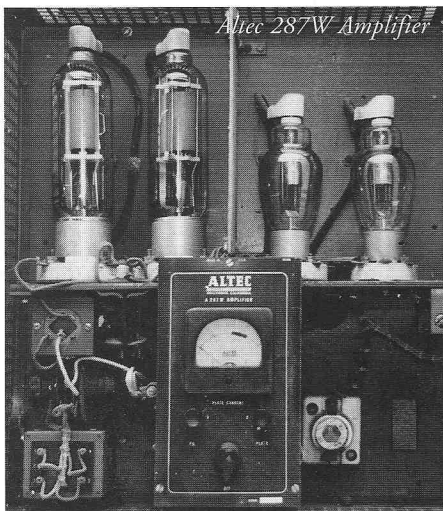

has a nice wide range and doesn't tax the driver amp. Next all the high voltage wiring was replaced with high-grade ignition wire. Then the bias circuit was reworked: the selenium rectifier was

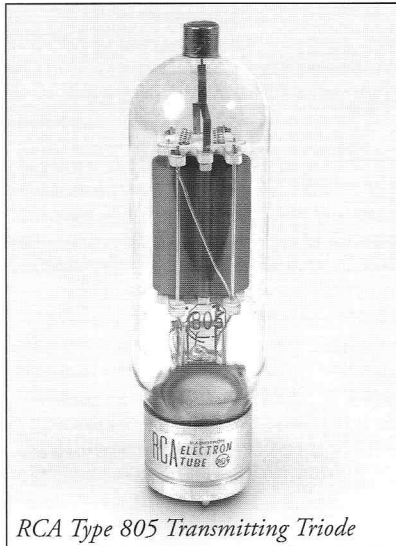

replaced with a 5A bridge and a 25 Watt-50 ohm pot replaced R8, allowing on-line tuning. Next, C1 was taken out and an RC decoupler was added, giving a more stable output and reducing hum. The last two mods were the addition of high/low switches on the plate and filament transformer primaries. I've seen my home line voltage swing twenty volts and didn't want to power down every time I needed to change taps.

After some power up readings were taken, I started trying different driver amps. If you are unable to track down the OEM Altec A-127 amp, a Macintosh 50W2 or A116 make good candidates. I'm currently working on building a SE/91. Electra Print would be my first choice for an output transformer with a high impedance on the secondary to drive the input of the 287W directly, doing away with the T5 transformer. An additional secondary with common impedances (4, 8, 16 ohms) would allow the user to drive speakers as well as the 287W.

After the amp was up and running and a two-day burn-in complete, it was time to reap my rewards. With close to 300 watts of thundering audio at my discretion, I soon discovered these amps are their happiest fully loaded. They were originally auditioned on a pair of Theil CS 3.6 speakers. These were way too efficient for an application such as this. I strapped the transformer for 5 ohms and connected a pair of old Cerwin-Vega 15 inch and 12 inch home speaker cabinets along with my own home-brew 12 inch Focal cabinets. Then I set the volume up ever so slightly as I walked down the street to ensure my neighbors could enjoy the music as much as I did.

Needless to say, these amps aren't for everyone: they like inefficient drivers and lots of load! They have a class B rating and they have a plate voltage of around 1500 volts. BAD STUFF, MAN!

Just to see what the plate transformer was capable of, I used a neon lamp as an igniter and was able to develop a ten inch arc which extinguished only after I killed the mains. It never blew the 2 Amp fuse! If I were to equate this amp to a car it would be a '57 Chevy. Bodacious looks, lots of power, and inefficient. But what a ride! They don't have the high headroom or presence I've heard from amps like Futterman OTLs or a Mac MI-200, but they definitely have redneck appeal.

One can also see the early influence that Western Electric had on Altec. Four tubes mounted benchmark style on the same plane, a plate current meter, and the unique starter switch that rotates. Just look at the W.E. 43A (VTV issue #2).

Sadly, looking ahead was the coming of the amps like the Altec 260A. An era was

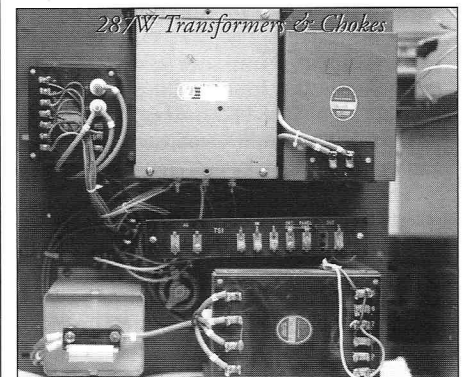

coming to a close. Gone were the days of the "Gentle Giants" and their simplistic ways. In their place was a contorted maze of RC networks, caps and coils, and enough feedback to kill a concerto. The

THE GENTLE GIANT ALTEC 287W

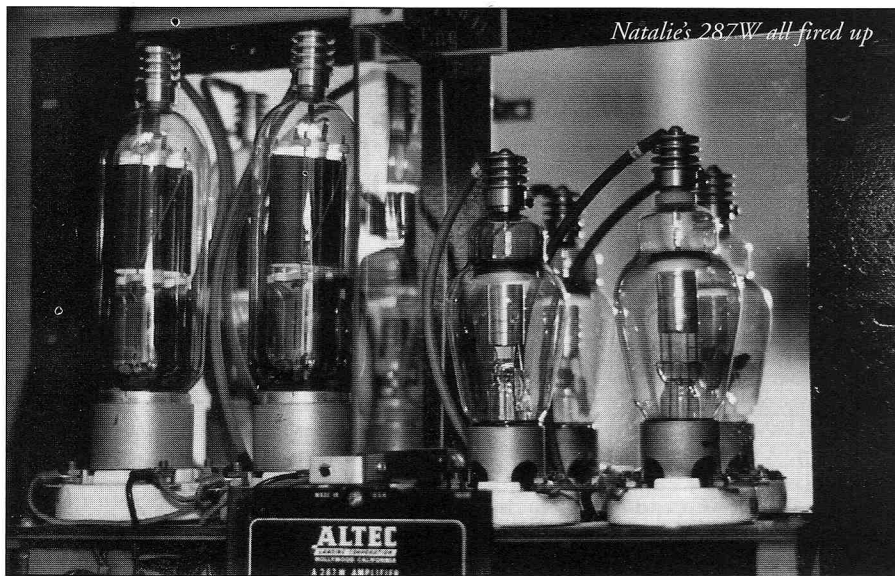
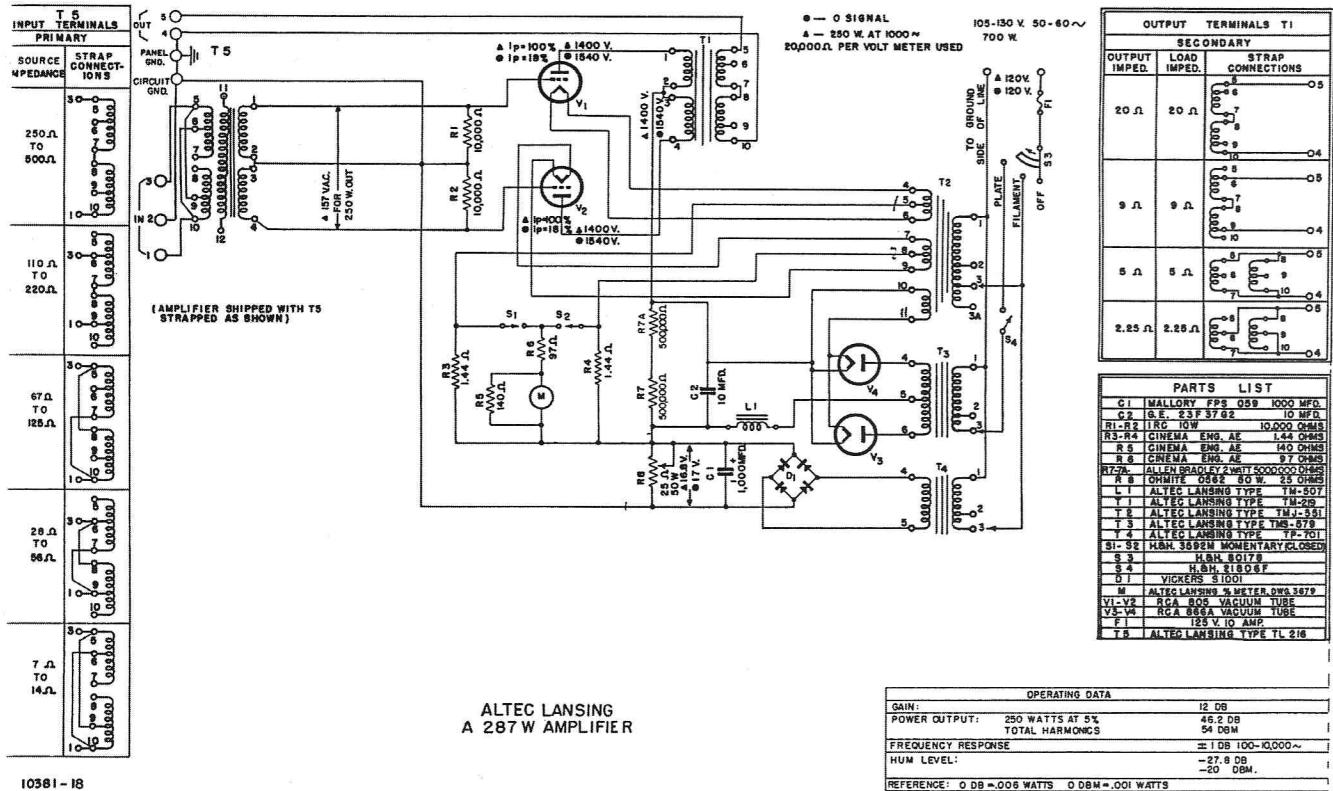

only real carryover was the use of a center-tapped input transformer. Engineering was going in a new direction now. But was it better?

Many have asked why I kept the two 866A mercury-vapor rectifiers instead of using solid state. Yes, these can be very problematic, but once you get a pair that are fairly balanced, you can get several thousand hours out of them, and besides they sound better to me. A lot of people argue against mercury vapor rectification,

but even the old 83 has a smoother texture than the 5U4/5R4, etc. Decide for yourself. At any rate the 866As weren't going anywhere. At night you can turn the lights down with only the 287W's glow for illumination, put on Pink Floyd's Dark Side of the Moon, and experience a visual and aural spectacle that would cause even the great "Harvey Gizmo" to make water!

They create an atmosphere that's hard to describe, but for anyone who enjoys

the old ways of Western Electric but can't find or afford one, you're better off anyway! And for whoever isn't afraid of super lethal power, the ALTEC 287W makes an excellent project.

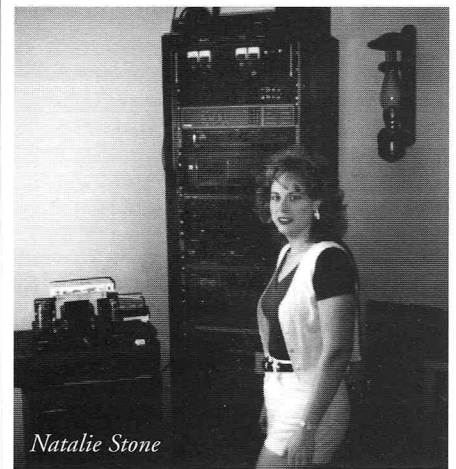

Natalie Stone is a vacuum tube audio enthusiast who works as an electrical technician in a power generation plant. She is also into motorcycles, steam locomotives and lately, the restoration of an original Linotype machine.

You can reach Natalie by email: sueanneb@mis.net

The Best Sounds in Vintage Hi-Fi Under \$350

By Charles Kittleson © 1998 All Rights Reserved

You don't have to spend a king's ransom to get a great sounding tube hi-fi system. There are thousands of 1960's vintage tube stereo components available for a song, which may only need minor servicing and upgrades. The equipment mentioned in this article is not for audiophiles who must have at least 200 watts per channel and concert-like realism. Obviously, those requirements will cost the audio perfectionist ten thousand dollars or more. Components mentioned in this article will make good music, even with moderately efficient speakers, and will be easy to listen to for long periods of time without listener fatigue. Plus, they won't break the bank, by costing typically less than \$350US per unit (1998 prices). They are an excellent complement to CD players that nearly always sound too "digital" and cry for tubes in the signal path to smooth the irritating solid-state edge. Unless you have high frequency hearing loss and can't tell the difference, you need tubes when playing CDs.

Most audio stores will downplay the value and practicality of vintage components because many of them have never owned any, but mainly because they want to sell you a new system. New tube hi-fi can sound good, but the price may be staggering. Buying vintage components can be a fun and rewarding experience, plus you won't suffer massive depreciation as you would when buying new equipment. Buying anything used is a problem

for some people, so we don't recommend this exercise for audio snobs or arrogant yuppies.

Most of the gear mentioned in the article has excellent transformers, point to point wiring and classic, good sounding circuits. *There are other good-sounding bargains out there you may know about, but the equipment listed in this article is common and comparatively inexpensive.* The funny thing is, though, that when you start looking at a lot of the new tube hi-fi equipment, much of it is copied from designs from the 1950s and 60s. With all the audio equipment buy-sell publications plus rec.audio.marketplace and ebay.com on the Internet, it won't be difficult to locate any one of these popular components.

Repair and Upgrades

Restoration can be the fun part of this exercise. Actually bringing a vintage piece back to life with your own hands! It is always a good idea to obtain a schematic diagram of your equipment before you begin the job. *Be sure to check all wiring and solder joints. Many of these units were kits and the builder may not have had soldering skills.*

A lot of vintage equipment is dusty from storage and may have caked on dirt. Use a soft, new paintbrush to dust the equipment. Dirt and smudges can be removed carefully with water, mild soap and a soft cloth. Rust and corrosion can be a problem, especially if found on chrome surfaces. Some restorers use Simichrome paste polish with either a soft cloth or 0000 steel wool (super fine) on chrome to remove rust haze. Be extremely careful with cleaning the dial glass on tuners to ensure you don't wash the letters off.

You will need to check all the tubes to determine if they are strong and have no defects. Either buy a late model mutual conductance tube tester or borrow a

friend's. Tubes most likely to be weak are output and tuner tubes, but check them all anyway. Tube pins and sockets can be dirty and have caked-on dirt or scale, especially the smaller seven and nine pin miniature types. Use a reliable and environmentally safe contact cleaner to spray into the sockets and replace and remove the tube from the socket five times, then spray some more cleaner in the socket before you replace the tube. This breaks up the dirt and makes a better electrical contact. Slide switches, tone and volume controls, rotary function switches and input jacks benefit from contact cleaner spray as well. I have had excellent results with Caig D-5 spray cleaner and preservative.

Avoid plugging your equipment in without first bringing it up slowly on a variable AC transformer (VARIAC). If you hear 120 cycle hum, it is most likely a high-voltage filter capacitor, which must be replaced before you can safely operate the unit. Any older capacitor in the signal path can potentially effect the sound quality of the unit. Most restorers replace them all with newer film types. In many cases, the bias rectifier in older equipment was a selenium type that goes bad with age and develops excessive resistance. This reduces bias voltage to the output tubes, causing the plates to glow orange and go bad. The selenium unit must be replaced with newer silicon diodes or a diode bridge. In addition, the electrolytic capacitors used to filter the bias voltage must be replaced for best reliability.

Dynaco Stereo 70 Amplifier

There are more Dynaco Stereo 70s on the planet than any other tube hi fi amp ever made. The reason is simple; they are uncomplicated, easy to repair or mod and sound very musical. The ST70 was a recommended component in many audio magazines from its introduction in 1959 through the mid-1960s. With 35 watts per channel, you can drive most speakers in most small to mid-sized rooms very easily. The amp is nickel plated and has an attractive cage to enclose the amp and make it safe for households with children or pets. The output transformers are the famous Dynaco A-470 Ultralinear units. For many audiophiles, the Stereo 70 was their first serious audio amp. It is estimated that there are more than 300,000 Stereo 70s in existence, so finding one should be very easy. For more information on the ST70 and other Dynaco tube gear, see *VTV* Issue #1.

Tube complement: two 7199s, four

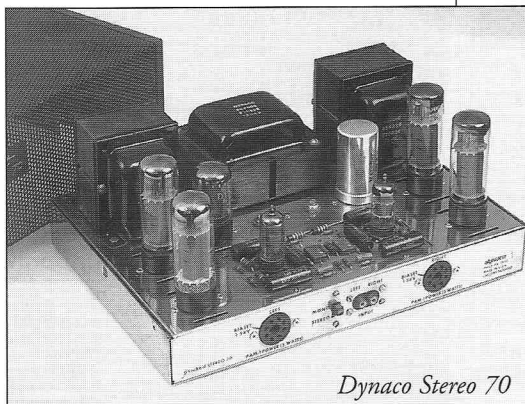

Dynaco Stereo 70

EL34s and one 5AR4. Sound quality: very musical midrange, bass response can be soft and highs are not extremely detailed in stock, unrestored form. Good modifications and upgrades can improve the sound quality significantly. Typical repairs: replace selenium bias rectifier with silicon diodes, replace quad filter capacitor, replace coupling and bypass capacitors on circuit board with modern film types. Most mods involve replacing the driver stage circuit board with a custom unit and replacing the 7199s with more available types including 6DJ8s, 6GH8s or 12AX7s. Other mods improve the power supply with more capacitance and regulation. There were dozens of mods for the ST70 published in *Audio Amateur*, *Glass Audio*, etc.



Dynaco PAS-3

Dynaco PAS-2 and PAS-3 Preamps

A very popular and good sounding stereo preamp, the Dynaco PAS is an excellent choice for somebody who wants to get into a tube preamp without buying the farm. There are dozens of mods and upgrades published for this preamp because it is easy to work on. Most parts are mounted on circuit boards, so be careful when replacing caps, etc. The early Mylar and paper capacitors in the signal path should be replaced with newer film caps for the best sound.

Tube complement: four 12AX7s and one 12X4. Sound quality: a very musical preamp that can sound much better than units costing thousands. Circuit design features tone controls at the end of the audio stage. Typical repairs: replace the selenium filament supply rectifier stack with two silicon diodes and replace the two filament stage caps with newer electrolytics, plus replace old signal path capacitors with newer film types. Mods include bypassing the tone controls and beefing up the power supply.

Dynaco SCA-35 Integrated Amplifier

The SCA-35 integrated amp is an excellent sounding device. Using push-pull EL84s in Ultralinear mode, the SCA-35 is one of the most compact tube stereo amps available. Output transformers are the

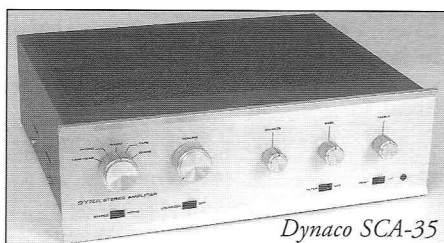

Dynaco SCA-35

very excellent Z565 Dynaco Ultralinear units that have a super-wide bandwidth. All tubes and most components are mounted on circuit boards that can be kind of brittle if the unit was left on for long periods of time.

Tube complement: four 7189/6BQ5s, two 7199s and two 12AX7s with solid-state rectifier. Sound quality: musical, balanced and very pleasing to listen to, even when compared with higher priced component systems. Typical repairs: in most cases, the EL84 output tubes should be replaced as well as the 7199s. Coupling capacitors in this unit were very poor quality and should be replaced with newer film types. Filter capacitors should be upgraded to new units. Be very careful when working on the circuit boards to avoid breakage and other damage! A common mod for SCA-35s is to convert the driver stage to accept easy-to-find 6U8/6GH8 tubes instead of 7199s.



EICO HF22

EICO HF 22 and HF 35

EICO power amps are real sleepers and worth checking out. They are not especially attractive, but usually have excellent circuit design and use high quality output transformers from Chicago, Acrosound, etc. Although many collectors go after the higher powered HF 50 and HF 60, the lower powered units are excellent when properly restored.

Tube complement: HF 22 and HF 35 are Ultralinear type power amps with a Mullard-Type front-end using an EF86, 6SN7 and PP 6L6GC for the HF 22 or EL34 for the HF 35. The rectifier tubes are either 5U4GB for the HF 22 or 5AR4 for the HF 35. Sound quality: balanced, with good bass, musical midrange and

sweet extended highs, due to excellent transformer quality. Typical repairs: replace all paper coupling and bypass capacitors, replace selenium bias rectifier with a silicon diode, form and/or replace all electrolytic capacitors, and replace all plate and cathode resistors in the front-end of the amp which reduces background hiss. Modifications include: triode connecting the EF86 (results in lower sensitivity, but cleaner sound) or replace EF86 with a nine-pin dual-triode, increase power supply capacitance, etc.

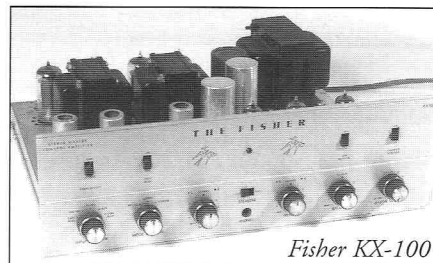

Fisher KX-100

Fisher X-101 and X-202 Amplifiers

Another popular 1960s integrated stereo amplifier series, the Fisher products were available in assembled and as kits. Several variations were made including: X-100, X-101, X-101B, X-101C, X-202, X-202B, X-202C, KX-100, KX-200, etc. Most driver tubes were 12AX7s and output tubes were either 7189, 7868 or 7591. These amplifiers are full-featured, good sounding and fairly common.



Fisher 400 and 500C Receivers

Undoubtedly the most popular tube hi-fi components in the world, the Fisher 400 and 500C receivers are excellent sounding units. Although the output tubes are the hard to get 7868 for the 400 and 7591 for the 500C, these receivers are worth the effort. Output stage can be modified to accept either EL34s or 6L6GCs. These receivers are still plentiful and easy to find. Transformer quality on the Fisher stereo receivers is excellent. This iron is very musical and really makes the unit sound great.

Restoration of a Fisher is not for a beginner. These units are fairly complicated, but if you have a schematic and the right parts and test equipment, it will be a rewarding project.

Tube Complement: 7591A output tubes, 12AX7s and a variety of 7 and 9 pin tuner tubes such as 6AU6, 6HA5, 6CW4, etc. The 400 uses 7868 Novar base output tubes. Basic repair and service involves replacing the selenium bias rectifier with a newer silicon bridge, plus replacing bias electrolytics. Be sure to check all tubes and replace bad ones with NOS units. If you do not have skills in FM tuner alignment, it is best to find a skilled technician in your area. For more detailed information on Fisher receivers see VTV #6 pages 3-10.

Fisher FM 50 and FM 100 Tuners

Fisher tuners are the best sounding, most realistic FM tuners in their price class. Fisher really "hot-rodged" their tuners with extra IF stages and super-sensitive front-ends. You don't have to buy the FM200B or the FM1000 to get a musical and sensitive tuner. Both the FM50B and the FM100B are excellent performing units. In fact, the FM100B was voted "best buy" in the VTV Tuner shoot-out in Issue #5.

Heathkit W-4M and W-5M Amplifiers

Among of the most successful versions of the Williamson amplifier ever sold, the Heathkit W-4M and the later W-5M are excellent tube audio bargains. They are very easy to work on and both have tube rectifiers.

Tube Complement: W-4M - two 5881/6L6GCs, two 6SN7s and one 5V4G. W-5M - two KT66, two 12AU7s, and one 5R4GY. Sound quality: both amps have a classic hi-fi sound, but the W-5M is more high-end tilted. The W-4M is a little more romantic sounding. Typical repairs: replace signal and electrolytic capacitors with newer units. Mods include beefing up the power supply with more capacitance and substituting EL34s for the 6L6/KT66s.

H. H. Scott 222 Integrated Amplifier

Variations include the original 222 that came out in 1959. This was followed by the 222B which was introduced in 1960 and featured larger transformers. Then came the 222C which featured huge transformers and a higher power rating. Last of the series was the 222D with a silver faceplate and different knobs. The Scott Kit version of this unit was the LK-

48 and LK-48B; both units are very similar in styling and circuitry. The LK-48 was available with a black and champagne faceplate.

Tube Complement: four EL84s, four 12AX7s, two 6BL8s (6U8s or 7199s are used in later models) and one 5AR4. Sound quality: this is a very sweet and detailed sounding amplifier. It is not for a bass freak or a high-power nut. 222s make an excellent office, den or second system for playing CDs or listening to FM. Typical repairs: replace selenium bias bridge with a newer silicon type. Replace signal capacitors and electrolytics that test bad with newer units. Mods for the 222 include substituting the 6U8/6BL8 driver tube to a type 7687 for better bass and more punch.

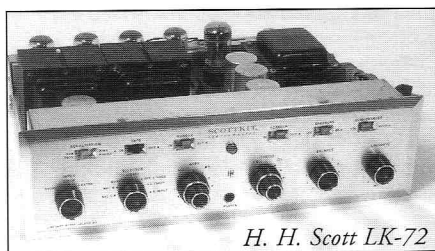

H. H. Scott LK-72

H. H. Scott 299C, D & LK-72 Amps

The early 299 Scotts used 7189 output tubes, but in 1961 the 299C was introduced with the 7591 output tube for much higher output power. One of my favorite vintage hi fi pieces, the Scott 299C has decent power, great sonics and lots of flexibility. Scott wound some of their transformers in-house and quality of the iron is excellent. The 299C output transformers are massive and are about 50% larger than the Dynaco ST70 iron. The LK-72 and LK-72B were kit versions with a few different features, but the same basic circuit.

Tube Complement: four 7591As, two 6U8 or 6GH8s, four 12AX7s and one 5AR4. Sound quality: these amps have more punch than the smaller 222s. They tend to run a little warm and sound warm and rich. Typical repairs: replace the selenium bridge with a newer silicon type. Replacing signal and electrolytic capacitors with newer units always improves performance and reliability. I usually don't recommend modding these amps because there isn't a lot of extra room under the chassis.

H. H. Scott 350 Tuners

Another extremely popular FM tuner with dozens of variants available. The most common versions are the Scott 350, 350B, 350C and the kit versions LT-110



H. H. Scott LT-110

and LT-110B. All of these units have a built-in multiplex decoder and can receive stereo signals. The chassis is aluminum and wiring is point-to-point. Later tuners used solid-state rectification. The Scott tuners are plentiful and cheap, so finding one shouldn't be a problem.

Tube Complement: typical tuner tubes including 6AU6s, 6BQ7, 6U8s, 12AT7, 12AU7, etc. Sound quality: these tuners, if properly restored and aligned, can sound great. They are less prone to drift than many other tuners of their era. Aligning the multiplex section can be tricky and should be done by an experienced professional. Typical repairs: check and replace all bad tubes, replace film and electrolytic capacitors, replace selenium bridge rectifier and internal signal cables with shielded silver coaxial. If the unit you have was a kit, be sure to check soldering joints and IF cans for damage. Mods for tube tuners should not be attempted by amateurs.

Sherwood S-5000 & S-5500



Sherwood S-5500II

Sherwood integrated amplifiers are attractive, common and can sound good with the servicing and the right upgrades. There are several versions of the S-5000 and S-5500 that can use: 7189s, 7591s or 7868 output tubes. All of the stereo integrated amps have solid-state rectification. Sherwoods have lots of controls for phonograph fanatics including a presence control on some models.

The next article in this series will cover mid-priced vintage tube hi-fi gear.

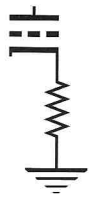

Cathode Bias

by
John Atwood

Metallic Rectifiers

© 1998 All Rights Reserved

Long before modern single-crystal semiconductors became part of the electronic designer's repertoire, "metallic" rectifiers were available as an alternate to vacuum or gas rectifiers. The most common metallic rectifier is the selenium type, but other materials were also used. While not prone to catastrophic failures as tubes are, selenium rectifiers slowly age and wear out, leading to problems in older equipment where they are used. We will look at several of the different kinds of metallic rectifiers and recommended ways of replacing them.

Copper Oxide

The earliest commercial metallic rectifier was the copper oxide type. Rectification takes place at the boundary of Cuprous Oxide (CuO₂) and metallic copper. The maximum allowable reverse voltage per copper-cuprous oxide junction is typically 6 volts. To achieve a higher voltage rating, the copper plates that make up each one of these "cells" are stacked in series. In higher-power rectifiers, the plates are arranged as fins to permit air cooling. For the first year or so of use, the forward voltage drop increases as the copper oxide rectifiers age, but once aged, they are very stable.

Along with Tungar gas rectifiers, copper oxide rectifiers were heavily used in the

1920s and 1930s as car and radio lead-acid battery chargers. The low voltage per cell and large sizes needed to handle any appreciable current led to them being phased-out by the 1940s. However, the high stability of aged copper oxide rectifiers kept a niche open for them as instrumentation and meter rectifiers (such as used in some AC meters and VU meters) up to the present.

Selenium

The rectifying properties of selenium were discovered by Werner Siemens in 1877, but the first commercial selenium rectifiers did not appear until 1928 in Germany. Selenium rectifiers started to be used in the United States shortly before and during World War II, and after the war essentially replaced copper oxide rectifiers in all but instrumentation uses. Selenium was popular because the breakdown voltage per "cell" (plate) is typically 25 volts or more. This made rectifier "stacks" much smaller and more efficient than copper oxide types.

The dark side of selenium rectifiers is their instability over time and their tendency to wear-out with age and high temperatures. For general-purpose bulk rectification, things like unstable reverse currents are not a problem. However, the forward voltage drop increases over time, and

eventually becomes high enough to affect the circuitry. Lifetimes are highly dependent on the quality of manufacturing, but for a high-quality selenium rectifier, rated lifetimes range from 1600 hours at 130°C to over 60,000 hours at 40°C. Clearly, heat accelerates the breakdown process.

Another peculiarity of selenium rectifiers is, like electrolytic capacitors, their reverse leakage current goes up while sitting idle. By slowly re-applying a reverse voltage, the rectifiers can be re-formed. I have experimented with old selenium rectifiers, and found that the degree of leakage is not nearly as bad as for electrolytic capacitors sitting idle for the same time, so it is unlikely that reforming would be needed prior to the first power-up. However, if the rectifiers were planned to be kept in service in top condition, it would be helpful to slowly apply a reverse voltage up to the maximum PIV (Peak Inverse Voltage) rating of the rectifier.

The most insidious problem with selenium rectifiers is their potential for emitting poisonous gases. If a short-circuit causes a selenium rectifier to overheat, it will create selenium vapor, which is poisonous. If this ever happens to you - you can tell by the characteristic pungent smell--clear everyone out of the room and open the windows to clear the air. This aspect of selenium rectifiers is rarely told in manufacturers' literature, but was well known in the radio-TV service community.

Other Metallic Rectifiers

Magnesium-copper sulphide rectifiers were seen as a possible alternative to selenium rectifiers. Several problems have kept this type from gaining popularity: a significant hysteresis in the forward voltage and current with applied AC voltage, high reverse current, maximum reverse voltage of about 5 volts per cell, and a much shorter life-time than selenium.

Titanium dioxide rectifiers, made by applying bismuth to a layer of titanium dioxide built up on metallic titanium, were developed by Battelle Memorial Institute in an effort to create very high temperature rectifiers. They could function at well over 300°C, and up to a point, their characteristics get better with higher temperature. They have fairly high leakage current, and a maximum reverse voltage of from 5 to 15 volts per cell.

Typical Selenium Rectifiers

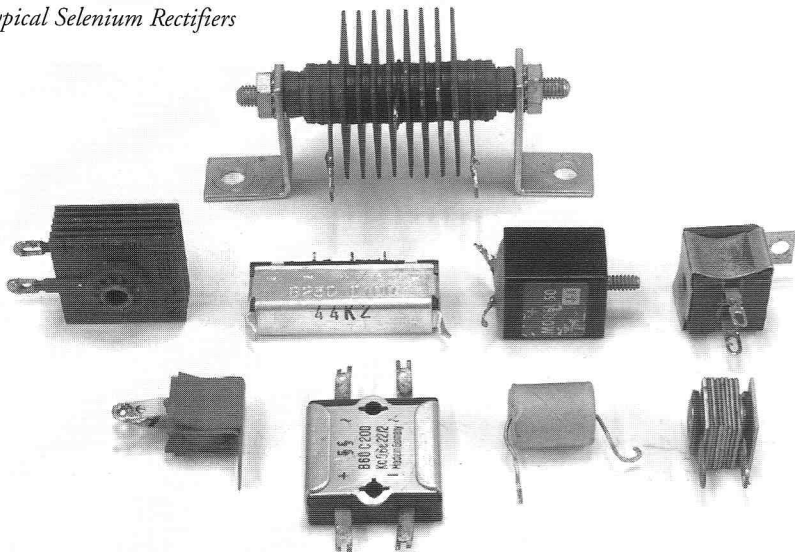

Coming in VTV #10

**6V6 Shootout,
Tube Headphone Preamp
project, and More.**

Although not considered in the same family as selenium rectifiers today, germanium and silicon rectifiers were grouped with metallic rectifiers in the 1950s. Germanium alloy-junction rectifiers were the first commercial power rectifiers built using the single-crystal technology developed for transistors, and were first available about 1950. Germanium rectifiers have a very low forward voltage drop – about .2 to .4 volts, high breakdown voltage (up to 300 volts), and reasonably low reverse leakage current. Their main limitations are: limited high temperature operation of 85°C maximum, and the need for strict hermetic sealing. Germanium power rectifiers were used by industry and the military, but were too expensive for consumer use.

The first silicon power rectifiers were alloy-junction types, similar in construction to germanium rectifiers, and were commercially available in the early 1950s. They improved upon germanium rectifiers by having extremely low leakage, high maximum operating temperature (150°C) and breakdown voltages up to 1000 volts, although they have slightly higher forward voltage drop (approximately .7V). In 1956, commercial diffused-junction silicon rectifiers became available, bringing better control of characteristics and much better electrical ruggedness. Later, silicon-dioxide passivation was added to allow packaging in non-hermetic packages. This is basically the same construction as the ubiquitous 1N4000-series of rectifiers so common today.

Dealing with Selenium Rectifiers

In electronic equipment that uses metallic rectifiers, selenium is by far the most common, so from this point on, the discussion will focus on selenium. When refurbishing a piece of vintage equipment that uses selenium rectifiers, a decision needs to be made on whether to stay with selenium, or to replace with silicon types. If historical accuracy is desired and the equipment is not heavily used, then staying with selenium makes sense. If the original rectifiers are weak, as determined by low DC output voltage, then they can be replaced by either a selenium rectifier removed from other equipment or by an unused N.O.S. replacement. On the other hand, if just functionality and reliability are desired, then the seleniums should be replaced by silicon rectifiers. However, silicon types cannot just be substituted without some thought on their usage in the circuit.

Because of the lower voltage drop of silicon rectifiers, the rectified DC output voltage will rise when silicon is substituted

for selenium. In cases where the DC voltage is regulated or can be adjusted, such as with the bias rectifier in Dynaco power amps, there is no problem, and no other precautions are needed. In cases where there is no regulation and the DC voltage is critical, such as in DC filament supplies, series resistance should be added to bring the DC voltage to the correct value. This value should be determined from the manufacturer's documentation, since the value measured with the existing selenium rectifier is likely to be low. If there is no documentation, an estimate can be made based on the circuit usage. For example, tube filament supplies are generally multiples of 6.3 volts. Many pre-amps that use low plate-current tubes, such as 12AX7s, will run the filaments at lower voltages (from 5.0 to 6.0 volts) to reduce noise and increase life.

The best way to pick a series dropping resistor is by cut-and-try, since there is no easy analytical way to characterize the current pulses in a capacitor-input rectifier circuit. Either have a handful of low-ohmage power resistors or have a power rheostat, and substitute resistors until the DC voltage is correct. Make sure the AC power line voltage is at a known nominal value (generally 120 volts in North America) when doing this. Pick a power rating so that the resistor does not run too hot. As an example, when the selenium bridge rectifier in a Fisher 500C receiver was replaced, it was found that a 4.7Ω 5 watt resistor was needed to bring the voltage within spec.

The voltage rating of a replacement rectifier can be determined either by counting the plates in the selenium rectifier, or by the AC voltage used in the circuit. Using the plate method, allocate 25 volts per plate (between terminals), and multiply by 2 as a safety factor. Using the AC voltage method, take the AC voltage presented to the rectifier, and multiply by 2.83 for half-wave and center-tapped full-wave circuits or by 1.41 for full-wave bridge circuits. Then take this resulting peak voltage, and multiply it by 1.5 to 2 to give a safety factor. Remember, you can always use a higher-than-necessary voltage rating.

There has been some concern about whether the original selenium rectifier can be kept in the circuit. If you simply wire silicon rectifiers across the terminals of a selenium rectifier, virtually all the forward current will flow through the silicon, bypassing the selenium. This bypassing technique is convenient, since the old rectifier acts as a terminal strip for the silicon rectifiers. However, there have been reports of seleniums burning-out due to reverse current, so for safety, the selenium should not be connected to the circuit.

Using the techniques described above, you can maintain equipment using metallic rectifiers indefinitely.

Bibliography

1. *Metallic Rectifier and Crystal Diodes*, T. Conti, John F. Rider, New York, 1958.
2. *Selection and Application of Metallic Rectifiers*, S. P. Jackson, McGraw Hill, New York, 1957.
3. *Power Rectifiers with Notes on Converting Machinery*, J. Rosslyn, George Newnes Ltd, London, 1941.
4. *Testing and Replacing Selenium Rectifiers*, D. Schoo, *Antique Radio Classified*, Sept. 1997, pp. 18-23.

Moth Audio Corporation



Introducing
The Ultimate Dynamic
Headphone Amplifier.

Hi-Fi Show 98 Westin Hotel suite 976
(213) 467-4300

It's Like Music to Your Ears...

Amperex Bugle Boy audio tubes are back and they're better than ever!

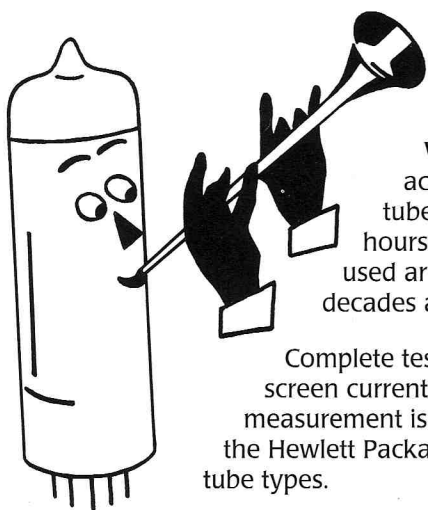

When it comes to selecting premium audio tubes for your amplifier, accept no less than the best, Amperex Bugle Boy! Amperex Bugle Boy tubes are burned in under full load with all voltages applied for 24 hours before being tested for noise & microphonics. The aging racks used are from the original Amperex production line built in Holland decades ago.

Complete test results are supplied with each tube, including plate current, screen current, filament current, and total harmonic distortion (THD). The THD measurement is performed using one of the finest spectrum analyzers available – the Hewlett Packard 3561A. Matching in pairs, quartets & octets is available for all tube types.

Special test requirements? Not a problem. For a slight additional charge we will test and match to your specified operating conditions.

Types available: **6DJ8/ECC88**, **12AU7A/ECC82**, **12AX7A/ECC83** and many more!

So if you haven't dealt with a source capable of meeting your demands, call us at **1-800-TUBE USA** or **630-208-2200** today for information on additional products and the worldwide locations nearest to you. You'll like what you hear!

APD is pleased to announce the addition of **Hammond Manufacturing's** complete line of Classic Transformers and Enclosures to our product offering. Call today for a Hammond catalog or download it from our WEB site at www.tubes-r-us.com/classic.html.



BLUENOTE Midas Dampers are now available, along with other quality audio accessories - such as, equipment isolators and CD/LP treatments. The Midas Dampers (as reviewed in *Stereophile Magazine*, February, 1996) are made of the highest quality materials available. They reduce microphonics in your preamp tubes thereby enhancing the music you hear.

Call **1-800-TUBE USA** or **1-800-882-3872** today for your copy of our **NEW APD brochure** featuring Audio Tubes, **BLUENOTE** and Hammond products.

APD **Audio Product Division**

a division of Richardson Electronics, Ltd.

You can also visit our Classic Components site on the Internet at:

<http://www.tubes-r-us.com>

 **Richardson
Electronics, Ltd.**
ISO9002 Registered

40W267 Keslinger Road
P.O. Box 393
LaFox, IL 60147-0393
(630) 208-2200
(800) 882-3872

*Though **Heath-kits**, **Knight-kits** and **Eico-kits** are gone...
still the Incredible Sound of the 50's is back!*



Model A-8

Easy-to-build Tube Hi-Fi Stereo Kits Made In USA

Model	Description	Assembled each	Kit each	Chrome add-on
A-1	Amplifier 10 Watt Mono Block, 2 x EL-84 P-P	\$ 299	\$ 229	\$ 60
A-2	Amplifier 10 Watt Stereo, 4 x EL-84 P-P	\$ 435	\$ 349	\$ 80
A-4	Amplifier 30 Watt Stero, 4 x EL-34 P-P	\$ 559	\$ 449	\$ 95
A-8	Amplifier 80 Watt Mono Block, 2 x 6146B P-P	\$ 1195	\$ 995	\$ 120
PP-1	Phono Pre-Amp, Stereo with Gain control, 40dB gain	\$ 439	\$ 329	\$ 50
PP-2	Phone Pre-Amp, Stereo with Gain control, 60dB gain	\$ 525	\$ 395	\$ 60
PA-1	Line Pre-Amp, Stereo with Gain, Balance, Treble, Bass	\$ 699	\$ 579	\$ N/A
PA-2	Line Pre-Amp, Stereo with Gain, Balance, 5 inputs	\$ 625	\$ 499	\$ N/A
PA-12	P/A Amplifier 12 Watt Mono, with paging microphone	\$ 389	\$ 299	\$ 60

Prices for protective cages: A-1 & PA-12 = \$39, A-2 = \$77, A-4 = \$89, A-8 = \$99, PP-2 = \$45

Call for your free Catalog now!

Many Models: Amplifiers * Preamplifiers * Phono Preamps
Documentation: Complete easy step-by-step Assembly Manual

ASUSA-Kit

6717 NE 181st Street, Seattle, WA 98155 USA Phone 425-481-8866 Fax 425-485-3836

E-Mail: franklab@ix.netcom.com

S m a l l P a c k a g e .
BIG SOUND.

A L I X - A N N E I I

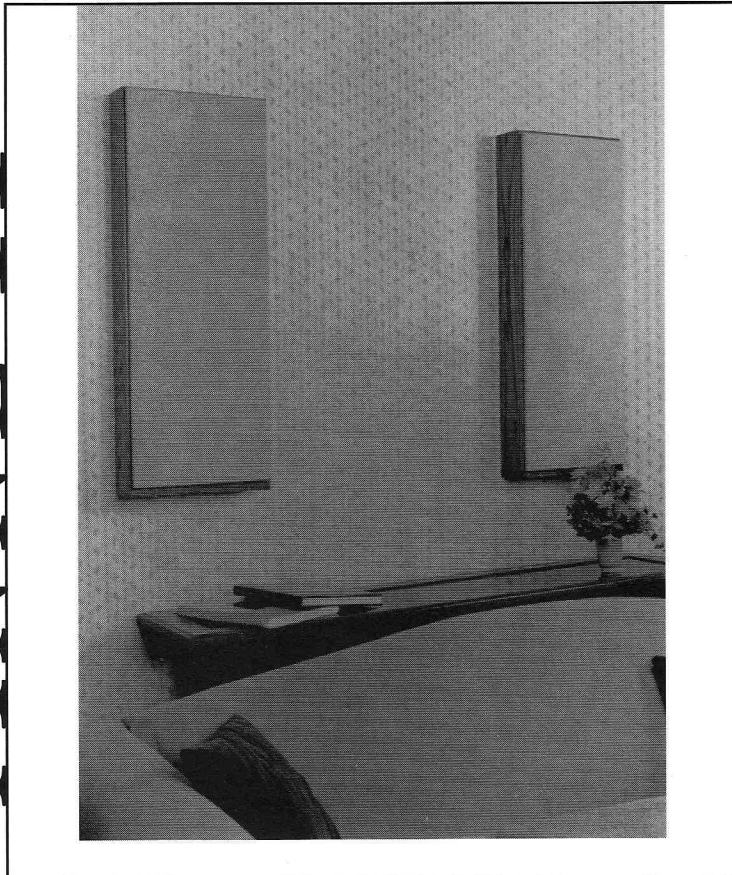

96 dB SPL 2.83v/1 meter sensitivity in a true high fidelity transducer utilizing a patented, pure first order, complimentary symmetry crossover. Suitable for solid state amps to 300WPC: or experience the magic of uncompromised performance with the SE 300B. The stable resistive load that the Alix-Anne II presents to a single ended amplifier results in a near perfect match.

Designed for operation on or in the the wall pressure zone, this wall-mounted speaker uses zero floor space. Dimensions: 37" x 14.25" x 3.875"

Constructed of beautiful, solid, non-endangered hard woods.

Manufactured exclusively by

AMERICAN APPLIED ACOUSTICS
under license from American Power and Light, Inc.

Phone: 916.666.1873

Fax: 916.666.6272

Dealer Inquiries invited
Suggested Retail Price \$3,995.00 per pair

This is a music lover's speaker - the listener is brought closer to the musical event through the window of the Alix-Anne II. There is a seamless integration of the voice of the speaker which leaves the impression of a single perfect driver - no part of the spectrum is favored over another. It has the agility to accurately recreate the transient nature of a piano, a plucked string or a struck instrument. At the same time, it lacks any sign of stored energy of its own so that the natural modulated decay of an instrument sinks into silent blackness in proper time. Another important characteristic is that the speaker neither diminishes nor exaggerates the scale and size of a musical instrument or voice. This is a rare accomplishment in a speaker system. The Alix-Anne II brings the performance to the listener and then disappears so that the connection of listener to performing artist is direct.

Walter Davies, The Last Factory

A LEGEND REBORN!

Enlarged, heavy gauge figured glass bottle handles higher temperatures, improving performance at higher power levels.

Extra thick premium quality star mica spacers (top and Bottom) improves performance stability and reduces adverse microphonics.

Precisely tensioned filaments for better mechanical stability and reduced adverse microphonics.

Deep swaged heavy grid rods made from pure copper provide improved mechanical support for grid windings.

Brite nickel beam focusing electrode concentrates the electron flow precisely on the plate for improved power output.

Heavy duty plates made from a special alloy are stiffened with ridges and coated for strength and durability.

Enlarged phenolic base provides excellent contact with glass envelope and insulation, preventing shorting between critical components.

All specifications equal or exceed the original Genelex Gold Lion KT66 standards.

THE GT-KT66



Groove Tubes... *The American Tube Company, since 1979.*

12866 Foothill Blvd., Sylmar California 91342 USA
Tel: (818) 361-4500 • Fax: (818) 365-9884 • www.groovetubes.com

The legendary British made KT66 is one of the most famous tubes of all time. In the 60's it powered other British legends like Quad Hi Fi amps and the first Marshall guitar amps. This tube was the sound of Eric Clapton on the classic John Mayall Bluesbreakers album.

If you can even find an original KT66 today, they'll set you back up to \$300 apiece.

Groove Tubes has given new life to this legend, creating our own tooling to manufacture it again. We were able to keep the sound and improve on the tube in satisfying ways.

With our precision tooling and modern manufacturing processes, we consistently hold tolerances the 60's original could never attain. Insights from our research allows us to control musical parameters no other tube maker even knows about.

Groove Tubes is offering Performance Matched Duets of the GT-KT66R @ \$120 (U.S. retail price).

Purveyors of "Classic" Transformers & Enclosures

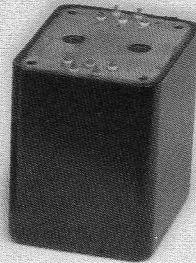
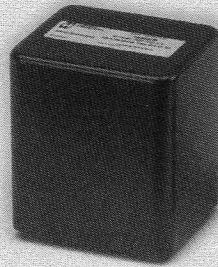
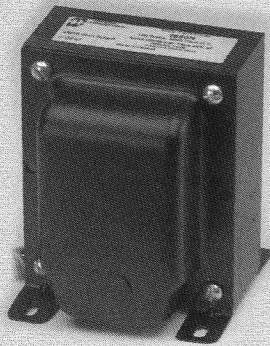

*Single Ended, Push-Pull
and Potted Tube Output
Transformers*

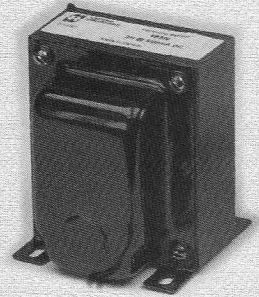

Filter Chokes

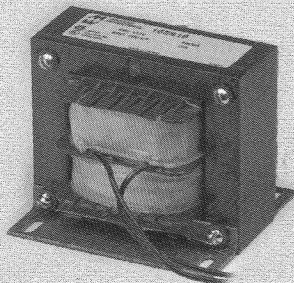

*Open & Enclosed
Filament Transformers*

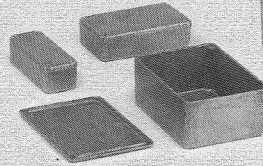

*Aluminum & Steel Chassis
and Diecast Aluminum
Enclosures*

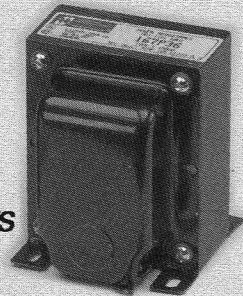

*High Voltage Plate
Transformers*

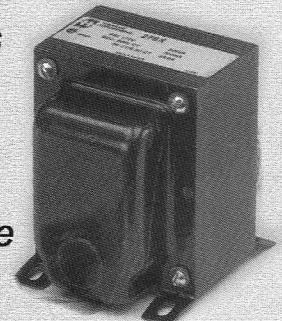

Contact us for a free catalog & list of stocking distributors

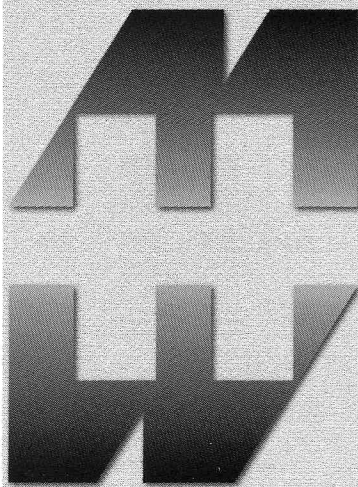

HAMMOND MANUFACTURING™

4700 Genesee St. - Cheektowaga, NY 14225 USA
Phone: (716) 631-5700 Fax: (716) 631-1156
394 Edinburgh Rd., N. - Guelph, Ontario N1H 1E5 Canada
Phone: (519) 822-2960 Fax: (519) 822-0715

www.hammondmfg.com

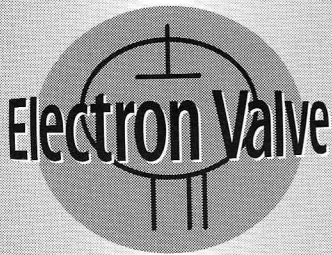

**Your source for hard to find
Vintage Audio Tubes
and Quality Vacuum Tube
Audio Components**

Stop by our website to see a detailed look at all of our products!
www.electron-valve.com • Email: info@electron-valve.com
Phone: 901-382-9955 • Fax: 901-382-9956

We are a proud dealer of **Western Electric** Audio Products.
The current production 300B is now in stock.



Electron Valve stocks a wide array of **NOS** Vintage Audio Tubes like Mullard EL34, RCA 2A3, and Mullard 5AR4. We also have a good stock of Old Production Western Electric tubes such as

205B/D, 252A, 274B, 300B and many others.

Electron Valve carries Precision Tested Ram Labs Reference Tubes. These tubes are computer tested, graded and matched to ultra high specifications predetermined by Roger A. Modjeski.



We also carry the Music Reference **MR** RM-10 (Push-Pull 6BQ5, 35W/Side) Stereo Amplifier and the Music Reference RM-200 (Push-Pull 6550, 100W/Side) Stereo Amplifier.

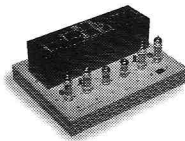

KR ENTERPRISE VV VALVES

Power Triodes Without Output Limit

New Low Prices

The KR Enterprise VV Valves are the first new directly heated triodes to be manufactured in over three decades. Hand built in the Czech Republic with their patented 32 cathode and ribbon filament structure, the VV Valves will provide more power, lower distortion and better tonal fidelity than is available with any other power triode.

VV300B	clear	\$475.00/pr
VV300B	blue	\$575.00/pr
VV302BC	blue	\$575.00/pr
VV32B	clear	\$675.00/pr
VV52B	clear	\$775.00/pr

For more information contact the North American Distributor:

Welborne Labs P.O. Box 260198 Littleton, CO 80126 USA
Voice: 303.470.6585 Fax: 303.791.5783 E-Mail: wlabs@ix.netcom.com

OEM and dealer inquiries invited. The VV Valves are warranted for one year or 2000 hours.

Listen to the VV Valves today and experience a whole new horizon of musical pleasure.

Feel The Glow

Glowing warmly in

amplifiers across the

world, Svetlana Audio

Tubes command high

praises from

musicians and

audiophiles alike.

Achieving smooth,

satisfying tones,

Svetlana Audio Tubes

offer sound no other

can match.



www.svetlana.com

Headquarters: 8200 S.Parkway Huntsville, AL 35802 Phone 205-882-1344 Fax 205-880-8077 • Marketing & Engineering: 3000 Alpine Rd. Portola Valley, CA 94028 Phone 650-233-0429 Fax 650-233-0439

VACUUM TUBE VALLEY

Back Issues, Books, Goodies, & Subscriptions



VTV #1 Spring 1995 \$8 US - \$10 Foreign
Vintage Dynaco Tube Equipment - 1955-77
History and Testing of the 12AX7/ECC83 dual triode
Tube Testing Methods + Early Amplification and Amps

VTV #2 Fall 1995 \$12 US - \$15 Foreign
Heathkit - The Tube Williamson Years 1950-61
EL34/6CA7 History, Types and Tests
Magnum SE EL509 Amplifier Project by Dave Wolze
1927-34 Western Electric Theater Sound Systems

VTV #3 Winter 1995/96 \$12 US - \$15 Foreign
Eico Mono Tube Gear - 1955-62
Altec Lansing 604 Coaxial Loudspeaker History
Western Electric 300B History and Listening Tests
300B SE Transformer Listening Tests

VTV #4 Spring 1996 \$12 US - \$15 Foreign
6L6 History, Types and Listening Tests
Vintage Bookshelf Speakers 1955-1965
Early FM Broadcasting History
HK Citation I & II Amplifier History and Mods

VTV #5 Fall 1996 \$12 US - \$15 Foreign
The Ultimate FM Tuner Shoot Out
Red Bank Guided Missile Tubes for Hi-Fi
The Birth of the Marantz 10B
Choosing Rectifier Tubes for your Guitar Amplifier

VTV #6 Winter 1997 \$12 US - \$15 Foreign
Fisher 500 - History, Models and Restoration
A Tribute to Avery Fisher by the Fisher Doctor
6550 and KT88 History, Types and Listening Tests
Loftin-White Amplifier History by Alan Douglas

VTV #7 Summer 1997 \$12 US - \$15 Foreign
6DJ8 & Frame Grid Tubes + Listening Tests
Altec 1950s Theater Amps and Modifications
The Great Voice - The Peter Jensen Story
Computing with Tubes - The Savage Art
Uncle Eric's Tube Dumpster - 417A/5842

VTV #8 Fall 1997 \$12 US - \$15 Foreign
EL84 History, Types & Listening Tests
RCA Tube Mfg at Harrison, New Jersey
200 watt OTL Amp Project by Allan Kimmel
300B Listening Tests: NOS and Vintage Types
Bruce Moore Tube Audio Pioneer

Vintage Hi-Fi Spotter's Guide-Volume 1
Over 450 photos & specifications of tube audio gear
from the Golden Age of Hi Fi. 86 pp. \$18.95

Vintage Hi-Fi Spotter's Guide Volume 2
Volume 2 covers equipment not listed in Volume 1.
Almost 500 amps, preamps, tuners, etc are depicted.
Edition covers early audio and includes a Speaker section
with most vintage manufacturers. 88 pp. \$18.95

Vintage Hi-Fi and Pro Audio Price Guide
Updated price & grading guide for almost 1,000 vintage
hi fi amps, preamps and tuners. Includes Vintage pro
audio and theater gear. Also, pro loudspeakers, N.O.S.
vacuum tubes and audio transformers. \$30.00

"Vintage Hi-Fi The Golden Era Video"
A one-of-a kind video covering the classic post-war and
1950s home hi fi era. Over 80 classic audio amps, pre-
amps tuners, are shown. This video is professionally pro-
duced. 34 min VHS NTSC \$25.00

The Ultimate Tube Substitution Guide
No tube electronics enthusiast should be without this
book. Over 10,000 tubes are listed on 240 pages includ-
ing: audio, radio, transmitting, and special. Features an
audio tube section with tube evaluation. \$29.95



Vacuum Tube Valley T-Shirts
Two Styles to Choose From!

A) VTV Marching Tubes - "Big Tone"
1 sided available in several colors.
Tan, Sea Foam Green, and Burgundy \$15.00 XL only



B) VTV Tube Sunburst Shirt with 2-color black & orange
art as pictured plus large 2-color RCA tube diagram
exploded view on back. (white or gray) \$20.00 XL only

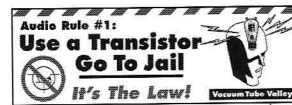

VTV Politically Correct Bumper Sticker
two-color waterproof vinyl 2 1/2 x 10"
Sent post-paid: \$3.50 US - \$4.50 Foreign

Quotes from VTV Subscribers:

"The best audio mag on the planet." "Clearly written with great photographs."
"A wealth of vacuum tube information." "VTV reads with authority and truth..."

ORDER FORM

Name _____ Date _____

Address _____

City _____ State _____ Zip _____

Please Send Me The Following Products

_____ \$ _____

_____ \$ _____

_____ \$ _____

_____ \$ _____

_____ \$ _____

_____ \$ _____

_____ \$ _____

_____ \$ _____

_____ \$ _____

_____ \$ _____

_____ \$ _____

Add \$5.00 Shipping per order in USA / Add \$10.00- Item Air Mail Foreign Shipping

CA Residents Add 7.75% State Sales Tax

(CA Tax)

Credit Cards, U.S. Bank Checks or Money Orders OK

Credit Card # _____

Signature _____

TOTAL ORDER

Exp. Date _____

Subscribe To Vacuum Tube Valley
The Classic Electronics Journal

\$36/year US - 4 issues \$43/Canada,
\$56/Europe & \$66/Asia & World

VACUUM TUBE VALLEY

1095 E. Duane Ave Ste.106

Sunnyvale, CA 94086 USA

408-733-6146 Phone

650-654-2065 FAX

email - triode@vacuumtube.com

www.vacuumtube.com

Western Electric®
High Fidelity

WE300B

**The Standard In
Quality and
Long Life**



Matched Pair WE300B

Western Electric High Fidelity products are marketed worldwide by Westrex Corporation. Western Electric is a trademark of Lucent Technologies Inc., formerly AT&T Technologies, Inc., licensed to Westrex Corp., a company independent of Lucent. Developments of Bell Laboratories. Western Electric High Fidelity products are manufactured in the U.S.A.

Western Electric Audio Products

1230 Peachtree Street • Suite 3750 • Atlanta, GA 30309-3575 • (404) 874-4400 fax (404) 874-4415
e-mail: sales@westernelectric.com • internet: www.westernelectric.com



TUBES - PARTS - BOOKS - SUPPLIES

(602) 820.5411 FAX (800) 706.6789

FIND EVERYTHING YOU NEED
BUY IT FOR A SONG.

*Where can I find a 6BQ5
replacement tube?*



Call or fax today for our new 60 page **FREE** catalog of vintage tubes, hard to find parts, books and supplies. We have everything you need to build new or repair classic audio equipment at prices you haven't seen in decades.

6221 SOUTH MAPLE AVENUE
TEMPE, AZ U.S.A. 85283

VISIT OUR WEBSITE AT WWW.TUBESANDMORE.COM

