

# VACUUM TUBE VALLEY™

Issue 10  
Summer/Fall 1998

The Classic Electronics Reference Journal

Published Quarterly  
Price \$9.00

## Baby Blues Bottle: The 6V6

### McMurdo Silver

Quality Hi-Fi in the 1930s

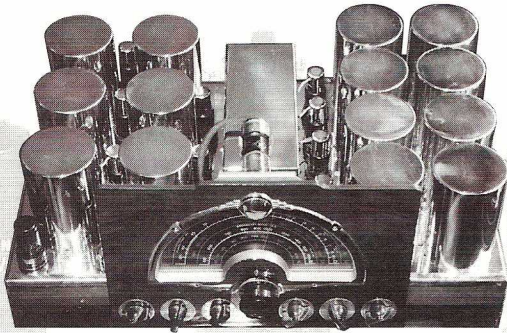

### Ultrathin Line Amp

Transformer Coupled Preamp



### Rediscovering the 6AV5

A Dumpster tube with attitude

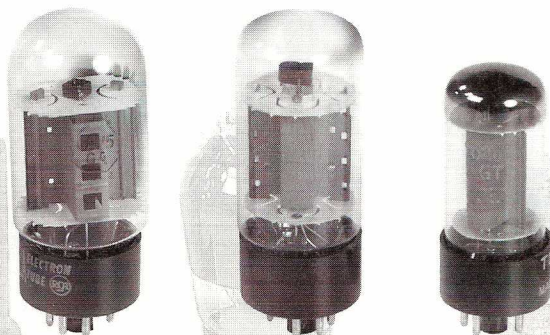

Visit us on the web  
[www.vacuumtube.com](http://www.vacuumtube.com)



**VTV Issue # 10  
Table of Contents:**

**Baby Blues Bottle: 6V6.....3**  
**Listening to the 6V6.....9**  
**The Ultrathin Line Amp.....11**  
**McMurdo Silver.....13**  
**Bruce Moore Part 2.....18**  
**Tube Dumpster 6AV5.....21**  
**Vacuum Tube Calculator.....22**  
**Maxi-Matcher Review.....24**  
**35 Watts of Triode Power...25**  
**Distortion Analyzers III.....29**  
**Tube Industry News.....33**  
**Advertiser Section.....34**

**VTV Wins Excellence in Publishing Award**

Due the skillful work of VTV Art Director, Steve Parr, and our printer, Olympic Screen Crafts in Fremont, California, VTV was presented a Bronze award (3rd place) for excellence in printing and superb craftsmanship. This is quite an accomplishment, because there were over 500 other entries, some with huge staffs and graphics budgets. The Excellence in Publishing competition is an annual event and is sponsored by The San Francisco Club of Litho and Printing House Craftsmen. **Kudos to Steve!**

**VTV at a New Location**

The offices of Vacuum Tube Valley have moved to Belmont, California. We also have new telephone and FAX numbers. Please use the following address to correspond or mail payments, letters, etc.:

Vacuum Tube Valley  
 P.O. Box 691  
 Belmont, CA 94002 USA  
 Telephone - (650) 631-6550  
 FAX - (650) 654-2065

**VTV Opens New Pro-Tube Shop**

To meet the growing demand for a retail source providing guitar amp & audio vacuum tubes and quality tube audio repair, VTV has opened a *by appointment only* shop in the San Francisco Bay Area.

The store will feature a retail display and sales area featuring new (Svetlana, Sovtek, Shuguang) and NOS audio tubes, parts, classic vacuum tube books and literature, back issues of VTV, T-Shirts and vintage tube hi-fi equipment sales. We stock and display classic Dynaco, Fisher, Heathkit, Pilot, H. H. Scott, etc. vintage hi-fi gear. In addition, we offer professional tube audio-consultation, repair, restoration and service of guitar amplifiers, high-end tube audio and vintage hi-fi equipment.

*Walk-in visitors without an appointment are discouraged* due to our commitment to individualized customer service. If you are in Northern California on a business or pleasure trip, give us a call to stop by the VTV Pro-Tube Shop. A mail order service for tubes, caps, sockets and vintage parts is in the works as well.

**(650) 631-6550 Phone**

**(650) 654-2065 FAX**

**triode@vacuumtube.com**

**New York Tube School Postponed**

Due to receiving less than 40 pre-registrations for the VTV New York Tube School, we are postponing this event that would have occurred in Fall 1998.

**VTV Lost in the Mail?**

We have had many reports of VTV issues not arriving in subscriber mail boxes. This is likely due to inadequacies of the post office or tube enthusiast postmen too cheap to subscribe. If your VTV does not arrive, it is not because we did not send it to you. VTV has a very dependable database and accurate mailing system. Before we can send you a replacement issue, you need to fill out a lost mail form at the post office regarding the lost issue, and send a copy to us. If the post office receives enough lost mail complaint forms, they may investigate this matter and find the culprits.

**Additions and Corrections**

**VTV #4, page 15**, Harman-Kardon Citation I & II, second column, second paragraph: Edward Duda, an engineer for Lafayette Electronics, was the main designer for the Lafayette KT-550A amplifier and KT-600A preamp. Stewart Hegeman was responsible for a portion of those designs.

**VTV #9, page 21**, Winter CES Report, first column, fourth paragraph: **Lars-X** should be **Loth-X**, a speaker and amp manufacturer.

Loth-X Audio Pty. Ltd., 37 Tannery Lane, #03-09, Tannery House, Singapore 347790

**VTV #9, page 10**, Transmitting Tube Test Amp schematic: capacitor values are listed as farads (f) **instead of microfarads (uf)**.

**Note:** The front-end power supply for this amp is a modified voltage doubler and does work, according to John Atwood, Technical Editor. Usually the center tap on the power transformer is unused, but in this circuit, it is used and the supply works correctly.

**EDITORIAL STAFF**

**Charles Kittleson** - Editor and Publisher

**John Atwood** - Technical Editor

**Eric Barbour** - Senior Editor

**Terry Buddingh** - Guitar Editor

**Steve Parr** - Art Director

**Julie P. Werner** - Copy Editor

**Website** - www.vacuumtube.com

**Vacuum Tube Valley** is published quarterly for electronic enthusiasts interested in the colorful past, present and future of vacuum tube electronics.

Subscription US\$36.00/year (4 issues)  
 \$43/Canada and \$66/Asia, \$53Europe

**US Bank Check, Credit Cards or Cash are accepted for payment.**

**Phone - (650) 631 - 6550**

**FAX - (650) 654 - 2065**

Copyright 1998 **Vacuum Tube Valley™** and **Big Tone™**. All rights reserved.

No part of this publication may be reprinted or otherwise reproduced without written permission of the publisher.

Send circulation and editorial correspondence to:

**Vacuum Tube Valley**

P.O. Box 691,  
 Belmont, California 94002 USA  
**e-mail triode@vacuumtube.com**

**ISSN # 1095-4805**

# Baby Blues Bottle: Story of the 6V6

By Eric Barbour

© 1998 All Rights Reserved

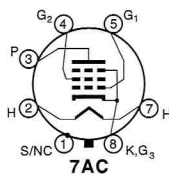

5-tube radios). 45s were good, but their direct heating and low sensitivity made them difficult to use in AC-DC and farm radio circuits. 50s were too inefficient and required too much plate voltage. And the arrival of indirect heating meant that the 47 was going to be pushed out of the way. RCA and/or GE were responsible for most of these developments.

The story of this small beam tetrode does not start with beam tetrodes; it starts with early power pentodes. And it begins with a common misconception: those who worship the might and power of RCA will be disappointed to hear that European firms were the first to pioneer audio output pentodes. RCA, and the rest of the American radio industry, were three years late to the party, and had fixated on triodes for this job until the greater efficiency of the pentode at low plate voltages could no longer be ignored.

## History

Philips introduced the first, the B443, in 1927. It was followed by the Mullard PM24 (1928), then by later Philips versions C443 and E443 (1929), then by the Mullard PM series (1929). All were directly heated. The first one with indirect heating was the Mazda AC/Pen of 1930. A very successful tube in the UK, it engendered a long series of pentodes, then beam tetrodes.

American firms eventually caught on. Champion showed the P-704 in 1930, followed by the Arcturus PZ. These types apparently were not especially reliable, and produced less than 2 watts in single-ended class A audio amplifiers. RCA, the alleged powerhouse, finally put some of its large engineering staff to work on it,

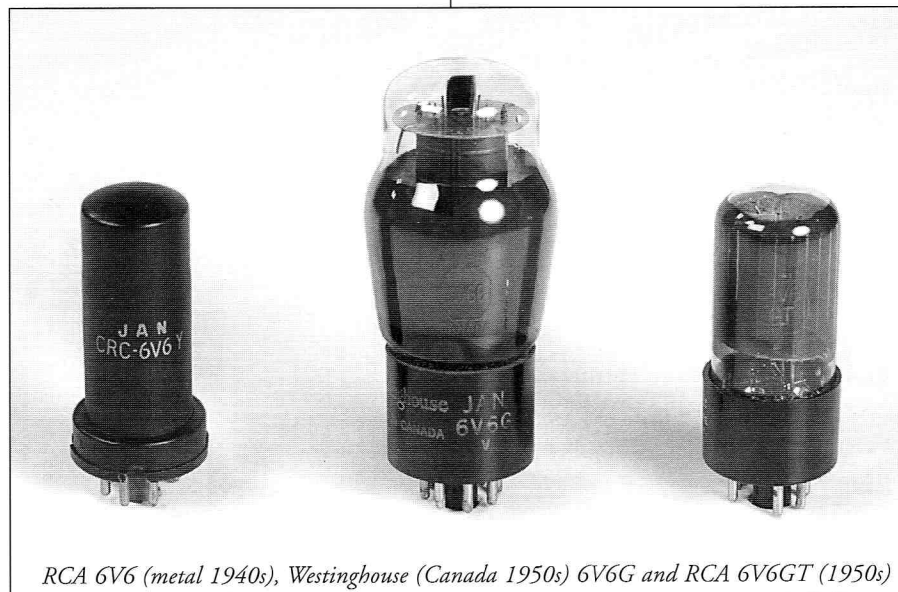

RCA 6V6 (metal 1940s), Westinghouse (Canada 1950s) 6V6G and RCA 6V6GT (1950s)

and introduced the 247 in late 1930. It was the first American audio pentode to be a real success. Bubble-envelope 247s and ST-envelope 47s are found in scores of radio receivers of the 1931-35 era. And they became the basis for an entire family of pentodes with about 10 to 12 watts of dissipation.

Manufacturers kept pushing for more power at 250 volts (a typical B+ value in

The result reads like Genesis, with the 47 begetting the entire 10-watt to 12-watt tube line. It begat the 38 (1931), a smaller device than the 47 and the first with a 6.3v heater and cathode. The 38 begat the 59 (1932), with its 2.5 volt heater and dual cathodes inside a 47-like structure. The 38 also begat a smaller 2.5 volt version, the 33. The 59 begat the 42 (1932), with a 6.3v heater and the first cylindrical structure of the series. Then the 42 begat the 2A5, similar but with a 2.5v heater.

And finally, the 42 was put into the new metal envelope with the innovative "octal" base, resulting in the 6F6 (1935). Innumerable Zenith and Philco tombstone radios used a single 6F6 as the audio output. The only component hi-fi amplifier to use this tube was the very rare Stromberg-Carlson Custom 400 of 1952. There were a few smaller tubes of the series such as the 6K6GT, but the power pentode development receives less attention after the 6F6, because RCA's engineers were developing the beam tetrode 6L6. It seems VERY obvious that the 6V6 was directly derived from the 6F6, their ratings are so similar.

Judging from the little information we have, the 6V6 (very late 1936, introduced

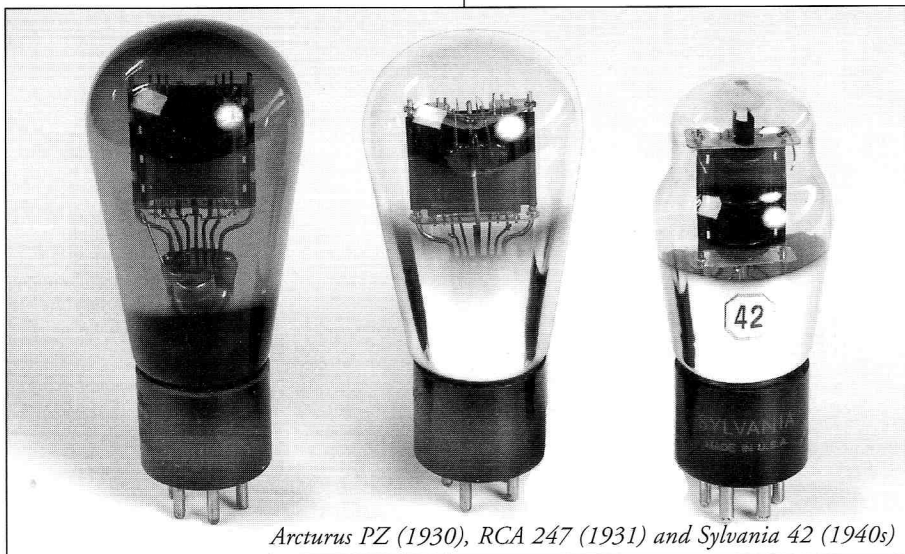

Arcturus PZ (1930), RCA 247 (1931) and Sylvania 42 (1940s)

## 6 V 6 : B A B Y B L U E S B O T T L E

1937) was developed by the same team that created the 6L6; Arnold Haeff, H. C. Thompson, T. M. Shrader and Otto Schade are names which are likely to appear. I say "likely" because the 6L6's development was heavily documented, while the 6V6 was just a baby 6L6 for use in single-ended mode in cheap radios. 2.5 watts undistorted (which apparently meant 5% distortion) was the target that the 6V6 met. And it did so with greater plate-power/heater efficiency than any of its predecessors.

### Ratings of the 247-6V6 Family

Type	Pdiss	Vpmax	Heater
247/47	no spec	250v	2.5v, 1.75A
38	no spec	250v	6.3v, 0.3A
59	10 watts	250v	2.5v, 2.0A
42	11 watts	375v	6.3v, 0.7A
6F6	11 watt	375v	6.3v, 0.7A
6V6	12 watts	350v	6.3v, 0.45A
6V6GT	12 watts	350v	6.3v, 0.45A
7C5	12 watts	315v	6.3v, 0.45A
6Y6	12.5 watts	200v	6.3v, 1.25A
6W6	10 watts	330v	6.3v, 1.2A
6U6	11 watts	300v	6.3v, 0.75A
6V6GTA	14 watts	350v	6.3v, 0.45A
5871	12 watts	350v	6.3v, 0.45A
5992	10 watts	300v	6.3v, 0.6A
7408	14 watts	350v	6.3v, 0.45A
6EY6	11 watts	350v	6.3v, 0.68A
7EY6	11 watts	350v	7.2v, 0.6A
6EZ5	12 watts	350v	6.3v, 0.8A
KT61	10 watts	350v	6.3v, 0.95A

Very soon after the metal 6V6 came the glass 6V6G. Finally came the last member of this series, Sylvania's "loktal" version of the 6V6, the 7C5 (1939). After that came World War II and television, resulting in a random explosion of beam-tetrode tube types for hundreds of new applications. Documenting this post-1940 industrial expansion would be nearly impossible at such a late date; in the past, it was not considered to be of importance by radio and tube collectors.

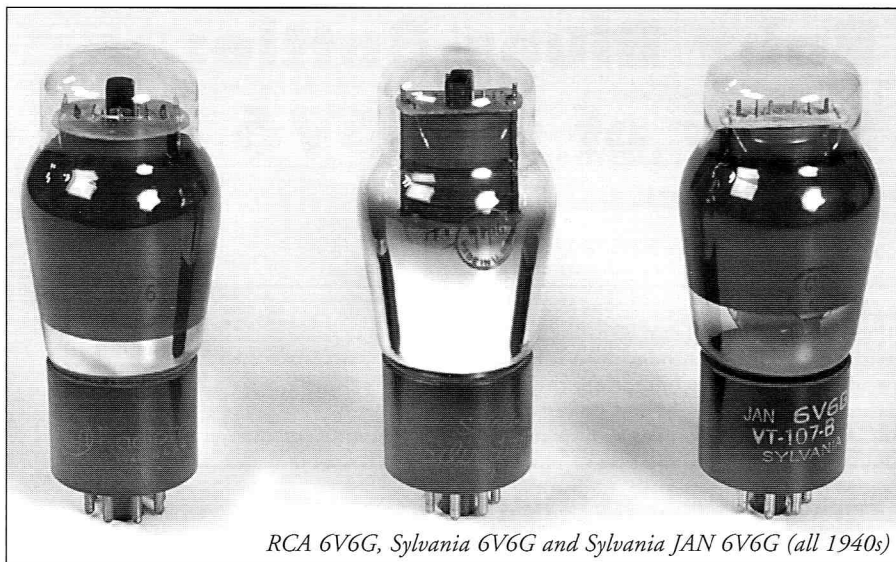

*RCA 6V6G, Sylvania 6V6G and Sylvania JAN 6V6G (all 1940s)*

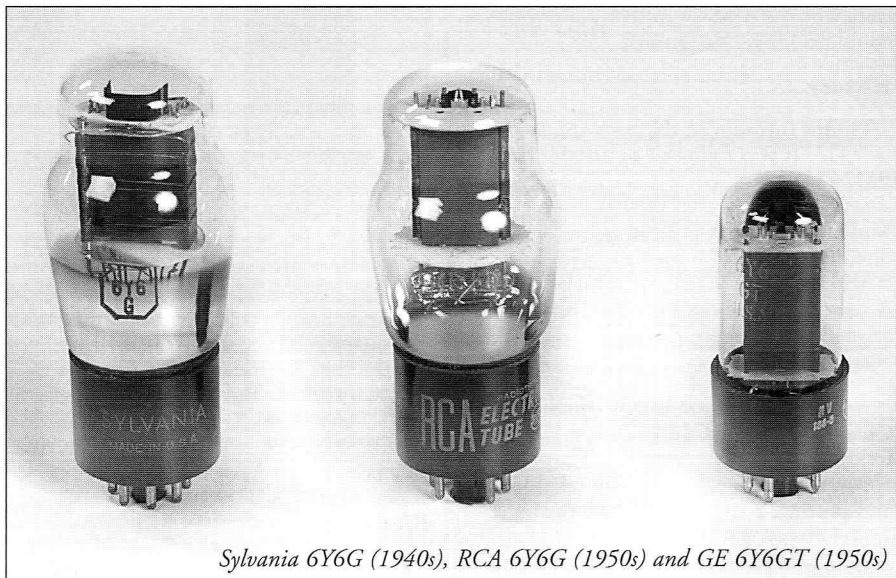

*Sylvania 6Y6G (1940s), RCA 6Y6G (1950s) and GE 6Y6GT (1950s)*

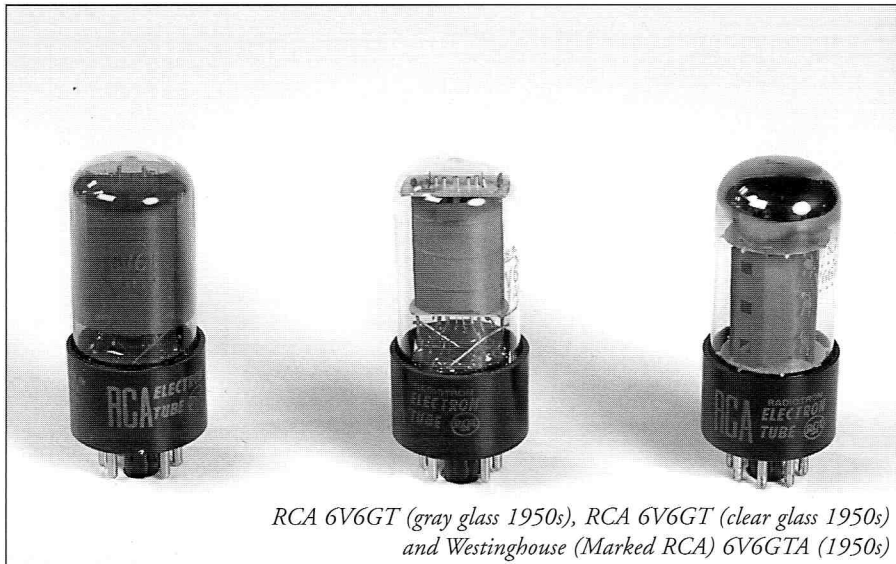

*RCA 6V6GT (gray glass 1950s), RCA 6V6GT (clear glass 1950s) and Westinghouse (Marked RCA) 6V6GTA (1950s)*

**Check out VTV on the  
World Wide Web:  
[www.vacuumtube.com](http://www.vacuumtube.com)**

**We now get over  
12,000 visits to our site  
every month!**



There were a few parallel developments. The 12-watt tubes also had an 8.5-watt family, starting with the 41 (1932), leading through the octal 6K6 (1936), to the loktal 7B5 (1939). Even more obscure is the Sylvania 6G6G (1937). Although it has only a 2.75 watt rating, all the books call it a power pentode. Apparently it was used in portable radios.

There were three beam tubes which were vaguely similar to the 6V6, and appeared to be intended for audio applications. RCA's 6Y6 (1937) was used as a high-voltage oscillator in pre-WWII TV sets with electrostatic-deflection CRTs, and (occasionally) as the audio output in TV sets and in military radios. It had a much larger cathode than the 6V6, for more plate current on 200-volt (or less) plate supplies. The 6Y6 was remarkably similar internally to series-string beam tetrodes, such as the 25L6, 35L6 and 50L6, so it may have been derived from the 43-25A6 series of pentodes, which produced the L6 series--all intended for low-voltage use. 6Y6s were occasionally used in hi-fi by hobbyists, and the Acrosound catalog of 1955 shows a 6Y6 amp. We should point out that the 6Y6 is not rated for typical 6V6 operating voltages, though it was very conservative. Plug it into a 6V6 amp at your own risk.

Tung-Sol's 6W6 (1939), with slightly lower dissipation but higher voltage ratings, was also aimed at low-voltage audio output duties. And the rarely-seen 6U6 from Sylvania (1940) was similar to the 6W6 but with lower heater consumption. The 6U6 is seen in a few 1940s TV sets as the audio output. Like the 6Y6, the 6W6 and 6U6 were intended for low-voltage applications and may not be suit-

able for use in 6V6 amplifiers. Well after the 6Y6 family ended, various firms developed special versions of the 6V6, often for hi-fi or industrial/military uses. There were many heater-voltage variations: the 5V6GT plus a variety of series-string and automotive radio types, such as the 12A6 and 25C6. Sylvania's 5871 (1950) was a rugged version intended for mobile radios. The most notorious super-6V6 was the Bendix Red Bank 5992 (1952), a fine example of wretched excess in tube design and the progenitor of the entire Red Bank line. See VTV #5 for more on Red Bank tubes.

Two types which were never intended for use in audio have become 6V6 replacements because they are close enough to work, and have the same pinout. GE's 6EY6 and 6EZ5 (mid-1950s?) were intended only as vertical-output drivers for TV sets. Their voltage ratings are very conservative, making them well-suited for older Fender Deluxe amps that run more than 400v on the plates. If the Deluxe owner decides to use these, be warned that their heaters draw MUCH more current than standard 6V6s, and that this can overload the power transformer in the amp. The 7EY6 is a version of the 6EY6 with a slightly different heater voltage, for use in series-string color TVs.

The final version to be developed was the GE 7408 (1959). Intended for high-fidelity applications, it proved to be less than a resounding success--very few OEMs used it. Old stock 7408s bring high prices today, because of their conservative ratings and extra-rugged grids, making them well-suited for guitar amps.

1948 RadioCraftsmen RC-2 10 watt 6V6 amplifier



By the way, the -X suffix indicates a ceramic base, and -Y indicates a "Micanol" base for low-loss RF applications. The only real super-premium versions of the 6V6 were the -5871, 5992 and 7408. There were a few "GT/G" versions in the past, basically just -GTs. Any further alphabet soup that you might find on a newly-marketed tube is just an attempt to snow the user with jargon. Only two TRUE 6V6s have been made since GE/MPD and Philips/Sylvania stopped production, a low-cost Russian version with black-painted glass, and a very similar Chinese version. Neither one can be used in an older Fender Deluxe guitar amp without self-destruction. Beware of the large guitar-tube distributor who sells a "6V6HD," which is actually a cheap Russian 6L6. This tube requires totally different biasing and plate loading and much more heater power. It may kill a vintage amplifier. Use their genuine 6V6GT instead.

There were a few European versions. The best-known was MOV's KT61, a high-sensitivity tube designed to be driven directly from an AM radio detector, thus saving a triode stage. It is not equivalent to the 6V6, but may be a substitute for it in certain applications. Most tube substitution guides equate it with the highly rare Sylvania 6AG6G. The classic Leak TL-10 amplifier used a pair of KT61s. Another version was the KT63, actually a premium 6F6GT. And CV731 is the UK military designator for the 6V6GT. Most 6V6s manufactured in Europe occurred under the American designator.

**Applications**

The 6V6GT so dominated the early hi-fi market that no other output tube was used so widely prior to 1955--not even the 6L6. Example: without their first success, the 20W-2 amp (with two 6V6GTs in the famous Unity-Coupled circuit), McIntosh Laboratory might not exist

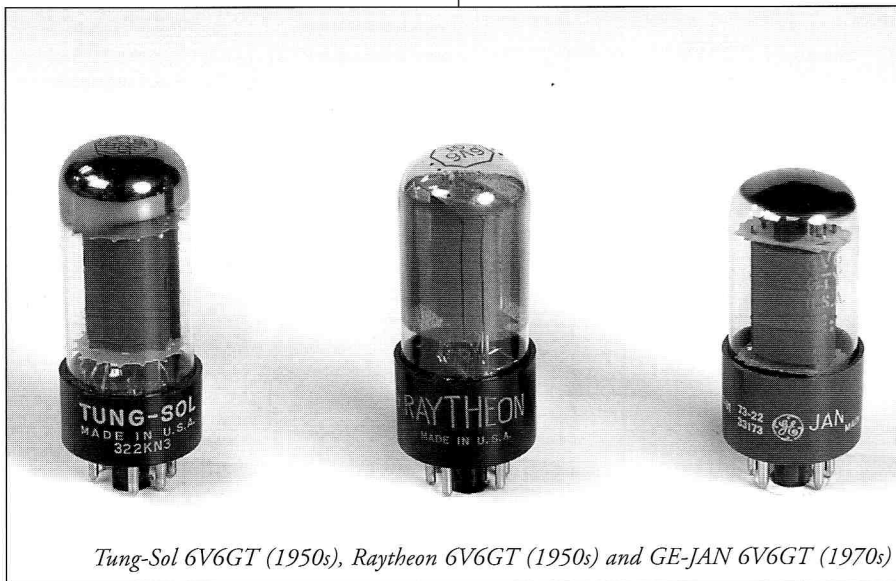

Tung-Sol 6V6GT (1950s), Raytheon 6V6GT (1950s) and GE-JAN 6V6GT (1970s)



# 6V6: BABY BLUES BOTTLE

1955 Regency HF-150 Integrated 6V6 Amplifier



Electro-Voice, George Gott, Grommes, Fisher (in early consoles), Harman-Kardon, Knight-Kit, Lafayette, Langevin (in pro-audio line amplifiers), McGohan, Munston, Newcomb, Pilot, Radio Craftsman, Rauland, RCA, Realistic, Regency, Sargent-Rayment, E. H. Scott, H. H. Scott, Stromberg-Carlson, and Triad, plus many other firms, were 6V6 consumers (usually of the GT style).

today. They managed to squeeze 20 watts out of these tubes with a high plate voltage. Popular amps by Bell, Bogen,

As a quick guide to the hi-fi collectors, we should note that most 6V6 amps were not the best quality. They tended to be low-cost kits or small "beginner" units

with very basic controls, often intended for use with cheap crystal or ceramic phono pickups. Some exceptions include the Electro-Voice A-20C with its "Circlotron" design; the Newcomb A-127; RCA's SP-10 and SP-20; and the Regency HF150. These were top-line models that just happened to use 6V6s; they apparently are all rare and little-known today.

There were also an endless list of console and portable phonographs from OEMs such as Magnavox, RCA and Motorola, which all added up to a dominant market position. This in addition to the millions of post-1937 radios it was used in, plus various obscure industrial and military jobs. Not to mention two of the smaller Hammond organs, the M-2 and M-3.

Probably the only other audio power tube that enjoyed similar success was the 6L6. The 6BQ5 eventually replaced 6V6s in most such jobs, and only by the late 1950s. Manufacture of some kind of 6V6 has continued since its introduction, although we are presently down to two confirmable sources.

In fact, the only major hi-fi firms we can think of that did not use the 6V6GT came into the market after 1955, or were very specialized: Dynaco, Eico and Marantz, not to mention triode specialists such as Brook. Acrosound did not make a 6V6 amp, but they did make transformers for it, the TO-270 and the "Ultralinear" TO-310.

6V6 guitar and instrument amplifiers occupied the low end of the market for some 20 years, from the late 1930s until the late 1950s. Nearly every small Hawaiian-guitar amp (including those infamous "mother-of-toiletseat" jobs) used a single 6V6. And the most classic small amps of all, the Fender Champ, Princeton, Harvard, Deluxe and early Tremolux models, were strictly 6V6 users. Not to mention most small Gibson amps before 1960. Plus the Fender Reverb effects-unit, which used a 6V6 (6K6 in early versions) as the reverb spring driver. Also, the obscure Jim Kelley amp of the 1980s managed to get 60 watts out of only four 6V6GTs; such an amp MUST be retubed only with top-grade NOS tubes, if the screen voltage is not decreased to allow the use of low-cost types.

And even though 6V6 manufacture has declined since 1988, there are still modern music amps being made to use it: Fender, Mesa, Speedster, Tone King, London Power, Analog Brothers, Top Hat

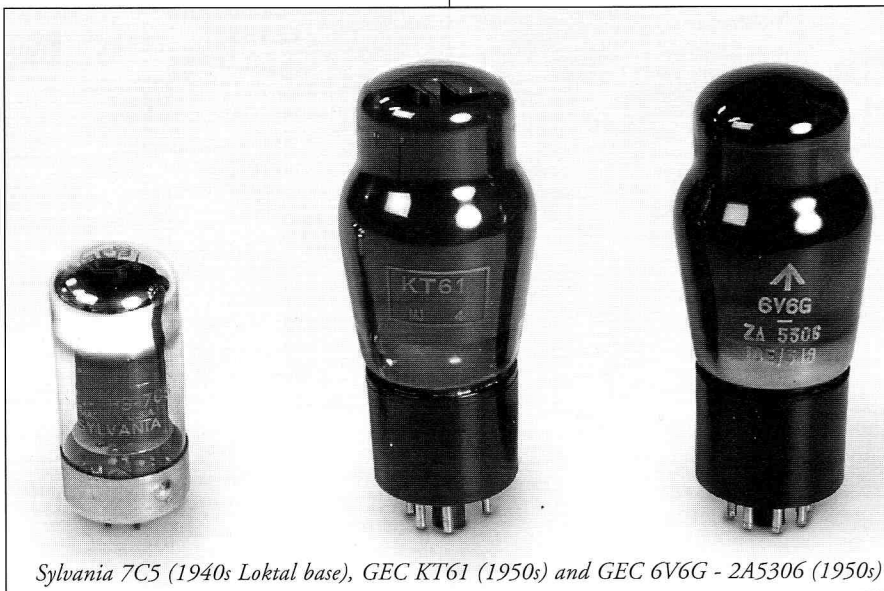

Sylvania 7C5 (1940s Loktal base), GEC KT61 (1950s) and GEC 6V6G - 2A5306 (1950s)

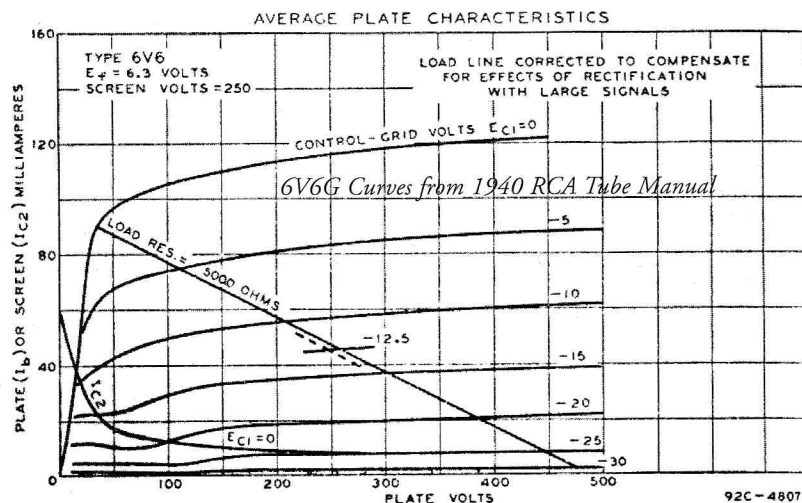



# 6 V 6 : B A B Y B L U E S B O T T L E

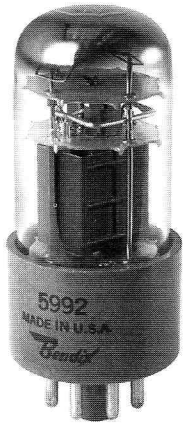

*Bendix Red Bank  
5992 (1950s)*

and Victoria feel serious enough about the unique clipping distortion of the 6V6GT to keep making products using this nearly-dead device. The only recent hi-fi amplifier we can think of that used 6V6s was the Mesa Tigris, which is no longer in production. It has been a LONG time since the 6V6

was used for any application other than low-power guitar amps.

### Tests

As usual, we subjected a random collection of 6V6 versions and variations to our distortion and peak-power tests. Although the same amplifier chassis, analyzer and other equipment were used for previous tests, these figures should not be compared directly to other tube-type results. The 3200-ohm load impedance is a bit lower than is usually specified for 6V6s (though, for a GIVEN impedance, the distortion seems to be quite consistent within a tube family). We apologize if your favorite type is not shown in our lists--6V6s found used tend to be too worn-out for further use. And (as usual) we had to depend on the collections of friends and colleagues to amass this cross-sample.

All types were tested at 300v on plate, 300v screen, 40 mA, 3200 ohm plate load. Distortion figures are second harmonic at 1000 Hz and arranged in order of increasing distortion. \*=good used tube. #=very high grid leakage current observed.

Type	Distortion %
6V6 RCA metal JAN 1954 *	.58
6V6G GE/Zenith 1940s*	.62
6V6G GE 1949*	.63
6V6G GE/Coronado 1930s*	.67
6V6GT Syl black base 1979*	.70
6V6GTY GE JAN	.72
6V6G GE 1949*	.72
6V6G Syl JAN 1940s*	.72
6V6GTY Syl JAN 1969 brown base	.73
6V6 RCA/HP metal 1960 *	.73
6V6GTY RCA JAN 1952 brn base*	.78
6V6G Cunningham/RCA 1940s*	.79
6V6Y RCA metal JAN 1950s*	.80

6V6G Syl/Silvertone 1930s*	.80
6V6G GE 1949*	.80
6V6GTY GE JAN 1956 brn base*	.81
6V6GT GE JAN 1975 black base*	.81
6V6GT Syl JAN 1976	.82
6V6GT Mazda French mil '50s	.82
6V6GTY GE Canada brown 1961*	.83
6V6G Cunningham/RCA 1940s*	.84
6V6GT Mazda French mil '50s	.84
6V6GTY Syl JAN 1976 brn base*	.85
6V6GTY GE JAN 1956 brn base*	.86
6V6G GE/Coronado 1930s*	.86
6V6GT Mazda French mil '50s	.87
6V6G RCA 1940s*	.88
6V6GT Syl 1950s top getter	.82
6V6GT RCA Victor 1948	.91
6V6GTY Raytheon JAN 1958*	.92
6V6GT GE 1953	.92
6V6GTY Syl JAN 1967	.92
6V6G RCA Victor 1940s*	.93
6V6GTY GE JAN 1973 brn base	.94
6V6GTY Syl JAN 1970 brn base*	.94
6V6G/ZA5306 GEC Brit. mil 1953*	.94
6V6GT/G Syl "Groove Tubes NOS"	.95
6V6G GE/Zenith 1940s*	.95
6V6GT Mazda French mil '50s	.97
5992 Bendix Red Bank 1956	1.00
6V6GT Visseaux French mil 1951	1.00
6V6G/ZA5306 GEC Brit. mil 1953*	1.00
6V6GT Visseaux French mil 1951	1.02
6V6GTY Syl JAN 1967	1.02
6V6G Marconi Canada '40s	1.02
6V6G Westinghouse Canada '40s	1.02
6V6G/ZA5306 GEC Brit. mil 1953*	1.02
6V6GT Russian 1970s	1.05
6V6G Marconi Canada '40s	1.05
6V6GTY Syl JAN 1964 brn base*	1.05
6V6GT RCA 1960s	1.05
6V6GT Syl '60s dark top	1.05
6V6G/ZA5306 GEC Brit. mil 1953*	1.05
6V6GT/G Syl "Groove Tubes NOS"	1.07
6V6 metal GE 1970s	1.07
6V6GTA RCA 1970s	1.10
7408 GE '70s *	1.10
KT61 MOV/Genalex '50s *	1.10
5992 Bendix Red Bank 1958	1.12
6V6 GE metal '60s *	1.15
6V6G/ZA5306 GEC Brit. mil 1953*	1.15
6V6GT/G Syl JAN 1940s*	1.17
6V6GT Russian 1970s	1.20
6EY6 RCA 1960s	1.20
6V6G Syl/Silvertone 1930s*	1.20
6EZ5 GE 1960	1.22
6V6G Syl JAN 1940s*	1.22
6EY6 GE 1960	1.25
6EY6 RCA 1960s	1.25
6V6GTA Tung-Sol 1950s/60s	1.27
6V6G Westinghouse Canada '40s	1.27

6V6GTA RCA JAN 1955	1.30
7408 RCA '60s *	1.30
6V6GTY GE JAN 1973 brown base	1.37
7408 RCA '60s *	1.42
6V6GTY GE JAN 1973 brown base	1.45
7408 RCA '60s *	1.47
6EZ5 GE '70s	1.50
7EY6 GE '70s (6.3v on heater)	1.52
6EZ5 GE 1960	1.55
6V6GTA RCA 1960s	1.57
6V6GT Raytheon 1964	1.57

### Low Plate Voltage Beam Tube Family

6Y6G Syl dual-cathode '40s *	0.20
6Y6G Syl dual-cathode '30s *	.27
6Y6G Syl dual-cathode '40s *	.32
6Y6GT GE JAN 1978 *	.57
6Y6GT GE JAN 1978 *	.58
6W6GT Mullard Italy 1960s	.66
6Y6G GE 1957*	.67
6Y6GT GE '70s *	.68
6W6GT Raytheon '60s	.70
6Y6G GE '70s *	.73
6W6GT Raytheon '60s	.77
6W6GT Raytheon '60s	.77
6Y6G Ken-Rad JAN '40s*	.88
6Y6G RCA 1959 *	1.05
6U6GT National Union 1950	1.12
6U6GT National Union 1950	1.15
6W6GT RCA '50s	1.20
6W6GT RCA '50s	1.22
6Y6GA Westinghouse 1975 *	1.20
6Y6G RCA '60s *	1.22
6U6GT National Union 1950	1.25
6U6GT National Union 1950	1.30
6Y6GA RCA '70s *	1.65
6Y6GA RCA '70s *	1.95

### Pure Pentode Types

6F6 RCA metal 1951 *	.21
6F6 metal GE 1960	.69
349A Western Electric 1940s*	.69
6F6G Syl/Philco '30s *	1.00
6F6GT Syl '50s*	1.05
6F6G Syl/Silvertone '40s *	1.15
6F6G Syl/Philco '30s *	1.52
6F6 RCA metal 1951 *	1.20
6F6G Syl/Silvertone '40s *	1.20

From this list, we can make a few inferences.

1. 6V6s were not the most consistent tubes ever made: it does seem, though, that GEs tended to have less distortion than other brands.



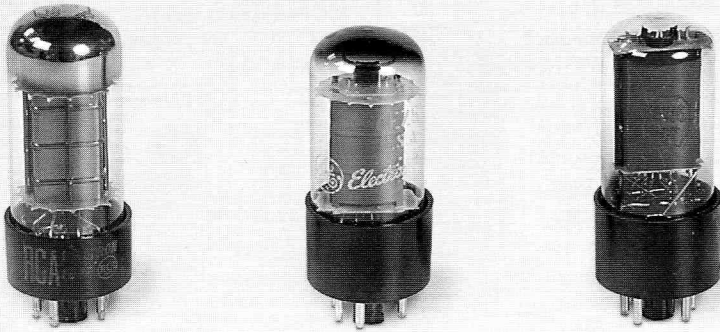

RCA 6EY6GT (1950s), GE 6EZ6GT (1970s) and RCA 6W6GT (1960s)

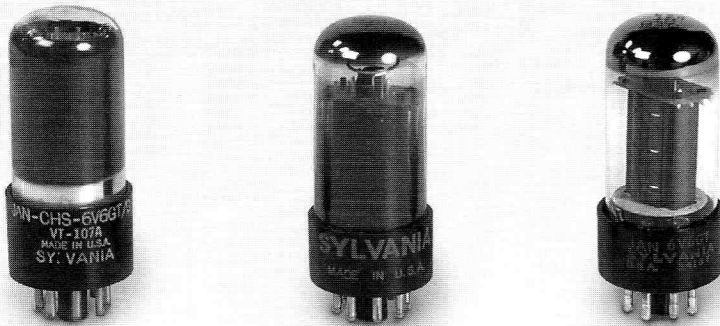

Sylvania types: JAN 6V6GT (1940s), 6V6GT (1950s) and JAN 6V6GT (1980s)

2. The 6V6G and 6Y6 types usually were lower in distortion than 6V6GTs, even the "premium" versions. (The low plate loading was probably most favorable to the 6Y6s.) 6F6s tended to be erratic, and 6W6/6U6s seem to be little different from 6V6Gs.

3. The much later 6EY6 and 6EZ5 have MUCH more distortion on average than 6V6s (and it didn't matter at the time, as they were not intended for audio).

4. The early Sylvania version of the 6Y6G, with its unusual dual cathodes, has distortion more in line with a 2A3 than a beam tetrode. This rare type could become a hot collector's item.

5. As many people have suspected for many years, grid-winding quality control started to decline after 1950. Tubes made after that seem to have more distortion than tubes made before 1950. Later RCAs were especially bad.

Finally, although the peak-power tests are not shown here, we will summarize: the 6Y6, 6W6, 6EY6 and 6EZ5 had much larger cathodes than any 6V6 variant, giving them far more peak-power capability. All this tends to make the 6Y6

family appear to be better for hi-fi use, while those desiring aggressive distortion in a guitar amp can look for the 6EY6/6EZ5s. Be careful about using lower-rated tubes in old amps that have high plate voltages--6Y6s are rated 200v but can be run up to 300v if care is taken and the screen is controlled. And always be careful of overloading the heater windings in the power transformer with tubes that consume more heater power than real 6V6s. If in doubt, and you insist on trying 6Y6s, KT61s, etc., be safe and add a filament tranny to run the power tubes. We cannot emphasize this enough.

**Exit**

Its many applications have made the 6V6 one of the longest-lived types ever sold. Even so, its continued manufacture is uncertain. Persistent rumors are that the Kaluga version from Russia (sold by Sovtek/New Sensor) recently went out of production. That would leave only the low-quality Chinese version on the market. If the blues community wants to save this tube, it will have to find a tube factory and encourage the owners (via large sales orders) to tool up for a new 6V6GT. The price is likely to be high, so be pre-

pared to support it. Don't develop sticker shock, or the 6V6 may just slip into history, like so many other tubes.

**References:**

1. **70 Years of Radio Tubes and Valves**, John Stokes (Vestal Press, Vestal, NY, third edition, 1992), pp. 55-63.
2. **Tube Lore**, Ludwell Sibley, Flemington NJ, 1997.
3. **"Beam Power Tubes"**, Schade, O. H., **Proceedings of the IRE**, February 1938.
4. **"Recent Trends in Receiving Tube Design,"** Warner, J. C., Ritter, E. W., and Schmit, D. E., **Proceedings of the IRE**, August 1932.

*Many thanks to Charlie, Steve, John Eckland and Terry Buddingh for checking the facts relating to equipment manufacturers. Also thanks to Kevin O'Connor of London Power for his assistance.*

**Coming in VTV #11**  
**6SN7s, Mid-Priced Vintage**  
**Hi-Fi, Headphone Amp**  
**Project, Richardson/APD**  
**Interview, VTV Line Stage**  
**Project, more!!**

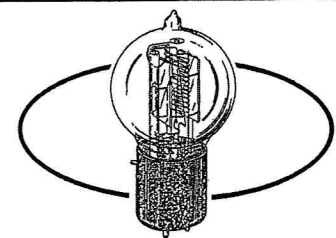

**Tubes**

Call or Fax Don Singerhouse  
**(715) 246-3899**

**SINGERHOUSE**  
**SOUND**  
 PO BOX 321  
 New Richmond, WI 54017

# 6V6 Listening Tests

## Guitar and Hi-Fi Applications

By Charles Kittleson and Terry Buddingh © 1998

### Hi-Fi Amp Listening Tests

For this test we used a common vintage hi-fi amplifier, a 1956 Bell 2122-C ten watt push-pull 6V6 amp that was restored and recapped by John Atwood. We listened to 6V6s in push-pull pairs. Not all samples were listened to because we only had one of some types. The CD player used was a Dynaco CDV-Pro and the loudspeakers were Klipsch Chorus 1s. *Due to time constraints, not all 6V6 types are evaluated in this listening test.*

**Bendix Red Bank 5992** 1950s: Very slow warm-up, but when hot this tube had an extremely detailed sound. The bass was deep and well damped. Highs were extended but not at all harsh. Without a doubt, this was the best sounding hi-fi tube. Rating: 98

**GE 6EY6G** (big plate version) 1950s: This tube has "black plates" and gave a deeper and heavier bass than newer versions of the 6EY6s. However, it still had the same brash sound. Rating: 87

**GE 6EY6** (small plate version) 1950s: A brash, loud tube with a thin sound. This is not a good hi-fi tube. Rating: 85

**GE 6EZ5** 1960s: Thin mids, brash and loud—similar to the 6EY6s. Rating: 85

**GE 6V6G** 1949: This tube had a fat, deep and round bass. The mids were balanced and the highs were sweet. Rating: 94

**GE 6V6GTY** 1970s: This type is still readily available and a solid performer. Highs are slightly harsh, but bass is punchy and deep. Mids are a little glassy, but detailed. A bargain at the present time. Rating: 91

**GEC 2A5306** (British Military) 1953: This tube warmed up very fast, but its bass was recessed and not very strong. However, the sound was tilted towards the highs, which were detailed. Rating: 90

**Mazda** (French military) **6V6GT** 1950s: This tube had powerful and balanced bass. The mids were also nicely balanced and the highs were detailed. This is an excellent tube and a very musical one at that. Rating: 95

**RCA/Cunningham 6V6G** 1930s: Nice detail, great bass and a warm sound. Highs not as extended as some of the oth-

ers, kind of a syrupy sweet sound. Rating: 90

**RCA 6V6G** early 1940s: Vintage 6V6 sound with tight bass, well-balanced mids and highs. Highs were smooth, but not overly extended. Rating: 92

**RCA 6V6GTA** 1950s: Classic 6V6 sound with smooth mids and a mellow, musical sound. Much less harsh than the Sovteks. Well balanced, similar to the Cunninghams, but not as syrupy. Rating: 93

**RCA 6V6** metal 1950s: Harsh, gritty, good bass, "solid state" sound. Not recommended for hi-fi but more for guitar applications. Similar to, but slightly better sound than, Sovteks. Rating: 80

**RCA 7408** 1960s: This bottle had powerful hi-fi sound, aggressive, powerful bass and extended highs. Rating: 96

**RCA 6W6** 1960s: Detailed and nice hi-fi sound. Punchy, but not very deep bass and definitely tilted towards the higher end of the musical spectrum. Rating: 92

**Russian/Sovtek** (Kaluga) **6V6** 1990s: Brash, loud, shouting, emphasized treble, bass OK. Better keep this one as a guitar tube for thrasher rock. Rating: 75

**Sylvania/Silvertone 6V6G** 1930s: This tube was much louder than other "Gs" in the test. Well balanced with good bass, mids and highs. Great example of the 6V6 sound. Rating: 96

**Sylvania 6V6GTY JAN** 1970-80s: Currently available due to government surplus downloads, this tube has a slight upper-tilt, but a nice punchy bass. Sound of this tube is similar to the GE 6V6GTY. The mids are not as rich as the RCAs. Overall, a nice compromise for hi-fi applications at a bargain price. Rating: 91

**Visseaux** (French Military) **6V6GT** 1951: Not as detailed as the 5992 Red Bank, but had good bass and balanced mids and highs. The top end was not as extended as that of some of the other tubes. According to Kevin Deal, a well-known rare tube dealer, people with Mesa Tigris amps thought that the Visseaux was an outstanding performer in their amps. Rating: 93

### Conclusions

The ultimate 6V6 in our hi-fi listening test was the Red Bank 5992. Even though this tube did not have the lowest distortion, it did have an incredibly balanced and detailed sound. The bass was deep and the highs were great. 5992s are relatively scarce, so finding matched pairs or quads may be difficult. A close second is the French-made Mazda 6V6GT with 1950s date codes. Apparently, a large stock of these has become available to tube vendors at sane prices. For those on a budget, the surplus GE or Sylvania JAN 6V6GTs are a much better choice than either the Chinese or Russian types. These tubes are still available at a relative bargain, but I wouldn't wait too long to get your stash.

### Guitar Amp Listening Tests

Our favorite amp for revealing the most microscopic tonal differences is the **Victoria 5C1 Fender Champ** reproduction. Its ultra-minimal circuitry features a single 6SJ7 octal pentode preamp tube driving a single 6V6 with no negative feedback loop. A pair of Fender/Eminence Blue Alnico 10 inch speakers provided extended bandwidth and more volume, detail, and headroom than the stock 8 inch Jensen. Other amps used were a **1952 5C3 Fender Deluxe** (with a pair of octal 6SC7s), a **Victoria 5F3 Fender Deluxe** reproduction (with a 5751, and a 12AX7), and a **1965 Fender Deluxe Reverb**. Our favorite test guitar was a **Fender 1959 reissue Stratocaster** with Van Zant Vintage Plus pickups.

**RCA 6V6 GT:** This is the classic 6V6 for use in vintage Fender amps. It came with or without the graphite coating on the glass and with various suffixes. The sound can vary from batch-to-batch, with the bigger and richer sounding ones generally coming from the '50s and '60s. The gray graphite-coated versions are usually preferred. They have a full and thick lower midrange and deep bass. They're not especially detailed, but are preferred instead for their thick and fudgy mids, and deep bottom that can increase the impression of size in a small amp. Later versions (without the coating) can sound thinner and "stringier," with a more even tonal balance. The sound can vary from batch-to-batch, so be sure to do your own listening tests before buying large quantities. Rating: 93

**RCA 7408:** These look identical to the RCA 6V6 GTs with gray plates and clear glass. They sound smooth, full, and rich—like a good RCA 6V6 should.



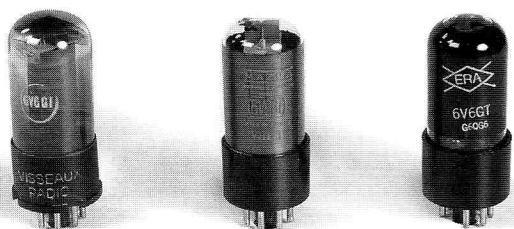

Visseaux 6V6GT (1950s), Mazda 6V6GT (1950s) and Russian 6V6GT (1990s)

Nicely balanced, with a bit less treble extension than some of our more upwardly tilted RCA GT specimens. A top choice for vintage Fenders. Rating: 96

**Sylvania/Philips JAN 6V6GT 1987:** These prevalent top-gettered military-surplus tubes (with clear glass and black-coated plates) exhibit more of an upward tilt than the RCAs. With stringier detail and more grind through the midrange, these tubes exhibit a more aggressive nature. They also have a hint of EL84-like top-end chime. Their brightish upward tilt and ripping mids makes them well-suited for mildly overdriven applications. Rating: 88

**GE JAN 6V6 GT 1983:** These military surplus tubes have less stringy detail and grind than the Sylvania/Philips, with a more mellow, laid-back sound. They're between the RCAs and Sylvania/Philips in tonal balance. They have fuller and stronger mids than the Sylvania/Philips tubes, with less twang and ring on top. They're not quite as thick and fudgy or as deep as the RCAs. They mildly emphasize the mid to low treble range, with a more even balance than the RCAs. The RCAs can sound a bit sluggish and slow in comparison. A good sounding all-around tube. Rating: 90

**Bendix 5992:** This extra-heavy-duty tube was designed for military applications. It's well balanced through the bass and midrange and has a rolled-off top. It's not very lively sounding, with limited dynamics and a rather dead and unresponsive feel. It sounds a bit dull and stiff without much treble chime—it's not very musical. Best for applications emphasizing durability over tone. Rating: 84

**Sylvania JAN 6V6G, VT-107-B:** This ST shaped 1950s era military version has great midrange detail and a sweet grind, combined with a balanced presentation, and complex texture. Very refined and musically pleasant. Its lacey bell-like chime would be best suited for cleaner applications. It doesn't possess the greatest depth; it should be thought of as having more of an "upward tilt." It combines a snappy transient response with crisp

detail. Best suited for tweed era amps requiring increased clarity. Rating: 92

**Canadian Westinghouse/Marconi JAN 6V6G:** Another ST bottle from the 1950s. Very similar to the Sylvania with a bit fuller mids. Not quite as grindy through the midrange and not quite as detailed. The mids are a bit thicker and bolder and a bit smoother and creamier. The Sylvania sound leaner and stringier in comparison. Rating: 90

**GEC 2A5306 (British Military 1953):** (bulk-packed, from Antique Electronics Supply): *With black graphite coating:* Full, rich, deep, and smooth. Nicely detailed and musical upper mids and lower treble, combined with deeply burnished lower mids. Laid-back and friendly, with a warm, full bottom. Can sound quite huge. *With gray graphite coating:* Not as deep and full as the black coated version. More of an upward tilt. Not as detailed and lacey on top. Not as big sounding. Rating: 92 (blk), 90 (gray)

**Russian/Sovtek (Kaluga)6V6:** Current production tubes sound sludgy, lumpy, unrefined, and unmusical, with a harsh and slicey top, and weak bottom. This, combined with poor reliability, makes the Russian 6V6 a poor choice for any music application. Rating: 75

**French Visseaux 6V6 GT 1951:** I was initially reluctant to push these cute little metal-based 1951 tubes very hard. But the bias was rock-solid at 400VDC, so I thought I'd push them hard to see what they could really take. The bias was still rock-solid as high as 465VDC (in a Fender Super Reverb!). I chickened out before they did. These are tough little tubes! They sounded unbelievably good at 450VDC and 30ma—nicely balanced, great detail, strong and punchy midrange, and startling transients. In the 1965 Deluxe (at 425VDC and 30ma) I was impressed with the stout and punchy, forward and aggressive sound of this little tube. It evoked images of a Mullard-EL34-powered Marshall Super Lead 100. Rich, smooth, un-harsh, well balanced, and silky smooth. Full and creamy mids, with a polished stainless steel-like quality to the top. The mids were tighter, punchier, more aggressive, more assertive, and more focused than the RCAs. It's one mean and nasty little tube! Not as big, warm, and juicy as an RCA, and also no match for the RCA's thicker lower mids, fuller bass, and deeper bottom. The RCAs are a warm and friendly, laid-back sound-

ing tube; the Visseauxs are a bit more vicious! A tube with plenty of character for midrange connoisseurs. Cool boxes too! Rating: 94

**Mazda 6V6:** Another recent discovery on the import front. Nice open, chimy sound, with a lacey and glassy top. Not as smooth or balanced over-all as the Visseauxs. Rawer sounding, the mids don't hold together as well as the Visseauxs. Looser, less defined and less articulate. Doesn't have the punchy and forward mids of the Visseauxs, or the deep and full bottom of the RCAs. Superior to the Russian 6V6 which sounded unrefined, trashier, recessed, less focused, grungier, mushier, flatter, and more one dimensional in comparison. The Mazdas are especially suited to those applications requiring an extended top. Rating: 89

**Motorola 6EY6:** This tube was usually used as a vertical deflection amplifier in TV sets. Be warned that it draws .68 amps of filament current, which could be the kiss of death for your already weakened-by-age vintage power transformer. (A 6V6 draws .45 amps of filament current.) Super strong sounding, with chunky mids and a full and powerful sound over-all. More extended top than the Visseauxs, with slicier top-end transients. Huge and impressive, but not as sophisticated and refined, nor as musical sounding, as the Visseauxs. For those seeking a stronger, more powerful sound. Rating: 84

**GE 6EZ5:** Another TV tube with ratings roughly similar to the 6EY6. Except the filament current is even higher at .8 amps. Beware! Not as strong or chunky sounding as the 6EY6. Not as full in the lower mids and bottom. More nasal mids, with an upward tilt. I would recommend the 6EY6 over the 6EZ5 because of its better sound and lower filament current. Rating: 80

### Conclusions

If you guessed by now that I liked the Visseauxs, you're right. My other favorites are the RCAs for their classic thick and creamy mids, and deep bass; the ST bottle Sylvania's for their balanced and detailed presentation with chimy top; and the GEC 2A5306 for their big sound with deeply burnished lower mids, musical upper mids and sweet top. We're fortunate to have so many great sounding 6V6s currently available on the NOS market.

*Thanks to Mark Baier of Victoria Amps, Naperville, IL for letting us use several Victoria amps for this test. Also, thanks to Antique Electronic Supply and John Eckland for supplying several 6V6 samples.*

# The Ultrathath Line Amp

By Jack Elliano © 1998

Even after having been there and done that, I still wonder what I might have missed along the way. Would you believe that some politician back in the early part of this century made a move to shut down the Patent Office? He stated that everything had been invented and that it was just a waste of money to keep it open. History now tells us that he had just invented a new kind of stupidity. What also happened in the early part of the century was the development of the triode and the wonderful things that transpired because of that device. The circuitry has not changed much from when it was in its infancy, nor has the basic arrangement to accomplish amplification.

The "improvements" we have seen for years are mostly of the materials used to build the same devices. Manufacturers sell these improved components to replace the old ones that they sold you when that one was better than the last one. Still, the circuit is the same and the new components are used to sell their latest product. Point being, very little has been done in basic circuitry to improve the quality of amplification. Only the quality of components has improved. It appears that when one changes a tube or component value in a conventional circuit and it works, it gives the inventor the qualifications to write a story about this amazing find and the new sonic relevance. What follows is not a tube change story but a real, new, honest arrangement of components that has not been tried until now.

Many excellent designs have been

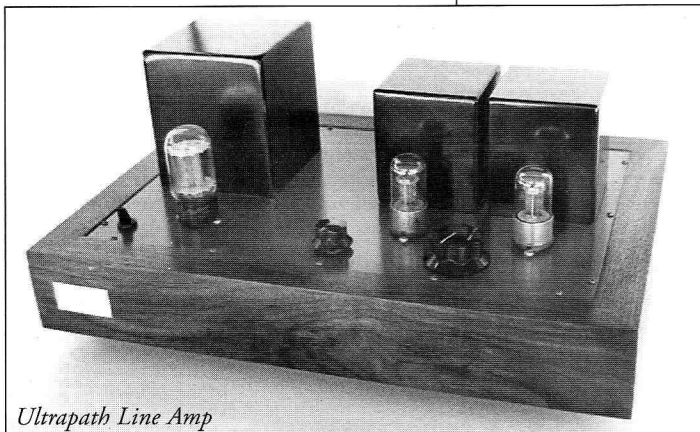

*Ultrathath Line Amp*

shown in Figure 1 (p.12), the "Ultrathath," as the name implies, couples the primary return of the transformer back to the tube cathode through one capacitor. This, of course, can only be done with transformer coupling and not with RC coupled stages. In the case of RC coupling, it is the plate coupling capacitor reacting against the grid resistor of the next stage that conveys the signal. The plate resistor and grid resistor together form an effective plate load with a slight capacitive reactance. There is no return path, only an operating load resistance that the tube likes.

The transformer or inductive load reacts very differently. A tube's load line with an inductive load is not a straight line like a resistor, but rather an ellipse. The ellipse is in motion with the frequency impressed upon the whole inductance. The inductive plate load varies with its reactance to a given variation of current. This whole device must work in a cycle or loop with its varying power source, the tube and power supply.

To further explain the theory of operation, we must know what all components do in the circuit. A triode is a motional resistor whose operating points are set by fixed resistors and voltage values. A transformer is an impedance matching device that can transfer the variation of the motional resistor to the next device in the circuit while isolating the power supply. Actually, the alternating voltages do not go through a capacitor but

around since the 1930s and are still the basic building blocks that we know and love. The "Ultrathath" circuit is a variation of the standard transformer coupled voltage amplifier. As

around its associated circuitry. The power supply needs no explanation. These are very simplistic descriptions and they are not here to insult anyone reading this. Having one of each basic component performing its own electrical function is an interesting concept, especially in audio.

When designing an amplifier with basic components, its circuitry can become simple. No constant current sources or local regulated operating points, and no microchip band-aids. While experimenting with various line output transformer designs it was necessary to build a single tube amplifier stage. A 6J5 was selected due to its popularity and basic geometry. Having consulted with Cy Brennehan, "Triode Proctologist," as to the operating points needed for lowest distortion, a breadboard was built and fired up. As transformers were connected, measured, cussed at (a little-known engineering procedure) and rewound, an idea came to mind as to coupling the source closer to this transformer. In a conventional circuit, the return from the primary of the transformer would pass through the

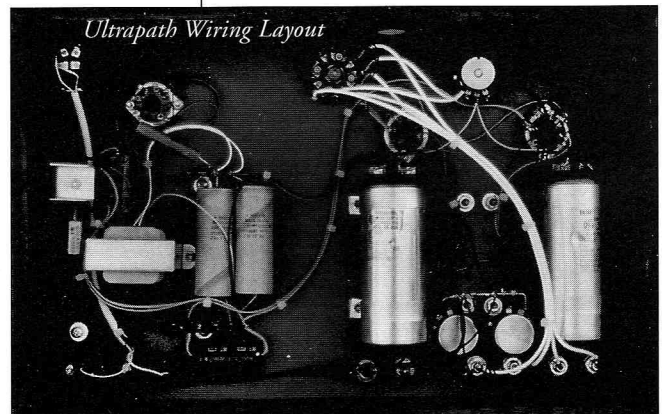

*Ultrathath Wiring Layout*

power supply capacitor, then through the cathode bypass capacitor to the tube. These capacitors are usually electrolytics and would be back to back or negative to negative. This seems strange now but it was the accepted, normal way to do it. Coupling back to the cathode with a capacitor from the end of the primary appeared to be practical, and was tried. Removing the cathode bypass capacitor seemed proper at this point.

Large enough to prevent degeneration, the oil capacitor has equal charge and discharge characteristics. There really is no effective discharge to zero volts but a variation nonetheless, in both directions. Back to back electrolytics in the path would produce various resistances at different frequencies and amplitudes. Making cathode and power supply capaci



Figure 1

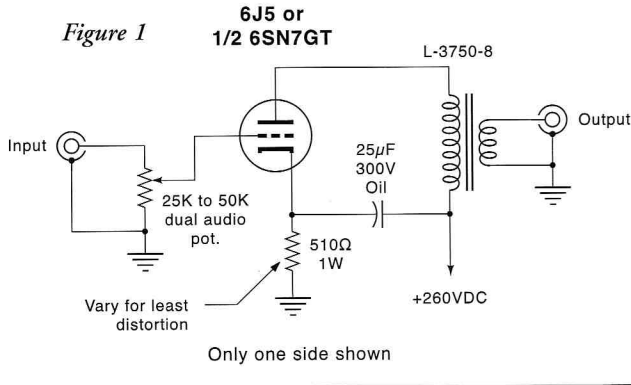

each tube will determine the secondary impedance, that is, a loaded secondary will reflect back to the plate load. This will need to be optimized with each tube type, but as long as it is higher that it needs to be, all should work well with a line output transformer such as the L3750-8. Frequency response will vary only slightly

if the load is around 600 ohms.

tors nonpolarized would help, but with two different values of caps in the path, the angular velocity or rapidity of variations will result in sum-differences in the circle of operation. The sound produced from these component combinations are usually explained away with tautology such as "grainy, veiled, pale, phlegmatic or zingy."

If the Ultrath path circuit was to modify the signal in any way, it would modify the signal less than any other type of circuit. The power supply is connected at the primary B+ end, of course, and is of very little consequence. The 510 ohm resistor was determined with the use of an HP 334A distortion analyzer under 600 ohms load, and with an HP 203A signal generator as the source signal. A 1K pot in the cathode is varied and the dip in distortion is noted, the resistance is measured and a fixed resistor is installed.

For the few that do not wish to use distortion analyzers, just connect it up to your existing system and adjust it for minimum audio signal damage. The cathode resistor will vary from about 150 ohms to 650 ohms or so, with different triodes. Medium- $\mu$  triodes, such as 6SN7, 76, 56, 6C4, 6C5, 12AU7 and the like will work. The plate impedance of

The power supply shown in Figure 2 is different in one way: The relatively large value resistor before the filter circuit. This helps isolate noise from power transformer interwinding capacity to the AC line and to reduce the peak charging current. The filter efficiency is increased and transformer heating is not a problem. The filter and its last capacitor is part of the path for the audio but is not the primary path. The 100uf electrolytic cap is an ample reservoir for power needed at the lowest frequency. The circuit measured out as follows:

- Frequency Response -1db, 23 hz to 43 khz
- Noise Floor -57dbV
- Voltage Gain (600 ohm load) 2.6, or 1 v gives 2.6v output
- THD .26% @ 20khz, .28% @ 2khz, 1.2% @ 24hz

The voltage across the triode should be 250v and the plate current should not exceed 20ma dcv for a 6J5. The cathode resistor adjustment will affect this and must be measured along with the distortion figure. Built as shown, this project should give very good results.

The Ultrath path was built in such a way

as to be scrutinized, hauled, shipped and tested. The first listening test was with the Las Vegas Audiophile Society. The educated ears in this group range from seasoned musicians to soundstage engineers. Armed with their three favorite CDs and a "nothing is better than my stuff" attitude, they sat without saying a word. As each played the CD of their choice, all heard something more in the recording. I, having not noticed anything other than very clean sound, finally heard something that I knew did not exist when I played this piece before. I noticed that the voice was recorded with a slight reverb.

Reconnecting the other conventional linestage, the reverb was only heard because we listened for it. The Ultrath path circuit had revealed the reverb on the voice as it was recorded. Reverb is not a product of harmonic distortion, oscillation or inferior design in a circuit. In other words, it cannot be manufactured within the interior of a conventional amplifier stage.

Reverb is a very interesting effect. It is a superimposed, decaying continuation of a given waveform. Theorizing on why it revealed this type of waveform will also express why the conventional linestage did not. The conventional linestage used the two capacitors as described previously, in the return path. Due to the charge/discharge at two different rates at the same frequency, a nulling out or sum/difference would clean up the dominating waveform. This also can account for other discrepancies or modifications of sound sources in conventional circuit designs.

I have seen high price tags and claims of near perfection with less difference than this circuit demonstrates. The simplicity and performance of this circuit is amazing and we at Electra-Print Audio Company invite you to build this circuit for yourself, if so inclined, and see how great simplicity can be. The output and power transformers and choke are available from Electra-Print Audio Company, but other high quality units should perform equally as well.

Electra-Print Audio Company retains the rights to the "Ultrath" name and the circuit published with this name. The reproduction of this circuit for profit by other than Electra-Print Audio Company is expressly prohibited.

Jack Elliano owns and operates Electra-Print Audio, Las Vegas, Nevada, a premier designer and manufacturer of audio transformers.

Figure 2

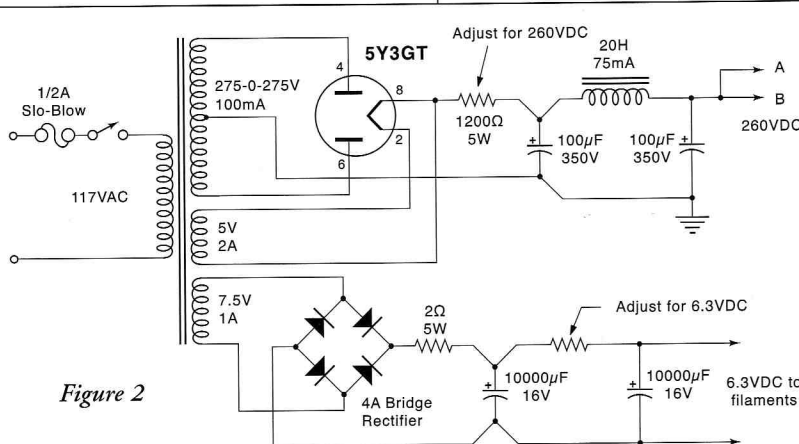

# The Early Days of High Fidelity and McMurdo Silver Corporation

By Norman S. Braithwaite © 1998 All Rights Reserved

The race was on. Through the 1930s, manufacturers of high performance receivers were well aware of the marketing significance and sales potential of realistic reproduction in high performance receivers. Among the large corporations battling for consumer dollars were Philco, RCA, Sparton, Stromberg Carlson, Zenith and others. Among small companies which found a niche meeting this demand for high-performance receivers were Capehart, Lincoln Radio Corporation (not related to Lincoln Walsh), McMurdo Radio Corporation and E.H. Scott Radio Laboratories (not related to the H.H. Scott Corporation). These smaller companies relied upon innovation to keep a market edge. This costly and risky approach was responsible for the success of some and the demise of others.

McMurdo Silver formed the McMurdo Silver Corporation in 1932 after leaving the failing Silver Marshall Corporation, co-founded in 1924 with his cousin John Marshall. McMurdo Silver, having a long-standing desire to build the best and recognizing the potential for success by designing and building receivers of the highest performance and quality, chose to manufacture and market such receivers to the public. This decision was also fueled by the success of the E.H. Scott Radio Laboratories, established manufacturers of high performance receivers (against which the new McMurdo Silver Corporation would directly compete), and E.H. Scott's acquisition of one of Silver Marshall's most valuable employees, their former chief engineer, Earnest Phaff.

In the early 1930s, receivers were distinguished by the range of radio frequencies received, the range of audio frequencies reproduced, audio output power, innovative features and quality of construction. High performance receivers had all-wave reception, good quality audio with about 10 watts of audio power, a bandswitch (instead of plug in coils) and a chassis worthy of showing off. By the mid-1930s, the requirements of a high performance receiver included wide band recep-

tion or an ability to reproduce audio frequencies in excess of the 10-kc separation between broadcast stations (FM was not developed and considered a mark of high performance receivers until the late 1930s), and relatively high output power.

## Masterpiece I

The McMurdo Silver Corporation entered the high performance receiver market with their first receiver, the Masterpiece I. This 13 to 570 meter (530 kHz to 23 MHz) receiver boasted 15 tubes, single dial tuning, 10-kilocycle selectivity, a bandswitch, automatic volume control, automatic noise limiter (squelch circuit), and one stage of RF amplification. 10 watts of audio power were developed from a pair of type 45 triodes operating in Class A2 (grids driven positive) push-pull. The first Masterpiece I receivers were offered in a brushed and lacquered brass finish. During the production of this receiver, the McMurdo Silver Corporation switched to a polished chrome finish and continued to use the polished chrome finish throughout the Masterpiece series of receivers.

The audio bandwidth of the Masterpiece I was on the order of 3 to 4 kilocycles. This was considered good for the time, especially in a receiver designed for 10-kilocycle selectivity (the need for variable or switchable selectivity had not yet been identified). Not many of the Masterpiece I receivers were built and very few are known to exist today.

## Masterpiece II

During the fall of 1933, McMurdo Silver introduced the 10 to 570 meter Masterpiece II receiver. McMurdo Silver claimed this improved model matched every accomplishment of last year's 15-tube model - and more - yet required only 12 tubes. This seemingly impossible task was accomplished in part by use of new multi-function tubes such as a

single type 2A7 oscillator and first detector (pentagrid converter). Bandspread tuning was added and the automatic noise limiter circuit, along with its tube, was removed. 15 watts of audio output were obtained from a pair of the new type 2A3 tubes in Class A push-pull. A single 12-inch die-cast Jensen auditorium speaker was offered for sound reproduction. The receiver could be purchased as a complete chassis set or with any of several console cabinet offerings. This practice of offering optional cabinets was popular among the manufacturers of high performance receivers and continued throughout the period of time during which McMurdo Silver offered the Masterpiece receivers.

Keeping up with the latest advances in the field, McMurdo Silver replaced the type 2A3 output tubes with the new type 2B6 tubes in the middle of the Masterpiece II production. The type 2B6 tube is an internally direct coupled Class A2 output triode (driver triode internally directly coupled to output triode) similar in characteristics to the type 6B5 and 6N6 types. A pair of these tubes developed 17 watts of output power.

McMurdo Silver provided a forerunner of the Masterpiece II receiver, a utilitarian model 5B amateur and commercial receiver, to Admiral Byrd for his second expedition to the Antarctic. Silver publicized Byrd's use of this receiver extensively, even though ad copy stating "Byrd's choice,



Masterpiece II with Carlton Cabinet



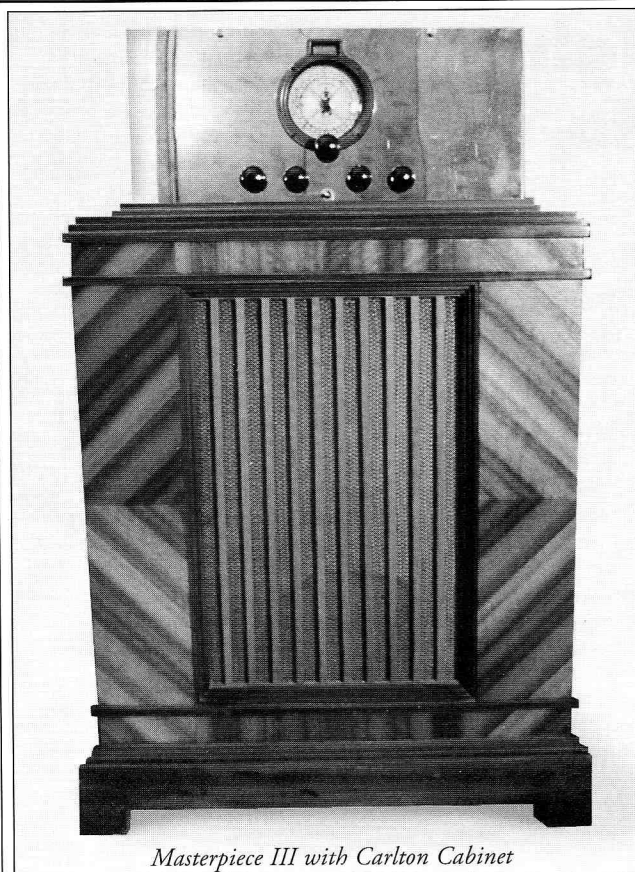

*Masterpiece III with Carlton Cabinet*

why not yours" led the reader to believe that Admiral Byrd selected this receiver. Of the several receivers selected by Admiral Byrd, it is believed one made by National was preferred. I is known that Admiral Byrd and McMurdo Silver were well acquainted and, until provided a better explanation, McMurdo Sound was named after McMurdo Silver.

**Masterpiece III**

In the fall of 1934, McMurdo Silver introduced the Masterpiece III. With the exception of dial cosmetics and the output stage, the Masterpiece III was nearly identical to the previous model. The type 2B6 tubes of the Masterpiece II, which looked so good on paper and in ad copy, were now obsolete (giving it the disgraceful honor of having one of the shortest production runs of any tube in history) and had to be replaced. Although the type 2A3 tube was gaining great acceptance and being used by Silver's competition, switching back to this type tube would make McMurdo Silver's decision to use the type 2B6 tubes appear to be a mistake. McMurdo Silver (once again) chose to use the new type 2A5 power pentodes, in Class AB triode mode, to produce 18 watts of output power. Audio performance of the receiver was described in the owners manual as follows:

"It is seen to be flat to 4db from 40 to 3100 cycles, or so close to absolute perfection as to be perfect even to the most highly trained musician's ear, since it is only 6 dB down at 4000 cycles. This drop is more than compensated for by the 12 dB rise in the speaker itself at 4000 cycles."

Versions of the Masterpiece III were provided to Richard Arlen and Bing Crosby for use in an international DX contest during the month of November 1934. Once again, Silver generated much ad copy from the use of the receivers by Mr. Arlen and Mr. Crosby. Among the claims were that the Masterpiece III smashed all distance reception records. 122 stations from 28 foreign countries were received in one week, all 5000 miles dis-

tant. However, Silver failed to identify whether this was the reception obtained by one or both of the celebrities. Silver further implied that the receiver used by Byrd was the Masterpiece III and denied claims to the contrary in print!

**Masterpiece IV**

Until introduction of the Masterpiece IV, Hallicrafters had manufactured all of the Masterpiece receivers for McMurdo Silver. Starting with the Masterpiece IV, introduced in the fall of 1935, McMurdo Silver contracted with the Howard Radio Corporation for receiver construction. The Masterpiece IV was of a completely new design incorporating 6.3 volt tubes. The new receiver was offered in versions incorporating 14 or 19 tubes, tuned wavelengths from 2150 to 735 meters (140 kHz to 410 kHz) and 565- to 9.4 meters (530 kHz to 31 MHz) and incorporated new features including switchable selectivity, two stages of RF amplification, beat frequency oscillator, separate bass and treble controls and optional audio amplifiers and speakers. The 14 tube version of the receiver contained an audio amplifier section which developed 15 watts of power from a pair of type 42 pentodes operating in push-pull Class AB triode and included a single 12-inch Jensen speaker. The 19 tube version included a push-pull pair of type 42 tubes driving four type 42 tubes operating in push-pull parallel Class A2 triode to develop 60 watts. In addition to the standard 12 inch Jensen speaker, a 5-1/2 inch Jensen tweeter was included with the optional amplifier.

*Masterpiece III Fidelity Curves*

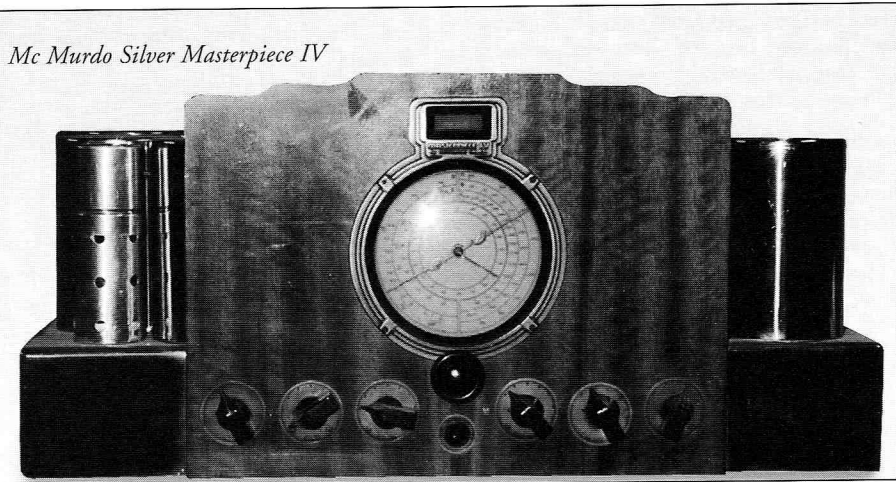
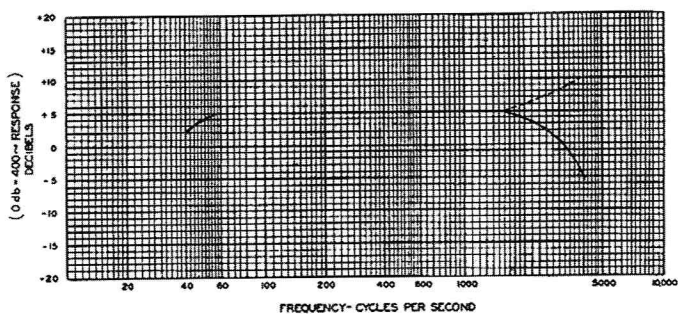

*Mc Murdo Silver Masterpiece IV*



*Mc Murdo Silver Masterpiece V chassis*

Switchable selectivity in the Masterpiece IV allowed the use of narrow bandwidth for good selectivity or wide bandwidth for high fidelity reception, and was accomplished by switching an entire sharply-peaked IF stage in and out of the signal path. This unconventional method of accommodating selectivity options may have been derived from a circuit used in the Lincoln Ultra Deluxe receiver of the previous year.

Competition for the Masterpiece IV included the truly classic Full Range - High Fidelity receiver offered by E.H. Scott Radio Laboratories, the Symphonic by Lincoln Radio Corporation, the Stratosphere by Zenith and other top-of-the-line offerings by Sparton, Stromberg Carlson, RCA and others. The most direct and significant competition was the E.H. Scott receiver. This competing receiver had a 23 tube complement, continuously variable selectivity from 2 to 32 megacycles yielding a maximum audio bandwidth up to 16-kilocycles, 35 watts of output power derived from four single-plate 2A3 triodes operating in Class AB push-pull parallel, and a separate woofer and tweeter. Similar features were offered in some of the competing receivers. All features considered, McMurdo Silver's Masterpiece IV receiver was a little off the front line.

#### Masterpiece V

On schedule in the fall of 1936, McMurdo Silver introduced the Masterpiece V receiver. The new model advertised new features including:

TRF-superhet circuit.

Reception of wavelengths from 2150 meters through 4.3 meters.

Power output of 30-watts undistorted from a pair of type 6L6 tubes.

0.5-millivolt sensitivity to 18-Mc, 5-millivolt sensitivity to 70-Mc.

Quieter operation.

Tonal perfection with theoretically perfect reproduction from 20 to 9000 cycles.

Automatic aural tone compensation (bass compensated volume control).

New metal type tubes, 20 tubes total.

Bandpass selectivity true, rectangular band pass characteristic.

Super giant high fidelity speaker (18-inch Jensen die cast pedestal type with dual cone angle).

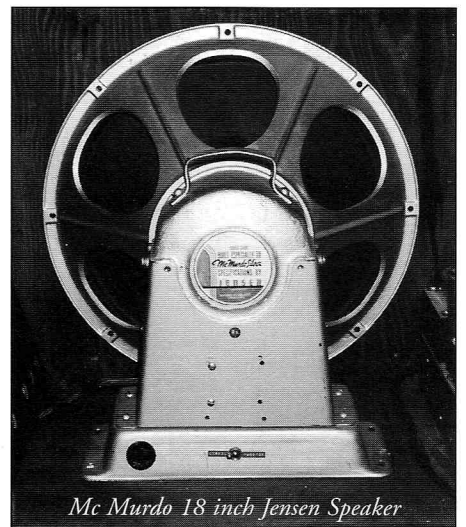

*Mc Murdo 18 inch Jensen Speaker*

Electronic volume range expander.

Large lance dial with knife edge pointer to reduce parallax error.

Bandsread tuning (vernier tuning indicator).

Dual ratio planetary on tuning knob.

Magic eye tuning indicator.

Complete calibrated controls including separate bass and treble.

High fidelity filter (6000-cycle low pass to cut out distortion from overmodulated high fidelity transmitters).

Complete shielding.

Two stages of tuned radio frequency amplification on all bands.

Amplified AVC.

Sealed air trimmers for greater stability.

Beat frequency oscillator.

Among a number of other new features in the list (which became somewhat



*Masterpiece V with Clifton Cabinet*



*Masterpiece V with Bristol Cabinet*



**SIMPLE EXPLANATION OF MASTERPIECE V CIRCUIT**

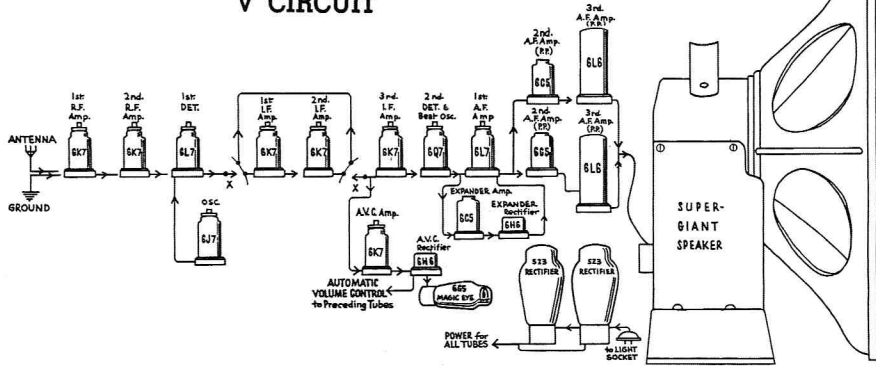

ambiguous and repetitive), was anti-microphonism. Aside from a little boasting (a true rectangular IF bandpass characteristic would have produced a strong audio ringing), the Masterpiece V was a top performing true high fidelity receiver. Intermediate frequency bandwidth was switchable between 8 and 18 kc producing audio bandwidth choices of 4 and 9 kc (nominal). Bandwidth variation was accomplished in the same manner as in the Masterpiece IV, switching entire IF amplification stages into and out of the signal path. In this respect the competitive offering of the E.H. Scott Radio Laboratories, still the Full Range High

sure, giving the Masterpiece V the distinction of being the first home receiver offered with a true high fidelity speaker enclosure. Some Masterpiece V receivers were ordered with a Jensen Q-series horn tweeter (a very rare option). With these speaker configurations, the audio performance of the Masterpiece V was far superior to all competitors.

**Masterpiece VI**

The introduction of the Masterpiece VI during the fall of 1937 evidenced the continuing advances in electronic technology and the ability of the McMurdo Silver Corporation to stay on top. The new model improved upon the Masterpiece V by incorporation of negative feedback, independent AVC on RF as well as IF circuits, addition of more selectivity choices, extension of received frequency to 65 Mc and replacement of the metal tubes with glass types. Bandwidth choices were 4, 8, 12 and 32 kc (audio bandwidth 2, 4, 6 and 16 kc) accomplished in this model by switching entire IF and RF circuits in and out of the signal path. The return to glass tubes was probably

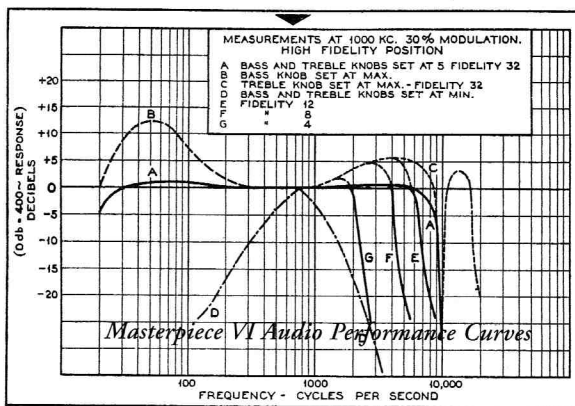

Fidelity Receiver (AKA Allwave 23 or Imperial), with its continuously variable IF selectivity of 2 to 32 kc (1 to 16 kc audio), was a superior performer.

Sound quality of the early Masterpiece V receivers built prior to January 1937 is comparable to that of the Scott Full Range High Fidelity receiver equipped with the optional pair of Jensen 4-inch cone tweeters. Starting in January 1937, McMurdo Silver started packaging the 18-inch Jensen speaker in a bass reflex enclosure,

due to criticism of the new metal tubes and reluctance of other competing manufacturers to use metal tubes. Power output was advertised as 34 watts at 2.5-percent distortion. All cabinets sold with the Masterpiece VI were of the bass reflex type. No competing receivers incorporated true high fidelity speaker enclosures, therefore, the Masterpiece VI continued to lead the industry in audio performance. The increased RF and IF bandpass (to 32 kc) made the Masterpiece VI comparable to the competition in RF and IF perfor-

mance but with less flexibility (not continuously variable). Overall, the Masterpiece VI was most likely the best performing home receiver available for the period of time in which it was offered.

**Orpheon and other models**

In addition to the high performance Masterpiece series of receivers offered, the McMurdo Silver Corporation explored other markets including amateur, commercial and industrial and moderate cost home receivers. A line of amateur receivers known as the 5A, 5B, 5C and 5D Radio Silver were offered from 1934 through 1937. Commercial and institutional equipment included high quality public address systems. Moderate cost home receivers included the World Wide Nine, 15-17 and an unusual late offering known as the Orpheon.

The Orpheon was a home high fidelity receiver designed for local broadcast band reception only. Introduced in the spring of 1938, this 7-tube receiver consisted of a small tuner chassis mounted in a jewelry-chest-style remote cabinet connected by a 25-foot cable to a modest sized console housing the power supply, amplifier and 15-inch speaker. The circuit of this receiver is most unusual in that it consists of a single 6K7 RF amplifier with tuned grid and plate circuits followed by an infinite impedance detector (connected as a cathode follower). The remainder of the circuit is conventional with a 6J7 voltage amplifier, a 6J5 split load phase splitter and a pair of 6L6 tubes in push-pull with negative feedback.

**End of the Line**

Unfortunately the article authored by McMurdo Silver, describing the Orpheon in the July 1938 issue of Radio News, was the last to be seen from McMurdo Silver as the Chief Engineer of the McMurdo Silver Corporation. No Masterpiece VII followed in the fall of 1938 and for that matter, to the knowledge of many collectors of McMurdo Silver receivers, no Orpheon receivers have been found. Although the McMurdo Silver Corporation had succeeded in producing what could reasonably be considered the best sounding AM home receiver of the time (and for some time thereafter), the cost of production could not be supported by a competitive sales cost. Although far more Masterpiece V and VI receivers were sold than the earlier models, the McMurdo Silver Corporation was never able to capture enough of a market to justify the continued production of such a costly receiver. Stiff price competition from other much better known manufac-

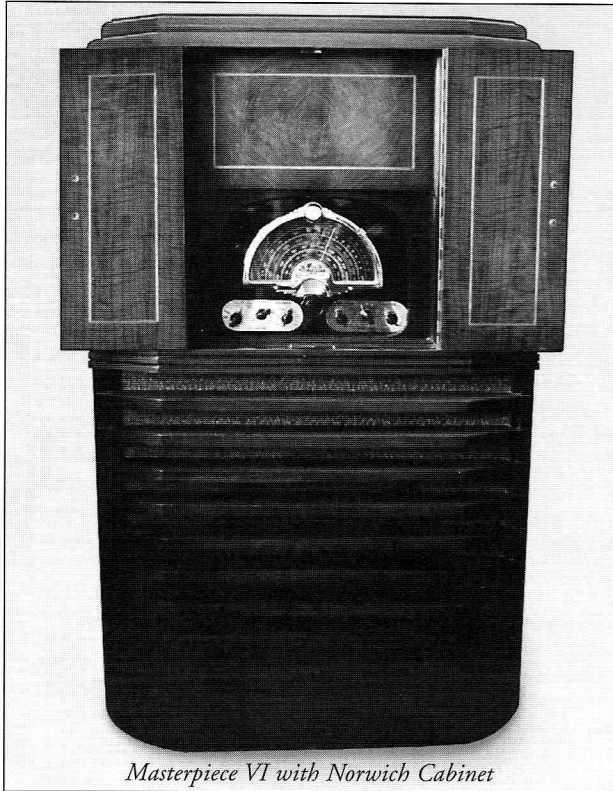

Masterpiece VI with Norwich Cabinet

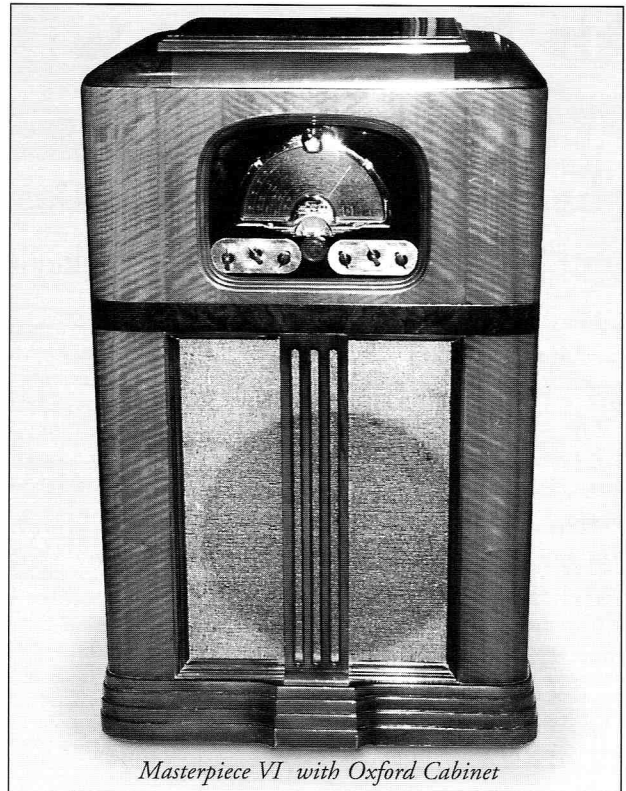

Masterpiece VI with Oxford Cabinet

turers, particularly the E.H. Scott Radio Laboratories, limited the price for which the Masterpiece receivers could be sold. The McMurdo Silver Corporation ceased business in November 1938 and company assets were purchased by McMurdo Silver's greatest competitor, the E.H. Scott Radio Laboratories.

Today the Masterpiece series of receivers are highly sought. The Masterpiece Vs and VIs are the most common of the line but even so, are considered rare. Only one McMurdo Silver receiver turns up for every ten or so E.H. Scott receivers which change hands among collectors. Due to construction practices employed during

manufacture, electrical restoration of the later Masterpiece receivers is very difficult. These receivers can only be aligned using a sweep oscillator and oscilloscope.

Whether restored or not, the Masterpiece receivers, especially the V and VI, are of historical significance and are highly prized by collectors today.

*Norman S. Braithwaite, PE, is a practicing flood control engineer in Northern California. He is an electronics historian and an avid collector of classic radios including E. H. Scott and McMurdo Silver.*

### The Bass Reflex Speaker Enclosure

The bass reflex enclosure used by the McMurdo Silver Corporation was developed in the mid-1930s by Hugh S. Knowles, Chief Engineer of Jensen Radio Manufacturing Company and formerly of McMurdo Silver's engineering staff. Unlike other early attempts at better-sounding speaker enclosures for home receivers, the bass reflex enclosure concentrated on phasing pressure waves emanating from the rear of the speaker cone with those from the front, thereby avoiding the canceling effect encountered with other enclosures. Use of rigid construction materials and soundproofing in the bass reflex enclosure avoided significant cabinet resonances present and even encouraged by other speaker cabinet designs for home receivers. With the exception of the new bass reflex enclosure and large speaker systems used in commercial sound installations, in radio cabinet design, emphasis was placed on simply extending the useful range of the speaker. These range-extending cabinets and their sometimes unusual features were designed to resonate at frequencies below those for which the included speaker was efficient. The effects of the pressure waves emanating from the back side of the speaker cone were not considered.

Masterpiece V Response Curves: Dotted Line = Open Back Speaker- Solid Line = Infinite Baffle

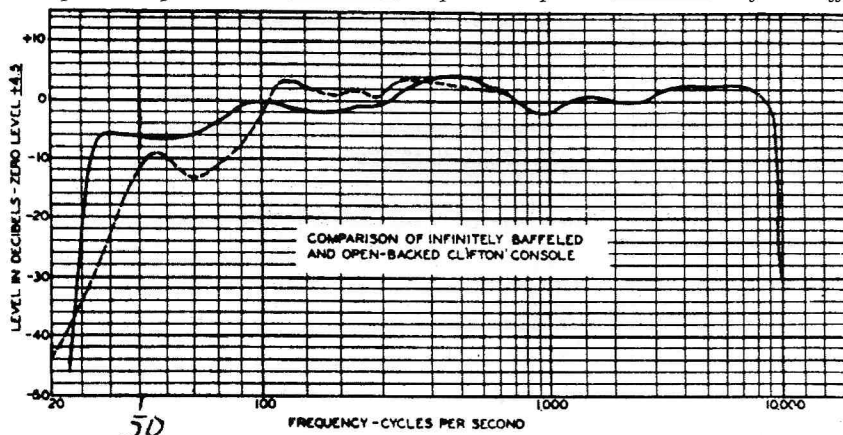



# An Interview with Bruce Moore (Part 2)

**Tube Hi-Fi Pioneer & Audio Designer**

By Charles Kittleson © 1998 All Rights Reserved

*Bruce Moore is a San Jose, California based tube audio designer who has been in the field as a professional since 1975. He was a designer for Audio Illusions, MFA, Paragon, and Precision Fidelity. Several classic amps and preamps were created by Bruce over the years. He now operates his own tube audio company, Bruce Moore Audio Design (BMAD). Part I of this interview was featured in VTV #8, pp 26-29.*

*What about output tubes? Were there any favorite types you preferred?*

Well, most of the amps I built used 6550s. Of course, my favorite is the GENALEX Gold Lion KT88. That tube sounds better, in my opinion, than any of the 6550s. We used the GEs because they were readily available, although personally I prefer the sound of the Tung Sols better than the GEs. I have a private stash of the Tung Sols I used for my own stuff, but they are hard to come by. Now I am using the Svetlana SV6550Cs.

*What about capacitors? How did you go about selecting capacitors and resistors for your circuits?*

You have to listen to them. As far as capacitors go, we really got into identifying the outside foil, and listening to them either way, seeing which we preferred. They do sound different, depending on how you put them in the circuit.

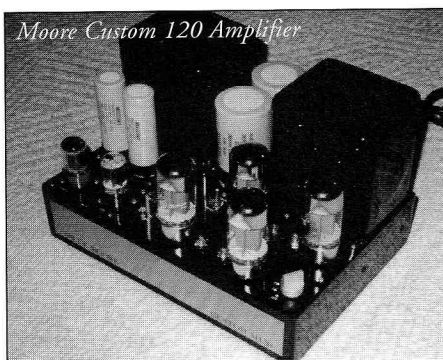

Moore Custom 120 Amplifier

Capacitors used to be marked with a band on one side indicating the outside foil. Now, most caps don't have the band, so you don't know which is the outside foil. If the cap doesn't have a band you can use test equipment to find the outside foil.

*What is the preferable way to wire a coupling cap, from the plate of your driver tube to the grid of your output tube?*

If your outside foil is connected to the plate of the driver tube, using your example, that is what I call the slow way. That is the way I put them in, because I prefer transients are a little slower. Another advantage to this way is that it is fuller sounding. If you put them in the other way, it's a little faster sounding, but it's thinner sounding. And it works the same way for bypass capacitors and power supplies. I'm sure it does the same thing.

*Did you have any specific brand of capacitors? Back in the 1970s, there weren't as many choices of gourmet capacitors.*

Well, back in the mid-70s, we didn't really know the difference between capacitors. We used the ElectroCubes, just the straight Mylars. I also used Vitamin Qs because they were available at electronics surplus stores. Vitamin Qs, however, give a soft and sometimes smeared sound.

*What kind of capacitors are you using in the signal path of your new designs?*

I use Rel-Cap polystyrenes.

*Any preference in resistors?*

Well, I like the Rodersteins, and I also use the Bradfords, which are made in the United States; they are little blue resistors, a metal-film type. I used the Beyschlag metal films in the Audible Illusions stuff. They were nice sounding in tube equipment, but are no longer available.

*What do you think of Allen-Bradley resistors?*

They have a full, but smeared sound. The Holco resistors are kind of pinched

and nasal sounding to my ears. They sound like MIT capacitors, or very similar.

*What about electrolytics, have you played around with anything with the sound of those?*

I use the Aero-M Electrolytics. Although I remember that at MFA we used Sprague electrolytics, and they sounded kind of gray and I think the CDE ones were very similar.

*How about wire?*

There is kind of a funny story, but at MFA, we used to wire the Luminescence with 18-gauge Radio Shack hook-up wire. It was pure copper wire, and it sounded pretty good. Later, we switched over to Mogami wire. At MFA, we started using Cardas, which is a litz wire, in some critical applications in the preamps back in the 1980s.

*Any thoughts about the sounds of silver wire? I'm talking inside the box, not outside, not interconnects.*

Silver wire has a little more detailing to the sound; it's also a brighter sound. A lot of people like that, though. A lot of audiophiles like high detail and high resolution

*Let's talk about the legendary MFA Luminescence preamp. Did you use a 7591 in that circuit?*

Yes. That was in the power supply. Scott Frankland designed the power supply for first Luminescence. In the first ones, we used FETs, the International Rectifier FETs. Eventually we migrated into using vacuum tube regulators. Tubes seemed to be the best compromise, as far as the power supplies affecting the sound, which they do, of course. The early Luminescence used the 6L6 as a pass tube, the 6EJ7 as the gain tube, or the correction tube, whatever you want to call it. And later Luminescences, we split it off to do a dual mono-configuration, they used the smaller 7591s as a pass... because, you know you divide the current in half when you split up the left and right channel.

*Have you experimented with or did you use the newer fast-recovery diodes, usually called HEXFREDS?*

I know what you are talking about. No, I've never played with those. The high-voltage ones are expensive. But I've always found that if you put a ceramic disk capacitor across the solid-state diode,



*MFA Magus Preamplifier (1980s)*

it seems to improve the sound a little bit. There is a slight graininess to the upper mid-range that you seem to get with the solid-state diodes.

*So what were some of the other products that you came up with?*

Well, to finish up with Luminescence, I should mention that we did build a switching power supply at one point early in the development of the preamp, and we tried it. Scott felt that it had a lot of promise, but I thought it was just too dry sounding. I personally am really sensitive to that area in electronics. I don't like dry sounding stuff. I don't like stuff that sounds thin or bright or doesn't have any body. I like all the usual tube quality, the spaciousness, the air, the dimensionality, the depth, the frequency extension...

*There are some people who think that the Luminescence preamp was the ultimate preamp made.*

Well, there was a big battle going on in the mid-1980s, the late-80s, I guess, with the CAT and the Luminescence. It was, like, which one was the best and everybody had their own little camp. Some people liked the CAT and some liked the Luminescence better.

*In its final version, is the Luminescence still being made?*

No. In 1989, Peter Evans bought the company from Scott and I and hired us as employees in 1990. The company moved to a much larger location in Santa Clara, California and ended up having 13 employees. They were inexperienced women who they tried to teach how to hand-wire this stuff and it was just a nightmare. They spent six months training them with virtually no production from the women. There was a lot of overhead spent for nothing.

Bill Jones of Aptos, California used to hand-build the Luminescence preamps, and he did a fine job. He is an excellent wiring guy, I have never seen anybody who can wire quite as good as Bill.

What happened after that--Peter Evans had decided that he wanted to do cost-no-object preamp design, and they were going to call it the MC-Reference.

*What did MC stand for?*

Moving coil. Very high gain, very low noise. Now, I don't know what went on in 1991, because Scott was still with the company full time at that point and there must have been some kind of--maybe some rivalry between the two as to who was going to have the upper hand in actually implementing this preamp. Since I wasn't with the company after that point, I don't really know what went on, but to make a point here, they did come out with the MC Reference finally. Arn Roatcap did the mechanical design and all the PC board layouts for it. I think they only built about 20 units. It was a very expensive project and a very refined design.

*What was the price of the MC Reference?*

\$13,500, this was a cost-no-object pre amp. They used the very best of everything. And because it was made in small quantities, it was very expensive. You know, you have to give an overseas distributor half off the U. S. retail and they were paying \$1,000 apiece to build them and parts cost was close to \$3500.

*Did you design the MFA Magis preamp?*

Yeah, I did that. That was both Scott's and my idea, to come out with an affordable high-gain preamp that you could use with a medium output moving coil straight in. So that ended up being a four-tube circuit and it was a volume seller for MFA. It was on a circuit board from year one. And it did quite well. There were a couple of reiterations through the years and stuff, but it ended up--I think it sold for \$895 back when it was introduced and a couple of years later, they raised it to \$1200 and \$1500. They just priced themselves out of the market at that time and so they just stopped building it.

*Let's talk about some of the MFA power amps.*

At MFA, we had the M-120, the M-200, and the Dual-75. But previous to those, Scott and I built something called an M150, which was in a completely enclosed case with gold and aluminum rack handles, and those used transformers

from an amp called an Ampex A120, which was a theater amplifier. What we would do is drive around the Bay Area finding these discarded theater amps and we would strip the transformers off. The original Ampex amp used four 807s in the output stage. We went up to Berkeley once to pick up four of those amps. We were in a little red BMW. Four of those things in the trunk of the car really bottomed out the suspension

*Did you build amps using Citation II output transformers?*

The Citation II had a really unique transformer. I liked it. It's got, like, a 3200 or 3500 ohm plate to plate winding, which does two things for you. You can use it with two 6550s or you can use it with four. It's the same size physically as a Dyna Mark III with a 2-1/2" lamination stack, which will actually work. It will actually put out 120 watts down to 18 cycles, if you have four output tubes. You need about a 535-volt rail to do that, so what we used to do is we put a transformer underneath the chassis that would boost the high-voltage winding on the Citation power transformer to get it up from 465 to 540 volts, or thereabouts. The amp had an octal base, cross-coupled front-end circuit and a pair of Gold Lion KT88s, 560 volts on the plate, ultra-linear connected, put out 100 watts, with a Citation transformer, two output tubes. It was really a unique piece.

*Was that a one-of-a-kind?*

Yeah. I made it and a bunch of custom pieces that I built in 1986. They all ended up in Hawaii with our dealer there to do a promotion thing.

*Did you make any crossovers at MFA?*

We made some custom cross-overs with octal tubes, for specific customers. We also had a little product which was a solid-state cross-over, which had a couple of op-amps in it. They were used for sub-woofers and had a passive top end. Some of them used solid-state for the bottom and active tube circuitry for the top.

*Tell us a little bit about what you do now.*

Well, the first thing I started out with is a low-profile two-tube line-stage preamp, and it is called the BMAD (Bruce Moore Audio Design) Companion. It's on two circuit boards and I've been selling it since early 1992. And I've revised it just about a year ago and its current form is called the Series II. I've sold a lot of those overseas.



*What is the circuit topology?*

It's real simple. It's a series shunt feedback circuit with a 6922 and it has a cathode follower in the power supply which feeds the tube itself. It's kind of like a voltage stabilizer. It uses an RC network on the grid of the follower tube and the cathode goes through another RC network, which gives B+ voltage to the actual audio amplifier itself.

*So it's tube regulation?*

It's not regulation. It's voltage stabilization. Because it's got a long-time constant in the grid, it doesn't change over for quick changes in AC line voltage. It remains stable. If you put it on the VARI-AC and turned the AC down to 90 volts, the B+ would slowly drop down and it would finally settle. The same thing if you turned it up past the 120 volts, it would slowly rise up. But for quick changes, like for line dropouts and stuff, it holds the voltage stable so you don't have pulses or anything coming through the system.

*Is this design used by other manufacturers?*

No, as far as I know, it isn't. I've kind of made it a mainstay of all my products. I use it in the first stage of all my power amplifiers and in all my preamps. I make a deluxe line-stage preamp that uses one of those for every stage. It's a de-coupler, also. It isolates the stages from one another. And the thing about it that I really like is that it has no sound of its own. With tube regulators, you always hear the sound of that voltage error correction tube. Whenever you put in a Holland

Amperex, you hear a difference in the sound, because of that tube. We had problems with that at MFA--finding good-sounding tubes in the Luminescence. There is one that Scott really liked the sound of, but it was hard to get. So anyway, doing what I do now without the error correction tube, the simple cathode follower, it has no sound of its own. You can put any tube in that position, any brand, as long as it's working properly, it doesn't change the sound one iota. So from that standpoint, I'm real happy with what it does.

*Do you make a more elaborate preamp?*

It's a duo-mono line-stage preamp, also, that uses stepped attenuators. It's a two-stage circuit with some feedback. It has a very wide frequency response. Coincidentally, I don't use cathode followers. I got tired of them. Back in the 1980s even. An interesting story there. I had dinner with Stu Hegeman, who designed the Citation stuff in the 1960s. In 1982 I met him in Chicago and asked him, I said, "You know I notice you didn't use cathode followers in your Citation designs. Why is that?" He looked me straight in the eye and he says, "Because they don't sound good." You know. And it got me to thinking. Every time I used the cathode follower, it kind of sounds a little bit thinner. It adds a thinness to the mid-range. And I think that was what he was talking about. Although in the Luminescence, with those big beefy dissimilar triodes, it sorta wasn't a problem. The octal triodes have a fuller sound than the nine-pin miniatures, to some extent anyway.

I am building a 70-watt stereo amplifier with 6922 and 6550s and also make an amplifier called the M125, which is a mono-block, and the M225, which is 225 watts, also a mono-block. I use that stabilizer in the first stage and also, as of about a year ago, I've been using a new type of phase inverter circuit that I've developed called the "T" inverter. It's all direct coupled. I do level shifting. Extremely wide frequency response. And it sounds better than the long-tail pair that I used to highly regard as a driver circuit. It sounds cleaner and clearer, without sounding brighter.

*Where are you selling your products now?*

Well, actually, it's mostly in Italy and Hong Kong. They've been keeping me going. I don't really have anything much at all so far as U. S. dealers are concerned. Never really tried to find any, because what happens is I'll build a run or something and either Italy or Hong Kong will buy virtually everything I build. So I've got nothing left to sell in the United States. But that's going to change, starting later on this year.

*What are some of the prices on your equipment?*

The Duo-70 is \$3800 retail and the M125s are \$6600/pair retail. The 225 mono block, 225 watts per channel are \$9300/pair. The Companion is \$1550 retail. \$2100 with step attenuators, retail. And the Deluxe Duo-Mono preamp with a line-stage only is \$5500 retail, with step attenuators. It has a remote power supply, by the way. The new Companion III is a five tube circuit with shunt-stepped attenuators and sells for \$2400 retail.

*What do you see as trends that are developing in the recent resurgence of vacuum tubes in audio?*

Well, one of the main trends is pretty obvious--single-ended triodes. I know that was really the way the Japanese were doing it for years before it caught on over here and you see a lot of that when you go to the shows. Lots of low-power expensive single-ended triode amplifiers, and I'm not familiar with the speakers that they are using. I don't know if they have anything that's really good sounding.

*What do you see happening in tube audio during next five years?*

I certainly hope it grows. It's good for everybody if it grows.

*So what do you use for your driver stage?*

I use 6922s and 5687s. I've always wanted to try that 6900 tube for years, but I've never been able to find any. I think it is a computer tube. I saw somebody had it listed for \$70 as a wholesale. It was a Bendix.

*Tell us a little bit about your latest amplifiers.*

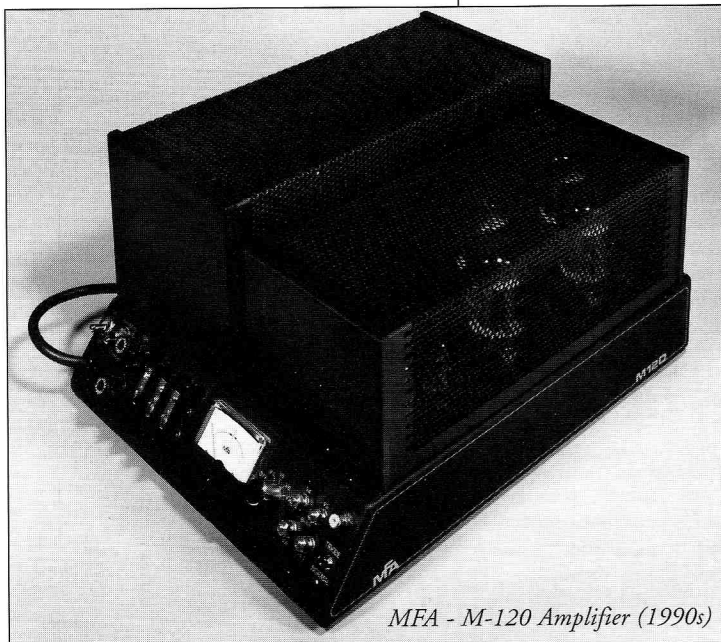

MFA - M-120 Amplifier (1990s)

## Uncle Eric's Tube Dumpster

The 6AV5 - A Small Sweep Tube

By Eric Barbour  
© 1998

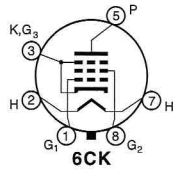

The Dumpster has talked about a lot of assorted preamp tubes up to this point. This time, we need to mention a beam-power tetrode that gets no respect, even though it seems perfect for hi-fi use.

Believed to have been introduced in 1949 by GE, the 6AV5 was a TV horizontal-driver, or "sweep" tube, intended for smaller black-and-white TV sets. Unlike almost all other sweep types, the 6AV5 has no plate cap. Why? The whole reason for a plate cap was to allow high peak plate voltages. In the flyback section of a TV, the driver needs to put plenty of current into a low-impedance primary winding; yet the secondary produces thousands or tens of thousands of volts (for the CRT accelerating anode). Some of that voltage would spike on the plate of the tube during each cycle.

It's one of the dirty little secrets of the tube world: most power tubes can handle VERY high plate voltages. The issue is not the tube's plate; the issue is leakage currents around the base pins and socket. So, you either use a plate cap, or you isolate the plate pin on the base, so there are no sensitive grids on adjacent pins. That's what the 6AV5 did. Pin 5 is the plate, pins 4 and 6 are unused. And the control grid is on pin 1 and screen grid on pin 8, well away from the plate. Otherwise the 6AV5 was very much like the more ordinary 6BQ6 sweep tube.

There was a small family of "single-ended octal" sweep tubes, including the

GE 6AU5GT, RCA 6AU5GT and RCA 6AU5GT (later type)

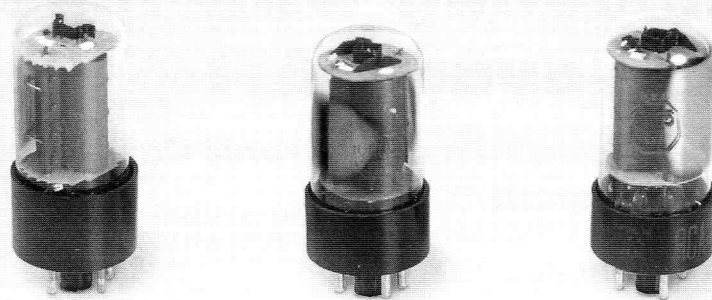

Bogen DB-130 35 watt Integrated Amplifier (1957)

6AU5, 6BD5, 6FW5, and some heater-voltage variants. A few such tubes were also made with novar and duodecar Compactron bases. None were as successful as capped sweep types. Yet all can be run with 3000 volts peak or more on their plates. 6AV5s can handle 5500 volts peak. One could conceivably run a pair of them on 2750 volts in Class B. (Not recommended except for the very brave—the official DC plate rating is 550v.)

The only major audio application for the 6AV5 was in Bogen's late-1950s PA and pro-audio line amps. Some of these amps ran the tubes in Class B on 700v plate supplies. The only hi-fi amp to use the 6AV5 was the Bogen DB130A (1958),

which got 35 watts from two 6AV5GAs. The 6AV5 was also used in the driver stage of the famous McIntosh MI-200 amplifier.

There were two versions, the GA and GT, with the GA being much larger and rated slightly differently. The reason for the two versions is obscure—possibly the larger envelope improved radiation cooling. Also, series-string versions were made for 600 mA (12AV5), 450 mA (17AV5), and 300 mA (25AV5).

Although there were other members of this family, we are singling out the 6AV5 because it is abundant in Philips/Sylvania military surplus form. That and its unique characteristics (and low distortion compared to 6L6 types) make it worth looking at for audio use. It will work very well in almost any 6V6 or 6L6 design. The output transformers made for 6L6s are a good match for the 6AV5. So long as the plate dissipation is kept somewhere near the 12-watt limit and the screen voltage is kept within its 175-volt rating, it is capable of fine music. (*The 6AV5 and its relatives also make good voltage regulator pass tubes.*-Tech. Ed.)

*Thanks to John Eckland for his help with historical details.*

GE (marked Tung-Sol) 6AV5GT, GE (marked Tung-Sol) 6AV5GA and RCA 6AV5GA

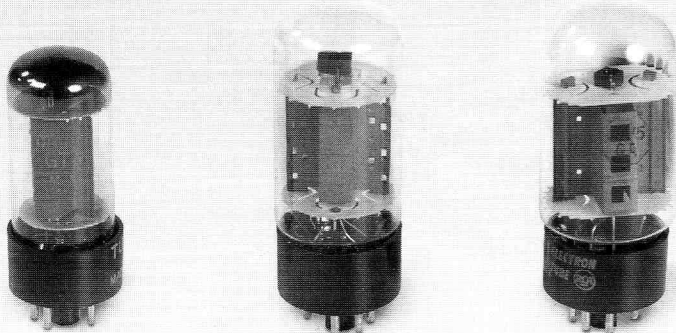



# Computing with Tubes: The Savage Art

## 4. The World's First Electronic Calculator- Tube Powered!

By Bruce Flamm, MD © 1998 All Rights Reserved

### Introduction

As we approach the year 2000, technology is expanding at an exponential pace. Several million transistors have been crammed onto a single microchip. Today a pocket-sized calculator with advanced scientific functions can be bought for a few dollars at any discount store. With this in mind, it's hard to believe that 30 years ago, electro-mechanical machines, using gears and levers to calculate, noisily clanked away in offices and laboratories all over the world. In fact, no electronic calculator of any type was available before the early 1960s. Yes, vacuum tube computers such as the ENIAC were developed during the mid 1940s, but anyone who has seen the massive components on display at the Smithsonian Institution understands that these box-car size machines were hardly suitable for home or office use.

The race to develop a four-function desk-top electronic calculator actually started in 1956. In that fateful year, engineers in England set out to build a desk-top sized calculator that would use no mechanical parts. Their work at the Bell Punch Company, Ltd, culminated in 1962 with the release of the world's first electronic calculator, the Anita. The name "Anita" was apparently derived from the phrase, "A New Inspiration to Arithmetic." The earliest version of the Anita that can be found from a review of the 1960s electronics and office machine literature is the Anita Mark VIII. The Anita Mark IX, a slightly modified version of the model VIII, was released about a year later. If earlier versions were ever developed, they may have been prototypes that were never sold.

The Anita weighed a hefty 33 pounds and used large "Nixie" tubes to display

results. Dozens of other tubes were used to actually perform calculations. If such a calculator sounds a bit ridiculous today, recall that this was 1962.

England's Anita was indeed revolutionary and had the potential to conquer the world's huge electro-mechanical calculator industry and force large companies like Friden, SCM-Marchant and Monroe completely out of business. But falling transistor prices would prevent Anita from doing so. By the late 1960s all-transistor (solid-state) calculators would make electro-mechanical calculators and the magnificent "tube calculator" obsolete.

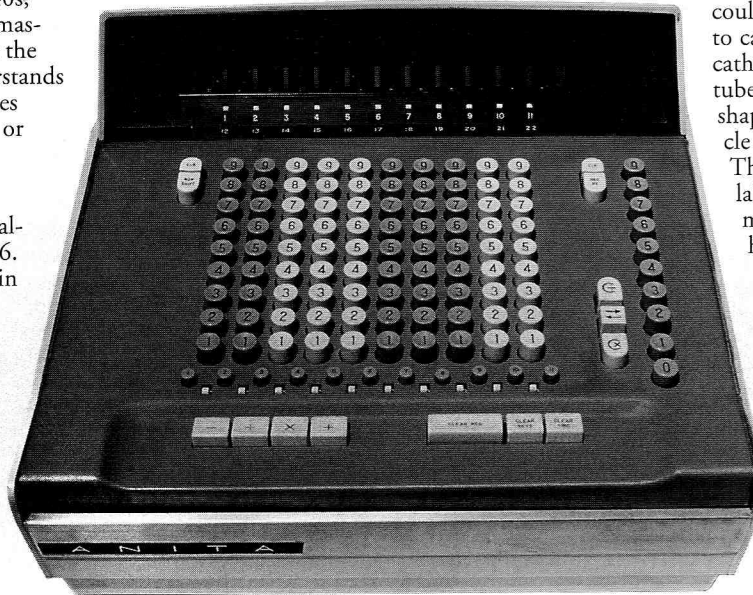

### Calculating and Displaying Results with Tubes

The Anita uses tubes in the pulse generator, the sequencing system, the accumulator and the display. It is truly a "tube" calculator. Overall, some 150 tubes are used in the Anita. Electronic tubes were called "valves" in England because they controlled the flow of electricity in much

the same way mechanical valves controlled the flow of water. In addition to typical vacuum tubes, the Anita made use of large numbers of gas-filled "cold-cathode" tubes. In these tubes, a fairly low voltage causes a glow to appear about one millimeter from the cathode. In contrast, a neon sign uses a high voltage to excite a bright glow discharge near the anode.

Perhaps the most common example of a cold-cathode tube is the "multicathode alphanumeric display tube" commonly called a "Nixie" tube. It was apparently also called a "Hivac Numicator" in England. The numeric display tube typically has 10 cathodes, each stamped like a number from 0 to 9 stacked one behind the other. The cathodes are not actually stacked in numeric order, but rather in a way that allows for optimum visualization of a given digit when illuminated. The stacking sequence used in the Anita's numeric display tubes was 1029384756. The Anita uses 14 such tubes to display results.

In addition to its original use as an alphanumeric display device, the cold cathode tube was later modified into a "stepping tube" or "dekatron" in which a visible glow discharge could be translated from cathode to cathode around a ring of cathodes. The typical stepping tube has thirty identical rod-shaped cathodes spaced in a circle around a central anode. The Anita's "stepping tube" is labeled GS 10D and was made in England. This tube has a large "ring" of cathodes projecting to the flat top end.

The Anita uses literally dozens of "subminiature" tubes as "logic" elements. Most appear to be variations of the Mullard Z700U gas tetrode. These tubes are labeled "Holland" and were apparently made by Philips. A few miniature tubes are labeled T E C 41 A. (The Z700U is not

much larger than a paper clip, measuring only 10 x 25 mm.)

Anita also used more conventional vacuum tubes or "valves." Eight such tubes are located under the back cover and several others surround the "stepping" tube. In addition to the rows of subminiature tubes, clearly visible in the photographs, there are another 70 subminiature tubes

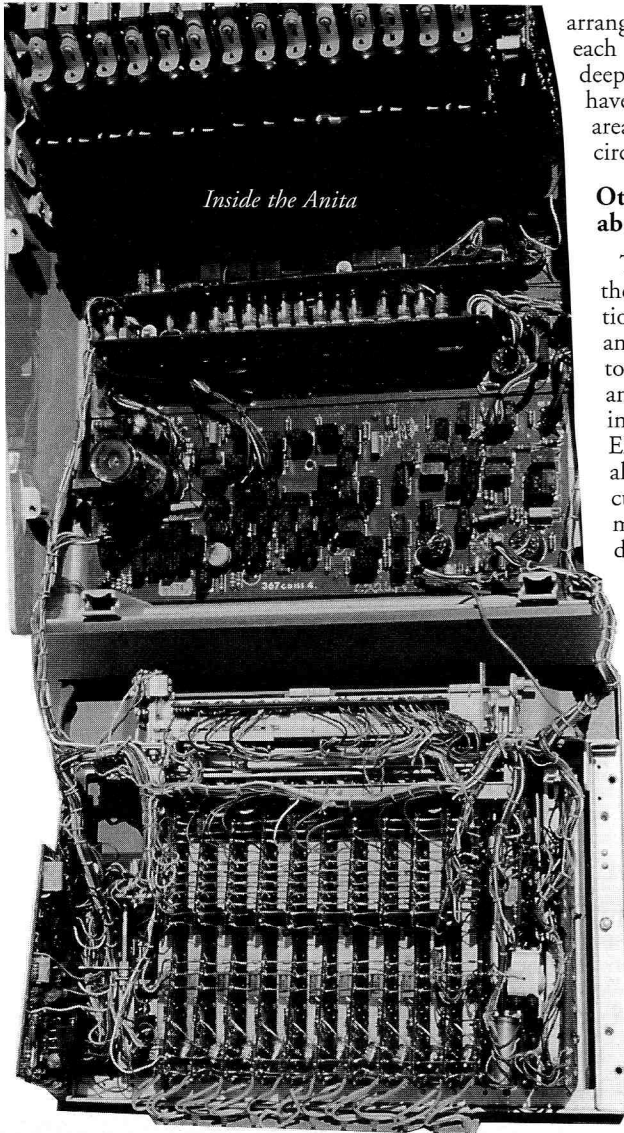

*Inside the Anita*

arranged in 5 rows of 14 tubes each on circuit boards buried deeply in the calculator. I have not ventured into this area for fear of damaging the circuit boards.

**Other Interesting Facts about Anita**

The case or enclosure of the Anita was also revolutionary. In the late 1950s and early 1960s, all calculators were electro-mechanical and were generally built into sturdy metal cases. Electrical shorts were generally not a problem since current only flowed to the motor, to drive the hundreds of gears and levers that performed the calculations. In contrast, the Anita would incorporate hundreds of tubes and other electronic components. A new type of case was fabricated by GEC Engineering Limited in Erith, UK. The casing was built up from 13 different molded parts weighing from 0.13 to 50.0 ounces. The material used was Cylolac T, an ABS plastic.

Numbers were entered into the Anita via 90 data keys, each operating a switch. This arrangement of 10

columns of 9 digits was called a "full keyboard." It was typical of the electro-mechanical calculators of that era and was probably used because it would not require retraining of people accustomed to the mechanical machines. Pressing a numeric key in a given column would cause that number to appear on the Nixie tube directly above it. Below the data entry keys, another row of buttons was used to enter decimal points. To the right of the machine is another column of keys not associated with any Nixie tube. This is the multiplier line and is used in multiplication to enter the second factor while the first factor is retained on the main keyboard. Interestingly, the Anita is the only known electronic calculator that incorporates a full keyboard. Even the early CRT-display calculators of the mid-to-late 1960s used the more modern 10-key design for data entry.

The ultimate fate of the Anita tube calculator was presaged by one of its developers in a paper presented in March 1964 at the University of Cambridge: "Unless more development and, indeed fundamental research is carried out into the field of gas tube applications, the users of these components will have few, if any, weapons with which to fight the onslaught of the healthy dollar-fed baby known as the 'transistor.'"

*The author of this article, Bruce Flamm, MD, FACOG, is a practicing physician specializing in Obstetrics and Gynecology at Kaiser Medical Center in Riverside, California. Bruce is also a co-founder of the International Association of Calculator Collectors.*

**References:**

1. **Computing With Tubes - The Savage Art**, Eric Barbour, Vacuum Tube Valley, #7, 1997.
2. **The World's First Electronic Calculator - Who made it?**, Bruce Flamm, The Journal of the International Association of Calculator Collectors, #14, 1996.
3. **The Cold-Cathode Tube**, M. A. MacDougall, Electronics, March 22, 1965.
4. **Using the cold-cathode tube to count and store**, Graham Jeynes, Electronics, April 19, 1965.
5. **Cold Cathode trigger and counter tubes for computing applications**, N. Kitz, Symposium on cold cathode tubes and their applications, University of Cambridge, March 1964.

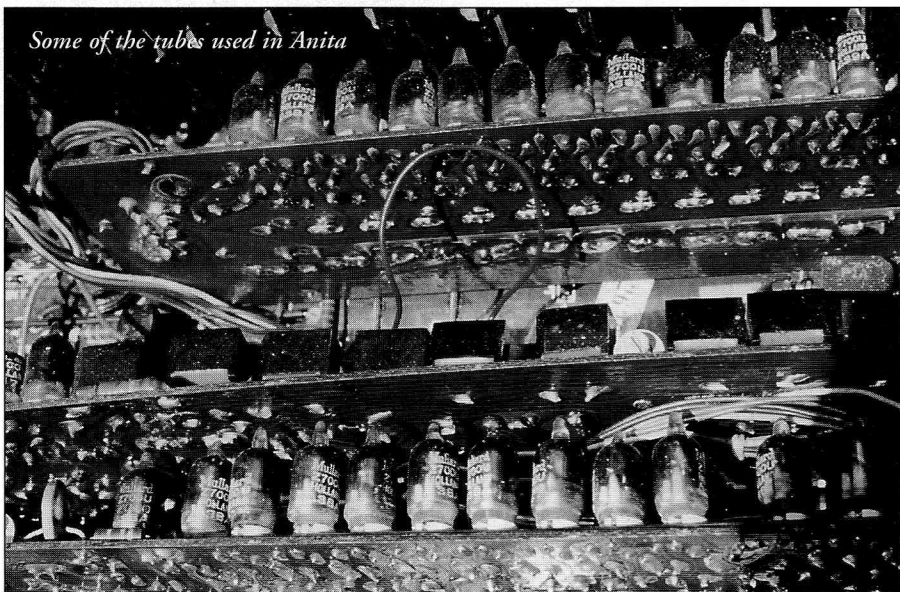

*Some of the tubes used in Anita*



# Maxi-Matcher Digital Tube Tester

## VTV Product Review

By Charles Kittleson © 1998 All Rights Reserved

How many times have you said "I wish someone would come out with a convenient way to match audio power tubes?" Trying to get the best performance out of push-pull hi-fi and guitar amps requires closely matched power tubes. Most tube vendors sell "matched" pairs and quads of power tubes for an extra fee and charge even more if they are "gold" or even "titanium" matched. Past experience and testing has demonstrated that a significant number of "matched" power tubes vary in transconductance and plate current by up to 25%. To make matters worse, tube vendor testing and matching methods are typically proprietary and not available upon inquiry. I would bet that there are as many matching methods as there are tube vendors.

After attending a recent audio show, I stopped by a display booth exhibiting a small black box that didn't look like an amp. Upon closer inspection, I saw that this "box" was actually a new piece of test gear from Maxi-Test Company of Seattle, Washington, especially designed for tube sellers and users. The Maxi-Matcher can instantly identify weak tubes, measure tubes for amplifying capability, and precision match up to four octal power tubes for plate current and/or transconductance.

In the standard model you can match the following types: 6L6, 5881, EL34, 6V6, 6550, 7581, KT77, KT66, KT88, KT90, KT100 and 7027A. In addition, Maxi-Test is developing an adaptor for nine-pin miniature dual triodes (12AU7, 12AX7, etc.) that will allow for noise and balance testing of these types. Other options planned for the future include a special regulated power supply and other useful tools for the tube trade.

Maxi-Matcher has a 3.5-digit LED display to match tubes within + or - 1.5%. Plate voltages are selectable for either 325 or 400 volts, depending on your tube type. Bias voltages are selectable for -60, -48, -36, -24 or -16 volts. The 6.3 filament voltage is rated for a maximum of 6 amps, which should be adequate for up to four 6550A tubes. In addition, the device has a separate socket for short circuit testing of tubes with LED indicators. There is a "smart" power supply that resets the circuit automatically and protects the unit from shorted tubes.

Controls include: On/Off Switch, Plate Voltage On/Off, Bias Voltage Selector, Function Switch and Plate Voltage Selector. Measurement ranges for various types of tubes are printed on a handy chart right below the display so you don't have to fumble with an instruction sheet to determine the correct readings for your tubes.

The Maxi-Matcher is a well thought-out instrument that will come in really handy for guitar repair shops, music stores, OEM tube equipment manufacturers, tube dealers, and tube audiophiles. With the Maxi-Tester,

you can even create your own brand label of tubes!

We noted that the power transformer buzzed slightly when four 6550Cs were being matched at once. The Maxi-Test people said it was OK and that the unit was rated to handle four 6550s with a significant safety margin. In addition, the power transformer gets a little warm with four output tubes in the sockets, but again, this should not be a problem with normal use.

The Maxi-Matcher works on 120 VAC with a maximum of 75 watts input power. Its dimensions are 8.5" D x 12.5" W x 2.5" H. Suggested retail price is \$495 USD plus applicable shipping.

### For product data sheets and ordering information contact:

Allen R. Kaatz, Sales & Marketing,  
Maxi-Test Company, 6920 Roosevelt  
Way NE, Suite 135, Seattle, WA 98115  
Phone (206) 363-9915 FAX (206) 525-1791

Website: <http://www.aa.net/maxitest>

### Manufacturer's Comments:

Maxi-Matcher is actually a modern, highly accurate, digital version of older tube testers, incorporating precision with user-friendliness. It contains all the major tests available in those older units: Dynamic Mutual Conductance (transconductance) and the Short-Circuit socket being the important tests. Thus in fact the Maxi WILL supersede those older units for the testing of most power tubes, given the correct adaptor.

Maxi-Matcher is intended as a multi-purpose tool for several issues facing technicians and hobbyists, those being quick, accurate testing and verification of tube operation at real-world voltages, and precision current measurement for matching purposes.

Maxi-Matcher is designed for easy use by those with minimal training or technical knowledge. It will also serve the sophisticated user as well with data not readily available anywhere else.

Many other functions are available to those with a little technical interest; since the data for Plate Current and Transconductance are available on the display, Plate Resistance and Gain data may be derived using simple algebra, and all the families of curves and load lines can be generated for a given tube. Why rely on old data manuals when you can measure the tube you've got in your hand? (*Peter Toms, Maxi-Test Company*)



# 35 Watts of Triode Power with Variable Feedback

By Eric Barbour © 1998 All Rights Reserved

## Introduction

Single-ended triode amplifiers are currently enjoying a vogue. With considerable interest from the audiophile community invested in SE circuits, this looks to be a major genre for home-audio equipment. Yet even in spite of the popularity of SE, the majority of high-end tube amplifiers are push-pull in nature. There continue to be advantages to push-pull beyond those of other trends, and industry sales figures are still dominated by push-pull-based products. Furthermore, push-pull is the major standard for guitar and music amplification.

In 1996, a new family of power triodes was introduced: the Svetlana SV572. Based on the classic 572B high-mu transmitting triode, the SV572s have become a popular alternative to the use of expensive and scarce new-old-stock triodes, such as 845s and 211s made by RCA, Western Electric and General Electric. The SV572s have some technical advantages over the older low-mu triode types:

- smaller physical size than 845 or 211
- greater safety than 845 or 211, which offer lethal exposure through the large open socket
- less expensive socket required
- less filament power (25.2 watts versus 32.5 watts)
- greater plate power dissipation capability (125 watts versus 100 watts)
- available with mu of 3, 10, 30 or 160, unlike old triodes (845 mu is 5.3, 211 mu is 12.5).

Although the older types have a 70-year head start for previous applications, the modern high-end market is fragmented and open to a variety of designs and tube types. Few operational sockets exist for the 845 or 211 (except possibly in some older transmitters and PA amplifiers, as well as the small number of high-end

amps sold in the past 10 years). So, the SV572 series has attractive merits for a new design. And finally, although they are single-source items, SV572s are still under manufacture in Russia, whereas the 211 is made only in China at this time. American 845s are still being made by Richardson Electronics under the Cetron brand, although they sell for much higher prices than the SV572 triodes.

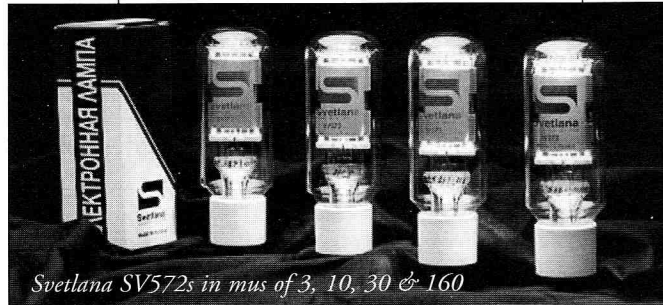

Svetlana SV572s in mus of 3, 10, 30 & 160

Presented here (Figure 1) is a power amplifier using a push-pull pair of SV572-3s in Class AB1. The design is centered around the use of commonly-available components which are reasonably priced. The total cost of parts for this amp, as shown, is estimated to be around \$800 if purchased from regular dealers. All the components are available from Antique Electronic Supply (AES), except the chassis, the meter and some capacitors (Mouser) and the DC power supply for filaments (Lambda). Surplus parts can reduce this total greatly, especially if a surplus DC switching supply can be found which is capable of producing +6 volts DC at 16 amps or more.

To date, very few amplifiers have been designed that feature variable loop feedback. My experiments with this circuit revealed that it could be made stable with the Hammond transformer and with a potentiometer to vary the loop feedback.

The control shown allows continuous adjustment of feedback from nearly 0 dB to about 14 dB. Thus, the user has an opportunity to experiment with different settings, so that optimum speaker damping factors and distortion levels can be found for a given setup. Considerable work was undertaken on the bench to optimize this amp into a variety of resistive and reactive loads, regard-

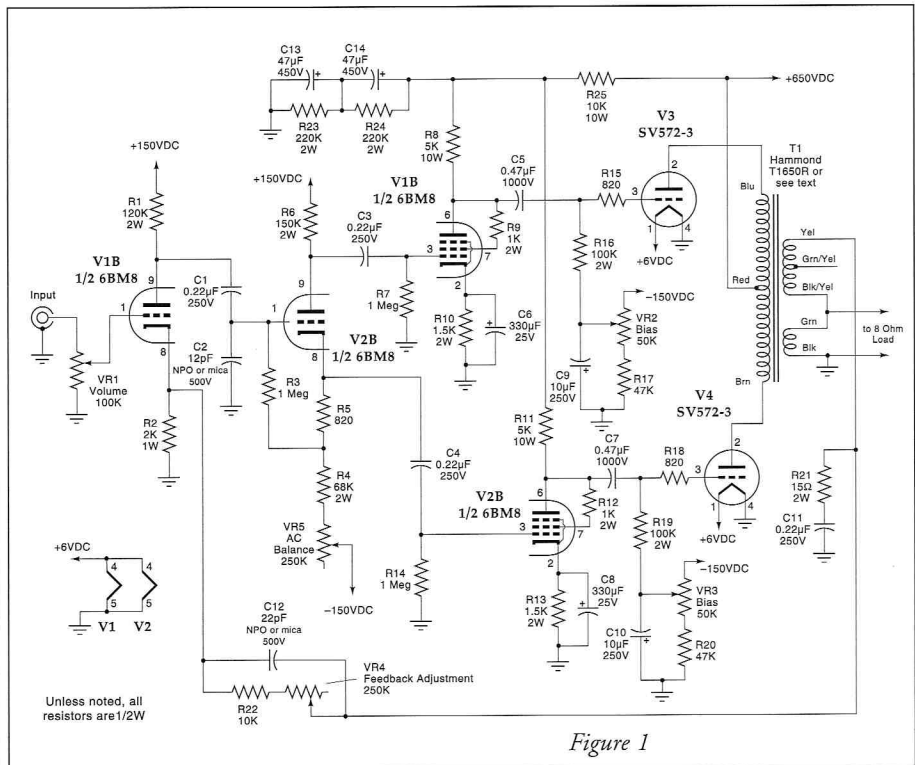

Figure 1



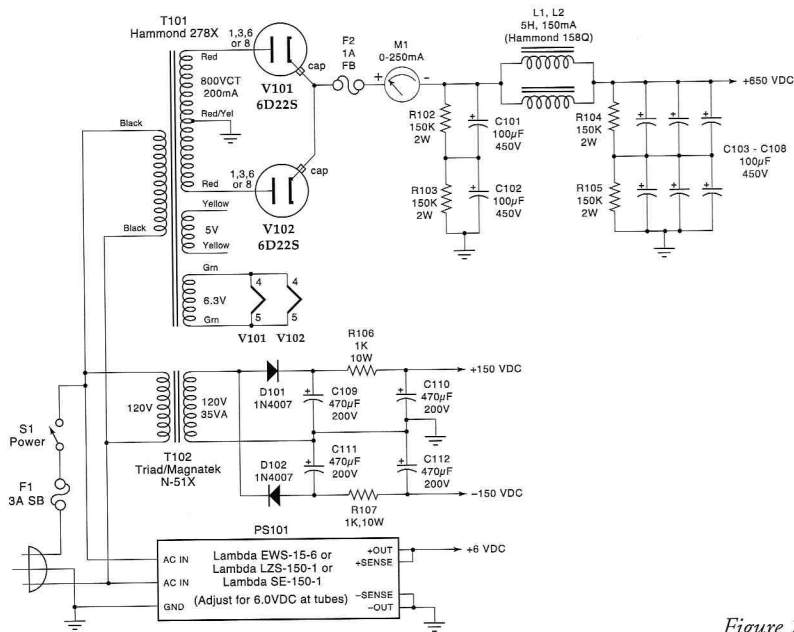

Figure 2

less of the feedback setting. As the driver stage has been kept as simple as possible with available tubes, voltage gain of the amp is relatively low, especially with feedback at maximum. So, the amp is recommended for use with a preamp which is capable of 5 volts r.m.s. output.

**Theory of Operation**

Primary design goals were decided with an eye to both the high-end audio area and to musical-instrument amplification. Simplicity was regarded as desirable, to maximize reliability. Only current Svetlana tubes were used, so that availability of NOS tubes in the future would not be an issue. Operation of all components is very conservative, again for maximum reliability in professional-audio use. Although the driver stage was kept simple, this amplifier is not really intended for the beginning DIY builder--some experience is recommended. The plate voltage of 650v is more hazardous than the voltages seen with less powerful tubes.

The design, seen in Figure 1 (on p. 25), is a straightforward driver and output stage. V1A is a high-mu triode which provides voltage gain of about 40. It is RC-coupled to V2A, which is connected as a split-load phase inverter. Potentiometer VR5 is used to adjust the AC signal balance of this phase inverter, to minimize output distortion. V2A is operated from a split supply of +150v and -150v, to prevent heater-cathode insulation damage.

V1B and V2B are used as gain stages

with a voltage gain of about 8. These 7-watt pentodes are connected as triodes, with a conservative plate loading of 5000 ohms and a conservative plate-current operating point of 20 milliamps each. The screen resistors R9 and R12 serve to limit the current into the screen grids of V1B and V2B, thus preventing damage. The plate supply for these stages is about +500 volts, which allows a maximum voltage swing into each SV572-3 grid of about 400 volts at clipping. This is more than adequate for maximum power in Class AB1 operation of the power triodes. +500 volts is derived from the +650v supply through R25. Biasing of the output tubes is accomplished with potentiometers VR2 and VR3, using the same -150v supply used on V2A to provide an adjustable -72 to -150v grid voltage for the SV572-3s.

The SV572-3s are connected in the common manner, with their filaments operated from a single switching power supply. Since 6.3 volt supplies are unusual, we have found some Lambda supplies that produce +6.0 volts, a good compromise. The model EWS-15-6 is a special-order item designed for 6 volts, while the LZS-150-1 and SE-150-1 are 5-volt devices, available from stock, which can be adjusted up to +6.0 volts. All of these supplies are conservatively rated for this load, which is about 9.5 amps steady-state and much more at power-on. (Remember, tube filaments draw much more current when cold than at operating temperature--switching supplies are usually limited in their transient current capability, and

must be derated when used to run tube filaments.) All switching supplies can produce RFI at frequencies greater than 20 kHz, so regardless of the supply used, C113 may be required and is recommended. It should be mounted directly to the SV572 socket tabs. Be sure to get the polarity correct.

The output transformer shown is a Hammond 1650R, which has a primary impedance of 5000 ohms plate-to-plate. As the SV572-3s will give best performance on a higher load impedance, the 1650R is connected so that it appears to have a 10k-ohm primary. This is done by simply connecting the 8-ohm load to the 4-ohm output tap. Although this can degrade frequency response, the effect is minimal in this circuit, and hi-fi performance is still possible. For musical-instrument use, the Hammond transformer gives excellent performance, especially compared to more conventional tube amplifiers which are often used for live music amplification. There are now some push-pull output transformers available with higher primary impedances, which are much more expensive than the Hammond and will give somewhat better performance. These transformers have been tested with this circuit, and all gave much improved performance. Figure 3 (p. 28) shows how they were connected to the amplifier. Ultimately, the choice of output transformer is up to the constructor and the budget.

Capacitors C2, C11 and C12, and resistor R21 serve to stabilize the amplifier at all feedback settings. Their values are not critical. An assortment of reactive loads and speakers have been attached to the prototype, and no instability or oscillation were observed with the values shown. C2 and C12 serve to limit high-frequency response and correct phase shift, while C11/R21 are a load network, which provides some capacitance on the output regardless of the speaker load. Even though great pains were taken to insure stability, some speaker loads may not work properly on this amplifier. It is difficult to build an adjustable-feedback amp of this type and be certain that it is well-behaved under all conditions. It's advisable to test it on the bench with the desired speaker load on it, with an oscilloscope attached in parallel, to allow watching for spurious oscillation.

The power supply (Figure 2) uses common components throughout. The rectifiers are Svetlana 6D22S types, which are of the TV horizontal damper-diode type. Their slow warmup and very conservative operation will help minimize the chance



of failure, as the SV572-3s warm up far more quickly than the 6D22Ss. This diode is unusual in that it has a cathode cap rather than a plate cap. A connector for the cap with an insulating boot is recommended. The Svetlana PC509 has a ceramic body which completely covers the cap; nevertheless, if safety is an issue here, a cage over the tubes or an enclosed chassis is recommended.

A small 120V-120V isolation transformer and voltage doubler rectifier are used to produce +150V for the driver and -150v for the phase inverter and bias network. PS101, discussed above, may be one of the Lambda models shown or a surplus unit capable of being adjusted to produce +6Vdc under load. If a single choke capable of 200 mA DC continuous operation is available, it may be used in place of L1 and L2. We used a pair of commonly-available 150-mA chokes here for conservatism.

Mounting of the components is up to the builder. In the prototype, the chassis was inverted and the Lambda supply, T102, L1 and L2, and some terminal strips were mounted therein. C101 thru C108 were soldered to two long terminal strips along with their bleeder resistors R101 thru R105. Capacitors C109-C112 are PC-mount types, and were attached to the bottom of the chassis with epoxy cement. D101, D102, R106 and R107 were installed on a terminal strip which then were wired over to these capacitors. Potentiometers were mounted on the front panel of the chassis.

The meter, M1, was a surplus 0-250 mA DC unit, mounted in a matching slope-front cabinet to the chassis front. Since this rating is difficult to find, the parts list gives a Mouser part which can

be substituted by paralleling a 2.2 ohm, 2-watt resistor across it. This makes it approximately 0-200 mA reading. A new scale will have to be devised for it, whereupon it can be mounted on the sloped case given in the parts list, then the whole assembly can be mounted on the chassis front. Mating holes through the bottom of the sloped case and the front of the

chassis can pass the wiring for the B+ power; be sure to use a rubber grommet on these holes, as shorting this B+ line can give some pyrotechnics. Finally, input and output connectors, S1, F1 and the AC cord connector were mounted to the case rear.

Sockets for V1 through V4, terminal strips for the driver passive components and C13, C14, R23 and R24, and transformers T1 and T101 are mounted to the top cover plate. Wired connections are made to the power supply components in the chassis. Be sure to leave sufficient free length in the wiring to allow removal of the top plate for troubleshooting, possibly with the top plate propped on its side to allow access to the circuitry underneath. If the amplifier will be used in a professional setting, the input jack should be a 1/4" panel-mount type. Alternatively, both RCA and 1/4" jacks can be provided on the input, and both binding posts and a 1/4" jack may be provided for the speaker output.

### Adjustment

Upon completion of the amplifier, install all the tubes and set the bias controls VR2 and VR3 to give the most-negative voltages to the SV572-3 grids. Power it up (no standby switch is needed), and observe the plate current meter. If it exceeds 250 mA, power off and examine the circuit for errors or for faulty components. Then set VR5 to its midpoint, and turn VR4 and VR1 down fully.

Once the amplifier has been verified to idle properly, bias adjustment may be performed. Shut off power and remove both SV572-3s. Power up again and observe

the current drawn by the 6BM8s alone, which should be about 45 mA. Power down, install V3 in its socket, and power up again. Adjust VR2 until the plate current meter shows 105 ma (60 mA for the triode plus 45 mA for the 6BM8s). Power down, install V4, power up again, and adjust VR3 to read 165 mA. Due to the difficulty of attaching cathode current meters to directly-heated triodes in a circuit such as this, it is necessary to adjust each triode's bias separately and add that current to the rest of the circuit. This scheme works quite well, and even with an old surplus 250 mA meter for M1, gives repeatable current balance in the output transformer to within 5 mA. More accurate adjustment is not required by the transformer; we have tried considerably greater DC unbalances with only a small effect on distortion and low-frequency response.

If desired, the AC balance of the phase inverter can be adjusted in two possible ways. The least expensive way involves mixing the phase-inverted outputs together and adjusting VR5 for minimum fundamental, as follows:

1. Remove power, pull V3 and V4 out of their sockets, and open the case. Attach one end of a 1-megohm resistor to pin 3 of V1. Attach one end of another 1-megohm resistor to pin 3 of V2. Connect the free ends of these resistors together, and attach the probe of an oscilloscope to this point. (Alternatively, the 1-meg resistors could be soldered to small screws or pins, which are then inserted into pin 3 on the V3 and V4 sockets. Be careful not to let anything short to the case, and be VERY careful not to plug the resistors into pin 2 of the V3 and V4 sockets.)

2. Attach a sine-wave generator to the input jack. Frequency setting is not important, 1 kHz is commonly used. Set the scope's sweep rate to 500 usec/division, and set the vertical sensitivity to 1 volt/division.

3. Carefully power up the amplifier. Set the volume control VR1 and the signal generator's level control until you observe the signal on the scope. It should appear like two dissimilar sine waves mixed together; one is the 1 kHz fundamental, the other is the 2 kHz second harmonic.

4. Then adjust VR5 until the fundamental is nulled out; you will find a point where VR5 can be rocked back and forth, and the fundamental will disappear, leaving only the second harmonic. Leave VR5 at that null point, remove power, and reassemble the amp.



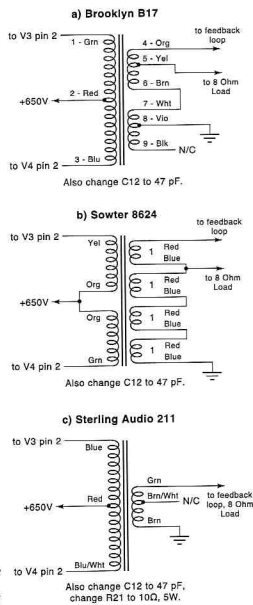

Figure 3  
Output  
Transformer  
Connections

**Modifications**

The advanced builder may wish to increase the plate voltage--calculations indicate that this design can produce close to 100 watts into an 8-ohm load if a plate voltage in the 900v-1000v range (at 500 mA maximum) is supplied to V3 and V4. This would require a substantial plate power transformer, a higher impedance output transformer, and, in addition, a more negative bias voltage would need to be provided for the SV572-3s. Also, another, small plate transformer may be required to provide +500 volts for the 6B8M pentodes. Again, this is not suited for the beginning DIY constructor, as such voltages would be a serious hazard while the amplifier is under test or during troubleshooting.

One possibility for improving frequency response would be to utilize a superior output transformer. Previously such a large transformer, with a primary on the order of 10k ohms, was difficult to find. Recently the situation has changed, as MagneQuest now offers the Brooklyn line of push-pull transformers. Also, Sowter and Sterling Audio have both produced models intended for large thoriated-fila-

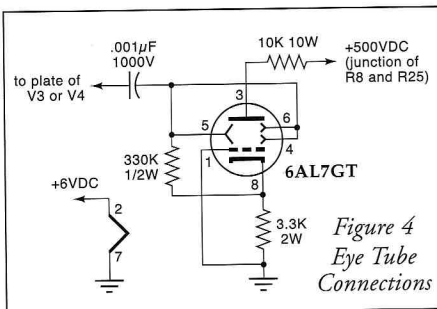

Figure 4  
Eye Tube  
Connections

ment power triodes such as the SV572. Figure 3 shows how to connect these premium transformers to the amplifier circuit. Their secondary connections are quite different from those of the Hammond 1650R, so modifications may be required for some speaker loads. These premium transformers were tested in the amplifier on the bench and appear to give modest improvements in electrical performance, especially with the feedback fully off. These premium transformers are much more expensive than the Hammond 1650R, so anyone intending to use this circuit in a commercial product may find the performance of the 1650R acceptable. For the DIY user who aims for best possible sound quality, the premium types are worth investigating.

A tuning-eye indicator tube can be mounted behind the front panel of the chassis to show the presence of signal. Figure 4 shows a circuit using the common and inexpensive 6AL7 eye tube. This is the same circuit used in my SV811-10 amp in Glass Audio. The eye tube is entirely optional, although it does make an interesting conversation piece.

Further improvements, of the POOGE type, are also possible. A variety of different film coupling capacitors can be used for C1, C3, C4, C5 and C7. Oil-and-paper types can also be tried, although the Audio Note types and some NOS brands may have leakage currents which could upset the bias points of V3 and V4, so these should be tested before use as C5 and C7. R8 and R11 were wirewound types, and their parasitic inductance seems to have little or no effect on sound or electrical tests. Still, if you worry about these small details, a string of five 1k-ohm 2-watt metal-film resistors could be substituted. R9, R10, R12 and R13 can be wirewound 5-watt units without any penalties. Electrolytic capacitors can be bypassed as needed with film types, although 1000-volt units would be recommended for bypassing the main supply filters C101-C108 and C13-C14. Antique Electronic Supply sells a 1600v polypropylene capacitor which is excellent for this use--its stock number is C-SD01-1600. This may not be needed if the amp will be used as a stage instrument or monitor driver.

**Exit**

Listening tests have been conducted with this amplifier, both in a hi-fi setup and as an instrument amp with various speakers. It acquitted itself admirably in

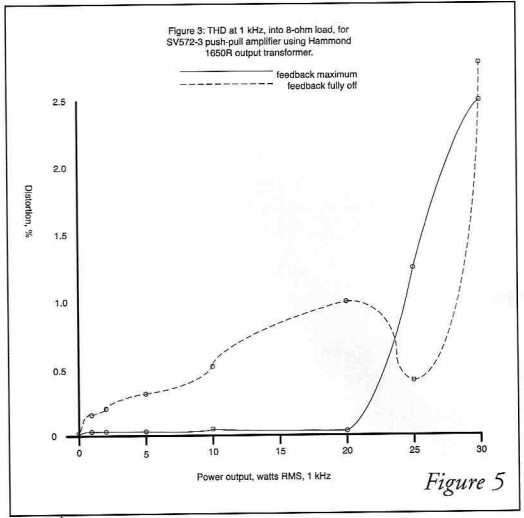

Figure 5

all the situations--if more damping factor is needed, simply increase the feedback until the desired bass damping is heard. It made an especially good match for my experimental vacuum-tube synthesizers, as well as for acoustic guitar. It seems to be excellent for amplifying acoustic instruments which have delicate tonalities, while having just the right accuracy. Many no-feedback single-ended amps can muddy the situation, by comparison.

Varying the feedback in this amp causes the distortion curve with power output to change as shown in Figure 5. The "dip" in the curve at 25 watts is commonly seen in push-pull amps, and is due to nonlinearities and incomplete cancellation of even-order harmonics. Note how the addition of feedback renders the distortion virtually flat below 20 watts, and causes it to rise smoothly above that point. Further, adjusting feedback causes major changes in the low-frequency response, allowing the user to "tune" the amp to a given speaker. Indeed, variable feedback is probably the ultimate "tweak," and one which has been very scarce in the past.

**Performance Ratings**

- (using Hammond 1650R output transformer)
- Power output into 8 ohms: 35 watts (16.7 volts RMS) at 5% distortion
- Input for full power, volume control at maximum: with feedback minimum: 1 volt RMS with feedback maximum: 5 volts RMS
- Frequency response, -3 dB, at 20 watts out: with feedback at minimum: 27 Hz to 15.7 kHz with feedback at maximum: 22 Hz to 40 kHz
- Hum and noise, within audio band: with feedback at minimum: 3.9 mV p-p with feedback at maximum: 2.7 mV p-p
- AC power consumption, at 35 watts into 8 ohms: 220 watts at 120 vAC.

# Distortion Analyzers

## Part III

© 1998 All Rights Reserved

### The Audio Test Bench

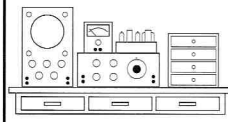

by

John Atwood

The history and philosophy of audio distortion analyzers was presented in part one of this series (VTV #8, page 30). In the second article (VTV #9, page 25) several actual distortion analyzers were discussed in detail. In this last article of the series, the interpretation of the measured results will be covered.

A distortion analyzer is only a tool. Its measurements need to be interpreted in the context of the circuit being tested. Most analyzer readings are actually quite crude – putting a one-dimensional number to a multi-dimensional problem. By either doing a series of single-point measurements, or by using newer analyzers that perform “sweeps,” the circuit can be much better evaluated.

The discussion of acceptable or desirable distortion levels is based on my own somewhat tube-centric view of audio. Many professionals view reducing distortion figures to the lowest possible levels as an essential part of their jobs. However, I have found that extremely low distortion figures have little to do with really good

sound. Since the common distortion measurements are so crude, they should really be viewed as guideposts pointing to how the circuit really sounds. *Note: The measurements in this article were made with an Audio Precision System 2 described in the previous issues of VTV.*

### Simple Total Harmonic Distortion (THD)

One of the most common figures of merit for an audio system is Total Harmonic Distortion (THD). This is usually taken at 1KHz and at full output for a power amplifier or at a standard line level output for preamps. As will be seen later, these test conditions are not really representative of real operation. Also, THD just measures the RMS value of all harmonics and noise, and gives no weighting to the various harmonics.

THD was one of the first measurements of the “goodness” of amplifiers. Back in the 1930s when it first became widely used, amplifiers had little or no feedback and could have considerable

non-linear distortion. A THD of 5% at full power was considered a reasonable design point for home radios and phonographs. For professional audio equipment, a maximum THD of 1% at maximum level was the standard through the 1950s. Due to the tube-type equipment, pre-dominance of class A or AB1 designs, and low feedback levels, distortion would nearly always fall at lower signal levels, so that at less than maximum levels (where most of the audio information resides) the distortion would be low.

However, even in the 1940s, there was evidence that THD was not an entirely reliable specification. Listening tests had shown, for example, that tolerable distortion was 3.4% on triode amplifiers and 2.3% on pentode amplifiers (see Radiotron Designer's Handbook, 4th Ed. p. 609 for more details). What was really happening was that the different distortion characteristics between these two type was manifesting itself.

So, what are reasonable THD values? If the amplifier is known to have simple, low-order distortion products, then several percent can be just fine. For amps with higher-order products (high-feedback or solid-state) 1% may be the limit. Don't let the difference between a 0.02% and 0.05% THD figure bother you. At these low “distortion” levels, other things are affecting the sound.

One aspect of THD figures that you should be aware of: on class-B amplifiers that have any amount of cross-over distortion (distortion at the zero-signal point), THD is often the lowest just below maximum signal level, and can be very high at low signal levels. This is one reason why some amps sound the best when played loud.

### Harmonic Products (Spectrum Analysis)

A much more indicative measurement of distortion is to see the relative amplitude of each harmonic. It is well known that the human ear is much more sensitive to high-order harmonics. The mixture of harmonics also can give an amplifier its tonal character. The harmonic structure of an amplifier is in a sense its “fingerprint.”

Traditionally, the amplitude of each harmonic was laboriously measured with a wavemeter – essentially a specially calibrated low-frequency radio receiver. This could be automated by sweeping the frequency. However, these spectrum analyzers typically sweep too slowly to be very

Audio Precision System 2

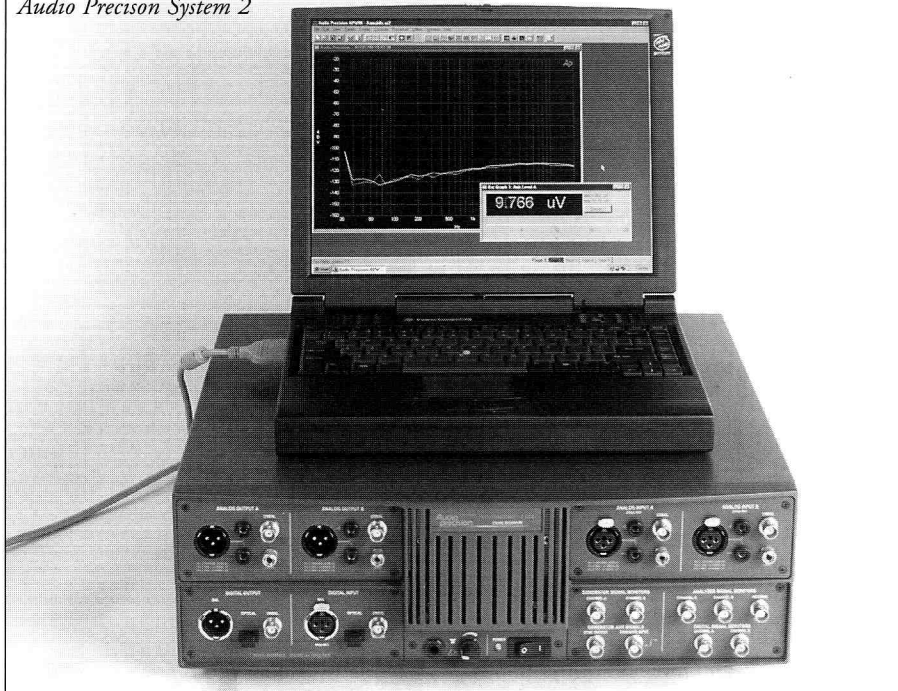



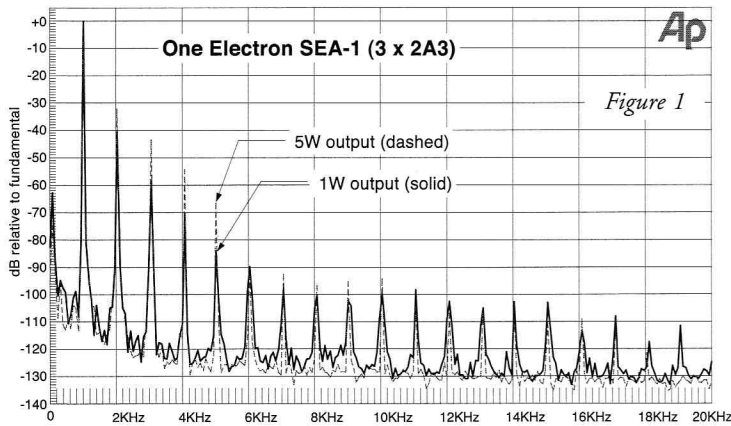

Figure 1

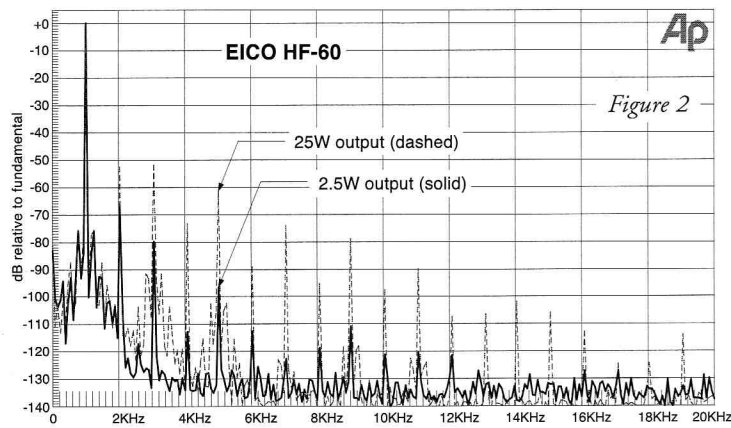

Figure 2

useful. The modern way of performing a spectrum analysis is by using an FFT (Fast-Fourier Transform). Now part of most high-end audio analyzers, several software packages are also available to allow your PC to run an FFT on the sound card input.

Different amplifier topologies tend to have characteristic spectrum fingerprints. Figure 1 shows the distortion of the One Electron SEA-1 amplifier (described in Sound Practices issue 7, page 26). It uses three 2A3s in parallel single-ended with no feedback. The driver line-up is a 6J5 triode followed by a 6BL7GT dual triode (sections paralleled). At the left is the fundamental, in this case at 1KHz. To the right of the fundamental are the 2nd, 3rd, 4th, etc. harmonics. Note how the harmonics tend to fall in a straight line up to about the 7th. When the power is increased from 1 to 5 watts, the harmonics up to the 10th fairly evenly increase.

Figure 2 shows the spectrum of a push-pull EL34 amplifier (EICO HF-60). Note that the harmonics fall quicker, but are uneven, with the odd-order harmonics dominating. This is due to the distortion cancellation inherent in push-pull stages. When the power level is increased from

2.5 to 25 watts, the higher-order harmonics increase quicker than with the single-ended amp. An interesting phenomenon unique to push-pull amps can be seen here: the power-supply hum spectrum appears on both sides of the fundamental and the odd harmonics. This is because the push-pull output stage is acting as a balanced modulator to the power supply noise. Before getting too fixated on an amp's particular spectrum, realize that the harmonic distribution is very dependent on signal level, amplifier stage bias, and particular tubes. In an amplifier with multiple stages, the distortion of one stage may actually cancel the distortion of another stage. It is not unusual to see certain harmonics actually go to zero at particular signal levels. Since music is not just a fixed tone, the sound of the amplifier will depend on how the harmonics behave from low signal levels to high. The bias point of amplifier stages can be adjusted to give the best behaved harmonics (i.e., low amount and low order).

When an amplifier starts to go into clipping, the high-order harmonics start to proliferate, as can be seen in Figure 2. Even in this over-drive condition, the spectral characteristics can be different, though. One reason low-feedback amps can be pushed harder than their

power ratings suggest is that the onset of clipping is gradual. Very high levels of feedback, typical of most solid-state amplifiers, give very abrupt clipping.

**Intermodulation Distortion (IMD)**

Intermodulation distortion creates distortion products that are not harmonically related to the incoming signal, and are thus more audible. Some engineers feel that IM distortion more accurately measures "bad" distortion. IM distortion is caused by high-order harmonic distortion, so, in general, there is a linkage between IM distortion and harmonic distortion, although the exact relationship depends on the harmonic distortion spectrum.

As a single-point measurement, IM distortion is more interesting than THD, since it is more sensitive to what the ear hears. However, there are several different IM measurement standards, and some are generally defined for a single set of frequencies, so it may difficult to compare different IM measurements and to sweep IM distortion versus frequency.

On most tube amplifiers putting out a given power, the IM distortion is generally about 1.5 to 4 times the THD reading. Readings below 2 to 5% are generally good.

**Other Distortion Measurements**

Some newer analyzers have provision for measuring Transient InterModulation (TIM) or Slewing-Induced Distortion (SID). These measurements are important in high-feedback designs, where inadequate slew-rate inside the feedback loop can be a problem. In low-feedback designs, TIM is seldom a concern.

A common slew rate test is the DIM (Dynamic InterModulation) test. A 15KHz sine wave is superimposed on a 3.18KHz square wave and then passed through the system. The results go through a low-pass filter (typically 30KHz) and the intermodulation products are measured.

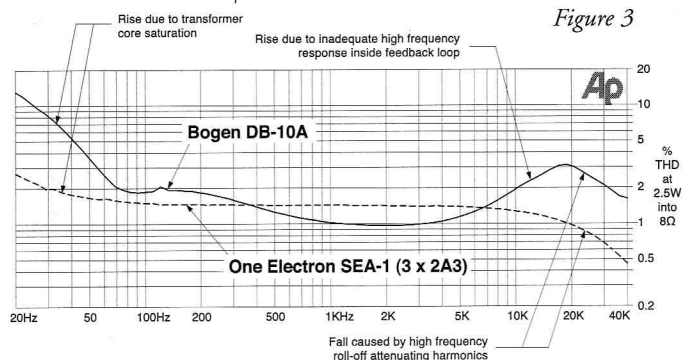

Figure 3

There have been various tests to try to come closer to measuring what the ear hears, or at least what conventional tests overlook. One proposed test works by applying white noise through a very sharp notch filter and measuring how much crud falls into the notch after passing through the system.

**Sweeps of Distortion vs Frequency**

The single-point THD measurement is not very revealing. However, by plotting THD versus frequency, you can get some clues as to how the amplifier behaves. These are sometimes called "sweeps," since the test signal is swept over frequency. At frequency extremes, amplifiers start to have problems, and THD at these frequencies is a clue.

Any amplifier with standard feedback (not frequency-selective) will tend to flatten the frequency response curve. In other words, if the low-frequency or high-frequency response of the open-loop amp drops at the frequency extremes, feedback will "restore" this lost frequency response. At the same frequencies that it restores the frequency response, the amount of feedback is reduced. This shows up as rising THD at the frequency extreme. Early solid-state amplifiers often used output transistors whose high-frequency gain barely made it to the upper end of the audio band. Feedback "helped" this drop-off, but at the expense of TIM and high THD at high frequencies.

Figure 3 compares the THD response of the SEA-1 single-ended amp and a push-pull 6V6GT amplifier (the Bogen DB-10A), both driven to give 2.5 watts into 8 ohms at 1KHz. The Bogen has almost 50% less distortion at 1KHz than the 2A3 amp, but is much worse at the

frequency extremes. Particularly striking is the high distortion at low frequencies, even though the amplifier is running at only about 1/4 of its power rating. This is due to transformer core saturation. Even though it is handicapped by running single-ended, the 2A3 amp has much less core distortion, since its output transformer (One Electron UBT-1) has a 2.0 square inch core cross-section versus 0.56 square inches for the Bogen.

Measurements of THD are only valid when all the significant harmonics are passed by the amplifier under test. The drop-off in distortion above 15KHz for both amplifiers is caused by their natural high-frequency roll-off.

Sweeps of Distortion vs Amplitude/Power Plotting THD or IMD vs power level can give some important clues about how an amplifier behaves as its power output is increased. Some of the best-sounding class-A amplifiers have the simple behavior that the amount of distortion increases linearly with amplitude. As an amplifier moves closer to class-B operation, the curve of distortion versus amplitude starts to flatten, and as cross-over distortion comes into play, the curve actually bends down so that distortion decreases at higher power. Experience has shown that systems with this behavior are not good-sounding. Amplifiers with dynamic biasing, "sliding class-A" operation and other such tricks usually show bumpy curves.

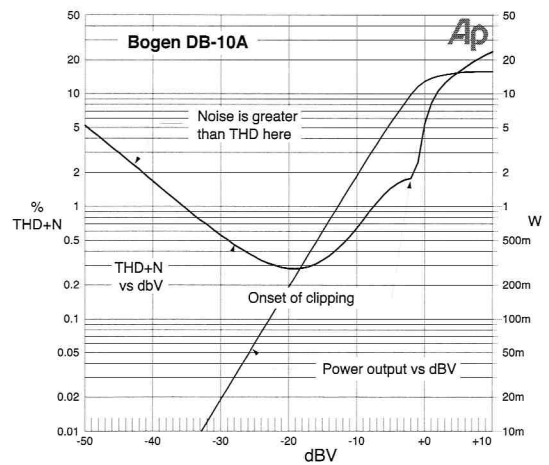

Figure 4

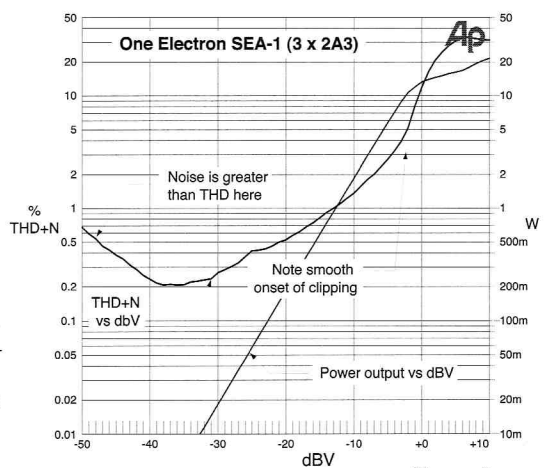

Figure 5

levels. This obscures the non-linear distortion behavior, so using filters and hum traps in the analyzer is warranted here.

When abrupt clipping occurs, the curve will not go straight up, as you might expect, since only a portion of the waveform is clipped. However, the clue that abrupt clipping is happening is a quick change in the slope of the line at high power levels. Gentle clipping gives a more rounded curve.

Figures 4 and 5 show distortion curves for two different tube amplifiers. The bottom scales indicate the input voltage to the amplifier (0 dBV = 1.000 Vrms). The curve of "Power Output vs dBV" is used to correlate the power output level to the distortion reading. The test frequency is 1KHz. A 400Hz high-pass filter in the analyzer reduces hum artifacts.

Figure 4 is of the Bogen DB-10A. The residual noise is fairly high at low signal levels, but as the power level rises above 300 mW, the real distortion starts to

When sweeping THD versus amplitude, be aware that below a certain signal level, the residual hum and noise will be larger than the distortion products. On the sweep, this shows up as a constant increase in "THD" at lower signal

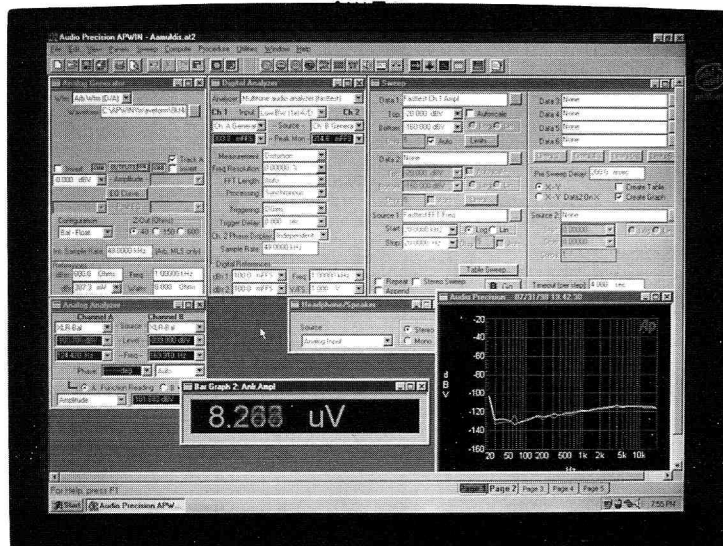

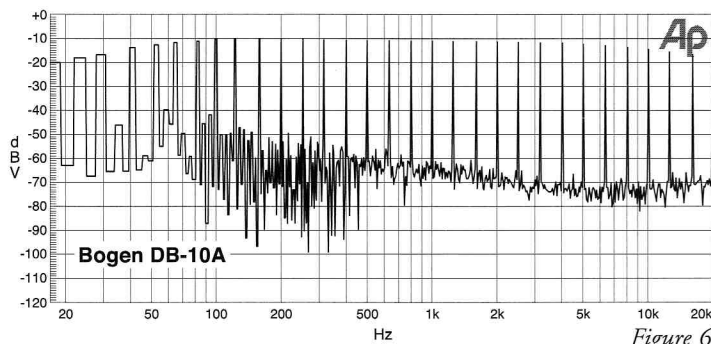

Figure 6

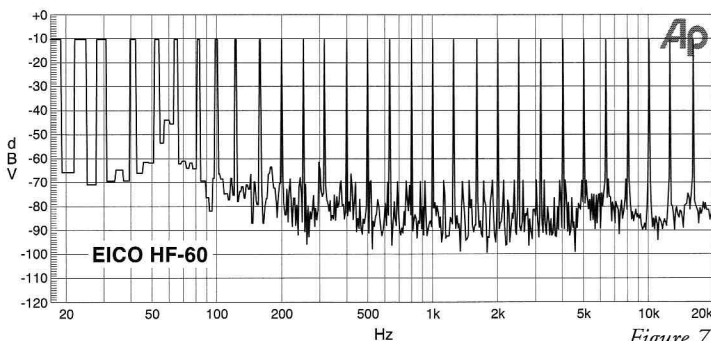

Figure 7

dominate. Note that the distortion does not increase linearly, but starts to flatten out before abruptly rising when clipping starts.

Figure 5 (p. 31) is of the One Electron SEA-1 amplifier. Note that the residual noise is quite a bit lower than in the Bogen amp, dominating only below 10mW. Also notice that the distortion increases fairly smoothly up to about 10 watts, where a very gentle clipping begins, typical of a no-feedback design.

**Multi-tone Testing**

Traditional distortion testing uses fairly simple test signals – one or two sine waves. Given the complexity of music, a more complex test signal would be helpful in stimulating the more unusual sources of distortion. It is difficult to run these tests with conventional analog circuits, although it has been done. An example is the use of several closely-spaced sine-waves at the high-end of the audio band. These can elicit digital converter non-linearities better than the usual IM or THD tests. This is just one type of a class of complex-waveform tests called “multi-tone” testing

Digital processing makes handling multi-tone tests much easier. A multi-tone test signal can be stored as an arbitrary waveform, and then output through a D/A converter. After going through the system under test, the signal is brought back into the digital domain through an A/D converter, an FFT spectrum analysis

is run, and the results are analyzed or plotted.

Since commonly-needed information, such as frequency response, noise level, THD, and phase can be extracted from a very short burst of a multi-tone signal, multi-tone testing has become popular in the broadcast industry, where disruptions due to testing must be minimized. As little as a quarter-second

multi-tone burst can be inserted into the broadcast signal – allowing on-the-air testing.

Multi-tone testing is helpful in audio circuit design and analysis, since it stimulates the circuit with a complex waveform that is more similar to real music than sine waves. Intermodulation distortion and time-dependent distortions will tend to fill in the gaps between the test signals – showing grunge in components better than simple harmonic spectra.

Figures 6 and 7 show the multitone response of two push-pull tube amps: the Bogen DB-10A (P-P 6V6GT) and the EICO HF-60 (P-P EL34 with Acrosound TO-330 output transformer). All the tones were at a -10 dBV level (approx. 12 mW into 8 ohms). In Figure 6, the poor frequency response of the Bogen amp can be seen as the tones drop at high and low frequencies. The HF-60 has very flat response and, except for some 60 Hz hum, has lower overall crud between the tones than the DB-10A. To be fair, the Bogen is being pushed harder than the EICO, but at the low power levels of the test the main differences are due to the EICO's better transformer and better circuit topology.

**The Future of Audio Testing**

As technology marches forward and computing power gets cheaper, the kind of automated testing that can be done on the Audio Precision system today will “trickle-down” to more mundane testing.

Analysis in the digital domain, such as FFT and multi-tone testing will become more common, with PC-based tests becoming very widespread.

As noted earlier, there still is a big gap between perceived audio quality and simple test results. The good news is that the vastly increasing computational power available to even hobbyists will allow more sophisticated tests to be run by more people. Work needs to be done on creating tests that better measure what our ears and brains hears.

**References:**

1. **Proceedings of the AES 11th International Conference**, Audio Test and Measurement, May 29-31, 1992 (available from the Audio Engineering Society, New York, NY). A good collection of papers on contemporary audio testing.
2. **Comparison of Nonlinear Distortion Measurement Methods**, Richard C. Cabot, AES 11th International Conference Proceedings (described above), pp. 53 - 65. A summary of test procedures with results from test circuits. Includes a good bibliography.
3. **Radiotron Designer's Handbook, 4th Ed.**, F. Langford-Smith, Chapter 14 “Fidelity and Distortion.” A summary of distortion and criteria for high-fidelity in the mid-1950s.



**VACUUM TUBE VALLEY**  
SUNNYVALE, CALIF. U.S.A.

Be the first in your neighborhood  
to have the official VTV  
“BIG TONE” T-shirt.

2 color heart print available in either  
**Blue Spruce** or **Burgundy**  
(Please Specify when ordering)  
100% cotton shirt. Only extra large available.

**Only \$14.50. plus \$3.00 postage US,**  
**CA residents add \$1.12 Sales Tax**  
Canada and Mexico add \$7.00 postage  
Europe and Asia add \$12.00 postage

**Cash, Check or Money Order**  
**Credit Cards OK**

**Vacuum Tube Valley**  
P.O. Box 691  
Belmont, California 94086 USA



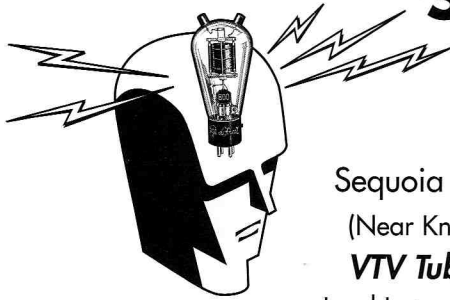

# Southern California Tube Enthusiast's Weekend

February 27 & 28, 1999

Sequoia Conference Center, 7530 Orangethorpe Avenue, Buena Park, CA  
(Near Knott's Berry Farm, Disneyland and John Wayne Airport, Lots of Motels Nearby)

**VTV Tube School for Guitar & Hi-Fi - First Time in LA - Don't Miss This!!**

Lead Instructor: John Atwood, MSEE, VTV Tech Editor with Charlie Kittleson & Evan Aurand

**Saturday - February 27, 1999 - VTV Tube School: 7:30 am to 4:00 pm - \$129** (pre-register before 1/15/99), \$139 (before 2/27/98) \$149 at the door. **Includes Tube School Binder and Class Reference Materials.**  
**\*Both Classes are for Beginning to Intermediate Tube Knowledge. Note: You can only sign up for one afternoon class.**

**Morning Session:** Tube Theory, Buying and Testing Tubes, Transformer Basics, Equipment Maintenance and Upgrades.

**Afternoon Hi-Fi Session:** History, Circuit Theory, Component Sound, Trouble Shooting, Schematics, Listening Session.

**Afternoon Guitar Amp Session:** Fender and Marshall History, Circuits, Effects, Mods, Transformers, Speakers, Repairs.

**Sunday - February 28, 1999 - Southern California Vintage Hi-Fi Swap and Orange County**

**Record Swap Meet:** Vintage Audio Gear and Guitar amps, NOS Tubes, Books, Parts, Speakers, Vinyl, more!!!

**Admission:** 9-10 am early birds: \$5.00, 10:00 am on: \$3.00, Vendors: \$35.00 per table. (Payable to Kevin Deal)

For info on the Hi-Fi Swap, contact: **Kevin Deal at (909) 931-9686** **AMEX, Mastercard and VISA Accepted**

## Vacuum Tube Valley

P.O. Box 691,  
Belmont, CA 94002  
**(650) 631-6550**  
**FAX (650) 654-2065**  
triode@vacuumtube.com  
www.vacuumtube.com

Name \_\_\_\_\_ Date \_\_\_\_\_  
Address \_\_\_\_\_ City \_\_\_\_\_  
State \_\_\_\_\_ ZIP \_\_\_\_\_ Phone Number \_\_\_\_\_  
Credit Card Number \_\_\_\_\_  
Card Expiration \_\_\_\_\_  
Date \_\_\_\_\_ Signature \_\_\_\_\_  
VTV Tube School Amount Enclosed \_\_\_\_\_  
Sign me up for the: Hi-Fi Class \_\_\_\_\_ Guitar Amp Class \_\_\_\_\_

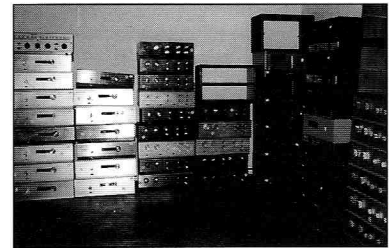
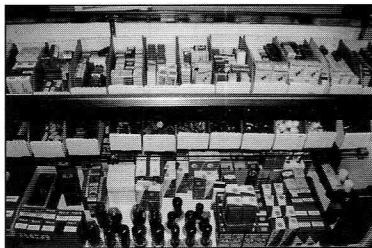

## VTV Pro Tube Shop

**The Premier Tube Shop in the Bay Area - Now Open for Customers by Appointment Only.**

J. J., Sovtek, Svetlana, Tesla, Western Electric, NOS Amperex, GE, RCA, Sylvania Audio Tubes

Large selection of 400 and 600 volt coupling and electrolytic caps, transformers and tube sockets.

Huge Selection of Vintage Audio Gear from Altec, Dynaco, EICO, Fisher, Harman-Kardon, McIntosh, Scott, etc.

**Professional repair, restoration and service of all tube-type audio and guitar amplifiers.**

VTV Pro-Tube Shop located right off Hwy 101 in San Carlos, CA (10 miles South of SF Airport)

**Call 650-631-6550 for appointment and directions. No Walk-ins Please!**



# ELECTRA-PRINT AUDIO

## QUALITY HANDWOUND S.E. OUTPUT TRANSFORMERS

- Primaries from 1.8K to 10K
- Exclusive wideband design
- 16, 8, 4, or 2 ohm secondary
- Gold plating

## CUSTOM-BUILT POWER TRANSFORMERS/CHOKES

- Wound to your requirements
- Heavy-duty design for Class A use
- DC filament supply windings
- HV chokes to 15H, 300ma
- Low voltage, high current filament chokes

Component pricing and specifications catalog available

### ELECTRA-PRINT AUDIO

4117 Roxanne Drive Las Vegas, NV 89108  
702-396-4909 FAX 702-396-4910



**Single-Ended Output Transformers**  
High Quality for a Reasonable Price  
Designed and Built in the USA

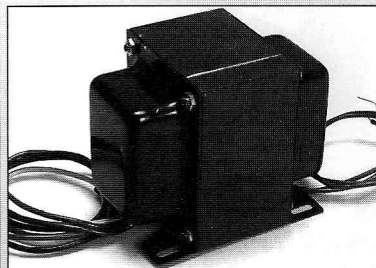

**UBT-1** Designed for parallel operation of:  
1.6k primary 15 watts 160 mA **\$90.25** 2A3s, EL34s, 300Bs 6AS7s, etc. or Sweep-tube in "enhanced triode" mode

**UBT-2** 4.8k primary 15 watts 110 mA **\$112.10** Can be used with: 300B, 50, SV811-3, etc.

**UBT-3** 3k primary 15 watts 110 mA **\$121.60** Good for single ended 2A3 or 300B

Quantity discounts available

ANTIQUE ELECTRONIC SUPPLY™ LIMITED PARTNERSHIP

6221 S. Maple Ave. • Tempe, AZ • 85283  
Phone (602) 820-5411 • FAX (602) 820-4643 or 800 706-6789



# 52A3

SPECIAL 3 Watt Stereo Amplifier EDITION

Introductory Special

1st 50 pieces **\$2700.00**



Place your order now and receive an upgrade to the new KR Enterprise single plate 2A3 vacuum tubes - a \$550 value at no cost to you!

Call now or visit us on the web at [www.mothaudio.com](http://www.mothaudio.com)



Fax 323 464-9100 HOlywood 7-4300

**New** From the makers of Audio Gadgets™ and Tube CAD™

# SE Amp CAD™

Successful analysis of a single-ended amplifier output stage requires an accurate model of the tube's plate curves. True Curves™ is the new mathematical model used in GlassWare's latest program, SE Amp CAD. Because of its ability to trace the output tube's transfer function exactly, you can answer these questions (and more): 211, 845 or SV572? ...100, 120 or 140 mA? ...5,000, 7,000 or 10,000 ohm transformers? SE Amp CAD has a library of over 100 output transformers and 30 tubes and SE Amp CAD knows how these tubes *really* curve in a singled-ended amplifier.

For more information, please visit our web site or write us at:

## GLASSWARE

PO Box 2 Santa Cruz CA 95063 USA  
SalesSvc@tubecad.com

[www.tubecad.com](http://www.tubecad.com)

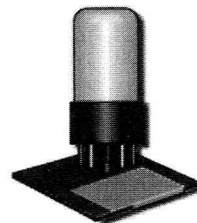

# SOUND PRACTICES

**"BEST LONG-TERM  
INVESTMENT I EVER MADE!"**

I was a bona fide hi-fi nut before I started reading *Sound Practices*, but I'm totally whacked out now!!

*says* **OMAR SMITH**  
Audio Experimenter, Des Moines, Iowa

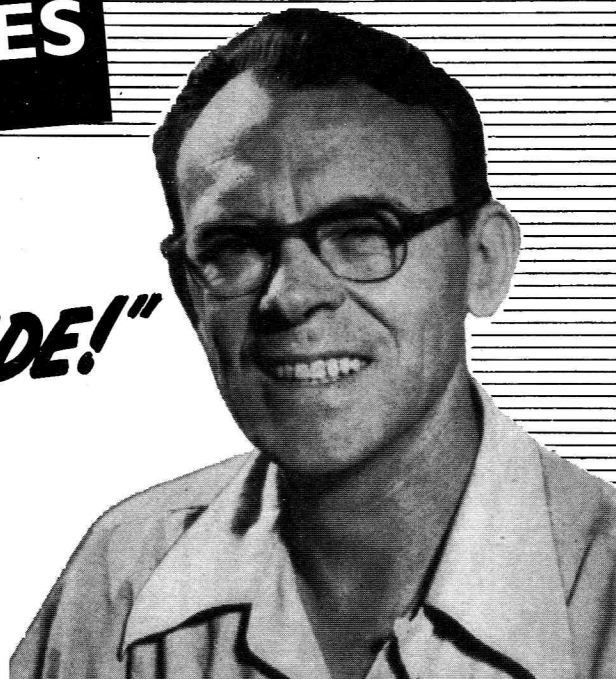

Take it from Omar and five thousand more of the most inspired and adventurous hi-fi nuts in the world today, once you enter the audio experimenter universe of *Sound Practices Magazine*, there's no going back to the mundane world of so-called "high-end audio" as most hobbyists know it.

More than just a flashy advertising medium like most conventional audio mags, *Sound Practices* focuses on the search for the musical truth as participants in this noble quest tell it in their own stories. *SP* content is diverse and various, but every article is written by a dedicated amateur author who really has something to share—no pro hacks whipping out incomprehensible two thousand word cable reviews the night before deadline for a monthly paycheck. It's the real thing. Serious but fun. The way it should be.

Stay up-to-date with leading edge approaches to vacuum-tube musical reproduction and enjoy the fellowship and inspiration of your comrades as the exploration continues. *Subscribe Today!*

## SOUND PRACTICES

The Audio Experimenter's Journal

PO Box 180562, Austin, TX 78718

voice: 512-467-0130 • fax 467-2341

e-mail: [info@soundpractices.com](mailto:info@soundpractices.com)

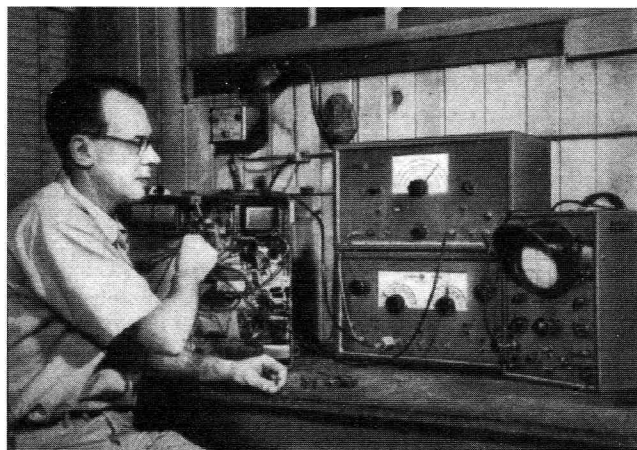

Omar sez—"Boys, you'll have to change your diapers after you hear this VCR I'm beefing up with silver foil caps and a battery-bias, choke-loaded triode output stage. Not only that but the picture is clearer too. Even my wife immediately noticed the difference!"

**Subscriptions:** \$24/1year/4 Issues US,  
\$28 Canada, \$34 Europe Airmail,  
\$39 Pacific Region Airmail

**Back Issues:** Issues 1, 2, 5, 6, 7, 8,  
11, 12, 13, 14, 15, and 16 currently  
in print. \$6 each in USA,  
\$7 Canada, \$7.50 Elsewhere

MC/Visa okay for payment. Please make  
all checks payable in US funds and drawn  
on a US bank. Money back guarantee.



# It's Like Music to Your Ears...

## Amperex Bugle Boy

audio tubes are back and they're better than ever!

When it comes to selecting premium audio tubes for your amplifier, accept no less than the best, Amperex Bugle Boy! Amperex Bugle Boy tubes are burned in under full load with all voltages applied for 24 hours before being tested for noise & microphonics. The aging racks used are from the original Amperex production line built in Holland decades ago.

Complete test results are supplied with each tube, including plate current, screen current, filament current, and total harmonic distortion (THD). The THD measurement is performed using one of the finest spectrum analyzers available – the Hewlett Packard 3561A. Matching in pairs, quartets & octets is available for all tube types.

Special test requirements? Not a problem. For a slight additional charge we will test and match to your specified operating conditions.

Types available: **6DJ8/ECC88**, **12AU7A/ECC82**, **12AX7A/ECC83** and many more!

So if you haven't dealt with a source capable of meeting your demands, call us at **1-800-TUBE USA** or **630-208-2200** today for information on additional products and the worldwide locations nearest to you. You'll like what you hear!

APD is pleased to announce the addition of **Hammond Manufacturing's** complete line of Classic Transformers and Enclosures to our product offering. Call today for a Hammond catalog or download it from our WEB site at [www.tubes-r-us.com/classic.html](http://www.tubes-r-us.com/classic.html).

**BLUENOTE** Midas Dampers are now available, along with other quality audio accessories - such as, equipment isolators and CD/LP treatments. The Midas Dampers (as reviewed in *Stereophile Magazine*, February, 1996) are made of the highest quality materials available. They reduce microphonics in your preamp tubes thereby enhancing the music you hear.

Call **1-800-TUBE USA** or **1-800-882-3872** today for your copy of our **NEW APD brochure featuring Audio Tubes, BLUENOTE and Hammond products .**

**APD** Audio Product Division

a division of Richardson Electronics, Ltd.

40W267 Keslinger Road  
P.O. Box 393  
LaFox, IL 60147-0393  
(630) 208-2200  
(800) 882-3872

**Richardson  
Electronics**

Engineered Solutions

You can also visit our Classic Components site on the Internet at:  
[www.tubes-r-us.com](http://www.tubes-r-us.com)

# VACUUM TUBE VALLEY

## Back Issues, Books, Goodies, & Subscriptions



**VTV #1 Spring 1995 \$8 US - \$10 Foreign**  
 Vintage Dynaco Tube Equipment - 1955-77  
 History and Testing of the 12AX7/ECC83 dual triode  
 Tube Testing Methods + Early Amplification and Amps

**VTV #2 Fall 1995 \$12 US - \$15 Foreign**  
 Heathkit - The Tube Williamson Years 1950-61  
 EL34/6CA7 History, Types and Tests  
 Magnum SE EL509 Amplifier Project by Dave Wolze  
 1927-34 Western Electric Theater Sound Systems

**VTV #3 Winter 1995/96 \$12 US - \$15 Foreign**  
 Eico Mono Tube Gear - 1955-62  
 Altec Lansing 604 Coaxial Loudspeaker History  
 Western Electric 300B History and Listening Tests  
 300B SE Transformer Listening Tests

**VTV #4 Spring 1996 \$12 US - \$15 Foreign**  
 6L6 History, Types and Listening Tests  
 Vintage Bookshelf Speakers 1955-1965  
 Early FM Broadcasting History  
 HK Citation I & II Amplifier History and Mods

**VTV #5 Fall 1996 \$12 US - \$15 Foreign**  
 The Ultimate FM Tuner Shoot Out  
 Red Bank Guided Missile Tubes for Hi-Fi  
 The Birth of the Marantz 10B  
 Choosing Rectifier Tubes for your Guitar Amplifier

**VTV #6 Winter 1997 \$12 US - \$15 Foreign**  
 Fisher 500 - History, Models and Restoration  
 A Tribute to Avery Fisher by the Fisher Doctor  
 6550 and KT88 History, Types and Listening Tests  
 Loftin-White Amplifier History by Alan Douglas

**VTV #7 Summer 1997 \$12 US - \$15 Foreign**  
 6DJ8 & Frame Grid Tubes + Listening Tests  
 Altec 1950s Theater Amps and Modifications  
 The Great Voice - The Peter Jensen Story  
 Computing with Tubes - The Savage Art  
 Uncle Eric's Tube Dumpster - 417A/5842

**VTV #8 Fall 1997 \$12 US - \$15 Foreign**  
 EL84 History, Types & Listening Tests  
 RCA Tube Mfg at Harrison, New Jersey  
 200 watt OTL Amp Project by Allan Kimmel  
 300B Listening Tests: NOS and Vintage Types  
 Bruce Moore Tube Audio Pioneer

**Vintage Hi-Fi Spotter's Guide-Volume 1**  
 Over 450 photos & specifications of tube audio gear  
 from the Golden Age of Hi Fi. 86 pp. \$18.95

**Vintage Hi-Fi Spotter's Guide Volume 2**  
 Volume 2 covers equipment not listed in Volume 1.  
 Almost 500 amps, preamps, tuners, etc are depicted.  
 Edition covers early audio and includes a Speaker section  
 with most vintage manufacturers. 88 pp. \$18.95

**Vintage Hi-Fi and Pro Audio Price Guide**  
 Updated price & grading guide for almost 1,000 vintage  
 hi fi amps, preamps and tuners. Includes Vintage pro  
 audio and theater gear. Also, pro loudspeakers, N.O.S.  
 vacuum tubes and audio transformers. \$30.00

**"Vintage Hi-Fi The Golden Era Video"**  
 A one-of-a kind video covering the classic post-war and  
 1950s home hi fi era. Over 80 classic audio amps, pre-  
 amps tuners, are shown. This video is professionally pro-  
 duced. 34 min VHS NTSC \$25.00

**The Ultimate Tube Substitution Guide**  
 No tube electronics enthusiast should be without this  
 book. Over 10,000 tubes are listed on 240 pages includ-  
 ing: audio, radio, transmitting, and special. Features an  
 audio tube section with tube evaluation. \$29.95



**Vacuum Tube Valley T-Shirts**  
**Two Styles to Choose From!**

**A) VTV Marching Tubes - "Big Tone"**  
 1 sided available in several colors.  
 Tan, Sea Foam Green, and Burgundy \$15.00 XL only



**B) VTV Tube Sunburst Shirt** with 2-color black & orange  
 art as pictured plus large 2-color RCA tube diagram  
 exploded view on back. (white or gray) \$20.00 XL only

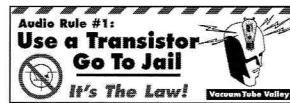

**VTV Politically Correct Bumper Sticker**  
 two-color waterproof vinyl 2 1/2 x 10"  
 Sent post-paid: \$3.50 US - \$4.50 Foreign

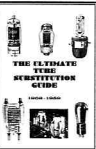
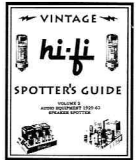

### Quotes from VTV Subscribers:

"The best audio mag on the planet." "Clearly written with great photographs."  
 "A wealth of vacuum tube information." "VTV reads with authority and truth..."

### ORDER FORM

Name \_\_\_\_\_ Date \_\_\_\_\_

Address \_\_\_\_\_

City \_\_\_\_\_ State \_\_\_\_\_ Zip \_\_\_\_\_

Please Send Me The Following Products

\_\_\_\_\_ \$ \_\_\_\_\_

\_\_\_\_\_ \$ \_\_\_\_\_

\_\_\_\_\_ \$ \_\_\_\_\_

\_\_\_\_\_ \$ \_\_\_\_\_

\_\_\_\_\_ \$ \_\_\_\_\_

\_\_\_\_\_ \$ \_\_\_\_\_

Signature \_\_\_\_\_

Add \$5.00 Shipping per order in USA / Add \$10.00- Item Air Mail Foreign Shipping

CA Residents Add 7.75% State Sales Tax

Credit Cards, U.S. Bank Checks or Money Orders OK

Credit Card # \_\_\_\_\_

**TOTAL ORDER**

Exp. Date \_\_\_\_\_

**Subscribe To Vacuum Tube Valley**  
**The Classic Electronics Journal**

\$36/year US - 4 issues \$43/Canada,  
 \$56/Europe & \$66/Asia & World

**Vacuum Tube Valley**

P.O. Box 691

Belmont, California 94002 USA

Phone (650) 631-6550 FAX (650) 654-2065

email - triode@vacuumtube.com

**www.vacuumtube.com**

# A LEGEND REBORN!

Enlarged, heavy gauge figured glass bottle handles higher temperatures, improving performance at higher power levels.

Extra thick premium quality star mica spacers (top and Bottom) improves performance stability and reduces adverse microphonics.

Precisely tensioned filaments for better mechanical stability and reduced adverse microphonics.

Deep swaged heavy grid rods made from pure copper provide improved mechanical support for grid windings.

Brite nickel beam focusing electrode concentrates the electron flow precisely on the plate for improved power output.

Heavy duty plates made from a special alloy are stiffened with ridges and coated for strength and durability.

Enlarged phenolic base provides excellent contact with glass envelope and insulation, preventing shorting between critical components.

All specifications equal or exceed the original Genelex Gold Lion KT66 standards.

## THE GT-KT66



Groove Tubes... *The American Tube Company, since 1979.*

12866 Foothill Blvd., Sylmar California 91342 USA  
Tel: (818) 361-4500 • Fax: (818) 365-9884 • [www.groovetubes.com](http://www.groovetubes.com)

The legendary British made KT66 is one of the most famous tubes of all time. In the 60's it powered other British legends like Quad Hi Fi amps and the first Marshall guitar amps. This tube was the sound of Eric Clapton on the classic John Mayall Bluesbreakers album.

If you can even find an original KT66 today, they'll set you back up to \$300 apiece.

Groove Tubes has given new life to this legend, creating our own tooling to manufacture it again. We were able to keep the sound and improve on the tube in satisfying ways.

With our precision tooling and modern manufacturing processes, we consistently hold tolerances the 60's original could never attain. Insights from our research allows us to control musical parameters no other tube maker even knows about.

Groove Tubes is offering Performance Matched Duets of the GT-KT66R @ \$120 (U.S. retail price).



# Purveyors of "Classic" Transformers & Enclosures

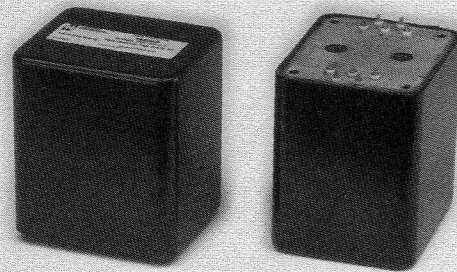
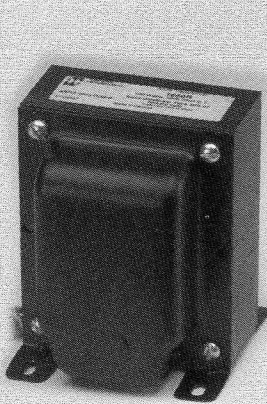

*Single Ended, Push-Pull  
and Potted Tube Output  
Transformers*

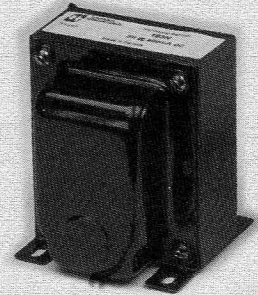

*Filter Chokes*

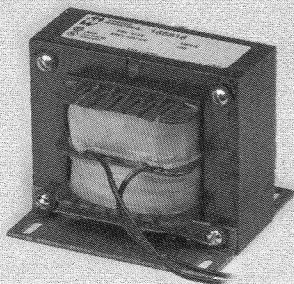

*Open & Enclosed  
Filament Transformers*

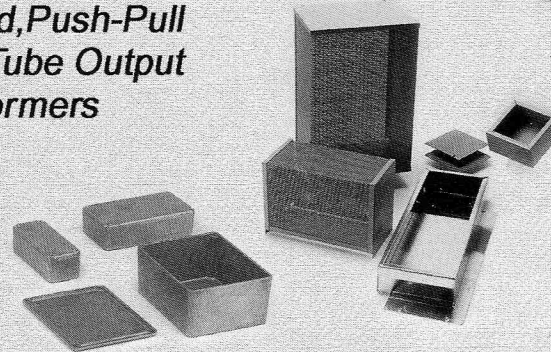

*Aluminum & Steel Chassis  
and Diecast Aluminum  
Enclosures*

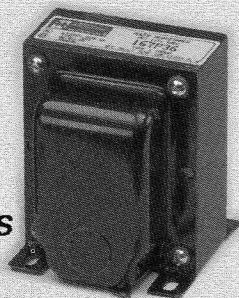

*High Voltage Plate  
Transformers*

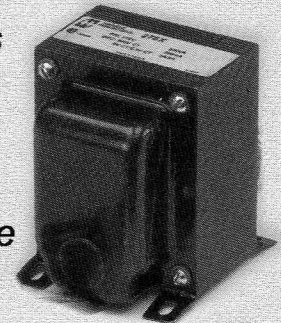

*Contact us for a free catalog & list of stocking distributors*

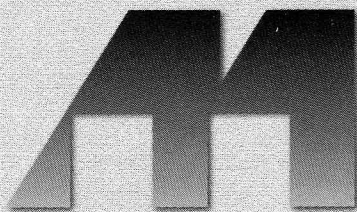

# HAMMOND MANUFACTURING™

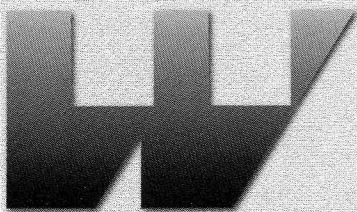

4700 Genesee St. - Cheektowaga, NY 14225 USA  
Phone: (716) 631-5700 Fax: (716) 631-1156  
394 Edinburgh Rd., N. - Guelph, Ontario N1H 1E5 Canada  
Phone: (519) 822-2960 Fax: (519) 822-0715

[www.hammondmfg.com](http://www.hammondmfg.com)



Products by:

- Allen Bradley
- Alps
- Caddock
- CAIG Labs
- Cardas
- DH Labs
- Elna Cerafine
- Hammond
- Holco
- Hovland MusiCaps
- Hubble
- Jensen
- Kimber Kable
- KR Enterprise
- LCR Caps
- Lowther
- Magnequest
- Mills
- MultiCap
- Neutrik
- Noble
- PFT Chassis
- Ram Labs
- Roederstein
- Solen
- Sorbothane
- Sovtek
- Svetlana
- Tesla
- Vampire
- WBT
- Wima
- and many more...

 **Welborne Labs**

P.O. Box 260198 Littleton, CO 80126 USA  
tel: 303.470.6585 fax: 303.791.5783

e-mail: wlabs@ix.netcom.com

website: <http://www.welbornelabs.com>

Celebrating our 10th Anniversary 1988 - 1998

Our 1998 Catalog & Design Manual is now available featuring tons of kits, parts, books, software, schematics, fun projects and the usual info. It's just \$12 U.S. and Canada, \$18 International, refundable. Visa and Mastercard Welcome.

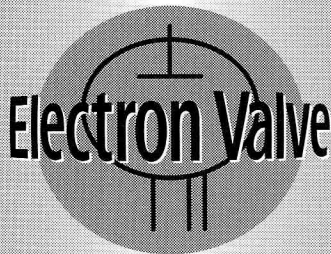

**Your source for hard to find  
Vintage Audio Tubes  
and Quality Vacuum Tube  
Audio Components**

Stop by our website to see a detailed look at all of our products!  
[www.electron-valve.com](http://www.electron-valve.com) • Email: [info@electron-valve.com](mailto:info@electron-valve.com)  
Phone: 901-382-9955 • Fax: 901-382-9956

**W**e are a proud dealer of **Western Electric** Audio Products.  
The current production 300B is now in stock.



Electron Valve stocks a wide array of **NOS** Vintage Audio Tubes like Mullard EL34, RCA 2A3, and Mullard 5AR4. We also have a good stock of Old Production Western Electric tubes such as

205B/D, 252A, 274B, 300B and many others.

Electron Valve carries Precision Tested Ram Labs Reference Tubes. These tubes are computer tested, graded and matched to ultra high specifications predetermined by Roger A. Modjeski.

We also carry the Music Reference **MR** RM-10 (Push-Pull 6BQ5, 35W/Side) Stereo Amplifier and the Music Reference RM-200 (Push-Pull 6550, 100W/Side) Stereo Amplifier.

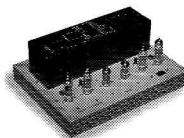



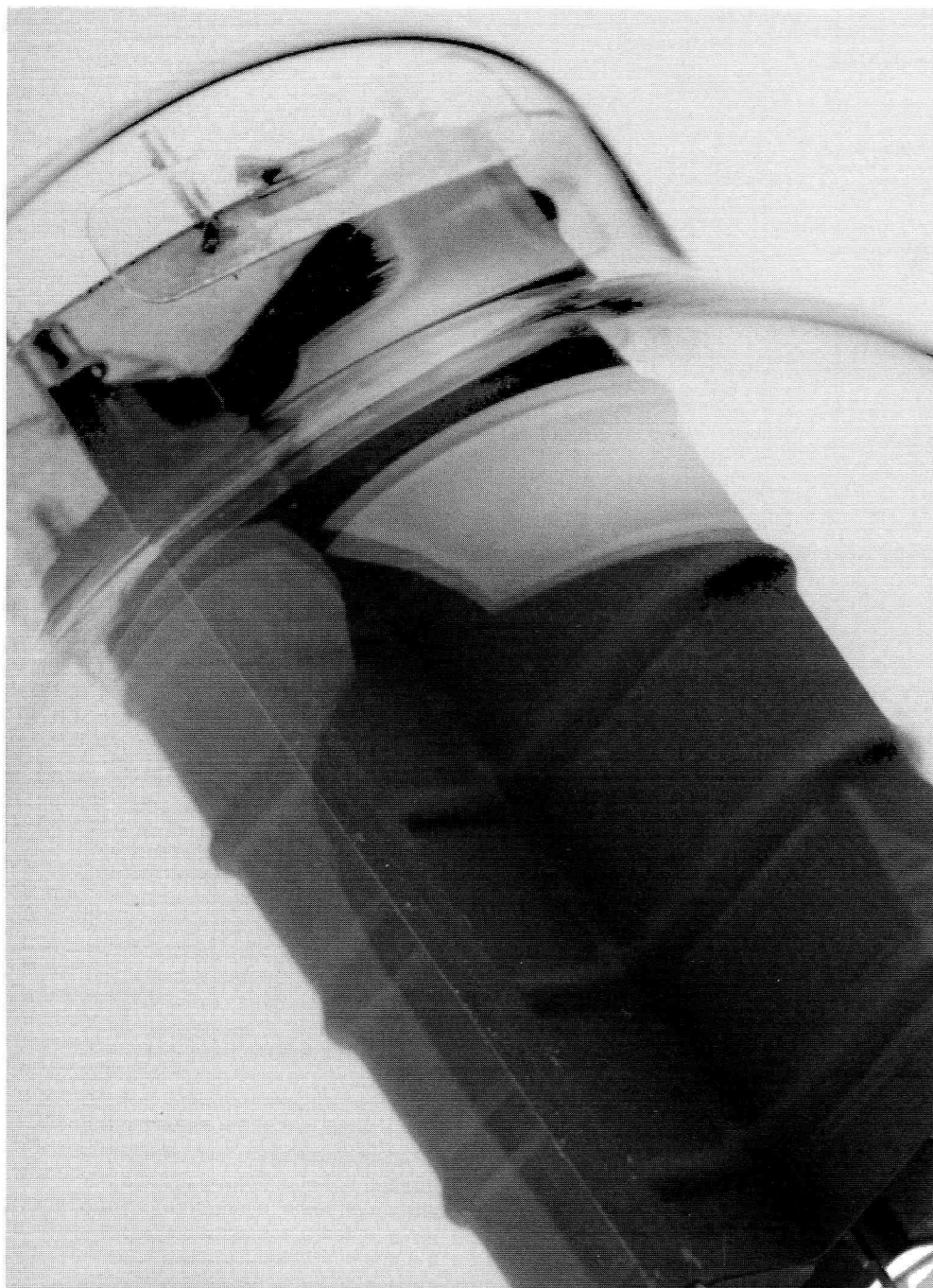

**Svetlana**  
ELECTRON DEVICES

*They made it first but  
we made it affordable!*

*Svetlana is proud to introduce the SV300B power triode. Recreating the tonal qualities of the original, the SV300B sets a new standard of excellence. It is manufactured in Russia under Svetlana's stringent quality control and offers ultimate sound and appearance without the high price of the original. The SV300B is tested at the factory and matched into pairs, ensuring optimal performance and durability.*

# SV300B

*For an early review of the Svetlana SV300Bs sound, see Vacuum Tube Valley magazine, issue 8, page 22-23.*

Copyright 1998. Svetlana Electron Devices, Inc. All rights reserved.

8200 S. Memorial Parkway  
Huntsville, AL 35802  
256-882-1344 • Fax: 256-880-8077

3000 Alpine Road  
Portola Valley, CA 94028  
650-233-0429 • Fax: 650-233-0439

[www.svetlana.com](http://www.svetlana.com)



Though **Heath-kits**, **Knight-kits** and **Eico-kits** are gone...  
 still the Incredible Sound of the 50's is back!



Model A-8

# Easy-to-build Tube Hi-Fi Stereo Kits Made In USA

Model	Description	Assembled each	Kit each	Chrome add-on
A-1	Amplifier 10 Watt Mono Block, 2 x EL-84 P-P	\$ 299	\$ 229	\$ 60
A-2	Amplifier 10 Watt Stereo, 4 x EL-84 P-P	\$ 435	\$ 349	\$ 80
A-4	Amplifier 30 Watt Stero, 4 x EL-34 P-P	\$ 559	\$ 449	\$ 95
A-8	Amplifier 80 Watt Mono Block, 2 x 6146B P-P	\$ 1195	\$ 995	\$ 120
PP-1	Phono Pre-Amp, Stereo with Gain control, 40dB gain	\$ 439	\$ 329	\$ 50
PP-2	Phone Pre-Amp, Stereo with Gain control, 60dB gain	\$ 525	\$ 395	\$ 60
PA-1	Line Pre-Amp, Stereo with Gain, Balance, Treble, Bass	\$ 699	\$ 579	\$ N/A
PA-2	Line Pre-Amp, Stereo with Gain, Balance, 5 inputs	\$ 625	\$ 499	\$ N/A
PA-12	P/A Amplifier 12 Watt Mono, with paging microphone	\$ 389	\$ 299	\$ 60

Prices for protective cages: A-1 & PA-12 = \$39, A-2 = \$77, A-4 = \$89, A-8 = \$99, PP-2 = \$45

Call for your free Catalog now!

Many Models: Amplifiers \* Preamplifiers \* Phono Preamps  
 Documentation: Complete easy step-by-step Assembly Manual

**ASUSA-Kit**

6717 NE 181<sup>st</sup> Street, Seattle, WA 98155 USA Phone 425-481-8866 Fax 425-485-3836

E-Mail: franklab@ix.netcom.com

**Western Electric®**  
High Fidelity

**WE300B**

**The Standard In  
Quality and  
Long Life**



**Matched Pair WE300B**

Western Electric High Fidelity products are marketed worldwide by Westrex Corporation. Western Electric is a trademark of Lucent Technologies Inc., formerly AT&T Technologies, Inc., licensed to Westrex Corp., a company independent of Lucent. Developments of Bell Laboratories. Western Electric High Fidelity products are manufactured in the U.S.A.

**Western Electric Audio Products**

1230 Peachtree Street • Suite 3750 • Atlanta, GA 30309-3575 • (404) 874-4400 fax (404) 874-4415  
e-mail: sales@westernelectric.com • internet: www.westernelectric.com





# TUBES-PARTS-BOOKS-SUPPLIES

(602) 820.5411 FAX (800) 706.6789

FIND EVERYTHING YOU NEED  
BUY IT FOR A SONG.

*Where can I find a 6V6  
replacement tube?*



**C**all or fax today for our new 60 page FREE catalog of vintage tubes, hard to find parts, books and supplies. We have everything you need to build new or repair classic audio equipment at prices you haven't seen in decades.

6221 SOUTH MAPLE AVENUE  
TEMPE, AZ U.S.A. 85283

VISIT OUR WEBSITE AT [WWW.TUBESANDMORE.COM](http://WWW.TUBESANDMORE.COM)

