

# VACUUM TUBE VALLEY™

Issue 12  
Summer 1999

The Classic Electronics Reference Journal

Published Quarterly  
Price \$9.00

## 2A3 - The Mother of High Fidelity

### SE 2A3 Amp Comparison

Sweetest Watts on the Planet



### Bookshelf Speaker Shootout

Best Sounds for PP and SE Amps



### Allen Guitar Amp Kits

An Affordable Boutique Amp

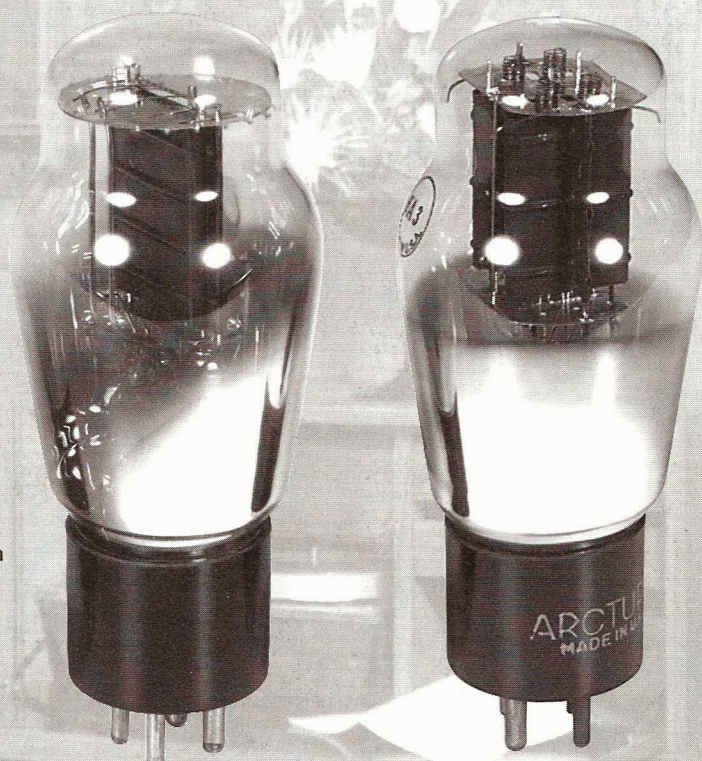

## The Scott 299

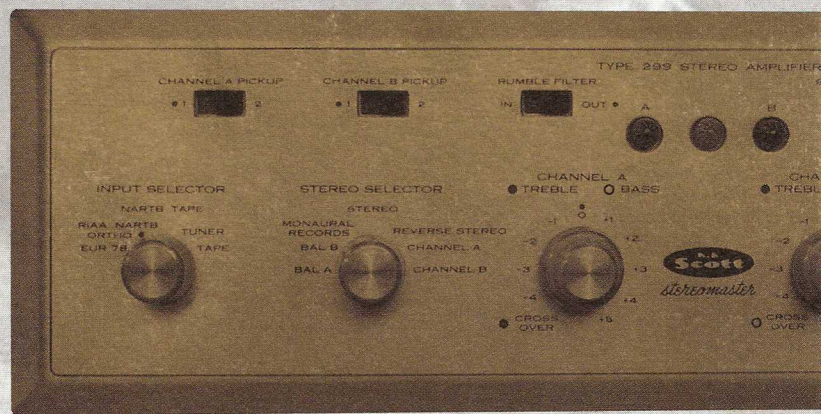

[www.vacuumtube.com](http://www.vacuumtube.com)

ISSUE 12

THE SCOTT

# VACUUM TUBE VALLEY

P.O. Box 691, Belmont, CA 94002 USA  
(650) 631-6550 Phone (650) 654-2065 FAX  
<http://www.vacuumtube.com>

February 17, 1999

Mike Matthews  
Sovtek/New Sensor Corporation  
NYC, NY

Dear Mike,

Thanks again for sending us the new 12AX7LP tubes for evaluation. VTV conducted both listening and electrical tests on the tube.

John Atwood, VTV Tech Editor, took the 12AX7LPs to his One Electron Laboratory and used a Tektronix 570 curve tracer to evaluate the tube's electrical characteristics. John noted that the tube is very linear and has great looking curves, indicating a well-made tube. Compared to the Sovtek 12AX7s of the past, he felt that your new tube is significantly better. In fact, John commented that its quality approaches the famed Telefunken ECC83 smooth plate.

Next, we gave the 12AX7LPs to Roger Coon, a well-known record collector and a major audiophile in the San Francisco Bay Area. Roger is a very critical listener and has "golden ears," plus, he recently completed a 12AX7 listening test for a future issue of VTV. He notes: "large, full soundstage, very musical with nice detail." He compared it to the sound of a Mullard CV4004 box plate 12AX7, but not quite as detailed. In short, Roger was impressed with your tube.

Then I listened to the 12AX7LP in a variety of tube preamplifiers and amplifiers. You have a very musical, smooth and involving tube. It is easy to listen to for long periods of time, like a quality tube should be. This will be a great tube for both hi-fi and guitar amp applications. I think it sounds a lot like a vintage Brimar 12AX7.

Compared to anything else out there in the 12AX7 market, with the exception of some primo NOS stuff, I feel that the Sovtek 12AX7LP is the best sounding one on the market at this time. In conclusion, you have a winner here!

Thanks again and best regards.

Vacuum Tube Valley  
*Charlie Kiffeson*  
Editor of VTV

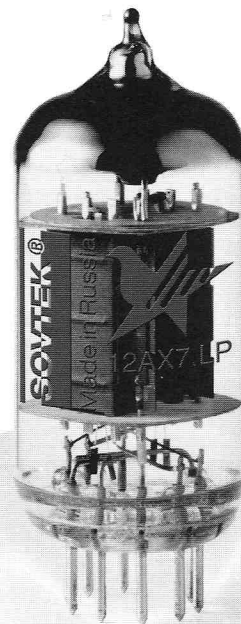

## NEW SENSOR CORPORATION

20 COOPER SQUARE NEW YORK CITY, NY 10003

FAX (212) 529-0486 INFO@SOVTEK.COM WWW.SOVTEK.COM

**VTV Issue # 12  
Table of Contents:**

**2A3 Mother of Hi-Fi.....4**  
**SE 2A3 Amps & Listening....8**  
**Allen Guitar Amp Kit.....10**  
**Impedance Measurement..13**  
**Bookshelf Speaker Test.....15**  
**Guitar Amp Book Review..18**  
**H.H. Scott 299 Amplifiers..19**  
**300B PP Amp Project.....25**  
**Dumpster Rectifiers.....30**  
**300 Watt SV572 Amp.....31**

**Coming In the Next  
Issue of VTV:**

- **6L6 Shootout**
- **Exclusive Interview with David Hafler of Dynaco**
- **2A3 Push-Pull Amp Project**
- **H.H. Scott 222, 222B, 222C, 222D and LK-48 Integrated Amplifiers**
- **Review of AS-USA Single-Ended EL84 Kit**
- **And, a lot more stuff!**

**Get Your VTV Faster**

We are now offering US subscribers to VTV an option to have their issues sent by **First Class** mail. Generally, **First Class** arrives at your location in one to five days. Since Issue #11, we have been using 3rd Class bulk mail to send the issues to US subscribers. Bulk rate mailings can take from **2 to 8 weeks**, depending on your local and regional post office.

For new or renewing subscribers, the **First Class mailing option is \$9 additional per year for a total of \$45**. If you are an existing subscriber and your mailing label says for example #14, send us a check or cash for \$2.50 for each issue you have coming (\$5.00 in this case). **Do not use credit cards for the First Class upgrade please! Send either money order or checks only.**

This notice does not apply to foreign subscribers who already get their issues by First Class Air Mail.

**Antique Electronic Supply to begin manufacturing FP Mallory Capacitors**

Aerovox, Incorporated announces the sale of their FP high voltage can capacitor line to CE Manufacturing, LLC. With the transfer of FP type can capacitor manufacturing equipment, much of it originally built by Mallory, the inventors of the FP type to CE Manufacturing, LLC, OEMs can be assured of a quality American-made product without fear of obsolescence. These capacitors are especially applicable to new designs in the growing market of vacuum tube audio and musical instrument amplifiers. In addition, there is an established market for replacement and restoration of older consumer and industrial electronic equipment.

CE Manufacturing, LLC is a division of Campanella Enterprises, Limited Partnership which also owns Antique Electronic Supply, LLC and CE Distribution, LLC. Volume sales of the FP can capacitors to OEMs, dealers and distributors will be through CE Distribution

and sales to end-users will be through Antique Electronic Supply available sometime in October 1999. For further information contact: CE Manufacturing, 6221 South Maple Avenue, Tempe, Arizona 85283. Phone: (480) 755-4712 or FAX (480) 820-4643

**Jack Mullin, a key figure in AMPEX tape recorder development, passes**

John (Jack) Mullin, an instrumental figure in the invention of the original AMPEX magnetic tape recorder, left this world peacefully on June 24, 1999 at his home in Camarillo, California. Mr. Mullin was the first American to recover a and evaluate a German-made Telefunken Magnetophone magnetic paper tape recorder at the close of World War II. This important technology was shared, advanced and developed in an association with AMPEX manufacturing and the popular film and recording star Bing Crosby in the late 1940s.

**1999-2000 Collector Tube Catalog**

A new tube catalog with a full-color cover showing a composite of 48 collector tubes is now available. Copies may be requested by phone, mail or e-mail. For further information contact: George H. Fathauer, 688 West First St., Ste. 4, Tempe, AZ 85281 (480) 968-7686 [www.fathauer.com](http://www.fathauer.com)

**METASONIX Introduces a Vacuum Tube Synthesizer**

The first of its type in the world, Metasonix has introduced an all vacuum tube, MIDI compatible music synthesizer. This unique device is intended for special sound effects in film and video, recording studios, amateur musical enthusiasts and live performance applications. The instrument is called "Phattytron" Model PT-1. It is monophonic and is extremely analog. Suggested retail price is \$2400US. A demo CD is available for \$5.00. Contact: METASONIX, 801 Woodside Road, Suite 14-247, Redwood City, California 94061 USA [www.metasonix.com](http://www.metasonix.com)

**EDITORIAL STAFF**

- Charles Kittleson** - Publisher
- John Atwood** - Technical Editor
- Eric Barbour** - Senior Editor
- Terry Buddingh** - Guitar Editor
- Steve Parr** - Art Director
- Julie P. Werner** - Copy Editor
- Website** - [www.vacuumtube.com](http://www.vacuumtube.com)

*Vacuum Tube Valley* is published quarterly for electronic enthusiasts interested in the colorful past, present and future of vacuum tube electronics.

Subscription Rate: US\$36/4 issues 3rd Class-\$45 1st Class; Canada/\$48; Asia/\$66; Europe/\$56

**US Bank Check, Credit Cards or Cash are accepted for payment.**

**Phone - (650) 631 - 6550  
FAX - (650) 654 - 2065**

Copyright 1999 **Vacuum Tube Valley™** and **Big Tone™** All rights reserved.

No part of this publication may be reprinted or otherwise reproduced without written permission of the publisher.

Send circulation and editorial correspondence to:

**Vacuum Tube Valley**  
P.O. Box 691,  
Belmont, California 94002 USA  
e-mail [triode@vacuumtube.com](mailto:triode@vacuumtube.com)

**ISSN # 1095-4805**

# 2A3: Mother of High Fidelity

By Eric Barbour ©1999 All Rights Reserved

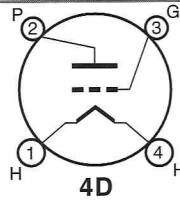

ments were wired in parallel. This gave the tube an excellent emission profile--the many small wires behaved almost exactly like a flat plane of emissive material. The specialized mechanical skills required to build this structure were considerable.

In 1930, radio engineers wanted to build audio amplifiers with more power output than could be obtained with existing triodes using a 300-volt supply. This voltage limit was roughly set by the cost of available radio-set power transformers and electrolytic capacitors. The already-popular type 45 tube was too small for this configuration, requiring four or six 45 tubes to produce a clean 10 watts into a speaker. And the type 50 tube needed a higher voltage supply and a higher primary impedance on the output transformer--meaning, more cost. The type 10 tube, though reasonably priced, was even worse, needing a very high plate load impedance. Other triodes were either too small or too large and power-hungry.

Ten watts was regarded as the minimum requirement for a large "deluxe" console radio, using the open-baffle speakers of the era. Pentodes were available, but added more distortion than the engineers liked. Using feedback to cancel the distortion was virtually unknown before 1935. So, again all the requirements came back to economic issues.

All of the filamentary triodes of the period were made with the same filament support method -- the lower ends were welded to electrical lead-ins. The upper folds were supported by small wire hooks. Careful selection of the wire used in the hooks, and careful adjustment by the assembler before the anode assembly was inserted into the envelope, allowed the filament to expand and contract through many heat-cool cycles without breaking or touching the tube's grid. This was more art than science, and the brittleness of the nickel-iron-tungsten wire inside the filament exacerbated the problem. Such fine wire is often made of successive single crystals, with a tendency to fracture along crystal divisions.

It is thought that an unnamed Westinghouse engineer devised the "harp" filament structure in the mid-1920s, for use in large transmitting triodes. Many folds of the filament were passed over a stiff, notched wire. It was then suspended from the top mica by a pair of small coil springs. This was easier

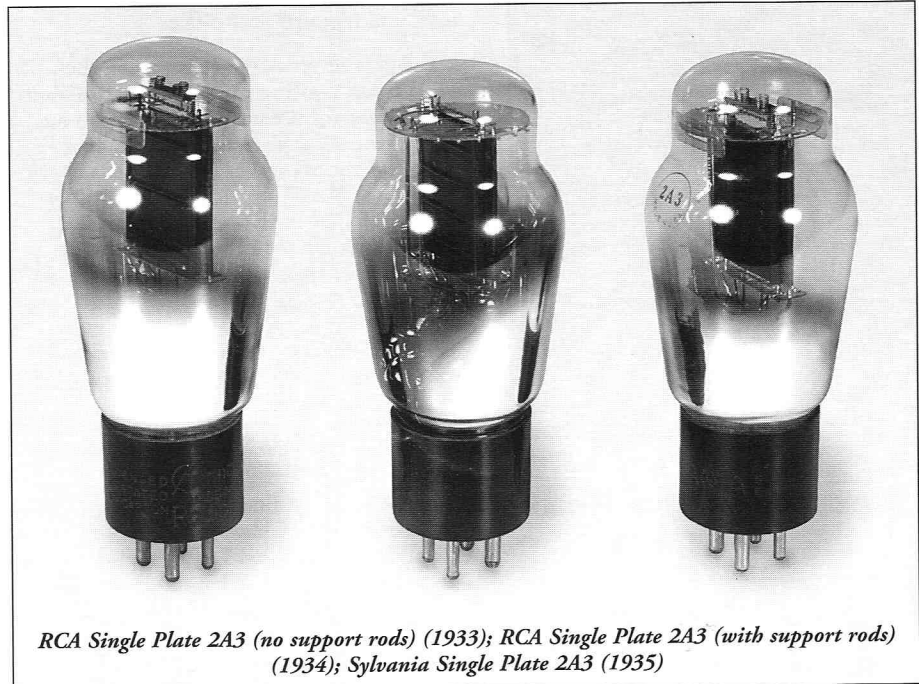

RCA Single Plate 2A3 (no support rods) (1933); RCA Single Plate 2A3 (with support rods) (1934); Sylvania Single Plate 2A3 (1935)

to install, requiring less skill on the part of tube assemblers, as well as giving more uniform electron emission.

Many engineers of the period were very fond of the Class B push-pull output stage, most notably, L. E. Barton of RCA. These adherents championed the use of tubes intended for Class B, such as the 2B6 and the 19. Yet they had only a passing effect on common engineering practice of the day. Most radio-set designers used pentodes (41, 47) or tetrodes (48) for applications requiring efficiency, and 45s or 50s for top-level models.

RCA decided to come out with a triode which worked on the same voltages as the 45, yet gave about twice the power. Thus was born the 2A3 (developmental number A181C, introduced January 10, 1933). Despite being intended as a low-cost tube for a new thing called "high fidelity" sound amplification, the original 2A3 had a very complex harp filament, consisting of 24 short segments in parallel.

The tungsten wire was ridiculously fine, and it had to be, since all the seg-

Only during the Great Depression could such a tube have been made in the USA. It was so difficult that RCA engineers scaled it back to 20 segments in late 1932, before the tube was even introduced. Even more ironically, 2A3s hardly rated a mention in magazines of the period, while many more RCA advertising dollars were spent promoting pentodes like the 2A5. Nearly all of the major tube distributors and manufacturers sold a single-plate 2A3. Some of these included GE, Sylvania, Tung-Sol, Arcturus, even National Union.

Unfortunately, by February 1936 RCA had replaced the single-plate with a structure having two smaller 45-like triodes wired in parallel. Their "W" filament arrangement was similar to the 45 and involved less labor and less cost. There are 2A3 lovers who claim that this was a step backward, and that the single-plate had superior distortion characteristics. Possible, though our distortion tests of old 2A3s of both types were unable to confirm this. It didn't help that the new double-plate tubes had higher internal capacitances, a fact not reflected on data sheets published after 1935.

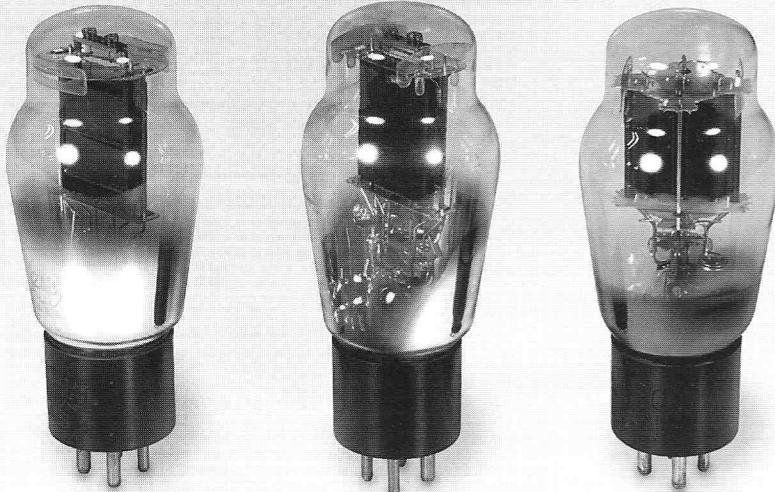

*National Union Single-Plate 2A3 (1934); Arcturus Single-Plate 2A3 (1934); Raytheon Triple Triode 2A3H (1936)*

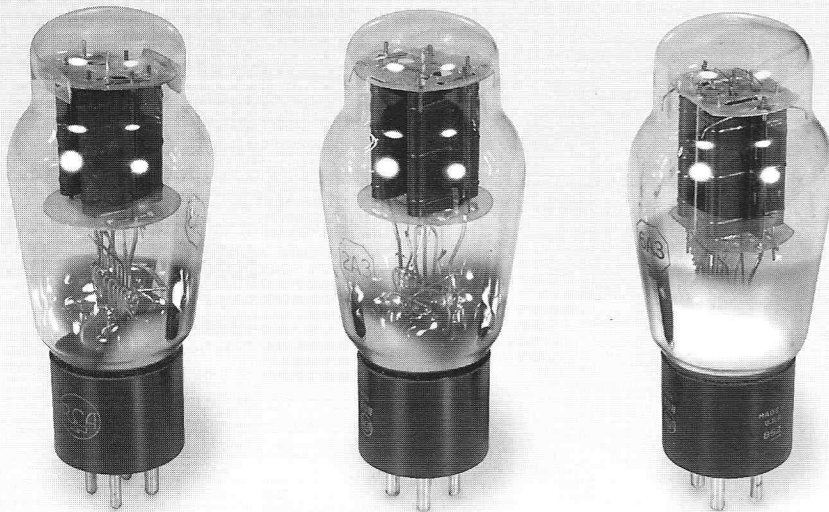

*RCA Bi-Plate 2A3 (1940s); RCA Bi-Plate 2A3 (late 1940s); RCA Bi-Plate 6A3 (1940s)*

Raytheon's "Four Pillar" 2A3H, produced in 1936, was an oddity. The original version had three small triode structures and indirect heating; its filament consumed 2.8 amps instead of the specified 2.5 amps. Later, Raytheon switched to a more conventional double-plate structure. National Union is believed to have also made a 2A3H.

About the same time as RCA's introduction, Western Electric introduced their most 2A3-like tube, the 275A. It was seen

only in WE industrial audio amplifiers and a few other WE products. In what

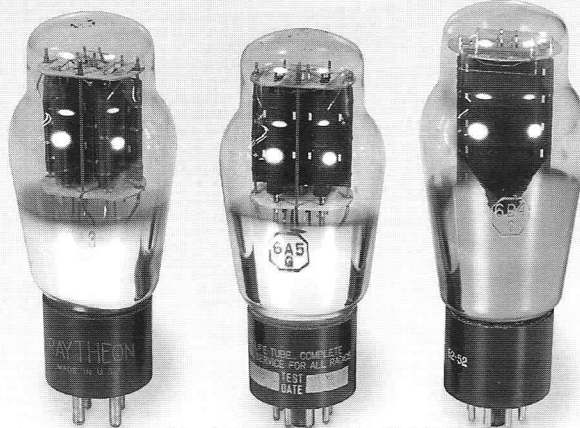

*Raytheon 6A3 (1940s); Sylvania 6A5G (1940s); Union Tube Company Single Plate 6B4 (1940s)*

seems to be an amusing contradiction, the US Military contracted with Sylvania in 1948 to produce a ruggedized version of the notoriously fragile 2A3. This resulted in the creation of the 2A3W, also known as the type 5930.

2A3s were used as the output tubes in the majority of large, expensive console radios of the mid-1930s. In 1935, Stromberg-Carlson offered a huge hotel lobby radio featuring a quad of 2A3s. E. H. Scott was especially fond of 2A3s, starting with their Allwave 15 in 1934 and the Allwave 23 in 1935 and 36. Scott's monstrous 48-tube Quaranta (1935) used twelve 2A3s in push-pull biamped circuits. (See VTV #3 for a complete article on the Scott Quaranta). McMurdo Silver used 2A3s in the Masterpiece II (1934), but preferred Class B operation in later models. The 2A3 had a good life because none of these radios used negative feedback to reduce distortion, and all the alternatives sounded worse.

In 1935, RCA offered the model D-22, a high quality "home hi-fi" radio-phono console with push-pull 2A3s. Many of the early audio and phono "hi-fi" amp circuits of the period were developed by transformer manufacturers such as Amertran, Jefferson, Stancor, Thordarson and UTC. Lots of public address and small theater amplifiers using the 2A3 were made by Auburn, PAM, Lafayette and RCA. Juke box manufacturers, including Mills Novelty, Seeburg and Wurlitzer, used 2A3 based power amplifiers from 1934 through 1939. Hammond organs used a quad of 2A3s in their tone cabinets from 1935 through 1940.

With six-volt tubes becoming popular during the mid-1930s, the 6A3 was created. It was internally the same as the dual-section 2A3, but with a thinner filament allowing it to run at 6.3V at 1 amp. By the late 1930s a "glass-octal" version, the 6B4G, was introduced that was electrically the same as the 6A3. Its pin connections were cleverly arranged so that it could substitute for a 6L6 if the cathode was connected to the filament supply. This physical interchangeability was cited by regulated power supply designers.

When operated in single-ended mode, the 6A3 and 6B4G produced too much filament hum to be used in high-fidelity applications. This was not an issue for the power-supply designers, but for the audio users a special version of the 6B4G was developed - the 6A5G. It had tiny cathode sleeves around the filaments. This

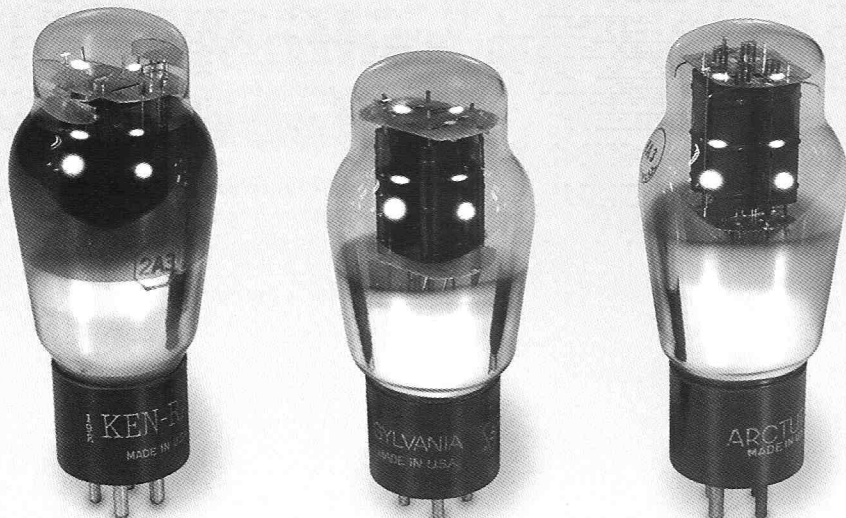

*Ken-Rad Bi-Plate 2A3 (1940s); Sylvania Bi-Plate 2A3 (1940s); Arcturus Bi-Plate 2A3 (1938)*

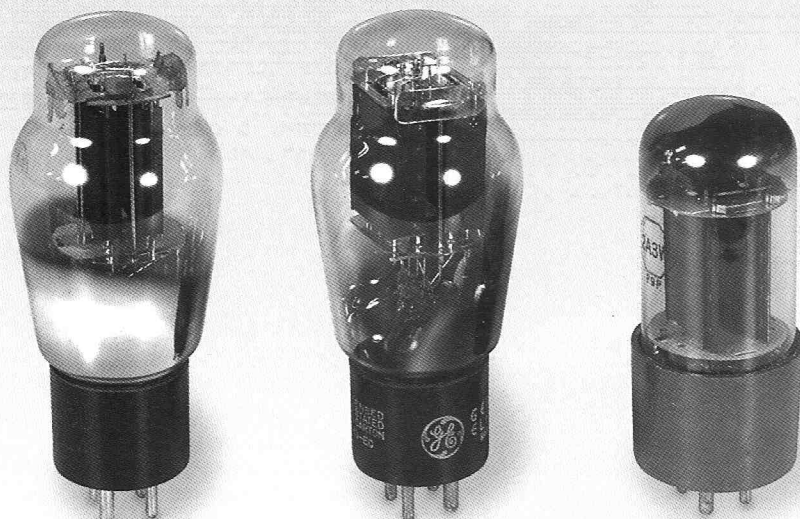

*Tung-Sol Bi-Plate 2A3 (1940s); GE Box Bi-Plate 2A3 (1940s); Sylvania 5930/2A3W (1940s)*

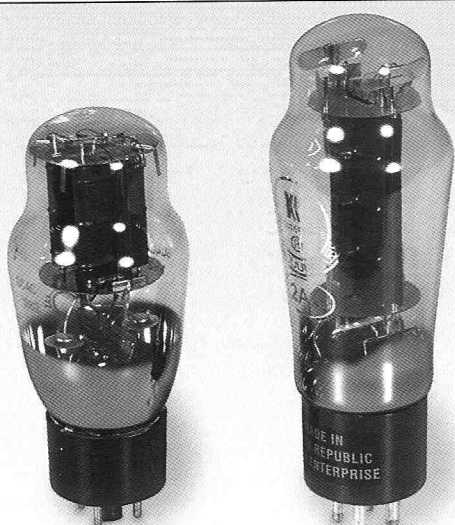

*Svetlana 6B4G (1982); KR2A3 (1990s)*

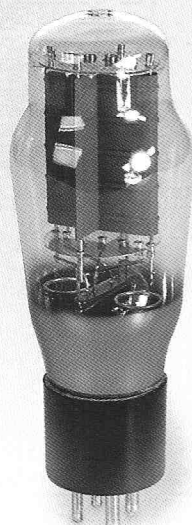

*New Sovtek (Russian) Single Plate 2A3*

cathode was connected to the center-tap of the filament as well as being brought out to pin 8. This odd hybrid cut the hum substantially, but was probably too obscure and expensive to become widely used.

During World War II, the 2A3 and its relative, the 6B4G, were the most common pass elements in regulated power supplies. This latter fact kept the production of such "primitive" triodes going well after 1945, since the U.S. military is notoriously slow to replace equipment which serves a purpose well.

The 2A3 got a new lease on life with the post-war hi-fi craze. The Brook 10 and 12 series of amplifiers were the best-known high fidelity products to use 2A3s. The massive Capehart 400N of 1946 used four 2A3s. Very few hi-fi amps from the late 1940s through the mid-1950s depended upon 6B4Gs or triode-connected 6L6 types. It is believed that Uncle Sam kept the 2A3 on its official military-procurement list until the 1980s. Only the recent interest in single-ended triode hi-fi amps has revived this tube and kept its production going in China, at KR Enterprise in Prague, and most recently at Reflector in Russia (under the Sovtek brandname).

In Japan, the DIY single-ended (SE) triode amplifier scene got going in the 1960s. Even today, Japanese tube enthusiasts build their own amps or assemble kit amplifiers using 2A3s. The early RCA mono-plate version of the 2A3 is revered there for its sweet, musical, and detailed sound characteristics. A SE 2A3 amplifier can sound especially compelling with well-designed horn loudspeakers or Lowther-based systems.

A few USA-made 2A3 SE amplifiers include the Fi "X"; Welborne Labs' "Moondog"; Electronic Tonalties' "Afterglow"; Moth Audio's S2A3; Wright Sound's WPA 3.5 Mono, and a few others. Many DIY tube audio enthusiasts have built their own 2A3 amplifiers using high-quality SE transformers from AudioNote, Bartolucci, Electra-Print, Magnequest, Tango, and Tamura. So, unlike some of its RCA brandmates of the early 1930s and in spite of a rather small demand, the 2A3 appears poised to survive into the 21st century.



Type 2A3

POWER AMPLIFIER TRIODE

The 2A3 is a three-electrode, high-vacuum type of power amplifier tube for use in the power-output stage of a-c operated receivers. The exceptionally large power-handling ability of the 2A3 is the result of its design features. Among these are its extremely high mutual conductance and its highly efficient cathode which is composed of a large number of coated filaments arranged in series-parallel. This unusual feature provides a very large effective cathode area and thus makes possible the desirable characteristics of the 2A3.

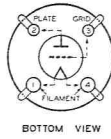

BOTTOM VIEW

CHARACTERISTICS

FILAMENT VOLTAGE (A. C. or D. C.)	2.5	Volts
FILAMENT CURRENT	2.5	Amperes
GRID-PLATE CAPACITANCE	13	μf
GRID-FILAMENT CAPACITANCE	9	μf
PLATE-FILAMENT CAPACITANCE	4	μf
BULB (For dimensions, see Page 151, Fig. 13)		ST-16
BASE		Medium 4-Pin

As Single-Tube Class A Amplifier

FILAMENT VOLTAGE (A. C.)	2.5	Volts
PLATE VOLTAGE	250 max.	Volts
GRID VOLTAGE*	-45	Volts
PLATE CURRENT	60	Milliamperes
PLATE RESISTANCE	800	Ohms
AMPLIFICATION FACTOR	4.2	
MUTUAL CONDUCTANCE	5250	Micromhos
LOAD RESISTANCE	2500	Ohms
SELF-BIAS RESISTOR	750	Ohms
UNDISTORTED POWER OUTPUT	3.5	Watts

As Push-Pull Class AB Amplifier (Two Tubes)

	Fixed-Bias	Self-Bias	
FILAMENT VOLTAGE (A. C.)	2.5	2.5	Volts
PLATE VOLTAGE (Maximum)	300	300	Volts
GRID VOLTAGE*	-62	-62	Volts
SELF-BIAS RESISTOR	—	750	Ohms
PLATE CURRENT (Per tube)	40	40	Milliamperes
LOAD RESISTANCE (Plate-to-plate)	3000	5000	Ohms
TOTAL HARMONIC DISTORTION	2.5	5	Per cent
POWER OUTPUT	15	10	Watts

\* Grid volts measured from mid-point of a-c operated filament.

RCA CUNNINGHAM RADIOTRON MANUAL

APPLICATION

As a power amplifier (Class A), the 2A3 is usable either singly or in push-pull combination in the power-output stage of a-c receivers. Recommended operating conditions are given under CHARACTERISTICS.

The values recommended for push-pull operation are different than the conventional ones usually given on the basis of characteristics for a single tube. The values shown for Push-Pull Class AB operation cover operation with fixed-bias and with self-bias, and have been determined on the basis of no grid current flow during the most positive swing of the input signal and of cancellation of second-harmonic distortion by virtue of the push-pull circuit. The self-bias resistor should preferably be shunted by a suitable filter network to minimize grid-bias variations produced by current surges in the self-bias resistor.

When 2A3's are operated in push-pull, it is desirable to provide means for adjusting independently the bias on each tube. This requirement is a result of the very high mutual conductance of these tubes—5250 micromhos. This very high value makes the 2A3 somewhat critical as to grid-bias voltage, since a very small bias-voltage change produces a very large change in plate current. It is obvious, therefore, that the difference in plate current between two tubes may be sufficient to unbalance the system seriously. To avoid this possibility, simple methods of independent self-bias adjustment may be used, such as (1) input transformer with two independent secondary windings, or (2) filament transformer with two independent filament windings. With either of these methods, each tube can be biased separately so as to obtain circuit balance.

Any conventional type of input coupling may be used provided the resistance added to the grid circuit by this device is not too high. Transformers or impedances are recommended. When self-bias is used, the d-c resistance in the grid circuit should not exceed 0.5 megohm. With fixed-bias, however, the d-c resistance should not exceed 10000 ohms.

Additional curve information is given on page 35.

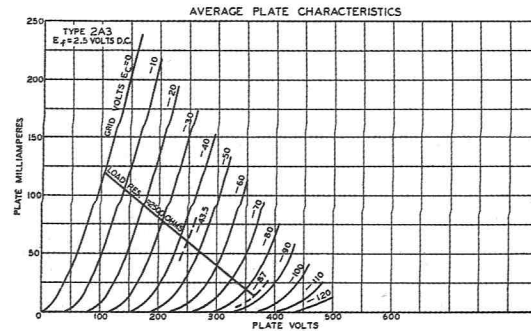

Original 2A3 Specifications from 1933 RCA Tube Manual

Test Results of the 2A3 Samples Measuring Second-Harmonic Distortion at 300 V, 50 mA plate.

Distortion shown is 1000 Hz, at 1 watt into 3200-ohm load. All tubes are double-plate unless otherwise noted. Arranged in order of increasing second-harmonic distortion. All tubes had 2.5 VDC filament power except the 275As.

2A3 RCA single-plate*	.140
2A3 Tung-Sol orange-blue box	.175
2A3 RCA JAN 1952	.180
2A3 KenRad 40s	.210
2A3 GE dbl box-plate 1943*	.230
2A3 KR Enterprise single plate	.260
2A3 Tung-Sol orange-blue box	.270
2A3 RCA 1940s	.270
2A3 KenRad 40s*	.280
2A3 Syl 1930s	.280
2A3 KR Enterprise single plate	.290
2A3 RCA single plate*	.310
2A3 Ken-Rad late 30s*	.310
2A3 KenRad 40s	.340
2A3 Nat Union single plate*	.360

2A3 RCA single plate*	.380
2A3 TungSol dbl flat plates*	.400
2A3 RCA JAN 1952	.410
275A Western Electric 1962*	.410
2A3 Sovtek Single Plate 1999	.430
275A Western Electric 1962*	.450
2A3 RCA 1950s	.450
2A3 Shuguang 1990s	.490
2A3 Arcturus single plate 1934	.520
2A3 Shuguang 1990s	.520
2A3W/5930 Syl 1950s*	.610
2A3 Shuguang 1990s*	.640
2A3 Shuguang 1990s	.700
2A3 Shuguang 1990s*	.710
2A3 Syl single plate*	.750
2A3 RCA JAN 1950s	.762
2A3 Shuguang 1990s*	.970

Averages:

2A3 single plates	.410%	6 samples
2A3 double plates	.345	15
2A3 Shuguang	.670	6
2A3 KR Enterprise	.275	2
275A WE	.430	2

\*=good used (note: casual tests showed the 2A3W to be far less microphonic than the conventional ST-shaped tubes.)

References:

- Recent Trends in Receiving Tube Design, J.C. Warner, E.W. Ritter and D.F. Schmit, RCA Corp. Proceedings of the IRE, August 1932.
- Design of Audio Systems Employing Type 2A3 Power Amplifier Triodes, RCA Corp. Tube Department Application Note No. 29, December 29, 1933.
- 70 Years of Radio Tubes and Valves, John Stokes (Vestal Press, Vestal, NY, 3rd edition, 1992), ISBN 0-911572-60-0.
- Tube Lore, Ludwell Sibley, Flemington NJ, 1997, ISBN 0-9654683-0-5.

Many thanks to Ludwell Sibley and Alan Douglas for their assistance with historical facts. A special thanks to Norm Braithwaite for his knowledge and for providing some of the scarcer 2A3 types for the tests.

# Listening to 2A3s In Modern SE Amplifiers

By Charles Kittleson ©1999 All Rights Reserved

Here was the opportunity I had been looking forward to. A chance to evaluate some of the best sounding audio triodes with some of the best sounding SE 2A3 amplifiers currently available. With the cooperation of the manufacturers, we were able to audition the Fi-X 2A3 stereo amplifier, the Moth Audio stereo S2A3 amplifier and a pair of Welborne Labs Moondog monoblocks.

While a great percentage of the single-ended mania is driven by the 300B, the 2A3 is a more musically balanced tube, in my opinion. Many SE 300B amplifiers have more power, but their bass response can be rubbery and in many cases not very well defined. On the other hand, with the right circuit, transformers and speakers, a 2A3 amplifier sounds more balanced, musical, and sweeter with a better defined bass. Keep in mind however, that with only three watts of Class A power, your speaker selection is critical. SE 2A3 amps can work well with horn speaker systems, Lowthers, and a few sensitive modern and vintage bookshelf speakers. Incidentally, the 2A3 was Paul Klipsch's favorite tube and any of the amplifiers we talk about in this article can make your K-Horns sing.

The good news is that several new 2A3s are available, including the Chinese type, the KR2A3 and the new Sovtek 2A3 (to be in production soon). Please keep in mind that vintage RCA single-plate engraved base 2A3s are ultra-rare. Good used examples can cost \$200 to \$350 each and NOS examples can fetch in excess of \$400 to \$700 each!

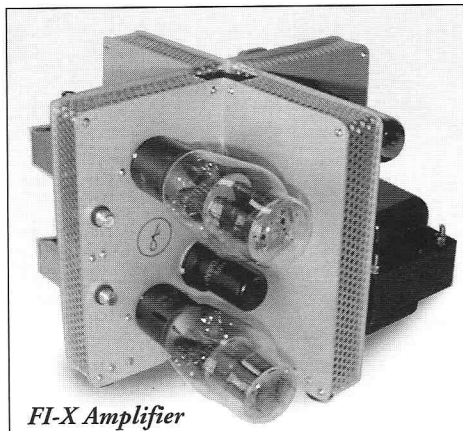

As with all of the VTV listening evaluations, we had the VTV editors and several audio enthusiasts from the local area listening to all the tube types over a period of several weeks. Meticulous notes of sound quality and other comments were recorded. Tube sonic characteristics were rated numerically as follows: **excellent, detailed, balanced and musical 90 to 100; good sounding, but has one or more sonic deficiencies 80 to 90; noticeable sonic flaws and in some cases, irritating 70 to 80.**

Besides the amplifiers described below, other components used in the evaluation included: the VTV Comparison Preamp (see VTV #7) using a 1953 Western Electric 396A dual triode, D. H. Labs B1 Series II Silver Sonic Interconnect, D. H. Labs T-14 Silver Sonic Speaker Cable, Klipsch Chorus I or B&W DM-110 loudspeakers. All of the listening tests were conducted in the VTV audio evaluation studio. The listening panel consisted of John Atwood, Eric Barbour, Steve Parr, David Bardes, Ray Stafford and myself.

## 2A3 Listening Evaluations

**Arcturus Single-Plate 2A3** (1934 with dark-colored plate) This tube had solid bass, mid-range with depth and detail with sweet, extended highs. Very balanced with great separation of instruments. Rating: 94

**General Electric 2A3** (1940s with large dual box-plates) Smooth, good musical depth, but the highs were slightly sibilant. This particular type is not common and was probably only made for a few years. Rating: 83

**National Union Single Plate 2A3** (1934, appears to be a re-branded RCA type) This bottle has super-depth and detail. The mids are superb with somewhat soft bass that is slightly distorted. Rating: 89

**Ken-Rad Bi-Plate 2A3** (1949 with gray-tinted glass) A very balanced tube, musical and easy to listen to. Highs are very sweet and not sibilant. These tubes can sound better than the highly-touted RCA bi-plate. Rating: 92

**KR-2A3 Single-Plate** (1998) This is a beautifully made tube with excellent

detail and a "high-end" sound. The higher frequencies are emphasized and thus, are somewhat forward-sounding. The upper-mids are a little recessed and seem to sound less three-dimensional than vintage 2A3s. With some ultra-sensitive horn speakers, the highs may be a little bright. Rating: 85

**Raytheon 2A3H** (1936) An extremely rare tube, but a great sounding one. Very accurate, balanced and musical with super nice high-frequency detail. In the same league as the original RCA single-plate 2A3, but noticeably better high-frequency detail. Rating: 97-98

**RCA Single-Plate 2A3** (1933 no plate support rods) This legendary valve is the standard by which all other 2A3s are to be judged. A tube with delicious, deep and sensuous mids. Highs are sweet, liquid and extended, without a hint of sibilance. The bass was well-defined and tight. Overall tonal balance through the sonic registers is close to perfect. Rating: 97

**RCA Bi-Plate 2A3** (1949) The bi-plate RCA is no slouch either. Very balanced, with great upper mid extension. Highs are sweet and mids are musical. This is the classic bi-plate 2A3 and worth pursuing, even at premium prices. Rating: 92

**Shuguang 2A3 Bi-Plate** (1990s Chinese) Smaller and more recessed sounding with weaker bass, rolled-off highs and less power than others in the test. Good control of mid-bass, but highs have a noticeable degree of sibilance. For the money a fair to good tube, considered a good buy at current prices. Rating: 80

**Sovtek/Reflector Single-Plate 2A3** (1999) A new offering from Sovtek, we were able to obtain a pre-production sample. The bottle is closer in shape to the original "ST" shape and the plate structure looks similar to the Sovtek 300B. Our sample of the Sovtek 2A3 had a huge, clear soundstage with sweet, detailed highs. Midrange response is excellent with realistic imaging. The tube has an overall good tonal balance across the spectrum. It also seems to put out more power than any of the other 2A3s in this test. Performance easily exceeds the Chinese 2A3 which has less bass response and rolled-off highs. Let's hope Sovtek can bring this tube into full production soon. Rating: 90

**Sylvania 2A3 Bi-Plate** (1936 engraved base with black plate) This tube has sweet highs, great mids with nice soundstage. However, the bass response was slightly flabby. Rating: 87





Welborne Moondog SE 2A3 Mono

**Sylvania 5930/2A3H (1949)** This extremely rare tube is sweet sounding, but has a recessed soundstage. It seems to put out less power and has less high frequency extension than most of the NOS 2A3s. Rating: 80

### Sampling 2A3 SE Amplifiers

Thanks to very helpful and cooperative manufacturers, we were able to evaluate a nice cross-section of current SE 2A3 amplifiers. All of the amps listed are currently available directly from the manufacturers.

### FI "X" Amplifier (Base price \$895)

Hands down, the "X" is one of the coolest stereo amplifier chassis designs we have seen. Don Garber, owner of FI in Brooklyn, New York, designs and builds these compact and unique little amplifiers. The "X" generates close to 3 watts from an SE pair of 2A3s driven by 6SF5 triodes with a 5Y3GT tube rectifier. Our sample included a pair of 5 Henry chokes (\$40 extra) to use with extra-sensitive horn speakers with efficiency of 100dB. This came in handy when using the "X" with our Klipsch Chorus Is that are extremely sensitive to any amplifier hum.

Due to smaller output iron and a simpler driver stage, bass response was not as robust as the other amps we listened to in this review. However, as an upgrade option, the "X" is available with larger Magnequest output transformers which will add more body to the bass. While not super extended, the mids and highs are smooth, sweet, and easy to listen to as SE 2A3s are supposed to be.

If you are on a limited budget and don't have a lot of space, the "X" amplifier may be just what you are looking for. The "X" should not be used with power hungry speakers, so make sure you have a good

horn speaker system, Lowthers or other speakers of 93-96 dB or greater efficiency.

*Fi-Audio, 30 Veranda Place, Brooklyn, New York (718) 625-7353 FAX (718) 875-3972*

### Welborne Labs "Moondog" SE 2A3s (Base price from \$1350/pr less tubes)

These mono SE amps are absolutely gorgeous with their classic styling, real wood bases and beautiful solid-brass chassis plates. Ron Welborn designed the Moondog circuit with a medium-mu voltage amp stage using a pair of 6SN7GTBs, a single 2A3, and a GZ37 tube rectifier. The output transformer is a beefy and super-high quality 4K ohm Electra-Print model. Maximum output power is 3.5 watts with distortion of 2% at rated power. However, at .5 watt, the distortion is about .5%, so you can easily use the Moondogs with Altec horns, Lowthers, horns, or other 90-95dB+ efficient speakers. These would be perfect amps to drive horns in bi-amp systems.

Welborne "Moondogs" are available either as kits or fully assembled and tested. By the way, the kit manual is included and is excellent with color-coded step-by-step illustrations and wiring diagrams. Our factory assembled test amps had the ultimate component upgrade kit with Jensen copper foil paper-in-oil coupling caps, Caddock precision resistors, Blackgate Muse electrolytic power supply caps and precision machined teflon tube sockets. Standard chassis hardware with all "Moondogs" includes speaker terminals and RCA inputs by Cardas and a few other cool goodies.

You will be howling at the moon with glee when you listen to these beauties. Sound quality is superb with strong, well-defined bass, spacious mids and extended musical highs. Imaging is very natural and lifelike with high-definition resolution on all registers.

*Welborne Labs, P.O. Box 260198, Littleton, Colorado 80126 (303) 470-6585/FAX (303) 791-5783 www.welbornelabs.com*

### Moth Audio S2A3 (\$2700)

Based in Hollywood, Moth Audio produces some dramatically styled SE tube audio products. Not only are they dramatic, but they are beautiful! The S2A3 produces a solid 3 watts of awesome SE power with a response of 3Hz to 32kHz (-3dB at one watt). The build quality is excellent including a highly-polished black-finished chassis top-plate and a heavy-duty black-wrinkle covered steel chassis. The amp dimensions are four inches H x 14 1/4 inches W x 15 1/2 inches L with a weight of 40 pounds.

In the power supply department, the S2A3 power supply is serious, with beefy toroidal chokes and a power transformer feeding a 5AR4. Voltage gain and driver functions are handled by a 6SL7GT for each channel. Each channel uses a single 2A3 and no negative feedback is employed. Output iron is the legendary Electra-Print TM-3. Wiring is a combination of point-to-point and circuit board. Speaker impedance is set at 8 ohms by the factory, but can be adjusted by changing the connections under the chassis.



Moth Audio S2A3

Audio performance of the S2A3 is nothing short of sensational. This beauty has excellent tonal balance, strong bass, three-dimensional mids and sweet-extended highs. Soundstage is huge and very deep indicating superior circuit design and component choice. Even though we are talking about only three watts, this amp has the balls of 15 or more watts. If you like the exotic and want the best, the S2A3 will thrill you.

*Moth Audio Corporation, 1746 Ivar Avenue, Hollywood, California (323) 467-4300/FAX (323) 464-9100 www.mothaudio.com*

# Allen Amplification Guitar Amp Kit Review

By Ron Veil ©1999 All Rights Reserved

Quite a few boutique guitar amplifiers have been available to the consumer over the past few decades. There are more than 25 nationally advertised amps in the USA, with many more amp builders/shops doing small production runs of old and new designs, using both tube-based and solid state chassis. Serious musicians and audiophiles have long realized how tube gear delivers better tonality and clearer imaging than the solid state equivalents. When both devices are over-driven into

(now also available with 1x15", and as an amplifier head which was built for this VTV review), and 2x12" in the TONESavor (now also available with 4x10"). New models will include the Accomplish 20W (combo or head), 80W version of the TONESavor, and a Tube Reverb Unit.

The tube complement in the amp (as tested) are as follows: V1-preamp tube (Ruby 7025STR used here - 12AX7 or JAN 5751 usually supplied), V2 reverb driver (JAN 12AT7 used), V3 reverb recovery and 2nd preamp (Mullard 12AX7 used), V4 phase inverter/driver (JAN 12AT7 used), V5 and V6 6L6GCs (Svetlana used here, Sovtek, NOS, and Ruby are available from Allen amps), and V7-rectifier tube (RCA GZ34/5AR4 used here, Ruby Tube GZ34 usually supplied), with a plug-in solid state rectifier supplied with all 40 watt kits.

The front panel has a single input jack, volume knob, bright switch (for a higher treble boost), RAW switch (this disconnects the EQ circuits from ground, allowing ALL of your input signal to be amplified instead of grounding out a good portion of it), 3 EQ circuit; Treble, Midrange, and Bass, 3-knob reverb circuit; Dwell, Mix, and Tone, Master Volume, power switches (instead of at the back of the amp); AC (for power), and DC (also known as Standby with other amps), and the pilot light.

The rear panel has a single 4 ohm speaker jack. However, it can be ordered with different output impedances if desired. The rear panel also has bias adjustment jacks (one for each output tube), and a fuse holder. The reverb jacks are on the bottom of the chassis, so they are not susceptible to movement or inadvertent damage. The cabinets that are used in the combos, heads, and speaker enclosures have some of the best solid pine finger jointed construction that I have ever seen. The 2 speaker enclosures used for the evaluation had a single WeberVST C15CA speaker in one, and 2 WeberVST C10Q special design speakers in the other.

## Nice Parts From the Start

The Allen amp kits (or pre-wired amp, if so desired) arrive extremely well packed. They are shipped in 350 lb rated double wall cardboard boxes, with full flaps, giving the contents several outside layers of protection for shipping. Smaller sub boxes and well marked zip locked bags made checking the parts inventory and kit construction fast and easy. All of the components, hardware, and cabinetry are top notch quality.

The documentation provided includes a well-organized parts inventory, a component fiberboard layout (with both a top and bottom view showing terminal markings and hidden jumpers), a 30 page Instructions for Assembly manual, a 5 page Operating Instructions booklet, a 11"x 17" schematic, and the best (11"x 17") COLOR chassis layout I have ever seen. The earlier chassis layout was black-and-white and was accompanied by a color photograph to check your progress and correct component layout. NOTE: The newer COLOR chassis layout is a vast improvement and one of the best tools to put kits together. If other compa-

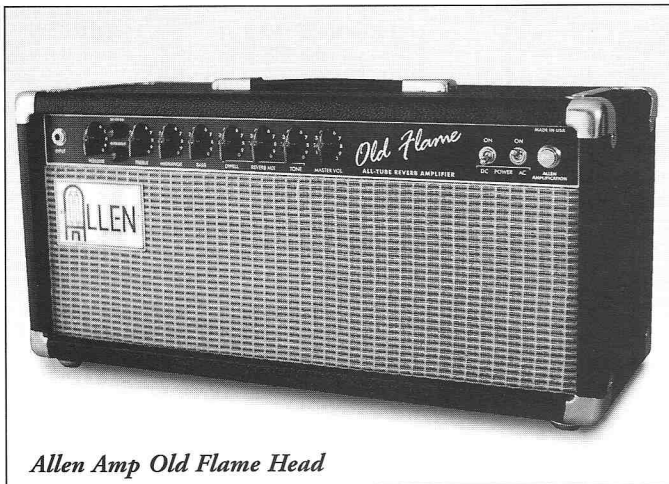

Allen Amp Old Flame Head

distortion, the tube amp sounds much warmer, and is less harsh to the ear. As long as tubes are available, the majority of guitarists will choose tube gear for their medium.

There has not been a quality musical instrument amplifier kit since Heathkit discontinued theirs almost 20 years ago. The last Heathkit available was a solid state amp, a rather large piggyback version with a 2x 12" speaker cabinet. After extensive searching, both on the Internet and in musical publications, no other kit amplifier could be found that is produced today.

## Allen Amps: Concept and Layout

The basis of the original Allen amps was the blackface era Fender amps from the mid sixties AB763 circuit, with 2 x 6L6GC output tubes (40W with tube rectifier, and 45W with solid state rectifier), GZ34 tube rectifier, tone circuit, and reverb. The speaker complement was either 1x12" or 2x10" in the Old Flame

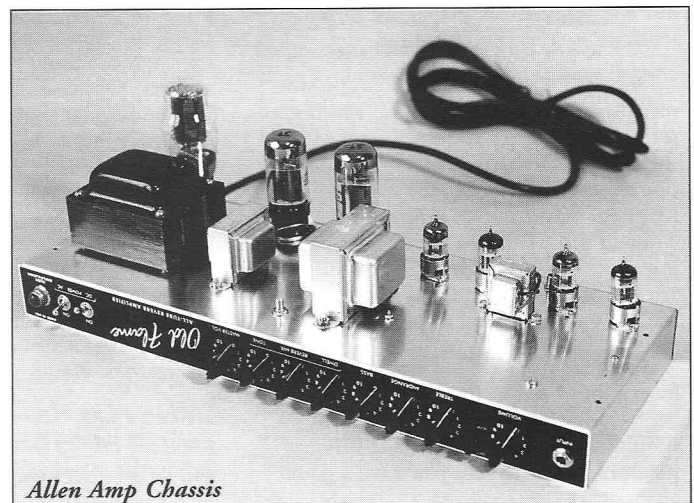

Allen Amp Chassis

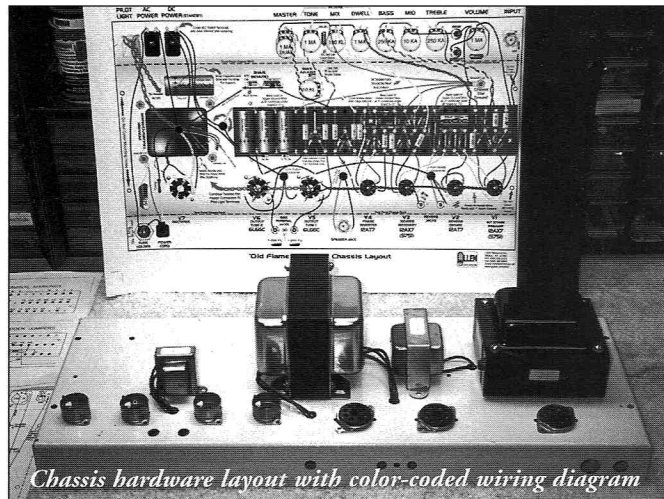

nies used this approach, their products would be much easier to construct.

The kit itself is comprised of the cabinet (either combo: containing both speakers and amplifier, or head/speaker in separate boxes), chassis (heavy gauge aluminum), faceplates (back and front control panels), and reverb tank (Accutronics 2-spring medium delay). The transformers (power, output, reverb and choke) are manufactured by TMI/Robins, of Chicago. The larger, optional Bassman transformer was used for this review, in lieu of the smaller Pro Reverb/Vibrolux tranny. The potentiometers are made by Alpha, most resistors are Allen-Bradley, capacitors (Mallory, Sprague, or YOUR choice), jacks, switches, tube sockets (vintage style), cables, power cord, cloth wire (for doing all the components and chassis wiring point-to-point) and cabinet hardware are all included with the kit.

For speakers you can use your own, or you have a choice between Eminence, Jensen Re-Issue, or Weber/VST, Weber VST being the premium, optional upgrade. For tubes again you may use your own, or you have a choice of NOS, JAN, Svetlanas or Ruby. There are 2 Vulcan component fiber boards (one with eyelets for component mounting and the other for insulation).

**Assembly**

The instructions for assembling the amplifier are both comprehensive and well thought out. They start with the usual safety warnings, which tools are needed for the kit construction, and recommended work area layout. Everything is then broken down into sub-directories to allow building the kit in the most logical and expedient manner.

The first step is the mechanical assembly of the chassis and associated compo-

nents. This is actually the installation of the tube sockets, faceplate/control panels, speaker, reverb, bias, and input jacks, the switches, potentiometers, and transformers. This part of the assembly went quickly using simple hand tools.

Circuit components and connecting wires are laid out on a Vulcan fiber board with preinstalled eyelets to facilitate their soldering. Each eyelet on the board is given a unique alphanumeric designation, such as A1, or E2, or P3. They start with A through Z for horizontal lines, and the 3 rows are designated with 1 for the top row, 2 for the middle row, and 3 for the bottom row.

First, the various resistors and capacitors are soldered to the fiber board before it is mounted to the chassis. The components are called out in color codes for the resistors, and values for the capacitors. Next, the flying leads are soldered along the edges of the board for connection to the pots, sockets, and transformers later on. The solid-core cloth covered wire was a pleasure to work with. Just push back the cloth (no stripping required), solder it to the lug or eyelet, and then push the cloth back up against the connection. The wire twists together and stays in place much better than modern plastic insulated stranded wiring. The cloth wiring is color coded, with plate connections being blue, grids being brown, cathodes being yellow, high voltage points using red, low voltage heaters and grounds using green. All these tie into the color layout drawing which even shows the correct lead dress (proper twisting and routing of wiring for lowest noise.) This sub-assembly is then fastened into the chassis which was previously set aside.

Then, the flying leads are trimmed and soldered to the preamp tube sockets, the power tube sockets, the potentiometers,

the transformers, and the various switches and jacks on the chassis.

There are boxes included next to the kit construction steps. You can check off each instruction and know where you are in the assembly process if you get interrupted. The combination of the assembly instruction sheets, schematic, and the COLOR chassis layout make this kit very easy to assemble. All the drawings and documents were large and easy to read.

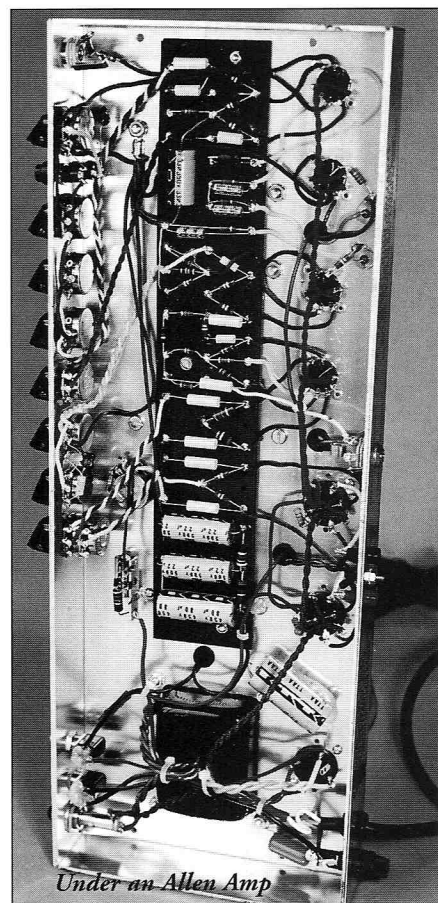



TONEsavor and Old Flame Combo Amplifiers

solid-state rectifier are included.

The back panel is a nice touch. It shows complete amp, fuse, and speaker ratings along with instructions on setting the bias using the bias jacks, a permanent tube chart along the bottom, and important safety warnings. The heater supply has a center tap, which eliminated the need for wiring 100 ohm grounding resistors to each side of the 6.3V supply.

master volume. The mid frequencies are complex and rich, the highs clear, and lows tight, even with the 2x10"s. You can get some great tones with either speaker complement, or any guitar pickup selection. It was possible to emulate any (good) reverb sound with the 3 knob reverb circuit, being full and lush, not splattery or harsh at all. An added plus for those who record is that Allen amps have an extremely low noise floor at all volume settings.

To sum it up, the Allen amplifier is a well designed, solidly built, compact and relatively lightweight instrument. Amateur and professional guitarists will find the ToneSavor versatile, flexible, and great sounding. For jazz, blues, country, and classic rock this amp is just the ticket. Heck, it will work fine in some heavy metal or trash rock applications.

The small bias board, the resistors on the output tube sockets, the resistor on the bias potentiometer, and the resistors on the input jack come pre-wired from David Allen which makes construction much quicker. The last part of the actual construction is wiring the 6.3V heaters for the preamp tubes, power tubes and the pilot light. It's not particularly difficult, but does take time. The kit features a heavy 13 gauge aluminum chassis for low ground resistance, non magnetic coupling, low weight, resistance to long term corrosion, and uses a traditional star chassis ground near the input jack.

All hardware has lock washers or Keps type locking nuts. The rear graphics panel is held on with a high temperature adhesive while the front graphic panel was held on by the various pots, jacks, switches, and the pilot light. Pots were the full sized 3/8" bushing type with solid metal shafts. All sockets are the molded type with the preamp sockets being NOS military grade, and the octal sockets featuring tube base retaining clips. The power supply is very beefy, using five filter capacitors and a large 3 Henry choke. Both a tube and plug-in

With construction done, all tubes installed, speakers hooked up, a final check of all wiring, component layout and orientation, one can adjust the output tube biasing. This is a very good feature of the Allen amp, as it has outboard bias jacks and an easily reached bias potentiometer to facilitate the adjustment of the output tube idle plate current. The amp used for demo purposes went through several tube swaps (different tube manufacturers) quickly with this feature without having to pull the amp out of the cabinet each time. This would definitely be a great selling feature for musicians that need to change tubes and bias it themselves on a gig between songs, or sets, if a tube dies or goes microphonic.

**How Does the Amp Sound?**

Several guitars were used in a sonic evaluation: a 74 Fender Stratocaster, a 75 Fender Telecaster, and an 81 Gibson ES-347. To calibrate our ears, the Allen amp was compared to a '65 Super Reverb, and '68 Bandmaster Reverb. It was surprisingly easy to get some great tones with any guitar pickup selection, or either speaker complement with the Allen amp. The amp is very versatile in itself, given the

EQ arrangement, volume knob setups, or reverb shaping possibilities.

With little effort, you can get those mid-60s blackface "sparkling clean" sounds, as well as great warm, sustaining, overdriven, classic blues tones with the use of the

Exceptional technical support and dedication to customer service make purchasing an Allen Amplifier a pleasant experience. Without a doubt, the Allen Guitar Amplifier Kit is a qualified Best Buy and highly recommended.

**Allen Amp Prices**

The basic kit prices are \$799 for a 2x12 TONEsavor, \$749 for a 2x10 Old Flame, \$649 for the Old Flame head, \$499 for the Tube Reverb unit, \$699 for the single speaker Accomplice, and \$599 for the Accomplice head. Prices vary for different configurations or optional speakers, tubes, output transformers, and special features. The assembled amps run approximately \$200 more for a Tube Reverb unit, \$300 more for an Accomplice and \$400 more for a TONEsavor or Old Flame combo.

**Allen Amplification, 1325 Richwood Road, Walton, KY 41094**

**(606) 485-6423**

**http://www.iguitar.com/allen/  
e-mail: tonesavor@fuse.net**

*Ron Veil is a guitar amp technician based in San Bruno, California. His first job was in a TV/audio repair shop. While in the Air Force he was trained in telecommunications and test equipment calibration. After the military, he worked for Philips Electronics, specializing in electron-microscopes. After that, he formed Uncle Spot, Inc. in 1990, and V.E.I.L. Customer Services in 1998.*

Ron Veil (Uncle Spot, Inc. Tube Amp Restorations)  
**veilcs@earthlink.net**

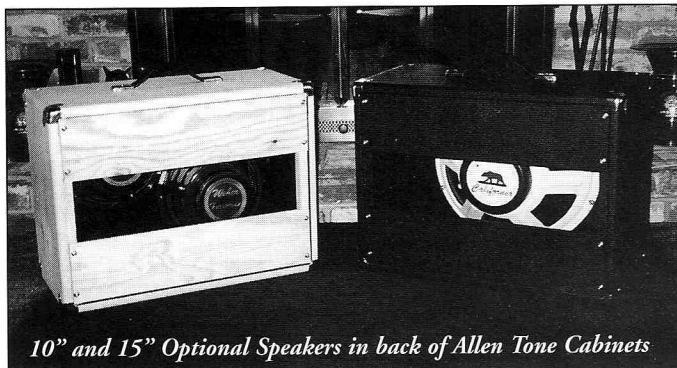

10" and 15" Optional Speakers in back of Allen Tone Cabinets

**The Audio Test Bench**

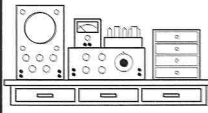

by  
**John Atwood**

# Impedance Measurement

©1999 All Rights Reserved

If resistance can be defined as having the effect of limiting DC current flow, then impedance can analogously be defined as limiting AC current flow. Actually resistance is a subset of impedance - where a resistive network is made up of resistors only, which have constant energy loss at all frequencies. A generalized network is made up of impedances which can have resistive, capacitive, or inductive components. To fully explain AC circuit theory would require describing vectors, imaginary numbers, complex algebra, phase angles, etc. For the purposes of the Audio Test Bench, just be aware that any component has a mix of resistance, capacitance, and inductance, and that sometimes it is helpful to measure the unwanted "parasitic" aspects of a component in addition to the desired value. The term impedance covers all of these aspects.

Impedance measurement has changed over the years. Resistance measurements have always been straightforward: apply a voltage across the device and measure the DC current flow. Up until the digital era, analog meters were used, with an accuracy limitation of about 1% or so. Digital meters have allowed accuracies of .1% and better - usually limited by the number of digits in the display and the quality of the internal circuitry. Beware, however, cheaper DVMs often have far less accuracy than expected. Be sure check their specs.

Measurement of capacitance and inductance is more complex than resistance, since usually two parameters need to be measured: the capacitance or inductance and the resistance, which corresponds to loss. There are direct ways of measuring capacitance and inductance, such as how fast a constant current charges up a capacitor, but these direct ways often can't measure the loss very well. The traditional way of doing accurate impedance measurements has been to use a "bridge" circuit, where both the reactive (capacitance or inductance) and resistive values can be independently measured. Advances in digital design have made the direct methods more feasible, resulting in low-cost DVM-like capacitor testers. However, accurate testing, particularly while the part under test is under voltage or current stress, still is best done with bridges.

### Impedance Bridge Theory

The concept of a bridge is to place the unknown component into a circuit network with an applied voltage, then vary other components in the network to cancel the effect of the unknown. These other components can be calibrated so that they can read out the unknown component's value. Figure 1 shows the most basic bridge, the Wheatstone bridge. It is used to measure resistances. If the resistors Ra, Rb, and Rs are calibrated and accurate, then the accuracy of the measurement depends only on them, and not the exact value of the applied voltage or the detailed characteristics of the null meter. In this bridge, the applied voltage can be either AC or DC. To measure Rx, Rs is varied until the null meter has a minimum reading.

Figure 1

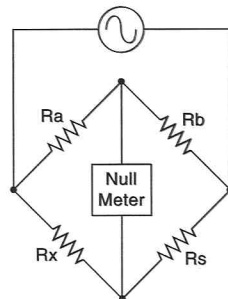

$$\frac{R_a}{R_b} = \frac{R_x}{R_s} \quad \text{or} \quad R_x = \frac{R_a}{R_b} R_s$$

Wheatstone Bridge

Figure 2

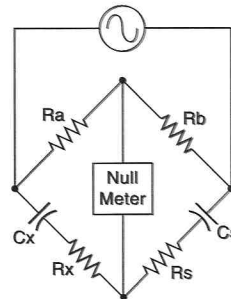

$$C_x = \frac{R_a}{R_b} C_s \quad R_x = \frac{R_a}{R_b} R_s$$

$$D_x = \omega R_x C_x \quad \omega = 2\pi f$$

Resistance-Ratio Bridge

Figure 3

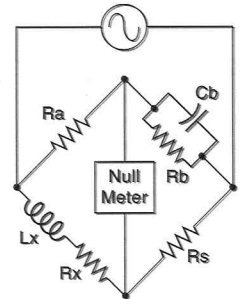

$$R_x = R_a R_s C_b \quad R_x = \frac{R_a}{R_b} R_s$$

$$Q_x = \frac{\omega L_x}{R_x} = C_b R_b \quad \omega = 2\pi f$$

Maxwell Bridge

to be tested with DC current flowing through them. Because it is difficult to make high-quality reference inductors, the bridge network is altered to null the unknown inductor, Lx, with a capacitor, rather than an inductor. The Maxwell bridge, Figure 3, is an example of this. The common measure of loss in inductors is Q, or Quality Factor. Q is 1/D or  $\omega C_b R_b$  in the Maxwell bridge.

Where DC current flow through an inductor is required during measurement in filter chokes or the primaries of single-ended transformers, the Hay bridge is used. This bridge is the same as the Maxwell bridge, except Rb and Cb are in series. In this configuration, the frequency term,  $\omega$ , enters into the equation for inductance. If high DC currents are needed, then the resistors in the bridge will require high power ratings.

There are many other bridge configurations, each with its own characteristics and advantages. Texts on electronic measurement describe many of the types of bridges.

### Practical Impedance Bridges

Bridges are among the oldest types of electrical instrumentation, with the result that many older bridges appear rather primitive to use. These old-style bridges are completely passive, requiring external AC voltage sources and an external null meter. My Freed inductance bridge is such a device, but its usefulness made it worthwhile to supply all the external pieces.

Portable bridges and most newer lab bridges contain AC voltage sources and null meters. They also are switchable so that resistance, capacitance, and inductance can be measured. Typical of these types of bridges are the General Radio

To measure capacitance, a common type of bridge is the resistance-ratio bridge, shown in Figure 2. This is similar in concept to the Wheatstone bridge, but to obtain a null, both Rs and Cs must be varied. Where variable capacitors are not desired, Ra or Rb can be varied instead of Cs. The common measure of loss in a capacitor is D, the dissipation factor. D is defined in this type of bridge as  $\omega C_s R_s$ , where  $\omega$  is  $2\pi$  and f is the frequency of the generator.

Measuring inductance is more involved than measuring capacitors, since the losses in inductors are often large, the inductance and losses change with frequency and signal level, and often inductors need



General Radio 1650A

1650A and the Hewlett-Packard 4260A. These types commonly use a sensitive AC meter as the null meter.

Many of the so-called capacitance checkers for radio servicemen use a bridge to measure capacitance values. These use a "magic eye" tube for the null indicator. The famous Sprague Tel-Ohmike is typical of this type.

Finding the null when using a bridge can sometimes be challenging, especially for inductors. The nulls can be very narrow and require that both the inductance and resistance adjustments be close to the final null point. Reducing the gain of the null meter helps find the general vicinity of the null.

If you do end up with a bridge that requires external instrumentation, there are several things to be aware of. The null meter can be a standard AC voltmeter,

bridges, since it easily available from the power line. In electronic instrumentation practice, 1KHz is standard. This requires a good sine wave oscillator. If higher voltages are needed (I use 50 Vrms to test the One Electron transformers), then a high-output oscillator or a power amplifier is needed. A power amp with a 500-ohm output impedance such as the McIntosh MC-30 will give 50 volts or more. Other frequencies can be used, but make sure that the bridge calibration takes into account the new frequency.

**Direct Impedance Measurements**

A direct measurement system is one that generates a component value read-out without the need for adjusting for a null. In some cases, a bridge with an auto-null feature gives a component value reading. More common are schemes that charge the inductor or capacitor with current or voltage, respectively, then calculate

but a meter with a logarithmic scale is much easier to use. If you are measuring iron-core inductors, the core generates harmonics, so a tunable meter (tuned to the generator frequency) gives better nulls.

In the electrical power industry, 50 or 60Hz is most often used as a source for

of capacitance can be obtained, but losses and inductance measurements are not as accurate.

A common type of direct impedance measurement is the capacitance mode of DVMs and the inexpensive capacitance checkers that look like DVMs. For low-loss capacitors, these can give decent readings (although often not as accurate as the number of digits in the display would suggest). Sometimes very strange readings occur, so it is worthwhile to do a "sanity check" on any readings. An example of how these meters can be confused occurred a few years ago on one of the sci.electronics internet news groups. Someone connected a 1 Megohm resistor to his capacitance meter and it read out something like 5 microfarads. After reporting this to the net, various theories were floated on how a resistor could have so much capacitance (a few pF is more realistic) until some saner people suggested that this type of cheap meter was being confused by measuring something out of the ordinary!

A common technique for component measurement at RF is to put the component into a resonant circuit and adjust the other components and/or frequency to resonance, then calculate the unknown component value. This does not work very well at audio frequencies, because virtually all inductors used at these frequencies have ferromagnetic cores, and these materials are notoriously variable - changing value with temperature, signal level, and frequency.

A brute-force but reasonably accurate way of measuring inductors with DC current flowing in them (called incremental inductance) is to build a choke-input power supply and measure the input AC voltage (Eac) to the rectifier and the AC current (Ic) through the filter capacitor. The reactance of the incremental inductance is then (0.424 Eac)/Ic. Changing the resistive load changes the DC current. See the Terman reference, pp. 110-111 for details on this technique.

**References:**

1. **Electronic Measurements**, F.E. Terman, J.P. Pettit, McGraw-Hill, 1952, 2nd Ed. Very complete and readable reference on all sorts of measurements. The 1st edition (1937) has much of the same material of interest to audio people.
2. **Manual for Type 1650-A Impedance Bridge**, General Radio Corporation. Includes a good summary of various impedance measurements using a bridge.

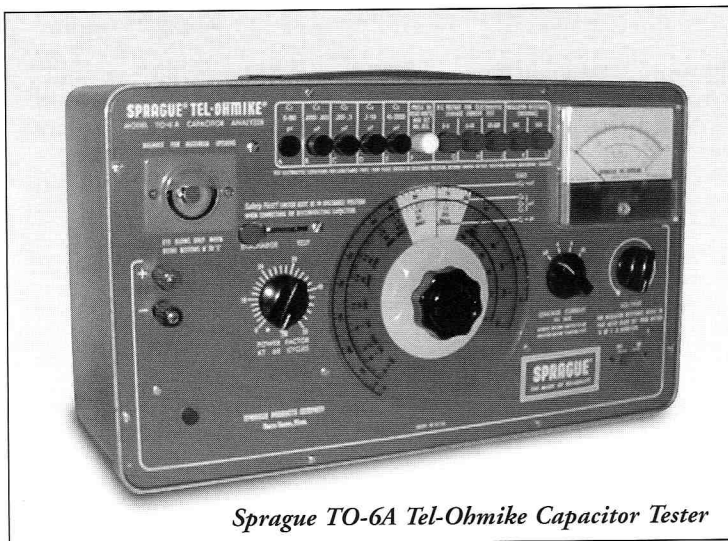

Sprague TO-6A Tel-Ohmike Capacitor Tester

# Modern Bookshelf Speakers for Classic Tube Amplifiers

By David Bardes ©1999 All Rights Reserved

So you just picked up a classic tube amp, or perhaps you have completed a tube amplifier kit and you're ready to complete your system with the purchase of a set of speakers. What speaker is "right" for the job? Those glossy four-color audio magazines review a lot of speakers - one at a time, using over-priced solid state gear. C'mon guys, waxing poetic about how these so-called bargain speakers held their own in your ultra-fi rigs, despite the amounts of brie and Merlot that were consumed by the reviewer, isn't a big help.

In what might be a ground breaking move, we have gathered up a sampling of some of the most popular speakers, from the very modest to the moderately expensive, and listened to them in a real living room. What's more, we used three different tube amps in our audition. Our mission: to find some really good matches for great critical or casual listening at a variety of price points. So whether your amp is a low wattage SE, or a classic push-pull type, we have a recommendation for the job. Our "golden-eared" ad hoc panel listened at considerable length to find the best match of amplifier and speaker. No wine or cheese was present. More importantly, no advertising dollars influenced our decisions!

*NHT Super One XUs and Polk Audio RT-55s*



For our first ever modern speaker review, bookshelf speakers seemed a natural choice. They are versatile, compact and typically cost less than their floor-standing brethren. While they can certainly fit on a shelf for casual listening, they can also provide front-row realism propped up with speaker stands and placed for optimum imaging. Either way, it's hard to go wrong with a good bookshelf speaker.

### Lessons Learned

Take your time finding a pair of speakers for your system! Carefully matching speakers to your amplifier can make the difference between musical sounds and true musical expression. It seems that for each particular amp (and room), different speakers will behave quite differently. We found ourselves surprised by the chameleon-like performance of several of the speakers we auditioned. Finding synergy between amp and speaker can be unpredictable, but is obvious when it is found. This review isn't about finding which speaker gets an editors' choice, this is about making recorded music sound great! For the speaker buyer, finding the right speaker/amp match will bring about much greater musical gains in one's system than the myriad of discs, dots, spikes and widgets available to "improve" the sound of speakers.

Musicality should take center stage over flawlessness. When an audio system starts conveying true musical expression issues such as a small midrange coloration, or a splashy sounding tweeter, become irrelevant. When your toes start tappin' and you find yourself humming along, instead of finding the strengths and weaknesses of a speaker's performance, bingo - you've found a successful match!

Fortunately, we found several matches in just this fashion.

### Push-Pull Synergy

For our Push-Pull amp we used the GW Labs Model 270. At 70 watts per channel, this amp has lots of gusto. It has the clean powerful sound that the 6550 tube is famous for. Of our speaker sampling we found several that worked quite well. At the smaller, less-expensive end, the NHT Super One XUs were our favorites. We were a bit dubious about the doped polycarbonate enclosure, but it seemed well damped and didn't interfere with the music. Cool rubber wedges placed under the speaker either sloped the baffle back for a desktop application, or tilted the cabinet forward to bring the baffle to its full and upright position for use on a shelf or speaker stand. These small speakers projected a large soundstage, and worked with the amp to provide clean separation of voices and a balanced tonal presentation. Bass performance was modest, but



*GW Model 270 Amplifier*

the lively, dynamic presentation made the most of what was there. Our panel was in complete agreement that the Super Ones were definitely working in concert with the GW Labs amp, with a clean musical result.

Moving up in size and price were the Polk RT-55s. These speakers had the largest enclosure of the speakers we reviewed, and sported two 6-1/2" mid-bass drivers. Our panel agreed they sounded big, dynamic, and smooth. "Big" here is different than the size and depth of the soundstage, which were both considerable, it was more of a sense of scale. Big music, like our recording of "Fanfare for the Common Man," produced big results through these speakers. They possessed good resolution and a sense of coherency; at the same time they were very smooth and well-behaved. Bass response was deep, but a bit veiled.

Two other speakers performed well with the GW Labs: the Infinity Overture Ones and the Cambridge Sound Works Model Six. The Overture Ones performed as well



**JBL HLS-810 and KEF Q-15**

as the Polks and even had deeper, more defined bass, but their higher price point didn't provide the value that the Polks did. The CSW Sixs were smooth, and harmonically rich, but were rolled off at the bottom and had a slightly distant politeness to them not present in the NHTs.

**SE Voodoo**

The magic midrange of the 300B tube was represented by our home brew single ended amp. This formidable looking amp has all the virtues and vices of single-ended amplification, a mid-range to die for, a lowly 8 watts per channel, whispery bass, and recessed treble.

Starting again at the economical end, we have two surprise favorites, the JBL HLS-810, and the KEF Q-15. The JBL HLS-810s were found to be contoured (exaggerated bass and treble), veiled and polite with our PP amp. While they did nothing really objectionable, they were in no way involving. When we plugged them

into the SE amp they came to life! The midrange of the 300B tubes came through. Where the music sounded rolled off with other speakers, the JBL's contour propped up the response providing a very balanced presentation. While just a little bit soft and veiled, they were nevertheless very musical.

The KEF Q-15s also sounded amazingly different with the SE amp. Our panel found them 2-dimensional, bright and ragged with the GW Labs 270. With the SE, all our panelists found them smooth, smooth, smooth. Great pacing, a respectable soundstage, and a sense of dimensionality made this speaker

stand out. Most of our panelists found the Q-15s very involving. A lone dissenter found them a little less musical, but said the sound vastly improved with the SE amp. This small speaker and amp combination did not produce a lot of bass, but would likely sound better in a smaller room that required less acoustical energy to fill out the bottom octaves.

Experiencing the Infinity Overture Ones was a real treat. They sounded very good with the push-pull amp but were a bit bright. With the SE, they provided some of the best music reproduction of the day. With their 8" woofer driver and built in 150 Wpc amp to drive them, the 300 B SE amp did not need to drive the lower octaves. The result was extended, detailed bass, with a balanced presentation of the rest of the spectrum. The objectionable brightness was replaced by a clean, dynamic, and complete sound. These speakers had us involved with the music very quickly. It was obvious to all

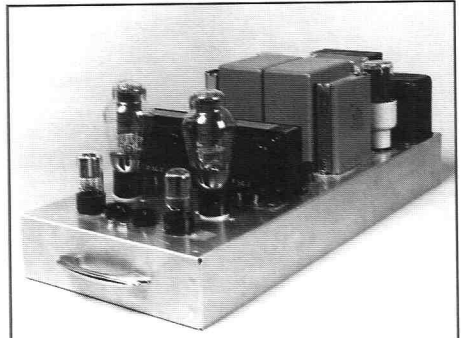

**John Eckland's SE 300B Stereo Amplifier**

the panelists that a very good match had been achieved. One panelist was very taken with these speakers and felt that they had great flexibility in how they could be positioned. With some effort, he felt, a room position could be found to bring out the best sound in many a den or living room.

**Switch Hitters**

We must tell you about two speakers which sounded darn good with both our amps. They also happened to be the most and least expensive speakers in our sample.

The Celestion A1s were an example of how good speakers can sound. While not perfect, they revealed more detail than the other speakers in this review. That detail allowed them to sound more open, smooth and spacious. At over two times the median price of the speakers in this review, it was not fair to call them the champ, but they were a great reference for our evaluations.

The Paradigm Titans are a marvel at \$219 a pair. They performed consistently on both the single-ended and push-pull amps. And while other small speakers edged the Titan out as our favorites, it gave them a real run for the money. This speaker provided a big soundstage and sounded great with whatever we hooked it up to.

**Just Desserts**

As a reward for our hard work (are you feeling sorry for us yet?), we treated ourselves to playing a few of the speakers through one of our favorite vintage amps, the Scott 299A. This sweet amplifier has a way of making almost all speakers sound lively and detailed. Both the Polk RT-55s and the Celestion A1s really took to this amp and provided the sound quality one expects from a room full of audio gear. The perfect antidote to the etched, high-current sound of modern megabuck hi-fi. It was a great way to end the day!



**Infinity Overture Ones**



**Salty Suggestions**

Please take our recommendations with salt liberally applied. These speakers sounded great in our test environment and with our amps. Your audio mileage may vary. With that said, here is what we found, and what we recommend:

The Celestion A1s were alone in their price range for this review. However, we really liked these speakers. They are amazingly well built, sounded good with the 300B amp, even better with the GW Labs amp and glorious with the Scott 299A. This speaker is best used with an amp that has a little tube muscle. It only takes a little, though, and then the A1s become a clean window for the rest of your system to shine through.

The Infinity Overture Ones are a great match for those low powered amps. If you don't have a lot of room for speakers, and you want the deep bass and flexibility of placement a bookshelf speaker provides, these speakers are the ticket. Designed for home theater, these speakers performed well, far from their intended purpose.

Polk Audio's RT-55 are a great value. That extra mid/woofer and larger enclosure is worth the extra few dollars. Performing best with the GW Labs amp, we liked the level of sonic refinement provided by the RT-55s at this price point. A great choice for your push-pull amps.

The JBL HLS-810s mated well with the 300B's recessed bass and treble. Often, 300B amps are paired up with expensive speakers. But the JBLs proved that a musical experience can be enjoyed for a little more than a song. The JBLs had a better bass presentation than the KEF Q-15s.

KEFs Q-15s were a lively musical match with the 300B amp, at about the same price point as the JBLs. The Q-15s held the upper hand in resolution and dynamics over the JBLs.

Cambridge Sound Works Model Six played best with the GW Labs amp, and we can appreciate its well mannered, balanced presentation. We felt that it was a bit too polite for our tastes, but would work well for those looking for a relaxed, full sound.

The NHT Super Ones mated well to the GW Labs amp. It made the most of its small size, providing a clean dynamic presentation. A great choice for push-pull amps in a smaller room.

The Paradigm Titan has received a lot of well deserved praise. We could find no argument to the contrary in a speaker at this price point that performs this well. A good economical match for your tube amplifier. This speaker has spunk!

We auditioned several speakers including NHT, Klipsch for which we did not find a suitable match for our tube amplifiers in our test environment. Rather than belabor the issue, we'll point out that these same popular selling speakers may excel in a home theater environment or when connected to a solid state amplifier. Our sincere thanks to those manufacturers for their participation in this review.

**Test Parameters and Hardware**

Room Size: 17' x 13' x 8' (LWH)

Speaker Position: 30" from long wall, 9" apart on 24" high sand-filled stands.

Front End: Marantz CD 63-SE (With

beefed-up power supply caps, Burr-Brown Op-Amps, upgraded signal caps, Schottky Diodes in power supply and anti-resonance modifications to the chassis.)

Cabling: DH Labs T-14 Silver Sonic speaker cable, DH Labs BL-1 Series II interconnects

Pre-Amplifier: VTV Octal Line Stage, 1 6SN7 per channel (See issue 11 of VTV for complete details!)

Amplifier #1: GW Labs model 270 ultra-linear push-pull design, producing 70 watts RMS per channel using 2 Svetlana 6550-Cs per channel. Torroidal power transformer, double C core output transformers.

Amplifier #2: DIY Single-Ended 300B designed and built by John Eckland of Palo Alto, CA. Output of about 8 Watts RMS per channel. Tango output transformers, 6SN7 driver tubes, Svetlana SV300B output tubes and oil-filled power supply capacitors.

Amplifier #3: Scott 299A (vintage 1959) push-pull 6BQ5/EL84 integrated amp, 17 watts RMS per channel. NOS Telefunken 6BQ5s driven by a pair of Sylvania 7687s. (See this issue for further details)

**Music Selections:**

*Garota de Ipanema* (Girl From Ipanema) Antonio Carlos Jobim, Performed by Joao & Astrud Gilberto. From The Antonio Carlos Jobim Songbook, Verve.

*The Pink Panther*, Henry Mancini. Performed by James Moody. From Moody Plays Mancini, Warner Brothers.

*Fanfare for the Common Man*, Aaron Copland. Performed by Louis Lane and the Atlanta Symphony Orchestra. From Copland, Telarc.

Each speaker pair was broken in with 40 hours of white noise and another 10 hours of music before the panel auditioned them. All speakers were auditioned with the GW Labs 270, before being auditioned against Johns 300-B amplifier.

**Listening Panel:**

Steve Parr, David Bardes, Charles Kittleson and Roger Coon

*David Bardes works for a major computer magazine, is a professional photographer, and a hi-fi loudspeaker enthusiast residing in San Mateo, California. (By the way, the photos in this article were done by David) Ed.*

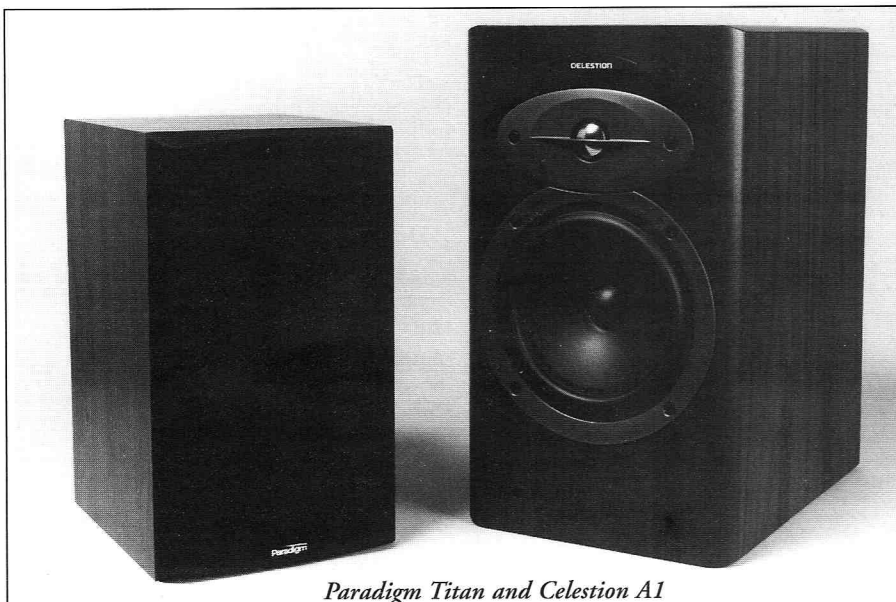

*Paradigm Titan and Celestion A1*

# A Review of Popular Guitar Amp Books

By Eric Barbour ©1999 All Rights Reserved

The first book on tube guitar amps was *Guitar Amplifiers* by Jack Darr, first published in the late 1950s. In recent years, though, the first edition of the Aspen Pittman/Groove Tubes *Tube Amp Book* led to a number of texts being published, covering more-or-less the same ground: basic descriptions of how an amp works, schematics, simplified tube data, and some modifications. Except for the Fliegler book, all of these were essentially self-published by their authors (or the author's company). So, like the Dan Torres and Kevin O'Connor books we reviewed in VTV Issue 5, these books are aimed at the beginner to intermediate skill level technician or enthusiast.

The first of the "modern" guitar amplifier series to appear (not counting the Groove Tubes book or a few "Tab" Books and the like) was Tom Mitchell's *How to Service Your Own Tube Amp*, in 1989. The current 1991 edition is a good beginning education on tube audio amplifiers, for those who already have some basic knowledge of electronics. If you are going to repair your amp, I feel that you should start with Tom's book, and READ IT. Cover to cover. It even has some history, plus accurate descriptions of electronic components used in guitar amplifiers.

Gerald Weber, the owner of Kendrick Amplifiers, is well-known on the boutique and custom-guitar amplifier scene. Many guitarists know him from his columns in *Vintage Guitar Magazine*. Weber has written two beefy books on the subject of guitars and amps. The first one is the

*Desktop Reference of Hip Vintage Guitar Amps*. Weber was the first to elaborate on detailed mods and repairs for a number of guitar amp makes and models besides the typical Fender and Marshall. He includes schematics and specific tune-up and repair info for Ampeg, Fender, Gibson, Magnatone, Marshall, Rickenbacker, Silvertone and Vox models. There is also a section on maintaining Echoplexes, replete with schematics--this alone makes the book worth having.

Weber's second book, *Tube Amp Talk*, starts with numerous chapters discussing basic electronic repairs and modifications for a variety of guitar and bass amps. *Tube Amp Talk* concludes with an interview of Weber, followed by a catalog of Kendrick's product line. *Tube Amp Talk* is a useful book, containing lots of tube, speaker and guitar amp information, lore and opinions. To sum it up: Weber's books are quite informative, and are very interesting reading for guitar amp collectors, musicians and technicians.

*Dave Funk's Tube Amp Workbook* focuses strictly on Fender designs. That said, it is probably the most thorough treatment of Fender amps ever printed. The bulk of it is a full set of schematics for pre-1975 Fender amplifiers, from the "5C1" Champ through the "AB763" Vibroverb. The schematics are clear and reasonably readable. At the end is a list of the part numbers for the transformers used in all the Fender models of this period. If I were a working guitar tech who wanted to learn about old Fenders, this book would be very useful. Word has it that Funk is working on newer books covering Ampeg and Marshall amplifiers.

Ritchie Fliegler's *Guide To Guitar And Amp Maintenance* covers amplifier information as well as the basic repairs and tune-tups for electric guitars, such as bridge adjustments, neck and fret setup, cleaning and polishing, and wiring repairs. The

guitar wiring information and diagrams cover mainly older Fender models. The amplifier section is a reasonably well-detailed set of instructions for basic troubleshooting of tube amps, plus about one-half page on solid-state amps, followed by speaker wiring data and cabinet repairs. It's not exhaustive, yet might be enough for someone who is looking for a combination of guitar and amplifier information.

Although it isn't a general guide, Kevin O'Connor's *Tonnes Of Tone* is worth mentioning as a suitable companion for his *Ultimate Tone* and *Principles Of Power*. "Tonnes" starts with basic construction techniques, and goes on to describe eight guitar amp projects. Acoustic-guitar preamps are covered by showing how to modify a tube guitar amp for piezo pickups, then a small JFET buffer preamp is described for installation in the guitar. Then we get excellent descriptions of a dual-channel 12AX7 guitar preamp, three different bass preamps, a push-pull 6L6 power amp, and a fairly conventional tube reverb circuit. All of these circuits are well documented, and should be easy for a hobbyist with moderate skills to build successfully.

Which book is the best? It depends on how deeply the guitar tech or musician wants to explore tube theory, guitar-amp design, history, restoration, and service. Each book is unique in its own way, so read them all and become really informed.

1. **A Desktop Reference of Hip Vintage Guitar Amps**, Gerald Weber, Kendrick Books, Pflugerville, TX, 1994, ISBN 0-9641060-0-0, 508 pgs.
2. **Tube Amp Talk For The Guitarist and Tech**, Gerald Weber, Kendrick Books, Pflugerville, TX, 1997, ISBN 0-9641060-1-9, 538 pgs.
3. **The Complete Guide To Guitar and Amp Maintenance**, Ritchie Fliegler, Hal Leonard Corp., Milwaukee WI, 1994, ISBN 0-7935349-0-9, 80 pgs.
4. **How To Service Your Own Tube Amp**, Tom Mitchell, Media Concepts, Norwalk CA, 1991, ISBN 0-962817-0-7, 258 pgs.
5. **Dave Funk's Tube Amp Workbook**, Dave Funk, Thunderfunk Labs, Waukegan IL, 1996, ISBN 0-9650841-0-8, 424 pgs.
6. **Tonnes of Tone**, Kevin O'Connor, Power Press Publishing, London ONT, Canada, 1996, ISBN 0-9698608-2-X, 116 pgs.

*A special thanks to Antique Electronics Supply for providing the guitar amp books covered in this review.*

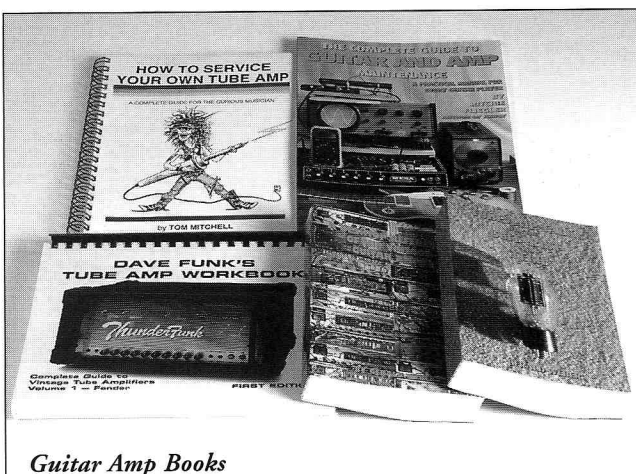

Guitar Amp Books

# H.H. Scott 299 & 299B EL84 Stereo Amplifiers

By Charles Kittleson ©1999 All Rights Reserved

## In the Beginning

Home hi-fi really gathered momentum in the late 1940s. Better speakers, transformers and circuit designs all made the quest for musical realism more accessible to the hi-fi enthusiast. During this era, Hermon H. Scott started a hi-fi equipment and test instrument manufacturing operation in Cambridge, Massachusetts. Scott, an MIT graduate during the early 1930s, was initially employed by General Radio Company where he developed the RC oscillator, sound level meter and many other audio and electronic innovations.

The first commercial H. H. Scott amplifier was the model 210A Laboratory Amplifier (1948). This instrument was a 6L6 push-pull 20 watt unit featuring the famous Scott Dynaural Noise Reduction, designed to reduce the surface noise from 78 rpm records. The 210 series was continued until the late 1950s with the 210E which used push-pull EL34s. In 1953, Scott introduced the 99A Transcription Amplifier, the first "flat" styled amplifier designed with all the tubes enclosed and the output tubes mounted horizontally out the back. The 99A produced 10 watts from push-pull 6V6GTAs and featured switchable Rolloff and Turnover phono equalization. The 99 series was continued until the early 1960s with the 99D, a 24 watt unit using 6L6GBs.

Stereo records became a commercial reality in 1957 with the introduction of stereo discs by Audio Fidelity Corporation of New York. Mono hi-fi system diehards

claimed that stereo was just a conspiracy devised by the equipment manufacturers to sell more amplifiers and speakers. Many others were swept off their feet during hi-fi trade show demonstrations and retail audio shop listening sessions showcasing the "stereo" effect. Early stereo setups were a complicated maze of wires, mono amps, mono preamps and stereo adapters. As a result, the need for packaged, one-piece dual channel amplifiers was created.

H.H. Scott was in a growth mode in the mid-1950s due to increased consumer enthusiasm about hi-fi. In 1957, Scott moved from Cambridge to Maynard, a small mill town west of Boston. Scott built a new 30,000 square foot facility that was capable not only of electronic assembly, but also housed a machine shop for chassis fabrication and a transformer winding operation. The new facility was completed just in time to handle the increased demand from the emerging stereo equipment market.

## 222 and 299 Circuit Design

Daniel von Recklinghausen began his career as an audio design engineer with H.H. Scott in 1951 soon after graduating from MIT. He was intimately involved in most of the audio designs Scott produced from 1951 through 1973, when the company was sold to Emerson Electric. Daniel was assisted by Peter Globa, a Ukraine engineer who emigrated to the USA from Brazil and was hired in 1956. From the beginning, H.H. Scott pursued and

achieved audio excellence. His attention to detail, good sounding circuit design and component selection was evident in all Scott products.

The concept for a Scott stereo amplifier probably began sometime in 1957. The first stereo amplifier was the legendary model 299, introduced in mid-1958. The lower power, less expensive 222 was introduced a few months later. The design and execution are excellent examples of quality American audio engineering. It was built with craftsmanship to last a lifetime.

Most music in the late 1950s was played using either stereo or mono LPs and 78 records, so the phono section of an integrated amplifier was very important. The 299 phono stage was a product of 10 years of progressive experience with previous designs. Von Recklinghausen went for a conservative design using two super quiet Telefunken ECC83/12AX7A dual triodes. Telefunken used a process during manufacture that reduced barium getter deposits on the control grid, thus minimizing electrostatic and mechanical noise. In addition, Telefunken tubes were made with precision and strict QC standards to reduce variations in individual tubes. The phono stage utilized frequency-selective negative feedback in the pre-amplifier stage. Positive feedback was used from the cathode of the second ECC83 triode to the cathode of the first triode. This design brought overall loop gain up and produced a rich, musical mid range with good response on the frequency extremes.

The tone control stage has two ECC83s and uses separate bass and treble Baxandall-type tone control circuits for each channel followed by another stage of amplification. This is fed into the gain control and the loudness-volume switch. Scott operated all four ECC83s with DC on the filaments for a significant reduc-

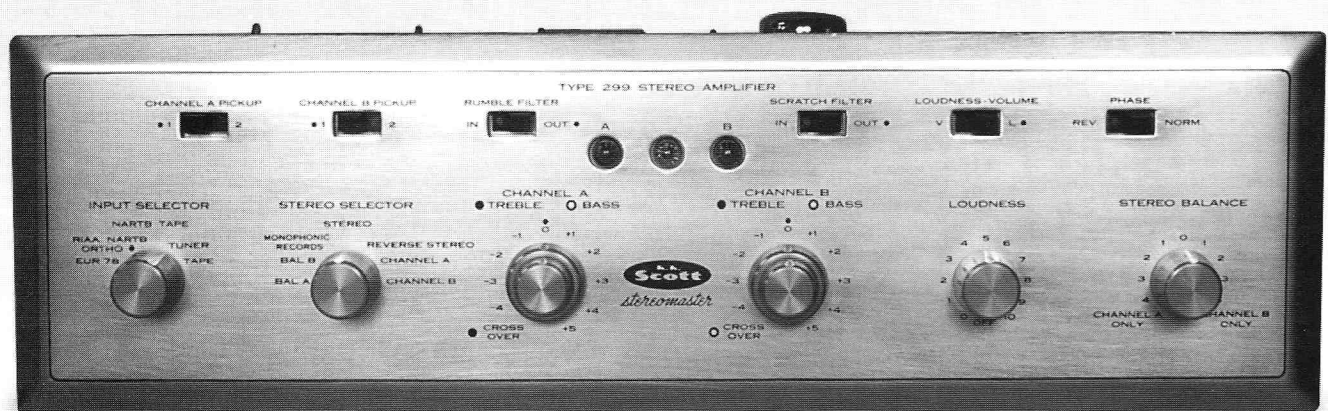

H. H. Scott 299

# Now! The Most Important Product Announcement in the History of H. H. Scott!



Here are the exciting details on

## The Stereo Amplifier that sets the Standards for the Next Decade!

The H. H. Scott engineering laboratories proudly introduce the new Model 299 40 watt stereophonic amplifier and control center. It contains many advance features that not only meet the needs of today's stereophonic program sources, but anticipate the requirements of the future. Check the details of this new amplifier, and see for yourself why the new 299 is superior to any other amplifier available.

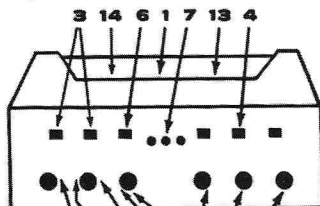

1 40 watt power stage consisting of dual 20 watt power amplifiers. You need this much power to meet the requirements of today's speaker systems. 2 Completely separate Bass and Treble controls on each channel so that different speakers may be matched. 3 Provision for connecting both a stereo phono cartridge and stereo

tape heads. 4 Phase reverse switch to compensate for improperly phased tape recordings or loudspeakers. 5 Special balancing circuit for quick and accurate volume balancing of both channels. 6 Separate record scratch and rumble filters. 7 Unique visual signal light control panel. Instantly indicates mode of operation. 8 Can be used as an electronic crossover (bi-amplifier). 9 Special compensation for direct connection of tape playback heads without external preamp. 10 Special switching lets you use your stereo pickup on monaural records. 11 You can play a monaural source such as an FM tuner through both channels simultaneously effectively doubling power. 12 Loudness compensation. 13 Stereo tape recorder output. 14 D.C. filament supply for preamp to virtually eliminate hum (80 db below full power output). 15 Distortion (first order difference tone) less than 0.3%.



Size in accessory walnut case: 15 1/2" w x 5" h x 12 1/2" d. Price \$199.95. (West of Rockies \$204.95)

Write for complete technical specifications and new catalog A-2.



H. H. SCOTT, INC.  
111 POWDERMILL RD., MAYNARD, MASS.  
EXPORT: TELESCO INTERNATIONAL CORP.  
36 W. 40TH ST., N. Y. C.

tion of hum. The selenium bridge rectifier supplied DC for the filaments and negative bias voltage for the output tubes. After the gain control, the signal fed into the phase inverter stage.

Most vacuum tube research in the 1950s and early 1960s was for television applications. Nine pin miniature tubes including the 6GH8, 6BL8/ECF80, 6U8 and 6EA8 were originally designed for home television sets. They eventually found their way into audio applications in the mid-1950s in Dynaco, Fisher, McIntosh, etc. audio equipment. In order to save precious chassis real estate, Scott chose to use ECF80/6BL8 triode-pentode tubes for the integrated amplifier driver and phase inverter stages. To allow for better fine-tuning of the amplifier, a voltage-type divider phase inverter circuit design was employed.

The output stage in the 299 used the relatively new 7189 nine-pin miniature output tube (a higher voltage-rated version of the EL84/6BQ5). Output tubes were configured in push-pull tetrode in fixed-bias mode. The 299 utilized several adjustment pots for fine-tuning the output stage including output tube bias, DC balance, and AC balance.

### Power Supply and Capacitors

There was lots of reserve capacitance in the 299 design. The 299 had five Sprague multi-section electrolytic cans mounted on the top of the chassis. This allowed for quicker reserve power recovery during demanding musical transients. Additional filtering also improved decoupling, channel separation, and overall fidelity.

The power transformer was made by Stancor and designed to operate at a 40 degree centigrade (150 degree F) rise operating temperature. In the Scott 299, the power transformer was mounted with laminations perpendicular to the top of the chassis. The 299C and D had the transformer mounted parallel to the top of the chassis.

Coupling and bypass caps initially were the paper and foil "striper" plastic molded types in Scott mono gear. In the Scott stereo amplifiers, they chose to use the white ceramic American Radionic mylar and foil types. These caps are notorious for failure and all of them should be replaced if you plan to use the amplifier.

### Output Transformers

Von Recklinghausen designed the transformers used in the 299. His spec was for a transformer that was not saturable at rated power and capable of both good low

H. H. Scott 299 Type 1 Chassis



and high frequency response. The proper size of the laminations and core density were very critical to achieve this performance. Von Recklinghausen used scramble windings on both sides of the primary for improved tonal balance.

### Golden Era Styling

H.H. Scott home audio products produced in the 1950s and early 1960s were very attractive and stylish. 299s sported a beautiful one-piece champagne gold anodized formed aluminum faceplate with black lettering. The original Scott "champagne gold" styling was introduced in 1954 by Victor Pomper, VP of Marketing for Scott. One of the problems with the anodizing process was color matching. Different anodizing batches ranged from a dark copper-red to a light gold champagne appearance. Dealers of the era found that if a customer bought a Scott amp with a darker anodizing finish, it was tougher to sell the customer a matching tuner with a lighter finish.

The 299's gold anodized solid aluminum machine-turned knobs were actually made in the Scott factory with a screw machine. The 222 and some other models used brown bakelite knobs with gold rims that were manufactured in Germany. Later versions such as the 222D and 299D used the fluted bakelite knobs with metal caps.

### Scott 299

Probably the most popular stereo tube integrated amplifier series ever produced, the 299 was an audio sensation that changed the course of home hi-fi stereo.

There were six control knobs, two of them dual-ganged type, six slide switches and three function lights. Controls included from left to right, input selector, stereo/mono selector, bass/treble for channel A, bass/treble for channel B, stereo balance and loudness. The three pilot lights enabled the user to know at a glance whether the 299 was operating in one of the seven operating modes: true stereo, reverse stereo, simulated stereo, etc.

There were four inputs per channel including two for magnetic phono cartridges, one for tuner and one for tape heads. The magnetic inputs were switchable between either one, allowing for use of either a record changer or a turntable. The second magnetic input had two jacks, one for low level cartridges and one for high level cartridges. The speaker output terminals will handle either 4, 8 or 16 ohm loads. Speaker loads were changeable by an external jumper terminal for each channel. The 299 also featured a center channel output for a third amplifier and speaker. This "three channel" stereo system gave the listener a very impressive "wall of sound" effect.

Von Recklinghausen noted that Scott made amplifiers and tuners in batches of 1,000. One production batch would be tuners and when it was completed, they would switch to building amplifiers. There were actually two versions of the 299 sold. The first version (pictured) was produced through the first 8 months of 1958. It is estimated that approximately 8,000 to 10,000 Type 1 299s were made.

A pair of output transformers were mounted one behind the other with the output tubes installed in a row right next to the transformers. The part number of these transformers is TRA-8-3-1 and they are smaller in size compared to the later versions. Apparently, these transformers could have been made in-house by Scott as they have 100 stamped where the manufacturer EIA code should be.

Scott introduced a second version of the 299A in late 1958, apparently for the 1959 model year. It is estimated that approximately 8,000 to 10,000 of the Type 2 299s were made. This version used different appearing and slightly larger output transformers (part number TRA-8-4) that were mounted at the back of the amp, horizontal to the rear panel. The later transformer has better specs, but they do sound fairly similar.

Factory power ratings for the 299 were 20 watts per channel with harmonic distortion at 0.8% at full power output. Maximum sensitivity was 3 millivolts for rated output. Frequency response was rated at 20 to 30,000 Hz with noise and hum at better than 80 dB below full power output. Dimensions of the accessory case were 15 1/2" wide x 5" high x 12 1/2" deep.

*Audio Magazine* reviewed both the Scott 299 and the 222 in their November 1959 issue. Right out of the box, their review sample had fairly high distortion in one channel. After adjusting the AC balance control to the phase inverter, distortion in that channel decreased significantly. After adjusting the AC balance control for best performance, the official measurement for the 299 was as follows:

1. At 1000 Hz, 0.19% IM distortion at 1 watt, 0.23% IM distortion at 10 watts and 1.4% IM distortion at 15 watts.
2. With gain on maximum and tone controls flat, response was 2 dB down at 20 Hz and 3 dB down at 20 KHz.
3. Signal to noise on the high-level inputs was 72dB with an input of 0.5 volts at 1000 Hz. Signal to noise on the phono stage was measured at 63dB.

### Scott 299B

As a result of "new model" pressure from the marketing department, Scott introduced the 299B in the summer of 1960 for the 1961 model year. The faceplate was slightly different with a newly designed Scott logo and another slide switch added to the center of the panel. The knobs were still gold anodized turned

aluminum, but were more rounded looking and similar to the knobs used on the 299C. The three neon pilot lights were new flat-faced non-fluted plastic. New features included tape monitoring facilities and an additional high-level input for use with an electronic organ. Power rating was boosted from 20 watts per channel to 25 watts per channel (Institute of High Fidelity Manufacturers standard). In reality, this power rating was probably optimistic by 25%. In addition, the mechanical layout of the chassis, including placement of tubes, ceramic dropping resistors, filter capacitors and transformers, was changed.

Output transformers were larger in size, and apparently the power of the amplifier was increased to a rated 25 watts. The driver stage had a slightly different circuit design. It is estimated that less than 10,000 299Bs were made.

For the 1962 product year, Scott introduced the 299C, which featured octal-type 7591 output tubes. Power rating went from 25 watts per channel to 40 watts per channel (IHFM). This, as well as the 299D, LK-72 and LK-72B, will be discussed in a future issue of VTV.

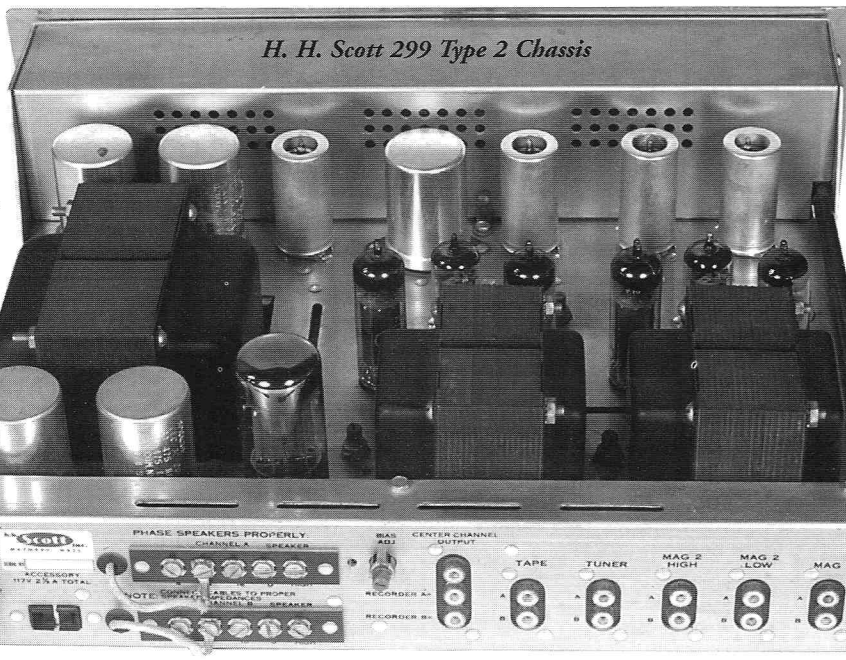

have a balanced sonic spectrum, great bass response for EL84s and detailed, extended highs. They work well with speakers that have an efficiency of 91dB or greater.

### Owning and Upgrading a 299

If you are looking for an easy to maintain and compact amplifier, a Scott 299 or 299B is an excellent choice. They are currently easy to find in want ads and on eBay.

### How Does the 299 Sound?

As von Recklinghausen told me, "sine and square waves are pretty dull. It's what happens with musical transients that makes the difference." Scott spent a lot of time and money to ensure that the 299 would make great music. Attention to detail was obvious. In fact, according to von Recklinghausen, Scott brought in professional musicians including members of the Boston Symphony for listening evaluations of Scott amplifiers during product development. Not only does the 299 sound great, but it is extremely versatile. In my opinion, the 299 and 299B Scotts are two of the best sounding vintage EL84 integrated amps ever produced. They are very lively, involving, sweet, and musical. In addition, they

Typical 1999 price should range from \$150 to \$400 or more for an unrestored amplifier. Buying a restored and rebuilt one will cost more. I have recently noted in *MJ Magazine* (a high-quality Japanese audio publication) that companies like Sansui, Marantz and Luxman have introduced tube stereo integrated amplifiers. These look surprisingly similar to early 1960s Fisher and Scott amplifiers, but with modern components. However, the cost in Japan for these tube integrations ranges from \$3500 to \$6000! At those prices, a Scott 299 is a bargain.

Because 299s and 299Bs use inexpensive EL84/7189s, output tube replacement will not break the bank. A few recommended vintage speakers to use with a 299 include: AR-4X, most Bozak models; Dynaco A-25; most Electrovoice models and KLH 23, 24, and 32. For modern speakers, see our bookshelf speaker review in this issue.

Remember that if you purchase a 299, **Do Not Plug It In** until you have checked it out and rebuilt it. When upgrading a 299 here are some steps to follow:

1. Remove all tubes and clean chassis with compressed air or a soft clean brush. Clean and lubricate all contacts, controls and switches with Cramolin R-5 or similar product. Check all tube sockets and re-tension them using a dentist's pick or similar tool.
2. Remove and replace all white or striper tubular ceramic or molded plastic "striper" signal capacitors one at a time

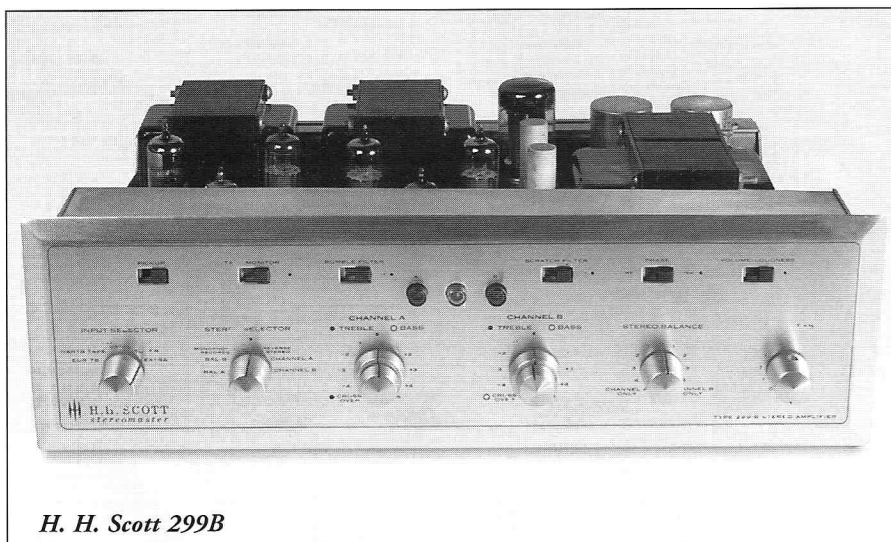

H. H. Scott 299B

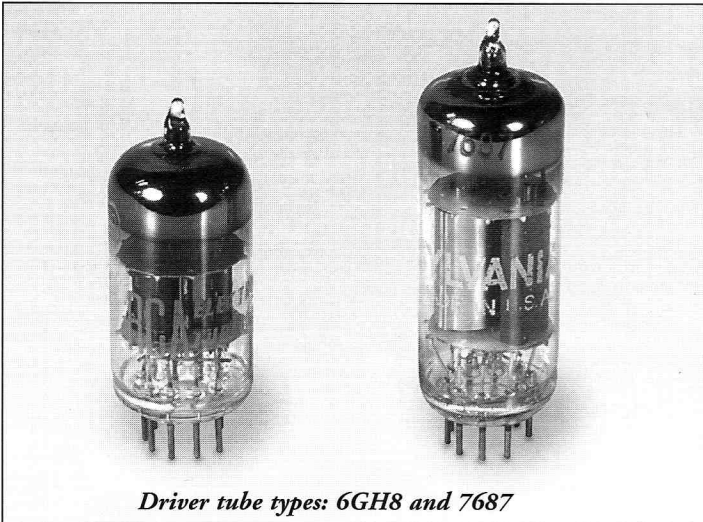

*Driver tube types: 6GH8 and 7687*

to avoid making a mistake. Replace them with good quality modern film and foil capacitors. I have had excellent results with Illinois Capacitor ICMWR foil and film types. They retain the vintage sound and are very reasonably priced. Replacing all the caps with expensive premium foil and film caps can be a mistake because they can change the original sound characteristics.

3. Check and replace all carbon-composition plate resistors in the phono and tone control circuits with 1% low noise carbon or metal film types. It is best to experiment with the type of resistor that sounds the best to you. Using all metal film types can cause the sound to be too hard or irritating.

4. Replace the selenium bridge rectifier (filament and bias supply) module with a newer silicon diode bridge. The original selenium bridge is located on a side mounting bracket under the chassis. Replacement is essential because the older selenium bridges usually develop high series resistance, thus lowering bias voltage. This can cause your output tubes to draw too much current and overheat, causing plates to turn red or orange. Allowing any tube amplifier to operate in this condition will burn out transformers. You may have to add a series dropping resistor to compensate for the lower voltage drop of the silicon bridge.

5. Clean all tube sockets and tube pins with solvent, R-5 or suitable material. Check and replace all tubes that test bad. The original phono and tone

control tubes were probably Telefunken ECC83/12AX7s. Finding these in NOS condition could be costly. It is OK to use newer US or import 12AX7s as long as they test well and are quiet.

The driver tubes were either 6GH8 or 6BL8 triode-pentode nine-pin miniatures in the original Scott amps.

It is possible to substitute a 6U8A or 6EA8 in this position. A better substitute (if you can find it), is the Sylvania 7687 (see photo) triode-pentode which is a superior plug-in replacement for the above types. The gain of both tube sections is slightly different, but the sonic improvement is incredible. Just adding a pair of 7687s will give you more headroom, better bass, high frequency extension, and a more 3-D soundstage.

The output tubes were originally Amperex Bugle Boy EL84s made in Holland. These are now very rare and

expensive. As modern replacements, the Sovtek EL84s and the JAN/Sylvania military surplus 6BQ5s are good performers. The original GZ34 rectifier was made either by Amperex or Mullard which are both costly. You can use the Chinese 5AR4 but be sure to check it in-circuit first because these can have a relatively high failure rate.

6. Check all can-type electrolytics for leakage by measuring current draw while forming them on a regulated DC supply. Any electrolytics that have leakage of over 5-10mA at rated voltage should be replaced with newer cans or under-chassis axial electrolytics.

7. Check all wiring and soldered wire terminations for crumbly solder joints or shorts. When ready, bring the amp up slowly on a variac. If it passes the smoke test, hook up your input sources, connect your speakers, and then enjoy the music!

**References:**

1. **Audio Magazine**, Scott 299 and 222 Amplifier Review and Test, November 1959.

*A special thanks to Daniel von Recklinghausen, former Vice President of Engineering at H. H. Scott, for his assistance with this article.*



*Cartoon by Jack Elliano*





# 30 Watts Push-Pull with Svetlana SV300Bs

By Kevin Kennedy ©1999 All Rights Reserved

## Introduction

I think many, if not most, of the sonic benefits of single ended operation can be realized in a DHT push-pull amplifier, as long as very high quality iron is employed and global feedback is not. Power supply performance is a crucial ingredient in the overall sonic performance of an amplifier, and for this reason I employed tube based voltage regulation in this design. The amplifier design is fully differential in nature, and may be driven by either a balanced source or unbalanced source.

Although output power is only 30Wrms, these amplifiers sound much more powerful with my planar speakers than I have any right to expect. I must attribute a lot of this to the excellent performance of the SV300Bs, and the fine quality of the Citation II output transformers used. This design is targeted at those who own moderately inefficient high end speaker systems, but neverthe-

less recognize the seminal virtues of DHT triode amplifiers, and in particular the virtues of the 300B tube family.

My goal was to design an amplifier of high resolution, accuracy, and tonal correctness without the harshness of some designs or the euphony of others. Equally important is the fact that no exotic parts except for the Citation II transformers are required for this level of performance, and that the design is simple enough to allow replication by almost anyone skilled with a solder iron and a few hand tools. No exotic test equipment is required to get them operating, just a simple multimeter as a minimum.

I chose the 300B output tube because I feel it is hard to better its sonic virtues and exemplary electrical performance. I also wanted to avoid extreme drive and supply voltage requirements for this design. I chose the Svetlana 300B because it performs electrically and soni-

cally about as well as the few vintage WE300Bs I have come across, and at less overall cost. It also exhibits exceptional consistency, bias stability, and quality of construction.

The amplifiers are extremely neutral, detailed, and open. Perhaps the best I have yet heard in my own system. Imaging and sound stage depth are amazing, microdynamics, and dynamics seem just right. Clarity of reproduction is extremely pleasing. Tonal balance is pleasingly neutral with no particular emphasis to any part of the spectrum.

Amusingly, I have started to notice some not so subtle, but previously inaudible, shortcomings in a few of my favorite recordings, such as small extraneous noises: electrical clicks and pops, rustling sheet music, footfalls, as well the studio or venue noise floor. I listen to a variety of music, including classical, jazz, pop, funk, and grunge rock, and these amplifiers seem to be at home with it all, and are particularly good at capturing the subtleties of female vocalists, and the natural timbre of acoustic, percussive and wind instruments.

## Technical Description

The topology employed is conventional in most senses, as the goal was to keep the design as simple as possible without compromising within reason on bandwidth or output tube drive capabilities. Available gain is such that 1.0Vrms of unbalanced drive, and 500mVrms balanced drive should be sufficient to drive this amplifier to full output, making this design suitable for use with active as well as some passive pre-amplifiers, and buffered designs having no actual voltage gain.

These units were built as monoblocks, and are completely self-contained. The power supplies and other required circuitry are on the same chassis with the amplifier circuitry. Layout is crucial, and for this reason the power supplies are located on the rear area of the chassis, the output stage towards the middle, and the input and driver stages at the front. All AC wiring near sensitive circuitry is fully shielded to keep hum and noise away.

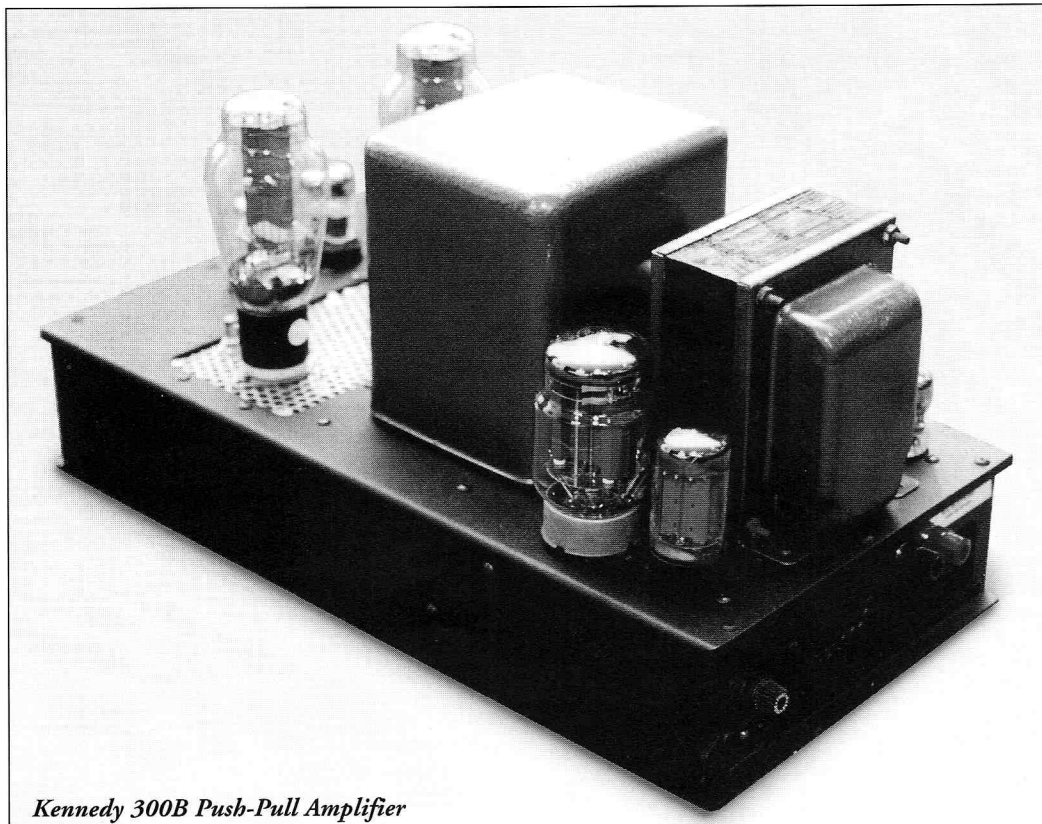

*Kennedy 300B Push-Pull Amplifier*

The differential amplifier tubes and input sockets are deliberately located to one side of the chassis, far way from the AC switch. The chassis as designed are fairly compact at 8.5" wide x 17" long. In order to make this practical, careful attention was paid to ventilation. The 300Bs are mounted on a perforated stainless steel platform which is mounted in a rectangular cutout in the chassis. Insurance against setting the amplifiers down on a soft surface (such as carpet) is provided by ventilation apertures in both ends of the chassis. These apertures are protected by a perforated metal sheet, and as a result, these amplifiers run very cool. However, unless you are prepared to make similar provisions, the use of a considerably larger chassis is recommended to avoid compromising the life of the 300Bs and other components.

The first amplifier stage is a differential amplifier (long-tailed pair) employing a 6SL7GT, and operating at a quiescent current of 1mA per section. No current source is employed as this runs counter to my philosophy of keeping the circuit path as simple as reasonably possible. In previous experiments it became clear that using a simple large valued resistor in the long tailed pair only reduced common mode rejection by a few dB, and had no measurable impact on stage balance, provided that the tail resistance is large relative to the internal cathode resistance. A combination of fixed bias (represented by the tail tied to the -200V rail) and self bias provided by the individual cathode resistors tied to the tail resistor, provides a reasonable measure of dc balance even with some unmatched tubes. Some minimal tube matching is recommended. Stage gain is typically 22dB with unbalanced drive, and 6dB greater with balanced drive.

The differential driver stage is direct coupled to the preceding stage, and like the input stage relies on a combination of fixed and self bias for the same reasons as outlined previously. Overall gain in this stage will be in the

range of 14dB. Quiescent current is 3.4mA per section, and the total output current from the driver stage at clipping is approximately 0.35mA peak, excluding the loading due to miller capacitance in the 300Bs (Miller + grid to filament capacitance is estimated to be 70pF.) Full signal bandwidth at this point is 80KHz @-3dB, and 170Vpp per plate, without the 300Bs installed. Cathode followers are not employed, as I felt that the standing current in the 6SN7 differential driver stage should allow for sufficient output current to drive both the Miller capacitance of the 300B as well as the current requirements of the 221K grid bias resistors.

The output stage employs a pair of Svetlana 300Bs in push-pull, operating in class AB1 at a quiescent current of 80mA per tube. Fixed bias is employed, and each tube has its own filament winding to allow for easy bias measurements. AC heating is employed simply because I prefer the sound of DHTs that way, and push-pull operation will cancel most of the hum so induced, as the filament hum is a common mode signal.

The Citation II output transformers employed are excellent quality devices with a primary impedance of 3.3K ohms.

The Peerless S-275, by Magnequest, would be another good choice based on performance specifications, and has a primary Z of 4K. A less expensive alternative is the Brooklyn B23 also with a 4K primary impedance, and the least expensive alternative is the Hammond 1650K/KP. The Bartolucci 123, with a primary Z of 3K, may produce slightly more output power, with a possible small penalty in terms of THD.

There is no global feedback used in this design because it is typically detrimental to sound quality. One of the key issues in this application is that the primary inductance should be quite high relative to the plate to plate impedance. Values of 150H and above are not unreasonable to prevent excessive distortion at low frequencies.

There are three regulated supplies in this design: two tube based high voltage regulators, and one solid state regulator for the driver and input tube filaments. Power supply design is crucially important to the performance of this (or any) amplifier, and a lot of attention was devoted to this issue. These supplies offer excellent performance in all areas relevant to audio amplifier design: tight regulation, wide bandwidth, low output imped-

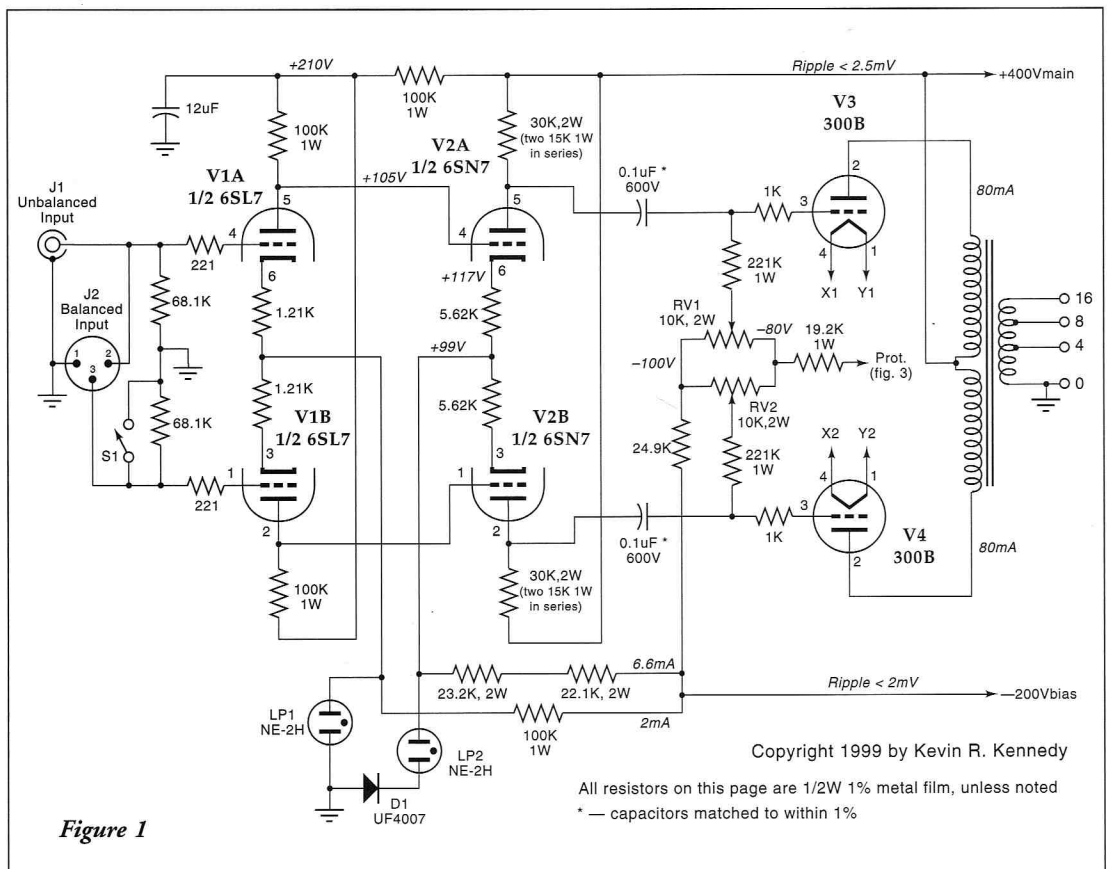

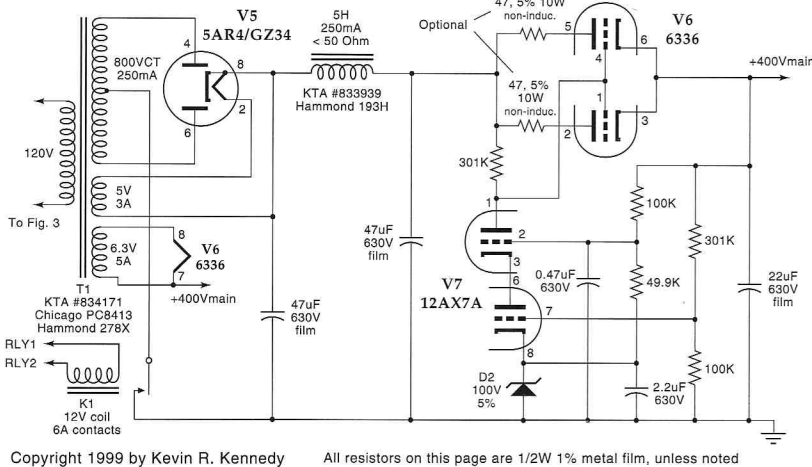

Figure 2

ance - just a few ohms at dc, good to excellent ripple rejection, and low noise.

The regulated plate supply offers a continuous capacity in excess of 250mA, the limit of the 5AR4 rectifier chosen - perhaps two might be paralleled if desired for greater capacity. The raw supply is rectified by a single 5AR4 and then applied to a pi filter consisting of two 47uF film capacitors and a 5H choke.

The pass element is a parallel strapped 6336/A/B, and the error amplifier is a 12AX7A connected in a cascade configuration for high open loop gain, and good voltage standoff ability. Output voltage is +400Vdc, with loadline regulation of better than 1%, and ripple levels of 2.5mVpp or less under load. Output impedance calculates to 2 or less from dc on up, and is capacitor dominated at high frequencies. No electrolytic capacitors have been employed in this regulator. Interaction between the power amplifier and its supply has been greatly reduced by virtue of its low output impedance.

The bias supply is based on a single 6U8A, fed by a 600PIV solid state bridge rectifier. The pentode section functions as the pass element, while the medium mu triode serves as the error amplifier. The pentode pass element's screen supply is heavily filtered to allow the pentode to provide a high level of ripple rejection prior to the application of loop feedback. The regulator can source up to 20mA at 200V for the output tube bias, input stage bias, and driver stage negative supplies. Ripple and noise are typically < 2mVpp, and warm up time is typically less than 40 seconds, handily beating the main plate supply time constant.

Note that protection against bias supply failure and delayed B+ during bias supply

warm up should be provided as shown in the schematics. Optionally this relay may be installed in the primary leads of the main power transformer if desired. However, if you contemplate substituting a 5U4 for the 5AR4 specified, this may cause problems with the 6336 cathode stripping. If this feature is omitted altogether a 300mA fuse must be installed in the center tap lead of the plate supply transformer.

Most of the tubes have dedicated filament windings on their respective supply transformers, and all tube filaments including the 300Bs operate on AC, except for the driver stages which have a tightly regulated 6.3Vdc filament supply.

**Amplifier Specifications**

Voltage Gain: 20dB unbalanced, 26dB balanced

Input Impedance: 68.1Kohm Balanced or Unbalanced Inputs

Frequency Response: + or - 0.5dB 20 - 20KHz small signal

Power Bandwidth:

1W : -3dB @ 33KHz

25W : -3dB @ 33KHz

Harmonic Distortion:

1W : < 0.16% thd @ 100Hz, 1KHz, 10KHz.

10W : < 0.35% thd @ 100Hz, 1KHz, 10KHz.

25W : < 1.0% thd @ 100Hz, 1KHz, 10KHz.

Noise: < 1mVpp, typical into 4 ohms

Maximum Power into 4 ohms: 31Wrms at 2% thd and 1kHz

*Notes: All measurements performed with unbalanced RCA input mode selected, and Citation II output transformers.*

**Construction & Testing**

This design includes circuits that operate at lethally high voltages, and extreme caution in the construction and testing of this, or any tube amplifier is required! The death you prevent might be your own. No liability by the author or *Vacuum Tube Valley* will be assumed for injuries or property loss while constructing or using this circuit.

Please note that this design is provided for the use of hobbyists only. No commercial use of this design is permitted.

In terms of constructing this amplifier it may be useful to think in terms of individual circuit blocks. There are actually five blocks to consider: the first block is the 300B based output stage, the second block is the input stage (perhaps the most critical of all), the third block is the +400Vdc regulated supply, the fourth block is the -200Vdc bias supply, and the fifth block is the dc filament regulator, filament supplies and fault protection. Individual circuit blocks may be tested before proceeding to the next stage if desired. Testing of the actual amplifier circuitry requires that the power supplies be built and debugged first.

**Amplifier Circuit Theory**

**Input Stage, Driver Stage, Neon Clamps, 300B Coupling & Bias Circuitry**

The first and second blocks are present in the first schematic (Figure 1, page 26) and consists of the 6SL7 based balanced input stage, a +200V supply decoupling capacitor, the 6SN7 based driver stage, two neon lamps which serve as protective clamps for cathode insulation protection in V1 and V2 during warm-up, and the 300B push-pull output stage. Neon lamps LP1, LP2, and diode D1 must not be omitted! Immediate destruction of the cathode to filament insulation in V1 and V2 will result. These devices serve to clamp the cathodes to safe voltage values, during filament warm up. LP1 ceases conduction once V1 warms up to the point where normal plate current is flowing, and D1 prevents the neon LP2 from conducting during normal operation of V2 by becoming reverse biased. These neon lamps should extinguish once the tubes warm up.

The 6SL7 first stage functions both as a phase splitter and provides most of the voltage gain in this amplifier. The plate voltage on this stage should be approximately 105V + or -5%, and should be matched to within + or - 2.5%. R103 and R104 provide both a limited amount

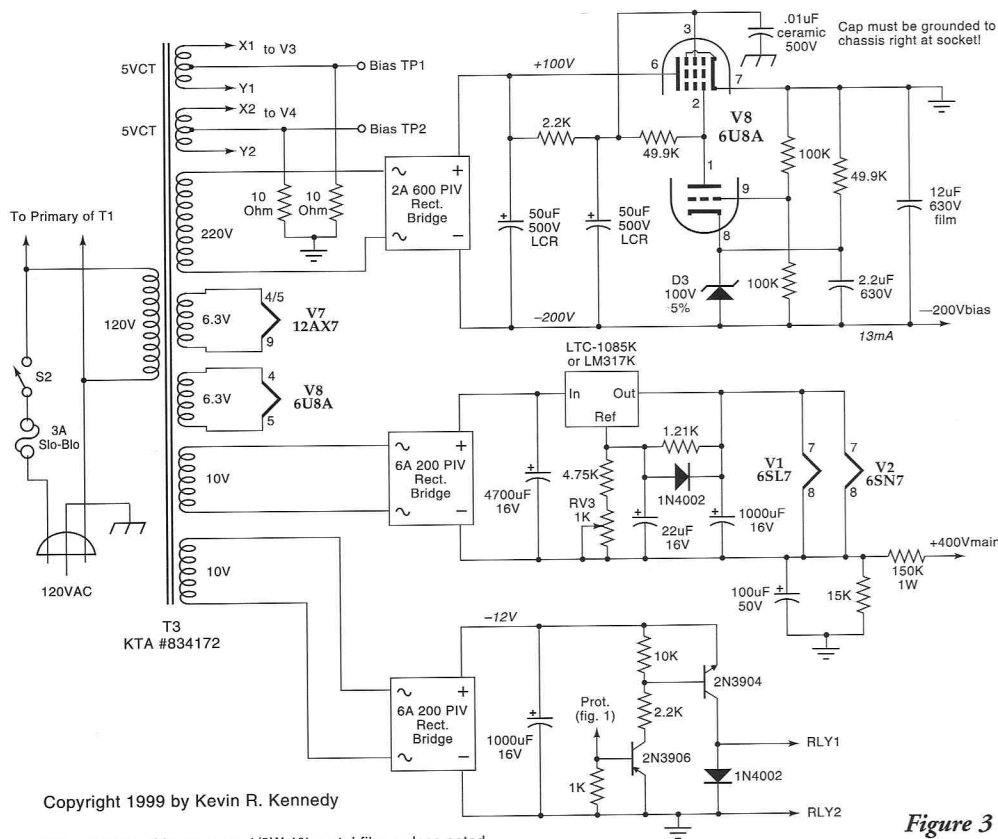

Copyright 1999 by Kevin R. Kennedy

All resistors on this page are 1/2W 1% metal film, unless noted

Figure 3

of cathode degeneration and help to correctly bias V1. This stage may be tested by removing V2 at which point the plates should be capable of swinging at least 40Vpp per plate, and should swing 20Vpp per plate with 1.4Vpp at the RCA input, with switch S1 in the closed position.

The second stage consists of a 6SN7 running as a differential amplifier, and primarily serves to develop the large voltage swings required to drive the 300B output tubes to full output. R113 and R114 are tied to the negative bias supply and act as a 4W power resistor. (This resistor dissipates ~ 2W in normal operation) The purpose of the connection to the bias supply is to allow the use of a large common resistance to assure good AC balance in this stage despite the presence of the largish 5.6K cathode resistors which provide some self bias in addition to the fixed bias created due to direct coupling the first stage to the driver stage. This provides adequate voltage swing at the grids of the 6SN7 to assure linear operation at the maximum plate voltage swing required. This stage should swing at least 170Vpp linearly per plate before any observable clipping occurs, and 180Vpp is typical. Bandwidth at this stage should be greater than 80kHz @ -3dB without the 300Bs installed.

The output stage consists of a pair of Svetlana SV300B in push-pull driving an output transformer of at least 3K primary impedance. The output stage is capacitively coupled to the 6SN7 driver stage, and employs fixed bias. Each 300B has its own independent bias adjustment pot, the component values chosen allow an adjustment range of -80V to -100V, with -82V resulting in about 80mA (+400V plate) of plate current per tube. If necessary, resistor value may be decreased slightly in order to change the bias range if you cannot adjust the plate current to 80mA per tube. These component values were chosen to prevent destruction of the output tubes should the pots be mis-adjusted. Small, high quality film caps of 0.1uF - 0.22uF/250V minimum may also be added between the pot wipers and ground if desired. 10 ohm 5% 1W carbon composition resistors selected to 1% are used to sample the cathode current, and are inserted in series with the individual 300B filament winding center taps. The bias pots are adjusted until 800mVdc is measured across the cathode resistors.

**+400V Plate Supply Regulator and Raw DC Supply**

Arguably this is the first block that should be constructed and tested, as all

other blocks except the -200V bias regulator require it for operation, and troubleshooting purposes. This regulator may be operated safely with as little as 2mA loading from V1. The regulator circuit consists of a number of sections including 5AR4 rectifier feeding a pi-filter consisting of two 47uF/630Vdc film capacitors, and a 5H, 250mA choke. This filtered +560V supply then feeds the pass element which consists of both sections of a 6336A low mu power triode connected in parallel. R1 and R2 are optional resistors to force current sharing, and in this application are not required due to the relative modest power dissipation in the two sections of the 6336A -- I recommend their omission for this reason. However, the compulsive among you may install them as recommended in the tube specifications.

The next section of the regulated plate supply consists of the error amplifier and reference, complete with the output voltage setting

feedback network and zener reference. The error amplifier operates in a cascode connection for greater bandwidth, gain, and in some instances where higher output voltages are required, in order to keep the 12AX7A operating comfortably within its design margins. Closed loop gain is 12dB (4X) and the 100V reference voltage results in a +400V output. The 6336A needs a minimum of 125V across it to avoid potential drop out problems. The margin in this design is typically 160V. Output voltage with just the 6SL7 and 6SN7 installed should drop less than 2V when the output tubes are installed and biased for a total quiescent current of 160mA. Ripple should not exceed 5mVpp under load, and warm up time is typically 2 minutes.

Do not use any rectifier other than the 5AR4 if the protection circuitry described in the last block is not used - cathode stripping of the 6336 and the 300Bs may result.

**-200Vdc Bias Supply**

The -200V bias supply is crucial to the safety and functionality of this amplifier. Solid state bridge rectification and a 6U8A are used to assure a quick warm up, particularly important if the optional pro-

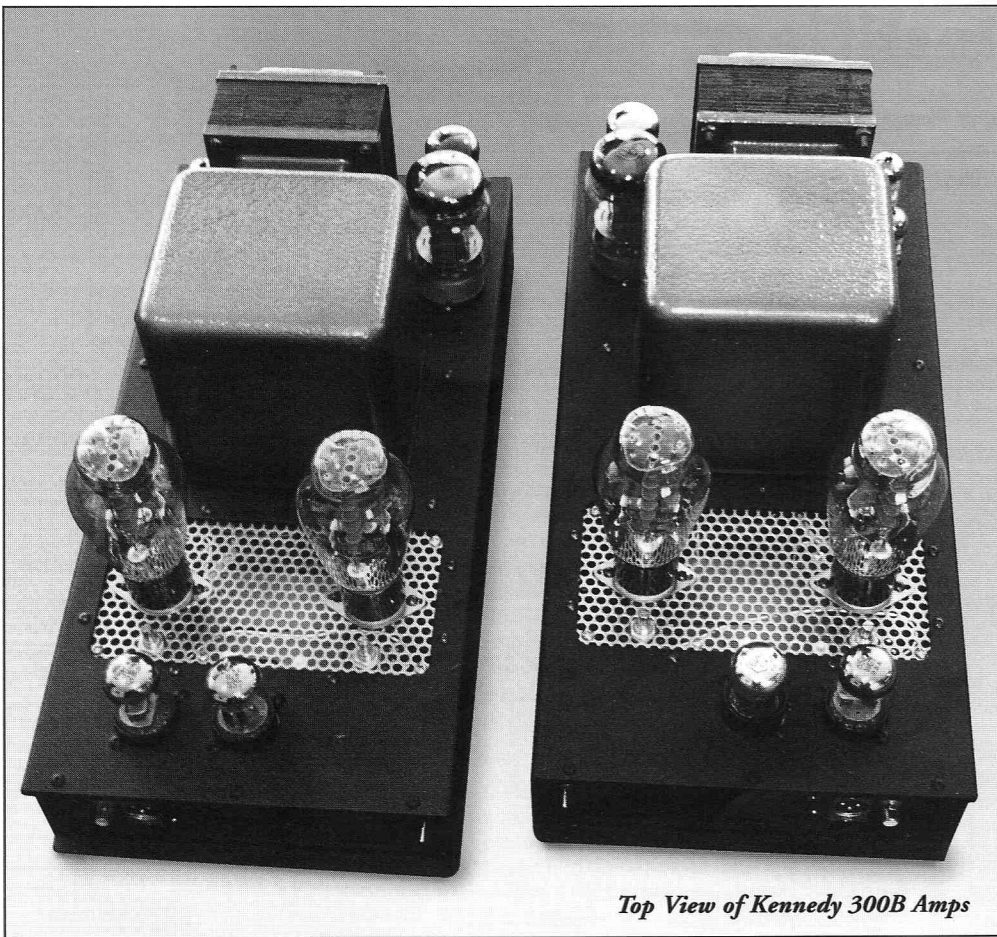

Top View of Kennedy 300B Amps

tection circuits are not used. The raw dc is pi filtered for the screen and error amplifier, and directly connected to the plate of the pentode section of the 6U8A. The filament is powered off of its own dedicated winding and is intentionally left floating to equalize voltage stress on the cathode/filament insulation in the triode and pentode elements. It is important to note that this is a floating supply and that the ground connection occurs at the cathode node of the regulator, and that the output is taken from the negative output leg of the circuit. (See Figure 3, page 28 for details.) The regulator is otherwise fairly conventional in design with a triode error amplifier driving a pentode connected pass element. The loop gain margin provides for about a 20dB reduction in ripple amplitude and output impedance, while the pentode connection of the pass element provides an additional 30dB of ripple rejection typically. Gain setting for desired output voltage is as described in the previous section. This supply should reach full output in 30 seconds or less. Output voltage should be  $-200V$  + or - 1% (select zener2 or trim R10 as required - zener selection preferred.) Ripple should be 2.5mVpp or less at full load.

#### Filament and Protection Circuitry

All filaments except V5 and V6 operate off of secondaries provided on T2. V1 and V2 filaments operate off of regulated dc, using a simple regulator circuit based on the Linear Technologies LTC - 1083/4/5K low drop out regulator. A LM317K may be substituted if required. Ripple should be less than 5mVpp under load. The dc filament supply is floated at +40Vdc to assure cathode/filament insulation longevity in V1 & V2 and to reduce noise coupling through the filament/cathode insulation capacitance.

This block also includes a circuit to sense normal bias supply operation. A simple two transistor switch senses the presence of bias voltage at or beyond the level required for safe operation and closes a relay in the center tap lead of the main power transformer. Conversely, if the bias supply malfunctions the relay will either not close at all, or open rapidly to reduce the likelihood of damage to the output tubes. If this protection circuit is omitted (NOT RECOMMENDED) a 300mA fuse should be installed in the center tap lead to protect against bias supply failure.

#### Notes on Output Transformers

Transformer recommendations are based solely on discussion with certain manufacturers, study of specification charts, or suggestions made by other respected audio professionals. At this time I have only evaluated the performance of the Citation II output transformers.

There are probably many other possible choices besides the ones listed here.

Peerless/Magnequest S-275, endbells, 4K ohms primary impedance, 800HY primary inductance, 80W power handling, 2 ohms, 4 ohms, 8 ohms, 16 ohms secondary taps.

Vintage NOS/Used Harman Kardon Citation II Output transformers, potted, 3.8K primary impedance, 150mA per side, 60W power handling, 4 ohms, 8 ohms, 16 ohm secondary taps.

Bartolucci Model 123, potted, C-Core, 3K ohms primary impedance, 170HY primary inductance, 150mA per side, 60W power handling, 4 ohms, 8 ohms, 16 ohms secondary taps.

Brooklyn/Magnequest B23, endbells, 4Kohm primary impedance, 50W power handling, 100mA per side, 10mA imbalance allowable. (Inexpensive)

Hammond 1650K(P), endbells or potted, 3.4K ohms primary impedance, 50W power handling, 100mA per side, 4 ohms, 8 ohms, 16 ohms secondary taps. (Least expensive option, particularly if 1650K is specified.)

#### Acknowledgements

*My business partner Richard Sears, (the Sears in Kennedy Sears Audio), both engineered and fabricated the chassis, and often provided valuable second opinions, as well as insights into many of the electrical engineering performance/space & cost tradeoffs I ultimately made in the design.*

*Kevin Kennedy has decades of experience in the design, building and restoration of tube audio equipment. He owns and operates Kennedy Tube Audio, P.O. Box 481, Stow, MA 01775-0481 (978) 897-2351 kennedyk@kta-hifi.com*

# Dumpster Rectifiers

By John Atwood ©1999 All Rights Reserved

More tubes were produced for TVs than any other application. Unfortunately, many of these tubes were specially optimized for TV application and were not used in conventional audio designs. However, many TV tubes can serve well in other applications, and are especially attractive due to their easy availability. We will look here at how TV "damper" tubes can make very good power rectifiers.

In order to scan an electron beam across a TV screen, the magnetic field in the deflection yoke must be linearly charged-up, then abruptly reset during the retrace interval. Since the inductance of the deflection yoke has stray capacitance, the transient caused by the retrace will cause the yoke to "ring." In the vertical deflection circuit, this damped oscillation can be further damped to practically nothing by putting shunt resistors across the deflec-

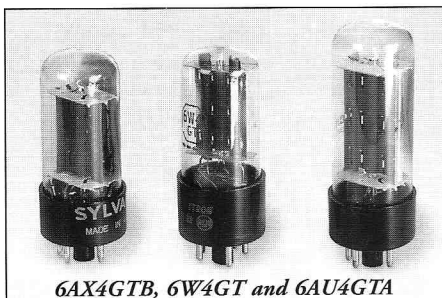

6AX4GTB, 6W4GT and 6AU4GTA

tion coils. However, in the horizontal circuit, high speeds and high power make the use of shunt resistors very inefficient. Instead, a diode is used to clamp the oscillation of the yoke as soon as the voltage across it goes negative. In practice, this "damper diode" is usually connected to taps on the flyback transformer, but it still has the same effect of stopping unwanted oscillation in the yoke.

In the very first American TVs, a 5V4G rectifier was the damper diode. It had the advantage of low voltage drop at high current, but having the heater in common with the cathode required a separate filament transformer with a very high breakdown voltage - since the cathode of the damper sees the highest voltage peaks. These high peaks put a lot of stress on the rectifier, and to improve reliability manufacturers such as RCA and Sylvania reworked the 5V4G to make it more rugged. However, the 5V4G was not a very cost-effective solution.

bore a striking resemblance to the 35Z5GT rectifier (used in series-connected 5-tube radios), with just a slightly larger cathode and a bit more cathode-to-plate spacing. The heater-to-cathode insulation was such that it could be used without a separate filament winding - barely. The

larger and better designed sets still used a separate heater winding.

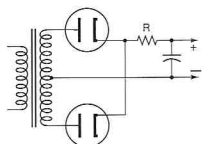

Figure 1

to 3500 volts must be handled. By 1951, good damper tubes finally came out. In Europe, Philips introduced the EY81 which used a special internal support structure to float the heater inside the cathode sleeve. In America, the 6AX4GT was introduced, which used a ceramic-insulated wire wrapped around the heater to increase the spacing to the cathode. Both these techniques continued to be used on both sides of the Atlantic, but in America the insulated wire technique was by far the most common.

Most American damper tubes continued to look like the the 6W4GT with all leads coming out of an octal base, but as larger picture tubes became popular and set reliability became a concern, there was a steady improvement in maximum ratings, with early types like the 6W4GT, 6AX4GT, and 6AU4GT getting several upgrades to GTA and GTB. In Europe, the damper

TABLE 1

Type	Max I DCmA	Max PIV	Peak H-K voltage	Fil. current
6AL3/EY88	220mA	7500V	+300/-6600	1.55 Amps
6AU4GT	175	4500	+300/-4500	1.8
6AU4GTA	210	4500	+300/-4500	1.8
6AX4GT	137	4400	+300/-4400	1.2
6AX4GTB	165	5000	+300/-5000	1.2
6AY3	175	5000	+300/-5000	1.2
6CE3/6CD3/6CG3	350	5000	+300/-5500	2.5
6CJ3/6CH3	350	5000	+300/-5500	1.8
6CM3	400	5500	+300/-5500	2.4
6D22S	300	6000	+200/-600(DC)	1.9
6DE4/6CQ4	180	5500	+300/-5500	1.6
6DM4A/6DA4	200	5000	+300/-5000	1.2
6DW4B	250	5500	+300/-5000	1.2
6EC4/EY500	440	5600	+300/-6300	2.1
6V3A	135	6000	+300/-6750	1.75
6W4GT	125	3850	+300/-2300	1.2

In 1948, RCA came out with the 6W4GT, the first tube designed to be a damper. It

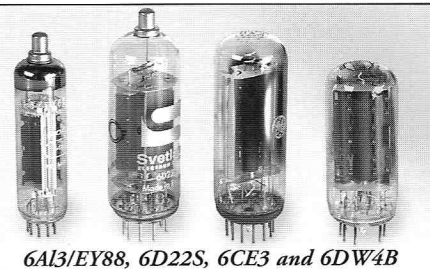

6AL3/EY88, 6D22S, 6CE3 and 6DW4B

tubes took on a different style: 9-pin novar bases with the cathode coming out on a top cap. In America, Tung-Sol came out with this European style in the 6V3 and by the 1960s, when there was lots of sharing of tube designs between Europe and America, American versions of some of the cathode-cap dampers were made.

Two developments about 1960 produced an explosion of American damper tube types: the all-glass Noval

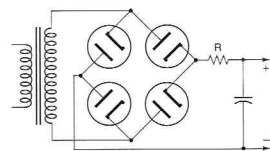

Figure 2

and Compactron bases which replaced the octal base, and the expansion of color TV which required higher-powered damper tubes. Some of these new tubes were just re-based octal designs (e.g., the 6AX3 is a compactron version of the 6AX4GTB); others were new high-power versions such as the 6CG3 and 6CH3. Since the introduction of the 6W4GT, nearly all damper tubes had series-string versions in addition to the 6.3V versions, with numbers such as 12AX4GT, 17AX4GT, and 25AX4GT. The existence of 0.3A, 0.45A, and 0.6A series heater sets further multiplied the number of damper tube types.

The result of the proliferation of damper tube types and their lack of use outside of TV sets has resulted in a huge number of damper tubes sitting in dealer's inven-

tories, warehouses, and in old tube cad-dies. With the availability of good traditional tube rectifiers suffering, it's time to re-examine the use of damper tubes for audio designs.

Some tube manuals did not recommend damper tubes be used as conventional power rectifiers. From what I can tell, this was mainly an application problem: the damper tubes were not designed and tested for the high switching currents

in capacitor-input power supplies, so the manufacturers wanted to steer designers to tubes like the 5U4GB and 5AR4/GZ34.

However, there was some use of damper tubes in power supplies in the 1950s: in the Marantz 2 power amp and in some ham-radio transmitters. In these applications and in my own experience, damper tubes work well and are quite reliable in power supplies, as long as maximum surge currents are kept down (they are not as rugged as silicon rectifiers in this regard!). The good heater-cathode breakdown ratings mean that no separate heater winding is needed for them (although be careful with the 6W4GT). The large heater-cathode spacing means that the damper tubes take a long time to warm-up - a nice built-in time delay to help protect expensive output tubes!

Since there is only a single rectifier in a damper tube, two are needed to replace conventional full-wave rectifiers (see fig. 1). If two more are used, a full-wave bridge can be implemented as in Fig. 2, p. 30. The resistor R can be used for current-limiting in capacitor-input filters. A circuit trick that combines the convenience of solid-state rectifiers with the slow turn-on and regulation characteristics of a tube rectifier is shown in Figure 3. I first saw this technique used by Dave Wolze. The voltage drop of a damper tube is fairly low, so when used to replace a regular tube rectifier, the DC output voltage will usually be higher, but not as high as with a solid-state rectifier.

Table 1, p. 30, shows the key characteristics of common damper tubes. Due to the large number of types, a good tube manual should be consulted for a comprehensive list. The 4CG basing diagram shown at the top of the article is used by virtually all the octal damper tubes. The photos of dampers shown here are just a small sampling of the different types produced.

## Build 300 Watts of Triode Power

By Eric Barbour and Peter Belov ©1999

In the 1950s, the idea of a "booster" amplifier was commonplace. Because hi-fi amps of the era were usually very low in power (often less than 10 watts), many hobbyists built booster amps to take the speaker outputs of their amps and increase the power output. Commonly, these amps were built with war-surplus power tubes (usually low- $\mu$  triodes), plus suitable push-pull input and output transformers. The input transformer was simply a high-power impedance converter, boosting the low-impedance output of the driving amp to higher voltage levels to drive the grids of the tubes directly--no driver electronics were needed. The remainder of the circuit was a conventional push-pull amp.

Such boosters are rarely built today, primarily because engineering practices and audiophile attitudes have changed (the mainstream attitude is simply to buy a large solid-state amp). If an audiophile prefers a small, low-power amp, however, this limits the choice of speakers to very efficient models.

Presented here is a booster amp which uses only stock Hammond transformers. Instead of low- $\mu$  triodes such as 845s, it uses push-pull parallel SV572-160 high- $\mu$  triodes in Class B mode. Zero bias is used, simplifying the power supply. By using a Hammond line-matching transformer for the input matching, adequate voltage swing is obtained to drive the grids of the SV572-160s directly, plus more than enough grid current is available to drive the grids positive.



Although Class-B operation has gained something of a bad reputation in audio circles in recent years, it still does offer some advantages, if implemented properly.

Because it drives one side of the output stage into cutoff just as the other side is driven into linear operation, push-pull tubes in a Class B stage offer the possibility of very high linearity, as their loadlines would utilize the maximum available voltage swing of the tubes--IF the loadlines were perfectly aligned. This may be difficult to do with a pair of tubes, unless they are carefully matched.

This amplifier takes a different approach. A "virtual device" is created by paralleling a large number of triodes and letting their transfer characteristics average out. This trick happens to work much better with high- $\mu$  triodes, since their grids are driven positive throughout nearly the entire signal swing. This gives current-limited curves similar to those of a pentode, yet with greater linearity. Extensive experiments have shown that this amp can use either matched pairs OR unmatched random SV572-160s, with no apparent sonic differences or electrical changes. A small amount of negative feedback, provided by resistor R1, further linearizes the circuit.

It happens that eight SV572-160s make an excellent match for Hammond's largest output transformer, the 1650W. This transformer is very conservative in its ratings, as we found in subsequent testing. The onset of visible waveform clipping was observed at 62 vRMS into an 8-ohm load, or 490 watts output. The transformer did not seem to strain with this, even though it was carrying about 800 milliamps and 1800v peak-to-peak on its primary. We have decided to respect the Hammond company's ratings, however, so we will call this a 300-watt amplifier.

The SV572-160 is an excellent choice for this circuit,

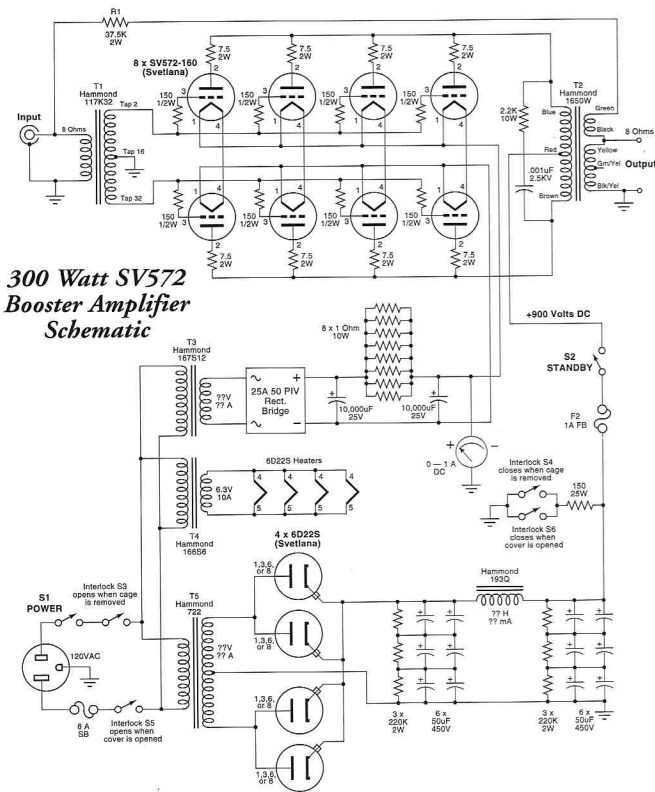

300 Watt SV572  
Booster Amplifier  
Schematic

since it has no plate cap to offer an electrical hazard. However, this circuit works just as well with more conventional high-mu triodes with plate caps, such as the 811A or 572B. If the constructor decides to use capped triodes, an enclosed chassis is strongly recommended. Medium-mu triodes, such as the 812A or SV572-30, will also work in this circuit, provided a

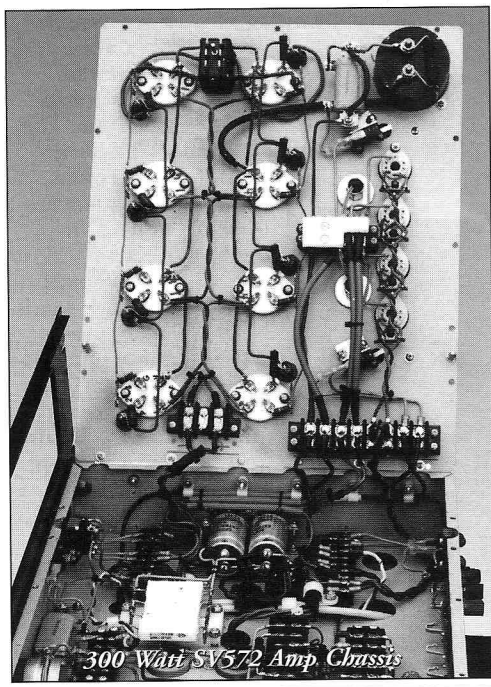

300 Watt SV572 Amp Chassis

means of biasing the grids negatively is provided. Low-mu triodes are not recommended for this circuit due to their greater voltage-drive requirements. Also, the feedback may have to be changed. These are advanced modifications, and will not be covered in this article.

The chassis used with the prototype is a Hammond steel chassis, model 1441-38, with a 1431-38 cover mounted on hinges. The tubes are mounted on the cover; wiring to the power supplies is along the hinged edge, while a large 6-pin Jones plug set connects the plate and grid circuits to the tubes when the cover is closed. Wiring was

done on surplus barrier strips, while number 14 solid-core wire was used for most circuit and filament wiring. None of the passive component values are especially critical to proper operation.

The design is very straightforward. T1 converts an 8-ohm impedance to a variety of other speaker impedances. By using the common and 32-ohm taps of the primary as a secondary, and grounding the 16-ohm tap, we end up with a low-impedance push-pull signal pair, with the voltage swing multiplied by 1.4. Thus, a 25-watt signal input (14.1 volts RMS or 40 volts peak-to-peak) is converted to two out-of-phase signals of 56 v p-p--perfect for driving the high-mu grids of the SV572-160s. T1 is rated for 32 watts, so it (and all other components in this amp) are operated very conservatively. Each SV572-160 has a 150-ohm grid stopper resistor plus a 7.5 ohm plate resistor to insure high-frequency stability and provide some circuit protection in the event of a fault. R32 and C15 are a "snubber" network to further stabilize the amp. Negative feedback from R1 mixes with the input signal in T1's primary. This constitutes only a few dB of feedback--just enough to help stability and distortion performance. More may be added by the experienced builder, at the cost of some precious voltage gain.

The power supply makes use of parallel Svetlana 6D22S rectifier tubes. They are very rugged and capable of supplying considerably more current than most rectifier tubes. Because they use cathode cap connectors, the rectifiers were covered by a small cage (Hammond 1451-10) which is equipped with two safety interlock switches. Removal of the cage cuts off the AC power and shorts the DC plate filter capacitor to ground via 150-ohm resistor R33.

Bench tests showed that distortion at 300 watts output was about 1%. Hum and noise in the output is less than 2 mV, assisted by the use of a well-filtered DC filament supply. Frequency response at 100 watts output was -3 dB from below 10 Hz to about 18 kHz. Listening tests revealed a very transparent amplifier, which simply magnified the output of the driving amplifier by a factor of about 12. A good-sounding 8-watt SE 300B amplifier is thus made into a 96-watt amplifier with the same characteristics. When used as a booster for a guitar amp, results were even more spectacular; the amp drove a 300-watt Marshall 4x12 cabinet to full loudness, while still having the sonic attributes of the 50-watt Marshall plexi head used as the driver.

One final note: this circuit was optimized and intended for use with any transformer-coupled tube amplifier as the driver. The relatively high output impedance of most such amplifiers (especially guitar amps) allows the feedback loop to operate properly. If the user desires to drive this circuit with a solid-state amplifier, we recommend that a resistor be inserted in series with the driving amp's output. Try 4 ohms and adjust its value until the desired results are achieved. The value of R1 may have to be adjusted, also; and a parallel capacitor may be required across R1 to stabilize the amplifier.

**WARNING**

This amplifier *IS NOT* recommended as a project for beginners. The plate power supply is 900 volts DC, which can be instantly lethal if contacted by a careless operator. Construction of this circuit is recommended only for the very experienced technician or builder.

**References**

1. "The Musician's Amplifier Senior", David Sarser and Melvin C. Sprinkle, *Audio Engineering Magazine*, January 1951 (reprinted in *Audio Anthology*, Vol. 2 by Old Colony, 1989).



# TRIODE SPIRIT



IF YOU OWN WE284 OR RCA845 NOS TUBES, YOU ARE VERY FORTUNATE BECAUSE YOU'LL HEAR SOUND REPRODUCTION THE BEST WAY IT SHOULD BE AND THAT MOST LIKELY FOR THE FIRST TIME.

THIS NEW AMPLIFIER REVEALS SOUL AND SPIRIT OF POWER TRIODES.

THANKS TO ITS INPUT STAGE, IT IS PRACTICALLY FREE OF DISTORTION, WHICH IS THE CAUSE OF SONIC DETERIORATION AS WELL AS COMPROMISING THE HARMONIC RICHNESS OF TRIODE OUTPUT TUBES.

IN ADDITION, A FOURFOLD REGULATED POWER SUPPLY OFFERS THE BEST SIGNAL/NOISE RATIO:  $\leq 86\text{DB}$  AND THE DOUBLE C CORE TRANSFORMERS SIMPLY MEAN "STATE OF THE ART".

## US CONTACT

AUDIO ADVANCEMENTS LLC, BRANCHVILLE (NJ 07826 USA)  
PHONE : 1 973.875.8705 - FAX : 00 1 973 875 8735

## MANUFACTURER

J.-C. VERDIER : 5-7, RUE D'ORMESSON, 93800 EPINAY FRANCE  
PHONE 00 (33) 1 48 41 89 74 - FAX 00 (33) 1 48 41 69 28  
WEBSITE : [jcverdier.com](http://jcverdier.com)

SINGLE ENDED PUSH PULL ACROSOUND PEERLESS COPPER WINDINGS SILVER WINDINGS HAND WOUND

Peerless transformers go surprisingly low.

\$99, for example.

Surprised? The low price is shocking, but it's the sound that's electrifying. Because all Peerless transformers are made from premium materials with expert craftsmanship, and based on proven, well-balanced designs. So if you want the best inexpensive transformer, or just the best, you'll get a Peerless. For a sound that's peer-less.

**MagneQuest**

HANDBUILT TO PERFORM WITHOUT EQUAL

MAGNEQUEST, 1404 E. BRISTOL ST PHIL., PA.19124  
<http://www.MagneQuest.com>

SINGLE ENDED PUSH PULL ACROSOUND PEERLESS COPPER WINDINGS SILVER WINDINGS HAND WOUND

**AFFORDABLE HAND-WIRED GUITAR AMP KITS!**



Available with Jensen speakers!

Based on blackface era amps from the mid 60s, these all-tube guitar amps feature 3-knob reverb control, tube rectifier, solid-pine jointed cabinets, bias setting jacks, master volume control, heavy aluminum chassis, cloth covered wiring, full size potentiometers, vintage style tube sockets, 40W 2x6L6 output, carbon composition resistors, Mallory tone capacitors and many other top features.

2x12 TONESavor \$799 2x10 Old Flame \$749

**ALLEN**

AMPLIFICATION  
 Quality tube amps, kits and parts

Phone: (606) 485-6423

Fax: (606) 485-6424

E-Mail: [tonesavor@fuse.net](mailto:tonesavor@fuse.net)

[www.iguitar.com/allen](http://www.iguitar.com/allen)



**one electron™**

**Single-Ended Output Transformers**

High Quality for a Reasonable Price  
 Designed and Built in the USA

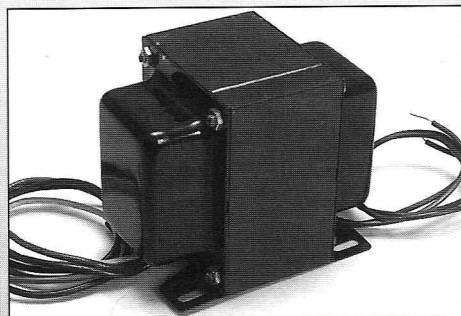

**UBT-1**

Designed for parallel operation of:

1.6k primary  
 15 watts  
 160 mA

**\$99.00**

2A3s, EL34s, 300Bs 6AS7s,  
 etc. or Sweep-tube in  
 "enhanced triode" mode

**UBT-2**

4.8k primary  
 15 watts  
 110 mA

**\$119.00**

Can be used with:  
 300B, 50, SV811-3, etc.

**UBT-3**

3k primary  
 15 watts  
 110 mA

**\$119.00**

Good for single ended  
 2A3 or 300B

Quantity discounts available

ANTIQUE ELECTRONIC SUPPLY™

LIMITED PARTNERSHIP

6221 S. Maple Ave. • Tempe, AZ • 85283

Phone (480) 820-5411 • FAX (480) 820-4643 or 800 706-6789

Hey, all you obsessed, nutbar,  
crazied-to-the-point-of-snapping,  
tube audio freaks!

# This is Mike.

(He's one of you.)



In the very near future, Mike will surprise you with many new kits-  
one of which is an great sounding efficient speaker and there is also a new  
line of excellent copper-foil caps. All from Audio Note North America.

Now, aren't you glad you met him?



Audio Note NORTH AMERICA

# thetubestore.com

Your online source for name brand audio tubes

Enjoy the convenience of purchasing audio tubes at  
our secure online webstore. We stock a wide range  
of products including Ei, Tesla/JJ, Svetlana, Sovtek,  
Sino, and JAN.

Competitive prices and fast service.

Check out the selection at [thetubestore.com](http://thetubestore.com)

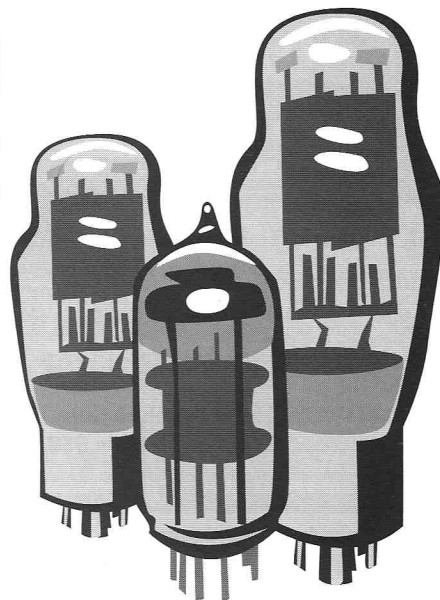

*Moth Audio  
Corporation*

*S2A3*

Inventory Tax Clearance

Sale Limited Offer \$1800.00



Place your order now,  
323 HOlllywood 7-4300  
fax 323 464-9100

Call now or visit us on the web at [www.mothaudio.com](http://www.mothaudio.com)



**ELECTRA-PRINT  
AUDIO**

**QUALITY HANDWOUND S.E. OUTPUT TRANSFORMERS**

- Primaries from 1.8K to 10K
- Exclusive wideband design
- 16, 8, 4, or 2 ohm secondary
- Gold plating

**CUSTOM-BUILT POWER TRANSFORMERS/CHOKES**

- Wound to your requirements
- Heavy-duty design for Class A use
- DC filament supply windings
- HV chokes to 15H, 300ma
- Low voltage, high current filament chokes

*Component pricing and specifications catalog available*

**ELECTRA-PRINT AUDIO**

4117 Roxanne Drive Las Vegas, NV 89108  
702-396-4909 FAX 702-396-4910



**Tell the world your music is powered by 6L6.** Super cool gig shirt for electric guitarists or sure-fire attention-getter for tube enthusiasts. Huge full-chest 12" x 15" 1950s style image with giant 6L6GC taking off. Available in either White Image on Black shirt or Black Image on Lt. Gray shirt XL only. Only **\$16.95** each

**New VTV Tube Head Baseball Cap** 100% cotton, one size fits all (adjustable band) Black or Navy **\$18.00** each  
Shipping and Handling \$5.00 US, \$6.00 Canada, \$10.00 Europe, \$12 Asia and World

California Residents add 8.25% State Sales Tax

**Vacuum Tube Valley, P.O. Box 691, Belmont,  
CA 94002 USA FAX 650-654-2065**

[www.vacuumtube.com](http://www.vacuumtube.com)



# VACUUM TUBE VALLEY

## Back Issues, Books, Goodies, & Subscriptions

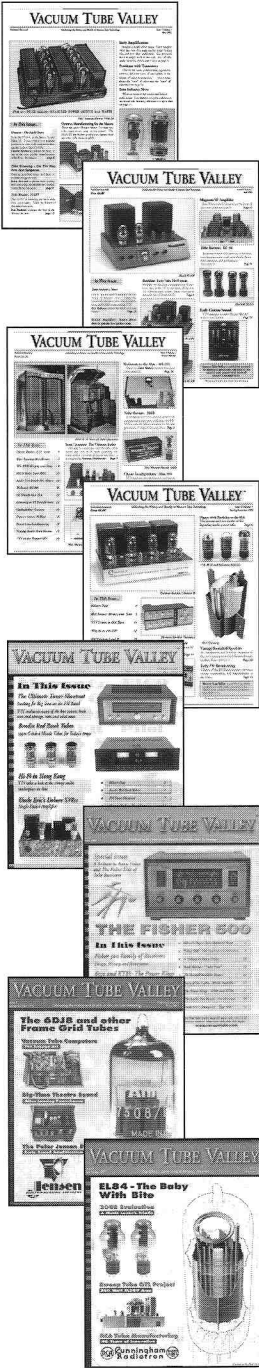

**VTV #1 Spring 1995 \$8 US - \$10 Foreign**  
 Vintage Dynaco Tube Equipment - 1955-77  
 History and Testing of the 12AX7/ECC83 dual triode  
 Tube Testing Methods + Early Amplification and Amps

**VTV #2 Fall 1995 \$12 US - \$15 Foreign**  
 Heathkit - The Tube Williamson Years 1950-61  
 EL34/6CA7 History, Types and Tests  
 Magnum SE EL509 Amplifier Project by Dave Wolze  
 1927-34 Western Electric Theater Sound Systems

**VTV #3 Winter 1995/96 \$12 US - \$15 Foreign**  
 Eico Mono Tube Gear - 1955-62  
 Altec Lansing 604 Coaxial Loudspeaker History  
 Western Electric 300B History and Listening Tests  
 300B SE Transformer Listening Tests

**VTV #4 Spring 1996 \$12 US - \$15 Foreign**  
 6L6 History, Types and Listening Tests  
 Vintage Bookshelf Speakers 1955-1965  
 Early FM Broadcasting History  
 HK Citation I & II Amplifier History and Mods

**VTV #5 Fall 1996 \$12 US - \$15 Foreign**  
 The Ultimate FM Tuner Shoot Out  
 Red Bank Guided Missile Tubes for Hi-Fi  
 The Birth of the Marantz 10B  
 Choosing Rectifier Tubes for your Guitar Amplifier

**VTV #6 Winter 1997 \$12 US - \$15 Foreign**  
 Fisher 500 - History, Models and Restoration  
 A Tribute to Avery Fisher by the Fisher Doctor  
 6550 and KT88 History, Types and Listening Tests  
 Loftin-White Amplifier History by Alan Douglas

**VTV #7 Summer 1997 \$12 US - \$15 Foreign**  
 6DJ8 & Frame Grid Tubes + Listening Tests  
 Altec 1950s Theater Amps and Modifications  
 The Great Voice - The Peter Jensen Story  
 Computing with Tubes - The Savage Art  
 Uncle Eric's Tube Dumpster - 417A/5842

**VTV #8 Fall 1997 \$12 US - \$15 Foreign**  
 EL84 History, Types & Listening Tests  
 RCA Tube Mfg at Harrison, New Jersey  
 200 watt OTL Amp Project by Allan Kimmel  
 300B Listening Tests: NOS and Vintage Types  
 Bruce Moore Tube Audio Pioneer

**Vintage Hi-Fi Spotter's Guide-Volume 1**  
 Over 450 photos & specifications of tube audio gear  
 from the Golden Age of Hi Fi. 86 pp. \$18.95

**Vintage Hi-Fi Spotter's Guide Volume 2**  
 Volume 2 covers equipment not listed in Volume 1.  
 Almost 500 amps, preamps, tuners, etc are depicted.  
 Edition covers early audio and includes a Speaker section  
 with most vintage manufacturers. 88 pp. \$18.95

**Vintage Hi-Fi and Audio Price Guide 1999-2000**  
 Updated price & grading guide for almost 1,000 vintage  
 hi fi amps, preamps and tuners. Includes Vintage pro  
 audio and theater gear. Also, pro loudspeakers, N.O.S.  
 vacuum tubes and audio transformers. \$20.00

**"Vintage Hi-Fi The Golden Era Video"**  
 A one-of-a kind video covering the classic post-war and  
 1950s home hi fi era. Over 80 classic audio amps, pre-  
 amps tuners, are shown. This video is professionally pro-  
 duced. 34 min VHS NTSC \$20.00

**The Ultimate Tube Substitution Guide**  
 No tube electronics enthusiast should be without this  
 book. Over 10,000 tubes are listed on 240 pages includ-  
 ing: audio, radio, transmitting, and special. Features an  
 audio tube section with tube evaluation. \$29.95



### Vacuum Tube Valley T-Shirts Two Styles to Choose From!

- A) VTV Marching Tubes - "Big Tone"  
 1 sided available in Burgundy only \$15.00 XL only
- B) VTV Tube Sunburst Shirt with 2-color black & orange  
 art as pictured plus large 2-color RCA tube diagram  
 exploded view on back. (Available in gray) \$20.00 XL only
- C) Official VTV Cap - High quality dark navy cap with silver  
 embroidered "Tube Head" on front. "Vacuum Tube Valley"  
 stitched on back. Velcro size adjustment, 100% Cotton \$18.00



**VTV #9 Spring 1998 - Transmitting**  
 Tube Review, Ampeg SVT Guitar Amp,  
 Altec 287W amp, Bargain Vintage Hi-Fi  
 \$12 US - \$15 Foreign

**VTV#10 Summer/Fall 1998**  
 Story of the 6V6, Hi-Fi radio in the 30s,  
 PP SV572 amp, Ultrathin Line Stage  
 \$12 US - \$15 Foreign

### ORDER FORM

Name \_\_\_\_\_ Date \_\_\_\_\_  
 Address \_\_\_\_\_  
 City \_\_\_\_\_ State \_\_\_\_\_ Zip \_\_\_\_\_

Please Send Me The Following Products

\_\_\_\_\_ \$ \_\_\_\_\_  
 \_\_\_\_\_ \$ \_\_\_\_\_  
 Add \$5.00 Shipping per order in USA / Add \$10.00 - Item Air Mail Foreign Shipping \$ \_\_\_\_\_  
 CA Residents Add 8.25% State Sales Tax (CA Tax) \$ \_\_\_\_\_  
 Credit Cards, U.S. Bank Checks or Money Orders OK **TOTAL ORDER** \$ \_\_\_\_\_  
 Credit Card # \_\_\_\_\_ Exp. Date \_\_\_\_\_  
 Signature \_\_\_\_\_

### Subscribe To Vacuum Tube Valley The Classic Electronics Journal

\$45/year US First Class \$48/Canada,  
 \$56/Europe & \$66/Asia & World

### VACUUM TUBE VALLEY P.O. Box 691

Belmont, California 94002 USA  
 Phone (650) 631-6550 FAX (650) 654-2065  
 email - triode@vacuumtube.com

www.vacuumtube.com

# How I Scored the Preamp Deal of the Century on AudioWeb

I was browsing through the **Classified Ads and Auctions** on AudioWeb, when I came across this ad for a preamp that I had never heard of before. Funny thing was that it was made by one of my favorite companies!

"Hmmm," I thought. So I clicked on the **Reviews** link and started reading the reviews by other AudioWeb members who had owned one. "Wow this baby sounds perfect," I thought.

I clicked back to the ad and as much as I wanted it, this particular guy was asking more than I wanted to spend. Well, I'm a patient, so I set up an **Ad Alert** to automatically notify me when another preamp came up for sale for the price I wanted to pay. You see, AudioWeb has this great feature where they automatically email you when something you're looking for comes up for sale.

Sure enough, a few days later I get an email that takes me right to the new ad. It was exactly the right model in at a great price! I checked out the seller's **Rating & Feedback** other member's had posted about the seller (after all, you can't be too careful). A few emails, and not too much cash later, it's in my living room sounding better than I imagined.

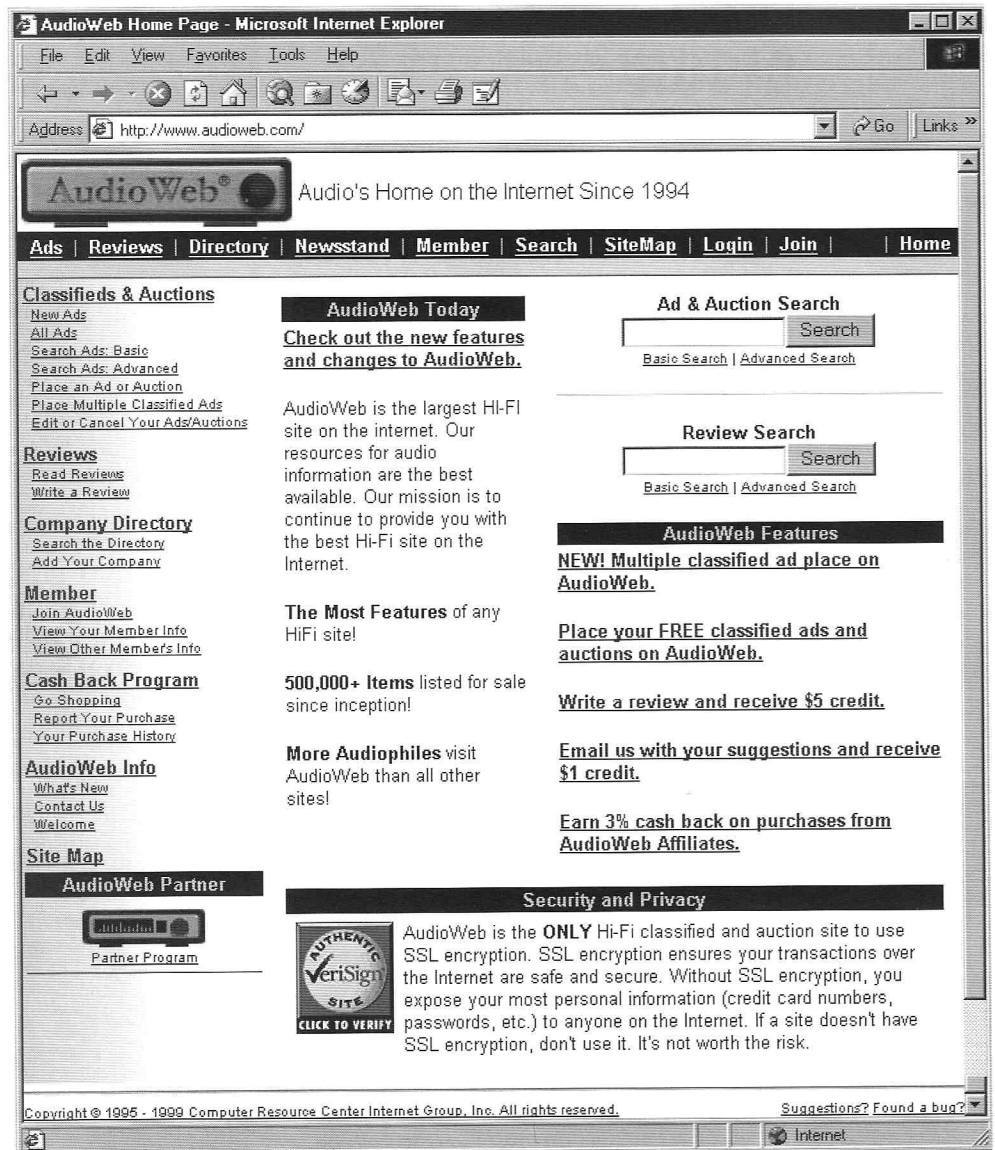

AudioWeb is a planet's worth of hi fi fanatics reviewing, buying and selling higher end audio gear and accessories. Whatever your particular audio affliction you will find it in abundance. Be sure and check out our new Audio Buyers Club where you name your price and our Newsstand of articles from great magazines like this one.

- Auctions
- Classifieds
- Audio Buyers Club
- Directory
- Internet Ad Search
- Events
- Global Web Review Search
- Newsstand
- Clubs

## www.AudioWeb.com



Audio's Home on the Internet Since 1994

AudioWeb, PO Box 303 Berkeley Heights, NJ 07922, 908-464-7307, 908-464-0271 (fax), [info@audioweb.com](mailto:info@audioweb.com)

# Purveyors of "Classic" Transformers & Enclosures

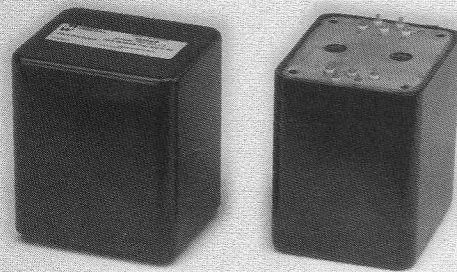
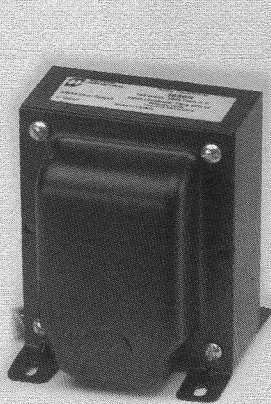

*Single Ended, Push-Pull  
and Potted Tube Output  
Transformers*

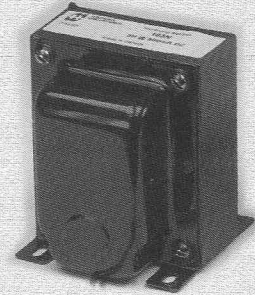

*Filter Chokes*

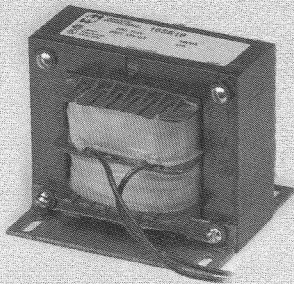

*Open & Enclosed  
Filament Transformers*

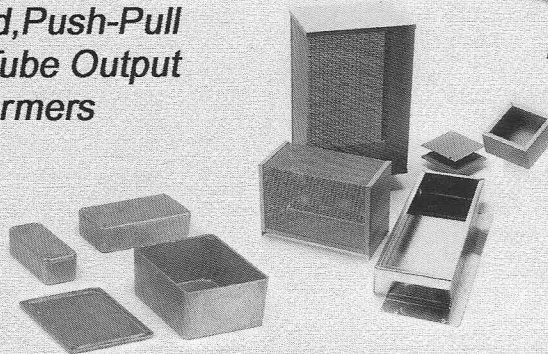

*Aluminum & Steel Chassis  
and Diecast Aluminum  
Enclosures*

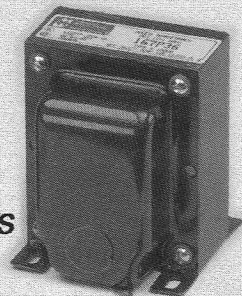

*High Voltage Plate  
Transformers*

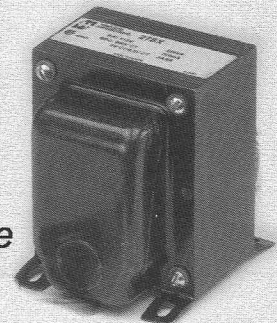

*Contact us for a free catalog & list of stocking distributors*

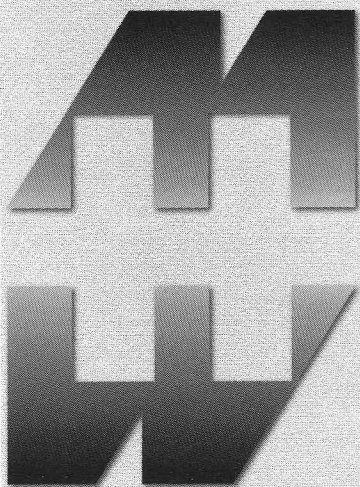

## HAMMOND MANUFACTURING™

4700 Genesee St. - Cheektowaga, NY 14225 USA  
Phone: (716) 631-5700 Fax: (716) 631-1156  
394 Edinburgh Rd., N. - Guelph, Ontario N1H 1E5 Canada  
Phone: (519) 822-2960 Fax: (519) 822-0715

[www.hammondmfg.com](http://www.hammondmfg.com)



Products by:

- Allen Bradley
- Alps
- Caddock
- CAIG Labs
- Cardas
- DH Labs
- Elna Cerafine
- Hammond
- Holco
- Hovland MusiCaps
- Hubble
- Jensen
- Kimber Kable
- KR Enterprise
- LCR Caps
- Lowther
- Magnequest
- Mills
- MultiCap
- Neutrik
- Noble
- PFT Chassis
- Ram Labs
- Roederstein
- Solen
- Sorbothane
- Sovtek
- Svetlana
- Tesla
- Vampire
- WBT
- Wima
- and many more...

 **Welborne Labs**

P.O. Box 260198 Littleton, CO 80126 USA  
 tel: 303.470.6585 fax: 303.791.5783

Celebrating our 10th Anniversary 1988 - 1998

Our 1998 Catalog & Design Manual is now available featuring tons of kits, parts, books, software, schematics, fun projects and the usual info. It's just \$12 U.S. and Canada, \$18 International, refundable. Visa and Mastercard Welcome.

e-mail: [wlabs@ix.netcom.com](mailto:wlabs@ix.netcom.com) website: <http://www.welbornelabs.com>

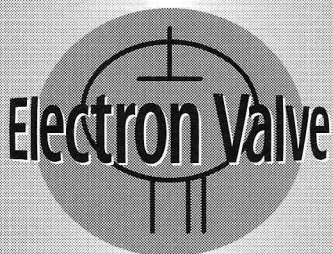

**Your source for hard to find  
 Vintage Audio Tubes  
 and Quality Vacuum Tube  
 Audio Components**

Stop by our website to see a detailed look at all of our products!  
[www.electron-valve.com](http://www.electron-valve.com) • Email: [info@electron-valve.com](mailto:info@electron-valve.com)  
 Phone: 901-382-9955 • Fax: 901-382-9956

We are a proud dealer of **Western Electric** Audio Products.  
 The current production 300B is now in stock.



Electron Valve stocks a wide array of **NOS** Vintage Audio Tubes like Mullard EL34, RCA 2A3, and Mullard 5AR4. We also have a good stock of Old Production Western Electric tubes such as

205B/D, 252A, 274B, 300B and many others.

Electron Valve carries Precision Tested Ram Labs Reference Tubes. These tubes are computer tested, graded and matched to ultra high specifications predetermined by Roger A. Modjeski.



We also carry the Music Reference **MR** RM-10 (Push-Pull 6BQ5, 35W/Side) Stereo Amplifier and the Music Reference RM-200 (Push-Pull 6550, 100W/Side) Stereo Amplifier.

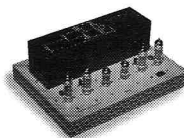



## The Shape of Great Sound

Svetlana Audio Tubes ignite music with a richness and clarity only achieved with the best in vacuum tube technology. At Svetlana, we start with quality materials, then add precision and careful testing. The resulting sound is rich, full and powerful. So your amplifier gives its best performance. Svetlana Audio Tubes are shaping the way you hear music.

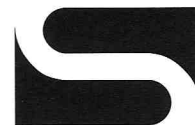
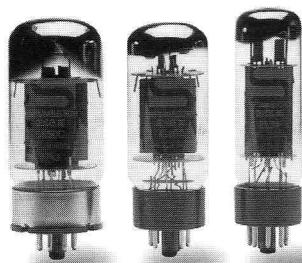
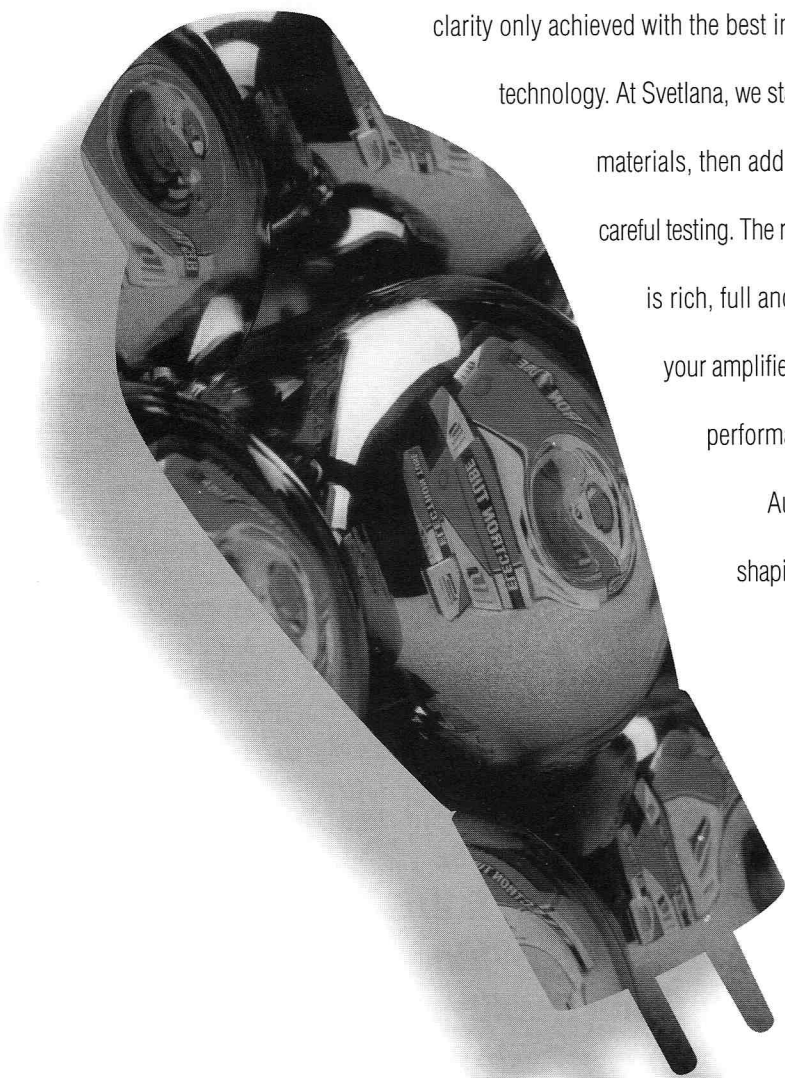

**Svetlana**  
ELECTRON DEVICES

[www.svetlana.com](http://www.svetlana.com)

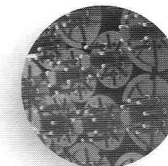
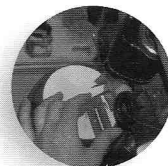

Headquarters: 8200 S. Memorial Parkway  
Engineering & Marketing: 3000 Alpine Road

Huntsville, AL 35802  
Portola Valley, CA 94028

Phone: 256-882-1344  
Phone: 650-233-0429

Fax: 256-880-8077  
Fax: 650-233-0439

# ***"Deep Impact"***



*That's the effect our A-4 has on it's owners.*

*Fully Assembled \$695 - Kit \$549 - Chrome chassis add-on \$95.00*

- 30 Watts Per Channel
- Extremely Low Noise
- Tubes: 4/12AU7 & 4/EL-34
- Point To-Point Wiring
- Exceptional Quality & Sound
- Ultra Linear Push-Pull

We carry other Amplifiers, Preamplifiers and Phono-Preamplifiers.

All kits come complete with step-by-step manuals, schematics and drawings.

*Call For Your Catalog!*

**Antique Sound USA** Made in the USA

6717 NE 181<sup>st</sup> Street, Kenmore, WA 98028 USA Phone 425-481-8866 FAX 425-485-3836  
E-Mail: [asusa@earthlink.net](mailto:asusa@earthlink.net) Web-site: [www.as-usa.com](http://www.as-usa.com)

# VTV Pro-Tube Shop

Your headquarters for high quality audio parts & tubes

P.O. Box 691, Belmont, CA 94002 USA (Order 10am to 6pm Tue-Sat)  
 (650) 631-6550-Phone (650) 654-2065 FAX www.vacuumtube.com

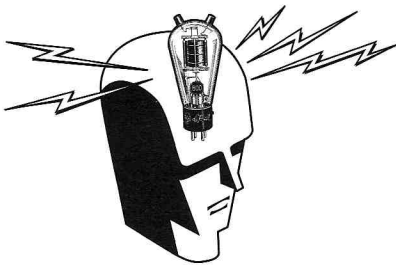

**Order: By email, FAX, Mail, Phone**  
**Minimum Shipping and Handling per order:**

US \$5.00, Canada \$10, Europe \$20, Asia \$25 (Heavier items will require additional postage)

**\$35 Minimum Order**

## Vintage Hi-Fi Rebuild Kits

**Get Great Sound & Save Bucks!**

All kits include all new ICMWR signal and bypass film caps, under-chassis electrolytics, 1 watt metal oxide low-noise plate resistors, new silicon power supply diodes and schematic. **Kits do not include FP can-type electrolytics.**

- Dynaco PAS2/3 \$50
- Dynaco Mark III \$40 (for pair)
- Dynaco Mark IV \$40 (for pair)
- Dynaco SCA-35 \$25
- Dynaco ST-35 \$25
- Dynaco ST-70 \$30
- EICO HF81 \$55
- EICO HF85 \$45
- EICO HF86 \$35
- EICO HF87, HF89 \$50
- Fisher X-101, X-202, etc \$55
- Fisher 400 Receiver \$60
- Fisher 500C Receiver \$65
- Fisher 800B, 800C \$65
- McIntosh C-20, C-11, C-22 \$100
- McIntosh MC30, MC40, MC75 \$45 ea
- McIntosh MC60 \$50 ea
- McIntosh MC225, 240 \$65
- McIntosh MC275 \$75
- Scott 130 \$80
- Scott 222, 222B, 222C, D \$60
- Scott 299, 299B, 299C, D \$60

## Illinois Capacitors

**ICMWR** Metallized Polyester (630Vdc rating)

0.001uf	\$0.80 ea
0.002uf	\$0.80 ea
0.0047uf	\$0.80 ea
0.0068uf	\$0.80 ea
0.01uf	\$0.90 ea
0.022uf	\$0.90 ea
0.047uf	\$1.00 ea
0.068uf	\$1.20 ea
0.1uf	\$1.30 ea
0.22uf	\$1.60 ea
0.47uf	\$2.20 ea
1.0 uf (400V)	\$2.50 ea
2.2uf (250V)	\$2.75 ea
3.3uf (250V)	\$3.20 ea
4.7 uf (250V)	\$3.80 ea
6.8uf (250V)	\$4.20 ea

## Ultra-Tone Silvered Foil in Paper and Oil Capacitors

98% pure silvered foil in kraft paper impregnated with non-toxic mineral oil and petroleum jelly, sealed in epoxy. Silver plated OFC leads with inner foil marked (650Vdc rating)

0.01uf	\$13.20 ea
0.02uf	\$15.40 ea
0.05uf	\$17.60 ea
0.1uf	\$20.90 ea
0.22uf	\$30.80 ea
0.47uf	\$44.00 ea
1.0uf	\$76.00 ea
2.0uf	\$110.00 ea

*Ultra-Tone Silver capacitors are superb performers. Our customers tell us these are the **smoothest, best-sounding and most musical** capacitors available.*

## Ultra-Tone Polypropylene Film & Foil Power Supply Capacitors (Not Silver Foil)

20uf @ 650V	\$22.00 ea
50uf @650V	\$40.00 ea
100 uf @650V	\$60.00 ea

## FREDS (Fast Recovery Diodes)

IXYS 600V 8A	\$3.00 ea
IXYS 1200V 11A	\$6.00 ea
60V 5 Amp Schottky	\$1.50 ea

## Illinois Axial Electrolytic Capacitors

Great Value and very dependable.

3.3uf @350V	\$1.20 ea
4.7uf @350V	\$1.45 ea
10uf @450V	\$1.60 ea
22uf @250V	\$1.95 ea
22uf @450V	\$2.25 ea
22uf @500V	\$2.85 ea
47uf @35V	\$1.50 ea
47uf @350V	\$2.50 ea
47uf @450V	\$3.45 ea
100uf @160V	\$2.95 ea
100uf @350V	\$3.90 ea
100uf @450V	\$4.90 ea
1000uf @25V	\$1.75 ea
2200uf @35V	\$2.75 ea

## Hovland MusiCaps Polypropylene Foil and Film

High resolution, great-sounding film caps perfect for all types of audio equipment upgrades.

0.01uf @1600V	\$9.79 ea
0.022uf@1000V	\$9.82 ea
0.033uf @600V	\$8.01 ea
0.047uf @1KV	\$12.05 ea
0.1uf @600V	\$11.52 ea
0.22uf @600V	\$14.55 ea
0.47uf @400V	\$12.80 ea
0.47uf @600V	\$21.71 ea
1.00uf @400V	\$21.66 ea
2.2uf @200V	\$23.83 ea
3.0uf @200V	\$28.45 ea

**Note: Only the above Hovland values in stock.**

## Tube Sockets

Octal Ceramic Chassis	\$3.50
Octal Ceramic PC mt	\$3.00
Octal NOS Phenolic	\$3.50
9 Pin Ceramic PC	\$2.50
9 Pin Ceramic Chassis	\$3.00
9 Pin Ceramic GOLD	\$5.00
9 Pin Plastic w/shield	\$4.00
9 Pin NOS Brn Phenolic	\$3.00

**Order Fast from our on-line catalog**  
[www.vacuumtube.com](http://www.vacuumtube.com)

## Can Electrolytic Capacitors

**20,20,20,20 @475V** (Mallory type) \$29.00

**50+50uf @500V** LCR w/clamp \$21.50

**100,100uf @500V** LCR w/clamp \$28.00

**40,20,20,20uf @500V**, LCR w/clamp \$32.00

## D.H.Labs Silver Sonic Wire

**Rated as the best sounding wire for the money by several audio publications.**

*"This is nothing other than a superb cable. It can be used with confidence with the finest of systems."*

**Make your own speaker cable & interconnects. Save BIG!!!**

**Silver Sonic T-14** Speaker Wire \$4.00/ft  
**Silver Sonic BL-1** High Definition Interconnect Wire \$3.50/ft

**Silver Sonic OFH-20** High Performance Silver/Teflon Chassis Wire \$0.95/ft

**RCA-2** Gold Tiffany-Style Interconnect Plug \$10.95ea

**B-1C** Gold Banana Plug and Insulator \$5.50/pr  
**BSP** Gold Mini Spade Speaker Terminals for Vintage Hi-Fi \$1.10 ea

**AMEX, VISA, MC OK**

**Send \$3.00/US, \$4.00/US\$ Foreign for our 24 page informative catalog with cool NOS tubes parts and Vintage Hi-Fi. VTV Pro-Tube Shop, P.O. Box 691, Belmont, CA 94002 USA**

# More Than Just Tubes

If You're Looking for that Special Mix of New and Vintage Components for a Special Project, There's a Good Chance We have Everything You Need under One Roof.

Tubes • Transformers  
Capacitors • Resistors  
Books • Videos • Knobs  
Grill Cloth • Chokes  
Filament Transformers  
Tube Sockets • Project  
Chassis • Soldering Tools  
Switches • Speakers  
Decals • Rebuild Kits  
Replacement Dials • Test  
Equipment • Meters  
Spotters Guides  
Reproduction Manuals  
Paint • Tuning Capacitors  
Hats • Shirts  
More Hardware  
Than You Would Believe

Phone (480) 820-5411 FAX (480) 820-4643 or (800) 706-6789

Visit our website at [www.tubesandmore.com](http://www.tubesandmore.com)

ANTIQUE  
ELECTRONIC  
SUPPLY<sup>®</sup>

ELECTRON TUBE

RCA  
Transmitting  
Tubes

SYLVANIA  
RADIO TUBE

S  
Svetlana

