

VACUUM TUBE VALLEY™

Issue 13
Winter 2000

The Classic Electronics Reference Journal

Published Quarterly
Price \$9.00

6L6 Shootout: 20 Types Tested

The Story of Klipschorn

Out of the Corner & Into the Limelight

Klipschorn®

Scott 222 and LK-48

Sweet Sound for a Song



6528 Cathode Follower

Single-Ended Amplifier Project

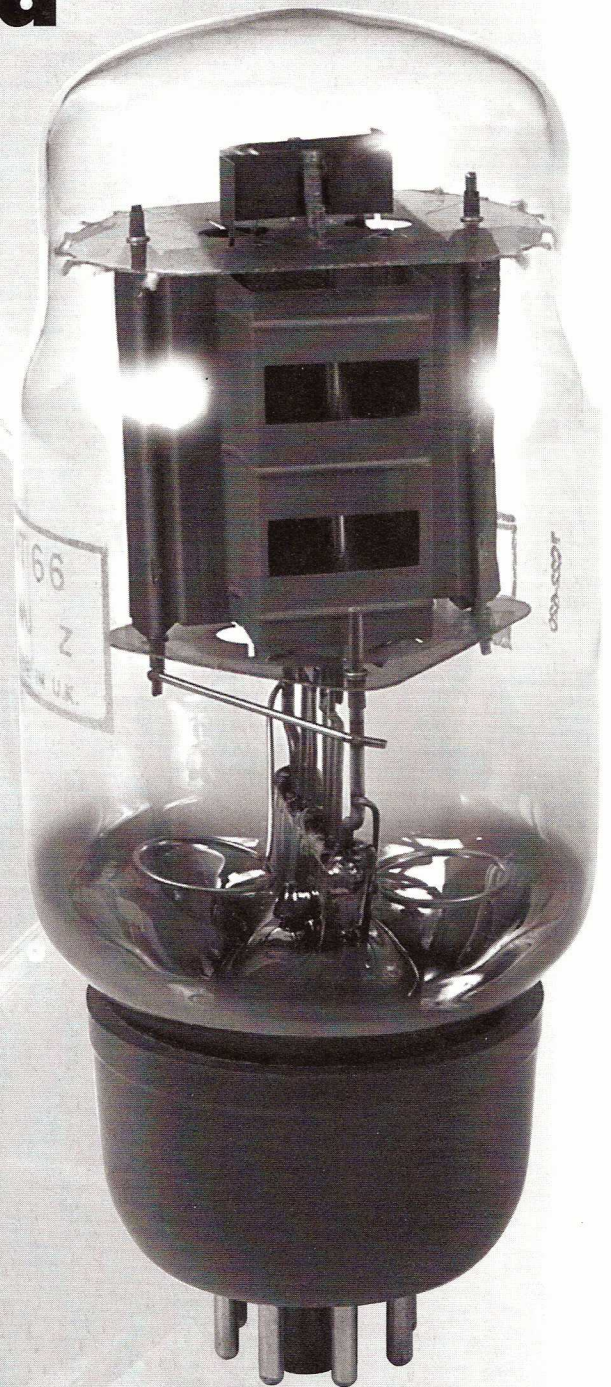
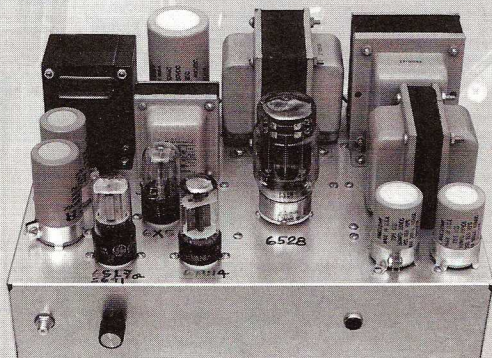

Visit us on the web
www.vacuumtube.com

VACUUM TUBE VALLEY

P.O. Box 1499, Lakeport, CA 95453 USA
Phone (707) 263-5881 FAX (707) 263-7648
<http://www.vacuumtube.com>

February 17, 1999

Mike Matthews
Sovtek/New Sensor Corporation
NYC, NY

Dear Mike,
Thanks again for sending us the new 12AX7LP tubes for evaluation. VTV conducted both listening and electrical tests on the tube.

John Atwood, VTV Tech Editor, took the 12AX7LPs to his One Electron Laboratory and used a Tektronix 570 curve tracer to evaluate the tube's electrical characteristics. John noted that the tube is very linear and has great looking curves, indicating a well-made tube. Compared to the Sovtek 12AX7s of the past, he felt that your new tube is significantly better. In fact, John commented that its quality approaches the famed Telefunken ECC83 smooth plate.

Next, we gave the 12AX7LPs to Roger Coon, a well-known record collector and a major audiophile in the San Francisco Bay Area. Roger is a very critical listener and has "golden ears," plus, he recently completed a 12AX7 listening test for a future issue of VTV. He notes: "large, full soundstage, very musical with nice detail." He compared it to the sound of a Mullard CV4004 box plate 12AX7, but not quite as detailed. In short, Roger was impressed with your tube.

Then I listened to the 12AX7LP in a variety of tube preamplifiers and amplifiers. You have a very musical, smooth and involving tube. It is easy to listen to for long periods of time, like a quality tube should be. This will be a great tube for both hi-fi and guitar amp applications. I think it sounds a lot like a vintage Brimar 12AX7.

Compared to anything else out there in the 12AX7 market, with the exception of some primo NOS stuff, I feel that the Sovtek 12AX7LP is the best sounding one on the market at this time. In conclusion, you have a winner here!

Thanks again and best regards.

Vacuum Tube Valley
Charlie Kittleson
Editor of VTV

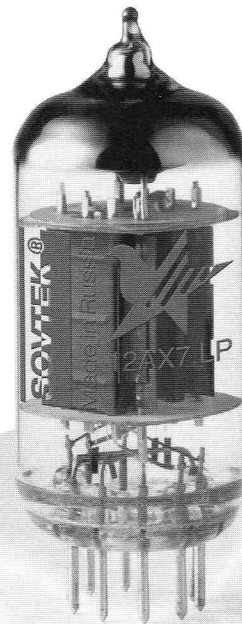

NEW SENSOR CORPORATION
20 COOPER SQUARE NEW YORK CITY, NY 10003
FAX (212) 529-0486 INFO@SOVTEK.COM WWW.SOVTEK.COM

**VTV Issue # 13
Table of Contents:**

- Interview with Paul Klipsch 4**
- Klipschorn: Lore and Mods..6**
- Classic 2A3 Amplifier.....10**
- Problems with Electronics..13**
- Scott 222 and LK48.....15**
- Computing with Tubes20**
- ASUSA K2003 Review.....21**
- 6L6 Shootout.....22**
- 6528 SE Amp Project.....26**
- Subminiature Tubes.....28**

**Coming In the Next
Issue of VTV:**

- **12AX7 Shootout**
- **Exclusive Interview with David Hafler of Dynaco**
- **Dynaco Tube Products Historical Review**
- **Gillum G-3 Speaker Review**
- **Direct Reactance Drive SE Amplifier Project**
- **PP SV 83 Amplifier Project**

Southern CA Hi-Fi Swap

The 4th Annual Southern California Hi-Fi Swap will be held on April 30, 2000, at the Holiday Inn Buena Park, 7000 Beach Blvd., Buena Park, CA.

Includes current high-end, vintage, parts, tubes, etc. Vendor tables \$40 (8:00 AM setup), Early admission (10:00 am) \$5, (10:00 AM) \$3. Call (909) 931-9686 to reserve a table or (714) 522-7000 for directions. www.upscaleaudio.com.

Vacuum Tube Valley is published quarterly for electronic enthusiasts interested in the colorful past, present and future of vacuum tube electronics.

Subscription Rate: US\$45/4 issues 1st Class-\$36 3rd Class; Canada/\$48; Asia/\$66; Europe/\$56

US Bank Check, Credit Cards or Cash are accepted for payment.

**Phone - (707) 263-5881
FAX - (707) 263-7648**

Eric Barbour Wins Tyne Award

At the 38th Annual Conference of the Antique Wireless Association (AWA) on September 3, 1999, VTV Senior Editor Eric Barbour was awarded the Tyne Award. This award is given yearly to an AWA member for recognition of work in documenting the history of vacuum tube electronics.

Mr. Barbour has written several articles dealing with the history of audio and other types of tubes for Vacuum Tube Valley and Glass Audio magazines. He is also a volunteer for the Computer Museum History Center in Mountain View, CA. He has helped them document and restore some of the Museum's historical vacuum tube computer exhibits. Eric manages the Vacuum Tube Applications Laboratory and provides customer technical support for Svetlana Electronic Devices in Portola Valley, CA.

New Contributing Editors at VTV

We are pleased to announce two new contributors to Vacuum Tube Valley:

David Bardes is a loudspeaker enthusiast and a DIY. Dave will be researching loudspeaker history and conducting interviews with famous loudspeaker designers. In addition, he will be the VTV Official Product Reviewer. In the future, we will be conducting reviews of reasonably-priced loudspeakers, tube CD players and tube amps and preamps. Dave's background is in professional photography and video production. He is employed as a product tester for a well-known electronic/computer products test lab. bardes@earthlink.net

Ron Veil well-known guitar amplifier tech in the San Francisco area. He served in the US Air Force, Philips Electronics and has ten years experience in musical instrument repair and service. Ron will be a regular tube guitar amplification expert and contributor. ron@unclespot.com

Electro-Harmonix Launches New EL34

Electro-Harmonix has announced its new EL34EH which is the first in a line of improved quality tubes for the year 2000. The EL34EH has gold-plated screen grids, a tuned bi-polar cathode cover that optimizes electron focus to the plate, precision alignment and a proprietary tri-alloy plate material the reduces distortion and odd-order harmonics.

For more information, contact Electro-Harmonix at: (212) 529-0466, (212) 529-0486 FAX or www.ehx.com

Tube Collectors' Association Formed

A new Tube Collectors' Association is now in operation. This is an organization of collectors focusing on all phases, types and vintages of tube technology. The association publishes a club bulletin and is planning tube collector events, etc. For more info, contact Al Jones at (707) 464-6470 or Ludwell Sibley at (541) 855-5207 or send your mail request to: TCA, P.O. Box 1181, Medford, OR 97525

Vacuum Tube Valley Moves

We are moving! After doing business in Silicon Valley for five years, we are moving the VTV office and shop to north of Napa Valley! The air is fresher, the scenery is beautiful and there is a lot less traffic. Business will be as usual (once we get everything moved) and we will continue to operate the magazine and the audio tube and parts business. Please note the following address changes:

Vacuum Tube Valley

P.O. Box 1499

Lakeport, CA 95453 USA

Phone: 707-263-5881

FAX: 707-263-7648

email: triode@vacuumtube.com

EDITORIAL STAFF

Charles Kittleson - Publisher

John Atwood - Technical Editor

Eric Barbour - Senior Editor

Ron Veil - Guitar Amp Specialist

David Bardes - Contributing Editor

Steve Parr - Art Director

Julie P. Werner - Copy Editor

Copyright 2000 **Vacuum Tube Valley™** and **Big Tone™** All rights reserved.

No part of this publication may be reprinted or otherwise reproduced without written permission of the publisher.

Send circulation and editorial correspondence to:

Vacuum Tube Valley

P.O. Box 1499,

Lakeport, California 95453 USA

e-mail triode@vacuumtube.com

ISSN # 1095-4805

An Interview with Paul Klipsch

By David Bardes ©2000 All Rights Reserved

Paul W. Klipsch is an audio pioneer who designed and produced the Klipschorn folded-horn loudspeaker system which has been in production for over 50 years. He also developed and produced several other loudspeakers and wrote dozens of articles and papers for audio publications and societies. Klipsch was inducted into The Engineering and Science Hall of Fame on October 16, 1997 for his contributions in acoustics, ballistics, and geophysics. This interview was conducted during the Fall of 1999 with the assistance of Klipsch Company staff and, of course, Paul Klipsch who at the time of the interview was 94 years old!

When did you become interested in audio?

My father taught engines and boilers at The Boiler Institute, Purdue University. He took me down where the students practiced radio. I was around seven years old at the time. Audio was the next step up from radio; the difference being ear-phones and loudspeakers.

What experiences in your early life influenced your work with speakers and your business philosophy?

I spent several of my grammar years winding coils and transformers. That prevented me from learning how they worked.

What influenced your development of the Klipschorn?

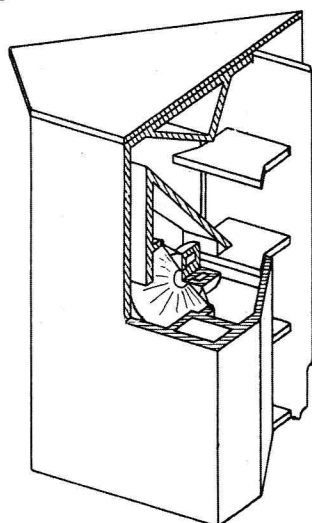

Cut-Away of Klipsch Cabinet Design

My mother bought an Edison Phonograph in 1923. When I went home for vacation from Cow College (New Mexico State), I noticed she had put it in the corner. It was the most obnoxious place for it, but it sounded better in the corner.

Later, in 1933, a fellow student at Stanford loaned me one of his 12 inch direct radiator speakers and I put it in an enclosure. At the suggestion of another fellow student, I put it in a corner. There was considerable improvement in the bass response. That prompted the idea of using the corner for a location of speakers.

Almost any speaker can be benefited by putting it in a corner. Especially in a corner application it becomes doubly improved. I have a theory yet to be proven: distortion is inversely proportioned to efficiency. That is, if we can have a speaker of 1% efficiency and compare that to a speaker of 10% efficiency the distortion will be 1/10 as great in the 10% efficient speaker.

How did you come to realize that the horn speaker was an area you wished to research?

The horn is a more efficient way of reproducing sound than a direct radiator. Bell Laboratory's horns achieved 30% efficiency against 1% from the typical direct radiator and 1/10% for some over-advertised direct radiators.

Describe how you developed the idea of the folded horn.

I didn't do it. I deny the accusation. In the late 20s and early 1930s, Bell Telephone Laboratories woofer horns were folded. The pipe organ employed folded pipes. To answer the question "How do you put a 16 foot pipe in a 10 foot room?," the folded pipe was the first step. In order to build a horn type loudspeaker to go down to 30 Hz, you fold it to get it in an ordinary size living room.

Which drivers were used in these early models?

The drivers used in these early models were experimental. To name one, Electro-

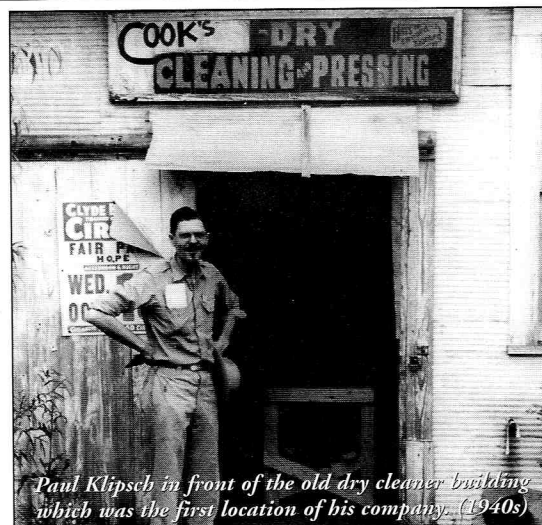

Voice 12 inch direct radiator, which was capable of about 1% efficiency, but by putting it in a horn we got 10% efficiency.

The earliest tweeter I can recall was offered by Bell Labs. It dictated the trend in tweeters that they have a small diaphragm which enables them to handle high frequencies or very short wave lengths. We tried them all.

From the Klipsch company Web Pages, I see that you started in the back of a laundry business. Please describe the evolution of your facilities from those early days to your current production facilities.

In 1946 I was invited by Sherman Fairchild, who manufactured airplane wings during the war, to New York to visit his plant. While I was there I priced buildings to start a small manufacturing facility.

One offering was a 11 x 16 foot room for \$400 a month. This seemed awfully steep. The laundry business here in Hope offered me a sheet iron building for \$10 a month. Since I didn't have any income, that looked like an opportunity. It was there that I developed techniques for making a molded high frequency horn that would accompany the low frequency woofer horn which was folded.

The adhesive I used was initially a success, but eventually the horns would warp. I sold several of these horns. I offered to take them back and substitute them with a horn molded with a warp-free molding compound. Most of them stayed sold.

Your decision to start up business in Hope, Arkansas placed the town on the map. What were the advantages and disadvantages of doing business in a small rural town?



Front of the original Klipsch factory in Hope, Arkansas (1950s)

I was ordered to come to Hope, Arkansas to work in the Army Ordnance Corps. where they tested ammunition. My decision to stay in Hope after the war was influenced by the fact that many of the buildings would be sold as surplus. After the war, I purchased the Telephone Exchange building in the proving ground which cost \$30,000 to build and I bought for \$3,000 (it is now the museum). The advantage of starting in a small building is that it did not cost too much.

Describe some of the challenges of building and marketing your business. What were some of the "victories" that occurred along the way?

When you try to break into a manufacture of a new engine you have the makers of existing engines as competition. I think I enjoyed more failures than I did

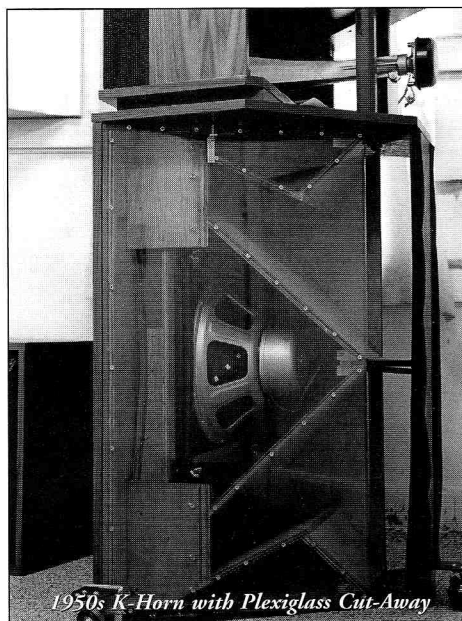

1950s K-Horn with Plexiglass Cut-Away

successes. But one learns from failures.

From early Klipschorn literature, I noticed that the mid-horn looked like a radial horn. When and why did you switch to an exponential horn?

The first high frequency horn consisted of a horn with a radiation angle of 90 degree horizontal and 30 degree vertical. These were made with wood sides and molded high and low boundaries. High frequency horns have been patterned after the general structure. Tests of the polar pattern of our current high frequency horn (used in the Jubilee), show how this horn structure is a significant improvement over contemporary horns.

Describe the Klipschorn prototypes such as the X2 and X3.

I guess every advancement in a given art should have a experimental name. The X2 and X3 were experimental changes #2 and #3.

When was the first Klipschorn sold? How much did it cost?

The first Klipschorn was sold in 1946. It cost about \$500 for one.

How many Klipschorns have been sold?

I don't know how many Klipschorns have been sold. I guess several thousand.

Which Klipsch speaker has been the most popular?

Of all the speakers I have built the Klipschorn is the most successful. Various smaller versions have been manufactured by myself and others.

Have any Klipschorns been sold oversea? If so, which countries?

Yes, all of the European countries, and also many sales in Asian countries and Africa.

I believe that you experimented with three-channel audio. What were your findings? Is this a viable playback format?

Bell Telephone Laboratories used 3 speakers spaced for a stereophonic sound reproduction. I did some experiments

with 2-channel stereo, right and left, and also 3-channel, right - center - left. All were relatively successful.

Which musicians, movie stars, and celebrities own or have owned Klipschorns?

Edwin Armstrong, inventor of the FM radio, bought 5 of our early Klipschorns, probably X1s. He bought them to assist in selling FM. Whether it was successful in that respect I don't know. Success in FM has taken place. The conductor of the Boston Pops orchestra had a Klipschorn.

I noticed in some of the old literature, that other companies have or had manufacturing licensing under your patents. Companies such as Vitavox, Electro-Voice, Western Electric, and the Radio Shack Corporation were listed. I'm aware of the Vitavox, Georgian, and Patrician corner horns. Were these other companies building corner horns from your designs?

Radio Shack did sell a few Klipschorns that we made. Yes, we did license a small number of companies. One company made a manufactured copy without a license and advertised as an improved Klipschorn (the patent had long since expired) but the Klipschorn was a registered trademark and the company was nice enough to quit using the name Klipschorn. I bought one and tested it. It had big holes in the response curves.

Were any of your speakers offered as kits?

Yes, I think we made a kit for a person I wanted for a client. He built the box and put his own driver in it and it probably worked. I'm not particularly proud of my kits. After all, a kit is something somebody puts together with a bunch of boards. If they fit together - fine. If they don't, why, they nail them together and make them fit, and then it rattles.

What audio equipment did you like or find well engineered?

As far as equipment, it was homemade amplifiers. Also, I liked an early amplifier of 1948 vintage made by Brook. The Brook amplifier used 2A3 tubes and put out 10 watts with very low distortion.

Where do you see the future of music reproduction heading?

I'm not a prophet. I thought the tape recorder would solve a lot of our problems. Now we have the Compact Disc.

Continued on Page 30

Klipschorns

Out of the Corner & Into the Limelight

By David Bardes ©2000 All Rights Reserved

Audio Origami

Paul Klipsch made audio history when he took the concept of the folded horn and transformed it into a compact speaker designed for the music lover. Far from compact by current standard, this speaker brought the deep dynamic-bass and the wide frequency range of the giant movie theater speakers of the 30s and 40s into the post-war living room. By using the room's corner as an extension of the bass horn, this speaker could be tucked out of the way while producing deep bass, and a live dynamic sound that few speakers could rival.

Even more amazing is the longevity of this much copied (and licensed) speaker. No other speaker can claim to have been in continuous production for over fifty years. Only a few speakers can claim to have been around for even half that long. Dismissed by many as an old-fashioned plywood construct, noted only for its ability to play loud, the Klipschorn has developed a following and continued interest that has kept it in production all these years.

Klipsch and Associates (now Klipsch Inc.) has continued to refine the design over the decades, but the current Klipschorn is an obvious descendant of the first Klipschorns produced by Paul and his employees in a building on the Army Ordnance Proving Ground outside Hope, Arkansas.

The Man and the Speaker

Paul Klipsch will always be known for developing the Klipschorn. Despite many other accomplishments, contributions, and successful speaker designs, his first contribution to audio history outshines them all. While in Chile in 1930, Paul's interest in amateur radio and his great curiosity lead him to compare cone speakers and horn loaded speakers. The result of these comparisons

developed into a working tenet in all his designs, and a mantra that Paul still utters today: "Speaker efficiency and speaker distortion share an inverse relationship. The greater the efficiency, the lower the distortion. Horn speakers therefore, have a natural advantage over conventional cone speakers." Later at Stanford University, Paul noted a fellow student's claim that speakers sound better in a corner. This was also a time of research for Paul. He read, with great interest, the Symposium of Auditory Perspective by Bell Telephone Laboratories.

These experiences blended and synthesized into the corner horn concept. And in 1939, while stationed at the proving ground, Paul made his first sketches and paper models of the Klipschorn. By 1941 the Klipschorn idea had become a full engineer's manuscript. In 1942, using only hand tools in his garage, Paul con-

structed the first successful prototype, the X3. That same year, Paul applied for a patent on his design. At the patent office he discovered several other corner horn designs. Paul's design might not have been the first, but his determination and his skill as an engineer made his design a success.

High Notes

Historians at Klipsch can't tell us how many Klipschorns have been made, but the Klipschorn has made its mark in audio history. By the early 1980s, over 20,000 had shipped. Klipschorns were the speaker of choice for Edwin Armstrong in promoting FM broadcasting. The Klipschorn was used to demonstrate stereo technology as early as 1955, and was used in 1958 to demonstrate three-channel audio at the World Fair in Brussels with the world's first center channel speaker, the Klipsch Heresy.

The voice of President Johnson was heard at Edwards Air Force Base through a Klipschorn modified for PA use. Klipsch's bass horn design was also licensed to other manufacturers around the world. Sought after vintage speakers such as the Vitavox and the Electra-Voice

Patrician are two of the best examples of this licensing arrangement. Even Leslie organs used a modified Klipschorn, using a paddle wheel installed in the mid-horn, powered by a turntable motor to get that organ tremolo sound.

Evolution

The Klipschorn has seen many refinements and changes over the years. The first Klipschorns were of a two-way design and used a variety of Stephens, University and Western Electric drivers. The first production run of 12 Klipschorn speakers occurred in 1947. Baldwin Organ and Piano Company built the cabinets and a local cabinet shop built the next seven. At this time, the back chamber for the woofer was enlarged to improve its performance.

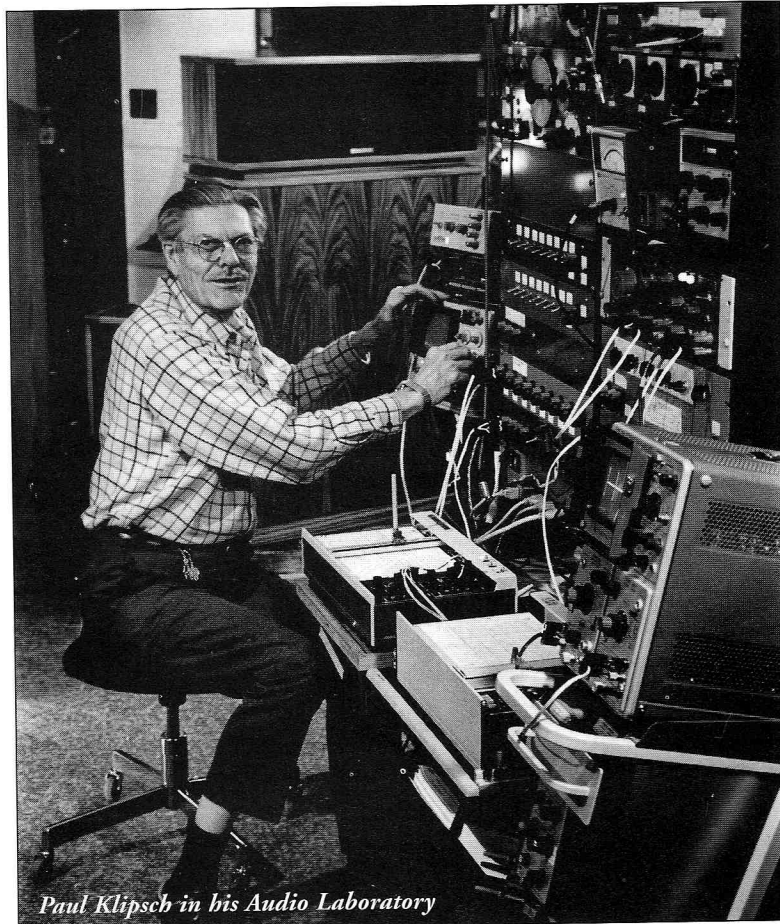

Paul Klipsch in his Audio Laboratory

In 1948, Klipschorns were built in the first Klipsch factory at a former telephone exchange building at the Army Ordnance Proving Ground in Hope, Arkansas. This is currently the site of the Klipsch Museum of Audio History. In 1951, the first three-way Klipschorn appeared, using the same tweeter that was used in the famous Jensen triaxial speaker, the G-610. It was not until 1952 that a final three-way design was developed. The two-way designs were flat to about 12 kHz, but with the improving quality of recorded music, a need for extended treble was realized and implemented.

In 1958, driver polarity was first observed, and a process was implemented to make their wiring and installation consistent. In 1961, the woofer throat width was reduced from six inches to three inches to boost response in the 400 Hz range, and to flatten the bass response. In 1964, the radial mid-horn was replaced with an exponential horn.

This resulted in a narrower dispersion pattern, but flatter frequency response. The mid-horn material was changed in 1987. Structural foam was used instead of metal for lower distortion. In 1983, Klipsch first started flush mounting the tweeters. Earlier designs had the tweeter mounted on the rear of the motorboard, which caused diffraction distortion. Also in that same year, corner gaskets were added to the tailboard to help seal the bass horn in oddly shaped corners.

For the Millennium, Klipsch will be unveiling the Jubilee edition of the Klipschorn. Using two 12 inch woofers instead of a single 15 incher, the bass horn is now capable of high frequencies up to 800 Hz. This allows the use of a two-way design incorporating a tractrix mid-hi frequency horn. The external dimensions are a bit larger as is the price tag, but with the Jubilee, Paul Klipsch has returned to the two-way design he started with in 1947.

Klipschorns have had many changes to the drivers and cross-over networks - too many changes for interesting reading. Please refer to our tables on page 9 for cross-over and driver information.

Accommodations

For those lucky few who have the space and a willing partner, Klipschorns can provide a listening experience unmatched by tower or bookshelf speakers. Klipschorns provide a big, dynamic and spacious sound. For tube heads, Klipschorns offer all the advantages of a horn speaker system in a single attractive enclosure. They can also be quite a bar-

gain in the crowded world of used speakers.

As with any pair of speakers, careful room placement is needed for the best sound. With the Klipschorns, your room placement options are quite limited, so the size and shape of the room are critical. Two 90-degree corners are needed to place the speakers. Adequate space on either side of the speaker is needed for the walls to act as the final flare of the bass horn. Crowding furniture up against the speakers will hamper the bass efficiency. If the corners are too far apart, then a center speaker will be needed to fill in the center. A similarly voiced speaker, such as the Heresy, fed a L+R signal at about 3dB down, will provide a huge soundstage. Placing the speakers in corners that are too close will bring the optimum listening position closer to the speakers and may set up some interesting standing wave room modes.

The listening room needs to be of at least medium size or the Klipschorns will visually dominate the room, and limit the bass extension of the speakers. The room must also have a moderate length to width ratio. Length to width room ratios greater than 2 to 1 can be problematic. The exponential mid-horn controls the dispersion so that room reflections are not as troublesome as with some wide dispersion speakers (this is good news for the corner bound Klipschorn). As a result, the need for acoustic room treatment is reduced. Within the sweet spot, stereo imaging is accurate and spacious.

Modifications for Klipschorns

One of the great advantages of owning a pair of Klipschorns is the ability to modify it as you go. With larger than life parts, modifying these speakers is easy, no surface mount soldering is required. However, care must be taken to work towards a better end result. Klipschorns sound pretty darn good right out of the box, or crate, and what works for other speakers may actually detract from the Klipschorn's performance.

This is especially true of the older Klipschorns. We strongly urge those who own these older speakers not to replace the paper-in-oil capacitors and alnico drivers. As you'll see, some of our recommendations include the use of these tried

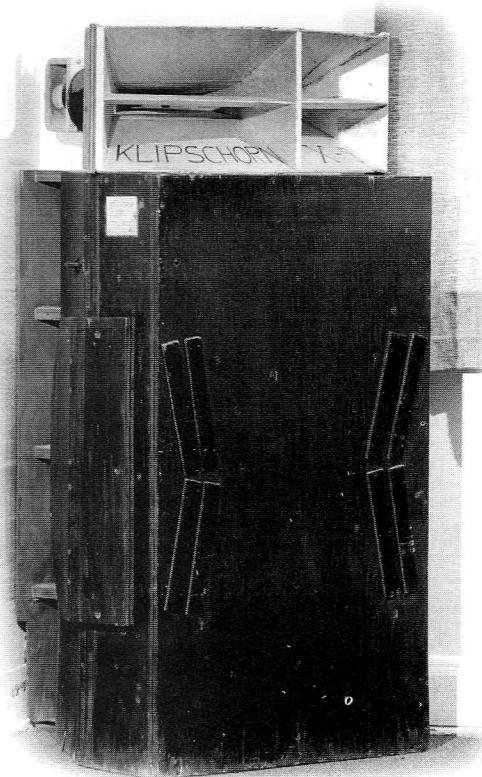

and true speaker parts. Here are some of the modifications we made on our pair of Klipschorns, which were produced in 1989:

Notch Filter

The Klipsch midrange driver (the later mid-driver supplied by Atlas-Soundolier K-55V or Electro-Voice K-55E) and horn combination create a spike at about 9 kHz, clouding the tweeter response. A tip of the hat to Max Potter who suggested that a simple LC filter would do the trick. Sure enough, this is a great bang for the buck modification. Take a .1 mH coil and a 3.0 mF capacitor and place them in parallel just upstream from the positive side of the midrange driver. The spike will be absent with this filter in place. This took care of the harsh sound we had attributed to an aggressive, shouty mid-horn.

Horn Damping

While the older metal midrange horn rings more than the newer poly-foam horn, both can benefit from some vibration damping. Dynamat or modeling clay wrapped around the horn is all that is required. Sonic benefits include a deeper soundstage and a darker silence between the notes. This seemed to make a modest change at first, but further listening proved the value of this modification.

Klipschorn®

CORNER
HORN
LOUDSPEAKER
SYSTEM



VACUUM TUBE VALLEY ISSUE 13

Alnico Tweeter

We replaced the stock Electro Voice sourced ceramic magnet tweeters with EV TW-35 tweeters. The original Klipschorn tweeter, the T-35B, and the TW-35 are all the same alnico tweeter from EV and are a drop in replacement for the stock ceramic tweeter. The TW-35 has a slightly smaller magnet (and is a tad less sensitive). These tweeters sound much sweeter and more extended than the stock ceramic tweeters. The even more robust T-350 may be used, but some padding will be required for its higher sensitivity.

Alnico Woofer

The stock woofer in our Klipschorn came with a ceramic magnet and stamped metal frame. To upgrade this driver we turned to the vintage JBL D130A. With its four inch voice coil, hefty alnico magnet, and cast aluminum frame, this driver provides deeper, more dynamic bass and midbass. Other vintage selections include the Altec Lansing 515B or 515C. A note of caution: these efficient vintage drivers are not designed to handle large doses of amplifier power, so go easy on them if you decide to bi-amp. Modern pro drivers can also be used. Drivers by Electro Voice, TAD-Pioneer, and others can provide a good match for the Klipschorn. Admittedly, this modification can be an expensive proposition as vintage drivers are expensive and hard to find, and current high-quality pro drivers are just plain costly.

Zobel Network

Like the CR circuits hiding in some expensive cables, this simple network smoothed out the sound of our horns, while providing some impedance compensation for the midrange and tweeter. We placed an 8.2-ohm resistor in series with a 2 uF capacitor and strapped them across the plus and minus terminals of the mid/hi crossover networks.

Fancy Cable

Why not? It's probably a good idea to use the same speaker cable inside your speaker as you use on the outside. For us, that was T-14, silver coated OFC cables from DH Labs. Figure another 6 stereo feet for the cable inside the Klipschorns.

Amplifier Recommendations

Klipschorns are, of course, very sensitive speakers. Any hum or hiss present in the amplifier will be immediately apparent, so whatever amp is selected, it must be quiet! Further, Klipschorns are not a good match

Crossovers

Year	Network	Low Pass	Mid Hi Pass	Tweeter Hi Pass
Pre-1966	Various	6dB/Octave	6dB/Octave	6dB/Octave
1966	A	6dB/Octave	6dB/Octave	6dB/Octave
1971	AA	6dB/Octave	6dB/Octave	18dB/Oct. + Diodes
1983	AK	12dB/Octave	12dB/Octave	18dB/Oct. + Trap
1983	AK-2	12dB/Octave	12dB/Octave	18dB/Oct. + Trap
1989	AK-3	12dB/Octave	12dB/Octave	18dB/Oct. + Trap

Tweeters*

Year	Designation	Manufacturer	Magnet Material
1951	4401	University	ALNICO
1958	K-77 (T-35)	Electro-Voice	ALNICO
1980	K-77-M	Electro-Voice	Ceramic

* Note that in the 1940s and 1950s, many units were shipped without drivers, or with customer-supplied drivers. Also, there were many other drivers not mentioned that were briefly (or uniquely) utilized.

Mid-Range Drivers

Year	Designation	Manufacturer	Type	Magnet Material
1947	713A	Western Electric	2-way	ALNICO
1949	P-15	Stephens	2-way	ALNICO
1951	SAHF	University	3-way	ALNICO
1961	K-55-V	Atlas	3-way	ALNICO
1983	K-55-M	Electro-Voice	3-way	Ceramic

with high-power amplifiers. High current amps that are required to drive and control less sensitive speakers are not needed. Big-ticker solid-state amps, that may sound good elsewhere, will sound

crowded and congested with the Klipschorns. Even ultra-linear push-pull amps don't have the finesse needed to keep Klipschorns sounding sweet.

Pentode-based tube amps can work, if they are low-wattage (under 35 wpc) and have a relaxed non-aggressive sound. Remember, the horns will supply all the dynamics needed; the amp needs to sound clean and transparent. McIntosh, Dynaco ST-70s or ST-35s, and other EL34 or 6BQ5 amps will work quite well.

Any good triode amp, one lung or two, will make the Klipschorns sing. Brook amps (push-pull 2A3s) were the staple diet of Klipschorns in the late 40s and 50s. A good 2A3 amp is scary-good with a K-

Woofers

Year	Designation	Manufacturer
1940s	P52LX2	Stephens
1940s - 50s	103LX2	Stephens
1950s - 60s	EV 15WK	Electro-Voice
1950s - 60s	K-33-J	Jensen
1960s - 70s	K-33-B	CTS
1970s	K-33-P	CTS
1970s+	K-33-E	Eminence

horn, and similar results can be had with 300B amps as well.

With proper room placement, a tweak here and there, matched to a good tube amplifier, listening to the Klipschorn can be a very rewarding experience. The Klipschorn is also a piece of audio history for your listening room, and at 104 dB sensitivity, any flea powered amp will work. In fact, when the power went out recently during a listening session, our Klipschorns played along just fine with our battery-powered Discman. Many Klipschorn owners are enthusiasts for life.

Special thanks to Max Potter and Jim Long for their assistance with this article.

A Classic 2A3 Amplifier

VTV Construction Project

By John Eckland ©2000 All Rights Reserved

Why the 2A3?

Audiophile preference for triodes over tetrodes or pentodes is nothing new. Even back in the 1930s, there were strong opinions about the superiority of triodes such as the 2A3, 10, 45 and 50 over the 42, 6L6 and 6V6 beam tetrodes, etc. Triodes

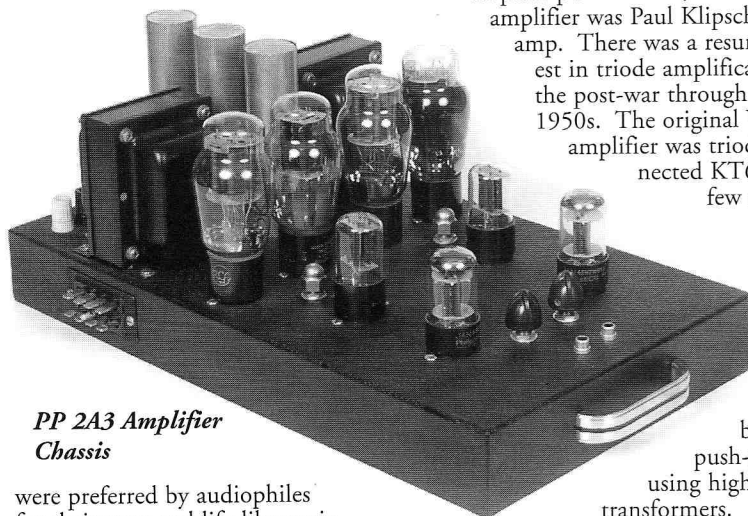

PP 2A3 Amplifier Chassis

were preferred by audiophiles for their pure and life-like sonic characteristics. Pentodes were preferred by OEMs for their efficiency and higher power output. McMurdo Silver, Philco, RCA and E. H. Scott offered push-pull or push-pull parallel triode output stages in some of their higher-priced radios from the mid to late 1930s.

Introduced by RCA in 1933, the 2A3 (in its original single-plate version) quickly became the preferred tube in many high-quality phonograph amplifiers, even after the introduction of the beam tetrode 6L6 in 1935. AmerTran, Chicago, Stancor, UTC, Jefferson, Thordarson and other transformer companies offered high-quality 2A3 transformers and push-pull 2A3 amp schematics and parts lists in their catalogs. An especially elaborate transformer-coupled 2A3 amplifier was the 1935 Thordarsen Tru-Fidelity Phonograph Amplifier. Ultimately, the 6L6 began to be used more in radio receivers and commercial sound applications. 2A3 amplifiers were reserved for early recorded music perfectionists, who often built their own amps.

During the post-war era, returning GIs and other audio enthusiasts again gravitat-

ed towards the 2A3 as their favorite hi-fi tube. Fortunately, inefficient speakers such as the AR3 were not in vogue yet, so the super-efficient Altec, JBL, Klipsch, Jensen and Western Electric speakers were ideal for low-powered triode. Amplifiers like the Brook 12A3 and 10C3 used 2A3s in push-pull. In fact, the Brook 12A3 amplifier was Paul Klipsch's favorite amp. There was a resurgence of interest in triode amplification during the post-war through the mid 1950s. The original Williamson amplifier was triode: triode-connected KT66s. Since very few manufacturers actually offered triode amplifiers during this period, many enthusiasts preferred to build their own push-pull 2A3 amps using high quality output transformers.

Why Push-Pull?

During the 1930s, single ended was considered a cheap circuit with limited power, and many audio enthusiasts preferred push-pull amps. The most popular application for single-ended amplifiers was the output stage in low-priced radio sets. Transformer quality in single ended amplifiers, with the exception of some pro-audio amplifiers like the Western Electric 91A, was marginal at best. There was next to zero interest in SE amps until the 1960s, when French and Japanese audio nuts started experimenting with ancient single-ended Western

Electric amps and horn speakers. They claimed that jazz music sounded "live and vibrant" through this setup.

In the last ten years, SE amps, formerly an underground oddity, have become more visible and are appearing on the covers of even mainstream audio publications. There are literally dozens of companies world-wide producing SE amps and there have never been more high-quality SE transformers available to audio constructors and OEMs.

Today, I think push-pull triode amps are set for a revival with modern day audio constructors and OEMs. When the SE folks start exploring different push-pull circuits and designs, I think we will start seeing more PP 300B, 2A3 and 45 amps than ever before. If you ask a more seasoned audio enthusiast, you will find that many prefer the sound of push-pull triodes over just about any other design. This is because PP triodes have a sweet, balanced sound, deeper bass, and can be used with a wider variety of loudspeakers. SE amps, on the other hand, require ultra-sensitive speakers, can have softer bass response, and are prone to higher levels of second harmonic distortion.

Building the Amplifier

In the spirit of audio constructors from the golden age of radio, I decided to build a classic push-pull 2A3 amplifier using a combination of 1930s and 1940s design features. The front-end design of this amplifier is similar to a 1934 Capehart radio amplifier, with the exception that a 6SL7GT and 6SN7GT are used instead of type 56 triodes in the original Capehart design. The amplifier is direct-coupled using only two coupling capacitors per side.

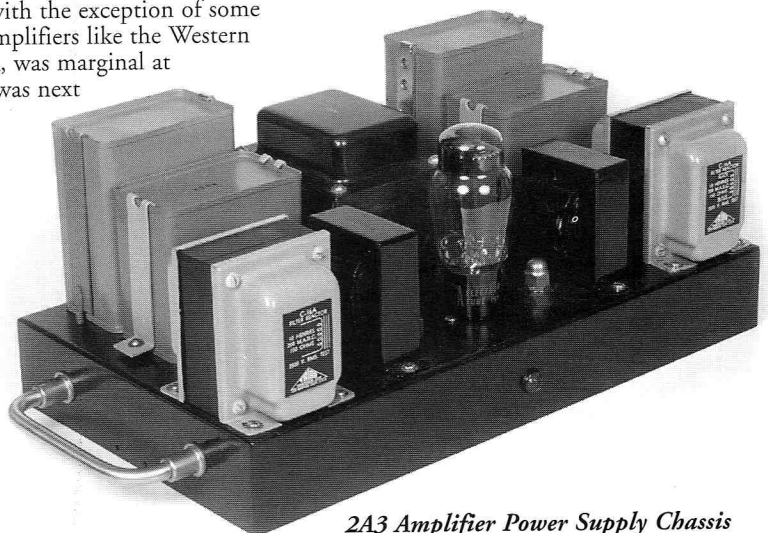

2A3 Amplifier Power Supply Chassis

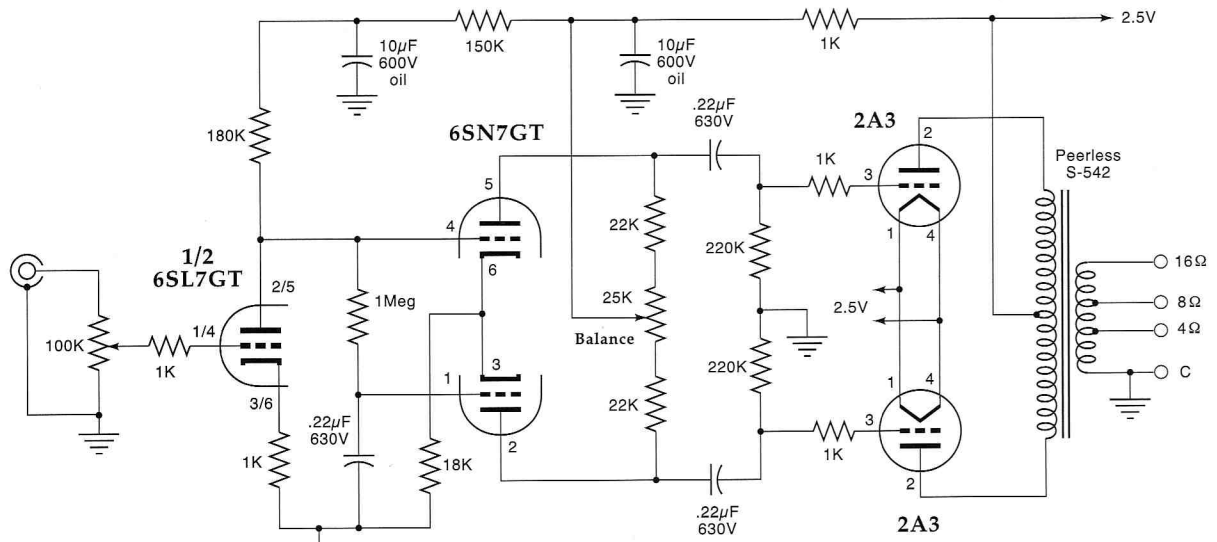

One channel shown
All resistors 2W, unless noted

Self-Bias PP 2A3 Amp
John Eckland Oct. 1999

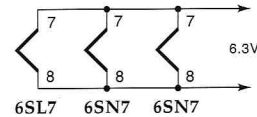

The phase inverter is a long-tailed pair design. The output stage is push-pull 2A3s in self-bias mode. A separate power supply uses a single 5U4G and is very conservatively rated.

This circuit is really quite simple and all the component values are listed on the two schematics provided in this article. If you are planning to build this amp, my advice is to read the article, obtain all the necessary parts and chassis, and carefully plan the layout of your amp. In order to cut holes in the chassis for the tube sockets, you will need to borrow or purchase a 1 1/8 inch Greenlee or equivalent circular chassis punch. All other tools needed should be in your tool kit or can be purchased from an electronics parts retailer. Be sure to carefully measure and re-measure

where you will cut the tube socket holes, mountings for the transformers and other components. Whatever you do, don't rush building this amplifier as you will wind up making mistakes, make a mess of it and lose interest in the project. You are not in a race. Enjoy the process and take your time to do a high quality job.

The chassis I used were NOS vintage aluminum BUD types that I painted wrinkle black. One chassis is for the power supply and the other is for the amplifier. If you can't find any old chassis, Hammond Corporation has several reasonably-priced chassis sizes available in either aluminum or steel. Power transformers, filament transformers and chokes are items from my parts box or the local

electronics flea market. You can also procure almost all of the inductors in this project from Hammond. Higher current ratings on filament and B+ transformers are OK, but avoid any lower ratings than what is specified in the circuit.

Wiring was done in the classic style with buss-bar grounding and lots of elbow room under the chassis. Tube sockets are vintage ceramics, but the new Chinese ceramic sockets will work fine. I originally tried 1950s vintage Sprague Black Beauty .22uf@600V coupling capacitors, but they sounded a little rolled off. Finally, I installed .22uf @ 600V Illinois Capacitor ICMWR metallized polyester caps. These took a while to break in, but worked fine. For resistors, I used the old reliable Allen-Bradley two watt carbon comps. The A-Bs have a smoother, more relaxed sound when compared to some of the new metal film types.

The power supply was built on a separate chassis and connected to the amp chassis via an umbilical cord and Jones plugs. However, if you can't find Jones plugs and sockets, you can hard-wire the power supply to the amp chassis. I used a two-chassis design to keep the size and weight of the chassis down and to improve longevity of components. The supply design has two pi networks and employs triple capacitance filtering using surplus oil-filled can-type capacitors. With triode amplifiers, oil capacitors give that deep, effortless and liquid sound characteristic.

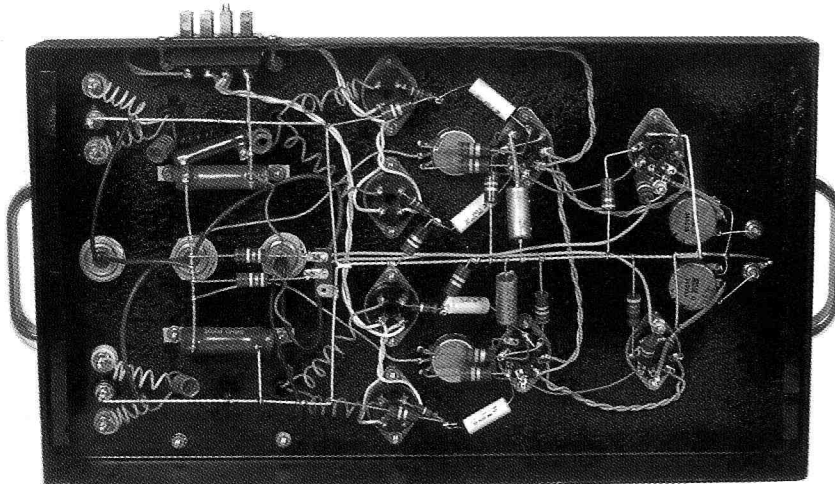

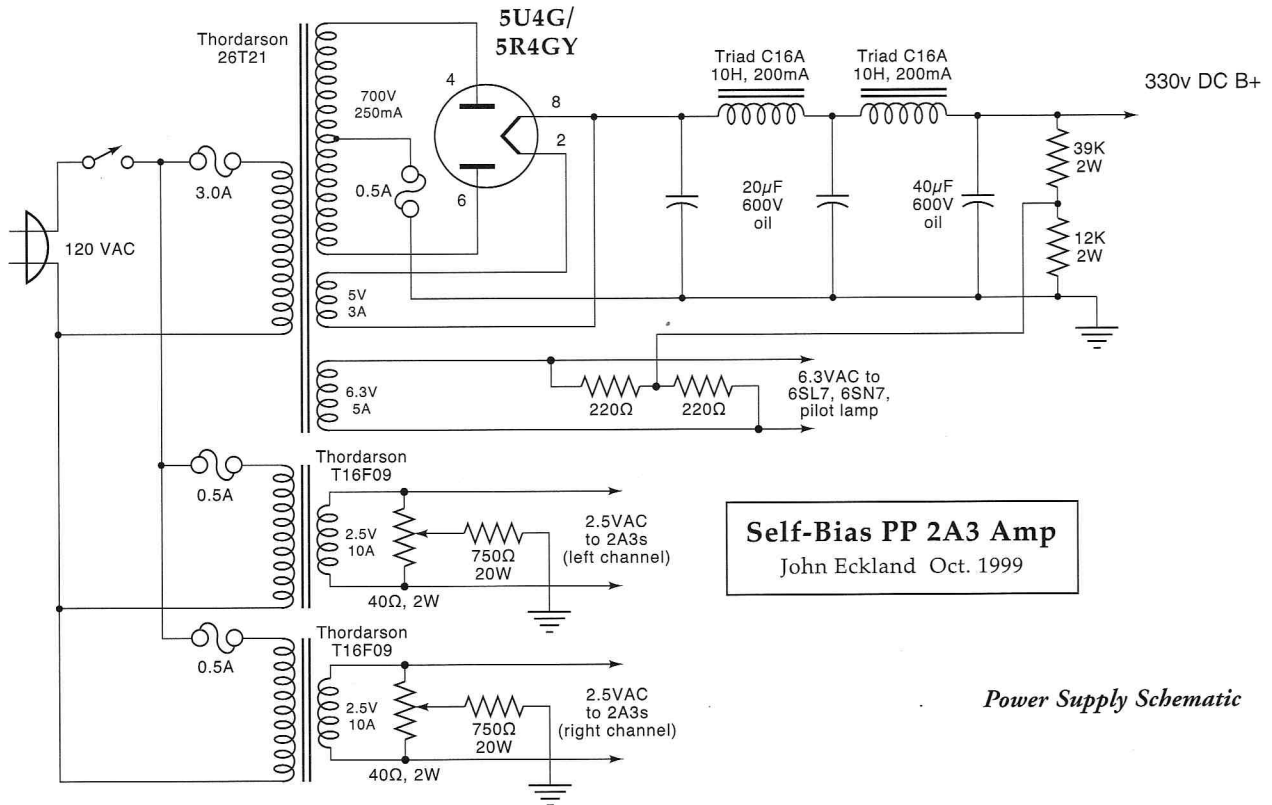

Self-Bias PP 2A3 Amp
John Eckland Oct. 1999

Power Supply Schematic

If you cannot find oil-filled power supply caps in the specified values, you can use either film and foil or high-quality electrolytics and bridge them with a smaller value tubular oil capacitor, like a .47uf @ 600V. There is also a dual filament supply, one for each channel of the amplifier. This is important, to allow output stages to operate independently.

Since older, vintage UTC and Peerless output transformers are getting hard to find, we contacted Mike LaFevre of Magnequest Transformers in Philadelphia, Pennsylvania (www.magnequest.com). Mike purchased the original Peerless transformer name with their transformer designs several years ago and is in the process of reintroducing several of the "classic" Peerless output transformers. After consulting with Mike, he suggested we try his reissue of the Peerless S-542 that was initially introduced back in 1950.

The new S-542 (\$149 each) is made with M-6 grain-oriented silicon-steel laminations and has a 5Kohm primary with a maximum power rating of 40 watts. However, Mike said he would probably rate it at about 25 to 30 watts for best results. The Peerless S-542 has a current rating of 140 mA per side (14 mA unbalanced) and a frequency response of 20 to 30kHz + or - one dB. It appeared to be a

well-made transformer, perfectly suited for this application. In this amplifier, the S-542 transformers were run in self-biased mode for simplicity and sonics. In self-bias, it is important to find 2A3s that are fairly closely matched (within 10% in gm). Measured output power is about eight watts RMS per side that should be sufficient for a lot of speakers.

How Does it Sound?

After about 40 hours of break-in, the amp really started to smooth out. The Peerless/Magnequest output transformers really began to perform well the longer we used the amp. I used either NOS Sylvania or RCA bi-plate 2A3s. 1940s RCA "black plate" 2A3s were the most musical. If you have a lot of money, the single-plate 2A3 would probably be the best-sounding. The new Sovtek mono-plate 2A3s are also an excellent choice for this amplifier. RCA and Sylvania 6SN7GTs and 6SL7GTs from the 1940s seem to have better imaging and are more musical than 1960 through 1986 vintage consumer or JAN bottles.

As with any tube amp circuit, modifications and potential improvements can be made. I tried using a 6SN7GT in place of the 6SL7GT in the first stage and noted the sound to be noticeably smoother. However, power output was definitely reduced due to the lower ampli-

fication of the 6SN7GT. You can also try reducing the resistance value of the plate resistor in the first triode stage for higher plate voltage. This will give you more gain if you decide to use a 6SN7 for the first stage tube.

We tried the amplifier with vintage JBL Hartsfields, 1980's vintage Klipschorns, B & W DM-110s, Von Schweikert 4.0s and 1980's Klipsch Chorus Is. The amp has a sweet and balanced sound with adequate bass. Sonics are different than an SE 2A3 amp, but are just as desirable. With eight watts of power, you can drive a lot more speakers than with just two to three watts. The amp has a smooth, easy-to-listen-to sound that you can enjoy all day long with no listener fatigue. As with any DIY project, sonic performance will vary with the skill of the builder, the quality of the components used, and the ability of the builder to "tune" the amp for best performance in the system.

John Eckland is a tube audio specialist residing in Palo Alto, California (650)-323-0101. He repairs and restores classic radios, jukeboxes, and vintage hi-fi equipment. He built his first tube amp using 6B4 triodes in 1966 when he was in the eighth grade. Since then, John has built several single-ended and push-pull amplifiers using 2A3s, 300Bs, 6L6s and 211s.

Problems with Modern Consumer Electronics

By Eric Barbour ©2000 All Rights Reserved

We live in strange times for consumer audio electronics. The world is filled with ever-increasing mountains of black plastic electronic mulch, all made in Asian countries by the daughters of impoverished rice farmers, for wages that would be considered slavery in Europe or North America. Yet consumers, especially Americans, grow ever fonder and more addicted to this cheap and disposable electronic trash.

Flat Black Racks

Go into any consumer electronics emporium, and you are confronted with rows of ugly "mini-rack" systems. The current incarnation usually features garish color vacuum-fluorescent displays, flashing in time with the music (and serving no useful purpose whatsoever, except to make the weak-minded think they are getting a quality audio product). The tendency to make these vile things look like cartoon robots has become overwhelming; you are hard-pressed to find one that looks "restrained." The "Megatroid Of Doom" appearance, which appeals to the 14-year-old male mind, is universal.

We've been told that these gadgets are usually designed by the junior members of manufacturer's design teams, and always to a specific price point. Rarely does a higher price equate to better sound. More likely, a costly rack system will simply have more semi-useless programming features and more buttons than the bottom-line model. The circuits are universally based on horribly sleazy ten-cent op-amps, such as the venerable 1458, and on power amplifiers based around ICs which cost less than \$2 apiece in OEM quantities. Their circuits are direct steals from 1968 designs, and they depend on 100+ dB of negative feedback to obtain tolerable distortion figures, low hum and low noise (since their power supplies are usually inadequately filtered). Most won't even drive four ohm speaker loads!

Bad as the electronics in modern audio gear might be, the speakers included in these all-in-one packages are made even more cheaply. We have literally seen "stereo system" speakers whose cabinets were partly made of corrugated cardboard. The drivers commonly have abominable frequency response, are assembled on paper-thin stamped metal baskets, and are

incapable of handling more than 25 watts of RMS power. The crossover usually consists entirely of a single cheap electrolytic capacitor in series with the tiny 50-cent tweeter. The sound is uniform among all such products: tizzy, harsh, metallic, with massive bass distortion and non-existent stereo imaging. This is the norm at the end of the millennium, and this is what an entire generation (and soon, two generations) of Americans have grown up listening to. It is all they have ever known of "high fidelity."

Politically Incorrect Electronics

Once these black boxes break (and they do break, in spite of the "infinite lifetime" of semiconductors), they end up dumped in landfills, leaching toxic heavy metals and plastic residues into water supplies. Because they are made as cheaply as possible, they are not designed to be easily dismantled for recycling. Indeed, a move is afoot in Europe to outlaw the use of lead in electronic solder, and to force manufacturers to make electronics so they are easily disassembled for recycling. Nor would this matter much--the manufacturers are huge corporations, eager to force con-

sumers to buy new toys as frequently as possible. So, rarely are such products supported more than five years after their introduction. Sorry, parts and service data no longer available.

Compare this to a typical tube amplifier. Not only is it easy to repair, the parts to fix it will always be available (at least in some kind of substitution form). Tubes and output transformers are still being made, unlike many integrated circuits of the last 20 years. If a tube goes bad, the user can just pop in a replacement. And if such an amplifier finally gives up the ghost, it is worth dismantling for recycling, because it will contain very little ABS or polystyrene plastic. Tubes tend to force good construction techniques, requiring lots of recyclable iron, copper and aluminum.

Digital Deception

Even more controversial is the current push toward digital in the professional recording studio, especially this fad for "lossy compression" digital audio systems. Fools with magazine columns are currently spreading corporate propaganda that MP3 sounds as good as CDs and will transform the music industry. They claim that MP3 will wipe out all older recording formats by allowing consumers to download music from web sites at very low cost, and with little or no advertising or promotion. Most of this blathering is seen in computer magazines and in Internet-



This is what we know so far. He's a solid state stereo equipment salesman, and it appears he was shot with a 45!

related business publications. Yet we have seen many respected experts in the professional recording field who are VERY disgruntled with this state of affairs.

For example, John Sabatello, a well-known recording engineer in Hollywood, has actually done listening comparisons of MP3 versus high-rate PCM audio, and he bluntly states "It's just a marketing ploy--most consumers don't care. It's great for kids, but it's not a quality format." Sabatello has similar feelings about Sony Mini-Disks, which use a compression scheme comparable to MP3. He even finds the current industry standard for conventional PCM audio, 16 bits at 44.1 kHz, to be inadequate. "I'm not anti-digital, but they will have to improve the sample rate."

Stephen St. Croix, the well-known columnist for MIX magazine, made similar comments in his January 1999 column. "Lossy data compression is, in my opinion, not great at all and should not be used. Take ten seconds of music, shove it through your fave lossy digital data reduction unit, save the result and repeat the cycle several times. That'll teach ya. Copies of copies using data reduction are garbage." He even finds conventional digital recording to have major disadvantages compared to analog formats, especially for archival storage: "The only truly safe

archival storage today is non-mag optical. A tiny ding in a (digital) disk can mean you spend the next day calling all the original musicians back in, and the day after that, consulting with your lawyers."

St. Croix claims that DAT digital tape machines, always Asian-made and widely used by pro and semi-pro recordists, have similar problems, especially when data dropouts occur: "DAT machines reconstruct your music using interpolation (they take a guess), without notifying you, whenever they feel the need. And why do we care? Because they feel the need quite often!" Engineer Otho Wilburn made these comments: "The analog (tape) has always been far superior to the DAT. My Nakamichi 1000 cassette deck sounds far superior to the DAT. It would bring such joy to my heart, to take the DAT machine into the parking lot, and take a sledgehammer to it."

Home Theater Hypnosis

Currently, high-end audio is losing some ground in media reporting to the maniacal religion called "home theater." Companies have popped up all over the world, who (for a very large fee) will turn an extra room in your house into a miniature video cinema, complete with uncomfortable folding seats and a popcorn machine. The mandatory audio equip-

ment for this kind of setup is always the modern "surround" system, using a matrix-encoded source similar to the old SQ and QS quadraphonic systems, or else a lossy digital compression scheme. The decoders and power amps invariably are designed to a price point and according to strict technical standards which have little relationship to actual human hearing response. Massive subwoofers are mandatory, the better to pound the listener into unconsciousness with explosions, gunshots and loud grunts from your

favorite muscle-bound action star.

Lynn Olson, currently editor of V&T News and a former designer of surround electronics, says in V&T's August 1999 issue: "One of the most disappointing things about contemporary surround sound is the paper-thin image--it wraps around you all right, but the effect is like being surrounded by posters hung on a clothesline. The low-level reflections are scrambled by digital compression or assorted solid-state gremlins (Class AB, slewing, or momentary loss of phase margin), the depth and you-are-there realism is sucked out of the recording, and no amount of synthetic signal processing can restore it." Olson even shows a diagram for an all-vacuum-tube surround decoder in this article.

Bogus Broadcasting

As for radio broadcasting, large corporations now own most of the radio stations in the United States, thanks to the current FCC tolerance of monopolistic behavior. These firms have dictated the programming formats, so that the same tunes are played over and over, usually "oldies." It's a safe, closed system, arrived at over many years to insure consistent advertising profits.

The current frantic push for digital TV and digital radio broadcasting is even more specious. Consumers do not see the justification for paying \$5000 for a digital TV set, while the broadcasters and cable-TV systems frantically try to assemble digital systems, as mandated by the FCC. We understand that less than 50,000 digital TVs have been sold in the United States, versus a current estimated analog-TV population of 200+ million. A similar situation obtains for digital radio--the digital data format has not even been fully decided yet. Yet the FCC mandate (and the bizarre ravings of a few industry pundits about the glory and inevitability of digital broadcasting) continues to press toward all-digital TV in 2006, followed by the requirement that the stations turn their old analog frequencies back to the FCC for auction to the highest bidder. (Major reasons for all this: the Clinton administration has apparently claimed to have balanced the federal budget, primarily by assuming the auctioning of valuable VHF and UHF TV channels in the future.) Of course, manufacturers would be so happy if all consumers were forced to buy new TV sets and radios. Our advice: keep your analog TV set and analog FM tuner. The changeover won't be on time, if it ever happens at all!

Ultra-Tone Caps

Laser-Etched Silver Foil in Kraft Paper and Oil
Amplifier and Crossover Capacitors

"The most lifelike capacitors I have ever heard!"

"Music steps forward from the speakers. Excellent pacing and rhythm."

Perfect for Single-Ended Triode Amplifiers and Horn Speakers

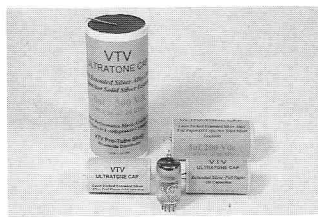

650V Silver Coupling Caps

0.01uf	\$13.20 ea
0.02uf	\$15.40 ea
0.05uf	\$17.60 ea
0.1uf	\$20.90 ea
0.22uf	\$30.80 ea
0.47uf	\$44.00 ea
1.0uf	\$70.00 ea
2.0uf	\$100.00 ea

NEW 300V Crossover Caps!

Solid Silver Leadouts!

1uf@200V	\$45 ea
2uf@200V	\$70 ea
3uf@300V	\$95 ea
5uf@300V	\$135 ea
10uf@300V	\$175 ea

VTV Pro-Tube Shop

P.O. Box 1499, Lakeport, CA 95453 USA
(707) 263-5881 - (707) 263-7648 FAX

Scott 222 & LK48 Amps

Sweet Sound for a Song

By Charles Kittleson ©2000 All Rights Reserved

With the mass marketing of stereo records in the late 1950s, most hi-fi equipment manufacturers struggled to get cost-effective stereo equipment to consumers. Many music enthusiasts were reluctant to change to stereo and decided to stay with mono for the time being. From the mid-fifties, mid-fi companies like EICO, Fisher, Harman-Kardon, Heathkit, Knight, Pilot, Scott, Sherwood and Stromberg-Carlson were producing audio equipment for the low to middle-end of the market. As a result, their challenge was to produce a competitively priced stereo integrated amplifier to get the most unit sales.

In the early part of 1958, H. H. Scott introduced a series of stereo integrated amplifiers that would impact the world of hi-fi stereo for some time. Their first stereo integrated amplifier was the 299 (\$199.95), a 40 watt tube stereo amplifier using 7189 output tubes. (Note: The model 299 Scott amplifier is described in more detail in VTV issue #12 pages 19-23). For the budget-minded music listener, Scott introduced the model 222 (\$139.95) a few weeks later. These two amplifiers became very popular and were highly rated by audio and consumer magazines of that era.

We will examine the development of the Scott 222 amplifier series and the related LK-48 kit amplifiers in this article. These amplifiers represent an important

used push-pull EL84/6BQ5s in the output stage that produced 12 watts RMS per channel with 0.8% distortion at rated output. The EL84s were in self-biased

Scott 222B Front Panel

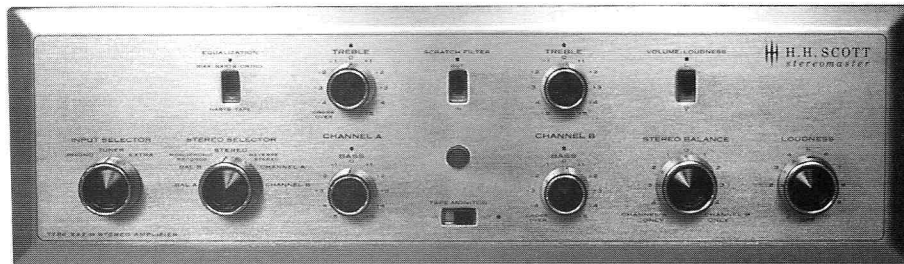

operation with 360 volts on the plates in conventional pentode mode with the screens running at full plate potential. Front-end tubes consisted of four-ECC83/12AX7s with their filaments string-wired in series. Voltage for the front-end tube filaments was derived from the 60 volt cathode potential of the output tubes. The driver/phase inverter tubes were ECF80/6BL8s and the rectifier was a GZ34/5AR4. No adjustable bias or DC balance controls were included on the 222; only AC balance adjustment pots were on board.

Other features included two low-level inputs and two high-level inputs from stereo sources. There were also stereo outputs for a tape recorder and provisions for

Scott 222 Front Panel



part of hi-fi history and are a bargain for those who want sweet sound for a song!

Scott 222

The 222 was a complete two-channel stereo integrated control center consisting of two complete amplifiers on a single chassis with a shared power supply. It

4, 8, and 16 ohm output for both speakers. The front panel was aluminum anodized in a "champagne gold" finish with polished brown Bakelite knobs and gold colored edges. Front panel controls included volume, balance, dual bass, dual treble, function, source, loudness, tape monitor and high filter.

One of the unique features, of the 222 and of other Scott integrated amps, was the third or middle channel. This extra output was used in conjunction with an auxiliary amplifier for fuller sound, wider soundstage, lack of "hole in the middle" effect when speakers were further apart. It can also be used as an output for a mono amplifier extension speaker output. All Scott amplifiers incorporated a low frequency rolloff that became operational below 20 cycles. This circuit was designed to prevent overload of the out-

put stage and speaker from subsonic rumble frequencies, from accidental dropping of the tone arm, or from record irregularities.

Scott 222B

For the 1959 model year, Scott introduced the 222B in December of 1958. The tube complement was the same, but power was increased slightly to 13 watts RMS per channel with harmonic distortion of 0.8% at rated output.

The faceplate was changed slightly with a tape monitor slide switch that was added in the center of the panel. The output transformers had a slightly larger stack and were labeled TRA-7-1. Interestingly, the output transformers had an EIA code of 100, indicating that they were either made in-house, or by a vendor Scott did not want their competitors to know about. The power transformer was labeled TR-12-7 and appeared to be similar to the original 222. The EL84 screen grids were no longer tied to the plate supply and were decoupled with an additional filter capacitor with a slightly lower voltage potential.

Scott 222C

For the 1962 product year, Scott launched the 222C, rated at 20 watts RMS at 1000 Hz. At typical listening levels of one to two watts, total harmonic distortion was said to be in the range of 0.05%. Improvements included huge output transformers (TRA-8-5-1) that were sourced from Stancor (EIA code 352). The larger transformers were more than twice the size of any comparable

Scott 222 B Chassis

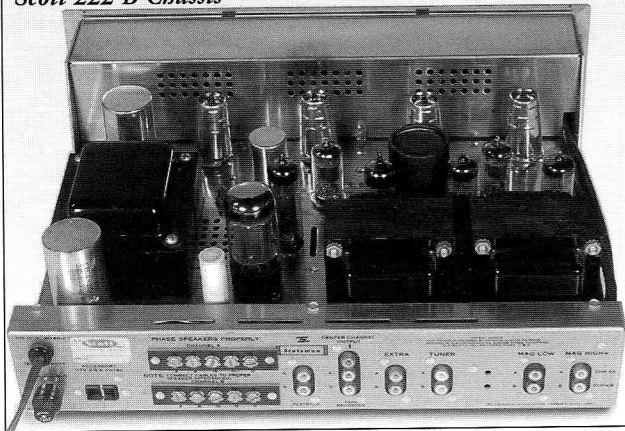

iEL84/7189 amps and were boasted about in Scott advertising. Another change was to some higher rated 7189 output tubes, operated in fixed bias mode with only a pair of DC balance pots for adjustment of the output stage. The plate voltage on the output tubes was increased to 420 volts with 345 on the screen grids. Early models of the 222C used a 6GH8 (triode-pentode) inverter/driver tube, but eventually it was changed to the 7199. Scott boasted in its advertising that the amplifier was operated at less than 75% of its component ratings. Another change was a front-panel headphone jack on the 222C.

The result was a more powerful amplifier with better bass response that could be used with less efficient speakers. Published Scott specs indicated that the 222C power band was 19 to 25,000 Hz + or - 1 dB. Feedback-type tone controls were quite effective with a treble boost and cut of + or - 15dB at 10kHz and bass boost and cut of + or - 15dB at 50 Hz.

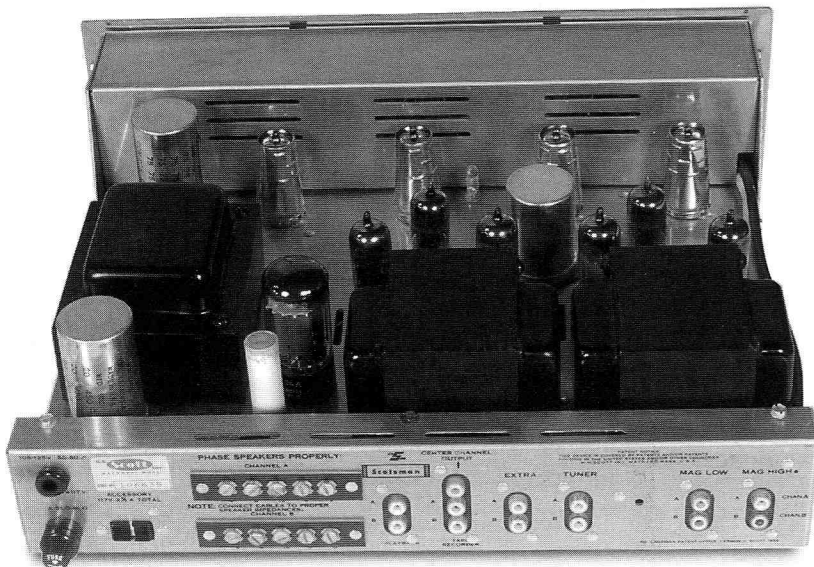

Scott 222C Chassis

Scott 222D

For its 1963 line, Scott hired an outside design firm to "spruce up" their integrated amplifiers. As a result, a new faceplate, control knobs and chassis layout were incorporated. The faceplate was cast aluminum with polished edges and an aluminum control panel which now included a headphone jack. Knobs were cast plastic with glue-on metal caps. Six slide switches were installed on the top of the front panel for

phono equalization, tape monitor, scratch filter, speaker on-off, power on-off and loudness. The output transformers were the same type as the 222C but relocated further towards the front of the chassis. The output tubes were mounted in the back of the chassis, behind the transformers, for



Scott 222 C Front Panel

better ventilation and cooling. The 6BL8/6U8 driver/phase inverter tubes were mounted near the front of the chassis.

Minor circuit changes were made to the

222D, including better bias adjustment facilities. There were variable controls for each channel's bias and DC balance, a pair of bias test point jacks and a bias adjustment switch for improved fine-tuning of the amp.

LK-48

Scott launched the LK-48 Scott Kit in 1961 for the growing hi-fi kit market. Peak power rating for each channel was 24 watts at 1000 Hz and 20 watts continuous, slightly higher than the 222C. Apparently, Scott spent a lot of money developing its kits and the profit margin was lower than with comparable assembled units. The kit assembly manuals were excellent, with complete instructions, lots of drawings and multi-color wiring charts. Everything came packaged in a well-thought-out container that included all the necessary parts.

The LK-48 was basically a kit version of the 222C with the following cosmetic dif-

ferences: 1. A dark brown faceplate was standard with a champagne gold faceplate as an option, 2. All the slide switches were on the top half of the chassis and the control knobs were located on the bottom of the chassis with the bass and treble controls in a concentric configuration. There were some relatively minor circuit changes as well. Both the power and the output transformers appear to be the same types as the 222C and 222D.

Scott kits were very popular, including the LK-48, the matching LT-10 mono FM tuner kit and later the LT-110 stereo FM tuner kit. Tens of thousands of these units were sold to do-it-yourself audio enthusiasts of the day. LK-48s are still around and have been passed on from father to son. Lots of good tunes have been played through these amps, and with proper restoration and service, many more can be played.

LK-48B

From 1963 through about 1965, Scott sold the LK-48B, which was a kit version of the Scott 222D with the updated cosmetics, different chassis layout and other

minor differences. The output and power transformers were similar to the Scott 222C parts.

200, 200B and LK-30

In 1962, for beginning and budget audiophiles, Scott made the model 200 stereo integrated amplifier which produced about 10 watts per channel. Priced at about \$139, the 200 offered many of the features of the more expensive Scott integrated amplifiers. The faceplate was the familiar champagne gold with the gold-ringed plastic knobs. However, it did not have a stereo balance control. Tubes in the 200 included three ECC83/12AX7s for the phono, tone and first audio circuits, four ECL82/6BM8s (a combination 9-pin pentode driven by a small hi-mu triode, similar to 1/2 of a 5751) and a 5AR4 rectifier. A kit version of the 200 was the LK-30, also introduced in 1962. The 200B model was introduced in 1963 and made through 1965 or 1966. It was basically the same as the 200 except for cosmetic changes and minor circuit upgrades.

Production Estimates and Values

Daniel von Recklinghausen, VP of engineering for H. H. Scott, estimated that 60,000+ units of all versions of 200s, 222s and LK-30s and LK-48s were produced from 1958 through 1965. The 222Cs and LK-48 are the most common and seem to be easiest to find. The scarcer models seem to be the first version 222s, 222Ds, LK-48Bs and LK-30s.

As with every collectible, condition is everything. Finding a 222 or LK-48 in mint condition is becoming less common these days. With internet auction sites like ebay and others, more people have more exposure and access to collectible tube audio equipment than ever before. Unfortunately, prices tend to rise with demand. For many years, audio collectors couldn't care less about anything that used

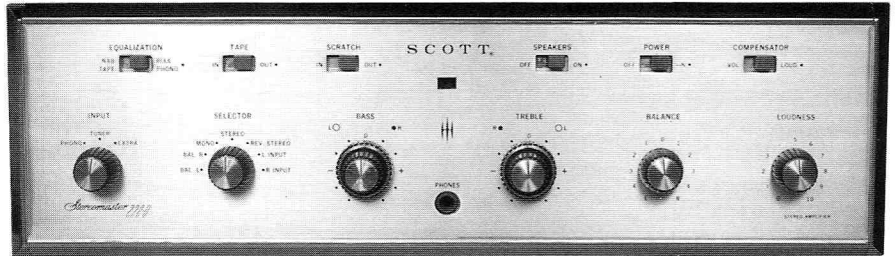

Scott 222D Front Panel



Scott LK-48 Front Panel

EL84s. Now, with many new enthusiasts becoming interested in tube audio and 7591s costing more than complete amplifiers, there is renewed interest in the EL84 and Scott 222 series amps. You can expect to pay anywhere from \$10 (at a garage sale) for a rough 222 to \$400-500 for an excellent, fully rebuilt and restored 222C.

Restoring a Scott 222

Never power-up a vintage amp without inspecting and testing it. It is important to obtain a schematic diagram to determine component values, correct wiring and voltage points. Begin with inspection of the unit for any missing parts, shorts, burn marks, burnt smell, etc. Repair as needed or have your technician do the work. The tubes should be removed and tested. Most Scott amplifiers have a tube location sticker on the bottom plate. Tube sockets should be re-tensioned with a dentist's pick and then cleaned and protected with Deoxit R-5 spray. R-5 should

also be used to clean and condition slide switches and volume controls. The chassis should be dusted or wiped clean with a soft cloth. Since Scott chassis are aluminum and are typically not lettered, they can be polished for a mirror-like finish using Simichrome metal polish.

For reliable operation and best sound, your Scott 222 should be electrically restored. All of the white tubular ceramic American Radionics capacitors should be replaced with a good quality, modern film capacitor. Any under-chassis axial electrolytics should be replaced with new, modern electrolytics. Above-chassis can-type multi-section electrolytics should be checked for leakage and if possible, be re-formed slowly using a regulated, variable DC power supply. If capacitor cans cannot be re-formed so leakage current is 5mA or less at rated voltage, they should be replaced.

The flat Siemens selenium bridge rectifier should be replaced with a modern silicon bridge rectifier. In addition, plate resistors in the phono section can be changed to modern low-noise carbon film or metal oxide film for quieter operation. The small screw speaker terminals can be replaced by modern Cardas gold or copper speaker terminals that fit in the rectangular hole. If time and care are taken in the restoration process, your Scott 222 will be a reliable performer for years to come.

What Do They Sound Like?

EL84s/6BQ5s have become the tube of choice for many enthusiasts, because of their sweet sound, quick dynamics and surprisingly musical presentation. For more detailed information on the EL84/6BQ5 tubes, see VTV issue #8 pages 3 through 7. The Scott 222 is musical, sweet, and lively sounding, probably due to smaller output transformers that have a quicker sound. Overall performance is balanced, but they can be bass-shy with inefficient speakers. The

Scott 222D Chassis

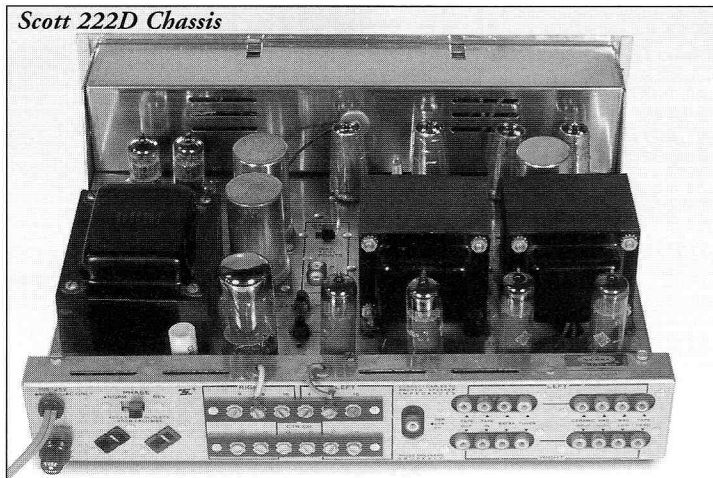

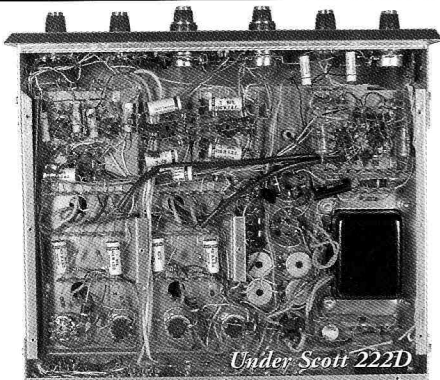

222B is similar sounding to the 222, but has slightly more power and a little better bass response. The 222C has deeper bass response, but the mids and highs do not seem as lively as the earlier models. Some feel that the larger transformers have a bass emphasis at the expense of the mids. Model 200s and LK-30s are also sweet-sounding, but have limited power and are not very punchy.

Generally speaking, Scott integrated amplifiers tended to have better midrange and in-the-room presence when compared to similar type Fisher integrated amplifiers. Some enthusiasts think that Fisher integrated amplifiers can sound more recessive due to Fisher's use of a voltage doubler for B+ voltage with a solid-state bridge rectifier. By comparison, the Scott 222 and 299 series used a tube rectifier without a voltage doubler. Note, however, that Fisher did use a tube rectifier on its earlier X-100, X-101 and X-202 integrated amplifiers and these models can sound excellent.

Since Scott 222s produce at least 10 watts RMS, they can be used with anything from a Klipschorn to a Bozak B-4000 or most modern bookshelf speakers with 91dB/one watt/meter efficiency. Some contemporary bookshelf speakers to consider would be Celestion A-1s, Paradigm Titans, and NHT Super Ones.

References:

1. *Audio Magazine, Scott 299 and 222 Amplifier Review and Test, November 1959.*

2. H. H. Scott Company, catalogs, schematics and service manuals from 1959 through 1965.

Special thanks to: Daniel von Recklinghausen, John Eckland of Palo Alto, Lance Cochrane of San Francisco and Rodger Coon of Redwood City for their assistance with this article.

New H.H. Scott Stereo Amplifier has features never before offered at \$139.⁹⁵*

The new H.H. Scott 24 watt stereophonic amplifier, Model 222, puts top quality within the reach of all. This new amplifier has many features never before available for less than \$200. It is backed by H.H. Scott's fine reputation. Check the features below and you'll see why you should build your new stereo system around the H.H. Scott Model 222.

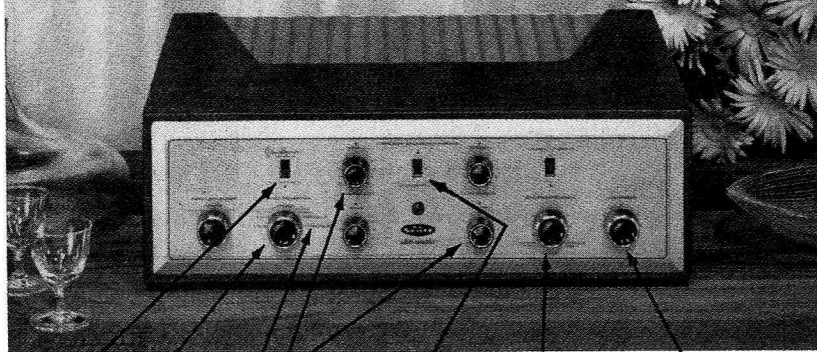

Equalization switch lets you choose between RIAA compensation for monophonic and stereo records; NARTB, for tape heads.

Special switch positions for accurate balancing, for playing stereo, reverse stereo and for using monophonic records with your stereo pickup.

Separate Bass and Treble controls on each channel let you adjust for differences in room acoustics and different speaker systems.

This position lets you play a monophonic source such as an FM tuner or a tape recorder through both power stages and speakers.

Effective scratch filter improves performance on older worn records and improves reception on noisy radio broadcasts.

Exclusive center-channel output lets you use your present amplifier for 3-channel stereo or for driving extension speakers. Separate stereo tape-recorder outputs.

Channel balance control adjusts for different speaker efficiencies and brings channel volumes into balance quickly and easily.

Master volume control adjusts volume of both channels simultaneously. Also functions as automatic loudness control whenever desired.

SPECIFICATIONS: Dual 12 watt channels; 0.3% IM distortion; 0.8% harmonic distortion; frequency response 20 to 30,000 cps; extremely low hum level (-80db); DC operated preamplifier heaters; Inputs for stereo or monophonic recorders, tuners, phono cartridges and tape heads. Phono sensitivity 3 mv. Sub-sonic rumble filter prevents overload from noisy changers or turntables. Price \$139.95*

H.H. SCOTT INC. Dept. A-7, 111 Powdermill Road, Maynard, Mass. Export: Telesco International Corp., 36 W. 40th St., N.Y.C.

Insist on genuine H. H. Scott components.

*West of Rockies \$149.95. Accessory case extra.



SEND NOW FOR
FREE HI-FI GUIDE
AND CATALOG



Rush me complete details on your new Model 222 and your complete 1959 Hi Fi Guide and Catalog. Dept. A-7

Name _____
Address _____
City _____ State _____

1959 Scott Advertisement

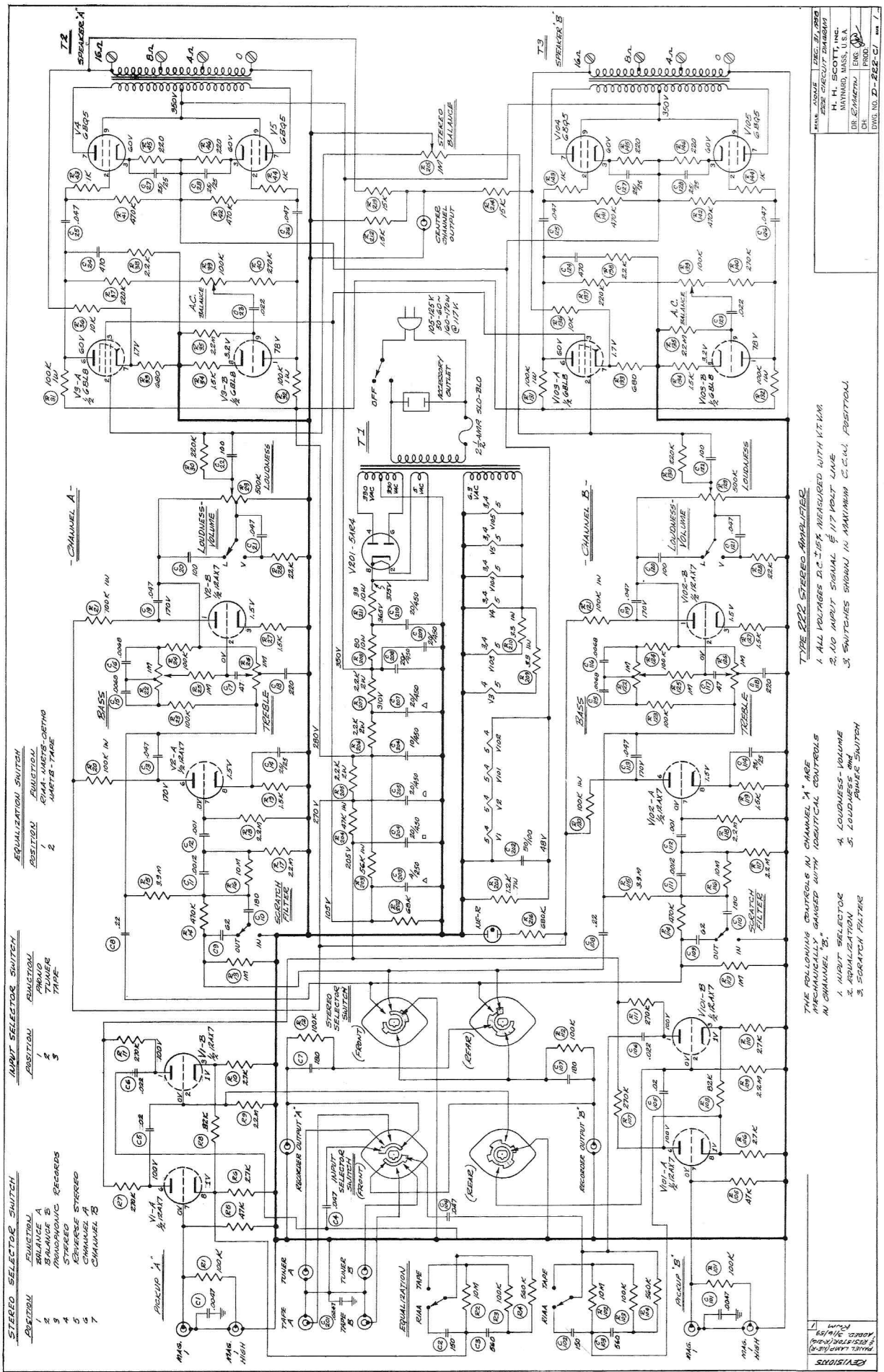

TYPE 222 STEREO AMPLIFIER

1. ALL VOLTAGES D.C. EXCEPT WHERE SHOWN OTHERWISE
2. 100 INPUT SIGNAL \pm 117 RMS VOLT LINE
3. SWITCHES SHOWN IN MAXIMUM GAIN POSITION

THE FOLLOWING CONTROLS IN CHANNEL "A" ARE MECHANICALLY GANGED WITH IDENTICAL CONTROLS IN CHANNEL "B"

1. INPUT SELECTOR
2. EQUALIZATION
3. SCRATCH FILTER
4. LOUDNESS-VOLUME
5. SCRATCH FILTER

REVISIONS

1	REVISED
2	REVISED
3	REVISED
4	REVISED
5	REVISED
6	REVISED
7	REVISED
8	REVISED
9	REVISED
10	REVISED
11	REVISED
12	REVISED
13	REVISED
14	REVISED
15	REVISED
16	REVISED
17	REVISED
18	REVISED
19	REVISED
20	REVISED
21	REVISED
22	REVISED
23	REVISED
24	REVISED
25	REVISED
26	REVISED
27	REVISED
28	REVISED
29	REVISED
30	REVISED
31	REVISED
32	REVISED
33	REVISED
34	REVISED
35	REVISED
36	REVISED
37	REVISED
38	REVISED
39	REVISED
40	REVISED
41	REVISED
42	REVISED
43	REVISED
44	REVISED
45	REVISED
46	REVISED
47	REVISED
48	REVISED
49	REVISED
50	REVISED
51	REVISED
52	REVISED
53	REVISED
54	REVISED
55	REVISED
56	REVISED
57	REVISED
58	REVISED
59	REVISED
60	REVISED
61	REVISED
62	REVISED
63	REVISED
64	REVISED
65	REVISED
66	REVISED
67	REVISED
68	REVISED
69	REVISED
70	REVISED
71	REVISED
72	REVISED
73	REVISED
74	REVISED
75	REVISED
76	REVISED
77	REVISED
78	REVISED
79	REVISED
80	REVISED
81	REVISED
82	REVISED
83	REVISED
84	REVISED
85	REVISED
86	REVISED
87	REVISED
88	REVISED
89	REVISED
90	REVISED
91	REVISED
92	REVISED
93	REVISED
94	REVISED
95	REVISED
96	REVISED
97	REVISED
98	REVISED
99	REVISED
100	REVISED

Computing with Tubes

The Savage Art

By Eric Barbour ©2000 All Rights Reserved

6. Uncle Sam's Monster

During the construction of Whirlwind (the first realtime computer - see VTV issue #11, p. 20), two major turning points occurred. First, the Soviets exploded their own nuclear bomb in 1949. Second, the U.S. Army conducted a test of their civilian Ground Observer Corps. This all-volunteer group had the responsibility of filling in for early coastal radar systems by watching for invading aircraft. Unfortunately, the Corps proved to be completely unreliable--Cold War jitters and Communist "witch hunts" had so inflamed the public that the Corps volunteers kept seeing Soviet bombers behind every cloud.

Thousands of false alarms were turned in. (At the time, the USSR didn't even have a bomber capable of reaching the

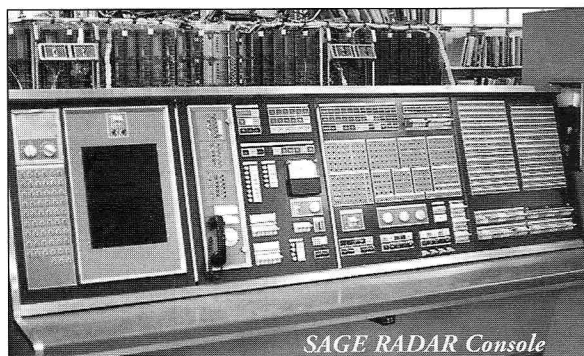

SAGE RADAR Console

United States.) The result was political turmoil, and Congressional demands for a reliable air-defense system.

The Air Force, given responsibility for developing an aircraft tracking system, resisted at first. It knew what a massive expenditure of money this would require and that whole new technologies would be needed. Still, in October 1950, the Air Defense System Engineering Committee recommended development of a computerized air-defense system. It went to MIT for the knowhow, and some of the Whirlwind team (minus Forrester, who went on to academic work) came on board.

A test of Whirlwind on April 20, 1951, was a success--the computer was able to track two aircraft accurately enough to allow a ground operator to direct one aircraft to intercept the other. By this time,

MIT's Digital Computer Laboratory had been taken over by the Air Force, becoming the core of MIT's new research center, Lincoln Laboratory.

The team developed a new machine called Whirlwind II. It acted as the prototype for the final system. Twenty-three "air defense sectors" were created, and each one was to get a Direction Center containing a dual-redundant version of Whirlwind II. This was SAGE--SemiAutomatic Ground Environment (the presence of Nat Sage on the senior staff may have influenced the name selection). It was the first digital computer to receive an official US defense-procurement designation, AN/FSQ-7. IBM was selected as the primary contractor, and the company benefited greatly from the technologies it got from SAGE.

By 1955, IBM had the first prototype working in Poughkeepsie, NY. It was a 32-bit parallel-bus processor, with the CPU and core memory duplicated, while the I/O systems and drum memories were common to both CPUs. Switchover could be accomplished almost instantly. Data came in on very slow data links from complex radar installations via landlines and HF radio channels. Each channel was dual-redundant, with automatic failure switching, and all were made of vacuum tubes. (Some transistorized equipment was introduced late in the project. Even so, most of the SAGE installations were 80% tube until they were finally shut down more than 15 years later.)

Indeed, each SAGE main computer contained 55,000 tubes in seventy rows of racked modules. Tubes used included the 7AK7, developed for Whirlwind, plus a mishmash of "super-premium" types, with octal, loktal and miniature basing. Lots of 6888 and 6889 pentodes, plus germanium diodes, were used for logic, and the core-memory drivers were 6080 or 7236 dual power triodes. 5692s were used as the flip-flops in the main system registers. Apparently, SAGE may have been the largest consumer of 5692s. Each accumulator contained a "split" 32-bit number, to serve as X and Y coordinates in the radar-

constructed map that made up each air sector. All of the coding was in assembly language.

All this drove 50 CRT realtime monitors, each having a light pen like the one attached to Whirlwind, used by the intercept technician to specify a target for tracking and interception. Each SAGE could track up to 400 aircraft at a time. These displays took one second to update, using very long-persistence phosphor to allow reading the slowly-repainted screens of data. Each main core module was 69k words in size, while the common drum memory held 150k bytes. Each SAGE was housed, along with its own independent 1-megawatt diesel power plant, in an ugly windowless concrete blockhouse four stories high.

The first operational system went into service July 1958, at McGuire AFB in New Jersey. Eventually, 26 systems were built, adding up to 56 CPUs (including four systems for software development). (Side note: it's ironic that the anti-Communist panic that started this huge project had run its course by the time the system went into operation, 8 years later.)

The SAGES proved to be extraordinarily reliable. A downtime average of less than 10 hours per year was typical, for a record of better than 99.9%. Those who claim tube computers were unreliable can mull over that statistic for a while!

In spite of rapidly advancing computer technology, most SAGES were not taken offline until 1972-76. The final SAGE in operation in the U.S. apparently was at Luke AFB in Arizona, believed to be shut down in 1977. The only one not in the USA, at North Bay, Ontario, finally was dismantled in 1982. Together, the SAGE installations constituted the physically largest, most complex computer system the world has ever seen.

References:

1. **Project Whirlwind: The History of A Pioneer Computer**, Kent C. Redmond and Thomas M. Smith, Digital Equipment Corp. Press, 1980.
2. **Bit by Bit: An Illustrated History of Computers**, Stan Augarten, Ticknor & Fields, New York, 1984.

Many thanks to the staff of the Computer Museum History Center for their assistance with research. Also for allowing us to take photos of their SAGE equipment. And thanks to Les Earnest, Paul Edwards and James Wong for giving the SAGE historical lecture in 1998 which made this possible.

ASUSA K2003 Amplifier

Good Things Come in Small Boxes

By David Bardes ©2000 All Rights Reserved

The K2003 is a small, inexpensive amp from ASUSA's line of tube amplifier kits. This time Antique Sound USA engineers chose the EL84/6BQ5 pentode as the output tube for single-ended operation. By using only a pair of EL84s and a single ECC83/12AX7 on a small chassis, ASUSA could offer this amp kit at a very modest \$399. While many low wattage SE amps look like 800-pound gorillas, the K2003 is only ten inches long, and weighs in at only eight pounds. Output is rated at 4 watts per channel.

The assembled kit is quite attractive, and is available in black powder coat finish (standard) or chrome chassis for an additional \$75. A black cage is also available for an extra \$75. Cute is the word that best describes this amp. The transformers are small, horizontally mounted affairs that seem appropriate for this "smaller than a breadbox" amp. Front panel controls include a stereo volume pot and a lighted power switch. Gold-plated speaker binding posts and gold plated RCA-type input jacks populate the back panel.

The kit comes with all that is needed, including Sovtek tubes and an IEC power cord. The instructions include a schematic, illustrations, and a step-by-step instruction manual. Despite the completeness of the kit, it took a couple of tries to get it right. Building this amp was not as easy as we had hoped. This is due to the small chassis and awkward layout. The use of a circuit board, or providing a chassis that is a couple inches longer or wider, would have reduced the confusion and the cramped soldering. Cute, it seems, has its price. Parts selection is modest as well. We would have liked to have seen bigger filter caps and diodes included in the kit. However, a couple of false starts and a new set of diodes later, we were in business. (Note: ASUSA has informed us that it has changed the component layout under the

chassis, making it easier to assemble.) Assembling the kit doesn't take long, as there are only a handful of parts. We assembled our kit in about five hours.

We were quite surprised at the sound of this little amp. This amp doesn't sound small at all! Bass is quite solid, although it does have just a bit of bloom. The highs are uncongested and the detail is good. No, it doesn't have the bass grunt that many push-pull amps have, but the K2003 also has less grain than many push-pull amps have. The K2003 possesses a rich, laid-back sound that isn't too romantic or mushy.

The first listen was through a pair of Klipsch corner horns, and of course four watts is plenty for these super-efficient speakers. So we tried it on some less-sensitive bookshelf speakers (B & W DM110s), and we were surprised to find

ASUSA K2003 Back Panel

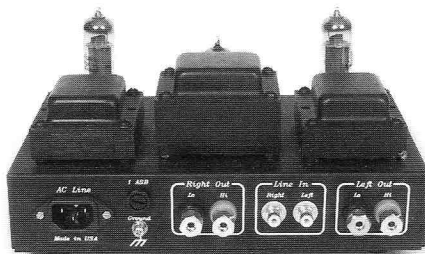

they had plenty of muscle to drive them to room-filling levels. Yes, it would distort at painfully loud volumes, but was great for normal listening. Only when the speaker efficiencies dropped below 88 dB, as with our vintage Dynaco A-25s, did they start to sound congested and strident when we cranked it up.

Some parts upgrades and tube rolling improved the already impressive sound. We replaced the existing silicon diodes with IXYS HEXFREDs. This cleaned up

the sound, adding more detail and a larger soundstage. Most of the bass bloom was removed as well. Next, we tried NOS Siemens (West German) E84Ls (similar to 7189s) and a JAN Philips 12AX7WA in place of the Sovtek tubes. These tubes provided the K2003 with the sweet and detailed sound associated with much more expensive amplifiers. With these changes, the K2003 is just shy of the sonic magic associated with SE 2A3 and 300B triode amplifiers. But don't discount the Sovtek EL84s. While they didn't have the detail and transparency of the Siemens NOS tubes, they did have more gain. A great combination is your favorite NOS 12AX7 with the Sovtek output tubes. This is a simple and modestly-priced upgrade that anyone can do.

ASUSA's K2003 is quite a bargain at \$399 in kit form or \$499 fully assembled. It sounds great in its stock configuration, but can really be dialed-in with a few choice parts upgrades and tube substitutions. We recommend that builders replace the stock diodes with HEXFREDs when they first build this kit. The few extra dollars invested at the beginning are well spent. Other upgrades such as replacing the coupling capacitors and increasing power supply capacitance we'll leave up to the kit builder. (Note: circuit modifications may void the warranty on your amplifier.)

We almost neglected to mention that one of the advantages of the diminutive K2003, is the ease with which you can show it off. Its light weight and small size make it easy to take over to a friend's house for an impromptu audition. This benefit should not be overlooked!

Post Script

ASUSA has told us that it is going to offer a premium upgrade option for the K2003 including HEXFREDs and silver coupling caps. Being impatient, we inserted our own silver coupling caps into our amp, having already installed the FREDs. Wow! This is the best EL84 amp we have heard in quite some time. The combination of FREDs and silver coupling caps gives this amp a very rich, open and smooth sound, even with the stock Sovtek tubes. Meanwhile, this author is enjoying our prototype premium K2003 in his living room.

ASUSA-Kit, 6717 NE 181st Street,
Kenmore, WA 98028 USA
PH (425) 481-8866
FAX (425) 485-3836
www.as-usa.com

Ultimate 6L6 Shootout

Evaluations of 20 New and NOS

By Charlie Kittleson and Ron Veil ©2000 All Rights Reserved

Since 1936, the 6L6 has been the standard in professional audio amplification. Its use in guitar amplifiers started with Gibson, Rickenbacker, and Fender in the late 1930s and early 1940s. Fender amps including the Bassman, Bandmaster, Vibrosonic, Twin, etc., were the dominant users of 6L6s. Over the last 60+ years, hundreds of thousands of guitar amps have been produced that used the 6L6. Even today, Fender, Boogie, Sovtek, and countless other boutique guitar amp manufacturers rely on the 6L6 for tone.

Since the first one rolled off the RCA tube production lines, there have been almost one hundred variations of 6L6s in the USA and other countries. For this article, however, we will be concentrating primarily on modern 6L6 types you can buy from your tube dealer or retailer. For more detailed history and discussion of many older 6L6 types, check out VTV issue #4, pages 3 through 11. Please note, this article will focus on the 6L6 as used in guitar amplifiers, because of its predominance in that market. While several vintage hi-fi amps made by Heathkit, McIntosh, and RadioCraftsmen used 6L6s, only a handful of tube hi-fi amplifiers use the 6L6 today.

Why are we doing a 6L6 shootout? In audio, every component in the circuit adds a degree of coloration to the overall sound. Even if the scope dopes and meter readers say it doesn't exist because they

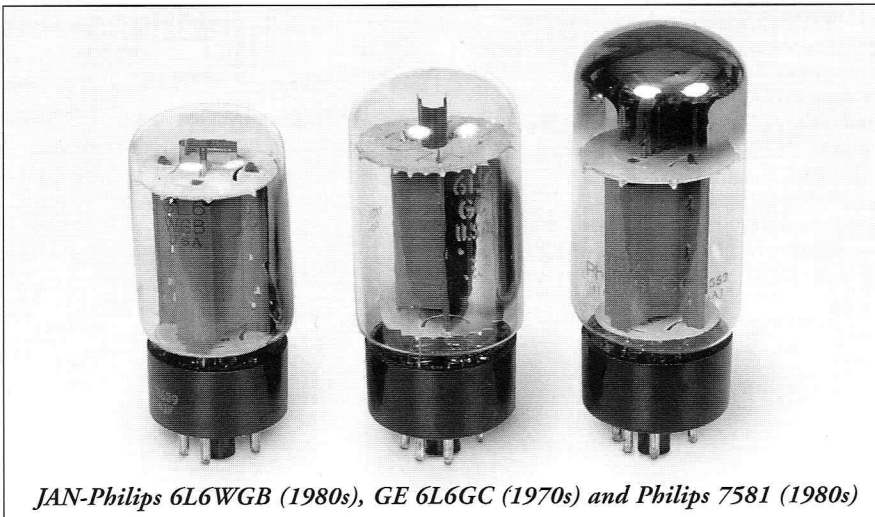

can't measure it, musicians can hear the difference. Solid-state amps are colored in a dry, artificial, sterile way that most guitarists simply don't care for. Wire, transformers, resistors, caps, controls, and speakers all add something to the sonic coloration of the musical output. Tubes can dramatically change the tone and distortion characteristics of a guitar amp and are the quickest way to do it. By simply plugging in another tube, re-biasing your amp, and plugging in your guitar, you will notice the difference immediately.

So many 6L6s, so little time! Today, there are more 6L6 and 5881 types on

the market than any other time in the last 25 years. Electric guitarists have more control over their tone with all these competitively priced new tubes. With the assistance of Groove Tubes, New Sensor Corporation, Svetlana Electron Devices, and Magic Parts, we were able to assemble an awesome collection of currently

available 6L6, 5881 and KT66 types. In addition, we rounded up some of the coolest classic vintage glass including original Tung-Sol 5881s, Genalex KT66s, Mullard EL37s, RCA "black-plate" 6L6GCs and GE 6L6GCs. Note that NOS audio tubes have been increasing in value steadily over the last 10 years. If you want to try some of the NOS types, don't wait too long or they may be priced out of your range or unavailable.

The 6L6s reviewed here came in three basic types:

1. **6L6GC** General Electric originally introduced this type in 1959. Plate dissipation was improved over the original G, GA and GB types. Sylvania, Westinghouse, and RCA (black plate) introduced their 6L6GC versions in the following years. The 7581 was the commercial version of the GC and is sometimes marked as a KT66. Most 6L6 types currently made are similar to the GC design.
2. **5881** Tung-Sol Electric of Newark, New Jersey originally introduced 5881s in 1950. They appear to be a derived design from the 6AR6 tube that was developed by Western Electric during WW2. The 5881 was a compact version of the 6L6G that was used in everything from B-52 bombers to Heathkit Williamson amplifiers. Fender used 5881s in its early amplifiers including the Bassman and Twin from 1954 to 1960.



Mullard EL37 (1960s) and Genalex KT66 (1950s)

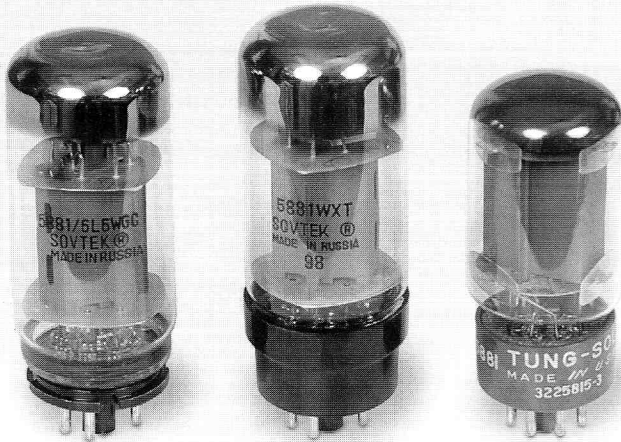

Sovtek 5881 (1990s), 5881WXT (1990s) and Tung-Sol 5881 (1950s)



Ruby 6L6 GC-C, 6L6GC-RC and 6L6GC-STR (1990s)

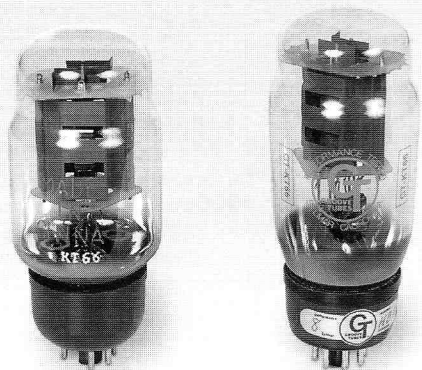

Chinese KT66 (1998), Groove Tubes KT66 (1998)

Marshall also used 5881s for a short time in its amplifiers made during the 1960s. There are a few derivative 5881s including the 6L6WGB JAN Sylvania.

3. **KT66** - A British beam power tube was introduced in 1938 by MO Valve and later

made by Genalex, Emitron, and Mullard (Philips). KT stands for kinkless tetrode, meaning that the response curve did not have the typical tetrode "kink" in it and was more linear.

Unfortunately, production of the famed KT66 officially ended in the 1970s with the legendary Gold Lion KT66 that had clear glass with a gold script and a figure of a lion on the bottle. NOS examples became very pricey, so a few years ago, they were re-introduced by a few manufacturers.

Tone Time!

For our 6L6 Tone Fest, we gathered up a unique crew of reviewers including guitarist Phil Loarie (he has a website devoted to the 6L6 tube <http://diva.eecs.berkeley.edu:80/-loarie/blues.html>), Ron Ott long time guitar amp tech and builder of King Amplifiers, Greg Cooper (San Francisco jazz guitarist extraordinaire to lay down the tone), David Bardes, and ourselves. The event was held at Ron Ott's house in Pleasanton, CA. In order to get the most variation in tone, we used both a Fender Custom Strat with Fralin pickups and a 1967 Gibson ES335 semi-hollow body guitar. Amps used were a 1971 Fender Black-Faced Super Reverb (with a 1967 transformer and four ten inch Alnico CTS), a 1999 Allen Amplification Old Flame 40 watt amplifier and a King Blues Rocker (basically a Marshall JTM-45 circuit). The speaker cabinet used with the Allen and King amp had two Weber C-10Q drivers. No effects, signal processors, reverb or other tone altering devices were used in the test.

All 6L6 sets were matched with the digital Maxi-Matcher and burned in for several hours, then checked again to insure close matching. Output tube bias varied from about 30 to 35 mA per tube for the 6L6s and 5881s and between 36 and 39 mA for the KT66s. Bias current was measured with the Swamp Probe Bias probe.

To calibrate our ears, we started out with the classic RCA 6L6GC black plate in all the amps. Then we ran through the other 6L6s, 5881 types and the KT66s and the EL37. Below is a general summary of the shootout. Certain guitar-amp combinations produced unique results and were commented on specifically.

RCA 6L6GC Black Plate (1960s)

This tube had a rich fluid warmth in the clean mode. Played with either the Strat

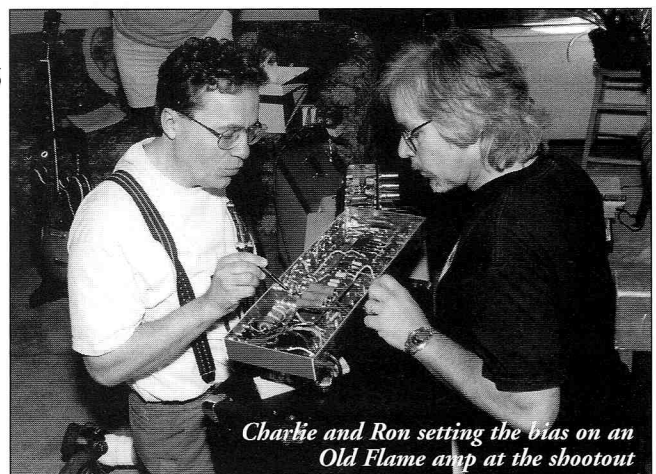

Charlie and Ron setting the bias on an Old Flame amp at the shootout



Tesla 6L6GC (1999s), Sovtek KT66 (1999) and EI KT66 (1990s)



Sovtek 6L6GB (1990s), 6L6GC-WXT (1999) and RCA 6L6GC "Blackplate" (1970s)

or 335, the RCA generated chimey, warm and detailed sonics. When pushed into distortion it had a tight, controlled and detailed breakup. The black plate's awesome performance was consistent in all three amps, and with both guitars. This is still the King of NOS 6L6GCs!

GE 6L6GC Grey Plate (1965)

A nice, and full sound in the clean mode. When kicked into the distortion mode it had a powerful sound with lots of warmth and strong bass. It was close to the RCA black plate, but just a tiny bit edgier.

JAN Philips 7581A (1980s)

When played clean, this one had a touch less dimensionality and was slightly flat sounding. Driven into distortion, it had good control and was full sounding. When played in the King Blues Rocker, it was full-bodied and balanced with zing

and no harshness. We pumped up the bias to 40mA and noted better definition and even fuller, tighter performance.

Ruby Tubes 6L6GC C (1999)

This is a competitively priced tube (made in China) with a soft, warm mid-range. Easily overdriven, it had a tilt towards the treble and was not as powerful as the Ruby STR.

Ruby Tubes 6L6GC RC (1999)

When played clean, this was a full, musical and chimey tube with a nice upper frequency response. The RC distorted easily, but it seemed a little bright in the Super Reverb and bass was not super tight. However, in the King Blues Rocker it sounded great.

Ruby Tubes 6L6GC STR (1999)

This tube was modeled after the origi-

nal Sylvania STR-387 and was an excellent performer. Played clean, it was full, rich, and balanced sounding. When overdriven, it had a rich, solid distortion tone great for most rock applications.

Svetlana SV6L6GC (1999)

With the Gibson 335 and Allen Old Flame in the clean mode, this tube was loud and powerful sounding with lots of headroom. In the distorted mode, it was full-bodied, with a nice, chimey response. The Svetlana is a solid and reliable tube for most guitar amp applications.

Tesla 6L6GC (1990s)

This tube has a nice, chimey midrange, but the upper frequencies were a little thin sounding played in clean channel. In the distorted mode, it was slightly edgy in the treble registers. In other amps it may sound different.

Sovtek 6L6GB (1990s)

This one had warmth, but not the upper frequency detail of some of the others in the clean mode. When it distorted, the tone was not as even or controlled as other tubes in this test.

Sovtek 6L6WXT+ (1999)

A warm but detailed sound with just the right amount of upper-mid range bite in the clean mode. In the distorted mode, mids were nice and strong.

5881 TYPES

JAN Philips 6L6WGB (1980s)

A modern derivative of the 5881, in the clean mode, this tube had good upper-frequency detail and sweet sonics. In the King Blues Rocker with the Gibson 335, it had a nice, woody character when played clean. It was powerful and detailed sounding in the distorted mode.

In the Allen Old Flame amp with the Strat, it was chimey, warm, and detailed. Some felt that it was very close to the RCA black plate 6L6GC. Overall, a great general-purpose tube for most types of guitars and playing styles.

Tung-Sol 5881

Used by Fender in the 1950s, this tube had that funky twang when played in the Fender-style amps with a Strat. It was warm, detailed, and kind of had a glassy sound in the clean mode. When pushed into distortion, it had a slight edge and a tilt towards the treble side.

Sovtek 5881 (1990s)

It appears that Sovtek has made some improvements in this tube as the first versions of their 5881 were a little thin-sounding in the mids. This latest 5881 had better mids and bass response when played with the Gibson 335 through the King Blues Rocker Amp. It sounded decent in the overdriven mode with full mids and highs.

Sovtek 5881WXT+ (1999)

A noticeable improvement of the standard Sovtek 5881, the WXT really rocks! Played clean, it had impressive, full mids and was nice and chimy. When overdriven, it had great distortion and sustain. This tube definitely exceeded our expectations in that it sounded better than a lot of the NOS stuff out there. If you want great tone on a budget, the Sovtek 5881WXT is your bottle!

KT66 TYPES

Genalex KT66 (1960s)

In the clean mode this classical glass had sweet fullness and chime. Chords and single note leads sounded extremely defined with a powerful bottom-end. When overdriven, distortion was sweet, balanced, and easy to control.

Chinese KT66 (1999)

Almost an exact look-alike to the famous Genalex Gold Lion clear glass KT66, this tube was very balanced and musical with strong bass. This tube would be great for full-sounding rhythm guitar. In distortion mode, it was lively and huge-sounding, perfect for rock power chords and lead, especially in a Marshall-type circuit.

EI (Yugoslavian) KT66 (1980s)

This tube looks like a junior KT90 and is not currently in production. In the clean mode, it sounded kind of flat and was less dimensional in the midrange. Distortion sound was a little better, but slightly on the edgey side.

Groove Tubes KT66 (1999)

This is a balanced and smooth sounding tube in the clean mode. When overdriven it was sweet and powerful with nice breakup. According to Groove Tubes, their KT66 should only be used in amplifiers with no more than 450V on the plates of the output stage. When kicked in to overdrive, it distorted evenly, especially in the Super Reverb amp with the Strat.

Sovtek KT66

This bottle resembles a Tung-Sol 6550. In reality, it is a low-profile KT66 that will fit in most 6L6 amps. In the clean mode, this tube was very musical. When pushed into distortion, it was not as full-sounding as the other KT66s in this test.

Mullard EL37 (1959)

Vintage Mullard EL37s have a premium tone with detail, richness and warmth. In the clean mode, the EL37 is balanced and full sounding. It sounded awesome overdriven with both the Fender and Gibson.

OUR FAVORITE 6L6s:

The following were our favorite tubes of this shootout in no particular order of preference. Your own results may vary depending on your amp, its state of repair, and your guitar:

JAN Philips 6L6WGB

This NOS glass is a detailed, musical and warm tube with both single coil and humbucker guitars. When kicked into overdrive it screams and remains very tight-sounding. These are super rugged tubes designed for extremely brutal conditions by the US military. They are made with genuine US craftsmanship and attention to quality and materials we will never see again. WGBs can be bought from most NOS tube dealers for under \$20 (2000 price), so get your lifetime stash now!

KT66 (Chinese reissue)

The Chinese version of the Genalex KT66 was well liked by all the reviewers. This tube has a powerful full-bodied sound; it is chimy and has great overall definition. Sound character is balanced in all musical registers and has smooth response. Overall sound is very close to the original Genalex, but a whole lot less expensive. Remember that KT66s are twice as large as a standard 6L6, so clearance in your amp may be a problem. This tube is a **Best Buy** in the world of KT66s!

Mullard EL37

EL37s are magical and rich sounding. A full-bodied, balanced and chimy tube in clean and distorted modes, this tube does everything right. It had sweet, extended highs, excellent midrange definition and deep bass. EL37s can also handle high-voltage really well, but are physically taller than an average 6L6 or EL34. These tubes were originally used in tube hi-fi amps during the 1950s and 1960s.

RCA 6L6GC Blackplate

The RCA 6L6GC is still king of tone for Fender and boutique amplifiers. This tube simply has a rich and smooth sonic presentation. It is very harmonically balanced and just sounds right. Beware of Japanese copies made in the 1960s that may be rebranded as RCAs. Blackplates are getting scarce and the price just keeps rising. Get your supply now.

Ruby Tubes 6L6GC-STR

Magic Parts really did their homework with their Ruby Tubes 6L6GC-STR. This tube is designed after the legendary STR-387 Sylvania that was used in the original Mesa Boogie amps. Clean tones were warm, full and sweet. Distortion is full-bodied, balanced, and well-defined. The Ruby 6L6GC-STR worked well in all the different combinations of gear during this test. This is an excellent tube for most rock guitar applications. The Ruby STR is a **Best Buy** in the 6L6GC types!

Sovtek 5881 WXT+

Sovtek has an incredible array of 6L6 and 5881 type tubes available for most musical tastes. It worked hard to improve its existing 6L6/5881 designs as well as introduce some new types. We were all impressed with the performance of the 5881WXT+. This is a tube with balanced sonics, a strong-full-bodied bottom end and lots of chime in both clean and distorted modes. In both the Allen Old Flame and the King Blues Rocker and with both the Strat and the ES335, tone was consistently musical and very pleasing. Overall, this tube is a **Best Buy** in the world of 5881s!

Some Parting Thoughts

Our **subjective** opinions in this tube shootout are based upon the tubes, guitars and amps we used during this evaluation. If you try this at home, your results and preferences may be different. This article is designed to inspire guitar players to experiment with their tone by trying different tube types. We encourage you to do some tube rolling of your own; it is fun and besides, you may learn something. **USE CAUTION!** Remember that you are dealing with high voltage and power tubes get very hot, so use insulated gloves when removing them from amps.

Note that many of the new 6L6/5881 types tested here are also available from companies like Groove Tubes and others in pre-tested graded pairs and quads. Also, OEMs can fine-tune their amp design to a specific 6L6 type and it will perform very well, while other tube types may not sound as good in that amp.

A Cathode Follower Amp

6528 in Single-Ended Mode

By John Atwood ©2000 All Rights Reserved

The cathode follower as an output stage has intrigued audio designers for decades. It promises very low output impedance and low distortion, both due to the high amount of local feedback in the output stage. The big difficulty with a cathode follower stage is the very high grid drive voltage needed on the output tube, since there is no voltage gain (and in fact sometimes a substantial loss) in that stage. However, if well-implemented, a cathode-follower amp can be an excellent performer.

The amplifier described here was built by Bruce Tilden, a California amp restorer and builder. Several of the design concepts seen in this amp, such as separate power supplies for each stage and all octal tubes, are hallmarks of Bruce's designs. Bruce is a designer who has built a lot of amps and carefully listens for what makes them sound good. These attributes are then incorporated into his designs.

For the output tube, Bruce used a 6528, which is a Chatham-designed dual triode that is a high mu brother to the

6336 ($\mu = 9$ vs 2.7). This beefy graphite-plate tube was designed as a voltage regulator and has a total absolute maximum plate rating of 60 watts. In this amplifier, the total dissipation is about 40 watts, so the tube is comfortably within its limits. A One Electron UBT-1 SE output transformer couples the cathodes

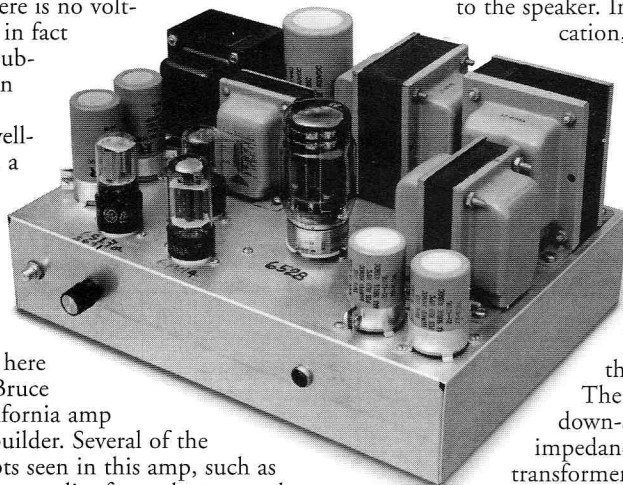

to the speaker. In this application, only a 14:1 ratio is needed to drive an 8-ohm load, so the normal 16 ohm tap becomes the 8 ohm tap, the 8 becomes the 4, etc. The pitfall in down-shifting the impedance in a transformer is that the high-frequency response suffers due to leakage inductance and stray capacitance.

However, the UBT-1 has a very good high frequency response, and is not a problem here. Bruce cleverly uses the 165 ohm primary DC resistance to bias the tube, generating the 26 volts needed to run the tube at 160 mA. If you substitute a different transformer, make sure it has a primary resistance of 165 ohms!

It may be necessary to select the 6528 so that the sections are matched within about 10 mA or so. This can be done by letting the tube under test warm up, then measuring the voltage across either the 1 ohm cathode resistors or 15 ohm plate resistors and using Ohm's law ($I = E/R$) to calculate the current in each section.

In order to use a cathode follower output stage, the driver

needs to supply the full output swing at the output transformer plus any losses in the output tube. At 5 watts output, 81 volts rms was measured at the cathodes and 94 volts rms (266 volts peak-to-peak) was measured at the grids. The somewhat higher voltage loss than expected is due to internal resistance in the output tube. To generate this large drive voltage with low distortion required a good low- μ triode, the 6AH4GT (originally designed for TV vertical amplifier service) run from a high (440V) B+ supply. The plate resistor is fairly low in order to drive the 47K output grid resistor. The first stage uses either a 6SL7GT or its rugged equivalent, the 5691, with its sections paralleled. Running from a high B+ supply insures very low distortion in this stage.

The power supply may seem a bit excessive, but by using separate supplies for every stage, interaction between stages is minimized. Bruce has found that this technique really has good sonic benefits. Surplus Triad (now Magnatek) transformers were used, but any other combination of transformers with specs similar to those on the schematic can be used. The power resistors in series with each filament supply were added to bring the filament voltages down to 6.3V with a line voltage of 120 volts. Without these, the filament voltages were well over 7 volts -- shortening tube life.

The 1500 pF capacitor across the cathode resistor of the 6AH4GT is some "cathode compensation" to help counteract the Miller effect in the driver stages. The amplifier puts out 5 watts before clipping, and has 1.6 % THD at 2.5 watts output. The frequency response is down -1dB at 20Hz and 27KHz.

A pair of these amplifiers were auditioned in several local enthusiasts' homes and were well-liked. The amp has a balanced, clean, and more accurate sound than most single-ended amps, yet doesn't sound at all like a transistor amp or push-pull amp. It works well with all efficient speakers tried, but seemed to work especially well with a vintage full-sized Klipsch corner horn. This may be because its low output impedance damped the bass boominess that occurs when the speaker is up against masonry walls, as it is in my house. This particular speaker is also hyper-sensitive to any grunge or edginess in the amplifier, and the cathode-follower amp came out very well here. All in all, this unusual amplifier performs well, yet is straight forward to build.

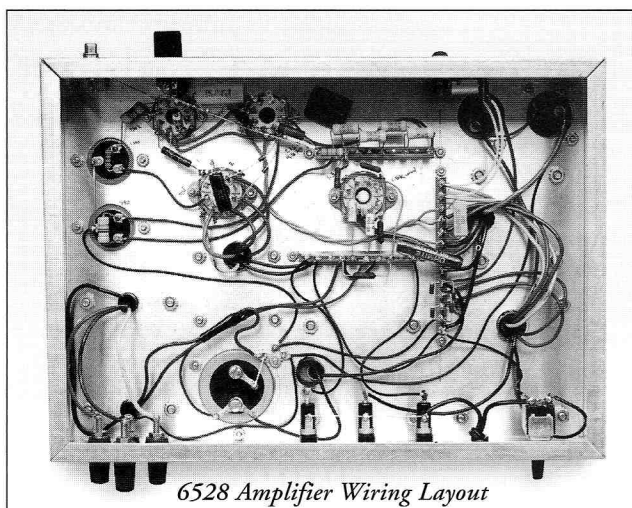

6528 Amplifier Wiring Layout

Tube Dumpster: Subminiature Types

By John Atwood ©2000 All Rights Reserved

Some of the more obscure types of tubes, at least to the average tube enthusiast, are the subminiatures. They have become more noticeable in the marketplace recently, since the US government has been liquidating its tube reserves. But are they any good? They have funny part numbers. How do you use them in circuits? This article will give a short history of subminiature tubes, descriptions of the more common types, and ideas on how to use them.

History

The first subminiature tubes were developed in the late 1930s as ultra-low power battery tubes for hearing aids. In America in 1940, Raytheon brought out the first subminiatures: a flattened envelope with the leads coming out one end in a flat press seal. This construction became Raytheon's hallmark style for subminiatures. Hytron followed with a line of even smaller "Super Bantam" hearing-aid tubes. During World War II nothing was heard about subminiatures, but behind closed doors they were a key part of one of America's secret weapons: proximity fuses for anti-aircraft shell and bombs.

Normal anti-aircraft practice required that the gunners manually set timers in the shell fuses to explode at the estimated altitude of enemy planes. This was a time-consuming and error-prone process that reduced the effectiveness of anti-aircraft defenses. If the planes dropped to a lower altitude, the shell would whiz right by them and explode too far away. By build-

ing a very simplistic doppler radar (similar in concept to police radar) into the fuse of the artillery shell, no adjustments were needed, and the shell would explode close to the plane. A simple 5 tube circuit was developed -- but the tubes needed to be very small and had to withstand 20,000Gs! Raytheon and Sylvania developed tubes for these shells and started producing enormous amounts of them. Although the proximity fuse became available late in the war, they were instrumental in reducing losses due to Japanese kamakazi pilots.

After the war, both Raytheon and Sylvania looked for ways to keep their subminiature production lines running. Raytheon had concentrated more on the battery type tubes, and found a ready market for them in hearing aids and portable radios. Sylvania, who was making mainly 6.3V heater-cathode types, had more of a problem. It tried convincing manufacturers to use them in consumer equipment -- but most manufacturers were just beginning the transition from octal to miniature (7,9 pin) tubes and couldn't be bothered with these tiny "pencil" tubes. The only successes in the commercial field (outside of avionics) were in a few special applications in test equipment, and in the lunchbox-size portable police radios of the 1950s.

It was the cold war that really drove up the volume of subminiature tubes. As the Army and Navy tried to pack more sophisticated radio systems into backpack and hand-held units, battery-type subminiatures were essential. Their compactness and ruggedness made them just right for avionics -- where most of the 6.3 and 26.5 volt subminiatures went. Missiles were another favorite use. Their small-

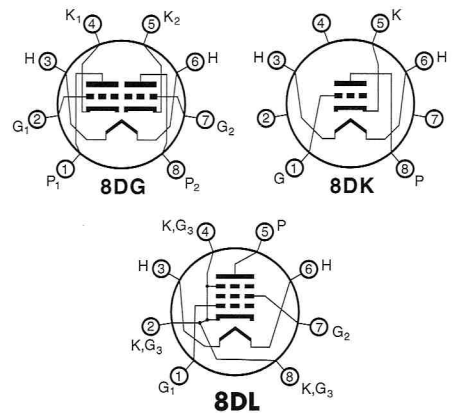

size gave them very good VHF and UHF performance. Once military equipment designers got familiar with them, they got designed into all sorts of equipment that didn't necessarily need their small size: shipboard radios (e.g., AN/SRR-13), analog and digital computers, and other military equipment. They were getting designed into avionics up until 1960, and since this equipment was manufactured for at least several years and had lifetimes of 10 to 20 years, subminiature tubes were in active use in aircraft through the early 1990s. It is believed that the communications equipment in the Mercury space program used subminiature tubes.

Raytheon and Sylvania were the major manufacturers of subminiature tubes, each with their distinctive designs: Raytheon with the flat-press base and Sylvania with the round 8-wire base. Both made battery types and 6.3 volt types. In military equipment the Raytheon types dominated in the battery applications and were second-sourced by Tung-Sol. Sylvania types dominated in the 6.3 volt applications. Many of the 6.3 volt types and a few of the battery types were also manufactured by RCA, GE, Sonotone, Philips, and Mullard. In England, Hivac came out with its own line of battery subminiatures. Interestingly, both the initial developers of the subminiature tubes were among the last American tube manufacturers. Raytheon and Sylvania (Philips ECG by this time) both shut down their subminiature tube production lines in the late 1980s.

Varieties

There are four general varieties of subminiature tubes: 1. Battery tubes. These are almost all Raytheon flat press construction. 2. Flat-press heater-cathode types. These are almost exclusively made by Raytheon. 3. Round-base heater-cathode types. These are mainly Sylvania-

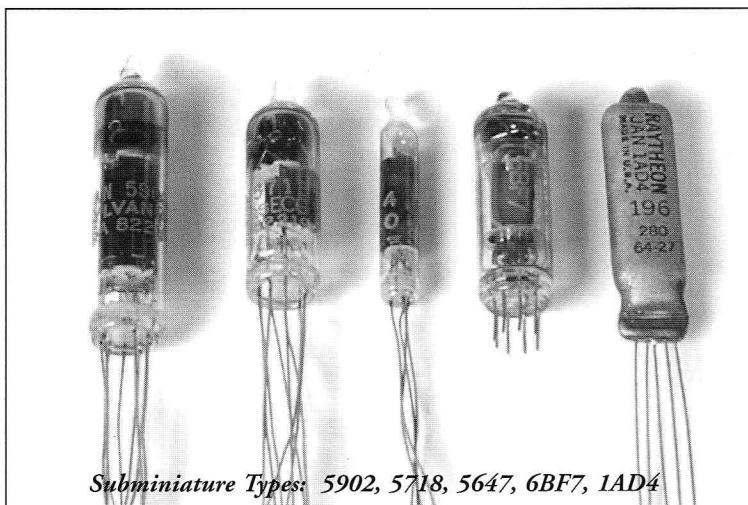

Subminiature Types: 5902, 5718, 5647, 6BF7, 1AD4

designed, with other companies (including Raytheon) second-sourcing the popular types. 4. Miscellaneous types.

The battery types range from ultra-low power hearing-aid types (such as the CK512AX) to relatively higher-power types used in portable military transmitters (5676). Most of these tubes are pentodes, since they can eke out the most gain possible with the least filament power. Battery tubes normally have a reputation for high microphonics in audio uses, but the subminiatures are rugged enough to approach regular miniature tubes for microphonics.

The heater-cathode subminiature tubes were often modeled after conventional miniature tubes and most have similar characteristics. The accompanying table lists the most commonly-found types that would be of interest to audio designers. Single and dual triodes are common, and make good audio tubes. They are quiet and have reasonably-low distortion. Note that the medium-mu triodes (6AK4, 5703, 6111) have nearly double the transconductance of, say, a 12AU7. A few of the later tubes (7963, 7995) are competitive with the high transconductance miniature tubes. Not listed are audio and video output tubes, diodes, dual-control pentodes, and low-mu regulator triodes. Also not listed are tubes with 26.5 volt heaters.

The miscellaneous types include high-voltage rectifiers, gas regulators, electrometer tubes, corona discharge regulators (made by Victoreen), thyratrons, and others.

During the 1950s, Bendix was contracted to develop subminiature versions of power tubes, including the 6L6 and 6AS7. Ceramic-metal prototypes were constructed, but never went into production due to problems with their very high operating temperatures.

Application

Data on subminiature tubes can be found most easily in the General Electric "Essential Characteristics" manual. It covers most types, except for some of the specialized Raytheon types.

Subminiature tubes can either be socketed or wired directly into the circuit. The sockets are 7-pin in-line or 8-pin round sockets, which, by the way, evolved into popular transistor sockets. Since most subminiatures are shipped with 1 1/2" long leads, they have to be carefully clipped to about 1/4" long if used with sockets. For purist audiophile applications, soldering the leads directly into the circuit is very

6.3V Heater-Cathode Tubes								
Name	Type	Base	Ep	Ip	Rp	Gm	mu	similar to
6AD4	triode	8DK	100	1.4	35K	2000	70	1/2 5751
6AK4	triode	8DK	200	9.5	5.3K	3800	20	
6BA5	pentode	8DY	100	5.5	175K	2150	-	
6BF7	dual triode	8DG	100	8.0	7K	4800	35	2C51/5670
5637	triode	5637	100	1.4	26K	2700	70	
5645	triode	5645	100	5.0	7.4K	2700	20	6C4
5646	triode	5645	100	1.4	29K	2400	70	
5702	pentode	5702	120	7.5	340K	5000	-	6AK5
5703	triode	5703	120	9.0	5K	5000	25	
5718	triode	8DK	100	8.5	4.65K	5800	27	
5719	triode	8DK	100	0.7	41K	1700	70	1/2 5751
5744	triode	5744	250	4.0	17.5K	4000	70	
5840	pentode	8DE	100	7.5	260K	5000	-	6AK5
5897	triode	8DK	100	8.5	4.7K	5800	27	
5898	triode	8DK	150	1.7	26K	2700	70	
5901	pentode	8DL	100	7.5	230K	5000	-	6AK5
6021	dual triode	8DG	100	6.5	6.5K	5400	35	2C51/5670
6111	dual triode	8DG	100	8.5	4K	5000	20	
6112	dual triode	8DG	100	0.8	39K	1800	70	5751
6205	pentode	8DC	100	7.5	260K	5000	-	6AK5
6832	triode	8DG	100	0.8	25K	1050	26	
7963	dual triode	8DG	100	7.5	3.1K	13000	40	6DJ8
7995	pentode	8KZ	150	8.0	85K	13000	-	6EW6

1.25V Filamentary Tubes								
Name	Type	Base	Ep	Ip	Rp	Gm	mu	comment
1AD4	pentode	1AD4	45	3.0	500K	2000	-	
1AH4	pentode	1AD4	45	0.8	1500K	750	-	
CK512AX	pentode	512AX	22.5	0.125	1250K	160	-	fil. = 0.625V
CK522AX	pentode	512AX	45	0.65	700K	625	-	10mW output
2E31	pentode	2E31	22.5	0.4	350K	500	-	
5672	pentode	2E31	67.5	3.3	-	650	-	65 mW output
5676	triode	5676	135	4.0	9.4K	1600	15	
5678	pentode	5676	67.5	1.8	1000K	1100	-	
6029	triode	5676	90	11.0	4.25K	2000	8.5	

Miscellaneous Tubes			
Name	Type	Operating Conditions	Similar to
5642	HV Rectifier	10KV max, 0.25mA max	1V2
5643	Xenon Thyatron	16mA max	5696
5783	Voltage Reference	87V, 1.5 to 3.5mA	5651
5787	Voltage Regulator	100V, 5 to 25 mA	0B2
5886	Electrometer Pentode	gm = 14 umhos @ 12V on plate	

Gm and Rp are at stated Ep (plate voltage) and Ip (plate current).
For more information, refer to GE "Essential Characteristics".

attractive, since the noise and unreliability of dissimilar metal contact is avoided. Soldering very close to the glass envelope should be avoided, though.

Even though subminiature tubes are very small, their power dissipation is only moderately lower than miniature tubes. As a result, their bulbs can run very hot. Packing lots of tubes in a small space aggravates this heat build-up. Studies of subminiature tube reliability show that, although the maximum bulb temperature rating is 220°C, they are most reliable below 180°C. Interestingly, if the bulb temperature is below 100°C, inter-element leakage becomes a problem. In military equipment, subminiature tubes were usually mounted in beryllium-copper clips that acted as heat sinks.

The maximum ratings of subminiature tubes are lower than regular tubes, so the maximum ratings need to be checked. The

maximum plate voltage rating for most heater-cathode types is 150 to 165 volts. The reliability studies recommend no higher than 125 volts for longest life.

Food for Thought

Subminiature tubes were the focus of intense development during the 1950s. Some of the possibilities of what these tubes could have become is hinted at in the last paragraphs of reference 4 (italics are in original text):

Super Reliability – an Attainable Goal

The fact that high reliability areas exist is verified by the presence in every test of a group of test lots that exhibited little or no degradation after 2500 hours of operation. It would be impossible to estimate the amount of time these lots would continue to provide highly reliable performance, but allied tests have shown that it would not be unrealistic to expect reliable operation for more than

20,000 hours. In one such test involving 60 dual-section tubes, no catastrophic failures had occurred and all characteristics were within initial limits on every section after 16,000 hours of operation. Also, no significant slumping of characteristics occurred in the last 5,000 hours of the test, making it impossible to use extrapolation methods to estimate the end of life due to characteristic degradation.

Indications are strong that this level of electron tube reliability is possible for many applications, provided proper choices are made with respect to tube type and operating conditions. The operating conditions for high reliability recommended in this book provide an excellent starting point for making such choices. With subsequent refinements based on careful studies of field experience, electron tube reliability could reach a level thought impossible only few years ago.

This was published in 1961. It's too bad the transistor came along to stop this development.

References:

1. "Radio Proximity Fuze Development," W.S. Hinman, Jr., C. Brunetti, **Proceedings of the I.R.E.**, Dec. 1946, pp. 976-986.
2. "Proximity Fuzes for Artillery," H. Selvidge, **Electronics**, February 1946, pp. 104-109.
3. **70 Years of Radio Tubes and Valves**, John W. Stokes, The Vestal Press, New York, 1982.
4. **Subminiature Electron Tube Life Factors**, M.W. Edwards, D.E. Lammers, J.A. Zoellner, General Electric Co., Engineering Publishers, Elizabeth, N.J., 1961.

Continuation of Klipsch Interview from Page 5

Like fashion clothing styles, some ideas seem to fall from favor and then return to vogue. In one of your white papers you mention listeners becoming tired of boomy bass response and the trend away from in-wall speakers. That was sixty years ago, although it seems like you're discussing the audio situation today. What other trends have you seen come around again?

History repeats itself. The Klipschorn, which was first marketed in 1948, has experienced 50 years of modifications, some of which have been improvements. I believe the forthcoming paper by Roy Delgado and myself will expose the succession of the improvement that brought

forth the Klipschorn Jubilee. Jubilee was chosen by being borrowed from the Jewish tradition where the Jews freed their servants after 50 years and returned 50 years accumulative properties. After all, the light bulb has enjoyed many improvements since Thomas Edison invented it over 100 years ago.

List Of Published Papers by Paul W. Klipsch:

1. "A Low Frequency Horn of Small Dimensions," **The Journal of the Acoustical Society of America**, October, 1941. Reprinted by the **Journal of the Audio Engineering Society**, March, 1979. (In 1978, Paul Klipsch was awarded the AES Silver Medal for this paper.)
2. "Improved Low Frequency Horn," **The Journal of the Acoustical Society of America**, January, 1943.
3. "A Note on Acoustic Horns," **Proceedings of the Institute of Radio Engineers**, July, 1945. Reprinted by the **Journal of the Acoustical Society of America**, January, 1946.
4. "A High Quality Loudspeaker of Small Dimensions," **The Journal of the Acoustical Society of America**, January, 1946
5. "Experiences in Stereophony," **AUDIO**, July, 1955.
6. "Room Dimensions for Optimum Listening and the Half-Room Principle," **IRE Transactions On Audio**, January-February, 1958.
7. "Stereophonic Sound with Two Tracks, Three Channels by Means of a Phantom Circuit," **Journal of the Audio Engineering Society**, April, 1958.
8. "Subjective Effects of Frequency Modulation Distortion," **Journal of the Audio Engineering Society**, April, 1958.
9. "Corner Speaker Placement," **Journal of the Audio Engineering Society**, July, 1959.
10. "Wide Stage Stereo," **IRE Transactions on Audio**, July-August, 1959.
11. "Experiments and Experiences in Stereo," **IRE Transactions on Audio**, May-June, 1960.
12. "A Speaker System with Bass Back-Loading of Unusual Parameter Values," **IRE Transactions on Audio**, July-August, 1960.
13. "Signal Mutuality in Stereo Systems," **IRE Transactions on Audio**, September-October, 1960.
14. "Polarity, Phase, and Geometry," **IRE Transactions on Audio**, January-February, 1961.
15. "Eight Cardinal Points in Loudspeakers for Sound Reproduction," **IRE Transactions on Audio**, November-December, 1961.
16. "Stereo Geometry Tests," **IRE Transactions on Audio**, November-December, 1962.
17. "A New High-Frequency Horn," **IRE Transactions on Audio**, November-December, 1963.

18. "Modulation Distortion in Loudspeakers," **Journal of the Audio Engineering Society**, April, 1969.
19. "Modulation Distortion in Loudspeakers: Part II," **Journal of the Audio Engineering Society**, February, 1970.
20. "Loudspeaker Performance," **Wireless World**, February, 1970.
21. "Delay Effects in Loudspeakers," **Journal of the Audio Engineering Society**, October, 1972.
22. "Modulation Distortion in Loudspeakers: Part III," **Journal of the Audio Engineering Society**, December, 1972.
23. "Project Notes/Engineering Briefs: 1. A Note on Modulation Distortion: Coaxial and Spaced Tweeter - Woofer Loudspeaker Systems. 2. A Note on Modulation Distortion: Two Frequencies Radiated From the Same Diaphragm," **Journal of the Audio Engineering Society** April, 1976.
24. "Loudspeaker Distortion," **The Institute of Electrical and Electronics Engineers**, April, 1976.
25. "A Note on Loudspeaker Impedance and its Effects on Amplifier Distortion," **Journal of the Audio Engineering Society**, July-August, 1978.

SILVER SONIC™
Audio Cables

Making the High End Affordable!

"With tube amps and hybrids, the Silver Sonic competed with the best."
Bound for Sound

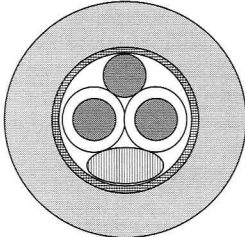

Silver Sonic T-14 Speaker Cable
Silver Sonic BL-1 Series II Interconnect
Silver Sonic D-110 AES/EBU Digital
Silver Sonic D-75 Digital Cable
Hook up wire & Connectors

D.H. Labs, Inc.
612 N. Orange Ave., Suite A-2
Jupiter, FL 33458
(561) 745-6406 (phone/fax)
www.silversonic.com

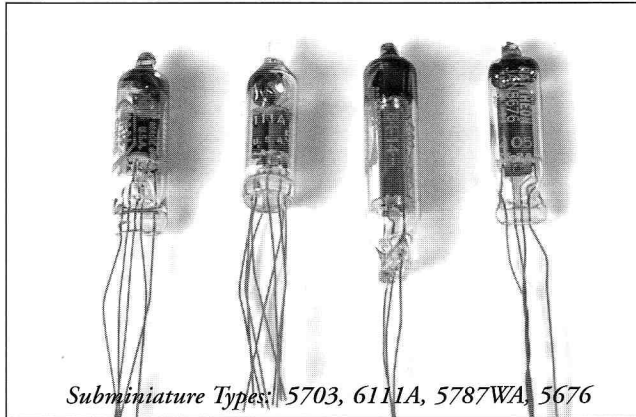

Subminiature Types: 5703, 6111A, 5787WA, 5676

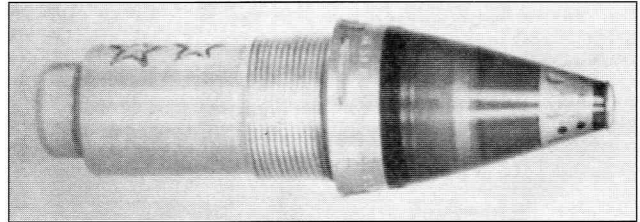

Proximity Fuse Artillery Shell

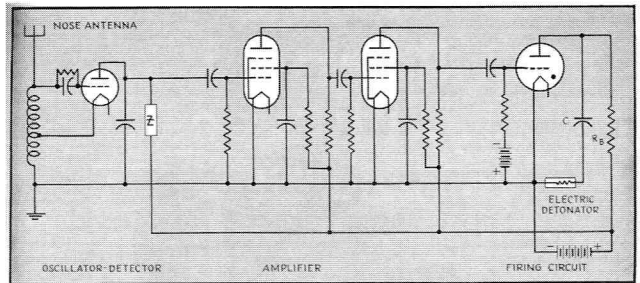

Proximity Fuse Schematic

VTV Has its first Official Vintage Hi-Fi Sale!

Coming in March 2000

Check the VTV web site for specific date of sale and location.
 Tube equipment by Dyna, Eico, Fisher, Radio Craftsmen, and Scott.

www.vacuumtube.com

TERMINAL BOARDS FOR POINT TO POINT

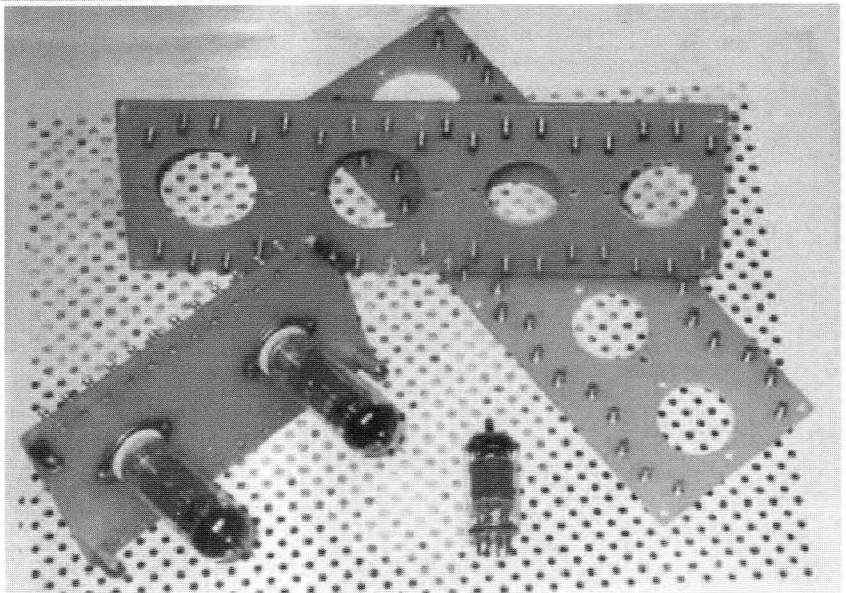
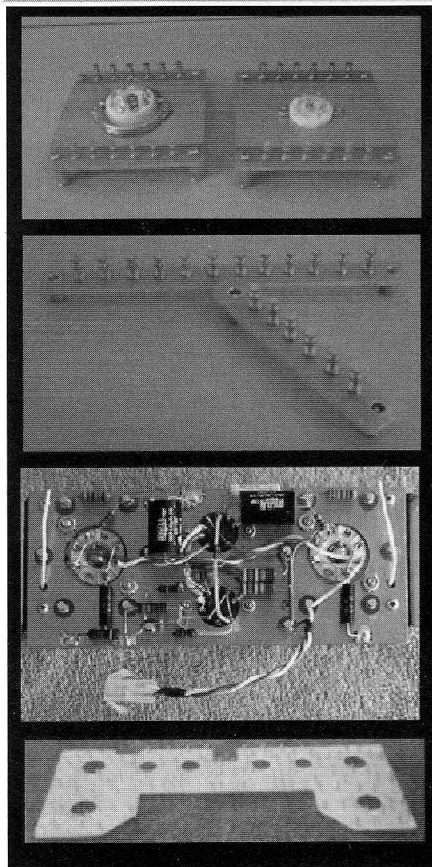

High quality terminal boards and strips are now available for your projects. Standard and custom sizes available. These rigid, high quality FR4 epoxy laminate .125" thick with copper ground plane, makes project building a breeze. Simply wire the board off chassis then install for a neat looking finish. If you build a lot of point to point projects you need these boards. These boards can be ordered in any configuration, just furnish a diagram of the layout and what type of sockets and we can build it. Please call for more details. OEM's welcome

IAG, PO Box 10096 Killeen, TX 76547-0096 Tel/Fax 254 699 8702 email hiag@dashlink.com

“a major artistic achievement”

Dr. Harvey Gizmo Rosenberg, www.enjoythemusic.com/triode/tgawards

**The best
audio output
transformers
in the world
— with specs
to prove it.**

**Ultra Wide Bandwidth
Toroidal Output Transformers
for Tube Amplifiers**

- o Single Ended
- o Push - Pull
- o Triode
- o Pentode / Super Pentode
- o Cathode Feedback
- o Unity Coupled



We specialize in audio transformers.
Since 1983 Plitron has supplied
toroidal transformers to high-end equipment manufacturers.

**“The highest quality audio transformer
I have ever heard.**

Incredible low-end response.”

Alex Aguilar, President
Aguilar Amplification, NY, NY.

**“This new sample looks super!
Congratulations to you and Menno on great
design work. Consider this as an enthusiastic
acceptance of production.”**

Christopher Russell, VP Engineering
Bryston Manufacturing, Peterborough, Ontario

**“The build quality and reliability are
excellent. ...simply the best...”**

Gilbert Yeung, President
Blue Circle Audio, Innerkip, Ontario

“ ...your design seems to be really elegant...”

Bill Chater, Journalist

**“...absolutely amazed at the low
frequency performance of your design...”**

Dr. Vincent McGinn, Chairman Electrical Engineering
Department, Northern Illinois University



8, 601 Magnetic Drive
Toronto, ON, Canada M3J 3J2
www.plitron.com
e-mail: techinfo@plitron.com
1-800-PLITRON
(1-800-754-8766)
Tel. 416-667-9914
FAX 416-667-8928

It's Like Music to Your Ears...

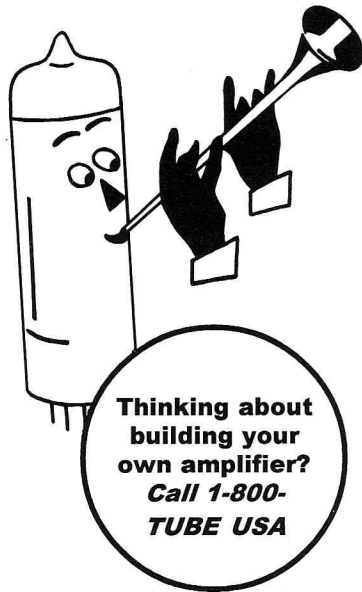

Thinking about
building your
own amplifier?
Call 1-800-
TUBE USA

Call
**1-800-TUBE USA or
1-800-882-3872**
today for your
copy of our
APD brochure
featuring
**Audio Tubes,
BLUENOTE
and Hammond
products .**

Amperex Bugle Boy

audio tubes are back and they're better than ever!

When it comes to selecting premium audio tubes for your amplifier, accept no less than the best, Amperex Bugle Boy! Amperex Bugle Boy tubes are burned in under full load with all voltages applied for 24 hours before being tested for noise & microphonics. The aging racks used are from the original Amperex production line built in Holland decades ago.

Complete test results are supplied with each tube, including plate current, screen current, filament current, and total harmonic distortion (THD). The THD measurement is performed using one of the finest spectrum analyzers available – the Hewlett Packard 3561A. Matching in pairs, quartets & octets is available for all tube types.

Special test requirements? Not a problem. For a slight additional charge we will test and match to your specified operating conditions.

Types available: 6DJ8/ECC88, 12AU7A/ECC82, 12AX7A/ECC83 and many more!

So if you haven't dealt with a source capable of meeting your demands, call us at 1-800-TUBE USA or 630-208-2200 today for information on additional products and the worldwide locations nearest to you. You'll like what you hear!

APD is pleased to announce
the addition of Hammond
Manufacturing's entire product
line, including Classic
Transformers and Enclosures.
Call today for a Hammond catalog
or down load it from our website at
www.rell.com/edg/hammond.html.



 **Richardson
Electronics**
Engineered Solutions

APD **Audio Product Division**
a division of Richardson Electronics, Ltd.

40W267 Keslinger Road • P.O. Box 393 • LaFox, IL 60147-0393
(630) 208-2200 (800) 882-3872

For more information visit our on-line catalog at catalog.rell.com

SINGLE ENDED PUSH PULL ACRO SOUND PEERLESS COPPER WINDINGS SILVER WINDINGS HAND WOUND

Peerless transformers go surprisingly low.

\$99, for example.

Surprised? The low price is shocking, but it's the sound that's electrifying. Because all Peerless transformers are made from premium materials with expert craftsmanship, and based on proven, well-balanced designs. So if you want the best inexpensive transformer, or just the best, you'll get a Peerless. For a sound that's peer-less.

MagneQuest

HANDBUILT TO PERFORM WITHOUT EQUAL

MAGNEQUEST, 1404 E. BRISTOL ST PHIL., PA. 19124
<http://www.MagneQuest.com>

SINGLE ENDED PUSH PULL ACRO SOUND PEERLESS COPPER WINDINGS SILVER WINDINGS HAND WOUND

AFFORDABLE HAND-WIRED GUITAR AMP KITS!



Based on blackface era amps from the mid 60s, these all-tube guitar amps feature 3-knob reverb control, tube rectifier, solid-pine jointed cabinets, bias setting jacks, master volume control, heavy aluminum chassis, cloth covered wiring, full size potentiometers, vintage style tube sockets, 40W 2x6L6 output, carbon composition resistors, Mallory tone capacitors and many other top features.



ALLEN
 AMPLIFICATION
 Quality tube amps,
 kits and parts

Phone: (606) 485-6423

Fax: (606) 485-6424

E-Mail: tonesavor@fuse.net

www.guitar.com/allen



one electron™

Single-Ended Output Transformers
 High Quality for a Reasonable Price
 Designed and Built in the USA

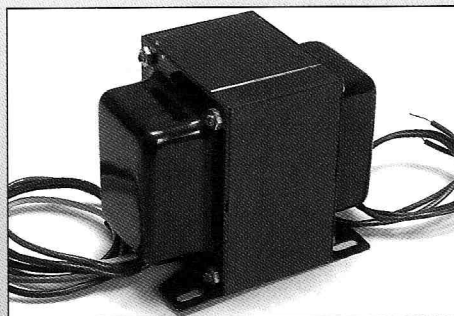

UBT-1 Designed for parallel operation of:
 1.6k primary
 15 watts
 160 mA **\$99.00** 2A3s, EL34s, 300Bs 6AS7s,
 etc. or Sweep-tube in
 "enhanced triode" mode

UBT-2
 4.8k primary
 15 watts
 110 mA **\$119.00** Can be used with:
 300B, 50, SV811-3, etc.

UBT-3
 3k primary
 15 watts
 110 mA **\$119.00** Good for single ended
 2A3 or 300B

Quantity discounts available

ANTIQUE ELECTRONIC SUPPLY™
LIMITED PARTNERSHIP

6221 S. Maple Ave. • Tempe, AZ • 85283

Phone (480) 820-5411 • FAX (480) 820-4643 or 800 706-6789

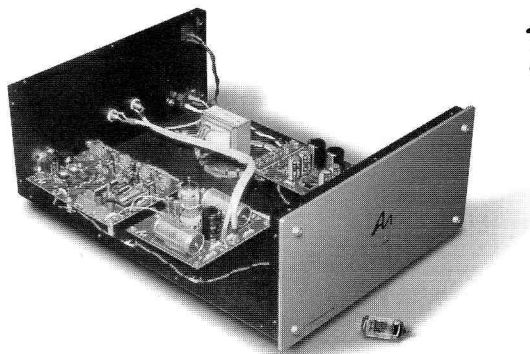

An amazing tube output
DAC kit that's actually affordable.
And also, the big Zero.

The new Audio Note DAC Kit 1.1

You'll be blown away by the quality of sound achieved from your CDs... we were, and at \$799.00 US this tubed output stage, one time oversampling DAC is truly an exceptional value.

The new Audio Note Zero Speaker

It's a 93 dB quasi quarter wave horn... this two way is musical. It packs a lot of punch and holds a great pace, an all out deal at \$899.00 US a pair. You'll find it a great match for the Audio Note Kit 1 amplifier.



Audio Note North America

1030 Kamato Road, Unit 19, Mississauga, Ontario, Canada L4W 4B6

Voice: 1.888.523.3359 905.624.6354 Facsimile: 905.624.1868

E-mail: audionote@idirect.com Web: www.audionote.on.ca

Call Mike at 1.888.523.3359 or visit our website for more information. Mike makes your audio day.

thetubestore.com

Your online source for name brand audio tubes

Enjoy the convenience of purchasing audio tubes at our secure online webstore. We stock a wide range of products including Ei, Tesla/JJ, Svetlana, Sovtek, Sino, and JAN.

Competitive prices and fast service.

Check out the selection at thetubestore.com

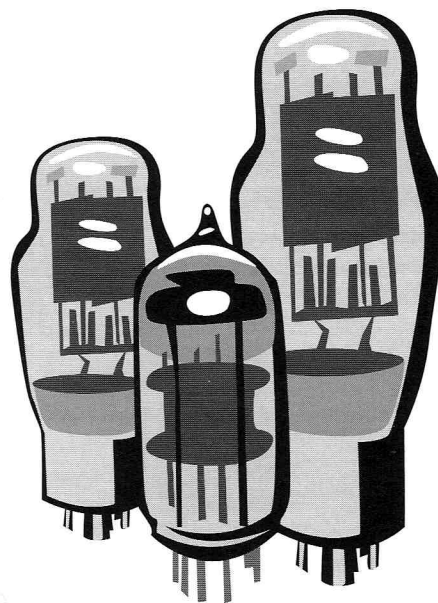

Moth Audio Corporation

Introducing The New S12A3

Same Great Sound as the S2A3
But now with 3 Input Selector Switch



323 HOllwood 7-4300

Call now or visit us on the web at www.mothaudio.com

ELECTRA-PRINT AUDIO

Quality Handwound S.E. Output Transformers

- Primaries from 1.8K to 10K
- Exclusive wideband design
- Line Stage with Headphone Out
- Single Plate to PP Grids

Custom-Built Power Transformers / Chokes

- Wound to your requirements
- Heavy-duty design for Class A use
- DC Filament Supply Windings
- HV chokes to 15H, 300ma
- Low voltage, high current filament chokes

Component Pricing and Specifications
Catalog Available



ELECTRA-PRINT AUDIO

4117 Roxanne Drive
Las Vegas, NV 89108

702-396-4909 FAX 702-396-4910



Stand Out in a Crowd! Super cool 6L6 gig shirt for electric guitarists or sure-fire attention-getter for tube enthusiasts. Huge full-chest 12" x 15" 1950s style image with giant 6L6GC taking off. Available in either White Image on Black shirt or Black Image on Lt. Gray shirt XL only. Only **\$16.95** each

New! VTV Tube Head Baseball Cap 100% cotton, one size fits all (adjustable band) Navy Blue Only **\$18.00** each
Shipping and Handling \$5.00 US, \$6.00 Canada, \$10.00 Europe, \$12 Asia and World

California Residents add 7.25% State Sales Tax

**Vacuum Tube Valley, P.O. Box 1499,
Lakeport, CA 95453 USA FAX 707-263-7648
www.vacuumtube.com**

ATLAS **NIKE HERCULES** **BOMARC**

BLAST OFF
with vacuum-tube
synthesizers
by **METASONIX**

TITAN 801 Woodside Rd, Suite 14-247, Redwood City CA 94061
www.metasonix.com

©1999 Metasonix. All rights reserved.

VACUUM TUBE VALLEY

Back Issues, Books, Goodies, & Subscriptions



VTV #1 Spring 1995 \$8

Vintage Dynaco Tube Equipment - 1955-77
History and Testing of the 12AX7/ECC83 dual triode
Tube Testing Methods + Early Amplification and Amps

VTV #2 Fall 1995 \$12

Heathkit - The Tube Williamson Years 1950-61
EL34/6CA7 History, Types and Tests
Magnum SE EL509 Amplifier Project by Dave Wolze
1927-34 Western Electric Theater Sound Systems

VTV #3 Winter 1995/96 \$12

Eico Mono Tube Gear - 1955-62
Altec Lansing 604 Coaxial Loudspeaker History
Western Electric 300B History and Listening Tests
300B SE Transformer Listening Tests

VTV #4 Spring 1996 \$12

6L6 History, Types and Listening Tests
Vintage Bookshelf Speakers 1955-1965
Early FM Broadcasting History
HK Citation I & II Amplifier History and Mods

VTV #5 Fall 1996 \$12

The Ultimate FM Tuner Shoot Out
Red Bank Guided Missile Tubes for Hi-Fi
The Birth of the Marantz 10B
Choosing Rectifier Tubes for your Guitar Amplifier

VTV #6 Winter 1997 \$12

Fisher 500 - History, Models and Restoration
A Tribute to Avery Fisher by the Fisher Doctor
6550 and KT88 History, Types and Listening Tests
Loftin-White Amplifier History by Alan Douglas

VTV #7 Summer 1997 \$12

6DJ8 & Frame Grid Tubes + Listening Tests
Altec 1950s Theater Amps and Modifications
The Great Voice - The Peter Jensen Story
Computing with Tubes - The Savage Art
Uncle Eric's Tube Dumpster - 417A/5842

VTV #8 Fall 1997 \$12

EL84 History, Types & Listening Tests
RCA Tube Mfg at Harrison, New Jersey
200 watt OTL Amp Project by Allan Kimmel
300B Listening Tests: NOS and Vintage Types
Bruce Moore Tube Audio Pioneer

Vintage Hi-Fi Spotter's Guide-Volume 1

Over 450 photos & specifications of tube audio gear
from the Golden Age of Hi Fi. 86 pp. \$18.95

Vintage Hi-Fi Spotter's Guide Volume 2

Volume 2 covers equipment not listed in Volume 1.
Almost 500 amps, preamps, tuners, etc are depicted.
Edition covers early audio and includes a Speaker section
with most vintage manufacturers. 88 pp. \$18.95

Vintage Hi-Fi and Audio Price Guide 2000-2001

Updated price & grading guide for almost 1,000 vintage
hi fi amps, preamps and tuners. Includes Vintage pro
audio and theater gear. Also, pro loudspeakers, N.O.S.
vacuum tubes and audio transformers. \$20.00

"Vintage Hi-Fi The Golden Era Video"

A one-of-a kind video covering the classic post-war and
1950s home hi fi era. Over 80 classic audio amps, pre-
amps tuners, are shown. This video is professionally pro-
duced. 34 min VHS NTSC \$20.00

The Ultimate Tube Substitution Guide

No tube electronics enthusiast should be without this
book. Over 10,000 tubes are listed on 240 pages includ-
ing: audio, radio, transmitting, and special. Features an
audio tube section with tube evaluation. \$29.95



Vacuum Tube Valley T-Shirts

Two Styles to Choose From! 100% Cotton USA

A) 6L6 MUSIC POWER

Large logo available in black or grey \$16.95 XL only

B) VTV Tube Sunburst Logo with 2-color black & orange
on front with large 2-color RCA tube diagram view on back.
(Available in gray) \$20.00 L or XL, \$24.00 XXL

C) VTV Tube Head Cap - High quality dark navy cap with sil-
ver embroidered "Tube Head" on front. "Vacuum Tube Valley"
stitched on back. Velcro size adjustment, 100% Cotton \$18.00



VTV #9 Spring 1998 -Transmitting

Tube Review, Ampeg SVT Guitar Amp,
Altec 287W amp, Bargain Vintage Hi-Fi
\$12

VTV#10 Summer/Fall 1998

Story of the 6V6, Hi-Fi radio in the 30s,
PP SV572 amp, Ultrathin Line Stage
\$12

ORDER FORM

Name _____ Date _____

Address _____

City _____ State _____ Zip _____

Please Send Me The Following Products

_____ \$ _____

_____ \$ _____

_____ \$ _____

_____ \$ _____

_____ \$ _____

_____ \$ _____

_____ \$ _____

_____ \$ _____

_____ \$ _____

Add \$5.00 Shipping per order in USA / Add \$10.00- Per Item Foreign Air Shipping

CA Residents Add 7.25% State Sales Tax

(CA Tax)

Credit Cards, U.S. Bank Checks or Money Orders OK

Credit Card # _____

Signature _____

TOTAL ORDER

Exp. Date _____

Subscribe To Vacuum Tube Valley The Classic Electronics Journal

\$45/year US First Class \$48/Canada,
\$56/Europe & \$66/Asia & World

VACUUM TUBE VALLEY

P.O. Box 1499

Lakeport, CA 95453 USA

Phone (707) 263-5881 FAX (707) 263-7648

email - triode@vacuumtube.com

www.vacuumtube.com

www.AudioWeb.com

The Largest Hi-Fi Site on the Internet

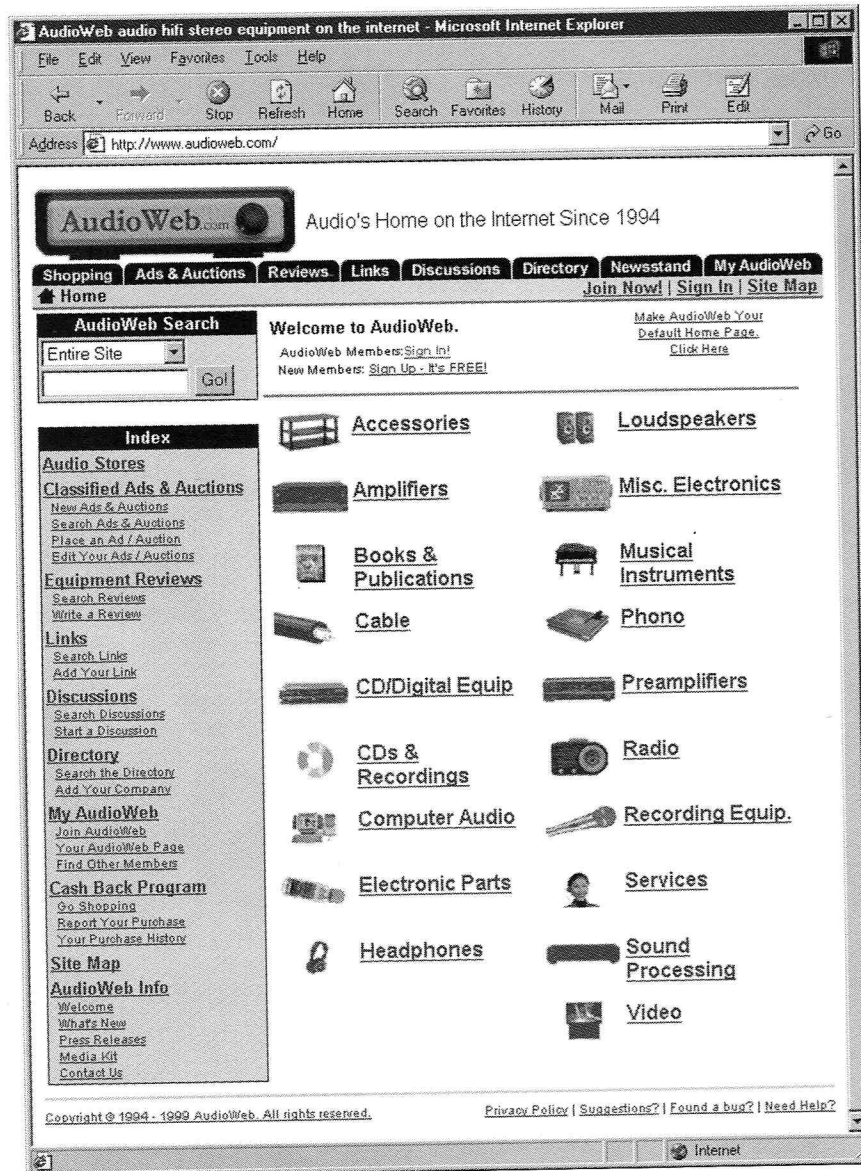

Shopping • Reviews • Classified Ads • Auctions
Links • Directory • Discussions • Newsstand

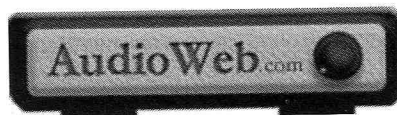

Audio's Home on the Internet Since 1994

AudioWeb.com, PO Box 303, Berkeley Heights, NJ 07922, 908 464-7307, 908 464-0271 (fax), info@audioweb.com

Purveyors of "Classic" Transformers & Enclosures

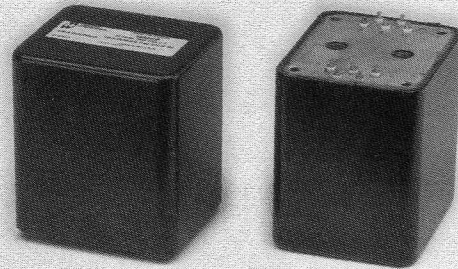
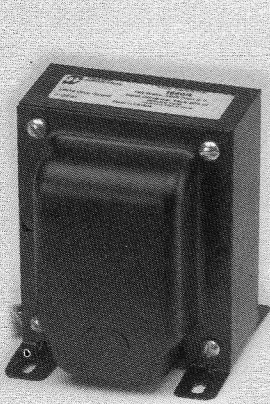

*Single Ended, Push-Pull
and Potted Tube Output
Transformers*

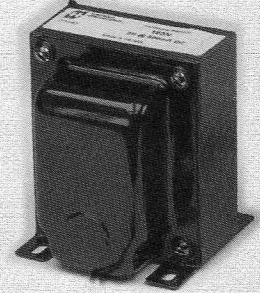

Filter Chokes

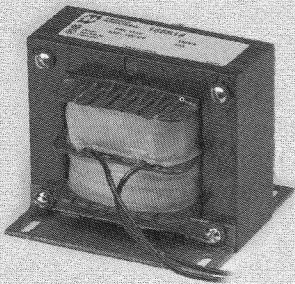

*Open & Enclosed
Filament Transformers*

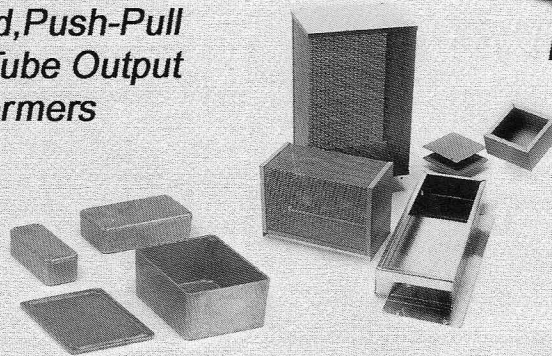

*Aluminum & Steel Chassis
and Diecast Aluminum
Enclosures*



*High Voltage Plate
Transformers*

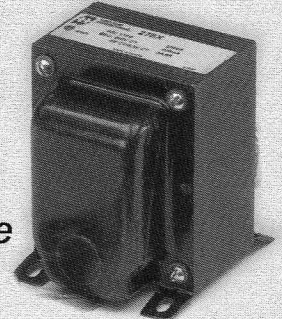

Contact us for a free catalog & list of stocking distributors

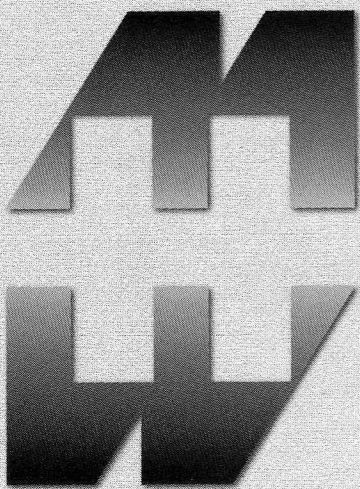

HAMMOND MANUFACTURING™

4700 Genesee St. - Cheektowaga, NY 14225 USA
Phone: (716) 631-5700 Fax: (716) 631-1156
394 Edinburgh Rd., N. - Guelph, Ontario N1H 1E5 Canada
Phone: (519) 822-2960 Fax: (519) 822-0715

www.hammondmfg.com

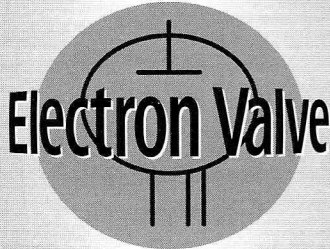

Your source for hard to find
Vintage Audio Tubes
and Quality Vacuum Tube
Audio Components

Stop by our website to see a detailed look at all of our products!
www.electron-valve.com • Email: info@electron-valve.com
Phone: 901-274-8823 • Fax: 901-274-0499
Toll Free: 1-888-909-8823

We are a proud dealer of **Western Electric** Audio Products.
The current production 300B is now in stock.



Electron Valve stocks a wide array of
NOS Vintage Audio Tubes like Mullard
EL34, RCA 2A3, and Mullard 5AR4. We also
have a good stock of Old Production
Western Electric tubes such as

205B/D, 252A, 274B, 300B and many others.

Electron Valve carries Precision Tested Ram Labs
Reference Tubes. These tubes are computer tested, graded and
matched to ultra high specifications predetermined by Roger A.
Modjeski.



We also carry the Music Reference **MR** RM-10 (Push-Pull
6BQ5, 35W/Side) Stereo Amplifier and the
Music Reference RM-200 (Push-Pull 6550,
100W/Side) Stereo Amplifier.

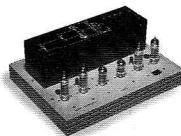

<http://www.triodeel.com>

Check out our site for...

...OEM tube data, schematics, links to nearly 200 tube
related sites all over the net, plus lots more
...World famous Dynaco upgrade boards, simple & effective
...Magnequest replacement transformers for Dynaco(tm)
...Upgrade chassis for ST70, complete & partial kits
...Tubes: JJ/Tesla, Svetlana, Sovtek, Philips, NOS
...capacitors, resistors and a potpourri of useful stuff
...more to come...new EZ-Build modules, (cheap hi-end
for everyone!), new paper capacitors, & the list goes on..

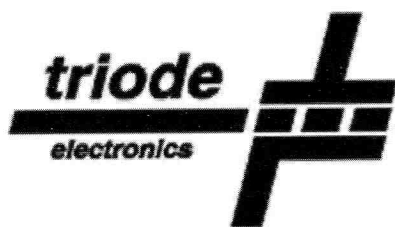

triode electronics

2225 W Roscoe St, Chicago, IL USA Ph 773-871-7459
Fax 773-871-7938 Office hours 12:30-8:00 CT M/F
(or until we get tired or thirsty)
Email us at postmaster@triodeel.com
"Worldwide Service, Neighborhood Prices"

The Shape of Great Sound

Svetlana Audio Tubes ignite music with a richness and clarity only achieved with the best in vacuum tube technology. At Svetlana, we start with quality materials, then add precision and careful testing. The resulting sound is rich, full and powerful. So your amplifier gives its best performance. Svetlana Audio Tubes are shaping the way you hear music.

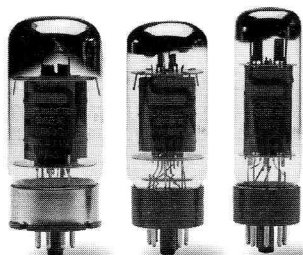
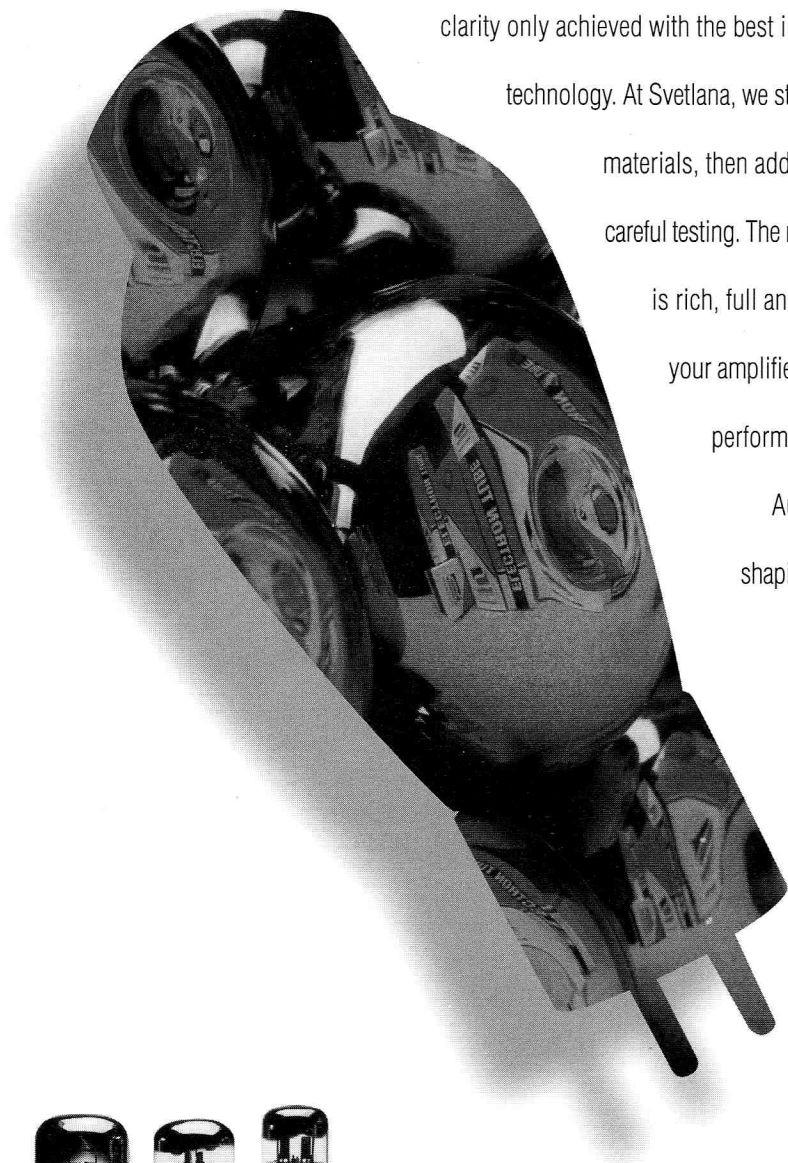

Svetlana
ELECTRON DEVICES

www.svetlana.com



Headquarters: 8200 S. Memorial Parkway
Engineering & Marketing: 3000 Alpine Road

Huntsville, AL 35802
Portola Valley, CA 94028

Phone: 256-882-1344 Fax: 256-880-8077
Phone: 650-233-0429 Fax: 650-233-0439

ASUSA

A2

10 Watt Stereo Amplifier

219E

CAS Speakers

10 Watts RMS/channel
Tube Rectified (5V4G)
2x6EA8, 4xEL-84
Point to Point Wiring
Low Noise
High Quality Parts
Superb Sound Quality

Sensitivity: 91.5db (1W at 1 Meter)
Max. Power RMS: 60 Watts
Dimensions: 16"H, 10"W, 7.25"D
Light Oak or Black Oak Finish

Complete quality kit audio system for
\$749 or fully assembled for \$939.
Includes speakers, amp, and cables.



6717 NE 181st St. Kenmore, WA 98028
1-877-480-8866 or 425-485-3836

E-mail: asusa@earthlink.net Website: as-usa.com

VTV Pro-Tube Shop

Legendary Tube Knowledge and Performance

P.O. Box , Lakeport, CA 95453 USA

Phone (707) 263-5881 (707) 263-7648- FAX www.vacuumtube.com

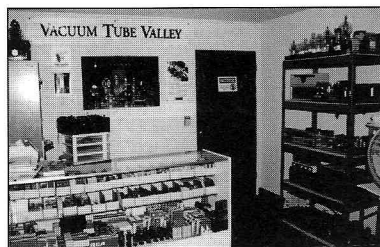
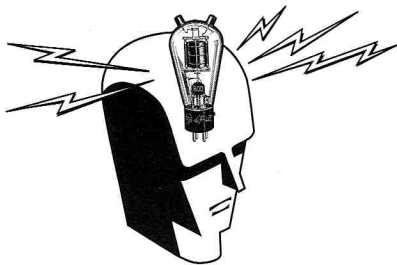

Order: By email, FAX, Mail, Phone
Minimum Shipping and Handling per order:
 US \$5.00, Canada \$10, Europe \$20, Asia \$25 (Heavier items will require additional postage)
\$35 Minimum Order

Vintage Hi-Fi Rebuild Kits Get Great Sound & Save Bucks!

All kits include all new ICMWR signal and bypass film caps, under-chassis electrolytics, 1 watt metal oxide low-noise plate resistors, new silicon power supply diodes and schematic. **Kits do not include FP can-type electrolytics.**

- Dynaco PAS2/3 \$50
- Dynaco Mark III, Mark IV \$40 (for pair)
- Dynaco SCA-35, Dynaco ST-70 \$30
- EICO HF35, 50, 60 \$30 ea
- EICO ST70 \$60
- EICO HF86 \$35
- EICO HF87, HF89 \$60
- Fisher X-100, KX100, KX200 \$55
- Fisher X-101, X-202, X-202B, C \$65
- Fisher 400 Receiver \$65
- Fisher 500C, 800B, 800C Receiver \$65
- Fisher SA-100 \$50, SA-300 \$85
- Heath W-2,3,4M \$35 ea W-5M \$45 ea
- Heath SP-2 \$65
- McIntosh C-20, C-11, C-22 \$100
- McIntosh MC30, MC40, MC75 \$45 ea
- McIntosh MC60 \$50 ea
- McIntosh MC225, 240 \$65
- McIntosh MC275 \$75
- Scott 130 \$80
- Scott 222, 222B, 222C, D \$65
- Scott 299, 299B, 299C, D \$65

Illinois Capacitors

ICMWR Metallized Polyester (630Vdc rating)

0.001uf	\$0.80 ea
0.002uf	\$0.80 ea
0.0047uf	\$0.80 ea
0.0068uf	\$0.80 ea
0.01uf	\$0.90 ea
0.022uf	\$0.90 ea
0.047uf	\$1.00 ea
0.068uf	\$1.20 ea
0.1uf	\$1.30 ea
0.22uf	\$1.60 ea
0.47uf	\$2.20 ea
1.0 uf (400V)	\$2.50 ea
2.2uf (250V)	\$2.75 ea
3.3uf (250V)	\$3.20 ea
4.7 uf (250V)	\$3.80ea
6.8uf (250V)	\$4.20 ea

Ultra-Tone Silvered Foil in Paper and Oil Capacitors

Laser etched silvered foil in high-quality kraft paper in non-toxic mineral oil, sealed in epoxy. (650Vdc)

0.01uf	\$13.20 ea
0.02uf	\$15.40 ea
0.05uf	\$17.60 ea
0.1uf	\$20.90 ea
0.22uf	\$30.80 ea
0.47uf	\$44.00 ea
1.0uf	\$76.00 ea
2.0uf	\$110.00 ea

NEW Ultra Crossover Caps! Solid Silver Leadouts!

1uf@200V	\$45 ea
2uf@200V	\$70 ea
3uf@300V	\$95 ea
5uf@300V	\$145 ea
10@300V	\$195 ea

*Ultra-Tone Silver capacitors are superb performers. Our customers tell us these are the **smoothest, best-sounding and most musical** capacitors available.*

Ultra-Tone Polypropylene Film & Foil Power Supply Capacitors (Not Silver Foil)

20uf @ 650V	\$22.00 ea
50uf @650V	\$45.00 ea
100 uf @650V	\$60.00 ea

Illinois Axial Electrolytic Capacitors

Great Value and very dependable.

3.3uf @350V	\$1.20 ea
4.7uf @350V	\$1.45 ea
10uf @450V	\$1.60 ea
22uf @250V	\$1.95 ea
22uf @450V	\$2.25 ea
22uf @500V	\$2.85 ea
47uf @35V	\$1.50 ea
47uf @350V	\$2.50 ea
47uf @450V	\$3.45 ea
100uf @160V	\$2.95 ea
100uf @350V	\$3.90 ea
100uf @450V	\$4.90 ea
1000uf @25V	\$1.75 ea
2200uf @35V	\$2.75 ea

Hovland MusiCaps Polypropylene Foil and Film

High resolution, great-sounding film caps perfect for all types of audio equipment upgrades.

0.01uf @1600V	\$9.79 ea
0.022uf@1000V	\$9.82 ea
0.033uf @600V	\$8.01 ea
0.047uf @1KV	\$12.05 ea
0.1uf @600V	\$11.52 ea
0.22uf @600V	\$14.55 ea
0.47uf @400V	\$12.80 ea
0.47uf @600V	\$21.71 ea
1.00uf @400V	\$21.66 ea
2.2uf @200V	\$23.83 ea
3.0uf @200V	\$28.45 ea

Note: Only the above Hovland values in stock.

Tube Sockets

Octal Ceramic Chassis	\$3.50
Octal Ceramic PC mt	\$3.00
Octal NOS Phenolic	\$3.50
9 Pin Ceramic PC	\$2.50
9 Pin Ceramic Chassis	\$3.00
9 Pin Ceramic GOLD	\$5.00
9 Pin Plastic w/shield	\$4.00
9 Pin NOS Brn Phenolic	\$3.00

Order Fast from our on-line catalog
www.vacuumtube.com

Can Electrolytic Capacitors

20,20,20,20 @475V

(Mallory type) \$29.00

50+50uf @500V LCR w/clamp \$21.50

100,100uf @500V

LCR w/clamp \$28.00

40,20,20,20uf @500V,

LCR w/clamp

\$32.00

D.H.Labs Silver

Sonic Wire

*Rated as the **best sounding wire for the money by several audio publications.***

Silver Sonic T-14

Speaker Wire \$4.00/ft

Silver Sonic BL-1 High

Definition Interconnect

Wire \$3.50/ft

Silver Sonic OFH-20

High Performance

Silver/Teflon Chassis Wire

\$0.95/ft

RCA-2 Gold Tiffany-

Style Interconnect Plug

\$10.95ea

B-1C Gold Banana Plug

and Insulator \$5.50/pr

BSP Gold Mini Spade

Speaker Terminals for

Vintage Hi-Fi \$1.10 ea

1 Meter BL-1 Factory

Terminated \$99

10 foot T-14 Factory

Terminated \$119

FREDS (Fast Recovery Diodes)

IXYS 600V 8A \$3.00 ea

IXYS 1200V 11A \$6.00 ea

60V 5 Amp Schottky \$1.50 ea

AMEX, VISA, MC OK

More Than Just Tubes

If You're Looking for that Special Mix of New and Vintage Components for a Special Project, There's a Good Chance We have Everything You Need under One Roof.

Tubes • Transformers
Capacitors • Resistors
Books • Videos • Knobs
Grill Cloth • Chokes
Filament Transformers
Tube Sockets • Project
Chassis • Soldering Tools
Switches • Speakers
Decals • Rebuild Kits
Replacement Dials • Test
Equipment • Meters
Spotters Guides
Reproduction Manuals
Paint • Tuning Capacitors
Hats • Shirts

More Hardware
Than You Would Believe

Phone (480) 820-5411 FAX (480) 820-4643 or (800) 706-6789

Visit our website at www.tubesandmore.com

ANTIQUE
ELECTRONIC
SUPPLY®

ELECTRON TUBE

Svetlana

RCA
Transmitting
Tubes

SYLVANIA
RADIO TUBE