

VACUUM TUBE VALLEY

TM

Issue 15

The Classic Electronics Reference Journal

Price \$10.95

The 45 Triode

Part No. 500 7.30 (N6272) RCA Radiotron Company, Inc. HARRISON, N. J. STANDARDIZING DEPT.

PAGE No. 3
DATE Jan. 10, '31

No. 3-1-245

David Hafler Interview

The Dynaco Years

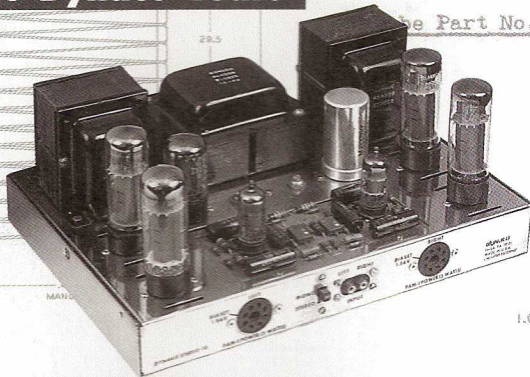

Assemblage SET-300B

A VTV Kit Review

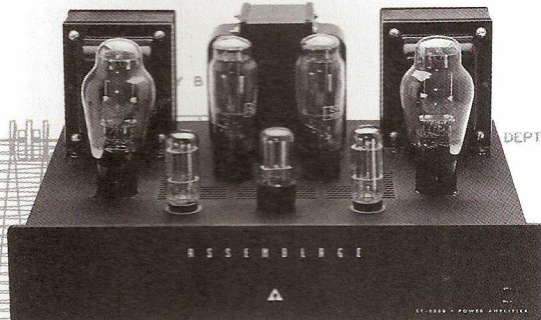

RF-Powered Parallel Feed

A High Performance Experimental Amp

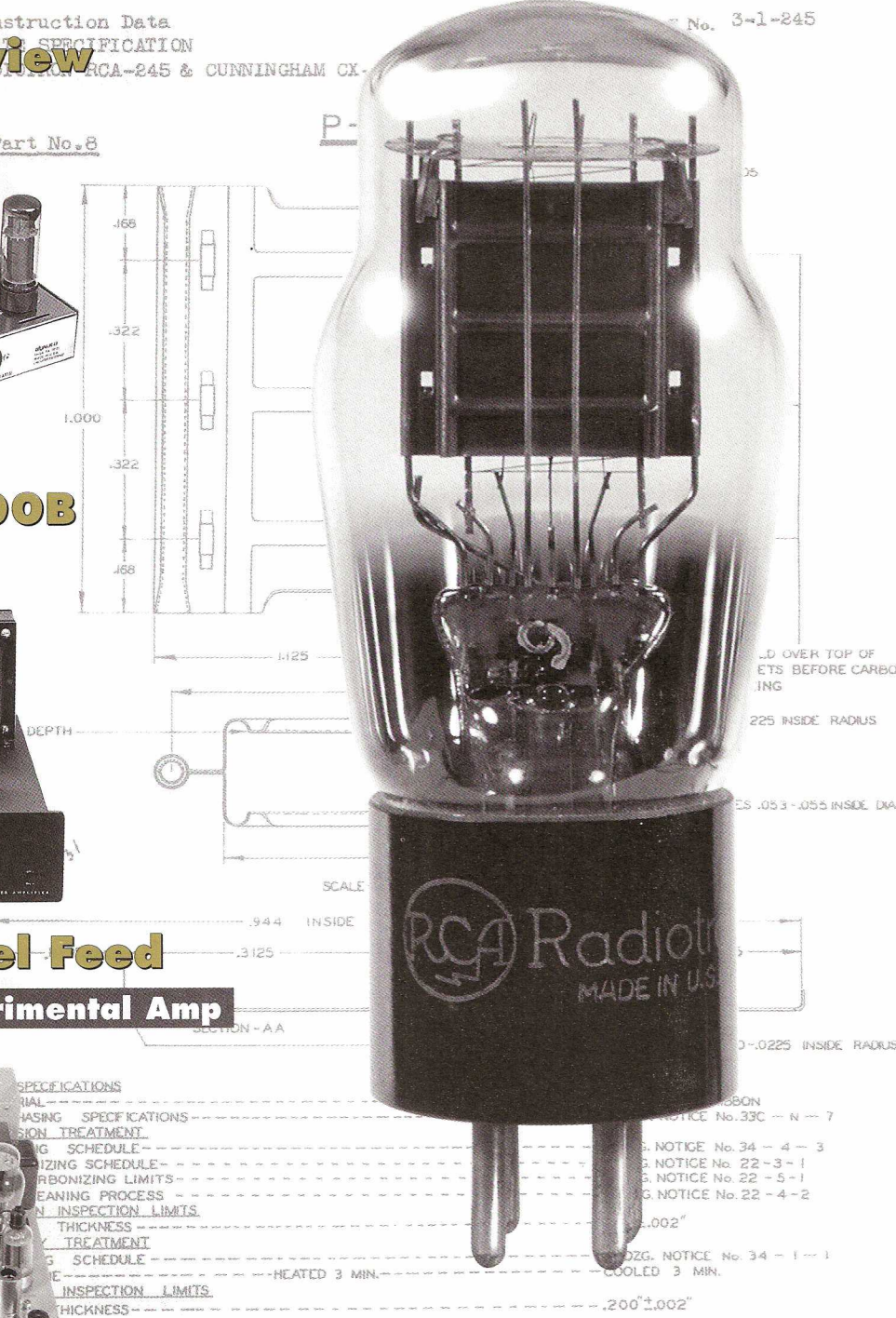
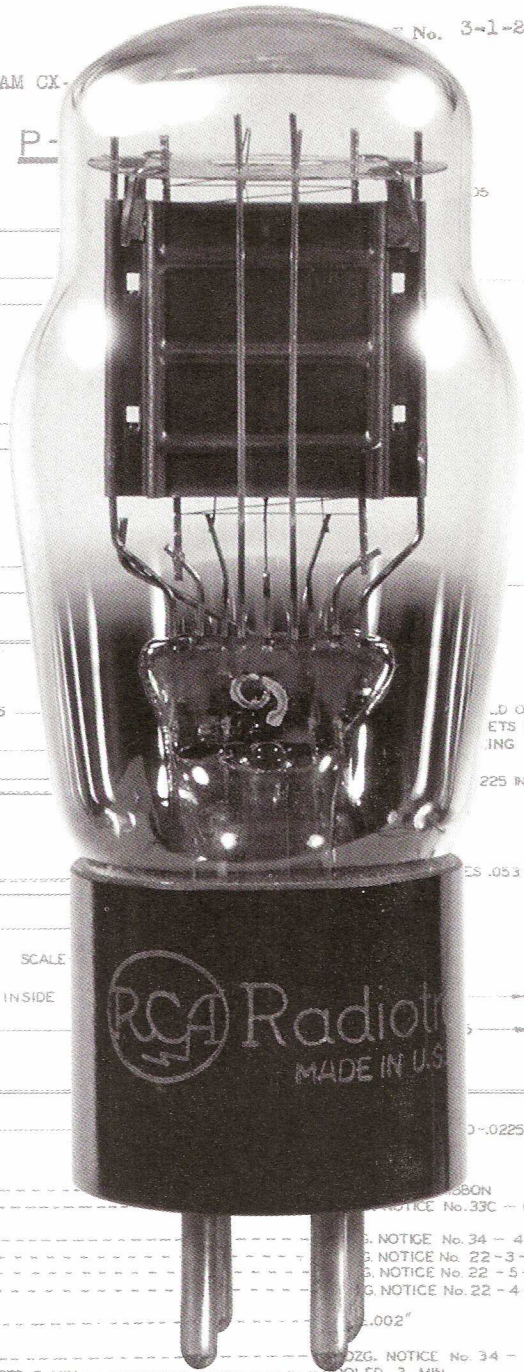
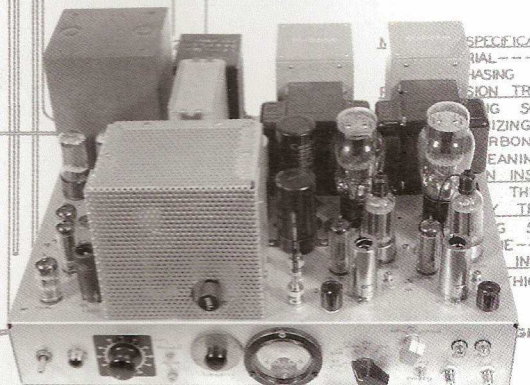

Visit us on the web
www.vacuumtube.com

VACUUM TUBE VALLEY

P.O. Box 691, Belmont, CA 94002 USA
(650) 631-6550 Phone - (650) 654-2065 FAX
<http://www.vacuumtube.com>

October 4, 1999

Mike Matthews
New Sensor Corporation
20 Cooper Square
New York City, NY 10003

Greetings Mike,

We finally got a chance to evaluate your new Electro Harmonix EL34 last week. Judging from electrical tests using the tube curve-tracer, your new EL34 is a significant improvement over the original Sovtek EL34. It was very stable and linear when operated within the typical EL34 range of about 40 mA and less than 525 volts on the plates. Physically, the tube appears well-made with tight internal plate bracing for reduced microphonics. The getter material is silver-black colored, similar to the original Mullard tubes.

Several local audio enthusiasts listened to the matched quad of Electro Harmonix EL34s you sent us using a restored vintage Dynaco Stereo 70 amp and an ASUSA-Kit A-4 amplifier. To our ears, your new EL34 comes very close to the sonics of a Mullard EL34 from the 1960s. The Electro Harmonix tube is musically balanced throughout the entire music spectrum. Bass goes deep and is tight, mids are sweet and well-defined and highs are detailed and extended. This EL34 should be dependable and sound great in most new and vintage hi-fi amplifiers.

The Electro Harmonix EL34 is a well-engineered tube at a competitive price. This tube offers us yet another quality choice in the EL34 market. It is refreshing to see that New Sensor is spending the time and money to improve their audio tubes instead of simply relying on existing designs.

Mike, thanks again for keeping the audio vacuum tube market alive and well!

Best Regards,

Vacuum Tube Valley

Charlie Kittleson
Publisher



electro-harmonix EL34EH

www.ehx.com

(212) 529-0466 FAX (212) 529-0486

**VTV Issue # 15
Table of Contents:**

The 45 Triode 4
Eight 45s Amp Project..... 8
Assemblage SET 300B..... 11
Tube Dumpster: 9 Pin..... 12
Tube Testers Book Review.. 14
RF Powered Amplifier..... 16
David Hafler-Dynaco..... 21
Computing with Tubes..... 32
12AX7 Hi Fi Shoot Out..... 33
Advertisers..... 36

**Coming In the Next
Issue of VTV:**

- **EL34 History & Tests**
- **Dumpster Tube: Vertical Sweep Triodes**
- **Budget Interconnect Cable Review**
- **Tube Headphone Amp Project**

Correction:
 Issue #13 P. 14. John "Sabatello" should have been spelled "Cevetello."

Vintage Tube Dynaco Archive CD

Finally, there is an excellent resource CD covering Dynaco tube hi-fi gear! This well-researched archive contains most Dynaco schematics, early catalogs, specifications, reviews, Acrosound information, photos, restoration tips, and more! You must have a fairly modern computer with Adobe Acrobat Reader installed. (Free download from the Web). The cost for the CD ROM is \$24.95 plus \$3.20 shipping in USA. For more information and to order, go to: www.the-planet.org.

First WATTS Meeting A Success

The first meeting of Western Amplification and Tube Technology Society (WATTS) was held on October 15, 2000 in Santa Rosa, California. Over 35 tube enthusiasts attended the meeting. Presentations included a shoot out of tube versus solid-state sound, Kara Chafee demonstrated the De Havilland Aries SE 572 amp, a "State of the Tube Business" debate with Eric Barbour, a live music demonstration using various Weber VST speakers, two guitar amp OEMs demonstrated their amps and a clinic for hi-fi amps.

Sidney Stockton Smith Passes

Sid Smith, design engineer for RadioCraftsmen and Marantz, passed on October 25, 2000 at the age of 77. He was involved in the development of one of the first production Williamson amplifiers in the late 1940s for RadioCraftsmen. In 1954, he teamed up with Saul Marantz to develop the Model 1 preamp and later the Model 2 amplifier. And the rest is history. He will be remembered for his contributions to the audio field.

Sovtek Re-issues the 7591!

Sovtek has come through with a plug-in replacement for the 7591. The new tube has the same electrical characteristics as the original Sylvania and Westinghouse 7591s from the 1960s. We evaluated four samples that were sent to us for evaluation this fall and they tested just like an NOS 7591 in our Hickcock 6000A tube tester. We also installed them in a McIntosh MC225 amplifier and they worked perfectly and sounded great.

The Sovtek 7591 is not just a re-based 5881, but a reverse-engineered 7591. Internal changes include tighter grid wire pitch, superior plate materials and other improvements.



Sovtek 7591

The gain is very similar to a real 7591. Note that the Sovtek 7591 is larger in physical size than a US-made 7591. Sovtek dimensions are 3.25 inches tall by 1.375 inches wide compared to the typical size of a US-made 7591 of 2.75 inches

tall by 1.125 inches wide. In some receivers and integrated amplifiers such as the Fisher 500C or Sherwoods, the Sovtek 7591 may be a tight fit. Sovtek tells us that their new 7591 will be available for shipment in early 2001.

For more information contact Sovtek: Phone (212) 529-0466; FAX (212) 529-0486; www.ehx.com

EDITORIAL STAFF

- Charles Kittleson** - Editor in Chief
- John Atwood** - Technical Editor
- Eric Barbour** - Senior Editor
- Ron Veil** - Guitar Amp Tech Editor
- David Bardes** - Associate Editor
- Steve Parr** - Art Director
- Julie P. Werner** - Copy Editor
- Website** - www.vacuumtube.com

Vacuum Tube Valley is published quarterly for electronic enthusiasts interested in the colorful past, present and future of vacuum tube electronics.

Subscription Rate: US\$40/4 issues 3rd Class-\$49 1st Class; Canada/\$52; Asia/\$68; Europe/\$60

US Bank Check, Credit Cards or Cash are accepted for payment.

**Phone - (707) 263 - 5881
 FAX - (707) 263 - 7648**

Copyright 2000 **Vacuum Tube Valley™**
 All rights reserved.

No part of this publication may be reprinted, copied or electronically reproduced without formal written permission from the publisher.

Send circulation and editorial correspondence to:

Vacuum Tube Valley
 P.O. Box 1499,
 Lakeport, CA 95453 USA
 e-mail triode@vacuumtube.com
ISSN # 1095-4805

45: Just Enough Power

By Eric Barbour ©2000 All Rights Reserved

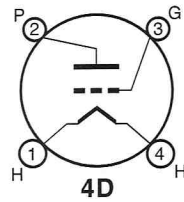

ing easier to wind). The 45's lower mu allowed its use in no-feedback circuits, similar to those used with the UX171A, while producing more power than the UX171A.

Dynamic loudspeakers came into wide use in the late 1920s, because they gave far better frequency response and lower

Intro

At Westinghouse Electric and Manufacturing Company's tube laboratory in Elmira, New York, E.D. Wilson's engineering team created the UX245 in June 1928. There was an obvious need for a triode that put out more power than the UX112A or UX171A on a typical radio plate supply, and without the high plate voltage of the UX210 or the UX250.

Using the latter tubes in SE mode meant heavy filtering of the filament supply, because their 7.5v voltage requirement increased hum in the output. So, what was needed was a directly-heated triode that used a relatively low filament voltage. Engineers working on tubes for battery radios had discovered that if the filament was AC operated, keeping the filament voltage low minimized the magnetic component of the AC hum, which interacted with magnetic metal parts in the tube. 2.5 volts was chosen as a good compromise, suited to low hum yet giving adequate temperature and emission for a power triode. Although the low distortion of the tube was well-known to engineers of the day, only in the last 20 years did users fully recognize the audio virtue of this device simply known by its later type-number, 45. Ironically, such recognition came long after manufacture of the 45 ceased.

The Design

It is a minimal structure a single W-shaped filament in a single crimped-nickel anode. The oxide coating of the filament gave enough emission for about half the plate resistance of a UX210, considering the small anode. This allowed the use of a less costly output transformer (mean-

ing easier to wind). The 45's lower mu allowed its use in no-feedback circuits, similar to those used with the UX171A, while producing more power than the UX171A.

Loose tolerances and 201-like construction made the most of existing tooling. Since the oxide filament ran cooler than the UX210's thoriated filament, the grid also ran cooler, allowing the use of molybdenum grid wire, without gold plating to prevent secondary emission. The UX-245 was very roughly similar to the earlier (and cruder) Western Electric 205D. WE never made a tube that was close in ratings to the 45.

Comparative Ratings of Pre-1930 Audio Power Triodes

Triode type	10	12A	71A	50	45
Filament volts	7.5	5.0	5.0	7.5	2.5
Filament power	9.38 W	1.25	1.25	9.38	3.75
Max. Vplate	425V	180	180	450	275
Load, ohms, SE	13K	10K	4.8K	4.6K	4.6K
Max power out	1.6w	0.285	0.79	4.6	2.0

The current reputation of RCA's tube engineering division is spotless, especially among Japanese audiophiles. Yet the irony is that Westinghouse designed and manufactured far more receiving types than RCA did—often at RCA's behest, as in the case of the UX226 and UX227. Even GE's huge Kentucky factory (Ken-Rad before 1945) was a second-runner next to Westinghouse. RCA bought many tubes from Westinghouse and rebranded them (especially before 1945).

The UX245 was made in many forms, by a variety of factories. Arcturus (type 145, in blue glass), Ken Rad, National Union, Raytheon (in their famous "4-Pillar" form), RCA, Sparton (they called it a 182), Speed, Sylvania, Triad, Tung-Sol, and others claimed internal production of their own variations of the UX245 and/or the 45 before WWII. Some manufacturers had their own unique numbers for their versions, as shown above. Cunningham labeled their RCA UX245 as CX-345, while DeForest called it a 445. The bubble or globe envelope ceased production in 1932; thereafter, all conventional 45s were in ST-14 envelopes. Like the 12AX7, so many variations existed that a complete catalogue (at this late date, anyway) would be nearly impossible to document fully.

Not many premium versions of the 45 were made. The most notorious was the VT-52, made by Tung-Sol primari-

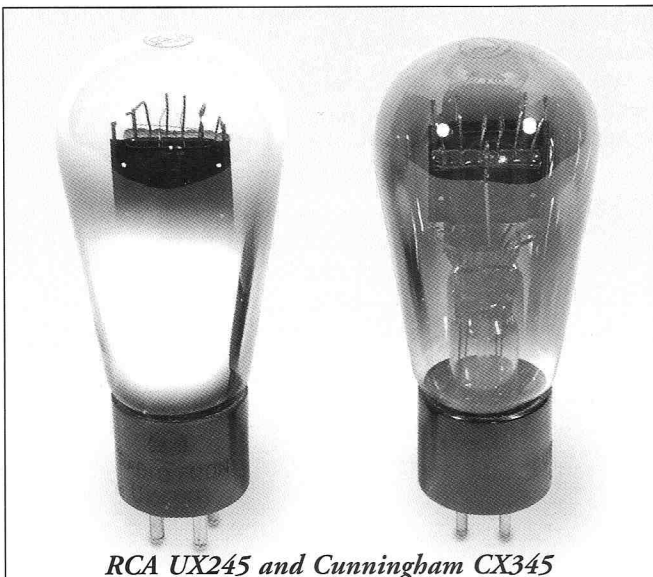

RCA UX245 and Cunningham CX345

ly for military equipment. The VT-52 has a 7.5v filament, so it was obviously intended as a 10 replacement, while making it unusable as a 45 replacement. Otherwise, a special "ruggedized" version apparently did not exist; designers preferred indirectly-heated tubes or 2A3 variations for such jobs. The Speed 295 was a type 27 and 45 in a single envelope originally designed for Loftin-White amplifier circuits in 1930s cheap table radios. No RETMA-series versions of the 45 were made after the war, as designers regarded the 45 as obsolete by then. A 45A version was made by Sylvania, using a larger ST-19 envelope, to allow cooler operation. This version was apparently sold mostly by Sears, under the Silvertone label and under the Colonial Radio brand. There was also a GT bottle 45, believed to have been made by a smaller tube company and very rarely seen today. The most amusing fact about the 45 is that it was considered very, very obsolete by 1938.

The power "inefficiency" and fragility of the 45 (as well as other filament triodes) pushed it out of the market quickly. It was widely used in commercial Public Address amplifiers and jukeboxes--until the 6L6 came along in 1936, gradually reducing the triode PA market. 45s saw use in PA amps by most of the major manufacturers, and even in amplifier kits sold by transformer companies such as Thordarson and UTC.

Before the war, the term "high fidelity" was little known to the general public. To the average radio user, a really good radio had a built-in phonograph, not necessarily a better speaker or lower distortion. Major manufacturers (such as Philco) tossed the term "high fidelity" around to refer to their upscale models, whether such radios could actually qualify or not. Yet even then, a few crazed prototype "audio bugs" were building 45 triode amplifiers and large speaker systems, and spending huge sums, as much as \$100, for a monophonic system--at a time when a new car could be had for \$400. Only around 1955 did hi-fi separates become a market of any size. Other than theater sound equipment, these prewar home audio systems have been poorly documented, a situation that VTV will work to rectify in the future.

Until recently, when fringe SE tube audiophiles noticed the high linearity of the 45, its only demand came from radio collectors needing replacements. Its more powerful RCA descendant, the 2A3, was much more complex and costly, so the latter saw much less use (and then only in some top-of-the-line radio models and PA systems). Even modern antique-radio textbooks mention the UX245 only in passing, as collectors regard it as far less important than major developmental landmarks such as the UX201A--in spite of the 45's frequent usage in 1930s radios. This included some Jackson Bell models and the Philco model 90 (in one rare version). Yet most radio designers often preferred to go for higher efficiency. Take any random AC-powered radio of around 1931, and odds are that it used a 46 or 47 for output--not a 45.

Ironically, one of the most valuable and rare early radios, the Zenith Stratosphere of 1934-38, used eight 45s in a 75 watt class AB2 (factory rated) push-pull-parallel amplifier. An odd place to use a cheap triode, when Zenith could

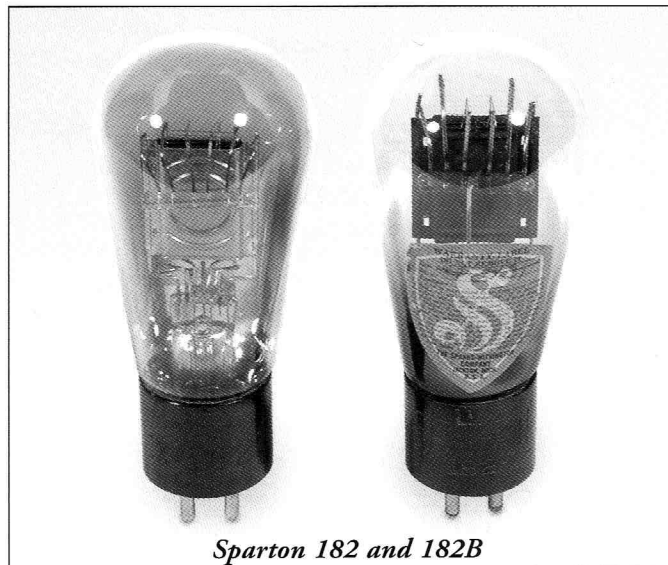

Sparton 182 and 182B

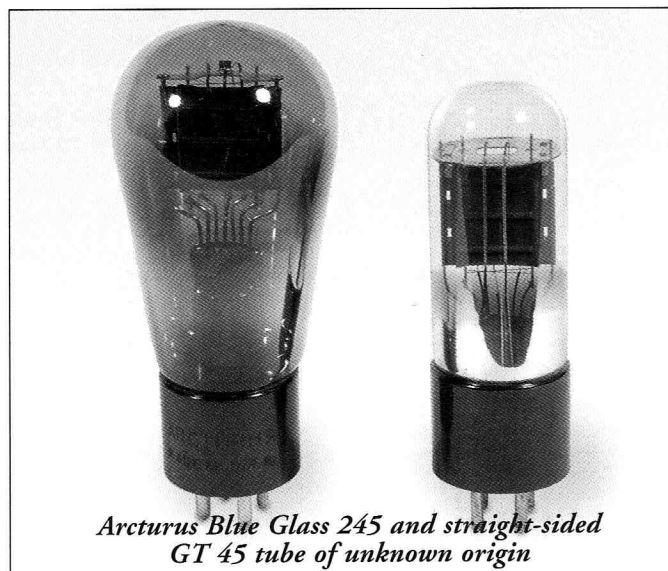

Arcturus Blue Glass 245 and straight-sided GT 45 tube of unknown origin

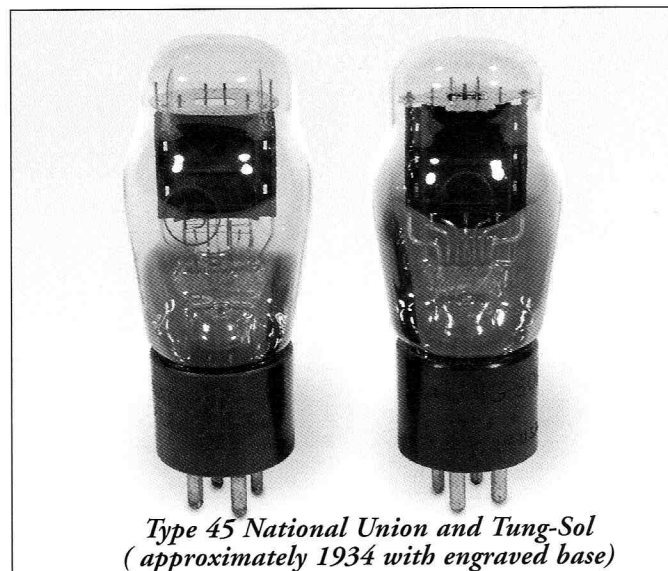

Type 45 National Union and Tung-Sol (approximately 1934 with engraved base)



Type 45

POWER AMPLIFIER

The 45 is a power-amplifier triode of the filament type capable of supplying large undistorted output in a-c operated receivers.

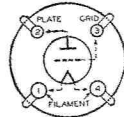

BOTTOM VIEW

CHARACTERISTICS

FILAMENT VOLTAGE (A. C. or D. C.).....	2.5	Volts
FILAMENT CURRENT.....	1.5	Amperes
GRID-PLATE CAPACITANCE.....	7	μf
GRID-FILAMENT CAPACITANCE.....	4	μf
PLATE-FILAMENT CAPACITANCE.....	3	μf
BULB (For dimensions, see Page 151, Fig. 11).....		ST-14
BASE.....		Medium 4-Pin

As Single-Tube Class A Amplifier

FILAMENT VOLTAGE (A. C.).....	2.5	Volts
PLATE VOLTAGE.....	180 250 275 max.	Volts
GRID VOLTAGE*.....	-31.5 -50 -56	Volts
PLATE CURRENT.....	31 34 36	Milliamperes
PLATE RESISTANCE.....	1650 1610 1700	Ohms
AMPLIFICATION FACTOR.....	3.5 3.5 3.5	
MUTUAL CONDUCTANCE.....	2125 2175 2050	Micromhos
LOAD RESISTANCE.....	2700 3900 4600	Ohms
SELF-BIAS RESISTOR.....	1020 1470 1550	Ohms
UNDISTORTED POWER OUTPUT.....	0.825 1.6 2.0	Watts

* Grid volts measured from mid-point of a-c operated filament. Self-bias is advisable in all cases; required if grid-coupling resistor (max. value of 1.0 megohm) is used.

As Push-Pull Class AB Amplifier (Two Tubes)

	Fixed-Bias	Self-Bias	
FILAMENT VOLTAGE (A. C.).....	2.5	2.5	Volts
PLATE VOLTAGE (Maximum).....	275	275	Volts
GRID VOLTAGE.....	-68	—	Volts
ZERO-SIGNAL PLATE CURRENT (Per tube)....	14	36	Milliamperes
MAXIMUM-SIGNAL PLATE CURRENT (Per tube)	69	45	Milliamperes
LOAD RESISTANCE (Plate-to-plate).....	3200	5060	Ohms
SELF-BIAS RESISTOR.....	—	775	Ohms
TOTAL HARMONIC DISTORTION.....	5	5	Per cent
POWER OUTPUT.....	18	12	Watts

Type 45 Specifications from 1934 RCA Tube Manual

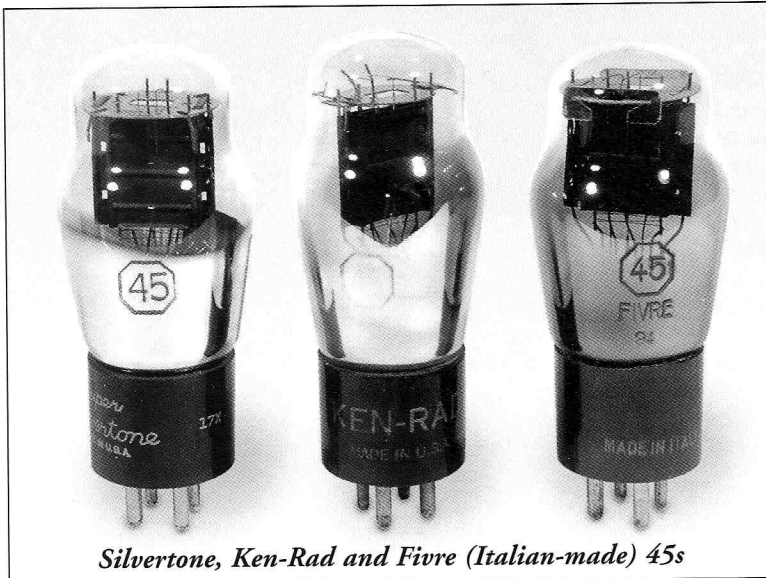

Silvertone, Ken-Rad and Fivve (Italian-made) 45s

have used more costly tubes for output in their top model. They must have known the device well, and regarded it more highly than the efficient 47. E. H. Scott came to prefer the 2A3, though their early Allwave-12 model (1929-33) used 45s. And Lincoln's Symphony (1933) used four 45s. All very costly radios from the depths of the Great Depression--all using the cheapest power triode available, with no negative feedback.

The 45 was also used occasionally in test equipment. Boonton Radio used it as the RF oscillator in their famous 160-A Q Meter, which was manufactured through the early 1950s. They had a "selected" version of the 45 for this instrument called a 102-A, but this was basically just a conventional ST-bulb 45. And amateur-radio operators were very fond of using 45s as CW transmitters, since they could be dug out of old radios and made to produce a few watts of RF using junk-box parts. 45s were so widely used as CW transmitters by poor hams that we have seen cartoons in postwar issues of QST, deriding the many remaining users of this "obsolete" device.

Millions of 45s and variants were sold, starting from 1929 until Sylvania production ceased in 1959. It is possible that some 45s were made offshore after 1959, under contract, though we have not been able to verify this. The RCA tube manual RC-19 of 1959 shows it as a "DISCONTINUED type, listed for reference only." Old stocks were plentiful thereafter due to declining demand, so it stayed available for several more years. Yet it was such a pedestrian tube, that it was often misused and even abused. We're told that some World War II military equipment used 45s as AC line fuses--the filament makes a very nice 3-amp fuse, with just the right characteristics. And Norm Braithwaite reports that his 1937 Wards Airline model 62-197 table radio uses a 45 as the output-tube bias rectifier.

Ongoing demand for 45s for radios has caused some dishonest distributors to rebrand Chinese 2A3s as 45s. This is an extremely foolish thing to do, yet it continues. If you buy a "45" from Radio Shack today, most likely they will deliver one of these mislabeled 2A3s, cheerfully provided by a dishonest contractor. Since the filament consumption of a 2A3 is almost twice that of a 45, this has caused many an elderly radio's power transformer to overheat. Please believe me: no one has made a true 45 since the early 1960s, at the very latest.

Tests

In general, 45s and single-plate 2A3s enjoy a better reputation for clean sound at low power than double-plate 2A3s. This fact has given rise to the common notion that single-plate construction has some kind of magical property. We at VTV feel

that construction quality and tolerancing have more to do with linearity than the number of plates. It's simply easier to get a linear tube if there is only one grid (in one plate structure). Double-plate 2A3s came about because of the cost and difficulty of aligning the complex "harp" filament in the early single-plate 2A3. In fact, the double-plate 2A3 strongly resembles two 45s in parallel. This problem also applied (and still does today) to the 300B. The 45 was just the right size and just the right scale for a single-plate tube. Easy to make, low cost, and reliable.

Our test of second-harmonic distortion was conducted at 300 V, 50 mA plate. Distortion and bias (grid) voltages shown, are arranged in order of increasing second-harmonic distortion. All tubes had DC filament power. *=good used, ba=bakelite base, met=metal base.

Tube sample	Distortion %	At neg grid bias
45 Syl green ink 1940s*	.082%	-34.5vdc
2A3 RCA single-plate*	.140	-58.5
2A3 Tung-Sol orange-blue box	.175	-51.7
2A3 RCA JAN 1952	.180	-52.0
UX-245 RCA bubble*	.230	-42.4
45 RCA Cunn engraved ba base*	.240	-53.0
45 RCA silver ink*	.240	-50.4
45 Cunningham silver ink 30s*	.250	-47.6
45 RCA red ink*	.260	-39.1
45 RCA/Cunn engraved ba base*	.260	-43.0
45 RCA silver ink*	.285	-47.4
CX350 Cunn bubble*	.300	-38.6
45 Syl green ink*	.315	-35.0
245 Philco/Syl bubble*	.315	-51.4
45 Syl engraved ba base*	.317	-45.6
45 National Union	.320	-52.5
45 Syl engraved ba base*	.325	-50.2
45 RCA/Cunn engraved ba base*	.350	-53.8
45 Wards/Syl engraved ba base*	.395	-51.7
275A Western Electric 1962*	.410	-71.0
UX250 RCA bubble*	.425	-29.1
275A Western Electric 1962*	.450	-90.0

Note: 205Ds are listed separately because they are not comparable to the above tubes, although they are popular in Japan in single-ended amps. These were tested at 300v, 30 mA, with 4.5vdc on filaments.

205D Western Electric engraved	.84	-16.0
205D Western Electric 1925 bakl	.87	-17.4
205D Western Electric 1925 bakl	1.27	-15.3
205D Western Electric 1923 met	1.35	-17.7

Averages

(Combined with some of the 2A3 family tests from VTV issue 11):

Tube Type	Distortion	# Samples
UX245	.273	2
45 all brands	.280	12

2A3 RCA double-plate	.373	4
2A3 Shuguang	.725	4

Comments

It is striking that the 45s did about as well as the 2A3s, even though the 2A3s are rated for much more power output. All other things being equal, one would expect distortion of the 45s to be higher.

Their plate resistance is about twice that of the 2A3s. Even so, with the same 3200-ohm load, they came out about the same. This load is a bit high for the 2A3s (in their favor) and a bit low for 45s.

I hasten to note that 50 mA at 300v is very hard running conditions for 45s, and is not recommended (225 v at 50 mA would be better).

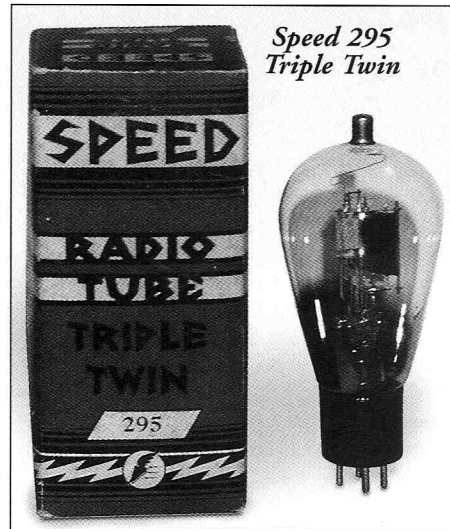

Outro

In Japan and with a few audio extremists, the venerable 45 holds great fascination. In spite of its flea-power capability, its extreme linearity (and commonness, at least until recently) gave it a special standing among tube purists. However, old stocks of 45s are almost depleted, and we feel duty-bound to issue a warning. The street price of the 45 will continue to rise. No large tube manufacturer of the modern era is likely to make a 45, as the demand is so tiny compared to the 300B, much less guitar-amp tubes. The rising price will engender more conflict between radio collectors and golden-ear audiophiles. Unless a specialist tube maker, such as KR Enterprise, introduces a version, the 45 is destined to fade into history--much like other now-rare tubes used in audio equipment. Find a recording engineer who owns a vintage Neumann U47 microphone, and ask him what a replacement VF14 tube sells for today (if available). That is the possible future of the 45.

References

1. *Tube Collector Magazine*, August 2000, Sibley.
2. *70 Years of Radio Tubes and Valves*, Stokes, Vestal Press, 1982, pp. 19-21.
3. *Saga of the Vacuum Tube*, Tyne, Prompt Publications, 1977, pp. 315-322.

Many thanks to Norm Braithwaite, John Eckland, and John Atwood for their assistance with this article.

Eight 45s In A High-Quality Amplifier

By Bart Brown ©2000 All Rights Reserved

A Bit of History

This amplifier is a tribute to my favorite audio power tube of all time--the once common 45. In the late forties, when I began servicing electric radios, many homes still had ornately carved radios with 45s inside them. But a mere 20 years after its introduction, the 45 was considered obsolete, a weak sister. Manufacturers were using pentodes and, particularly, beam power tubes, because they packed out a lot more power for their size and required less expensive drive circuits. By comparison, the new radios using linear detectors and automatic volume control sounded better than the earlier ones, which could overload and distort due to non-linear detectors. But with both tubes given the best of circumstances, pentode sets sounded harsh when compared to good triode sets. So power triode equipped radios hung on for a while where economy was of secondary importance.

Why Build a Triode Amplifier Today?

We have the charmless transistor amplifier to thank for the resurgence of interest in antique audio. If the triode is illusory, but emulates reality, the transistor amplifier, when connected to a loudspeaker, conflicts with it. Whereas, providing signal amplitude is constant, the triode amp is basically a constant voltage source (which is ideal for a loudspeaker), the transistor amp is a varying current source. Throw in a lot of feedback and hope the transistor amp will behave like a constant voltage source.

Push-Pull vs. S.E.

Many people today think that push-pull tube amps are no different qualitatively than transistor amps. They think that transistor amps are perfect and that SE amps were created to produce a lot of harmonious overtones, and thus they are the only "musical" sounding amplifiers. This is absolutely not true; both types of tube amps are capable of producing realistic sound with a loudspeaker whereas, aside from ugliness, the reason transistor amps are rejected is because, when connected to a speaker, they don't produce as high a degree of realism as the tube amps.

Some Circuit Discussion

The 6SQ7 was chosen for its high gain and very linear transfer characteristics. Even so, degenerative feedback is used in the form of an unbypassed cathode resistor. These circuit values are the result of scrupulous tuning, while using a tone generator, to produce purity at the output

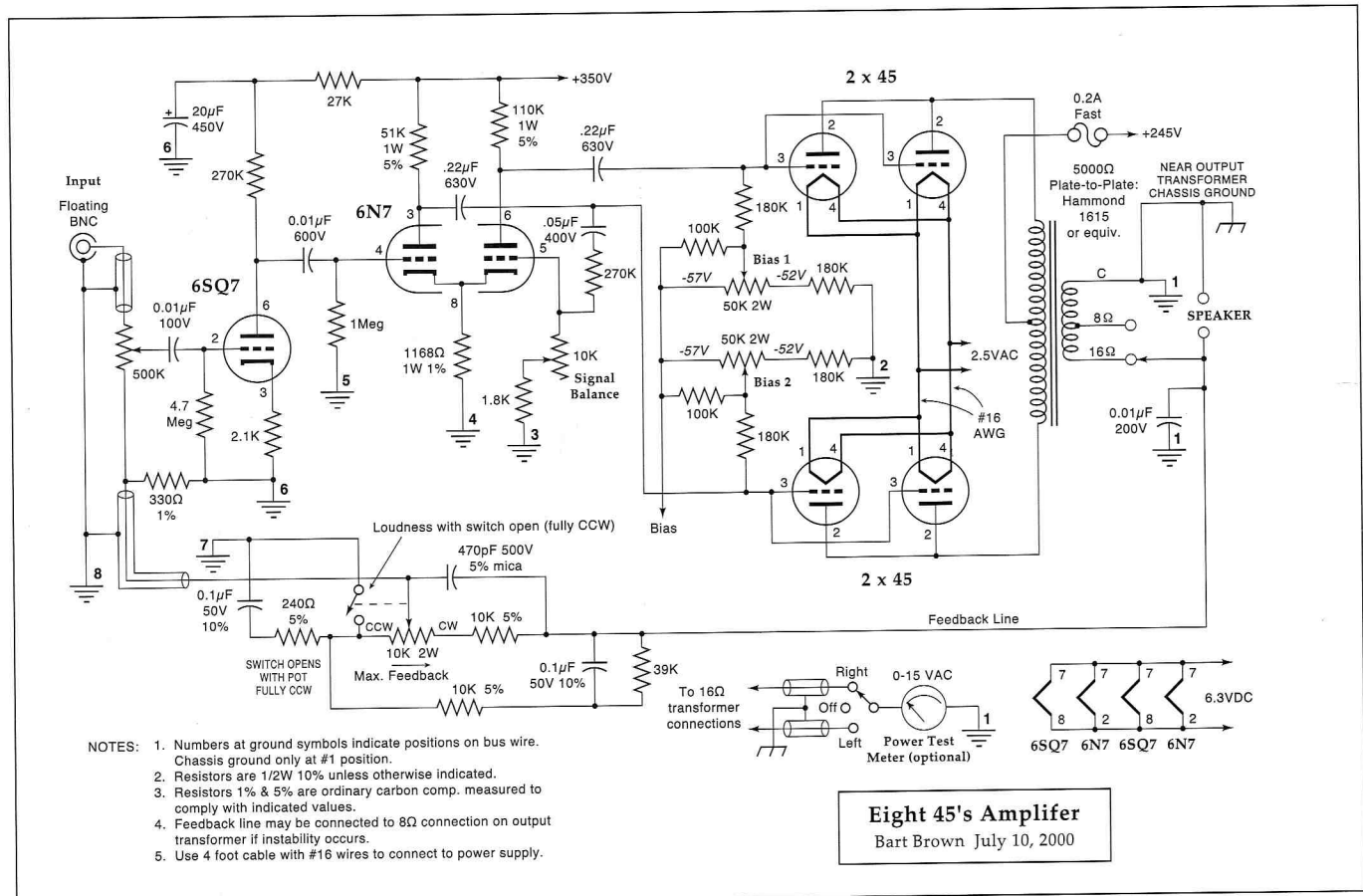

loaded with a correct resistive load. No values result in complete absence of harmonic content at every volume setting. After the best values are determined, the feedback which is variable, can reduce the harmonic distortion in such a manner that it is practically inaudible at any level below saturation. Note that the feedback loop extends from the speaker to the source and is tapped at the bottom of the gain control. This allows for more gain at high settings than would occur otherwise and lends itself to a loudness circuit which can be switched in with the percent feedback control.

Notice that the 45 grid resistors are 180K. Distortion levels rise with lower resistances and even raising the 6N7's plate supply to 400V cannot reduce the distortion significantly. 6SN7s were also tried, and the result was a tossup. In the interest of possible grid conduction, be sure to keep the 45s filament voltage down, say, to 2.3 to 2.4 VAC. A four foot #16AWG interconnect cable does that automatically. Use no gassy 45s!

Adjusting the Amplifier

For each stereo channel the total mutual conductance produced by one set of paralleled 45s should be within 10% of the total mutual conductance produced by the other pair of paralleled 45s. If possible, try to find matched tubes for best performance. There is a separate grid bias control for each set of paralleled 45s. Consequently, there are two bias control pots, side by side, for each stereo channel, located on the rear apron of the amplifier chassis. The other pots, each next to a BNC input connector, are feedback control pots. To maximize power output and keep the plate dissipation down, the bias is nominally set to -57 VDC. This occurs with the bias pots set fully ccw and with a line voltage of about 115 VAC. Therefore, at all times, each stereo channel has at least one bias pot set fully ccw.

A convenient way to statically (no signal) balance the plate currents in one channel is to listen to the hum at its speaker. Stand close to the speaker and have the power supply filament balancing pot within easy reach. Start with all bias pots set fully ccw, and zero feedback. Then minimize hum with the channel's 2.5V filament balance pot. Then balance hum (usually around center position) with the 6SQ7s, 6N7s using the balance pot next to the interconnect connector (shown in the photograph).

A good thing to note here is that defective 6SQ7s or 6N7s can contribute to hum even though the filament supply is rectified. Also, some 6SQ7s are very quiet, whereas others may be microphonic or produce a lot of hiss or hum or both. Select good tubes and remember that the steady state amplitude of a tone indicated by voltages at points A and B must be balanced by the dynamic balance pot each time a 6N7 is replaced and as it ages. When balancing, check back and forth on points A and B until the signals are of equal magnitude.

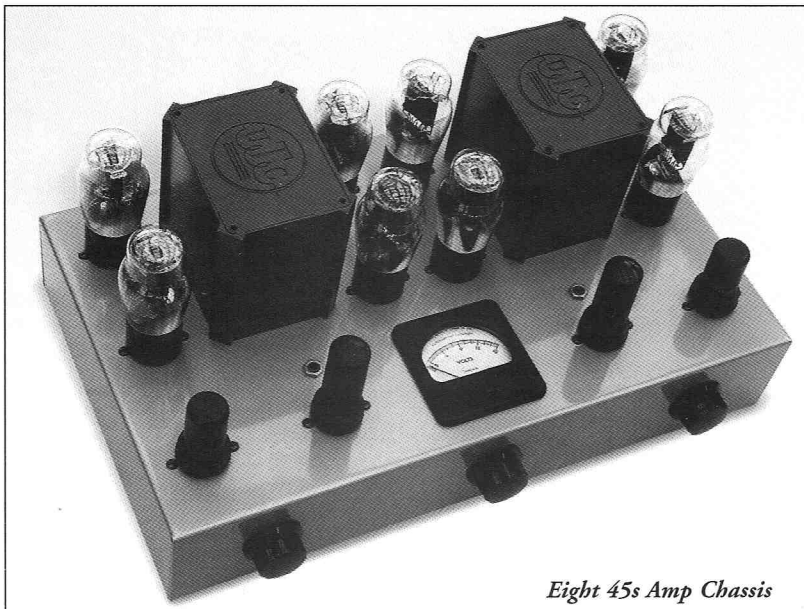

Eight 45s Amp Chassis

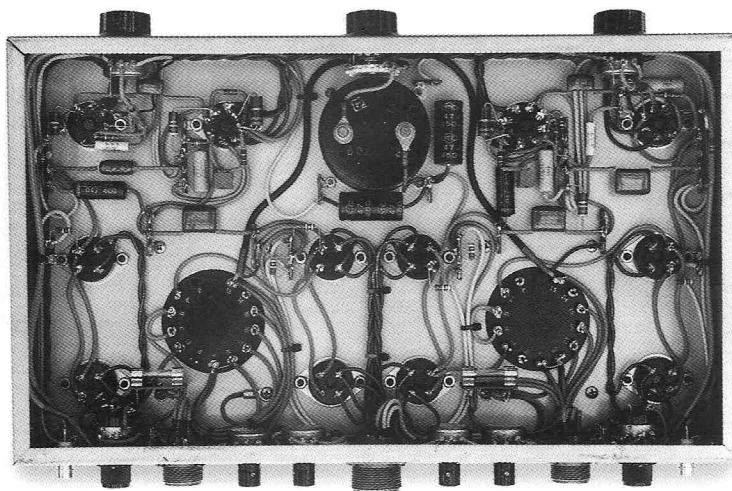

Eight 45s Amp (wiring)

Back to the bias pots: move one of the pots a bit cw and, again, minimize hum with the 2.5V filament pot. If you're left with more hum than before, put the pot back fully ccw and try the other pot. Readjust the filament pot. If hum drops, continue to find minimum hum setting. If no better, just leave both pots at fully ccw positions. If both pairs of 45s are well matched and all tubes are good, you should not have to mismatch bias settings very much to get minimum hum. Remember that feedback will probably make it appear to disappear altogether.

Important Notes

1. I don't recommend doing the above procedure with earphones; a mistake could cause ear damage.
2. If you pull out 6SQ7s or 6N7s with the power on, the pulse will pop the output transformer's fast-blow protection fuse. But this is cheap protection for transformers-

Assemblage SET 300B Amplifier

A Bargain Whose Time Has Come

By David Bardes ©2000 All Rights Reserved

If you are looking for a way into the single-ended Triode arena but don't want to sit with Bob Uecker in the cheap seats, consider the SET 300B from Assemblage at The Parts Connection. With some "solder equity," a quality stereo 300B can be yours for \$1099 including a pair of the new Valve Art 5300 300Bs!

Not since Welborne's Laurel 300B amps were introduced could one get a genuine, made in North America SET 300B kit for just over a grand. So what does \$1099 buy you? A solid chassis with a dark brushed aluminum front panel, really hefty iron, the driver, output and rectifier tubes, and all the parts to make a great amp.

The first thing to impress me was the size and weight of the transformers. No skimping on the iron here! And a first listen revealed that this is a well balanced amp with extended high and low frequency response, only possible with quality iron. The SET 300B does bass better than many commercial and home brew SET amps I have auditioned.

I did not build our evaluation amp, so I can't make any great claim about the ease of construction, but the directions look easy to follow and complete. And the well laid out circuit board goes a long way to reducing the builder's confusion. On the other hand, this is not a minimalist design, as there is a whole bunch of board stuffing to do.

Like many of the other Assemblage kits, much of the design effort and real estate is devoted to the power supply. The tube rectified (twin GZ37s!) B+ supply is pi filtered with a hefty choke and biggish caps, and the filament supply is DC rectified. The SET 300B has three driver stages: the first stage is a shared 6SN7, the second and third stages use one 6BX7GT dual triode per side. The last stage is a cathode follower to develop the voltage swing to drive those 300Bs. The folks at Assemblage were kind enough to provide a pair of the new Valve Art 300Bs, and this is what I used for most of my auditioning. I did trade in some Svet's, for a while, but the improvement was modest.

Our kit was supplied with the Signature parts upgrade package. This upgrade used even higher quality caps and resistors, and added small-value bypass caps in several locations. This \$300 upgrade can be purchased and installed anytime after the kit is built, or can be included in your kit order. No circuitry changes are made, so I don't believe that the parts upgrade changes the basic character of this amp, but enhances what is already there.

I auditioned the 300 SET in several systems. It produced lots of volume and headroom with the backhorn loaded

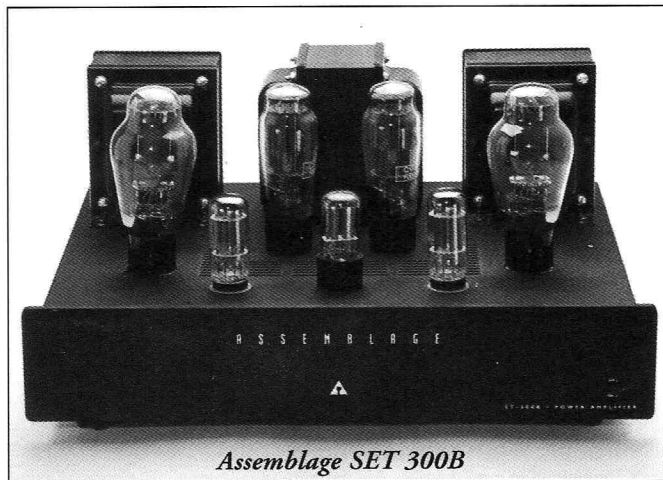

Assemblage SET 300B

Lowthers and the Klipschorns, and enough oomph to drive some bookshelf speakers to moderate volumes, but at 8 watts it didn't have enough power to drive a set of Von Schweikert VR4s. This was no surprise. What was a surprise is how clean and open this amp was, bettering most of the amps I have had in my system. It only gave up a little ground to my favorite 2A3 amp by Moth Audio. While not quite as detailed and big-sounding as the Moth S2A3, it had the same poise, pacing and sound stage that the Moth amp possessed. It also sounded just a bit more powerful. The Assemblage 300 SET was always smooth, balanced and very musical in all the systems I tried it in.

So if you have always dreamed of owning a 300B amp, but high price tags have kept you from those single ended triode bragging rights, get on the phone and give those folks at Assemblage a call! VTV considers the Assemblage SET 300B a best buy and it is highly recommended!

The Parts Connection, 2790 Brighton Road, Oakville, Ontario, Canada L6H 5T4

Phone - 905-829-5858 or 1-800-769-0747

FAX - 905-829-5388

www.partsconnection.on.ca

SET 300B Specifications (provided by Assemblage)

Power Output: 8 watts RMS (both channels driven)

Frequency Response: 20Hz (-0.7dB) to 20Khz (-0.9dB)

Total Harmonic Distortion: <3% at rated power with both channels driven. Typically 0.9% 1KHz@1 watt

Input Sensitivity: .55V for rated power

Input Impedance: 100KOhm

Hum and Noise: -89dB below rated power IHF-A weighted

Gain: 23dB

Power Requirements: 100-120VAC 50/60Hz

Tube Complement: 2 - 6BX7GT, 1 - 6SN7GTB, 2 - GZ37 and 2 - 300B (Valve Art 5300)

Dimensions: 17 inches W, 8.5 inches H, 13.5 inches D

Weight: 50 lbs

Tube Dumpster: 9-Pin Miniatures

By John Atwood ©2000 All Rights Reserved

In the last issue, we described the various 7-pin miniature tetrodes. We now look at the larger family of 9-pin (also called novar) tetrodes. The larger envelope size allows better heat dissipation than the 7-pin types, making the 9-pin types less of a high-temperature engineering problem. The first power tubes in the 9-pin novar format came out in America in the late 1940s. Unlike the 7-pin types, the novar format was quickly picked up by European manufacturers. In particular, the Philips "rim-lock" tubes could be migrated to the novar format by changing only the base. As a result, a significant number of the novar designs came from Europe.

The very first novar power tetrodes were military/aviation types where the small size and short lead lengths gave them an advantage over octals, particularly in VHF transmitters. The 5686 was developed by GE for the ARINC reliable avionics tube program. The 5763 was developed by RCA as a general-purpose small transmitting tube.

The next family of novar tubes developed was the video amplifier tubes. In 1950, RCA came out with the 6CL6, a miniature version of the popular World-War II tube, the 6AG7. About the same time, Hytron came out with the 12BY7 and other series of 12.6/6.3V TV tubes (others in the series were the 12A4, 12B4, 12BH7, and 12BZ7). Both these tubes were very popular, and were not displaced until the mid-1960s when color TV designs required higher-performance tubes. The very-high transconductance 12GN7 and 12HG7 then became the video amplifiers of choice. The only novar pentode that exceeded the gm of these color TV types was the European 7788/E810F, which was mainly used in high-performance industrial equipment. For

example, the 7788 was used as the front-end RF amplifier in the Mackay 3010 marine receiver and as a vertical deflection amplifier in the Tektronix 547 oscilloscope.

In the early 1950s, there began a wholesale conversion

Table 1

Type	Base	Ef	If	Pd max	Ep max	tetrode gm	triode mu	Prototype
6BK5	9BQ	6.3	1.2	9	250	8500	24	
6BQ5/EL84	9CV	6.3	0.76	12	300	11300	19	
6BW6	9AM	6.3	0.45	12	315	5200		
6CL6	9BV	6.3	0.65	7.5	300	11000	23	6AG7
6CM6	9CK	6.3	0.45	12	315	4100	8.7	6V6GT
6CS5	9GR	6.3	1.2	10	300	8000		
6CW5/EL86	9CV	6.3	0.75	12	250	11000	7.3	
6CZ5	9HN	6.3	0.45	9	315	4800	9.1	6V6GT
6DB5	9GR	6.3	1.2	10	300	8000	6.1	
6DT5	9HN	6.3	1.2	8	285	6200	9.5	
6DW5	9CK	6.3	1.2	10	300	5500		
6EM5	9HN	6.3	0.8	10	315	5100	8.7	6V6GT
6GC5	9EU	6.3	1.2	11	200	8000	6.3	6W6GT
6GK6	9GK	6.3	0.76	12	300	11300	18	6BQ5
6GM5	9MQ	6.3	0.8	17	500	10200	16	7591
6HB6	9NW	6.3	0.76	9	315	20000	27	
6HL5	9QW	6.3	0.95	11	300	17000		
6JQ6	9RA	6.3	1.2	9	385	10500	5	
12AB5	9EU	12.6	0.2	12	315	4100	8.7	12V6GT
12BV7	9BF	6.3/12.6	0.3/0.6	6.25	300	13000	25	
12BY7	9BF	6.3/12.6	0.3/0.6	6.5	300	11000	26	
12GN7A	9BF	6.3/12.6	0.3/0.6	11.5	360	36000	42	
12HG7	9BF	6.3/12.6	.26/1.52	10	360	32000		
5686	9G	6.3	0.35	8.25	235	3100	10.5	
5763	9K	6.3	0.75	10	255	7000	14	
6094	9DH	6.3	0.6	10.5	235	4100	9.2	6V6GT
6216	9CE	6.3	1.2	10	300	8800	6.5	
6973	9EU	6.3	0.45	12	400	4800	8.9	6V6GT
7551	9LK	13.5	0.36	8.5	320	5300	8.7 *	
7701	9MS	13.6	0.16	8	315	3600		
7788	9NK	6.3	0.34	4.25	215	50000	54	
7905	9PB	6.3	0.65	8.5	255	6700	11.5 *	
8106	9PL	13.5	0.25	5	280	9000	30	12BY7
EL81/6CJ6	9AS	6.3	1.05	8	250	6000	5.4	
EL82/6DY5		6.3	0.8	9	250	9000	10 *	
EL83/6CK6	9AR	6.3	0.71	9	250	10500	24 *	
EL861		6.3	0.23	4.5	550	11000	36 *	
SV83		6.3	0.76	12	300	15000	21	EL83
E80L/6227		6.3	0.75	8	300	9000	21.5 *	
E81L/6686		6.3	0.375	4.5	210	11000	36 *	

Note on triode-connected mu (g1 to g2 amplification factor): * indicates manufacturer's value, all other mu values measured at 20mA, about 100V, averaged over at least 3 samples.

5686, 5763, 8077/7054, 6094

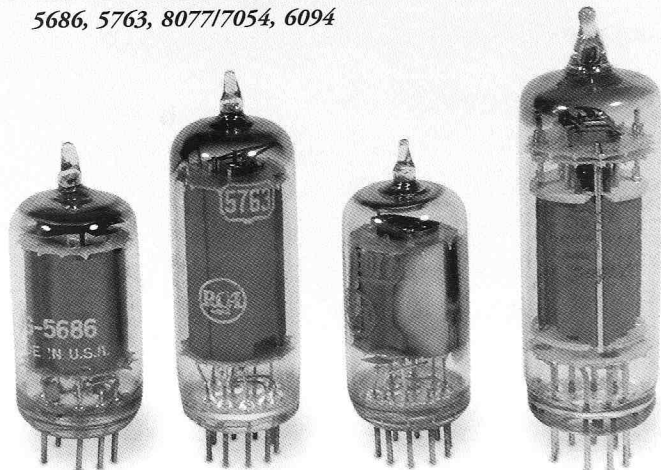

of octal GT types to novar types. The first types were simply upsized versions of 7-pin types which still matched the characteristics of octal types. Examples are the 6CS5 (similar to the 6BF5 and 6W6GT), the 6CM6 (similar to the 6AQ5 and 6V6GT), and the 12AB5 (similar to the 12V6GT, for car radio applications). In the spirit of American tube manufacturing, there was a huge proliferation of novar types in the 1950s and '60s. Often the only difference of a new type was a different pin-out and an insignificant change in maximum ratings.

Also in the early 1950s, Philips came out with a series of consumer electronics novar tubes: the EL81 (a horizontal sweep tube with a plate cap), the EL82 (an audio or vertical sweep tube), and the EL83 (a video amplifier). Shortly afterwards, they came out

6CL6, 12BY7, SV83, 7788

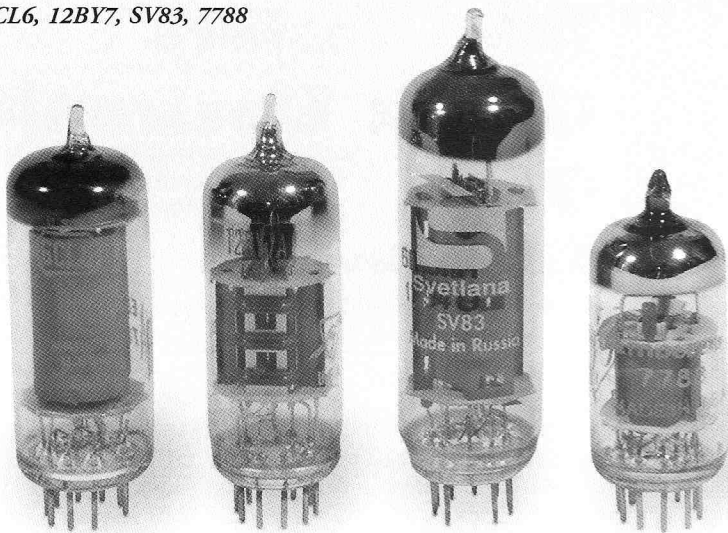

with two famous pentodes: the EL84/6BQ5 and the EL86/6CW5. The EL84 became the classic small hi-fi amplifier tube, considered by some to be the best-sounding power pentode ever. The EL86 is similar to the EL84 but with lower mu and voltage ratings, making it work well in line-operated audio amplifiers. These tubes became the mainstay of small power amplifier tubes for the Europeans, and were heavily used by American and Japanese manufacturers as well.

By the 1960s, the American tube companies had started to make quite high-performance novar tetrodes for vertical sweep amplifiers and audio output stages. Notable are the 6HA6/6HB6 and the 6GK6. The latter tube, interestingly, has essentially the same characteristics as the EL84/6BQ5, although is not often seen in hi-fi equipment.

In the late 1950s, there was a big push to convert consumer electronics to auto-inserted, PC-board construction. Octal sockets were more difficult to automate than novar sockets, so Sylvania came out with a line of power tubes in a GT-sized bulb but with a small novar base. These look surprisingly like miniature tubes on steroids! The 6GC5 is equivalent to the 6W6GT, while the 6GM5 is equivalent to the hard-to-find 7591. Other tubes in this Sylvania series include the 6EW7, the 6FR7, the 6HC8, the 6JT8, and the 6KU8. These types were soon superseded by tubes with the larger noval and duodecar (Compactron) bases.

Table 1 (page 12) lists the key characteristics of most 9-pin novar power pentodes and beam tetrodes. When possible, the triode-connected mu was measured at the One Electron lab. The maximum ratings were normalized to the older "design-center" rating system--that is why some of the newer tubes and industrial types seem to have lower ratings than listed in the data books. When using these tubes in triode-connected or ultra-linear modes, check the maximum screen voltage ratings. They are often lower than the plate ratings, especially for the high-transcon-

ductance types. Table 2 lists types derived from those in Table 1--mostly series-string versions.

The 6BQ5/EL84's use in audio has already been well-described in VTV issue #8.

As can be seen in Table 1, several other types have similar characteristics, although not always the same maximum ratings, such as the 6CL6, 6GK6, and 12BY7. Many types have been derived from the 6V6GT: 6CM6, 6CZ5, 6EM5, 12AB5, 6094, and 6973. These all will work well as audio amplifiers and some are easy to find as surplus. Many of the other TV types are worth experimenting with. Some of the really high-transconductance types, such as the

Table 2

Type	Base	Ef	If	Prototype
6HA6	9NW	6.3	0.71	6HB6
6JW6	9PU	6.3	0.6	12GN7A
8BQ5/XL84	9CV	8.0	0.45	6BQ5/EL84
8CW5/XL86	9CV	8.0	0.45	6CW5/EL86
8EM5	9HN	8.4	0.6	6EM5
8HA6	9NW	8.0	0.6	6HA6
10BQ5	9CV	10.6	0.45	6BQ5/EL84
10CW5/LL86	9CV	10.6	0.45	6CW5/EL86
10GK6	9GK	10.6	0.45	6GK6
12BK5	9BQ	12.6	0.6	6BK5
12CM6	9CK	12.6	0.225	6CM6
12CS5	9GR	12.6	0.6	6CS5
12DB5	9GR	12.6	0.6	6DB5
12DQ7	9BF	6.3/12.6	0.3/0.6	12BY7
12DT5	9HN	12.6	0.6	6DT5
12DW5	9CK	12.6	0.6	6DW5
15BQ5/PL84	9CV	15.0	0.3	6BQ5/EL84
15CW5	9CV	15.0	0.3	6CW5/EL86
16GK6	9GK	16.0	0.3	6GK6
25BK5	9BQ	25.0	0.3	6BK5
25DT5	9HN	25.0	0.3	6DT5
28HA6	9NW	28.6	0.15	6HA6
29GK6	9GK	29.0	0.15	6GK6
30CW5	9CV	30.0	0.15	6CW5/EL86
45B5/UL84	9CV	45.0	0.15	6BQ5/EL84
50BK5	9BQ	50.0	0.15	6BK5
50HN5	9QW	50.0	0.15	6HL5
60HL5	9QW	60.0	0.1	6HL6
6197	9BV	6.3	0.65	6CL6
6287	9CT	6.3	0.6	6094
6677	9BV	6.3	0.65	6CL6
7054	9GT	13.5	0.275	12BY7
7061	9EU	13.5	0.21	12AB5
7189A	9LE	6.3	0.76	6BQ5
7558	9LK	6.3	0.8	7551
7757	9NE	6.3	0.6	6094
8077	9GK	13.5	0.275	12BY7
E84L/7320	9CV	6.3	0.76	6BQ5/EL84
IL861		20.0	0.12	EL861

EL81, 6CZ5, 6CM6, 10GK6, 12JQ6

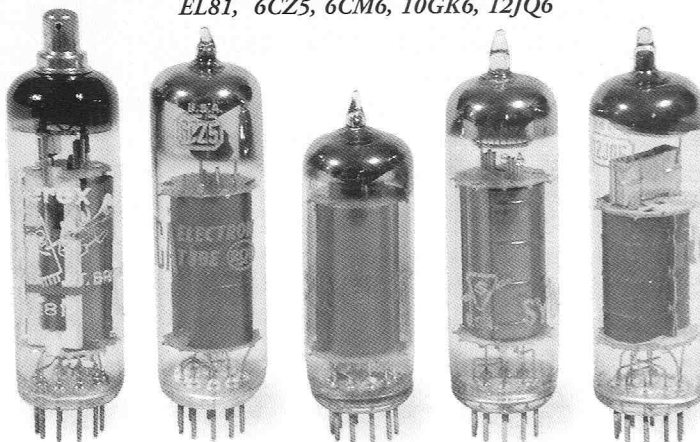

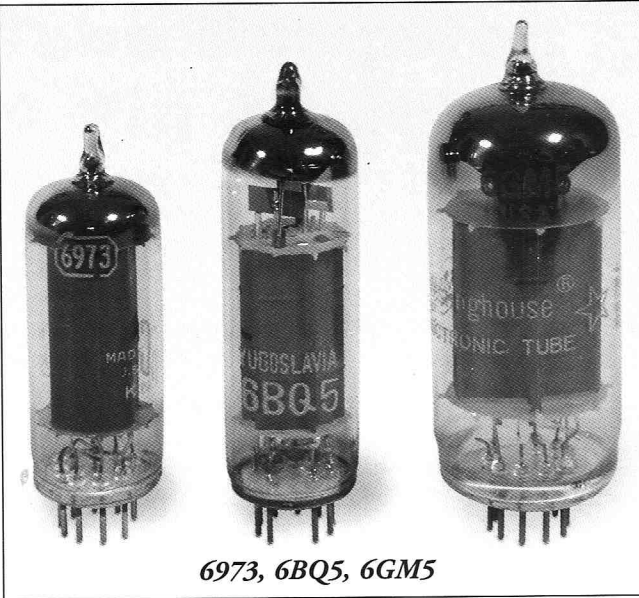

6973, 6BQ5, 6GM5

6HA6/6HB6, the 12GN7, and the Svetlana SV83, are less linear than the conventional audio types and also are prone to RF oscillation unless grid-stopper resistors are used.

As with the 7-pin power tubes, the novar tubes make good regulator tubes when triode-connected. In particular, the ones with low triode mu, such as the 6CW5/EL86, 6DB5, 6GC5, 6JQ6, and 6216, can work well as series pass tubes with low voltage drop across the tube. A high-transconductance pentode can be used by itself to make a reasonably good shunt regulator. The video amplifier tubes work best here: 6CL6, 6HA6/6HB6, 12BY7, 12GN7, EL83, and SV83.

Another good use of triode-connected novar pentodes is as a driver tube to a single-ended output stage. A triode-connected 6BQ5/EL84 gives the gain of a 6SN7 but with higher power ratings. The frame-grid 7788 has a good reputation with audiophiles and has almost three times the gain of a 6SN7. The lower mu types make good transformer or choke-coupled drivers due to their low plate resistance.

Since many of the 9-pin novar types described here are true "dumpster tubes," especially the various TV types, yet are close in characteristics to good audio types, experimenters have plenty to play with!

References

1. **Essential Characteristics**, General Electric Co., 1974.
2. **Frank's Electron tube Pages** (<http://home.planet.nl/~frank.philipse/frank/frank.html>)
3. **Tube Regulators**, a series of articles by John Atwood in the May, June, July and August 1999 issues of "Tube CAD Journal" (<http://www.tubecad.com/>)

Tube Testers and Classic Electronic Gear

A Book Review

By Eric Barbour ©2000 All Rights Reserved

For years, I wondered why there was no textbook about tube testers. These "archaic" devices were made in great quantities until the 1980s, and innumerable tube-audio users are trying to apply them today. Yet there has been no real central reference on tube testers. Anyone needing to repair or calibrate one was often forced to rely on the guitar-amp "grapevine," and was often at the mercy of an incompetent technician.

Finally, longtime collector and AWA (Antique Wireless Association) member Alan Douglas has produced such a book. It devotes separate chapters to all of the major manufacturers: AVO, Accurate Instrument, B&K, EICO, EMC, General Radio, Heath, Hickok, Jackson, Knight, Mercury, Precise, Precision Apparatus, RCA, Seco, Sencore, Simpson, Superior, Supreme (amazing how uncreative the namers of these firms were), Sylvania, Triplet and Weston, plus "miscellaneous." Most of these firms had been discussed in past issues of the AWA's "Old Timer's Bulletin" and in *Antique Radio Classified*, although sometimes more than 20 years ago. Finding the articles on companies such as Supreme, the only electronic manufacturer in Greenwood, Mississippi, would not be an easy job. Alan has done his research, and produced a credible reference.

Alan has considerable discussion on the top level of tube testers--the "laboratory" variety, that has always been scarce and rarely appears for sale on eBay or elsewhere. This includes the RCA WT-100A, Weston 686, General Radio's 561A tube bridge, AVO's VCM series, and a good-sized chapter on Hickok, including their notorious "Cardmatic" testers. I wish he had mentioned the WT-100A-like tube characteristic testers made in Europe by companies such as Mullard, Philips, Siemens and Rohde & Schwarz. Admittedly, however, those testers are so scarce that most tube-tester collectors in the U.S. have never even heard of them.

The chapter on Hickok testers is one of the longest, and ends with a model list that runs to one and a half pages. Although there are very few schematics in this book (it's not intended to be a repairer's reference), the Hickok mutual-conductance circuit is described in adequate detail for a smart person to use it in restoring or calibrating one of the uncounted thousands of testers current in the field. There is a brief section on calibrating Hickoks, as well, which will be useful in the future.

A good chapter also describes all the major U.S. military

standard tube testers, primarily the I-177 and the later TV series. Not many people have seen an I-177, and that's good; although an essential item in World War II, it was obsolete by 1945, and not very useful even before that. The TV-7 series was the most common, and since it used the Hickok mutual-conductance circuit, it might be the closest thing to a standard tube checker. Besides, unlike a lot of cheaply-built testers, you can drop a TV-7 into salt water from altitude, and it will probably survive. Apparently TV-7D/Us were being manufactured until 1982; and the USM-118B Cardmatic variant until 1988.

One chapter alone is worth the price of the book: Alan's discussion of tube curve tracers. Not only does he discuss the rare Tektronix 570 tracer, he shows how to use the more-common Tek 575 transistor curve tracer, and a few other older transistor tracers, to test tubes (most of them are capable of producing collector/plate voltages of 400v or more). Alan even tells how to build one's own manually-controlled tracer, using power supplies and an XY plotter.

Later in the book are several chapters discussing other kinds of vintage test gear. They cover such "obsolete" things as VOMs, VTVMs, Q meters (used to test the "quality factor" of capacitors and inductors), grid dip meters, capacitance, and inductance meters and bridges, RF and AF signal generators, signal tracers (talk about "dead technology"--find a technician under age 40 who knows how to use one) and early oscilloscopes. The latter touches briefly on Tektronix's classic models, and Du Mont's clunkier scopes from the same time period. I said these devices were "obsolete" because according to today's crop of know-it-all educators, there is no longer any need to breadboard circuits. Just run a computer simulation, and all your design's problems will be found beforehand. Yeah, sure...

There were so many electronic test gadgets made over the last 100 years that no book could possibly cover them all. Indeed, Alan decided not to give much coverage to emission-type tube testers, and for good reason. Emission testers are less helpful to modern tube-audio users, and there were so many made, of so many brands and models, that a separate book would be needed. Many vintage emission testers can't be trusted to give consistent or usable readings on a tube's health.

Thankfully, Alan repeatedly warns his readers to replace old paper capacitors, which are major causes of failure in vintage equipment--the black bakelite "striper" caps are especially notorious, as any McIntosh hi-fi collector can tell you.

Alan makes no effort to discuss the "drugstore" type emission testers, which often featured garish backlit advertising panels. They were once widely used by laymen to check TV tubes. I personally would prefer to see those horrible things forgotten--they were rarely accurate, and many people spent a lot of money replacing TV tubes that were still viable. (Invariably, the tubes sold by those non-electronic retail establishments were priced very high--\$28 for a sweep tube was not unusual--in 1969. That would be

Tube Testers and Classic Electronic Test Gear

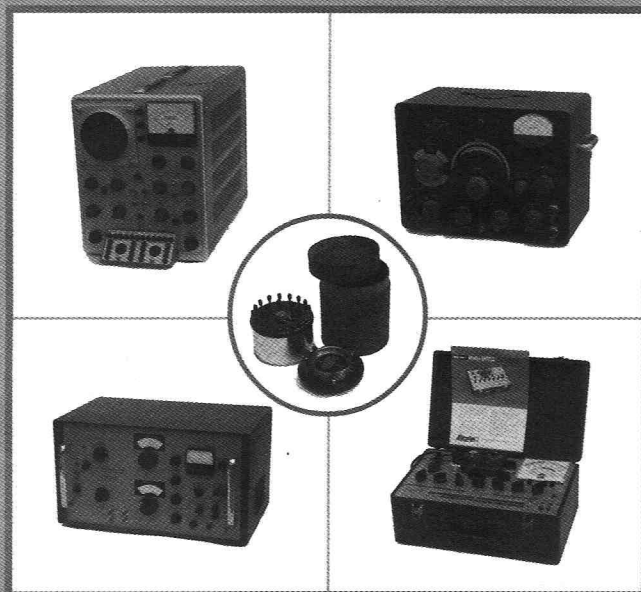

Alan Douglas

roughly equivalent to \$150 today. Modern audio tubes are a bargain. Count your blessings.)

Because this book is oriented toward vintage equipment, it doesn't discuss the few modern tube testers available. This would include the Maxi-Matcher, the New Sensor OTTO-1, and the George Kaye Small-Signal Tube Tester (the latter recently discontinued). Alan doesn't cover the only two recent tube curve tracers I know of, the Audiomatica Sofia (also recently discontinued) and the brand-new Hagerman VacuTrace. These devices tend to be "costly," in the view of most end-users. However, we must point out that the prices of good vintage tube testers can go only one way in the future: up! It's possible that the Hagerman curve tracer will seem like a bargain in a few years.

These tiny quibbles aside, I am compelled to say that Alan has done us all a huge service by documenting an area of electronics that had previously not been the subject of a proper book. The need for, and prices of, vintage tube testers are now rising, so this book is perfectly timed. No collector or tube user should be without it.

Price: \$25.95 - Sonoran Publishing LLC, 2000, 166 pgs, ISBN 1-886606-14-5

Available from *Antique Electronic Supply* (480) 820-5411 or www.tubesandmore.com

RF-Powered Amplification

A Parallel Feed Experiment

By John Atwood ©2000 All Rights Reserved

Those who design audio amplifiers using filamentary triodes face a dilemma: how to deal with hum from the filament. The better linearity and better sound from these primitive tubes is often compromised by hum, especially in single-ended amps. The usual solution to the problem is to use DC to power the filaments. However, some audiophiles have reported better sound (other than hum) with AC on the filaments. There are also several theoretical reasons why DC is not as good as AC: the fact that one end of the filament is always at a different potential than the other end, and that some types of tungsten filament can develop defects along crystal boundaries, shortening its life. The first problem can cause uneven wear-out of the filament emission and possibly some distortion, while the second problem, though well documented for light bulbs, may also occur in tubes (although this is not a pressing problem, since emission usually fades well before the filament fails).

Hum from AC-powered filaments is not a severe problem in push-pull design, due to the effectiveness of canceling the hum. Some tubes, such as the 2A3, 300B, 45, and 47 were designed to run with AC filament supplies in single-ended designs. However, even with hum balancing controls, the amount of residual hum, often harmonics of the line frequency, is just marginal for hi-fi applications with efficient speakers. Transmitting tubes with thoriated-tungsten filaments, often favored for their clean, "big" sound, are virtually impossible to use in single-ended designs with AC, due to their high hum level. DC has traditionally been used to power these tubes in hi-fi designs.

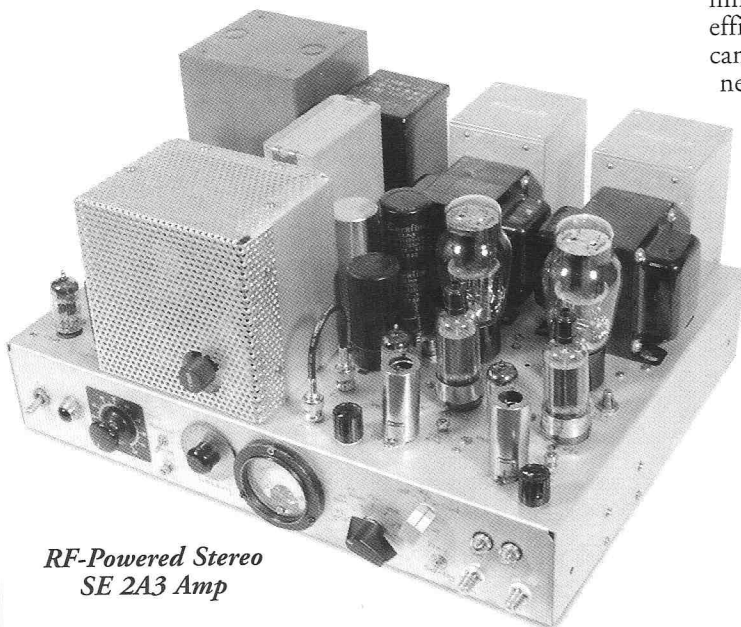

RF-Powered Stereo
SE 2A3 Amp

I have been thinking of an alternative method of powering tube filaments for several years, and finally built some amplifiers that tested the concept: heating the filaments with RF. This is not a new concept--RF heating has been used for years to power "exciter" lamps in 16 mm optical-sound projectors. The reason was that clean, hum-free RF was easier to produce than clean DC in the days before modern semiconductors, particularly in designs that had to run off of AC and DC power lines. Why couldn't the same concept be used to power filamentary audio tubes?

RF Heating Requirements

In order to effectively use RF filament heating, the following technical requirements must be met:

Frequency: It must be high enough that the highest possible harmonics generated within the amplifier cannot "beat" with the filament supply and cause intermodulation artifacts within the audio band. Several hundred KHz would be the minimum for an audiophile amplifier. However, inductance of the tube heater structure limits the maximum frequency.

Amplitude: It should be adjustable, yet stable. Hum and noise modulation of the RF should be minimized, since it gets rectified in the amplifier and can be manifested as audible hum and noise.

Frequency Stability: Not critical for heating, but for stability of circuit adjustments and minimization of interference, should be stable. Crystal controlled oscillators are used.

Electromagnetic Radiation: It should ideally meet FCC/EU EMI requirements and at a minimum for home-made designs, should not interfere with other radio services.

The Design Philosophy of the 2A3 Stereo Amplifier

Tubes have been used to generate RF power for almost ninety years, and have been developed to a high degree of efficiency and reliability. They are also very rugged and can withstand the trials and tribulations of debugging a new design. The technology of RF generation is also well developed for the experimenter. It is called a ham radio transmitter, and is well documented in amateur publications, such as the ARRL Radio Amateur's Handbook. So, I coupled a basic ham radio transmitter design with a filamentary tube single-ended amplifier. The only special technology needed was the method of coupling the RF to the filament. The rest of the design was made of pieces of existing technologies. The innovative part is the system design integrating these pieces together.

The first amplifier was to be a showpiece of the new design--I didn't want a compromised design to color my evaluation of the RF technology. I picked a 2A3 single-ended output with a two-stage driver. The first tube is a triode-connected 5879, which gives a mu of about 20. This is RC-coupled to a triode-connected

RF-Driven Directly-Heated Audio Amp

Simplified Conceptual Schematic Diagram

(power supply not shown)

John Atwood Sept. 2000

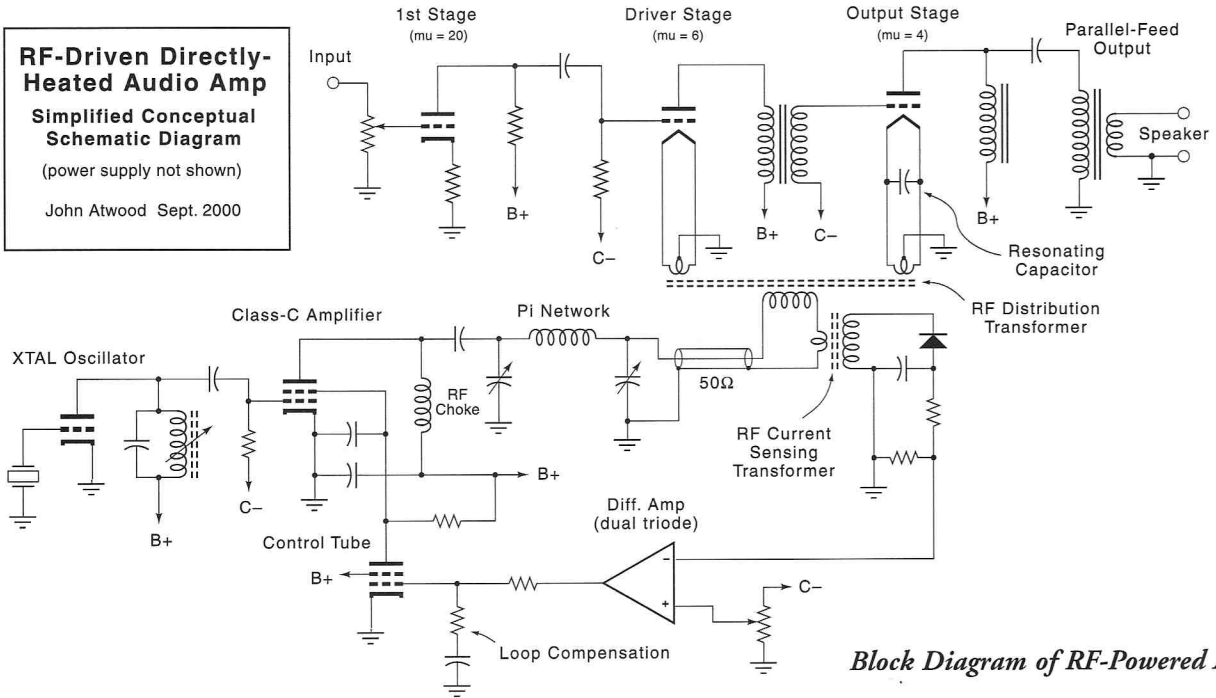

Block Diagram of RF-Powered Amp

2E24. This tube is a directly-heated cousin to the popular 2E26 transmitting tube, and was chosen to see how well the RF filament drive would work on a driver tube. A Lundahl LL1635/20mA interstage transformer couples the 2E24 to the 2A3. The output circuit is shunt-feed with a One Electron UBT-2 (secondary unused) as the choke load and a prototype Fi-Sonik OP-03058 nickel-core output transformer. No feedback is used other than a partially-bypassed cathode resistor in the first stage. Adjustable fixed bias is used on the 2E24 and 2A3. A 6CL6 is used as a shunt regulator for the 2E24 stage and Cerafine electrolytics (bypassed with polypropylene capacitors) filter the first and last stage. The filaments of the 2A3, 2E24, and 5879 are all run by RF.

To design the RF generator, first the power of the filament load is calculated:

$$2A3: 2.5V \times 2.5A = 6.25W$$

$$2E24: 6.3V \times 0.65A = 4.1W$$

$$5879: 6.3V \times 0.15A = 0.95W$$

$$\text{total} = 11.3W, \text{ then } \times 2 \text{ for stereo gives } 22.6W$$

With a generous allowance for circuit losses, start-up current, etc. I estimated that about 40 watts of RF would be needed. Sticking to traditional transmitter design, a 6146 running in class-C was used, with 500 volts on the plate. A 6AH6 is used as an electron-coupled crystal oscillator.

The first version of the stereo test amp used 6.78MHz for the RF frequency. This is the lowest frequency allocated by the FCC for industrial uses where radiation limits are slack. As explained later, a lower frequency was later desired, and a modification of the amp used 3.579545

MHz, the NTSC color subcarrier. The rationalization for using this frequency, even though it is in a ham radio band, was that any interference would be swamped by the stray emissions of color TV sets in the area. Also, the crystal is easy to find--mine was from a junked color TV.

The 6146 output circuit was designed to drive a 50-ohm load, just as it would in a ham transmitter, so that instrumentation could be inserted between the RF generator and the load for diagnostics and testing. Two BNC connectors on the chassis with a short coax jumper allows things like power meters and SWR meters to be inserted. The output circuit is a pi-network, with values calculated from the ARRL Radio Amateur's Handbook. The output inductor was made of 16-gauge wire wound around a plastic medicine bottle.

The most interesting part of the design is how the 50 ohm RF power is matched to the filaments. A toroidal transformer was used with four secondaries: two for each of the 2A3s, and two for each set of 2E24/5879s. At the RF frequencies used, core saturation was not an issue, at least with the size toroid used. The turns ratio is determined by the impedance of the filament loads: 1 ohm for the 2A3 and about 8 ohms for the 5879 and 2E24 together. Each filament supply has a grounded center-tap. The 2E24's filament already has a center-tap, but the 2A3 doesn't, so its secondary winding is center-tapped. The final winding scheme is primary: 27 turns, 2A3 secondaries: 2 turns, 2E24/5879 secondaries: 5 turns.

The choice of toroid core material is critical. Most ferrite toroids on the surplus market are optimized for switching power supplies, i.e., several hundred KHz at most. The ferrite catalogs usually rate their high-frequency ferrites for their lossiness (for EMI filtering) or for high-Q tuned circuits. Unable to get exact high power trans-

former-mode specs, I ordered cores of several different types: 43, 61, 63 from Amidon, a company that sells small quantities for hams (www.amidoncorp.com). Their ferrite toroids are actually made by Fair-Rite, so the best technical info is available at www.fair-rite.com. Ferrite formulations have fairly narrow frequency ranges where they have low losses. Generally, the lower the optimized frequency range, the higher the permeability. At 6.78MHz, only the highest frequency core, type 63, worked without overheating. At 2MHz, the higher-permeability type 61 worked well.

RF-Powered 300B Mono Amp

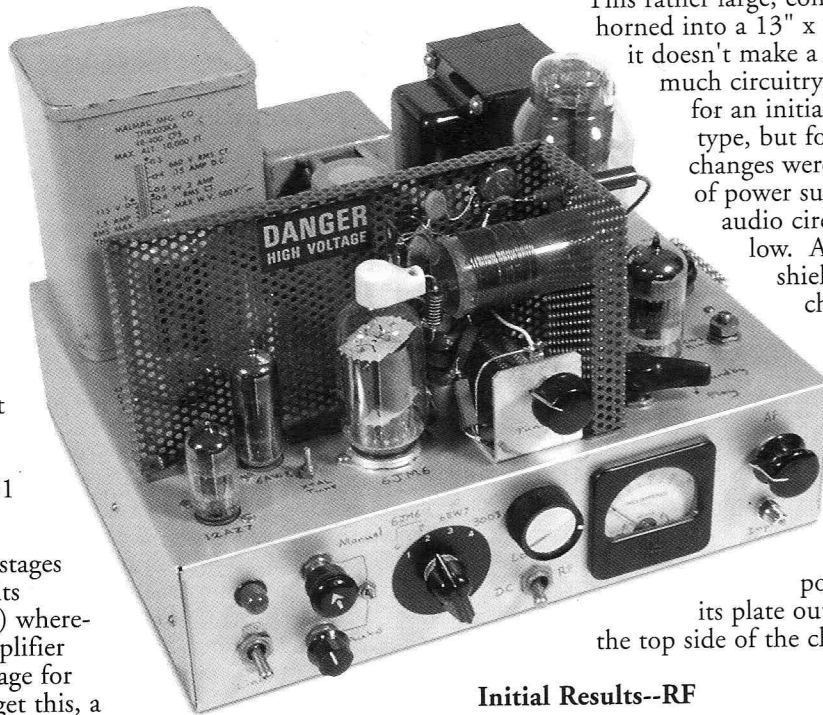

The 2A3 output stages need about 325 volts (275V on the plate) whereas the 6146 RF amplifier needs a higher voltage for best efficiency. To get this, a center-tapped bridge rectifier scheme was used, with damper tubes running into a capacitor-input filter for the 325V supply, and a 6AX5GT choke-input supply stacked on top of that to make the 500V supply. A separate -250V supply using a solid-state voltage doubler generates the negative voltage needed for the fixed bias circuits. An 0A2 gives a regulated -150V reference, which is further filtered and buffered by separate 12AU7 sections for each channel's 6CL6 regulator. A junk-box mil-spec power transformer was used. Due to its odd filament windings, 12AX4GTs were used for the main rectifiers. A panel meter can be switched to measure the 6146, 2E24, and 2A3 operating currents.

In order to stabilize the RF supply, a current feedback scheme was used. The 50-ohm RF lead is wrapped around a small high-frequency toroid to create a one-turn primary. 42 turns on the secondary were then rectified by a 1N34A germanium diode voltage doubler. The RF current was sensed instead of the voltage so that the RF supply would not be overloaded when trying to heat cold, low-resistance filaments. The rectified current sense voltage is compared to an adjustable reference in a 12AZ7 differential amplifier. This, in turn, drives the grid of a 6AQ5 beam tetrode which controls the voltage of the 6146 screen. A manual/automatic switch is provided; in manual mode, the 6AQ5 is controlled only by a variable resistor in its cathode; in automatic mode, the feedback loop is closed with the 6AQ5 being driven by the 12AZ7 diff-

amp. This stabilization circuit works quite well and has an additional benefit: residual hum modulation of the RF (due to imperfect B+ filtering to the 6146) is substantially reduced, since the bandwidth of the feedback loop is broad enough (about 1KHz) to clean up the hum.

This rather large, complex circuit was shoe-horned into a 13" x 17" chassis. In retrospect, it doesn't make a lot of sense to cram so much circuitry so tightly into the chassis for an initial proof-of-concept prototype, but fortunately, no major circuit changes were needed. Careful isolation of power supply circuits from the audio circuits kept the hum very low. An aluminum sheet-metal shield between the two audio channels, as well as separate power-supply filtering, kept the channel-to-channel isolation very good. This shield also serves as a well-needed chassis stiffener! A large Corcom power-line filter reduces RF emissions from the power cord. The 6146 and its plate output circuits are shielded on the top side of the chassis by an RF cage.

Initial Results--RF

The biggest problem with the RF-powered 2A3 amp was, and continues to be, getting the temperature of the RF-powered tube filaments to match. One of the first things noticed was that the RF load presented to the 6146 amplifier was extremely inductive--making it hard to tune and deliver power to the tube filaments. A few tests and calculations showed that the filament of a typical 2A3 was about 0.15 micro henries. This doesn't sound like much, but at 6.78MHz, this is a reactance of 6.4 ohms, 6.4 times its DC impedance of 1.0 ohm! The solution to this problem was to tune out this reactance with a shunt capacitor. Using the SWR meter, various capacitor values were tried across the 2A3 sockets, and at 6.78MHz, a value of 4400pF across each 2A3 was about right. The 2E24/5879 taps on the toroid transformer didn't need tuning, since the tube filament inductance was much lower, due to the very short internal leads. Once the inductance was tuned-out, the big problem was balancing the RF current. Either the 2A3s would be stone-cold and the 2E24s yellow hot, or vice-versa. Despite the symmetrical design, there were also differences between the right and left sides. After much cut-and-try experimentation with different shunt capacitors and low value series resistors, I finally got the tubes to balance!

The tube balance was precarious, though. Changing brands of 2A3's made a major difference, and without a complete re-tuning of the circuit, some would not light-up at all. I found that the Chinese 2A3s and vintage RCA's were fairly similar in behavior, so I optimized the circuit

for them. The RCA 2A3s exhibited an interesting phenomenon, though. The wires from the glass stem press seal to the tungsten filament strands would glow red to orange-sometimes as bright as the filament itself! This is probably caused by the high circulating currents from the effort to tune out the inductance, aggravated by the skin effect reducing the effective cross-section of the wire. The Chinese tubes don't glow. The filament lead material in the RCA tubes probably has fairly high resistivity. In any case, this kind of unusual heating isn't good for the tube--it drives gas out of the metal and stresses the glass-to-metal vacuum seal. Indeed, I saw early failures on some of the RCA tubes.

The RF power-generation circuits worked very well and are exceptionally stable. In fact, the original used a 6146 and has been in the amp throughout all the debugging and tests, some of which ran the 6146 orange-hot and others which burned-out my power meter, yet the tube is still running strong! The automatic leveling circuit works very well. Stray RF emissions, while not quantitatively measured, appear to be quite low, as long as the top RF cage is in place.

After a month of listening tests, I wanted to make the amp more reliable, so I dropped the RF frequency to 3.58MHz. This required larger shunt tuning capacitors of about .02uF. The heating balance was only slightly easier to tame and the filament lead wires still glowed, just slightly less. However, in the interim, I had built the mono 300B RF-powered amp, running at 2MHz, which had none of these problems (mainly because there was only one tube driven by RF!). The lessons learned from this are: 1. use a somewhat lower RF frequency, 2. don't have so many secondaries off of one RF torroidal distribution transformer, and 3. don't use tubes with such a low filament impedance. Using 6A3s or 6B4Gs would have been better than 2A3s.

Audio Results

Once the audio tube filaments had been tamed, it came time for bench tests and listening tests. On the test bench, the 2A3 amp had decent frequency response: down -1dB from about 30Hz to 25KHz, pretty good for a heavily transformer-coupled amp with no feedback! (This was with prototype Fi-Sonik transformers--production models have better LF response). The total harmonic distortion was typical for a no-feedback 2A3 amp: about 1.5% at 1 watt output and 5% at 2.5 watts, mostly 2nd harmonic. With the automatic RF leveling switched-in, the residual hum and noise was very low--less than 0.5 mV at the 8 ohm output.

The 2A3 amp was then put into my main listening system--replacing a Randall amplifier that was driving Altec 802 tweeters from 500Hz and up. Right from the start, the amp sounded fantastic! There was a degree of naturalness and presence that I had never heard before on the system. I then brought it to some audiophile friends in the San Francisco Bay area. It was also auditioned at one of the Bay Area Tube Enthusiast meetings at the Randall Museum. In all cases it was considered one of the best



amplifiers the listeners had heard. Needless to say, these were all systems with very efficient speakers, ranging from vintage Tannoys to Altec Voice of the Theater to custom-built horn systems. In most cases, the RF-driven amp replaced similar-powered SE amps. My big question then was: why did it sound so good?

There were a lot of sonically special things done in the amplifier that would help it sound good: shunt-feed output, nickel output transformer, high-quality interstage transformer, a filamentary driver tube, good N.O.S. output tubes, Cerafine electrolytics, some voltage regulation. But all of these have been tried (maybe not all together) without the knock-out sound quality I was getting. The best comparison was when I brought the amp to Niyom Nakarin's house. Niyom wound the output transformers, and his own SE system was full of nickel transformers and very finely tuned. He also was the one that turned me on to shunt-feed. His system was the closest to my 2A3 amp of all the ones I compared. The RF-powered amp sounded good to my ears there, and when I got back to Nevada a week later and called him, he said that he hadn't turned his own amp on in a week since he was ashamed of how his sounded compared to mine! The question now: was the RF filament system contributing to the good sound?

Round Two: The 300B Amp

Due to the packed chassis and the tightness of the design, it was hard to substitute DC supplies for the RF filament supplies in the 2A3 amp. I decided to build a test amp where the filament supply to the output tube could be easily changed between RF and DC, with no other parameters changing. I made the design more straight-forward: a mono Svetlana 300B amp with a One Electron UBT-3 output transformer, a 6EW7 dual triode driver, no regulation, and no Cerafines. I used the same Lundahl interstage transformer, though. The RF supply only had to deliver 6 watts to the 300B, so a simplified RF circuit

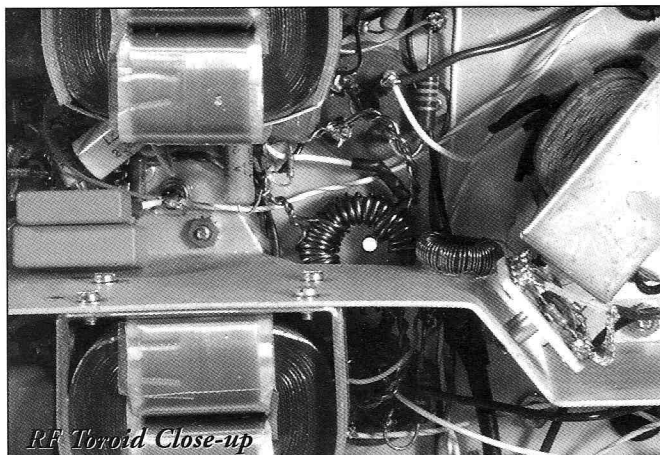

was used. A 6JM6 sweep tube is driven by the triode section of a 6AW8 running as a 2MHz crystal oscillator. The pentode section of the 6AW8 controls the screen of the 6JM6, and a 12AZ7 diff-amp amplifies the sense current signal. The B+ rectifier is a 5BC3. Despite being simpler, the RF control was tighter than the 2A3 amp, with the result that the residual hum and noise at the 8 ohm output was under 200 microvolts!

A DC power supply was built into the 300B amp that was sufficient to drive both the 6EW7 and 300B. It generates + and - 3.15V from an unregulated choke-input supply. Dropping resistors bring it down to + and - 2.5V for the 300B. To switch between RF and DC on the 300B's filament, a modified octal socket and plug were used to channel the desired power to the tube and the unused power to a 4 ohm dummy load. In other words, both the RF and DC supplies would see the same load, no matter what was selected to drive the 300B. This would keep operating voltages within the amp constant, so that the only variable being changed was the source of filament power.

A possible explanation for why the RF-powered 2A3 amp sounded good was suggested to me by Rene' Jaeger (formerly of Pacific Microsonics). He thought that perhaps the presence of a lot of RF in the audio circuits was linearizing the magnetics or nonlinear ohmic contacts, much in the same way that a high-frequency bias current linearizes magnetic tape. In order to test this, a circuit that could feed an adjustable amount of RF into the grid of the 300B was added. Thus three distinct modes of operation could be tested:

1. RF-powered filament
2. DC-powered filament, RF off
3. DC-powered filament, RF injected

At the maximum setting, the RF injection mode put over 10 volts of RF at the plate of the 300B, well over the 2 volts of RF measured at the plates of the 2A3s.

It turned out that with the filaments driven by DC and the RF generator driving the dummy load, there was considerable RF leakage into the audio circuits, so to truly test

the no-RF mode, the 2MHz crystal was pulled and the DC current through the 6JM6 manually adjusted to match the normal RF-mode value. If it turned out that simply the presence of RF was improving the sound, then a high-power, regulated RF generator wouldn't be needed--just an oscillator to inject RF into the audio stages.

Subjectively testing a mono amp is not as easy as a stereo amp, since the sound stage aspect is missing. However, I've long enjoyed listening to mono systems, and tried the 300B amp out on a favorite Stromberg-Carlson "Acoustic Labyrinth" cabinet with vintage Jensen drivers. I also tried it out on one side of the main listening system and in Niyom Nakarin's system. Overall, the amp was not as good sounding as the 2A3 amp. It compared well with good single-ended amps, but didn't have the magic of the 2A3 amp. Both Niyom and I independently came to the same conclusions when comparing the different filament power modes: with DC-powered filaments, there was no difference at all between the RF-off and RF-injected modes, and there was a barely perceptible improvement in the RF-powered filament mode. This threw cold water on the RF bias concept and made the RF-powered filament idea somewhat questionable.

On the test bench, when testing the amp for total harmonic distortion at 1KHz, with a 400Hz high-pass filter to eliminate hum, the THD was exactly identical for the RF-powered mode and DC-powered mode. This would suggest that the idea that non-linearities caused by one end of a DC-powered filament being at a different potential than the other end is either a negligible problem or is not cured by RF power. The residual hum in the DC mode was about 600uV versus less than 200uV in the RF mode, due to imperfect DC filtering. This possibly could explain why the RF mode sounded slightly better.

Conclusions or Lack Thereof

So where do these tests leave things? Does the lack of improvement found in the 300B amp show that the RF-powered filament concept is just a complicated way of heating filaments with no sonic benefit? Or is the effect such that the benefit is only revealed on an amp with the better quality parts, such as the 2A3 amp? Or, is it just that the 2A3 amp happened to be an excellent design regardless of the RF power? At this point the answer is not clear. I plan to build a stereo 2A3 amp that is very similar to the RF-powered 2A3 amp, but with DC power. If it has the same magic, then I will know that I've stumbled onto a good amp design, and won't pursue RF. It would also be interesting to see if RF has any impact on push-pull amps.

In any case, I wanted to put this research on RF-power audio amps out to the public and hope that others will experiment with it. It is an interesting confluence of classic radio technology and neo-classic audio design. Given the initial excellent results, it is something that needs more investigation. If you are interested in getting copies of the amp schematics or have more questions on my tests, contact me at: atwood@one-electron.com.

An Interview with David Hafler

Part 2: The Dynaco Years

By Charles Kittleson ©2000 All Rights Reserved

This is a continuation of the interview we conducted with David Hafler in May of 1999. The first part of the interview, in VTV #14, covered the early years and his affiliation with Acrosound. This part covers the Dynaco era.

When and why did you begin your own company, Dynaco?

I saw that there was a hole in the market. I had been doing a lot of customer contact, but not so much sales contact. I'd have people from all over the country write in with questions about using the Acrosound transformers. We had a brochure showing about three or four circuits and different power brackets. I would get people who would write in "Where do I buy the parts to do this?" I would speak by telephone with them or by correspondence. I found that I could handle a lot of normal sales activity as part of my general work. I saw the need for something other than just selling transformers through parts jobbers.

At that time, I was, and still am, into good sound reproduction. Back then, it wasn't easy for somebody to attain this. When I made my first amplifier, I went to a home of a friend whose father had a sheet metal shop, and he bent me up an amp chassis. I used a hand drill to drill the holes for hardware and used a Greenlee punch for the tube sockets.

I spent more time drilling holes in the chassis than soldering components into the circuit. I thought that there must be some easier way to do this. I saw that Heath was selling kits by mail order and they seemed to be doing a good business. I thought that there was no reason why

there can't be a kit of parts that would make it easy for somebody to assemble an amplifier and save some money over having a factory assembled job.

So with this thought in mind, I looked for suppliers who could take care of the printed circuit and chassis for me. I subcontracted all these things so it didn't take many people to run the business. With just a handful of people I had a small business operating without the difficulties and headaches of having a large workforce and the people to take care of it.

We had a little company where everybody did a little of everything and it was profitable. When I sold the com-

There are reasons . . .

WHY THE DYNAKIT*

50 Watt Hi-Fi Amplifier Kit

SOUNDS BEST

1. New High Stability Circuit

Superior transient response with greater clarity and definition. Designed for all speaker loads including electrostatic

2. Pre-Assembled Printed Circuit Board

Assures fool-proof assembly in less than 3 hours and guarantees faithful reproduction of performance specifications.

3. Superior Components Featuring the A-430 Dynaco Transformer

And of course the following minimum specifications that can be exceeded by any home constructor.

Power Output: 50 watts continuous rating, 100 watts peak. Distortion: under 1% at 50 watts, less than 1% harmonic distortion at any frequency 20 cps to 20 kc within 1 db of maximum. Response: Plus or minus .5 db 6 cps to 60 kc. Plus or minus .1 db 20 cps to 20 kc. Square Wave Response: Essentially undistorted 20 cps to 20 kc. Sensitivity: 1.5 volts in for 50 watts out. Damping Factor: 15. Output Impedances: 8 and 16 ohms. Tubes: 6CA7/EL-34 (2) (6550's can also be used) 6AN8, 5U4GB. Size: 9" x 9" x 6 3/4" high.



DYNAKIT Mark II
\$69.75 Slightly higher in West

*Pat. Pending
 (Complete including protective cover and all component parts)

NEW! DYNA BIASET now included in all Dynakits. Simplifies bias adjustment and assures optimum operating conditions.

1957 Dynaco Ad

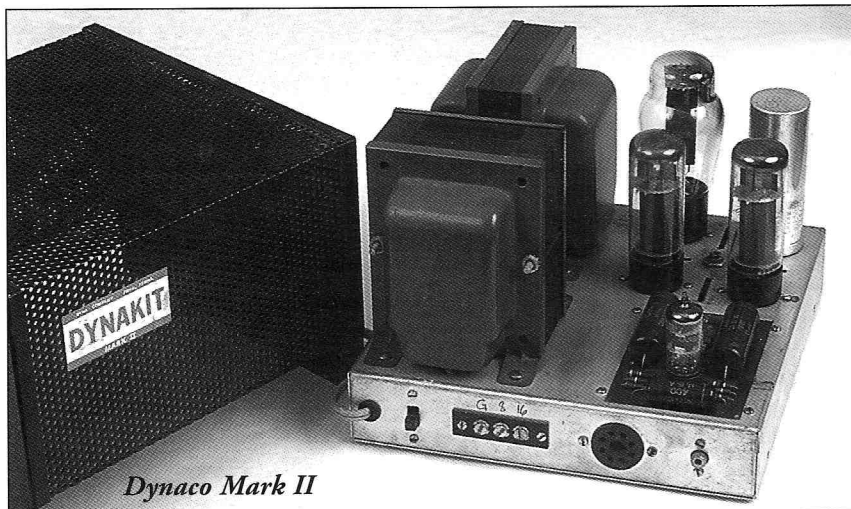

Dynaco Mark II

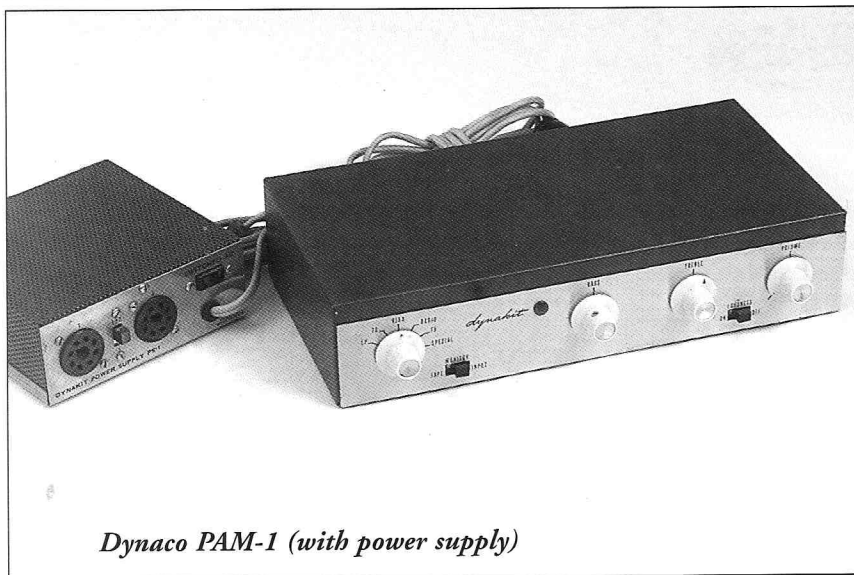

Dynaco PAM-1 (with power supply)

pany in 1968, we had 150 employees and were still subcontracting a good part of the production. I estimate that the total number of people working on Dynaco products must have been about 300 people.

What were your first amplifier and preamp products back then?

We had an amp that we called the Mark I, but it never went into production because it needed some modifications before it got too far. So that became the 50-watt Mark II. The Mark II was then superseded by the 60 watt Mark III that cost \$10.00 more but offered the freedom of 4, 8 and 16-ohm speaker taps and the new KT88 output tubes.

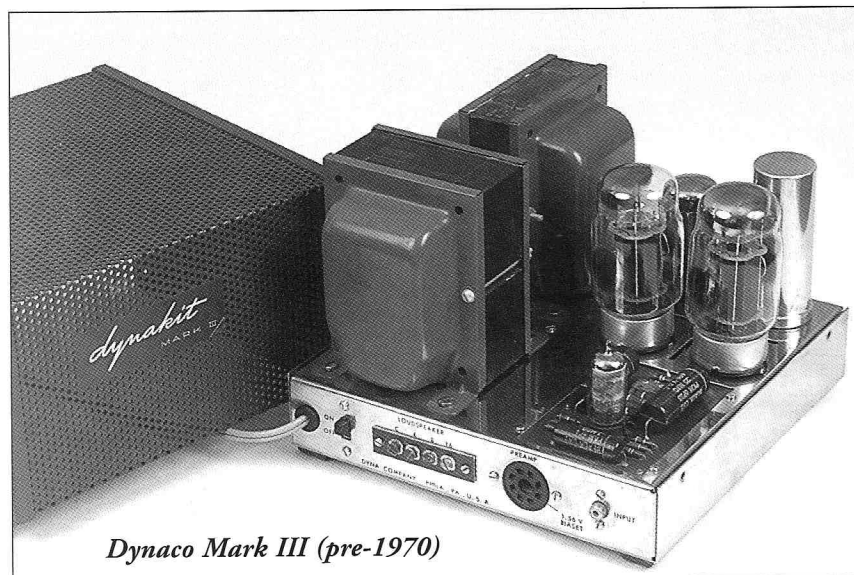

Dynaco Mark III (pre-1970)

There were speakers that specified a 4-ohm output including the AR speaker. However, the AR speaker required a high powered amplifier because it was very inefficient. We brought out an amplifier that did an excellent job into the AR speakers and the two coupled with each other very nicely. This turned out to be a great marketing arrangement because we could go to hi-fi shows and share the expenses. They sold speakers and we sold our amplifiers with no conflict of interest (laughter), but with complementary activity.

How did you initially market the Mark II and the PAM I preamp?

In 1955, we were making about 1,000 Mark IIs per month. That was fantastic business at that period. We had the demand for a preamp, but it wasn't quite ready. I had this preamp design which I had been carrying in my head for a long time. I did most of my circuit designing by thinking it over, rather than by bread-boarding it. The circuit used a feedback tone control arrangement that would be very simple and wouldn't require many tubes. I tried it and it worked and I arranged production. We used outside people to help style it.

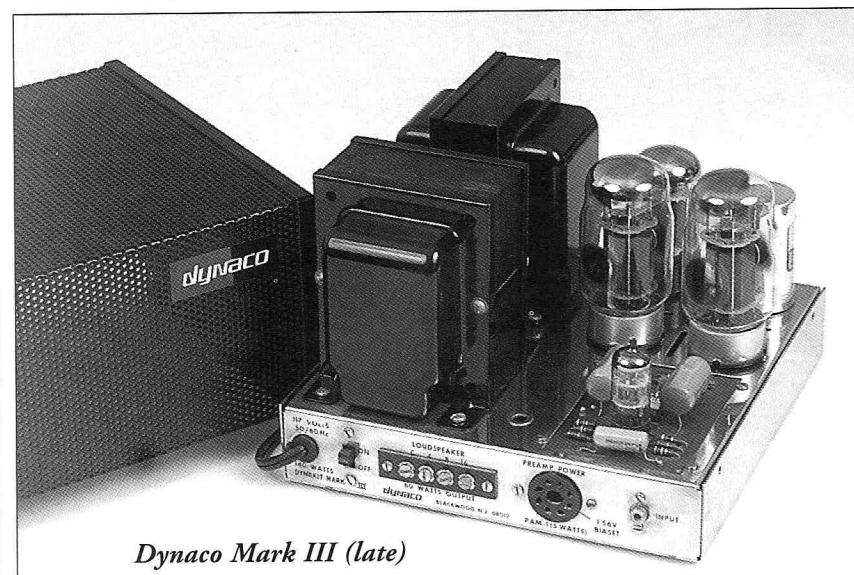

Dynaco Mark III (late)

Just about the time we were ordering parts, I noticed a peculiar kind of noise coming from it when it was turned up all the way. The prototype unit didn't have the noise problem. I tried everything that I could think of for weeks, and tried to pin the problem down. I even had Stewart Hegeman come in from New York to analyze the noise problem. He took a look at it and couldn't find the answer (laughter). I finally resolved the thing by taking the

preamp apart, piece-by-piece and interchanged them between my breadboard unit and the pre-production unit. I found that the low-noise resistors were noisier than anybody could have anticipated. They were just no good. It took me all that time to find it because they were consistent. They had the same harsh, rushing, waterfall kind of noise. That delayed shipping by several months at a time when the demand was really high. So when we started shipping, we had back orders for a couple thousand units.

Who did your sheet metal work back then?

Well, it started with a company called Dalco. This gentleman had migrated from Europe, who was a competent production man. He did a good job on stuff and his prices were good. After I found him, he did 95% of all of our work.

Who made your circuit boards back then?

A chap named Art Leibchur was working for a company called Avionics and broke off from them to set up a business for making printed circuits. I just found him in the classified pages of the phone book and started using him. He made some prototypes for me for the first hi-fi exhibit we had and then he made everything after that.

Who manufactured the Dynaco output and power transformers?

When Dynaco got started I knew of a company called Tresco that was located about 6 blocks from our factory. I was going to wind the transformers myself but I didn't like the idea of tying up money, buying new equipment, and the headaches of production. I went to visit the principals at Tresco and told them what I expected them to do. They made up samples for me according to my design. They sounded good and had pricing that was a very good deal for me. Eventually, I ended up buying 20% of Tresco. They supplied me everything I needed for years afterward and I turned out to be their biggest customer.

What was the very first Dynaco output transformer?

The A430 was first and the A431 just added the 4-ohm tap.

The A431 was your design?

Yes, but I used the same long-tongue EI arrangement that Herb Keroes had used with the Acrosound design. It used a long,

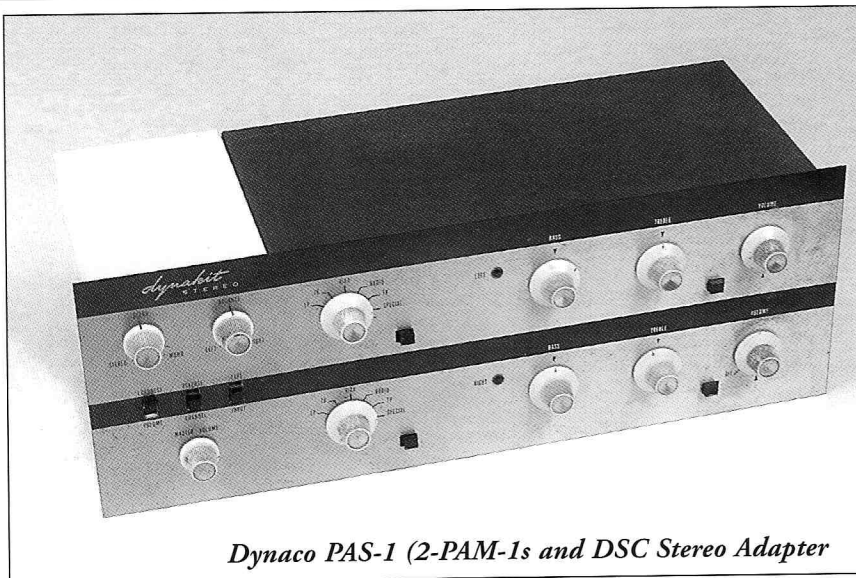

Dynaco PAS-1 (2-PAM-1s and DSC Stereo Adapter)

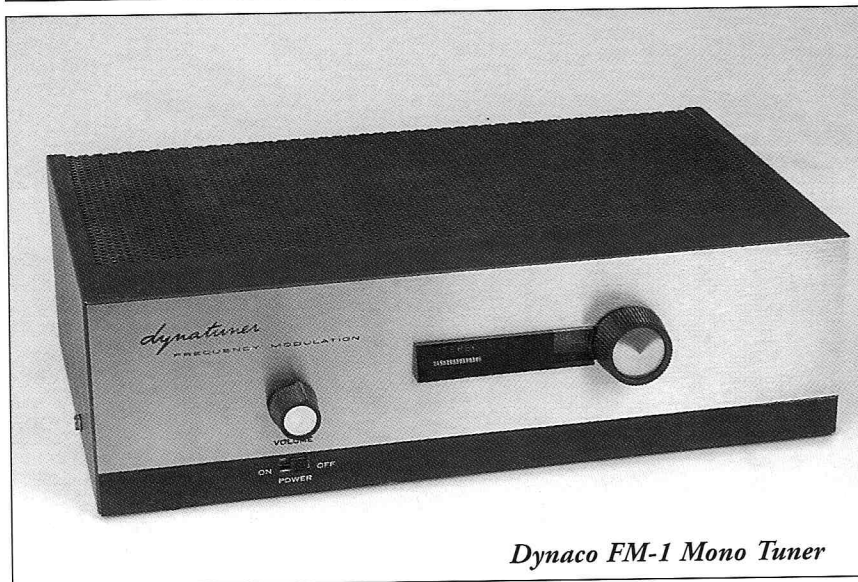

Dynaco FM-1 Mono Tuner



Dynaco PAS-2 Stereo Preamp

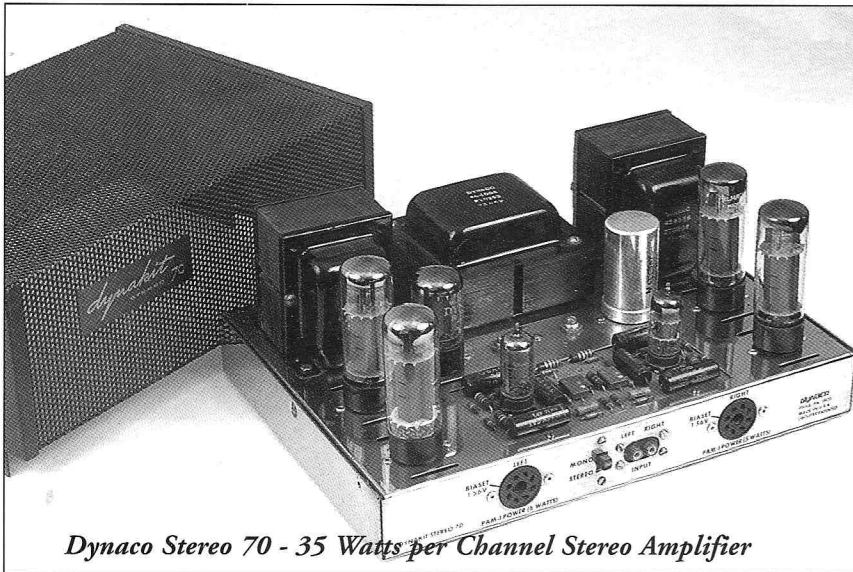

Dynaco Stereo 70 - 35 Watts per Channel Stereo Amplifier

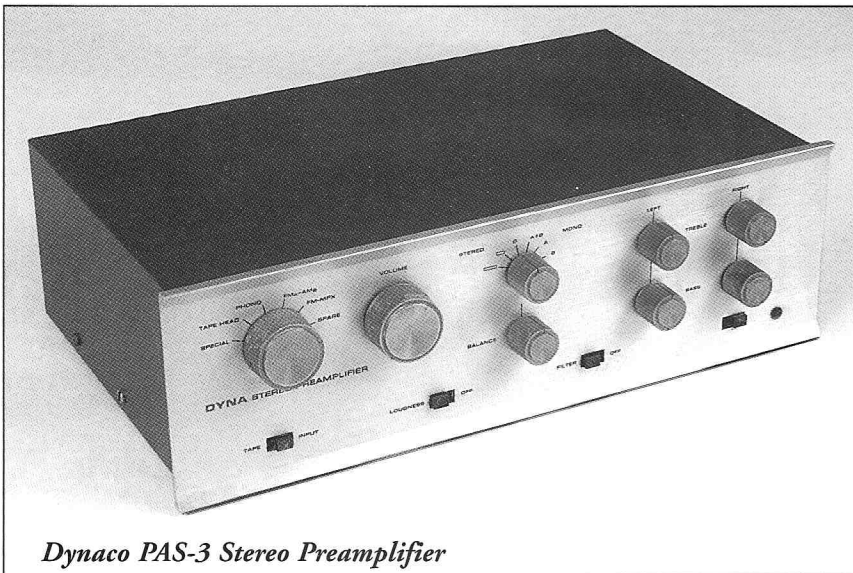

Dynaco PAS-3 Stereo Preamplifier

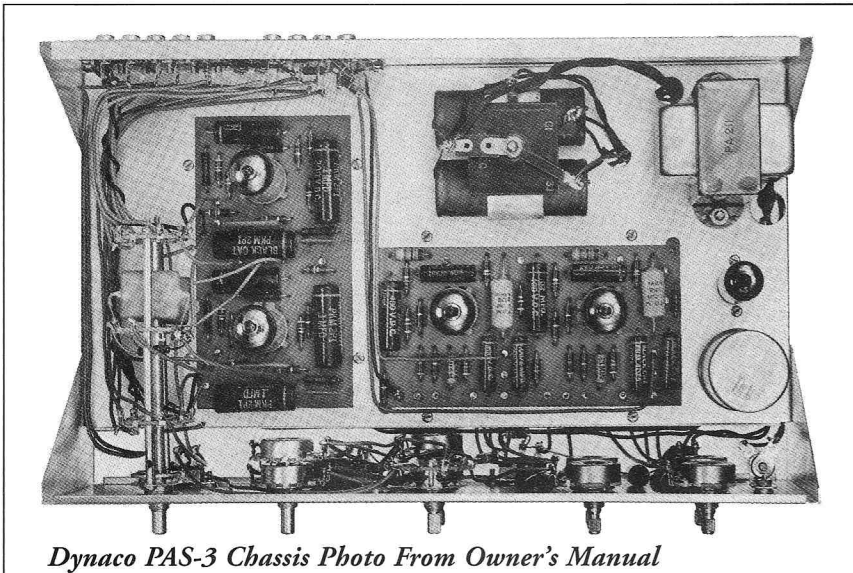

Dynaco PAS-3 Chassis Photo From Owner's Manual

narrow coil.

What about the winding arrangement in those transformers. Are they different than the Acrosound?

Oh yes, they are definitely different. I had a patent on the Dynaco transformers.

Is that patent still in effect?

No, the patent was only good for 17 years.

What were some of the unique winding features of the Dynaco design transformers?

The Dynaco design had something that was very rarely done, I had not seen anybody do it in output transformers. It inverted part of the winding. The coil was spun in the opposite direction and windings were put in parallel, criss-crossed sections. It is a little hard to describe. It was interweaved through a parallel connection rather than series connection which I had not seen other transformers use.

So the transformer had four winding sections. The first and third were wound in opposite phase and inserted backwards in order to make it work out. The secondary came in between the first and third or second or fourth sections. This is hard to describe without drawing a diagram. You could probably find that patent very easily if you wanted to look it up. It shows that both series had parallel arrangements. Both of them were unique with that step over.

What core material was used in the transformers?

I don't recall. Tresco brought this in for our use.

You also came out with some potted versions of those transformers that were kind of the deluxe line. Were they a better grade of transformer or was it just cosmetics?

Well actually there weren't any standard end-bells available for the larger sizes, 60 watts and above. These included the A440 and A450 models. They looked good and I guess the end-bells didn't look as nice as the sheet metal cans. They were not the same as the deep-drawn cases that we used with the Acrosound transformers.

Were you involved in all the designs of the transformers, such as the A470 for the Stereo 70, or the Z565?

Those were just derived from the basic

unit. The A430 was the starting unit and to make it smaller or make it larger was just a matter of changing the wire sizes, turns ratios and the size of the lamination stack. They were straightforward measurements and calculations. Tresco, based upon our specifications, designed the power transformers.

Did you use any other transformer vendors or imports?

The only thing that was made overseas, when I was still there (up until 1968) were some of the chokes.

Did you design the whole kit process?

The first ones I did myself completely. After that Bob Tucker got involved. He was very good at thinking of what problems a customer might have and trying to eliminate them. Anything that we were going to put out, he field tested it very thoroughly. He assembled them himself to write the manual. We also used people, who were not skilled, to assemble the kits under Bob's watchful eye. He could see where they ran into problems and make adjustments. The manual was an important part of the kit, of course. I think we had it down to at least as good as Heath and better than EICO and other kit companies.

Was Stewart Hegeman involved in the design of the FM3?

Yes, he worked on the FM-1 and the FM-3. We had a deal with him where he got paid, I don't remember exactly just how it worked out, but it made him a nice sum by the time it was finished. Unfortunately for us, we had to bring somebody else aboard to finish it up because Stewart was a guy that never finished a design.

Who designed the other units like the PAS3, the SCA35?

I was involved in all of the tube designs. Ed Laurent did most of the conversions from preamp to integrated amps. He did a good part of the mechanics. Actually, for practical purposes, I was chief engineer and in an administrative sense, Ed did mechanical design and stuff like that. I was involved in everything since I had started the company when I was the first person in it. I knew how to do everything that was done inside the company. I knew how to keep the books. I knew where to buy the components and it was a one man oper-



Dynaco FM-3 Stereo Tuner

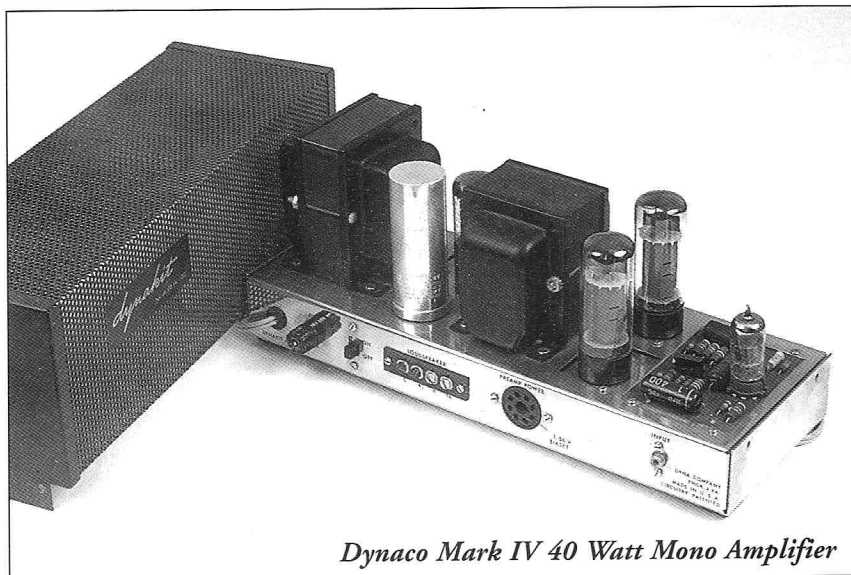

Dynaco Mark IV 40 Watt Mono Amplifier



Dynaco SCA-35 Integrated Amp

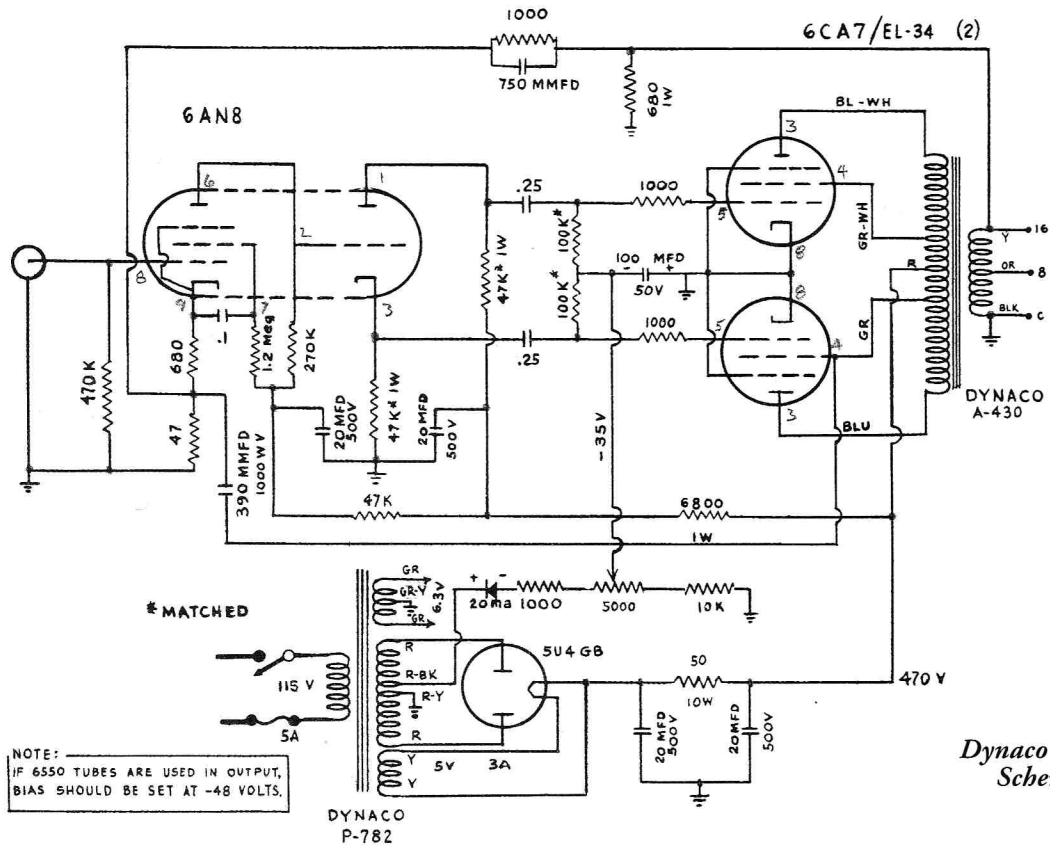

Dynaco Mark II Schematic

DYNAKIT MARK III 60 WATT POWER AMPLIFIER

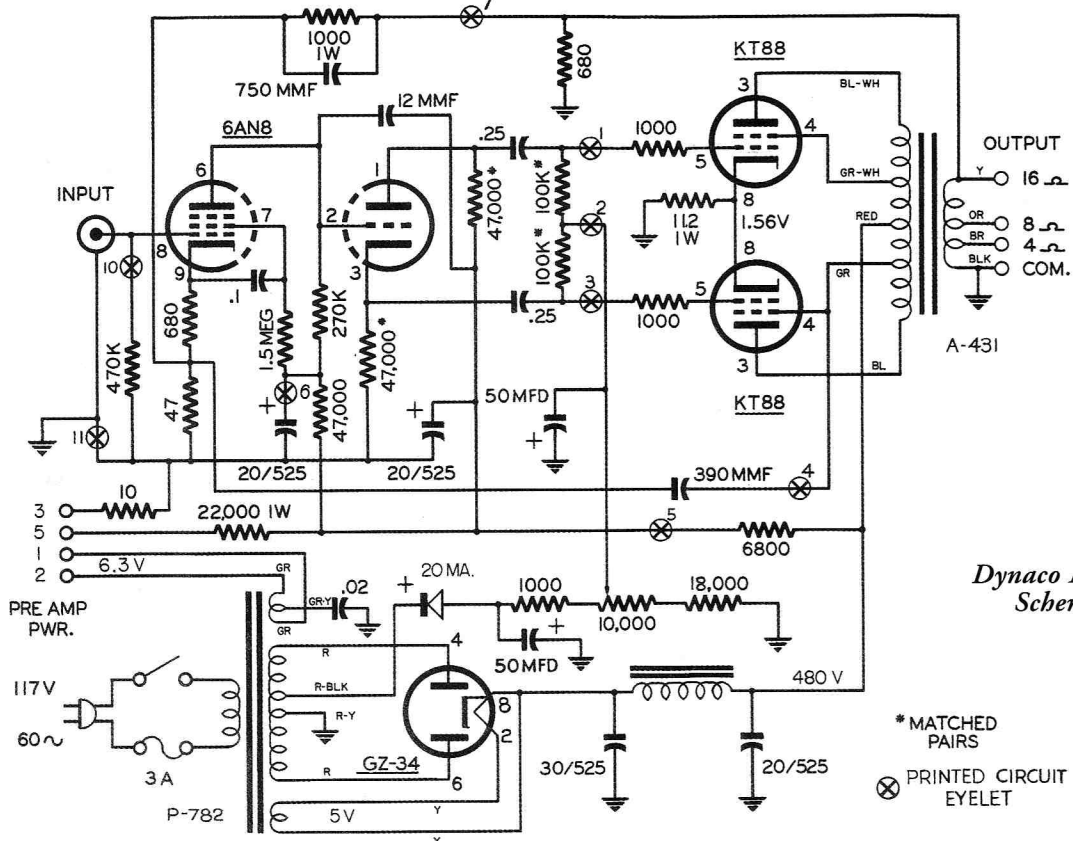

Dynaco Mark III Schematic

ation for quite awhile. One man with assistants, let's say. It was only gradually that I was able to delegate some of the work over to other people. At the time when I left, I think the organization had gotten to where we had a quality control man and other specialists.

Let's talk a little about some of your design philosophy. You used the 6AN8 and 7199 as driver tubes. What were your criteria in using those tubes?

The normal criteria to choose any tube. Low noise is one. Most people don't realize that you have hum in some of these things just because of the internal construction of the tube. What we found was that Sylvania 7199 had less noise than the RCA. We would pick tubes on the basis of noise or distortion if we found a difference in distortion. I think it is very difficult how you pick tubes because you are balancing one thing against another.

Did you use a combination driver tube to keep costs down?

The combination driver tube was done initially because it was space saving and saved costs without sacrificing anything.

What about output tubes. What were your selection criteria?

There are differences because some output tubes require higher voltages. So to have a decent safety margin you have to allow for the fact that you can't use the maximum voltage all the time. Hum was usually not a problem, but distortion levels were an important characteristic.

What were your favorite EL34s?

We used Mullard EL34s, because the Mullard salesman got to us first and he got friendly with the engineers, people who would have some say. They were aggressive sales people.

In the Mark III amps, you used the Genalex KT88s?

When the KT88 was first designed, Genalex came to me with samples of the tubes and they looked ideal. It handled more power than the Tung-Sol 6550s and we knew they were good tubes, so it was a natural. Also the KT88s had lower levels of distortion than others that we had used previously, but that was in a range below audibility.

During the mid to late 50s, which was kind of a golden era, if you will, of hi-fi in this country, were you influenced by any other designers, when you were producing your kits? Was there anybody that had major influence on you?

No, in fact I think it's the other way around. I had major influence on them (laughter).

I would say so too (laughter)!

Actually, when I think about it, things that I did as routine back in the 70s were still not adopted by the bulk of practitioners; Little tricks of the trade, like how to bypass input shielding in preamps, stuff like that. People who had been in the business and making designs for years and years still had not picked up those little things.

Were you impressed with any other manufacturers equipment back then, even though it might have cost more?

There wasn't anything I saw that cost more, that would contribute to the sound. I think that I was able at that time to pretty well convince most people that our equipment was the best. And when I say the best I don't mean the most expensive. I think we were ahead of the whole industry in terms of being able to produce a low distortion and accurate amplifier. Some people made it more expensive and sometimes they used more expensive components that were more than necessary. Some designers had their own wild circuit ideas, some of which worked in the field and many of them really didn't do anything special. I felt there was not a direct correlation between price and quality. This is especially true if you define quality as accuracy.

The Dynaco Stereo 70 was probably the most popular tube stereo amp. When did you start thinking about building a stereo amp? What motivated you to get into this?

The first demonstration of stereo records were in the late 1950s. The stereo tape recorders of the era were not very successful. Plus, there wasn't any reason to change equipment because there was very little binaural program material to be played. There was very little emphasis in promoting it in the 50s. But when the first records came out it, it gave consumers a chance for an easy conversion to stereo and gave retailers an opportunity to raise the price.

What year did you come out with the Stereo 70?

The Stereo 70 came out in late 1958 or early 1959. However, first we had the stereo adapter so that you could hook up two PAM-1 preamps to two Mark III amplifiers. I guess this got us into stereo earlier. That was a way of salvaging what was in the market already and selling consumers another preamp to line up with what they already had. It was a practical approach and it worked. The stereo tuner, I guess, came along in the early 60's.

Did you sell more Dynakit's than assembled units?

The kits were more popular in the beginning. In the later days, the kits became less popular because people didn't mind spending the extra few dollars for an assembled unit. Then there's always a little fear from people who put kits together that they were not getting the best results. There was always a market for assembled ones at any price level but we did it at a competitive price level.

Did the kits present much of a problem from a technical support standpoint?

No, because we debugged the assembly manuals to the point where they didn't make incorrect assemblies. But there were always a few people who just never could make something work because they couldn't solder point A to point B. We had a very inexpensive service policy, I think we only charged either \$5.00 or \$10.00 to fix any kit problems. We had two service techs at the factory handling kit issues and other service jobs. These guys handled up to a thousand pieces of service work in a month sometimes.

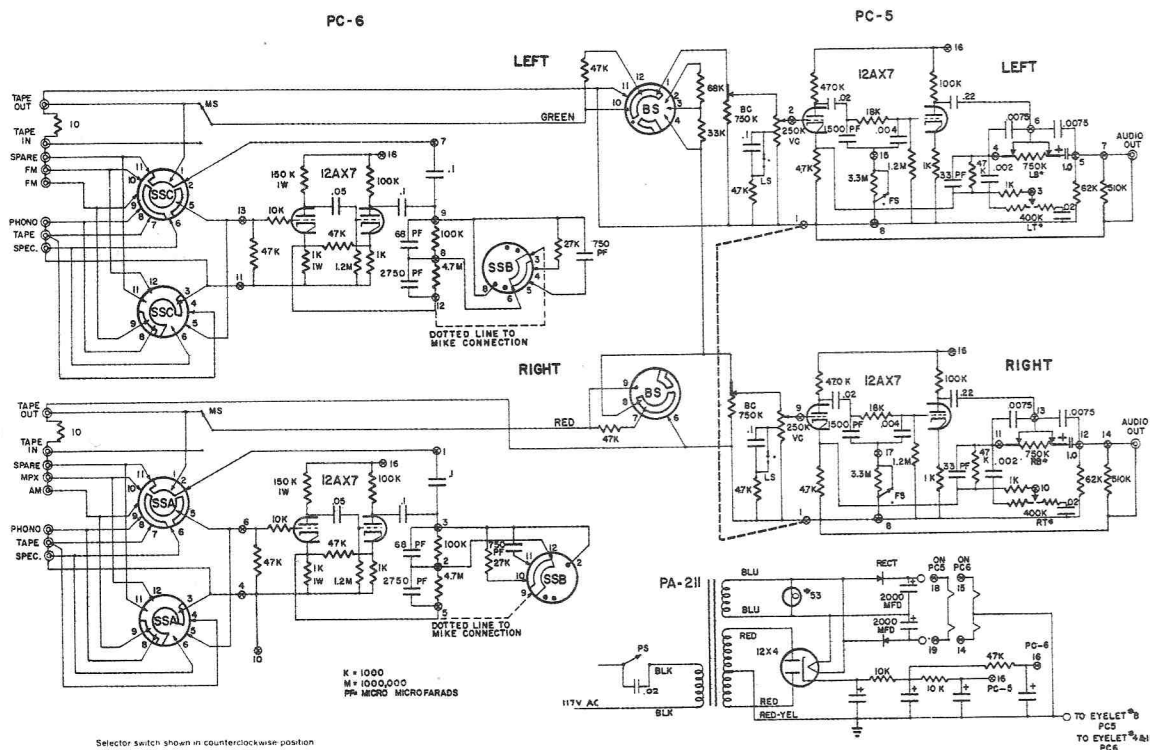

VOLTAGE CHART
 Tube pins numbered clockwise viewed from the bottom.
 All readings taken from pin to chassis (except #3 and #4 of 12X4) using a vacuum tube voltmeter.

Either tube PC-6

1	115 V DC
2	0
3	7 V DC
4	0
5	11 V DC
6	135 V DC
7	0
8	.8 V DC
9	5.5 V DC

Either tube PC-5

1	175 V DC
2	0
3	1.45 V DC
4	Less than 1 volt
5	11 V DC
6	200 V DC
7	0
8	1.25 V DC
9	5.5 V DC

12X4

1	335 V AC
2	0
3	10.5 V AC
4	0
5	0
6	335 V AC
7	405 V DC

Quad Filter Capacitor

- 405 V DC
- ▲ 355 V DC
- 330 V DC
- ▲ 210 V DC

Dynaco PAS-3 Schematic

www.AUDIOCLASSICS.com

Buy - \$ell - Trade - \$ave

High End Audio - Home Theater Systems

featuring products by: McIntosh, Krell, Sunfire, Marantz, Elite, Tannoy, Audio Research, Lexicon, Cary, Cardas, VPI, Sharp, JBL, Mirage, Bryston, conrad-johnson, New Castle, B&K, Audio Control, Acurus, Aragon, Thiel & more.

3501 Old Vestal Road, Vestal, NY 13850
 607-766-3501

www.StereoFactoryOutlet.com

Save on Refurbished and Discontinued AV components.

for stuffing fiberglass in the bass reflex port to make the bottom-end more damped. The way he did it worked well and we paid him a percentage for the first 10,000 speakers or some such value, I can't remember now the exact details. So he took the credit for designing it even though he and Skoning actually worked out the parameters jointly. It came down to two final speaker designs. The two of them looked alike and had essentially the same specs but they sounded entirely different. The one I picked turned out to have an aluminum voice coil instead of a copper voice coil, so it had a good low bass response and a nice sparkle at the high end.

How many A25s do you think Dynaco sold?

Bob Tucker once told me they had passed the one-half million mark. He kept track of those kinds of things.

While we are talking about production figures, let's go down the list of the tube products. What are your estimates of tube equipment production figures?

I did make a couple of notes based on what I knew about production figures up until I sold the company in 1968. These are more approximations than exact numbers:

Mark II - 30,000; Mark III - 85,000; Mark IV - 55,000; Mark VI - 1,000; PAM 1 - 120,000; Stereo 70 - 250,000; ST-35 - 65,000; SCA-35 - 80,000; PAS-2 and PAS-3 - 500,000 (combined); FM-1 and FM-3 - 200,000 (combined) (NOTE: for more descriptive information on Dynaco Equipment, refer to VTV #1 p 5-7)

Even though I sold the company in 1968, I stayed on as an advisor through 1971. The above numbers do not reflect production figures during that period. (Note: David estimated that the total number of Stereo 70s made through 1977 is over 400,000; PAS-2/3s >600,000 and Mark IIIs >125,000)

Did you sell many products overseas?

Yes, because most people didn't do any business overseas at that time. A lot of the overseas business went to McIntosh, who did a good job because their high price made it a very attractive item in the Japanese market. We sold more units than McIntosh did, but they sold more dollars into that market because their prices were so high.

You had a fairly good market in Japan then?

For a while there Japan did very well for us, buying 5,000 units at a clip.

What about Europe?

We set up our own distribution company in Europe and did well, we got about 20% of our business out of Europe. At that time that was very, very good because, let's face it, most American companies did very little in Europe and especially in Japan.

What was your favorite Dynaco amplifier?

I guess the Stereo 70 because it worked well, was inexpensive and was adequate for three-quarters of all people.

The remaining quarter needed higher power, mostly because they played it loud or because they had inefficient speakers, like electrostatics.

So your favorite loudspeaker would probably be Dynaco, right?

Yes, I did think they were great speakers for the time and price.

In VTV #4, we did a vintage speaker article and listening evaluation. Our listener panel found that the A25 was one of the best-sounding vintage bookshelf speakers, so that still holds true today.

I agree. Also, as a general class of speakers, I like electrostatic designs, but you need a lot of power to handle them properly.

What were your first solid-state amplifier and preamplifier?

The Stereo 120 and the PAT-4, which were brought out in the mid-1960s.

Why did you decide to go into transistors?

People were clamoring for them. They wanted them. I would say, in terms of listening, there wasn't any essential difference between tubes and transistors. If there was a difference it wasn't because of tubes versus transistors, it was because they may have been trying to drive wrong size speakers, with the wrong size amplifiers.

We have quite a few readers who would disagree with you on that, David! Who designed the transistor equipment?

Ed Laurent and his technical staff did much of the design. Then Erno Borbely, who we imported from Norway, was also involved in the design and final details. He was a very

SILVER SONIC™
Audio Cables

Making the High End Affordable!

"With tube amps and hybrids, the Silver Sonic competed with the best."
Bound for Sound

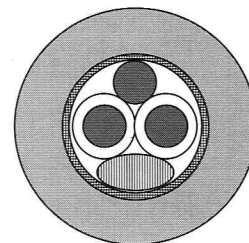

Silver Sonic T-14 Speaker Cable
Silver Sonic BL-1 Series II Interconnect
Silver Sonic D-110 AES/EBU Digital
Silver Sonic D-75 Digital Cable
Hook up wire & Connectors

D.H. Labs, Inc.
612 N. Orange Ave., Suite A-2
Jupiter, FL 33458
(561) 745-6406 (phone/fax)
www.silversonic.com

careful and methodical guy. A lot of the new things, I would personally suggest and tell them to "try this."

So you were making both tube and solid-state equipment in to late 1960s?

Yes, but the tube stuff was fading down at that point.

After you left Dynaco in 1971 as an advisor, how long did they continue to make tube gear?

I would say to approximately 1977 or so.

When and why did you decide to sell Dynaco?

I reached a certain age where I decided that being a workaholic was getting old. When I first started Dynaco in the mid-1950s, I had two full-time jobs and two part-time jobs all running at the same time. When somebody had to do all the legwork, it turned out to be me.

Was the fact that the Japanese audio companies had significant volume in the US hi-fi market a consideration in your decision to sell Dynaco?

The Japanese thing came a little later. They did a good job and sold product at realistic prices. They started out kind of weak and ended up very strong.

Who bought Dynaco?

Tyco Laboratories bought it from me. Tyco had the idea that anyone who took a business course at Harvard could manage any type of company anywhere. They felt like it was always the same only the details varied.

What are your thoughts about what is occurring in consumer audio today?

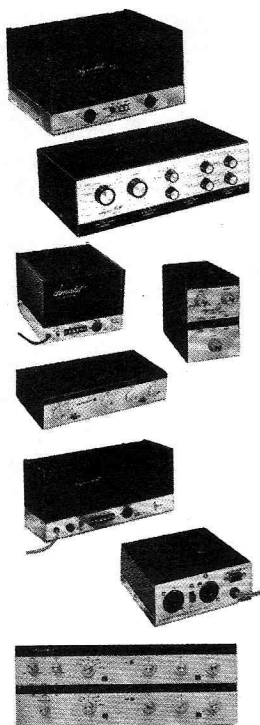

STEREO 70

Two 35 watt super-quality amplifiers for stereo or 70 watt monophonic use. Premium quality parts and uncompromised design for finest performance with all loudspeakers. Pre-assembled printed circuit design enables 3 hour assembly. EL-34 (4), 7199 (2), GZ-34, selenium rectifier. Nickel chassis and charcoal brown vinyl, 13" x 9½" x 6½", 32 lbs. Complete with cover, all parts and instructions \$99.95.

STEREO PREAMPLIFIER PAS-2

The famous DYNA preamp circuit adapted to stereo. Complete control, with absolute minimum distortion and noise, plus power supply. DC heaters, less than 0.05% IM, 60 db gain from 3 stereo low level inputs, plus 4 high level stereo inputs. Features exclusive Dyna Blend Control to eliminate the "hole in the middle". Two printed circuit boards for 8 hour assembly. 13" x 8" x 4", 11 lbs. Complete \$59.95.

MARK II

The 50 watt amplifier which made audio history. Similar to Mark III, below, but with 8 and 16 ohms only. \$69.75.

MARK III

The outstanding 60 watt amplifier. Unmatched performance and stability on all loads with pulse and square wave tests. Features Dyna Biaset for simplified adjustment. Three hour assembly with prefabricated printed circuitry. 9" x 9" x 7", 28 lbs., 4, 8, 16 ohms \$79.95. With added 70 volt output Mark III-70 \$84.95. 220 volt Mark III \$84.95.

MARK IV

A 40 watt analog of the Mark III, similar to one-half the Stereo 70. Assembly time 3 hours. Uncompromised performance and utmost reliability. 5" x 14" x 6½" high, 20 lbs., complete with all parts and protective cover \$59.95.

PREAMPLIFIER PAM-1

The famous "no distortion" preamp which made audio history. Accurate equalization, minimum noise, utmost flexibility, yet amazingly simple—6 hour assembly. Requires 300 volts @ 4 ma, 6 volts @ .75 amps—from amplifiers or PS-1. Brown or white finish, 7 lbs., 12" x 6" x 2¾", \$34.95.

STEREO CONTROL DSC-1

The simple solution to "step up to stereo". Plugs in to Dyna or similar preamps to provide centralized control and complete switching facilities. Exclusive Dyna Blend Control. No noise, no distortion, no loss. Brown or white, 2½ lbs., matches Dyna preamplifiers. \$12.95.

PANEL MOUNT PM-25 CABINET SET CM-25

Single front panel and brackets for panel mounting two Dyna preamps and DSC-1 \$5.95. Panel and walnut cabinet for same \$17.95.

DUAL POWER SUPPLY

For powering 1 or 2 preamps. Well filtered, with separate heater windings for individual hum adjustment. \$8.95.

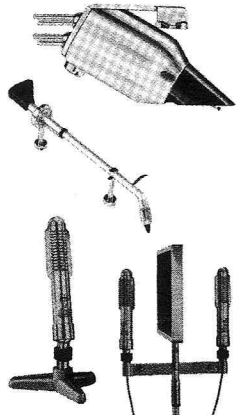

STEREODYNE II PHONO CARTRIDGE

Without equal for stereo or mono reproduction. Uniform high compliance, minimum dynamic mass, high output, no hum pickup, no turntable attraction—all the vital features for minimum record and stylus wear, plus the highest channel separation over the entire spectrum. With replaceable diamond \$29.95.

STEREODYNE ARM-CARTRIDGE

The STEREODYNE phono cartridge is united with a modern tone arm for unexcelled stereo or mono performance, and unmatched convenience in installation and use. Dynamic balance and gyro pivoting enable 2 gram tracking with perfect groove contact even if turntable is jarred. Detachable cartridge and replaceable stylus. Single hole mounting. \$49.95.

B&O MICROPHONES

The finest ribbon microphones made. Utmost versatility, ideally suited for stereo applications with the Stereo Spacer, achieving remarkable ease of installation, optimum separation, consistent balance. B&O 53 has 50 Ω, 250 Ω, Hi-Z switch \$59.95. B&O 50 for 50 Ω use only, \$49.95. Accessory Stereo Spacer, Dual Microphone Mount, \$14.95.

DYNACO SUPER FIDELITY TRANSFORMERS

Featuring para-coupled windings, this patented design insures superior wave forms under all transient and pulse tests. Full rated power 20 cps to 20 KC, double nominal power from 30 cps to 15KC.

MODELS

A-410	15 watts	EL-84, 6V6, 6AQ5	\$14.95
A-420	30 watts	5881, EL-34, KT-66	19.95
A-430	60 watts	KT-88, EL-34	29.95
A-440	120 watts	KT-88, 6550	39.95
A-450	120 watts	pp par KT-88, EL-34	39.95
A-470	35 watts	EL-34, pp par EL-84	24.95

Specifications

Response: ± 1 db 6 cps to 60 KC. Power: within 1 db 20 cps to 20 KC. Square Wave: No ringing from 20 cps to 20 KC. Permissible Feedback: 30 db.



DYNAKITS MAY ALSO BE OBTAINED COMPLETELY ASSEMBLED AND TESTED Prices slightly higher in the West
DYNACO INC., 3916 POWELTON AVENUE, PHILADELPHIA 4, PA.

You are not going to like my feelings, I'm afraid. There is a big rip-off going on. Companies are selling extra high-priced equipment that has no benefit except a high profit to the company that sells it. I don't think that many of these fads that come along are true advances.

Computing with Tubes The Savage Art

7. The First Mobile Computer

By Eric Barbour ©2000 All Rights Reserved

What was the first electronic computer designed especially for use while on the move? It wasn't the Osborne I or the Radio Shack Portable 100. It wasn't a minicomputer mounted in a truck. There were a few exotic machines in the 1950s, built into a tractor-trailer and intended for mobile use by battlefield commanders. This would include the National Bureau of Standards DYSEAC (1954) and a similar machine built by Sylvania in 1955. Still, these were unwieldy devices which required either connection to AC power mains, or a separate motor-generator.

The first digital electronic computer to be manufactured for use in a MOVING vehicle was the Hughes Advanced Airborne Computer, aka the "Digitair." Introduced in 1955, it was widely seen aboard USAF aircraft.

The world's first supersonic bomber, the Convair B-58 "Hustler," carried a Digitair. The B-58 embodied the first successful use of a digital computer in aircraft navigation systems. Indeed, the B-58s all-tube electronics were so complex, and ran so hot, that the jet developed a reputation for smoke in the cockpit, due to burning insulation.

Digitair's CPU was binary, 17 bits per word, using fixed

point arithmetic. Instructions were 15 bits long. Like most tube computers, it used serial-sequential operation; and rather than a master clock oscillator, the CPU was clocked from a 162 kHz square-wave track permanently recorded on the memory drum, so supply-voltage variations would not harm clock-sensitive operations. Add time was 0.2 msec.

All the memory was on the magnetic drum. It held 1984 words, access time 3.75 msec, with a special fast area for 8 registers, having an access time of 0.4 msec. The Digitair was also special in that it had analog I/O: an A/D converter, all tube, 0-100 volt input range, with a conversion time of 200 microseconds; plus a D/A converter, all tube, with 0-100 volt output, plus some assorted switched and pulse-length outputs. This was necessary, since it was intended for aircraft navigation applications. A Flexowriter could be plugged in for maintenance, testing, and entry of software into the drum.

Digitair had 481 tubes, all subminiature types, for obvious reasons. This is another lost technological world--many people born since 1960 have no idea that such tiny tubes were once manufactured in great quantities. And in military equipment like the Digitair, subminiature tubes were usually soldered into their circuit modules. So they HAD to be reliable and long-lived. Like many similar small computers, Digitair used a total of 3364 germanium diodes to accomplish various gated logic.

Unlike any similar tube computer, Digitair's size was a puny 5 cubic feet. The CPU cabinet alone occupied only 0.6 cubic feet. I/O, power, and drum memory were in separate cabinets, all modular and easily swapped in the field. Power consumption was 1500 watts, at 28vdc, using the included dynamotor power supply. (For the younger readers, a dynamotor was a small DC motor connected to a generator, which produced high voltage DC plate power for tube electronics. Dynamotors were ubiquitous in WWII-Korean War era aircraft, to provide power for the radios and other equipment).

It is said that Digitairs were kept in service in various military jobs until the 1980s. (Other than the B-58s, most of which were scrapped in 1977). This may help explain why Raytheon, Sylvania and GE continued making mil-grade subminiature tubes until the late 1980s. Although a few hundred Digitairs were made, if you stumble across one in a seedy surplus dealer's shop, buy it; because in the next century, Digitairs will be scarcer than Apple Is, and are likely to become highly desirable as collector's items. Luckily for collectors, a Digitair takes up little more space than a PC.

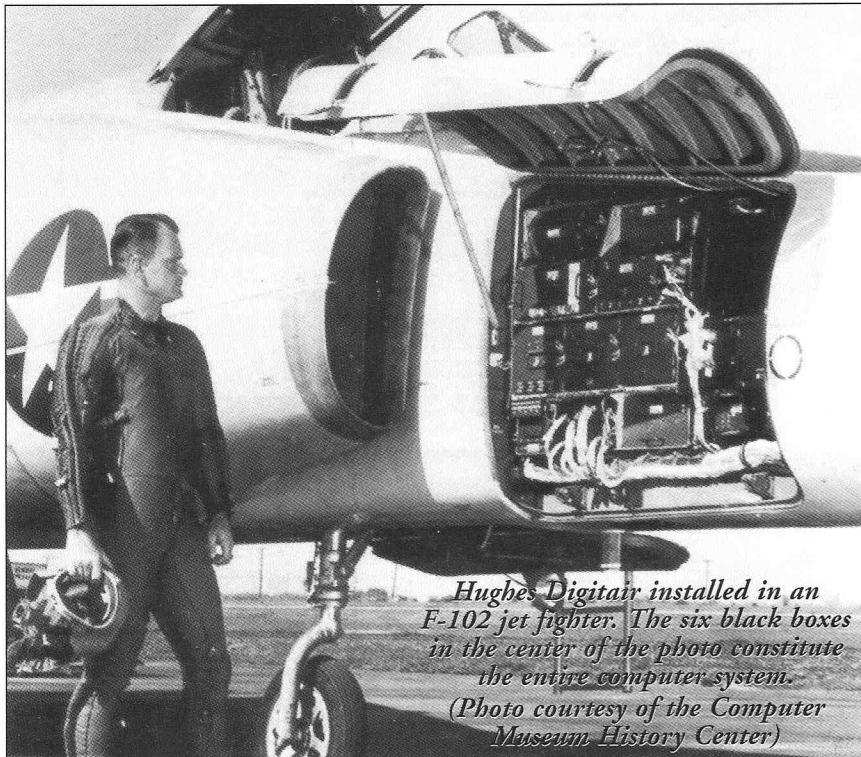

Hughes Digitair installed in an F-102 jet fighter. The six black boxes in the center of the photo constitute the entire computer system. (Photo courtesy of the Computer Museum History Center)

12AX7 Shootout

Part 2: Hi Fi

24 Types Tested

By Charles Kittleson ©2000 All Rights Reserved

In the last issue of VTV we reviewed 12AX7s in guitar amplifiers. In this installment, we evaluate 12AX7s in a true high-end audio system. We were able to evaluate 24 different types of 12AX7s, both NOS and current production.

Our tube shootout host was Don Palmer, a long-time Bay-Area audiophile and tube enthusiast now located in the heart of beautiful wine country in Napa County, California. Don's equipment included the following: LA Audio (Lennart Anderson) C3 stereo tube preamp (2-12AX7 line stage) and P3 Gold 120 watt monoblock amplifiers (12AX7, 12BH7, 4-KT88); Electrostatic Research Illusions cone/electrostat hybrid loudspeakers; cabling and power cords by Highwire Audio; room treatment by Echobusters; and a Technics A-10 DVD player with custom power cords, RF suppression and Black Diamond Mark 3 cones and round vibration dampers.

We listened to three types of music including jazz, classical, and female vocal to give us a diverse perspective. Our listening panel consisted of David Bardes, Steve Parr, Rodger Coon and Don Palmer. I acted as the "tube jockey" and pre-heated all the tubes before they went into the pre-amp. Again, we did the test "blind" so no one knew what tube was being played at the time of the evaluation. This tended to reduce the "favorite brand" effect.

Please note that this test was done using a high-end system that was dry and balanced towards the upper

Terms for Subjective Tonal Evaluation

Coloration: The emphasis on a particular frequency range that is noticeable or prevalent, i.e., warm, cool, harsh, etc.

Dynamic Range: Sonic performance from the quietest to the loudest, including the subtle differences in macrodynamics and microdynamics.

Transparency: How far you can see (hear) through to the musical source. The lack of any veiling.

Frequency Extension: Perceived bandwidth from the lowest to the highest frequencies.

Musical Involvement: The degree that you get sucked into the music. How much the music "grabs" you.

Three Dimensionality: Accurate portrayal of relative instrument placement and front to back soundstage.

Pace and Rhythm: The proper emphasis of musical syllables and phrases. Does the music make you feel like dancing?

midrange and higher frequencies. The electrostatic speakers tend to sound drier than a typical dynamic speaker system. Results could be different in a vintage system or with your particular components. The tubes we tended to favor in this system were slightly on the "warm" side.

Also remember that tubes break in over a period of several hundred hours and can mellow with use. Additional factors that can affect tonal coloration include year of manufacture, batch differences, and whether a tube is new or used. We used all new tubes or NOS that were pre-

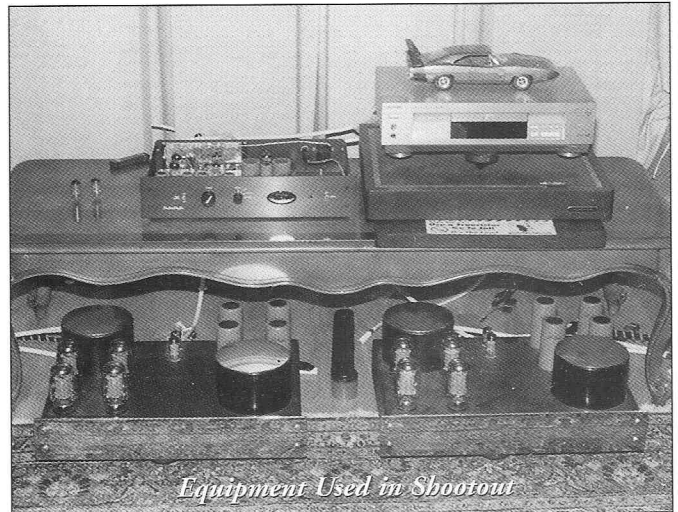

Equipment Used in Shootout

screened for low noise, low microphonics, balanced sections and proper gain factors. All of the screening was done with the George Kaye Small Signal Tube Tester.

We rated the performance of each tube used in the line stage of the preamp by first pre-heating it, listening to it with three types of music and rating it on a scale of 1 to 5 in the seven categories listed in the **Terms for Subjective Tonal Evaluation** on this page. The evaluations were tabulated and averaged in a numerical format in a spreadsheet on page 35.

As a result of this shootout, we determined the top five tubes of the test. They are listed in order of preference.

1. Mullard CV-4004/M8137 1977 Box Plate (Score: 90) This tube sounded seamless from top-to-bottom. There was minimal coloration and the least amount of veiling compared to any other tube in this test. It was balanced and smooth with excellent midrange and superb musical extension. This was the top-rated tube in our test. Note that late production CV-4004s from the 1980s have been known to not sound as good as the pre-1980 versions. Guitar players should be aware that the CV-4004 may not give optimum performance in your Fender or Marshall amps.

2. JAN/Philips 12AX7WA 1987 (Score: 82) Surprisingly, in this system, the JAN 12AX7 was full-bodied, bold and dynamic with smooth mids. However, timbral purity was not in the same category as the CV-4004. This may indicate a very slight amount of distortion. The JAN 12AX7 is

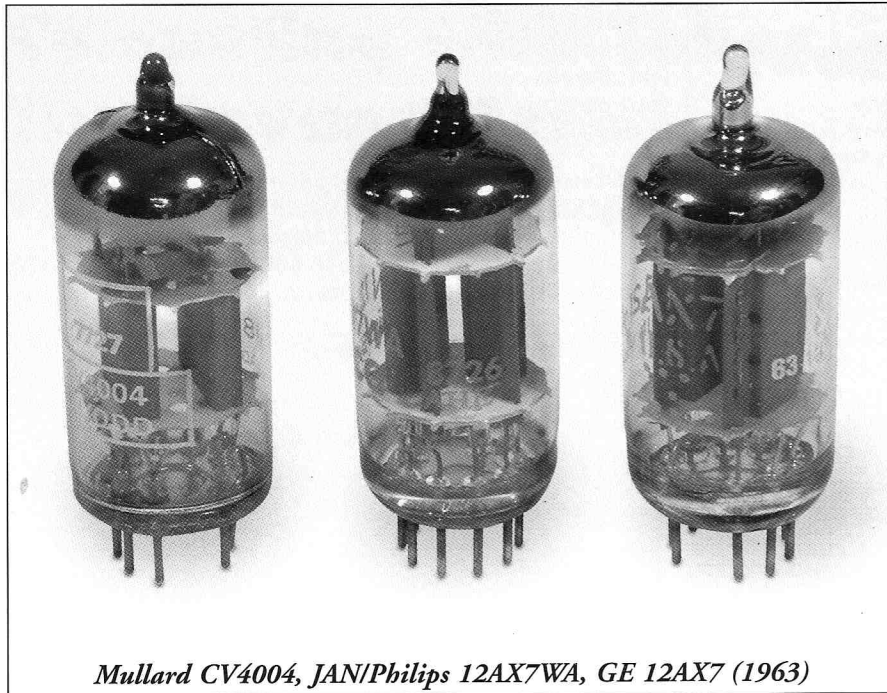

Mullard CV4004, JAN/Philips 12AX7WA, GE 12AX7 (1963)

currently available from many tube dealers at reasonable prices now and is considered a **Best Buy**. However, be sure to try some first in your equipment to see if you like the sound.

3. GE 12AX7 long gray plate 1963 (Score: 80) This is a military surplus tube that was made in the 1960s by GE. It was easy to listen to with a warm musical presence. The sound was balanced and sweet.

4. Raytheon 12AX7 long black plate 1957 (Score: 79) This is a super-rare tube that was natural and liquid-sounding. Musical dynamics were very good with nice fre-

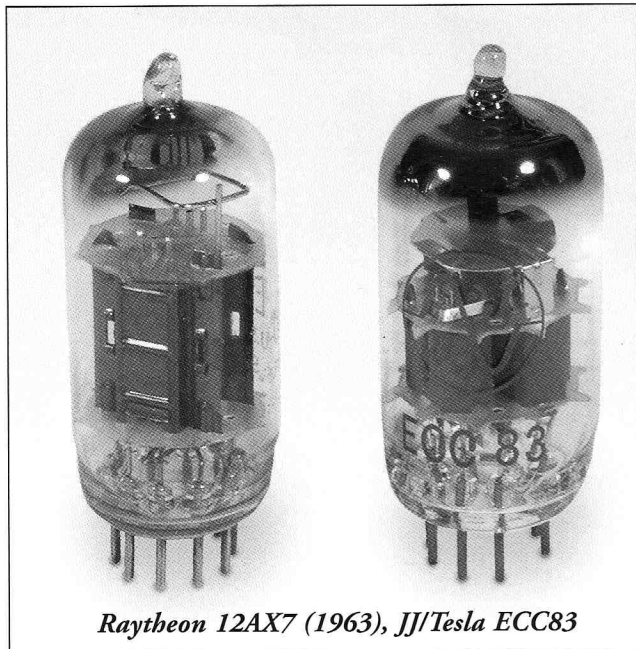

Raytheon 12AX7 (1963), JJ/Tesla ECC83

quency extension. It was smooth with ample midrange and overall balance. Don't expect to find these very easily as they have always been rare. Also be aware that Raytheon sold a lot of Korean and Chinese-made 12AX7s in the 1960s that are of lesser quality.

5. JJ/Tesla ECC83/12AX7 1999 (Score: 79) This is a well-balanced tube with good dynamic range. It has a tendency to be slightly soft and a little veiled-sounding, however. Also, it is not as dynamic as the CV-4004 or GE tubes in this test. Overall, a tube with good musical involvement. This is a very listenable current production tube and is considered a **Best Buy**.

Conclusion

For both objective and subjective rating of the other 12AX7s in this test, please see the table on the following page. As with any tube rolling shootout, your results may vary, depending on your tubes, equipment, program material

and ears. We urge you to try some tube rolling yourself to determine what sounds best in your equipment.

When purchasing tubes from unknown sources such as vendors on eBay, be cautious with small signal types such as the 12AX7. Most vendors test tubes using a standard tube tester (TV-7, Hickock 600A, etc.) which may not indicate all potential problems. But when the same tube is used in a preamp, it can be noisy and microphonic. Be sure you purchase tubes from a reputable dealer who thoroughly tests them and has a return policy.

A special thanks to Kevin Deal of Upscale Audio for his assistance with this tube shootout.

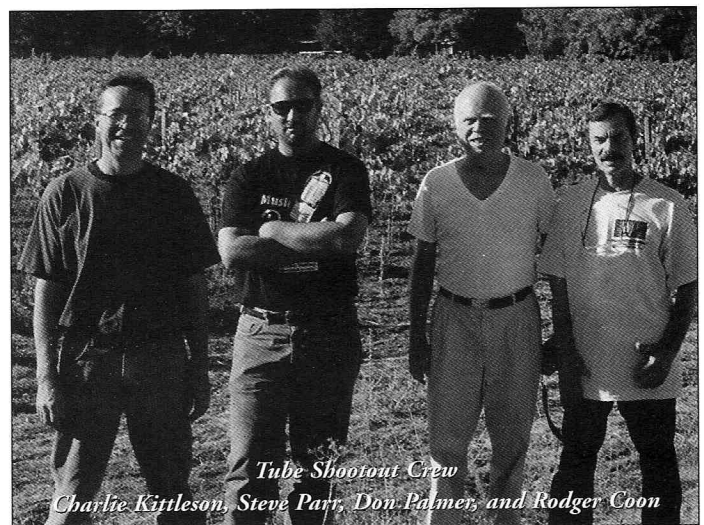

Tube Shootout Crew
Charlie Kittleson, Steve Parr, Don Palmer, and Rodger Coon

12AX7 Hi-Fi Shoot out

12AX7 Type	Coloration (subjective)	Dynamic Range	Transp arency	Frequency Extension	Musical Involvement	Three Dimensio nality	Pace and Rhythm	Total Average Score
Brimar 12AX7WA 1970s	Articulate, Bright, Forward	53	53	45	48	58	50	52
CBS Gray Plate 1955	Warm, Smooth	75	68	68	65	68	68	69
Chinese 1995	Bright, Thin, Recessed	63	70	68	68	68	65	67
Ei Smooth Plate 2000	Clear, Smooth,	68	70	78	60	70	75	70
GE Long Plate 1963	Relaxed, Smooth, Full	78	75	68	93	80	83	80
GE 12AX7WA 1986	Dry, Warm	58	60	60	65	65	60	61
JAN/Philips 12AX7WA 1987	Liquid, Warm, Smearred	83	85	73	88	85	80	82
Mazda Long Plate 1955	Liquid, Forward	70	70	60	70	65	70	68
Mazda Nickel Plate 1963	Warm, Light, Harsh	65	60	50	65	63	65	61
Mullard Long Plate 1950s	Smooth, Warm	73	65	75	65	65	65	68
Mullard Short 1970s	Recessed, Thin, Smooth	70	60	73	68	63	68	67
Mullard CV4004 1976	Detailed, Warmish, Clean	88	90	90	90	85	94	90
Philips Mini- Watt 1970s	Clean, Smooth, Warm	58	65	68	68	63	58	63
Raytheon Black 1957	Liquid, Natural	83	78	75	80	73	83	79
RCA 5751 Black Plate 1950s	Laid back, Smooth	72	72	70	65	65	65	68
RCA 7025 Gray Plate 1960s	Big, Liquid, Smooth	72	72	70	70	65	65	69
Sovtek LPS 1999	Bright, Smooth	60	53	55	53	55	55	55
Siemens (W.German) 1970s	Cool, Neutral	70	71	70	70	68	65	69
Svetlana 2000	Bright, Dry, Smooth	65	60	58	65	62	73	64
Sylvania Ridge 1961	Round, Warm	55	63	53	68	58	63	60
Telefunken Ribbed Pl. 1960s	Cool, Dry, Tubby Bass	68	70	70	70	68	73	70
Tesla/JJ 1999	Thin, Warm	80	78	75	83	78	80	79
Tung-Sol Gray 1960s	Big, Sibilant	65	65	65	58	60	68	64
Tungsram 1970s	Dry, Sweet, Warm	73	73	63	70	73	75	71

Purveyors of "Classic" Transformers & Enclosures

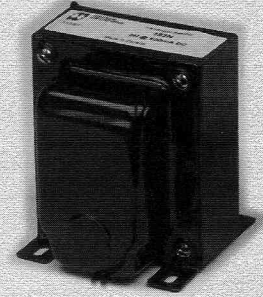
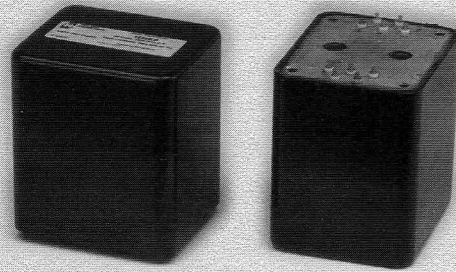
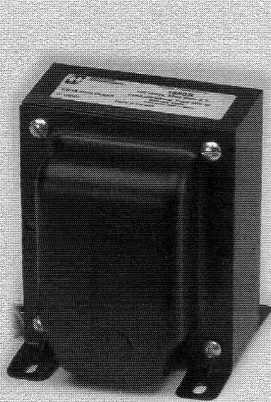

*Single Ended, Push-Pull
and Potted Tube Output
Transformers*

Filter Chokes

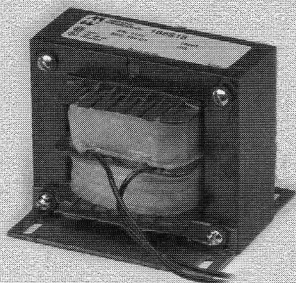

*Open & Enclosed
Filament Transformers*

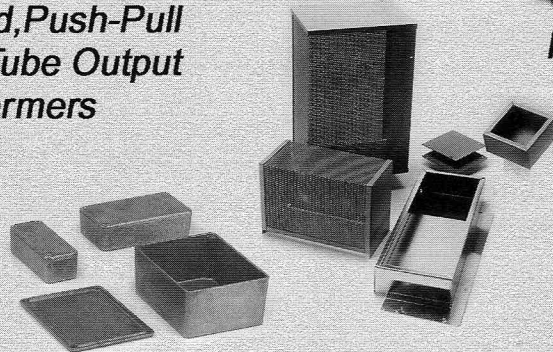

*Aluminum & Steel Chassis
and Diecast Aluminum
Enclosures*

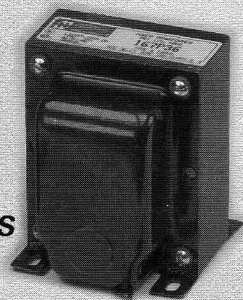

*High Voltage Plate
Transformers*



Contact us for a free catalog & list of stocking distributors

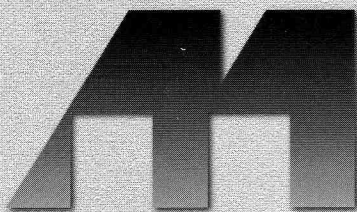

HAMMOND MANUFACTURING™

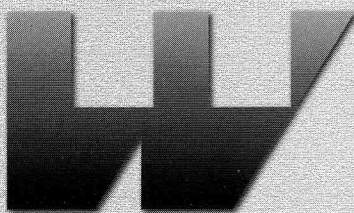

256 Sonwil Dr. - Cheektowaga, NY 14225 USA
Phone: (716) 651-0086 Fax: (716) 651-0726
394 Edinburgh Rd., N. - Guelph, Ontario N1H 1E5 Canada
Phone: (519) 822-2960 Fax: (519) 822-0715

www.hammondmfg.com

TUBES

TUBES, TUBES!!!

One of the largest selections of genuine, tested, premium grade NOS audio tubes for sale:

5U4GB	6L6GC	6SL7GT	6SN7GT
6V6GT	12AT7	12AU7	12AX7A
807	5881	6550A	6922
7355	7591	7868	8417
EF86	EL34	EL84	WE396A
GZ34s	KT66	KT90	MORE!!!

Plus great prices on the latest JAN/Philips, Sino, Sovtek and Svetlana audio tubes

www.vacuumtube.com

Fi-Sonik™

Parallel-Feed Single-Ended Output Transformers

*Exquisitely hand-crafted . . .
only thirty pairs made per year.*

Available in:

3K to 8 Ohm, 8 Watt
3K to 16 Ohm, 8 Watt
5K to 8 Ohm, 8 Watt
5K to 16 Ohm, 8 Watt

with either SuperPerm 49 Nickel Alloy or Amorphous Iron (Metglas®) core.

write, call, fax, or email for catalog

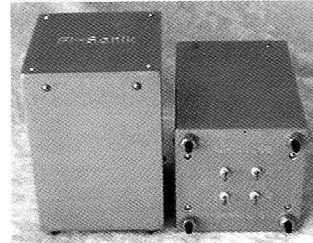

Fi-Sonik

P.O. Box 1080
Pinole, California 94564
Tel: (510) 724-7977
FAX: (510) 724-9439
email: FiSonik@aol.com

Industrial & Audiophile Parts

Hammond, MagneQuest, Alps, Clarostat, Kimber, WBT, RelCap, Nichicon, BlackGate, Hovland, Belden wire, Carbon Comp, IRC RN & GS & NAS, Mills, Caddock resistors, Cinch, Edison-Price, Cardas, N.O.S. & Sovtek tubes, kits and much, much more in all price ranges.

See us @

-<http://www.hndme.com>-

For a complete list of stock items, closeouts and sale items.

Or request a copy of Sales Flier No. 3

Handmade Electronics
P.O. Box 9114
Allentown, PA 18105-9114
USA

Phone (01) 610-432-5732

Visa, MasterCard, Discover & American Express
Export Friendly

one electron™

Single-Ended Output Transformers

High Quality for a Reasonable Price
Designed and Built in the USA

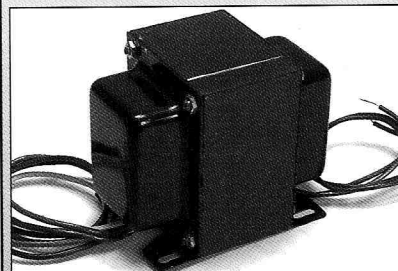

UBT-1 Designed for parallel operation of:

1.6k primary 15 watts 160 mA	\$99.00	2A3s, EL34s, 300Bs 6AS7s, etc. or Sweep-tube in "enhanced triode" mode
------------------------------------	----------------	--

UBT-2

4.8k primary 15 watts 110 mA	\$119.00	Can be used with: 300B, 50, SV811-3, etc.
------------------------------------	-----------------	--

UBT-3

3k primary 15 watts 110 mA	\$119.00	Good for single ended 2A3 or 300B
----------------------------------	-----------------	--------------------------------------

Quantity discounts available

ANTIQUE ELECTRONIC SUPPLY™
LIMITED PARTNERSHIP
6221 S. Maple Ave. • Tempe, AZ • 85283
Phone (480) 820-5411 • FAX (480) 820-4643 or 800 706-6789

the Chaffee
Hickok Store,
Santa Rosa, CA.

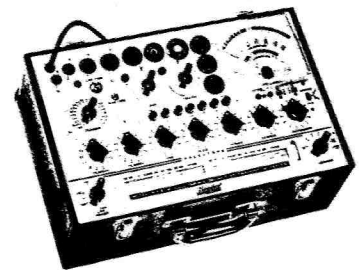

- Repair & calibration from 533 to Cardmatics
- **Hickok** testers for sale cleaned & calibrated with 90 day warranty
- Economical repairs
- We buy busted **Hickoks** too.
- See photos of all my testers for sale at:
www.Tubewizard.com
email: 6SN7@abac.com
Phone : (707) 544-4122

THE HOUSE OF TUBES

Putting the Glow in Your Audio System

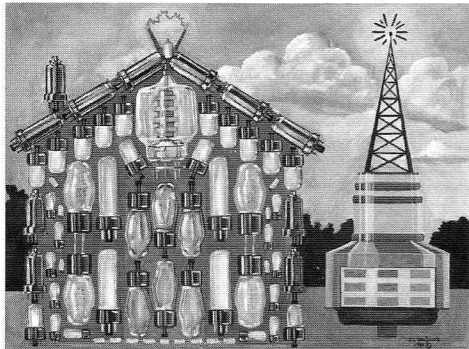

We know that tubes are the heart of a transceiver and the soul of an amplifier. That's why we're dedicated to reliable tubes at excellent prices. We offer the finest in audio tubes and quality components, and we've made ordering convenient.

Tubes—They're our foundation.

Visit us at: www.houseoftubes.com
e-mail: info@houseoftubes.com

ELECTRA-PRINT AUDIO

Quality Handwound S.E. Output Transformers

- Primaries from 1.8K to 10K
- Exclusive wideband design
- Line Stage with Headphone Out
- Single Plate to PP Grids

Custom-Built Power Transformers / Chokes

- Wound to your requirements
- Heavy-duty design for Class A use
- DC Filament Supply Windings
- HV chokes to 15H, 300ma
- Low voltage, high current filament chokes

Component Pricing and Specifications
Catalog Available



**ELECTRA-PRINT
AUDIO**

4117 Roxanne Drive
Las Vegas, NV 89108

702-396-4909 FAX 702-396-4910

TUBE POWER

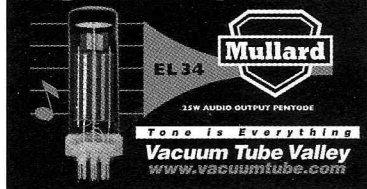

LATEST-GREATEST

2 Of The Latest Styles To Choose From

New EL34 Tube Power Shirt - Two color white and electric blue on black 100% cotton L or XL \$18.95 each

Tell the world your music is powered by 6L6. Super cool gig shirt for electric guitarists or sure-fire attention-getter for tube enthusiasts. Huge full-chest 12" x 15" 1950s style image with giant 6L6GC taking off. Available in either White Image on Black shirt or Black Image on Lt. Gray shirt XL only. Only \$18.95 each

Shipping and Handling \$5.00 US, \$6.00 Canada, \$10.00 Europe, \$12 Asia and World

California Residents add 7.25% State Sales Tax
Vacuum Tube Valley, P.O. Box 1499, Lakeport, CA 95453 USA FAX 707-263-7648
www.vacuumtube.com



AFFORDABLE HAND-WIRED GUITAR AMP KITS!



Available with Jensen speakers!

Based on blackface era amps from the mid 60s, these all-tube guitar amps feature 3-knob reverb control, tube rectifier, solid-pine jointed cabinets, bias setting jacks, master volume control, heavy aluminum chassis, cloth covered wiring, full size potentiometers, vintage style tube sockets, 40W 2x6L6 output, carbon composition resistors, Mallory tone capacitors and many other top features.

ALLEN
AMPLIFICATION
Quality tube amps, kits and parts

Phone: (606) 485-6423

Fax: (606) 485-6424

E-Mail: tonesavor@fuse.net

www.iguitar.com/allen



<http://www.triodeel.com>

Check out our site for...

...OEM tube data, schematics, links to nearly 200 tube related sites all over the net, plus lots more

...World famous Dynaco upgrade boards, simple & effective

...Magnequest replacement transformers for Dynaco(tm)

...Upgrade chassis for ST70, complete & partial kits

...Tubes: JJ/Tesla, Svetlana, Sovtek, Philips, NOS

...capacitors, resistors and a potpourri of useful stuff

...more to come...new EZ-Build modules, (cheap hi-end for everyone!), new paper capacitors, & the list goes on..

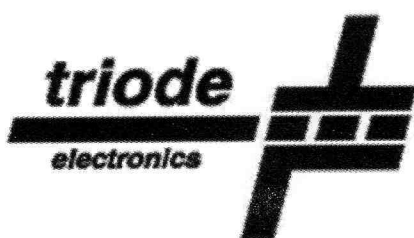

triode electronics

2225 W Roscoe St, Chicago, IL USA Ph 773-871-7459
Fax 773-871-7938 Office hours 12:30-8:00 CT M/F
(or until we get tired or thirsty)
Email us at postmaster@triodeel.com
"Worldwide Service, Neighborhood Prices"

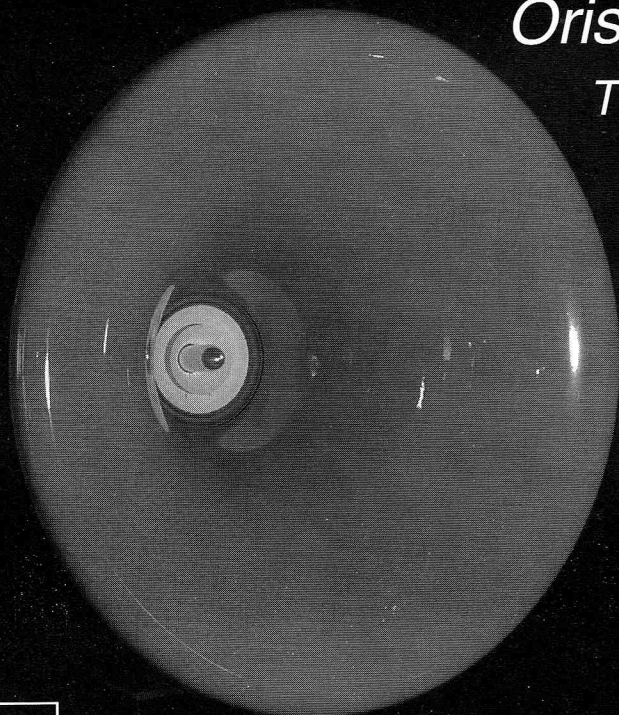

Oris 150

The Ultimate Lowther Experience

Imported from BD-Design Holland. The Oris 150 is the absolute best Lowther-based system we've heard to-date.

Smooth, full-bodied, three dimensional sound with deep bass!

The perfect match for low power Single-Ended amplifiers.

Call us or visit our website for more details.

Phone: 303.470.6585

<http://www.welbornelabs.com>

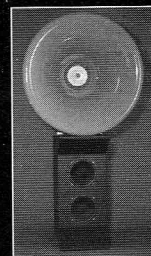

 Welborne Labs

www.AudioWeb.com

The Largest Hi-Fi Site on the Internet

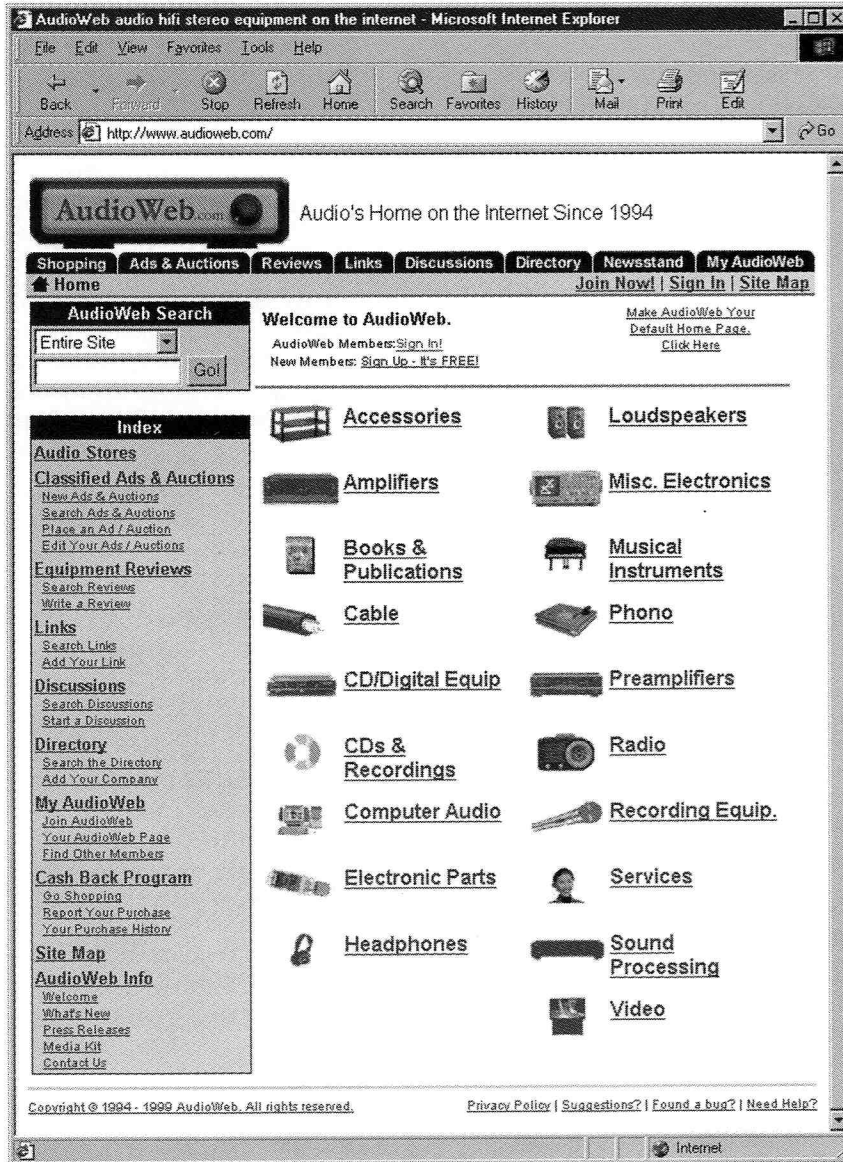

Shopping • Reviews • Classified Ads • Auctions
Links • Directory • Discussions • Newsstand



Audio's Home on the Internet Since 1994

AudioWeb.com, PO Box 303, Berkeley Heights, NJ 07922, 908 464-7307, 908 464-0271 (fax), info@audioweb.com

VACUUM TUBE VALLEY

Back Issues, Books, Goodies, & Subscriptions

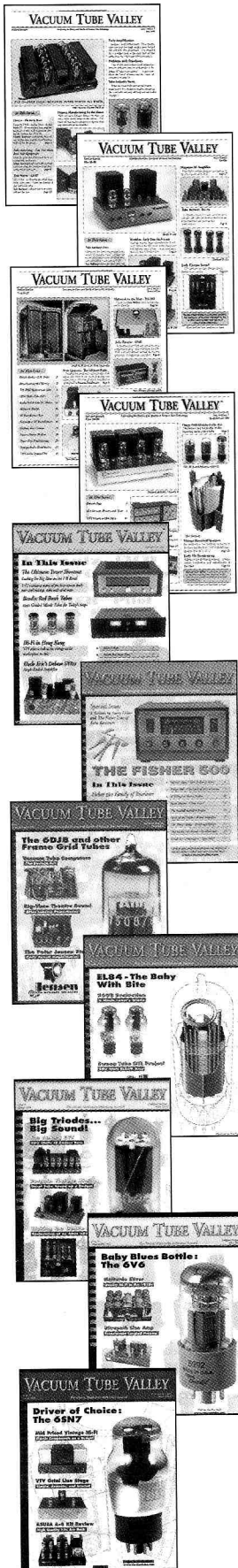

VTV #1 Spring 1995 \$12.95
Vintage Dynaco Tube Equipment - 1955-77
History and Testing of the 12AX7/ECC83 dual triode
Tube Testing Methods + Early Amplification and Amps

VTV #2 Fall 1995 \$12.95
Heathkit - The Tube Williamson Years 1950-61
EL34/6CA7 History, Types and Tests
Magnum SE EL509 Amplifier Project by Dave Wolze
1927-34 Western Electric Theater Sound Systems

VTV #3 Winter 1995/96 \$12.95
Eico Mono Tube Gear - 1955-62
Altec Lansing 604 Coaxial Loudspeaker History
Western Electric 300B History and Listening Tests
300B SE Transformer Listening Tests

VTV #4 Spring 1996 \$12.95
6L6 History, Types and Listening Tests
Vintage Bookshelf Speakers 1955-1965
Early FM Broadcasting History
HK Citation I & II Amplifier History and Mods

VTV #5 Fall 1996 \$12.95
The Ultimate FM Tuner Shoot Out
Red Bank Guided Missile Tubes for Hi-Fi
The Birth of the Marantz 10B
Choosing Rectifier Tubes for your Guitar Amplifier

VTV #6 Winter 1997 \$12.95
Fisher 500 - History, Models and Restoration
A Tribute to Avery Fisher by the Fisher Doctor
6550 and KT88 History, Types and Listening Tests
Loftin-White Amplifier History by Alan Douglas

VTV #7 Summer 1997 \$12.95
6DJ8 & Frame Grid Tubes + Listening Tests
Altec 1950s Theater Amps and Modifications
The Great Voice - The Peter Jensen Story
Computing with Tubes - The Savage Art
Uncle Eric's Tube Dumpster - 417A/5842

VTV #8 Fall 1997 \$12.95
EL84 History, Types & Listening Tests
RCA Tube Mfg at Harrison, New Jersey
200 watt OTL Amp Project by Allan Kimmel
300B Listening Tests: NOS and Vintage Types
Bruce Moore Tube Audio Pioneer

VTV #9 Spring 1998 \$12.95
Transmitting Tube Review, Ampeg SVT Guitar
Amp, Altec 287W amp, Bargain Vintage Hi-Fi

VTV #10 Summer/Fall 1998 \$12.95
Story of the 6V6, Hi-Fi radio in the 30s,
PP SV572 amp, Ultrathin Line Stage

VTV #11 Spring 1999 \$12.95
6SN7: History and Tests, Octal Line Stage
Project, Mid-Priced Vintage High-Fi, OTL
Headphone Amp, Capacitors and FREDs



VTV #12 Summer 1999 - 2A3 History
and Tests, 2A3 SE Amp Reviews, Bookshelf
Speaker Test, Scott 299: History and Mods,
300 Watt SV572 Amp Project **\$12.95**

VTV #13 Winter 2000
6L6 Shootout, Paul Klipsch Interview,
Klipschorn Lore and Mods, Scott 222 and
LK-48, PP 2A3 Amp Project **\$12.95**

Vintage Hi-Fi Spotter's Guide-Volume 1
Over 450 photos & specifications of tube audio gear
from the Golden Age of Hi-Fi. **86 pp. \$18.95**

Vintage Hi-Fi Spotter's Guide Volume 2
Volume 2 covers equipment not listed in Volume 1.
Almost 500 amps, preamps, tuners, etc are depicted.
Edition covers early audio and includes a Speaker section
with most vintage manufacturers. **88 pp. \$18.95**

Vintage Hi-Fi and Audio Price Guide 2000-2001
Updated price & grading guide for almost 1,000 vintage
hi fi amps, preamps and tuners. Includes Vintage pro
audio and theater gear. Also, pro loudspeakers, N.O.S.
vacuum tubes and audio transformers. **\$20.00**

"Vintage Hi-Fi The Golden Era Video"
A one-of-a-kind video covering the classic post-war and
1950s home hi fi era. Over 80 classic audio amps, pre-
amps tuners, are shown. This video is professionally pro-
duced. **34 min VHS NTSC \$20.00**

The Ultimate Tube Substitution Guide
No tube electronics enthusiast should be without this
book. Over 10,000 tubes are listed on 240 pages includ-
ing: audio, radio, transmitting, and special. Features an
audio tube section with tube evaluation. **\$29.95**



Vacuum Tube Valley T-Shirts
Check our web site for the latest designs! 100% Cotton USA

A) 6L6 MUSIC POWER
Large logo available in black or grey **\$18.95 XL only**

B) VTV Tube Sunburst Logo with 2-color black & orange
on front with large 2-color RCA tube diagram view on back.
(Available in grey) **\$18.95 L or XL, \$21.95 XXL**

C) VTV Tube Head Cap - High quality dark navy cap with sil-
ver embroidered "Tube Head" on front. "Vacuum Tube Valley"
stitched on back. Velcro size adjustment, 100% Cotton **\$18.00**



New and Fresh off the Press!

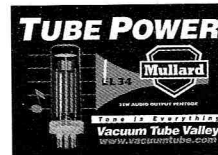

Mullard TUBE POWER
EL-34 T-Shirts

Available in black only with white and
luminescent blue art. **\$18.95 L or XL**

Subscribe To Vacuum Tube Valley
The Classic Electronics Journal

4 Issues / Year
\$49/year US First Class \$40/year US Third Class
\$52/Canada \$60/Europe
\$70/Asia & World

VACUUM TUBE VALLEY
P.O. Box 1499
Lakeport, CA 95453 USA
Phone (707) 263-5881 FAX (707) 263-7648

email - triode@vacuumtube.com
www.vacuumtube.com

Shipping and Handling: US \$7.50, Canada \$12.50, Europe
\$22.50, Asia and World \$28.50 Each Order.

VTV Pro-Tube Shop

Your headquarters for high quality audio parts & tubes

P.O. Box 1499, Lakeport, CA 95453 USA (Order 24-7-365 by phone)
 (707) 263-5881-Phone (707) 263-7648 FAX www.vacuumtube.com

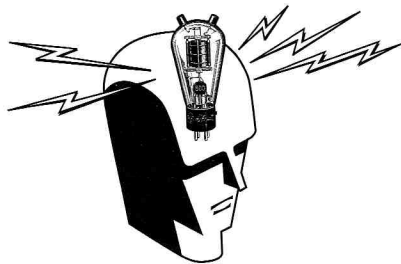

NEW! We now have a huge inventory of Foreign and US NOS audio and guitar tubes as well as excellent quality modern audio tubes.

Check out Pro Tube Shop on:
www.vacuumtube.com

Order: By email, FAX, Mail, Phone
Minimum Shipping and Handling per order:

US \$7.50, Canada \$10, Europe \$20,
 Asia \$25 (Heavier items will require additional postage)

\$35 Minimum Order

Vintage Hi-Fi Rebuild Kits Get Great Sound & Save Bucks!

All kits include all new ICMWR signal and bypass film caps, *under-chassis* electrolytics, 1 watt metal oxide low-noise plate resistors, new silicon power supply diodes and schematic. **Kits do not include FP can-type electrolytics.**

- Dynaco PAS2/3 \$65
- Dynaco Mark III \$40 (for pair)
- Dynaco Mark IV \$40 (for pair)
- Dynaco SCA-35 \$30
- Dynaco ST-35 \$25
- Dynaco ST-70 \$35
- EICO HF86 \$35
- EICO HF87, HF89 \$60
- Fisher X-101, X-202, etc \$65
- Fisher 400 Receiver \$65
- Fisher 500C Receiver \$75
- Fisher 800B, 800C \$75
- Heathkit W-4M \$60/pr
- Heathkit W-5M \$75/pr
- McIntosh C-20, C-11, C-22 \$100
- McIntosh MC30, MC40, MC75 \$45 ea
- McIntosh MC60 \$50 ea
- McIntosh MC225, 240 \$70
- McIntosh MC275 \$85
- Scott 130 \$85
- Scott 222, 222B, 222C, D \$65
- Scott 299, 299B, 299C, D \$65

Illinois Capacitors

ICMWR Metallized Polyester (630Vdc rating)

0.001uf	\$0.80 ea
0.002uf	\$0.80 ea
0.0047uf	\$0.80 ea
0.0068uf	\$0.80 ea
0.01uf	\$0.90 ea
0.022uf	\$0.90 ea
0.047uf	\$1.00 ea
0.068uf	\$1.20 ea
0.1uf	\$1.30 ea
0.22uf	\$1.60 ea
0.47uf	\$2.20 ea
1.0 uf (400V)	\$2.50 ea
2.2uf (250V)	\$2.75 ea
3.3uf (250V)	\$3.20 ea
4.7 uf (250V)	\$3.80 ea

Ultra-Tone Silvered Foil in Paper and Oil

Capacitors 98% pure silvered foil in kraft paper impregnated with non-toxic mineral oil and petroleum jelly, sealed in epoxy. Silver plated OFC leads with inner foil marked (650Vdc rating)

0.01uf	\$14.00ea
0.02uf	\$16.00 ea
0.05uf	\$18.00ea
0.1uf	\$21.00 ea
0.22uf	\$32.00 ea
0.47uf	\$45.00 ea
1.0uf	\$80.00 ea
2.0uf	\$110.00 ea

Speaker Crossover Caps with 200VDC Rating

1uf	\$45.00 ea
2uf	\$75.00 ea
5uf	\$145.00 ea

The Ultra-Tone capacitors are used in some of the finest amplifiers around the world. Incredible bandwidth with awesome imaging. Excellent for single-ended triode, push-pull and OTL amp designs. Can be bridged across film caps for improved sweetness.

FREDS (Fast Recovery Diodes)

IXYS 600V 8A	\$3.25 ea
IXYS 1200V 11A	\$6.50 ea
60V 5 Amp Schottky	\$2.00 ea

Illinois Axial Electrolytic Capacitors

Great Value and very dependable.

3.3uf @350V	\$1.20 ea
4.7uf @350V	\$1.45 ea
10uf@160V	\$1.25 ea
10uf @450V	\$1.60 ea
22uf@50V	\$.85 ea
22uf @250V	\$1.95 ea
22uf @450V	\$2.25 ea
22uf @500V	\$2.85 ea
47uf @35V	\$1.50 ea
47uf @350V	\$2.50 ea
47uf @450V	\$3.45 ea
100uf@100V	\$1.65 ea
100uf @160V	\$2.95 ea
100uf @350V	\$3.90 ea
100uf @450V	\$4.90 ea
2200uf @35V	\$2.75 ea

NEW! Ultra-Tone Polypropylene Film & Foil Power Supply Capacitors

10uf@650V	\$18.00 ea
20uf @ 650V	\$25.00 ea
50uf @650V	\$45.00 ea
100 uf @650V	\$65.00 ea

Vertical aluminum can-chassis mount with threaded stud.

Beautiful appearance with polished aluminum with black epoxy sealed top cap.

Lowest ESR, longest life, awesome sound. Perfect for DIY and custom audio projects.

Tube Sockets

Octal Ceramic Chassis	\$3.50
Octal Ceramic PC mt	\$3.00
Octal NOS Phenolic	\$3.50
9 Pin Ceramic PC	\$2.50
9 Pin Ceramic Chassis	\$3.00
9 Pin Ceramic GOLD	\$5.00
9 Pin Plastic w/shield	\$4.00
9 Pin NOS Brn Phenolic	\$3.00

Order Fast from our on-line catalog
www.vacuumtube.com

Can Electrolytic Capacitors

20,20,20,20 @475V

(Mallory type) \$31.50

50+50uf @500VLCR

w/clamp \$21.50

100,100uf @500V

LCR w/clamp \$28.00

40,20,20,20uf @500V,

LCR w/clamp

\$32.00

D.H.Labs Silver

Sonic Wire

Rated as the best sounding wire for the money by several audio publications.

"This is nothing other than a superb cable. It can be used with confidence with the finest of systems."

Make your own speaker cable & interconnects.

Save BIG!!!

Silver Sonic T-14

Speaker Wire \$4.00/ft

Silver Sonic BL-1 High

Definition Interconnect

Wire \$3.50/ft

Silver Sonic OFH-20

High Performance

Silver/Teflon Chassis Wire

\$0.95/ft

RCA-2 Gold Tiffany-

Style Interconnect Plug

\$10.95ea

B-1C Gold Banana Plug

and Insulator \$5.50/pr

BSP Gold Mini Spade

Speaker Terminals for

Vintage Hi-Fi \$1.10 ea

AMEX, VISA, MC OK

Huge Catalog

Available for **FREE** online with cool NOS tubes, premium parts, wire, kits and vintage hi-fi.

www.vacuumtube.com

Ask About Our FREE
80 Page Catalog

TUBES
TRANSFORMERS
SUPPLIES
CAPACITORS
PARTS
LITERATURE

TUBES • PARTS • TRANSFORMERS • CAPACITORS
LITERATURE • SUPPLIES



**ANTIQUE
ELECTRONIC
SUPPLY[®]**

Ph# 480•820-5411
Fax 480•820-4643
or 800•706-6789

OUR WEB ADDRESS SAYS IT ALL!

tubesandmore.com

