

VACUUM TUBE VALLEY™

Issue 16

The Classic Electronics Reference Journal

Price \$10.95

The EL34 Power Tube

Hi-Fi and Guitar Amp Shootout

Musical Evaluations of a Classic Design

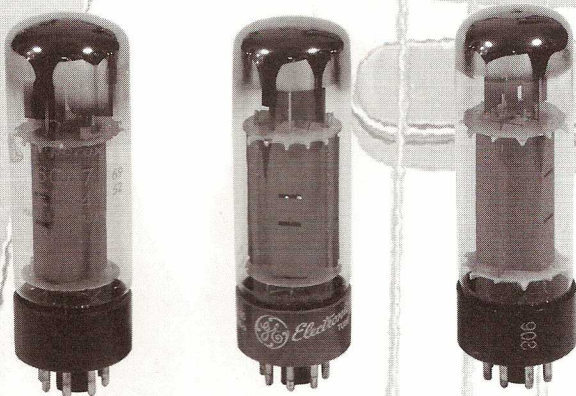

International Audio 4.5SE

Single-Ended EL-84 Stereo Amp

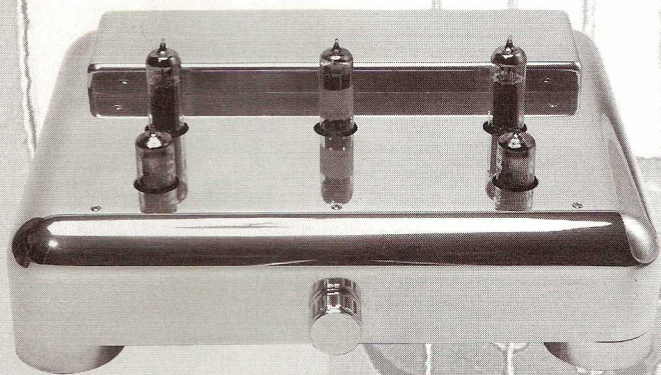

Dumpster Tube Treasures

Vertical Output Triodes

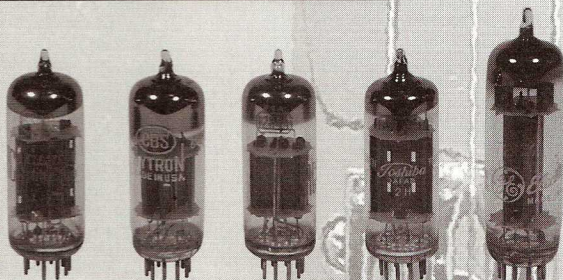

ISSUE 16

Visit us on the web www.vacuumtube.com



VACUUM TUBE VALLEY

P.O. Box 691, Belmont, CA 94002 USA
(650) 631-6550 Phone - (650) 654-2065 FAX
<http://www.vacuumtube.com>

October 4, 1999

Mike Matthews
New Sensor Corporation
20 Cooper Square
New York City, NY 10003

Greetings Mike,

We finally got a chance to evaluate your new Electro Harmonix EL34 last week. Judging from electrical tests using the tube curve-tracer, your new EL34 is a significant improvement over the original Sovtek EL34. It was very stable and linear when operated within the typical EL34 range of about 40 mA and less than 525 volts on the plates. Physically, the tube appears well-made with tight internal plate bracing for reduced microphonics. The getter material is silver-black colored, similar to the original Mullard tubes.

Several local audio enthusiasts listened to the matched quad of Electro Harmonix EL34s you sent us using a restored vintage Dynaco Stereo 70 amp and an ASUSA-Kit A-4 amplifier. To our ears, your new EL34 comes very close to the sonics of a Mullard EL34 from the 1960s. The Electro Harmonix tube is musically balanced throughout the entire music spectrum. Bass goes deep and is tight, mids are sweet and well-defined and highs are detailed and extended. This EL34 should be dependable and sound great in most new and vintage hi-fi amplifiers.

The Electro Harmonix EL34 is a well-engineered tube at a competitive price. This tube offers us yet another quality choice in the EL34 market. It is refreshing to see that New Sensor is spending the time and money to improve their audio tubes instead of simply relying on existing designs.

Mike, thanks again for keeping the audio vacuum tube market alive and well!

Best Regards,

Vacuum Tube Valley

Charlie Kiffeson
Publisher



electro-harmonix EL34EH
www.ehx.com (212) 529-0466 FAX (212) 529-0486

**VTV Issue # 16
Table of Contents:**

Ultrapath, Parallel Feed4
Tube Dumpster.....10
Dating Philips Tubes.....13
Life & Times of the EL34.....16
Interconnects in Review.....22
Hagerman Vacu-Trace.....24
IAG SE Amp Review.....27
Headphone Amp Project...28
EL34 Shootout - Hi Fi30
EL34 Shootout for Hi Fi32
Advertisers.....35

PM Announces New Venture

PM has negotiated the exclusive world-wide rights to distribute vacuum tubes made by Svetlana SPb of St. Petersburg, Russia under its international brand name, PM. PM Components of America will act as the sole importer of Svetlana audio and power tubes for the US and Canadian market. The PM Group will continue the St. Petersburg tradition of high quality at a reasonable cost to the tube industry.

For more information contact:

PM of America, Inc., 1687 Shelby Oaks Drive, Suite 8, Memphis, TN 38134 Phone - 901-388-2424 info@svetlanausa.com

Beware of Fake NOS Tubes!

Over the last year or so, we have been hearing about and seeing an increase in fake NOS tubes. This phenomenon is nothing new and has been going on for decades. However, the rapid price increases in premium vintage audio tubes has encouraged more activity and potential for profit.

The Internet and more specifically eBay have become a hotbed for illegitimate tube sellers looking for unsuspecting prey. Unscrupulous tube dealers from Hong Kong, Europe and Florida are shilling this trash in all directions now. Most of the tubes are recent manufacture Chinese, Russian and Tungstram tubes rebranded as Mullard, Amperex, Tung-Sol, RCA, Telefunken, Valvo, etc. They are even reprinting replicas of the old boxes. Many of the fake tubes are marked "Foreign Made." We have never seen this marking on genuine European NOS tubes. There are even cheap Chinese 6550 knockoffs in green and yellow Amperex boxes marked "KT88 - Made in England."

If tubes are priced lower than typical prices on the web, be sure to get a money back guarantee from the seller in the event the tubes are found to be fake. Always buy from legitimate tube sellers who are knowledgeable about their products.

Mojo Music Under New Ownership

Relocated and under new ownership, Mojo Music now has a new catalog available. They carry Ei, JJ/Tesla, Svetlana, NOS tubes and lots of parts. For more information, contact: Mojo Musical Supply, 828 West 4th St., Winston-Salem, NC 27101. 800-927-6656 or www.mojojotone.com

CE Distribution US Distributor for JJ Electronic Tubes

JJ Electronic, a manufacturer of high quality tubes, has appointed CE Distribution of Tempe, AZ, as US distributor. The JJ tubes are hand-made in the reorganized Tesla factory, relocated in the Slovak Republic. This legendary tube factory has built many OEM tubes comparable to brand names such as Amperex, Mullard, Siemens, etc. Current tube types available include EL34, 6L6GC, KT88, EL84, 12AX7-S, 12AU7, 12AT7, 6922, 300B and 7027A.

For further information, contact: Jon Bosaw, CE Distribution, 425-744-1053, 425-744-1052 (FAX) or jbosaw@cedist.com

Ei Still in the Audio Tube Business

Located in Nis, Serbia, the Ei-RC (Electronic Industry) Radio Tube factory was reportedly not damaged by recent military activities in that country. According to an email from Kosta Matejic, President of Ei, the company is still making glass tubes for audio applications.

The Ei factory produced its first tube in 1951, and in 1959 Ei management signed a contract with Philips covering the transfer of the manufacturing technology for "Noval" tubes. The peak of production at Ei was in 1977 when 12 million tubes were made with Philips, Siemens and Telefunken as the main buyers. Today, the factory has 282 employees, including 28 engineers.

The current Ei audio tube line-up is as follows: ECC81, ECC82, ECC83, EL34, EL84, 6CA7, 6L6GC, 12BH7, 6FQ7, 12DW7, KT90 and a few other types. Ei audio tubes are available from most new tube sellers.

EDITORIAL STAFF

- Charles Kittleson** - Editor in Chief
- John Atwood** - Technical Editor
- Eric Barbour** - Senior Editor
- Ron Veil** - Guitar Amp Tech Editor
- David Bardes** - Associate Editor
- Steve Parr** - Art Director
- Julie P. Werner** - Copy Editor
- Website** - www.vacuumtube.com

Copyright 2001 **Vacuum Tube Valley™**
All rights reserved.

No part of this publication may be reprinted or electronically reproduced without written permission of the publisher.

Send circulation and editorial correspondence to:

Vacuum Tube Valley
P.O. Box 1499,
Lakeport, CA 95453 USA
e-mail triode@vacuumtube.com
ISSN # 1095-4805

Vacuum Tube Valley is published quarterly for electronic enthusiasts interested in the colorful past, present and future of vacuum tube electronics.

Subscription Rate: US\$40/4 issues 3rd Class-\$49 1st Class; Canada/\$52; Asia/\$68; Europe/\$60

US Bank Check, Credit Cards or Cash are accepted for payment.

**Phone - (707) 263 - 5881
FAX - (707) 263 - 7648**

Ultrapath, Parallel Feed and Western Electric

By Lynn Olson ©2001 All Rights Reserved

In the last two years, independent developments in the Single-Ended Triode (SET) movement have revealed a better way to design vacuum-tube amplifiers. Although it appears at first glance that they only apply to certain SET amplifiers, there is a common thread that ties all of them together. By analyzing the complete AC signal path from plate to cathode, existing circuits can be examined in a different light, and new circuits created, both Single-Ended (SE) and Push-Pull (PP).

All of the combinations - conventional, Ultrapath, Parallel-Feed, Western Electric (WE), and others - are shown in a "Periodic Table of Topologies." The table shows simplified versions of each circuit, which can be preamplifiers, line amplifiers, drivers, or output stages.

Conventional Single-Ended (A)

As Jack Elliano explained in his VTV #10 (pp.11-12) Ultrapath article, a triode is simply a voltage-controlled resistor. To be more exact, the potential difference between the cathode and the grid controls the dynamic resistance of the plate-cathode circuit. When a steady DC current is impressed on the plate-cathode circuit, the tube simulates an AC generator connected to the primary of the transformer. Note the "ends" of the virtual AC generator are the plate and the cathode, not the plate and ground. For that matter, a ground reference is simply a matter of convenience in circuit design, a common low-impedance point that can be shared, but is not necessary for the operation of the tube.

When the tube is amplifying an audio signal, the AC current flows along the dotted lines in the table. It passes

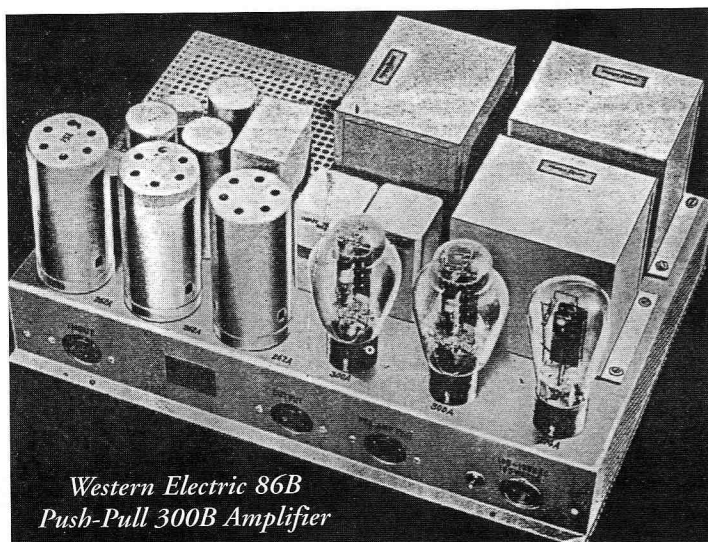

through two capacitors, and in typical circuits, these are low-quality polar electrolytics, and not even of the same type or value. If the cathode capacitor is omitted, the dynamic resistance (R_p) of the tube will probably rise three times or more, with disastrous consequences for the bandwidth of the transformer. If the B+ filter cap is omitted, the power supply will become much noisier, and more seriously, the impedance seen by the primary will become extremely high, since the R_p of the tube and the main power supply B+ choke then become series-connected.

Both cathode bypass and B+ filter caps are essential for correct operation in a conventional transformer-coupled SE circuit. I don't need to emphasize in this magazine the disastrous impact of low-quality electrolytics on the audio signal, yet as can be seen from the analysis of the AC signal, the electrolytics used in most designs are directly in the audio path.

The best that can be done with a conventional SE circuit is specify better-quality, non-polar caps, such as traditional oil-filled caps, and use fixed bias.

Ultrapath (B)

Jack Elliano's Ultrapath circuit solves the problem in a remarkably simple and elegant way; replace the cathode-bypass electrolytic with a high-quality oil cap, and move the grounded end of the cap to the B+ side of the output transformer. That's it. That one change alters the entire operation of the circuit.

With a cathode-transformer (KT) bypass cap in place, the AC generator that the tube represents has a direct terminal-to-terminal path, from plate, to transformer, back to the cathode again, courtesy of the KT bypass capacitor. There is no need for the AC signal to traverse two back-to-back electrolytics. Instead of completing the AC circuit, all the B+ filter cap does is shunt noise away from the audio circuit, a much less demanding application. At a single stroke, the strong colorations of the power supply components are greatly reduced, since the AC signal no longer requires the power supply to complete the AC circuit. All the power supply does is supply polarizing DC so the tube can operate.

The original VTV circuit recommends a 25 μ F oil cap for a 6J5 or 1/2 6SN7 triode. Since the required value of the new cathode-transformer (KT) bypass is a function of the dynamic impedance (R_p) of the tube and the cathode resistor, larger values will be required for lower-impedance tubes. For example, in a power amplifier with a 300B output, a 100 μ F oil cap would be desirable. Readers with access to circuit-modeling programs like SPICE can work out the optimum values for their favorite tubes.

In VTV #10, the B+ supply is shown with a conven-

PERIODIC TABLE OF TOPOLOGIES

© 2000 Lynn Olson

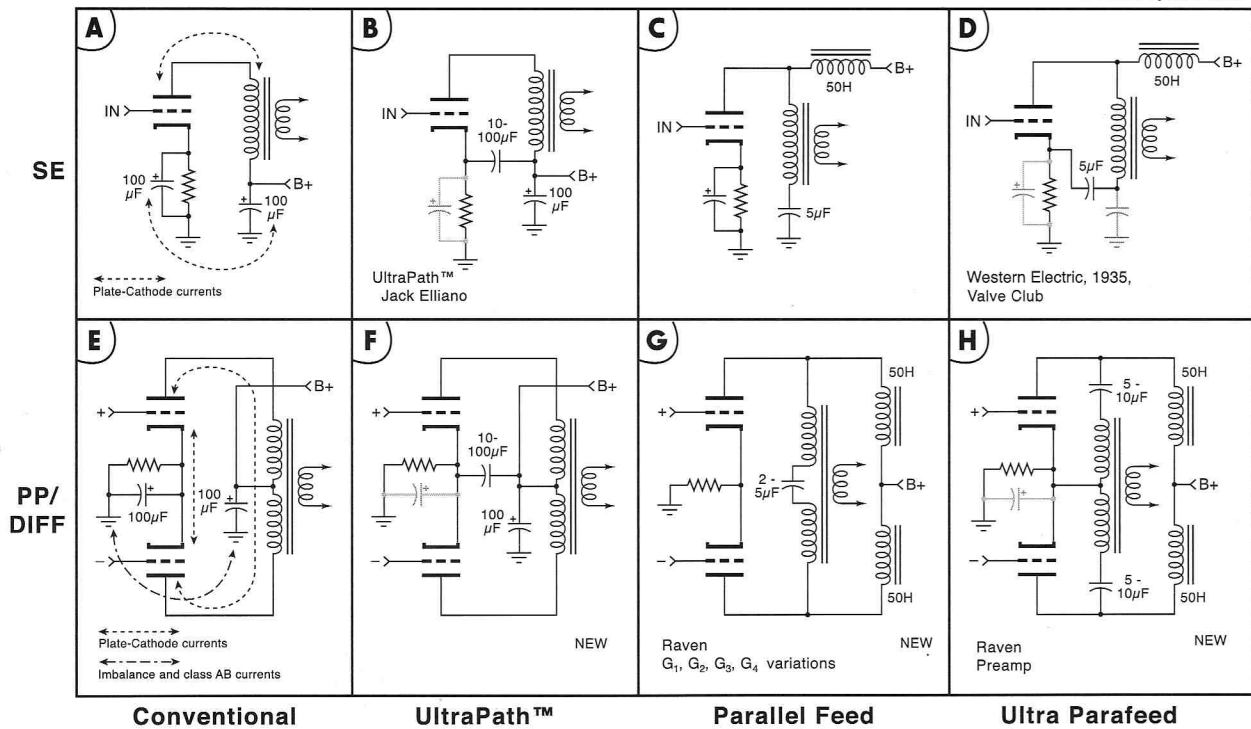

tional 100µF electrolytic filter cap. Curious experimenters can replace this with an oil cap, and notice how small a difference this makes to the sound. By contrast, if the amplifier reverts to a traditional SE circuit, the difference between the two types of filter cap is far more audible, since the signal from the virtual AC generator is forced to traverse two back-to-back electrolytics. What about regulated-power-supply enthusiasts, the folks who are using old Kepco lab supplies or the modern Allen Wright SuperReg? Does all of this apply to you?

Yes. Remember, in a conventional SE circuit, the power supply is in the direct path of the audio signal. See any electrolytics in there? That's what you're hearing. See any feedback in the regulator? That's there too. Why go to the trouble of building a non-feedback triode circuit if the sonics of feedback are still in the audio path? With the Ultrath path circuit, you can keep the tight regulation, low noise, and ultra-low source impedance of regulated supplies, without the added complications of "tuning" the regulated supply for optimum sonics.

It might seem counterintuitive, but the Ultrath path circuit makes regulated supplies more attractive, not less, since the unpleasant business of tuning a complex power-supply for pleasing sonics is sidestepped. The people who have tried regulated supplies, and gave them up in desperation over the tuning problem, can look at them again with the Ultrath path circuit. I'm making a guess here, but an Ultrath path circuit combined with a regulated supply could offer the sonics of the most exotic all-battery tube amplifier. (Note: "Ultrath path" is protected by trademark laws. Copying an image of the schematic from VTV is prohibi-

ed by trademark laws.)

Parallel Feed (C)

In the earliest days of radio, engineers had a choice of transformer, parallel-feed, and resistor-capacitor (RC) coupling between low-mu triode stages (no other tubes existed). B+ power came from unsightly, leak-prone, and heavy batteries that required frequent recharging. B+ voltage was a precious commodity, not something to be lightly burned off in a resistor, and the simple triodes needed every bit of gain available. The first choice was transformer coupling, which maximized efficiency.

When PP amplifiers first appeared, designers realized they could improve the performance of the interstage transformer (which is hard to design because of high impedances on primary and secondary) by isolating DC from the primary. This reduces the size of the transformer core, raises the inductance, and improves high-frequency response (as a result of smaller winding area). When B+ voltage was at a premium, plate chokes were used, and when there was plenty available, a plate resistor. Both variations came to be known as parallel-feed, since the AC and DC follow different paths in the circuit.

In the 1930s, RC coupling came into its own with AC-powered radios and high-powered sound systems in theaters. The extended HF bandwidth paved the way for feedback, vacuum-tube phase splitters, and the various Williamson derivatives that still dominate mainstream vacuum-tube audio. Over the last half-century, device linearity became gradually less important, with high-feedback opamps being the endstage development. With the

Directly Heated Triode (DHT) revival of the last decade, intrinsic linearity has returned to the forefront, and circuits that optimize the performance of zero-feedback triodes are being retrieved from the archives of audio. With encouragement from Michael LeFevre (MagneQuest) and Dan Schmalte (Doc Bottlehead of VALVE magazine), parallel-feed SET amplifiers are creating a buzz in the Northwest part of the USA. (Niyom Nakarin of Fi-Sonik and John Atwood of One Electron are also fans of parallel feed. -ed.)

On paper, parallel-feed is an ugly business, seeming to add an unnecessary cap and plate choke (or current source) to what would otherwise be a conventional SE circuit. Calculating the value of the coupling cap feels a little odd as well. Using the formula for resonance, set f between 6 and 15Hz, so $f = 1/(2\pi\sqrt{LC})$, with C being the coupling cap and L the primary inductance of the transformer. In practice, the coupling cap is considerably smaller than the usual cathode-bypass, with 1 to $6\mu\text{F}$ being typical.

(If you make the cap larger than optimum, it creates a subsonic peak, which muddies the bass and can damage the woofer. People who want to go beyond the crudity of cut, try, and listen are invited to model parallel-feed on SPICE.)

What does parallel-feed sound like? Contrary to expectation, the bass region sounds very similar to regular SE, but from 500Hz on up, the sound is noticeably more direct and open, with a significant subjective extension of HF response. This is not what you'd expect by glancing at the schematic; like SE itself, what you actually hear is quite different than the initial pre-conception of what you expect to hear.

What accounts for the change in the mids and highs? For one thing, power-supply colorations are nearly totally isolated from the audio circuit by the plate choke; at mid-frequencies, the power supply resembles a current source, not the usual voltage source, with a very significant amount of isolation between the B+ filter cap and the audio circuit. This is not a trivial matter; power supply colorations can easily overshadow the choice of tube or any other part in the audio path of the circuit. In most amplifiers, just swapping parts in the power supply is the most effective "tone control" in the entire hi-fi system ... certainly more effective than playing with interconnect cables.

Secondly, nickel or mu-metal transformer cores are a different animal than the usual air-gapped M6 silicon-steel transformer core. Nickel cores have essentially no tolerance for DC at all, plus they saturate hard and fast ... but offer superb low-level performance, especially in the midband. There's a reason that nickel cores are used in microphone transformers, professional applications that demand the last word in low-distortion performance.

There are several ways to get parallel-feed wrong: one is to cheap out and use power-supply chokes for the plate choke. Power-supply chokes are not designed for this application, and can have a self-resonance as low as several

kHz due to stray capacitance. Plate chokes, by contrast, have self-resonances as high as 70 kHz due to better control of stray capacitance, and pay more attention to the choice of dielectrics used in the construction of the inductor. Another way to get parallel-feed wrong is to use an off-the-shelf SE or PP transformer; since the circuit offers the prospect of near-zero DC flux across the output transformer, why not take advantage of the best-available core material for the operating condition?

The VALVE group in Seattle have discovered that oil caps, which can sound "slow" in other parts of the circuit, do not sound that way at all when placed in a parallel-feed circuit. Their experience with film caps is that they sound even more colored in parallel-feed, so oil is the way to go. The same cap-selection considerations that apply to Ultrathath apply to parallel-feed, with the difference that the parallel-feed cap is likely to have an optimum value somewhere between 1 and $6\mu\text{F}$.

Western Electric SE (D)

Although this circuit appears new, it is actually very old. Take a close look at the single-ended 262A driver in the schematic of the Western Electric 92B amplifier. C1-C connects the 262A cathode to the low-side of the interstage driver transformer, forming an audio-frequency shunt between B+ and the cathode (BK). The cathode-transformer bypass isolates DC from the interstage transformer (improving bandwidth and power-handling), and the plate current for the 262A is supplied through a 100K power resistor. It can be seen that the 100K resistor can be replaced with a plate choke or current source with no significant difference to the operation of the driver stage. As with parallel-feed, it is best to keep the cathode-transformer bypass to a moderate value between 1 and $6\mu\text{F}$.

The WE SE circuit combines features of Jack Elliano's Ultrathath and parallel-feed; however, the ghost of positive feedback lurks nearby, ready to make trouble. The Ultrathath circuit has the B+ filter cap shunting the low-side of the transformer primary to ground; no such shunt exists in the WE SE circuit. As a result, a small signal that appears at the plate can be re-amplified at the cathode.

In practice, the load of the transformer acts as a voltage divider for the cathode resistor, so the extra gain is only significant at low frequencies, when the effective transformer load falls to the DC resistance of the primary. Another way to analyze the positive-feedback potential of the circuit is to turn it on its side, and make it a grounded-grid amplifier with (positive) feedback from plate to cathode. It can be seen that the voltage-divider action of (transformer + KT bypass) / (cathode resistor) in the feedback path is the only thing preventing this circuit from entering full-blown oscillation.

A simple way to shut off the positive-feedback effect is to re-introduce the cathode-bypass capacitor, using a much larger value than the KT bypass (such as $100\mu\text{F}$). This greatly increases the effectiveness of the voltage-divider, stabilizing the circuit at all frequencies. Note that Western Electric didn't do this, using a very modest $0.1\mu\text{F}$ for the cathode-bypass (C2). The WE engineers probably selected

the values of C1-C and C2 to trim the LF response of the interstage transformer (T2).

Audibility of Power Supplies

The typical way of thinking of power supplies in terms of hum and noise is grossly oversimplified. With conventional triode, pentode, or transistor circuits, the power supply is directly in the audio path, and the audio signal is fully exposed to the low-quality parts used in power supplies.

In transistor circuits, the problem is aggravated by the low operating impedances, which in turn require very large bypass capacitors. Unfortunately, the only caps you can buy in 1000µF and larger values are electrolytics, which are so nonlinear that loudspeaker designers go to great lengths to avoid them, even in subwoofer applications. In a transistor amplifier (or preamp), the large-value electrolytic isn't just in the low-frequency part of the circuit (as it would be in a speaker), but exposed to the full bandwidth of the audio path. Take a good look at any "direct-coupled" transistor circuit and count up all the bypass caps you see; unless the circuit uses the techniques of Ultrathru, parallel-feed, or Western Electric, these caps are directly in the audio path. Paralleling the low-quality electrolytics with film capacitors may improve high-frequency response, but it does nothing for the underlying nonlinearity of the much larger electrolytic.

The typical values of feedback used in transistor circuits may linearize the transistors (which need it), but feedback can't make much of a dent on the time-dispersion problems (Dielectric Absorption) of electrolytic capacitors. In fact, feedback may worsen the defects of electrolytics, spreading out the time-dispersion even more and adding high-order terms to the underlying nonlinearities. This might be an important reason that simple, high-slew-rate, moderate-power transistor amplifiers are the most "triode-like" of transistor amps; there are fewer electrolytics, they have smaller values, and there's less feedback. The circuit isn't any better; there's just less to go wrong!

Conventional Push-Pull (E)

Part of the reason I wrote this article is to nudge push-pull enthusiasts away from endless variations of 1950's circuits such as the Williamson, Acro, Dyna, Citation, Marantz, and McIntosh. After strip-mining the "Golden Age" for the last half-century, there's no gold left anymore. The mine is played out. When you compare "Golden Age" designs to the entire span of vacuum-tube audio - more than 80 years - they are pretty similar, with 20+ dB of feedback, RC-coupling, pentodes, and vacuum-tube phase splitters. This narrow slice of audio history is all that comes to mind when audiophiles, magazine reviewers, and

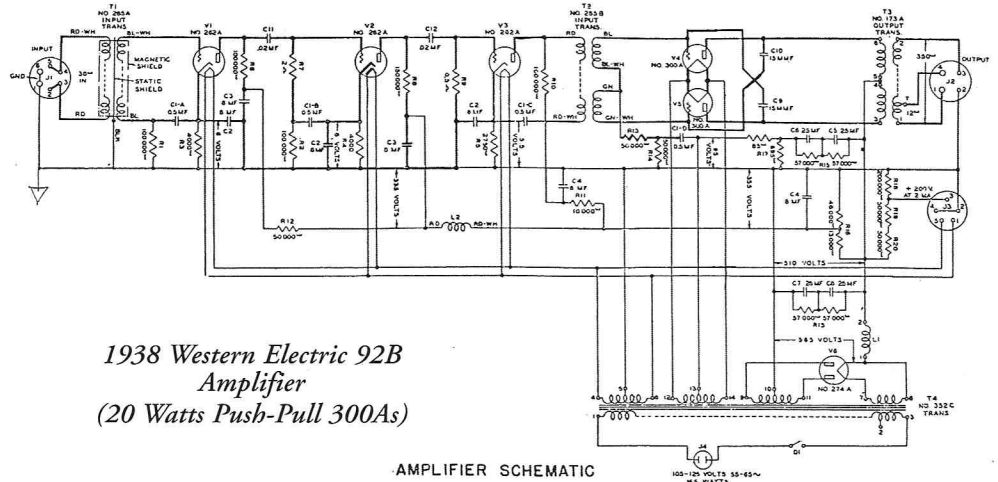

1938 Western Electric 92B
Amplifier
(20 Watts Push-Pull 300As)

hi-fi dealers think of "Push-Pull." That's all that North Americans and Europeans had ever heard, until the first SE-DHT amplifiers exploded on the scene in the early Nineties.

But you know what? A zero-feedback, non-RC-coupled, all-triode amplifier sounds as different from conventional PP as conventional PP sounds from single-ended direct-heated triode! It's a sound that will take most audiophiles by surprise once they hear it ... yet in engineering terms, it's nothing more complicated than selecting the most linear electronic devices (direct-heated triodes) and topology (very deep Class A push-pull). When the adventurous designer enters the new/old territory of naturally linear circuits, there are some things to watch out for. For one thing, power supply coloration becomes more objectionable, not less, when it can't hide behind a veil of distortion. The conventional wisdom says that Push-Pull, or differential, circuits are less sensitive to power supplies as a result of Common-Mode Rejection (CMR), which expressed another way, results in an improved Power Supply Rejection Ratio (PSRR). This is only true in the gross sense of hum and noise, which are easy to measure, and is the end of the story for conventional wisdom.

What about sonics? Conventional single-ended circuits are fully exposed to power supply colorations, as shown in the previous part of the article. If-and only if-the PP circuit were perfectly balanced at all frequencies and power levels, it would have near-total immunity to power supply coloration, in addition to the expected hum and noise rejection. All of the AC current would flow from tube to tube, plate to transformer to plate to cathode to cathode, ending right back where we started. A beautiful picture of symmetry, all of the AC current flowing in a circle, needing no reference to ground either through the cathode-bypass cap or the PS filter cap.

In the world we live in this Platonic ideal of balance is never attained. In practice, the best that can be hoped for is about 5%, and we have to go to considerable lengths to make sure there are no frequency, level, or power-supply variations in the balance condition. The PP amplifier has a poor-quality SE circuit hidden within it, with the disagree

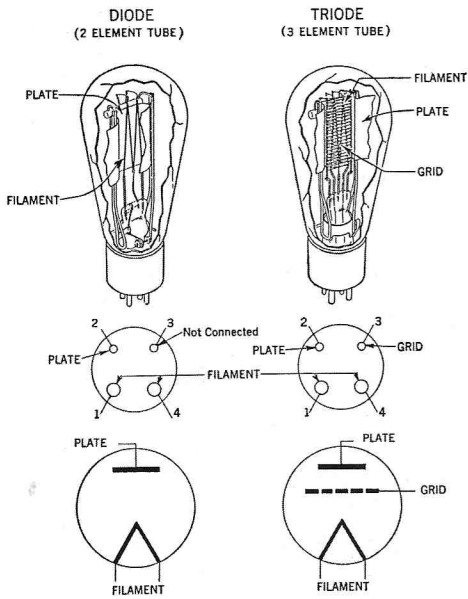

able property of unpredictable gain. If the PP circuit has typical phase-splitters (split-load, long-tail, see-saw, etc.), there's a frequency and level dependency to the SE circuit's gain. The drift in the balance condition is usually swept under the rug with the remark that

if it's hard to measure, it can't be very important.

The poor-quality SE amplifier hiding within the PP circuit is just as sensitive to power-supply coloration as the SE circuits in the previous section, with the added problem of selective amplification of power-supply coloration. In other words, with a physical SE amplifier, what you hear is what you get. If there's an electrolytic cap in the B+ filter circuit, it sounds like an electrolytic in the signal path. With the SE circuit hidden within the PP amplifier, there's the added problem of unstable gain to factor in. The electrolytic in the B+ filter circuit is audible, but it is behind a shimmering, gain-unstable circuit. This may be worse than the true SE circuit; the magnitude of audibility may be 26dB lower, but what's left is bouncing around with the signal, introducing a brand-new coloration that wasn't there in the SE circuit.

So in practice, PP circuits have less hum and noise than SE, but they also have power-supply colorations that are in some ways worse than a SE circuit. This may be why SE circuits are easier to "tune" than PP; the audio signal that is impressed on the power supply of a PP amplifier is considerably "dirtier" than a SE amp, where it is simply a clean and direct copy of the audio signal. If there is any tendency for the PP circuit drift into Class AB, the audio signal impressed on the power supply gets even dirtier, with substantial amounts of distortion present. The criticism of "haze" and unmusicality for PP amplifiers can be laid directly at the door of a complex and unstable power-supply coloration that is difficult to "tune out" in the manner of SE amplifiers.

Western Electric PP (F)

The KT bypass of this circuit provides a low-resistance, low-distortion path for the SE residue of PP. With the addition of one bypass cap, the 100µF B+ filter cap is no more than a noise sink, and is no longer part of the audio path. This circuit has the charm of simplicity, and cath-

ode-bias PP amps can easily be converted to WE PP - just be sure to use high-quality oil caps for the KT bypass, not poor-quality electrolytic caps, or you'll be right back where you started. Although it is desirable to keep the B+ filter cap to the existing large value, the bypass can be reduced to a fraction of the filter-cap value, which helps reduce the cost of the oil cap.

The WE PP circuit has special merit for PP applications where any possibility of Class AB operation can occur, since the brief excursions into the Class-B region require a low-impedance path between the plates and cathodes of the power tubes. If the low-impedance path flows through electrolytics (as it does in many PP amplifiers), the electrolytic coloration will suddenly intrude whenever one tube cuts off. This will only magnify the subjective colorations of the AB transition, which is already a problem for the amplifier designer. The WE PP conversion at least gets the amplifier closer to the "textbook" condition that assumes perfect capacitors with zero coloration.

Where does this circuit come from? Take a close look at bias circuit of the PP 300A's in the Western Electric 86, and in particular, C5 and C6. Although we have no "Theory of Operation" for the WE 86, the function of C5 and C6 are clear; they are KT bypass caps, similar to the C1-C bypass caps in the 262A driver section of the amplifier. (The function of C1-D and R13, R14, and R17 are less clear, and might be part of a hum and/or 3rd-harmonic reduction circuit. SPICE experts are invited to model this part of the WE 86 and let us know what they find.)

The WE 86 is old. The 300A specification tells us that the WE 86 schematic was drawn no later than 1935, when the 300B replaced the 300A. Just think, FDR was in the first term of his presidency when the WE 86 replaced the first-generation 211 amplifiers in movie theatres. There are fascinating design features in the WE 86 that were forgotten by the time of the Williamson, never mind the present.

Parafeed PP (G)

This is an interesting variation of parallel-feed for PP, and takes advantage of a split-primary transformer so that only one cap is necessary for the DC-blocking function. It might seem unnecessary to block DC - after all, PP transformers are designed to accommodate a moderate amount of DC - but zero DC allows core materials that would normally be off-limits for a PP transformer. The small amount of imbalance current might seem a minor matter, but it's not.

In the course of designing the Raven line-stage preamplifier, I collaborated with Brian Sowter of Sowter Transformers. The Sowter 9111 line-driver transformer has a 50% mu-metal core, and my original plan was to use a 10-turn balance pot to trim the DC balance of the circuit. Then Brian sent me the results of a test he had done on a production transformer that had the same core (and similar windings) as the new 9111.

Brian put a 20V 50 Hz sinewave on the primary, and measured the output distortion of the transformer for different amounts of DC offset. Here are his results:

Offset (mA)	THD+N (%)
0.0	0.0109
0.05	0.03
0.125	0.06
0.25	0.119
0.5	0.162
1.0	0.219
1.5	0.332
2.0	0.219
2.5	0.633

These are sobering numbers as only 50 microamps raises the distortion nearly threefold. A more typical 5% imbalance (1 part in 20) gives a twenty-fold increase in distortion! The transformer distortion null is razor-thin maybe 10 microamps wide. Think of it: for a preamp that runs at 20 mA per side, 10 microamps of DC offset is one part in 2000. That's a lot to ask a 10-turn trimpot: you might be able to adjust it to that precision, but how long will it stay in adjustment? Half an hour? As a former Tek employee, I know that DC precision and vacuum tubes are two things that don't go together.

The most direct solution is parallel-feed. Nothing to adjust, ever, and the series resistance of the plate chokes helps keep the tubes in DC balance-not that it matters to the output transformer, which only sees the infinitesimal leakage current of the capacitor. As with SE parallel-feed, the matched plate chokes buffer the power-supply coloration (and noise) from the audio circuit, but with an additional 20 to 30dB of noise rejection. If you want silence and a wide dynamic range, this is the way to go.

KT Parafeed (H)

This circuit is really blue-sky; whether it is "better" than the two previous circuits is hard to say. As mentioned before with the SE version, you might encounter positive-feedback operating regions, so a large cathode-bypass cap is probably desirable. As with SE, the cathode-bypass cap doesn't really do anything, it just shunts positive-feedback voltages to ground.

In terms of how the circuit operates, the two sides are in parallel, in comparison to (G), where the two sides are in series. How do you check? Easy. What happens when one tube is removed? With (E), (F), and (H), the circuit reverts to SE, which is another way of saying they are capable of Class AB operation (depending on load and bias). With circuit (G), both tubes are in series, so removing one tube shuts down the circuit; this circuit can only operate in Class A.

Conclusion

Conventional SE and PP circuits are directly exposed to the sonics of the parts in the power supply, with transistor circuits having the greatest problems as a result of low impedances and the consequent requirement for large-value electrolytics.

Jack Elliano's Ultrath, parallel-feed, and the Western Electric circuits take advantage of a transformer's floating

primary and make it part of a filter to isolate the power supply from the audio circuit. The isolation techniques can be applied to any transformer-coupled circuit, single-ended or push-pull. All benefit substantially from added power-supply isolation, not just in terms of easily-measured hum and noise, but in more audible but harder-to-measure subjective qualities.

By partitioning the audio and DC portions of the circuit into two separate elements, each can be optimized for the task it has to do--linearity for the audio portion, and isolation for the power supply. At first glance, they may look more complex on the schematic, but these circuits takes better advantage of the non-ideal properties of capacitors, inductors, and transformers.

This article only skims the surface of a new territory of vacuum-tube amplifier design. I am not a mathematician, so I hope those who are better qualified will jump in, analyze the new circuits, and share their discoveries with the readership of VTV. As for fearless experimenters, gentlemen, you may start your engines!

About the Author:

Lynn Olson has written for the Audio Engineering Society Journal, Positive Feedback, Glass Audio, and was the editor of Valve & Tube News during its span of publication. He is a co-founder of Aloha Audio, and is the webmaster of the Ariel Speaker Page at: <http://www.teleport.com/~lynnol/Ariel.htm> The Raven line driver, Amity, and Amity DHT Power Amplifier are at: <http://www.aloha-audio.com>

Sources:

Electra-Print Audio Company

4117 Roxanne Drive
Las Vegas, Nevada 89108 USA Phone: 702-396-4909
Fax: 702-396-4910 - E-Mail: electraudio@aol.com

VALVE Magazine/Electronic Tonalities

Phone: 360-662-1386 E-Mail: bottlehead@bottlehead.com
Web: <http://www.bottlehead.com>

MagneQuest Transformers

1404 E Bristol St., Philadelphia, PA 19124 USA
Phone/Fax: 215-288-4816 - E-Mail: magnequest@aol.com

Sowter Audio Transformers

The Boaryard, Cullingham Road, Ipswich IP1 2EG England
Phone: +44(0)1473 252794 Fax: +44(0)1473 236188
E-Mail: sales@sowter.co.uk - Web: <http://www.sowter.co.uk>

Lundahl Transformers AB

Tibeliusgatan 7, SE-761 50 Norrtälje Sweden Phone: 46-176-139 30
Fax: 46-176-139 35 - E-Mail: adm@lundahl.se
Web: <http://www.lundahl.se>

Lynn Olson

E-mail: lynno@teleport.com Visit Aloha Audio at <http://www.aloha-audio.com> and the Ariel Speaker Page at <http://www.teleport.com/~lynnol/Ariel.htm>

Dumpster Tubes: Vertical Output Tubes

By John Atwood ©2001 All Rights Reserved

In our last dumpster article, we covered 9-pin miniature tetrodes, many of which were designed to be used as vertical sweep amplifiers in TV sets. We now move to the triode members of the vertical amplifier group. It's hard to call these dumpster tubes, since their applicability to audio is outstanding. However their use in TV sets has insured that plentiful supplies of most of these tubes are still available. We will cover the single triode and identical dual triodes in this article; dissimilar dual triodes will be covered in the next issue.

A vertical sweep amplifier (also called the frame amplifier in Europe) is actually very similar to an audio amplifier. It has to faithfully amplify a modified 50 or 60Hz sawtooth wave to a power level of a watt or two. The asymmetrical nature of the waveform has encouraged the use of the single-ended topology. Early American televisions used triode-connected pentodes or one or two sections of a 6SN7GT as the amplifier. The sweep oscillator was often one half a 6SN7GT or 12AU7 run as a blocking oscillator. During the early 1950s larger screens and wider deflection angles required more sweep power, so new tubes were developed to address these power needs, both for vertical and horizontal deflection.

The 6SN7GT served well in many TVs, but there was a need for more "oompf" at lower plate voltages. One of the first new types was the 12BH7 - similar to the 6SN7GT and 6CG7/6FQ7, but with lower plate resistance. One side was used as an oscillator, the other as an amplifier.

Interestingly, the 12BH7 was reincarnated in the 1960s as

the 6GU7 for use as RGB an amplifier in color TVs. The 12BH7 was still not very powerful, so around 1952, Sylvania brought out the 6BL7GT. Originally it was made with a "box" plate construction, but was shortly changed over to the conventional "flange" plate configuration (see photos). Both sections together could dissipate 12 watts, almost twice what a 12BH7 could handle! Shortly afterwards,

the lower-mu 6BX7GT was introduced. It is physically identical to the 6BL7GT, but has a larger grid winding pitch. The 6BX7GT didn't find much use in TVs, but was picked up by industrial designers as a voltage regulator series pass tube.

Also in the early 1950s, several American single vertical sweep triodes came out: the 6S4, 12B4, and the rare 12A4. The 6S4 was essentially just a beefed-up 6J5. By lowering the mu to 6.5, the 12B4 had an even lower plate resistance than the 6BX7GT. The CBS-Hytron 12A4 was a higher-mu version of the 12B4, but never caught on, presumably since RCA's 6S4 was similar, and RCA had a lot more clout! In the higher-power area, the octal 6AH4GT and later the 6CK4 were introduced.

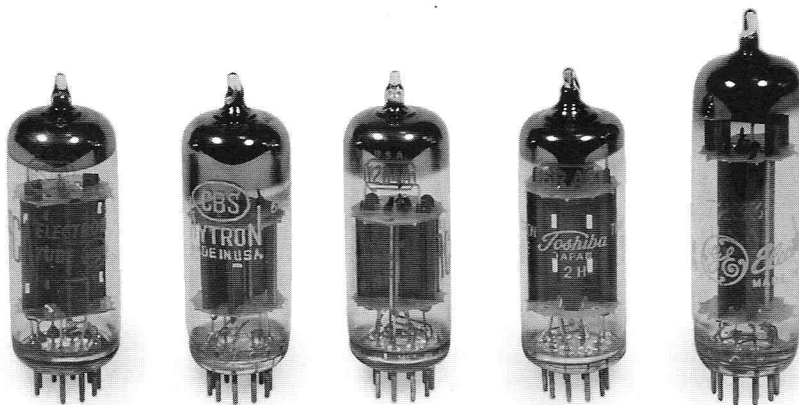

6S4A, 12A4, 12B4, 6RA6 and 7233

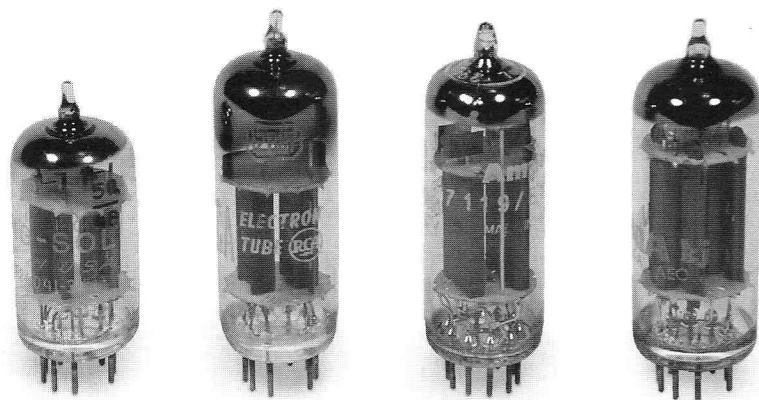

5687, 12BH7, 7119 and 6GU7

Interestingly, no dedicated European vertical sweep triodes were developed. Apparently pentodes were always used for this application. However, in Japan, it was a different story. There is a whole series of 9-pin miniature vertical output triodes from the 6R-A2 to the 6R-A9. As can be seen on the specification table, some of these were similar to American designs, but 6R-A2 to 6R-A5 were unique in having low mu of about 3, resulting in very low plate resistance. Although originally intended as a "hi-fi" amplifier rather than a vertical amplifier, the octal 6G-A4 is included here, since its specs are very close to the American 6CK4.

Although not TV tubes, a group of military/industrial triodes are included here, since they have specs comparable to the vertical

amplifier tubes. The Tung-Sol 5687 is a little powerhouse of a tube, combining a reasonably high mu of 16 with a low plate resistance. Although it never caught on in consumer gear (unlike Tung-Sol's 5881), it was widely used in military and industrial designs, and as a result is fairly common in the surplus market. By the late 1950s, improved versions of the 5687 were produced: the Bendix 6900 (see VTV issue #5, p.3), the GE 7044, and the Amperex/Philips 7119/E182CC. These all had slightly higher mu but lower plate resistance (i.e. higher transconductance). Note that these dual triodes do not have the same pin connections as the standard 9-pin dual triodes and will cause damage if plugged into 12AU7/12BH7 sockets! Another notable industrial tube is GE's 7233. Intended for use as a series regulator, its specs are similar to the Japanese 6R-A5.

So, how can these tubes be used in contemporary audio designs? Some of the dual triodes have already been used in classical designs: the 12BH7 in the Heathkit W-6M and the 6BX7GT in the MacIntosh MI-200. The medium-mu types (12BH7, 6BL7GT, 5687, 6S4, etc.) make good driver tubes in conventional RC-coupled driver stages in push-pull or single-ended amps. In situations where there is a lot of Miller-effect capacitance to drive, as when driving paralleled output tubes, the low plate resistance and higher current capability of the vertical output tubes can help maintain a decent high-frequency response. For purists who are concerned about cross-talk between sections of dual triodes (a real concern, except for in which the sections are shielded from each other, such as the 6BQ7, 6DJ8, and 6CG7), the single triode types are suitable. A trick that achieves the same result with the 6.3/12.6V dual triodes is to only connect the heater for one triode. By heating different sides for different channels, the tubes can be swapped when worn-out, giving them a second life!

In order to get decent low-frequency response from an interstage transformer, either a very high primary inductance is needed or the driving impedance from the tube

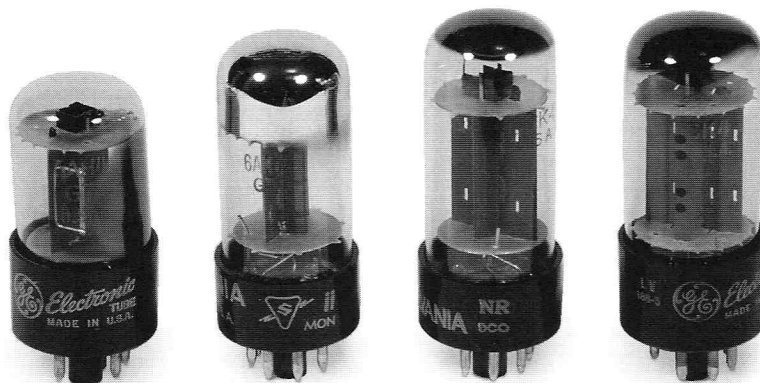

6AH4 (GE), 6AH4 (Sylvania), 6CK4 (Sylvania) and 6CK4 (GE)

has to be low. High inductance transformers have lots of problems achieving good high-frequency response. The low-mu vertical output triodes have low plate resistance which reduces the required primary inductance, making them great transformer driver tubes.

Vertical output triodes also make good low-power output tubes, either push-pull or single-ended. More power for a given plate dissipation can be obtained from the lower-mu versions. The 6CK4 and 6R-A2 have characteristics that are within 50% of a 2A3, making them an interesting alternative to this famous filamentary triode. The low-plate resistance also make good OTL (Output-Transformer-Less) output tubes. One of Julius Futterman's first OTL amplifiers from 1954 used eight 12B4s in push-pull-parallel. An article in the April 1990 issue of Japan's "MJ" magazine describes an OTL amp that uses eight 6R-A3 tubes in each channel and puts 40W rms into 16 ohms per channel.

As was recognized by the test equipment designers of the 1950s and 60s, vertical output triodes make good voltage regulator pass tubes. The low-mu ones are the most efficient, permitting the lowest voltage drop across the pass tube. However, the high-transconductance higher-mu ones can give better regulation for lower current loads, due to their higher voltage gain. The 12B4 was extensively used in Tektronix and Hewlett-Packard equipment as a pass tube. Toward the end of the tube era, both H-P and Tektronix started using the 7233, a great regulator tube.

The specifications table shows the key specs for a variety of vertical output and related tubes. Note that the maximum power dissipation (Pdmax) for each tube has been normalized to the "Design-Center" system.

In the next issue we will cover the final evolution of the vertical output tube: the dis-

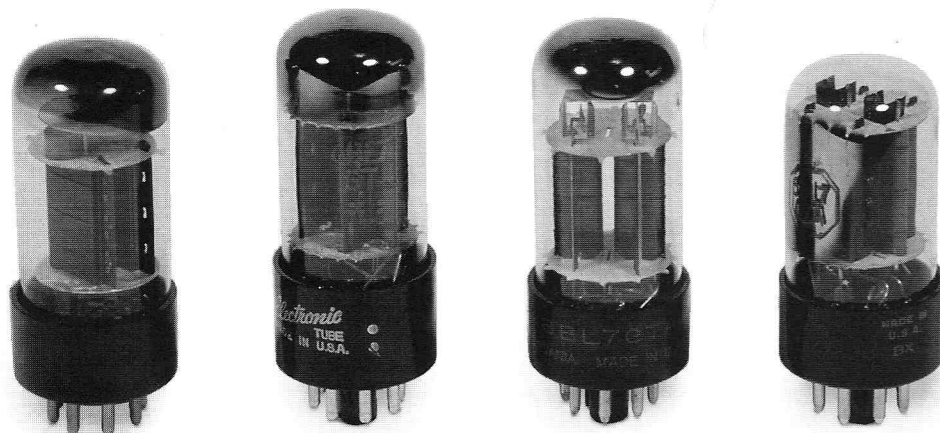

6BL7GT (Sylvania), 6BL7GT (GE), 6BL7GTA (Sylvania) and 6GL7GTA (RCA)

Type	Base	Ifil	Pdmax	mu	Rp	@ Ip	comments
American vertical output types:							
6AH4GT	octal	0.75	7.5	8	1780	30mA	
6BL7GTA	octal	1.5	10/12*	15	2150	40mA	dual
6BX7GT	octal	1.5	10/12*	10	1300	42mA	dual
6CK4	octal	1.25	11	6.6	1200	40mA	
6GU7	noval	0.6	same as 12BH7 with 6FQ7 pin-out				
6S4A	noval	0.6	7.65	16	3700	26mA	
12A4	noval	0.3/0.6	5.9	20	2500	23mA	12.6/6.3V
12B4	noval	0.3/0.6	5.5	6.5	1030	34mA	12.6/6.3V
12BH7	noval	0.3/0.6	3.5	16.5	5300	11.5mA	dual, 12.6/6.3V
Similar industrial types:							
5687	noval	0.45/0.9	4.2	17	2000	23mA	dual, 12.6/6.3V
6877	noval	0.8	12	3.75	2000	75mA	
6900	noval	1.0	3.4	18.5	1600	36mA	dual, 12.6/6.3V
7044	noval	0.45/0.9	3.6/6.4	21	1750	36mA	dual, 12.6/6.3V
7119/E182CC	noval	0.32/0.64	4.5	24	1600	36mA	dual, 12.6/6.3V
7233	noval	1.0	6.4	4	230	120mA	
Japanese types:							
6G-A4	octal	0.75	10.4	10	1400	40mA	for Hi-Fi use
6R-A2	noval	0.76	12	3.3	440	100mA	
6R-A3	noval	1.0	12	3.1	300	88mA	
6R-A5	noval	1.0	12	3.3	290	80mA	
6R-A6	noval	0.9	8	15	1750	26mA	
6R-A8	noval	1.0	12	9.7	900	55mA	
6R-A9	noval	0.6	8	16.5	2500	22mA	
8R-A7	noval	0.6	8	6	909	42mA	
8R-A9	noval	0.45	same as 6R-A9, 8.5V heater				
9R-A6	noval	0.6	same as 6R-A6, 9.0V heater				

Heater voltage is 6.3V, except where noted.
Power dissipation rating for dual tubes is per section; rating marked with * is total for both sections.

similar dual triodes. The vertical output triodes are some of the best audio tubes not designed for audio. They are proof that you don't have to use "audio" tubes to get good sound!

References:

1. General Electric Co., "Essential Characteristics," 1974.
2. Koji Hayashi's tube history.

For the Japanese triodes:

<http://radiomann.hoops.ne.jp/HomePageVT/CESa.html>

For American vertical output tubes:

http://radiomann.hoops.ne.jp/HomePageVT/Ver_US_Trio.de.html

(Note: These sites are in Japanese)

<http://www.triodeel.com>

Check out our site for...

...OEM tube data, schematics, links to nearly 200 tube related sites all over the net, plus lots more

...World famous Dynaco upgrade boards, simple & effective

...Magnequest replacement transformers for Dynaco(tm)

...Upgrade chassis for ST70, complete & partial kits

...Tubes: JJ/Tesla, Svetlana, Sovtek, Philips, NOS

...capacitors, resistors and a potpourri of useful stuff

...more to come...new EZ-Build modules, (cheap hi-end for everyone!), new paper capacitors, & the list goes on..



triode electronics

2225 W Roscoe St, Chicago, IL USA Ph 773-871-7459
Fax 773-871-7938 Office hours 12:30-8:00 CT M/F
(or until we get tired or thirsty)
Email us at postmaster@triodeel.com
"Worldwide Service, Neighborhood Prices"

Dating Philips Tubes After 1948

By Alan Blake ©2001 All Rights Reserved



1. Introduction

Most Philips tubes are marked with a group of symbols which contain coded information relating to the type, place of manufacture or country of origin in the case of bought-in tubes, and the date of manufacture.

This article details two code formats using the same type identifiers which were in use from 1948 to the end of manufacture of receiving tubes. The code format changed from the "old" to the "new" system around 1955-1956. From examination of actual tubes it is clear that whatever may have been the decree from Eindhoven, there were apparent deviations on the ground at manufacturing plants in other locations. Again, based on examination, it seems that prior to the coding system described here, a purely numerical system was in use for encoding the type and that for its own production, Mullard continued to use this until adopting the "new" code in 1955.

Some of the information is open to interpretation, due to being translated from fairly terse Dutch original documents, or based on examination of actual tubes. No claims of absolute accuracy are made.

2. The Code Elements

The code has the following elements, represented in section 3 below by the following bold letters:

T Type: May consist of one, two or three symbols.

F Factory: Manufacturer or country of origin. One symbol.

Y The least significant digit of the year of manufacture: This is only present in the 'new' code.

M Month of manufacture: In the "old" code this was represented by a sequence of 36 symbols which repeated every three years according to the following table:

Month	1948	1949	1950
	1951	1952	1953
	1954	1955	1956
Jan	A	R	t
Feb	B	S	O
Mar	C	T	1
Apr	D	U	2
May	E	W	3
Jun	F	X	4
Jul	H	Y	5
Aug	K	Z	6
Sep	L	d	7
Oct	M	k	8
Nov	N	m	9
Dec	P	r	+

In the 'new' code each month is represented by a simple sequential letter:

Jan A	May E	Sep I
Feb B	Jun F	Oct J
Mar C	Jul G	Nov K
Apr D	Aug H	Dec L

W Week of manufacture within month: 1 first, 2 second, etc. This seems to only been added from 1961 onwards, although that does not mean that all tubes made from 1961 bear it.

C Change symbol: The intention of this is not clear, but it may have been a symbol that was to be changed for each batch produced. In the 'old' code there was no year but the change symbol sequence was replaced in three year cycles such that this, taken together with the month symbol, would be a unique combination for any particular year. For example: Month W with change T would be unique to May 1955. The change sequence is indicated in the box below.

Batch:	0	1	2	3	4	5	6	7	8	9	10	11	12	13	14	15	20
1948-1950	0	1	2	3	4	5	6	7	8	9	=	□	%	t	h	Δ	o
1951-1953	A	B	C	D	E	F	H	K	L	M	≡	>	d	r	~	↗	
1954-1956	N	P	R	S	T	U	W	X	Y	Z	+	k	∟	m	∇	L	

3. Code application

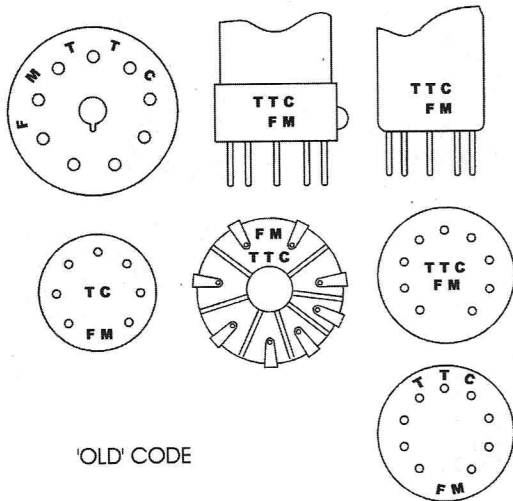

'OLD' CODE

Section 3: Philips Factory Symbols
Code Applications on Valves

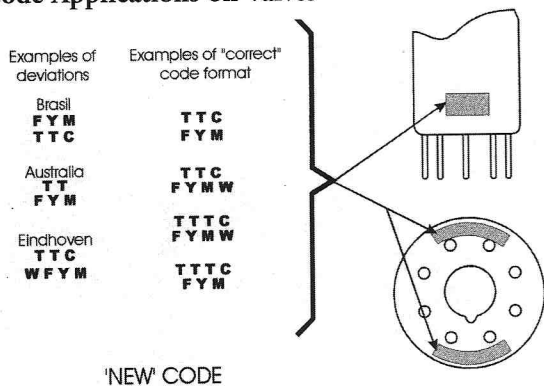

'NEW' CODE

In the "new" code this was just a sequence of symbols which appear to have no purpose other than perhaps provide batch traceability. Evidence indicates that this aspect of the code may not have been applied too rigorously at some locations. It is found to be missing on examined tubes of Australian Philips manufacture, for example. It was not applied to purchased tubes. The sequence to be applied was:

0 1 2 3 4 5 6 7 8 9 A B C D E F G H J I K L M N O P
Q R S T U V W X Y Z d f m r t

Presumably this sequence was then repeated if necessary.

3. Code Application

For both the "old" and "new" systems, the coding was applied to the tube as two groups of symbols. These can be found on the side of the bulb just above the base, on the side of the base molding, under the base or occasionally on the underside of the spigot.

"Old System"

For single symbol code (only used for 7 pin miniatures): **TC FM**. For two symbol type codes: **TTC FM**. The order may be reversed as **FM TTC**, and in the case of B9G (9 pin similar) types the symbols appear around the outer edge of the base without break as **FMTTC**.

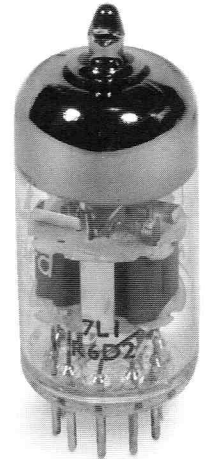

Mullard CV2493/6922
Date Code

"New System"

For two symbol type codes: **TTC FYM**, **TTC FYMW**. However there are exceptions to be found on some Eindhoven production as **TTC WFYM**, on Australian tubes i.e. with no change symbol giving rise to possible confusion with the 'old' system, and pairs reversed on Brazilian tubes as **FYM TTC**.

For three symbol type codes: **TTTC FYM**, **TTTC FYMW**.

Type Codes

Anything like a complete listing of the type codes would be beyond the scope of this article (and the size of this journal). However, by way of example, a few common audio types are included here. There may be more than one code for a particular type and this generally indicates some detail production difference. However, this is sometimes simple code duplication. It has to be remembered that the coding had to be administered on a world-wide basis before the common availability of computers and global data communications.

Examples of Type Codes:

E88CC/6922	7L
E188CC/7308	VR
ECC35	RU
ECC81/12AT7	Tk, VE, YK
ECC82/12AU7	Gf, K6
ECC83/12AX7	I6, f9, mC
ECF82/6U8	4X
EF86/6267	tE, BY, 9r
EL34/6CA7	KE, SY, Xf
EL37	R6

Alan Blake worked as a tube applications engineer at Philips/Mullard UK in the 1960s and 1970s.

This article was reprinted with permission from:

The Tube Collectors Association Journal
www.tubecollectors.org

Philips Valve Fonts

◻	A
⊙	B
△	C
#	D
⋈	E
⊖	F
⊥	G
⌊	H
⌋	I
⊞	J
□	K
×	L
⌒	M
↗	N
∴	O
=	P
≡	Q
≡	R
≡	S
⊙	T
*	U
ψ	V
⊙	W
△	X
~	Y
℞	Z
ƒ	f
⌋	l
⌋	t
⌋	2
ε	3
4	4
2	5
∂	6
∇	7
∅	0
⌒	[
⌒]

Philips Valve Companies and Affiliates

A Wiener Radio Werke "WIRAG", Wien
 B Mullard, Blackburn
 C Hendon Works, Alberton, Australia
 D Valvo, Hamburg
 d Ned. Instituut voor Fysisch Onderzoek
 E Hyperlec Brive (Correza)
 f Standard telephones and Cables Ltd. (later Thorn)
 East German origin (after 1 Jan 1970)
 G Mullard, Fleetwood
 Loewe Opta (after 22 Feb 1954)
 I Thorn-AEI Radio valve Co. Ltd. (Ediswan) , Mullard supply
 J Mullard, Tottenham (formerly Tungstram)
 L M.B.L.E., Bruxelles (Mazda)
 m ?
 N Matsushita Electronics Corp., Takatsuki, Japan
 G.E.C. Mullard supply
 n Matsushita Electronics Corp., Kyoto, Japan
 P Papesa, Buenos Aires
 R Mullard Radio Valve Co., Mitcham
 r Philips Electronics Industries Ltd., Ontario, Canada
 S Lampara "Z", Barcelona
 T Philips, Eindhoven, afd 22652
 t T.I.C. Philips Export Corp., New York
 † C.I.F.T.E., Courbevoie
 U Thorn-AEI Radio Co. Ltd. (Formerly B.T.H.)
 V Bharat Electronics (Private) Ltd, Bangalore 13, India
 X Philips, Sittard, afd 22127
 x Philips, Chilena de Productos Electronicos, Chile
 Y Philips, Sittard, afd 22117 and 22118
 Z Philips, Monza
 1 Philips, Eindhoven, afd 22020
 2 Philips, Eindhoven, afd 22021
 S Ferranti (Mullard supply)
 3 Philips Eindhoven, volgroepen I and II, Schouwbroekseweg
 Fivre, Italy (after 1 Jan 1970)
 ε Marconi, Chelmsford (Mullard supply)
 4 Venolanda S.A., Venezuela
 4 English Electric Valve Co. (Mullard supply)
 5 Toshiba, Japan
 2 Cinema Television (Mullard Supply)
 6 Philips, Eindhoven. Radio tube lab. receiving tube technology group
 Russian origin
 ∂ Mullard Fleetwood (after 18 Nov 1954)
 7 Philips, Eindhoven Radio tube lab. physics group.
 Hitachi, Japan
 ∇ Electrical and Musical Industries. (Mullard supply)
 8 Philips, Eindhoven. Radio tube lab. glass group
 9 Philips, Heerlen Radio tube lab. receiving tube technology group.
 + Philips, Sittard afd 22126
 = La Radiotechnique, Clichy (Neotron)
 * Amperex Electronic Corp., New York
 Δ Philips, Copenhagen
 < Philips Electrical Lamps Inc., Philipines
 > Visseaux, France

Life and Times of the EL34

By Eric Barbour, Senior Editor ©2001 All Rights Reserved

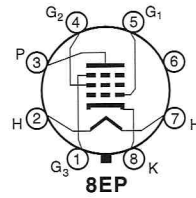

Phil Taylor suspects that the EL34 was derived from the EL37, because the original ratings for the two were remarkably similar. Because Philips was forced to pay royalties to RCA for the right to manufacture aligned-grid beam tubes (such as the EL37), the EL34 was obviously made a pentode to

Introduction

Since we did our first EL34 report in VTV issue 2, the editors of VTV have come across some more historical facts. A major source of information has proven to be former Mullard engineer Alan Blake, who worked at Mullard Blackburn in the 1970s. His help, along with the help of Phil Taylor and other tube collectors, gave us more data into the origin of this wildly popular power pentode.

The Essential History

It appears that Philips actually introduced the EL34 in 1954. It may have been "on the drawing board" for some years before that, because a 1950 Philips data manual exists which mentions it in passing. Apparently they did not make a big splash with it, because some Philips data manuals of the period do not even mention the type. It was introduced simultaneously with the GZ34, so the two apparently were meant for use together in audio amplifiers. (And, in fact, the early ring-base GZ34 looked identical to the ring-base EL34, except for a shorter structure and bottle.) Alan Blake remarks that the EL34 started from the earlier Philips developmental type 4699, originally intended for use in movie sound amplifiers. Philips engineers showed their classic 20-watt hi-fi amplifier circuit in the May and June 1955 issues of *Wireless World*, so that may have been the first published application for the EL34. The circuit is reproduced in the 1959 Mullard book *Circuits for Audio Amplifiers*, which is still in reprint today. Tooling and early production appears to be entirely the work of the main Philips facility in Eindhoven, Netherlands.

avoid the patent issue, thus keeping the price of manufacture down. Another difference was the use of the relatively new "button seal" on the EL34's base, rather than the older "pinch" construction of the EL37—thus allowing higher dissipation and higher operating voltages.

All of the EL3x series were closely related, even though they were explicitly rated either for audio use (EL31, EL34, EL37) or for TV horizontal sweep drivers (EL36 later in its commercial life, EL38). Another remarkable similarity is between the EL31 and EL38. Even though the former was intended as an audio power amplifier and the latter was aimed at TV sweep use, the two tubes appear to

be identical as their ratings are almost identical, except for the peak anode voltage handling of the EL38. Both even had anode caps and the same basing. The EL31 also had a larger-diameter envelope—an easy change for the factory that made both. So, beware of fools who claim that audio tubes had some "special magic" not



Mullard Type 1 Metal Collar Base, Type 1 Wide Brown Bakelite Base and Type 1 Dark Brown Bakelite Base

existing in similar tubes used in TV sets. Remember, by the 1950s and continuing through the 1980s, the sales of TV tubes far exceeded those of audio types! Sweep tubes can make excellent audio devices.

Many have remarked that the EL34 official anode voltage maximum rating of 800vdc was excessive for an octal-based tube. The issue is with creepage distances. Pin 3 being the anode, its proximity to pin 2, a heater connection, seems like a very bad idea. So is having the screen on pin 4 and the control grid on pin 5, then recommending the tubes use in ultralinear amplifier designs! The vast majority of octal-base power tubes (at least, those not mar-

keted by Philips or Mullard) are rated for 400v to 500v maximum on the anode. The 6550, which appeared shortly after the EL34, used a special base with raised ribs between the pins to increase leakage path lengths.

Even then, Tung-Sol only rated the 6550 anode for 600v maximum. Philips has long been known for very aggressive marketing, so this 800v rating appears to be an example of their standard practice. The long delay between the EL34's development and its introduction is also indicative of a mercenary attitude about new product development. As a temptation to EL34 users, Alan mentions that Mullard had developed a "super EL34" pentode in 1958. Officially given the number EL131, it was sampled and publicized, but apparently was not put into production. Ironically, this prototype tube is briefly mentioned in the 1994 edition of the Vade Mecum, on the same page as the KT67, 350B, 7581, and 7591.

Among the first amps to use the EL34 were the Marantz 2 (1955), Dynaco Mark II (1956), and the rare Pye Mozart, a single-ended 9-watt British unit from 1956. The easy drive requirements allowed a 30-40 watt amp to be built using only 3 tubes: the two EL34s, and a triode-pentode as the voltage amp and phase splitter. This made the EL34 a must for Dynaco to use in their Mark II and Mark IV mono amps and their stereo version, the Stereo-70. At least half a million Stereo-70s were sold from 1958 to 1977. The EL34 was also used in the Leak ST-50 and ST-60; Marantz 5, 8A, 8B and 9; the H. H. Scott 240, 250, 272 and 290; the Eico HF35, HF50, HF60, HF87 and HF89; the Heath W-7A; the Acrosound UL-II and UL-120; the Fisher 55A, 200, SA-300 and X-1000; and many, many others. These are some of the best tube hi-fi amplifiers ever made. So it wasn't such a bad tube after

all. And in fact, many audiophiles prefer it over the 6550 and other types.

The EL34's popularity was sealed when Jim Marshall selected it for his JTM45 guitar amp in 1965. He went with it because it was cheaper and easier to get in England than the 6L6 he had used previously. That amp became a standard for the British blues-rock sound. The EL34 also found its way into Hiwatt, Orange, and Laney amps, all made in Britain, as well as the popular Canadian-made Traynor brand. Because the EL34 has a much more pronounced distortion characteristic than the 6550 or other similar power tubes, its sound is distinctive and is a major influence on the heavy rock sound palette. Marshalls are often run full-tilt, which has caused reliability problems. In fact, the American importer of Marshalls was putting more rugged 6550s in the amps during the late 1970s and early 80s. But when new distribution was set up in 1986, Marshall was adamant that the amps be equipped with EL34s exclusively. And most ironically, some major Marshall dealers in the UK put KT77s in the amps they sold or serviced, even though the sound was quite different—simply because the KT77 could more easily tolerate the pounding it took in a guitar amp.

Why do EL34s sound so different from other tubes in guitar use? Because they were low in cost, they had a less "hard" vacuum and a less rigid structure than 6550s and similar types. Since the signal voltages in a tube amp can get very high at times, the tube's piezoelectric and mechanical behavior can influence the sound. Overall, most EL34s have a softer distortion tone than 6L6s or 6550s because of the construction differences and the pentode design. The Sylvania 6CA7 of the 1970s and M-OV KT77 are actually beam tetrode types, which give lower distortion than pentodes. This is usually not easy to hear at low volumes, but is

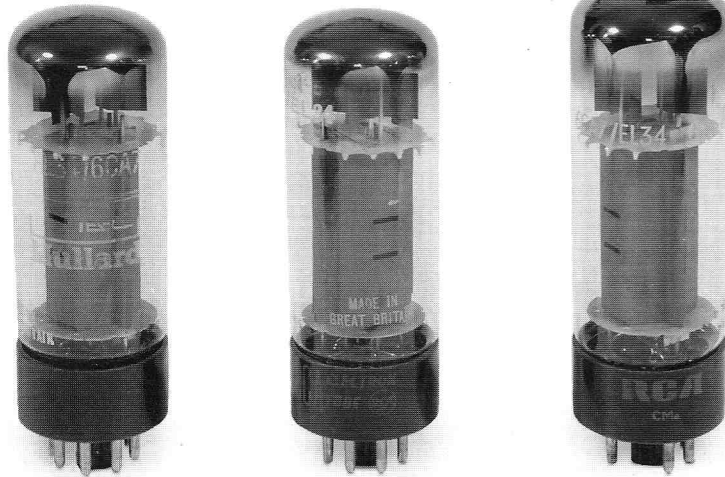

Mullard Xf2 (1970s), Xf2, Mullard/RCA (1960s) and (RCA) Xf2 1970s



Single Halo Getter Ring (Xf2), Double Small Halo Getter Rings (Xf1) and Double-D Getter Rings (Amperex-Holland)

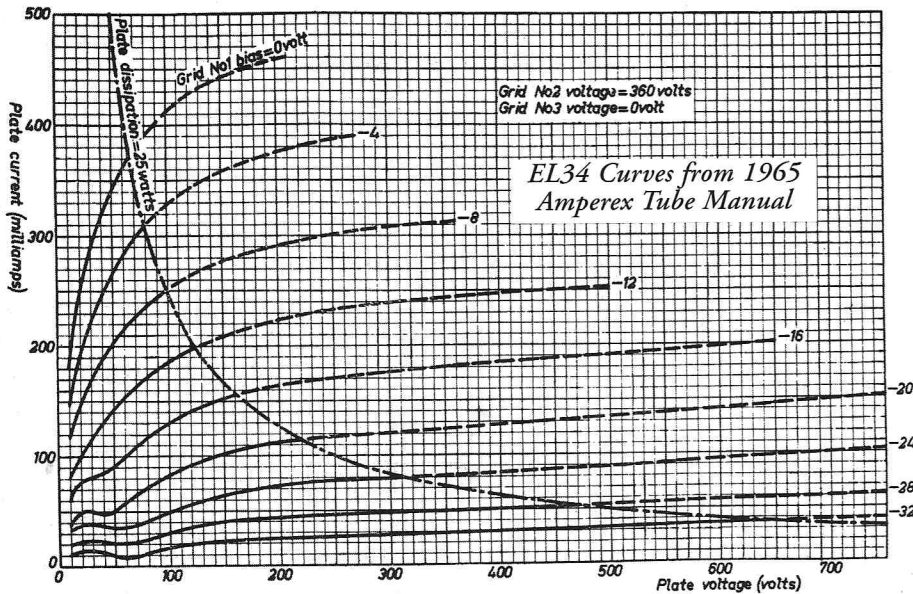

top (with a seam) and metal base ring, which is actually a cheap stamping of nickel-plated steel. The plates are medium-gray colored and spot-welded with a large metal circular plate on the top inside of the tube (probably for the getter). The getter flash on the inside of the tube was typically darker silver or even silver-black colored. There were four small rectangular openings on the sides of the plate (two each side). Type Is were primarily made in Philips's Eindhoven, Holland tube manufacturing facility. They were sold labeled as Amperex Bugle Boys, Mullard, Telefunken, Valvo and other European brands throughout the mid-to-late 1950s. Kevin Deal reports that he has an early Amperex Type I with a wafer (nude glass) base which may have been a pre-production prototype.

quite apparent when the amp is pushed into clipping distortion, especially in a guitar amp. So personal preference can be a major factor.

Types

Perfectionists still look to NOS versions for the standards. In the beginning there was only the Philips/Mullard original, or "Type I" (no Xf code), with a squared-off glass

Type I EL34s were reportedly the best ever made, which has contributed to the impossibility of finding NOS samples. Type Is had the date code stamped on the side of the metal base (not etched on the glass as in later versions). Dissipation has always been listed at 25 watts, but could usually be exceeded (and often was in certain guitar amps). Well-used Type Is frequently have heat-stress cracks in the

Operating Characteristics Class AB, two tubes
Supply voltage 375 volts

Load resistance, plate to plate	3400	ohms
Common grid No. 2 resistor	470	ohms
Cathode resistor	130	ohms
Grid No. 3 voltage	0	volt
Input voltage	0	21 volts (rms)
Supply voltage	375	375 volts
Plate voltage + voltage across cathode resistor	355	350 volts
Plate current	2x75	2x95 ma
Grid No. 2 current	2x11.5	2x22.5 ma
Max. signal power output	0	35 watts
Total harmonic distortion	—	5 percent

Operating Characteristics in Triode Connection
(Grid No. 2 connected to plate)
Class A, one tube, supply voltage 375 volts

Supply voltage	375	volts
Grid No. 3 voltage	0	volt
Cathode resistor	370	ohms
Load resistance	3000	ohms
Input voltage	18.9	volts (rms)
Plate current	70	ma
Max. signal power output	6	watts
Total harmonic distortion	8	percent
Input voltage for power output of 50 milliwatts	1.7	volts (rms)

Operating Characteristics in Triode Connection
(Grid No. 2 connected to plate)
Class AB, two tubes, supply voltage 400 volts

Supply voltage	400	volts
Grid No. 3 voltage	0	volt
Cathode resistor	220	ohms
Load resistance, plate to plate	5000	ohms
Input voltage	0	22 volts (rms)
Plate current	2x65	2x71 ma
Max. signal power output	0	16.5 watts
Total harmonic distortion	—	3 percent

TENTATIVE DATA

Class AB₁ Audio Amplifier
Distributed Load Connection

Maximum Ratings (Design Center Values)

Plate and Grid No. 2 Supply Voltage	500 V
Plate Dissipation	25 W
Grid No. 2 Dissipation	8 W
Cathode Current	150 mA
Grid Current Starting Point - Grid No. 1 Voltage when Grid No. 1 Current is 0.3 μA	-1.3 V
Grid No. 1 Circuit Resistance	500 K Ω
External Resistance Between Heater and Cathode	20 K Ω
Voltage Between Heater and Cathode	100 V

Typical Operation (Fixed Bias - Two Tubes Push Pull)

Plate Supply Voltage	500 V
Grid No. 2 Supply Voltage	(See Note 1)
Grid No. 1 Bias	(approx.) -44.5 V
Plate to Plate Load Resistance	7000 Ω
Plate and Grid No. 2 Current (Zero Signal)	2x57 mA
Plate and Grid No. 2 Current (Max Signal)	2x112 mA
Input Signal Voltage (rms)	32 V
Power Output	60 W
Harmonic Distortion	2.5 %

Note 1:
Screen voltage is obtained from taps located at 43% of the plate winding turns. An unbypassed resistor of 1 K Ω in series with each screen grid is necessary to prevent screen overload.

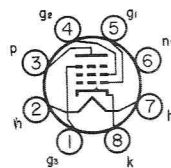

PIN CONNECTIONS

- NO.1- GRID NO.3
- NO.2- HEATER
- NO.3- PLATE
- NO.4- GRID NO.2
- NO.5- GRID NO.1
- NO.6- N.C.
- NO.7- HEATER
- NO.8- CATHODE

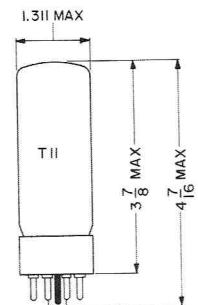

EL34 Specifications from 1965 Amperex Tube Manual

metal ring, yet often still test like new.

The Type II (Xf1 code) had a large diameter base of either dark red or dark-brown bakelite. The pins on the base were numbered and there was a small hole in the center of the locating pin. There were two small-diameter getter rings and the top of the tube was rounded with no glass seam. The Type IIs also had welded plates with two rectangular holes on either side, the classic profile. The first versions of Type IIs (Xf1) appeared around 1957-1958 and were seen labeled as Amperex, Mullard, Telefunken, etc. Later, versions are often seen relabeled 6CA7/EL34, with Amperex, Tungram, RCA, GE or Sylvania logos. (The American JEDEC designation 6CA7 apparently was bestowed around 1960.) It was also the original tube seen in 60s Dynaco amps, with the Dynaco brand. All Type IIs possessed a pair of 4-digit production codes. Early Type IIs (Xf1) had date codes printed in black ink with slightly larger letters than the later Type IIs (Xf2) with their date codes etched into the glass permanently. Type IIs came in three basic variations:

Xf1 Coding: This indicates manufacture at Mullard's main plant in Blackburn, UK (the B in the date code) from the late 1950s to 1961-1962. The first generation Xf1s had a larger diameter dark red base with a very large circular top getter ring. The later version Xf1s had a dark brown bakelite base and small double-halo getter rings. A typical Xf1 date code is: Xf1 BOK2.

Xf2 Coding: This indicates manufacture in either Blackburn or Eindhoven during the early to late 1960s and early 1970s. Xf2s made in Blackburn had standard diameter black bakelite bases and had either a large single halo or double-halo getter rings. We noted that typically the double-D getter rings were made from the early-to-mid 1960s, and the large single halo ring versions came later. This was not always the case, however. A typical date code for a Blackburn-made Xf2 is: Xf2 B4T4. Blackburn-made Xf2s were widely sold in the US, branded as CBS, GE, HP, Magnavox, Motorola, RCA, Sylvania, Zenith, and others.

Xf2s made in Eindhoven had a medium-brown bakelite base with double-D getter rings. These were branded Amperex Bugle Boy, Dynaco, Marantz, etc. A early date code for an Eindhoven Xf2 is: Xf2 X7H. (Note three-digit production and date code). Note that Tesla produced some Xf1 knock-offs. They have the same large-diameter base with some cosmetic differences. The pin diameter was slightly larger and more square than round-appearing. There was no hole in the center key and the getter was rainbow-colored on the edges.

Xf3, Xf4, and Xf5 Coding: This was a mixed bag of combinations. We have seen Blackburn-made Xf3s and Xf4s with welded plates and single large halo getters, and early 1960s and later date codes. We have also seen Xf3s, Xf4s and Xf5s with double-D getter rings and brown bakelite bases, obviously made in Eindhoven, Holland. In addition, we have samples of Xf3s with crimped plates and single halo getters made in the late 1960s. With Xf3

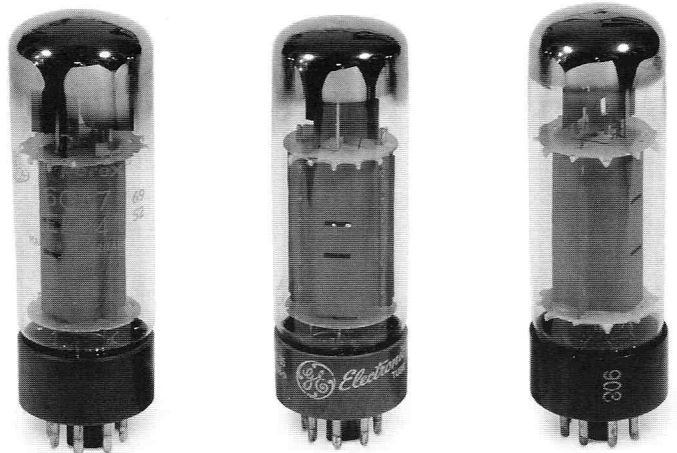

Amperex Branded Xf2 (1960s), GE/Amperex Double-D Getter (1960s) and Telefunken EL34 (1960s)



Amperex Bugle Boy (1957), Amperex Bugle Boy (1958) and Amperex Bugle Boy (1960s)

and later versions, it is difficult to come up with an exact way to identify each type as there were so many variations.

The Type III appeared about 1968-9. Its base was smaller and black. The anode was crimped (three square holes per plate side) at first. Many were thought to have been made in Blackburn. There were three variations of the Type III: first with two getter "haloes," then with one, and finally (in the 1980s) with one halo and a spot-welded plate, probably made by Tungram. EL34 experts say that quality started to slip in the 1980s, and the later welded plate EL34s were the least consistent of all. Many had screen-dissipation problems and reliability issues.

1950s metal-based Telefunken-marked EL34s were actually made in Eindhoven by Philips. Telefunken physically manufactured at least three different versions of the EL34 in the 1960s and 70s. The 1960s versions had a black bakelite base with dual ring halo getters. The plates were crimped with five small square holes per side and had "flanges" reinforcing the two round holes on each side of the plates. The Telefunken logo and date codes were printed in white ink. Later versions of the Telefunken-

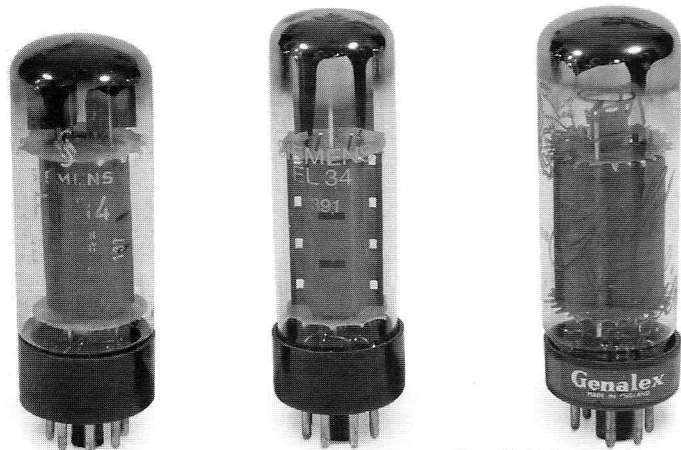

*Siemens EL34 (actually an Xf2 Mullard) (1970s),
Siemens EL34 Slim Bottle-Dimple Top (1991) and
Genalex KT77 Gold Lion Early (1970s)*



*Sovtek EL34EH (1999), Matsushita EL34 (1970s) and
Chinese EL34 (1990s)*

branded tubes were the "slim" version (similar to a type 3) with the crimped plates and dimple in the top of the tube. These were made by a division of ITT in East Germany. Note that there are many counterfeit versions of the Telefunken EL34 made in China, Japan and other countries, so beware!

Valvo of Germany (also owned by Philips) produced some EL34s in the 1960s. These apparently were similar in appearance to the Mullard Type IIs and had double halo getters. Siemens apparently did not actually make EL34s, but they did sell re-branded Xf2 Mullards with Siemens logos and boxes in the 1960s and 1970s. They also sold the ITT East German "slim" EL34s in the orange and blue boxes throughout the 1970s. According to Kevin Deal of Upscale Audio, neither Lorentz nor RFT ever made an EL34, or at least no one has ever seen one in the US recently.

There were some Japanese-made EL34s bearing Philips/Mullard branding. They were made by Matsushita, were offered in the late 1960s and 1970s, and looked like XF2s, except for the distinctive "seam" or flashing line in the top of the glass envelope. RCA re-branded these tubes,

and Dynaco sold them in their Stereo-70 kits.

In 1958 a major Mullard competitor decided to poach some EL34 business. Because pentode construction meant that the screen grid ran hotter than in a comparable aligned-grid beam tetrode, GEC's Marconi-Osram Valve division made the KT77. It looked like an EL34, it biased like an EL34-but it was built more like a 6550 internally, with beam plates and (most important) aligned grids, which lowered the current the screen grid was subjected to. This gave it lower distortion and greater reliability. Unfortunately, the KT77 was much more costly, and did not see much OEM business.

Around 1969, Sylvania decided they were sick of buying EL34s from Philips divisions, so they took a 6550 structure and changed the grids, so the tube biased like an EL34. This was called the 6CA7-STR (for "Special Test Requirement") or "fat bottle" 6CA7. It was remarkably 6550-like in appearance, except for the plain, small black Bakelite base. Some guitarists and audiophiles swear by it. Its aligned grids gave performance and sound similar to a 6550 or KT77. Unfortunately, it was not as successful as the true pentode. Production ceased in 1988. GE made their own version in the 1970s and 1980s. Copies have been made in the 1990s by Sovtek/Reflector in Russia and by Ei in Serbia, apparently with quality-control problems and very little success.

EL34s were widely made, in spite of their small demand compared to TV sweep tubes. Almost 20 different tube factories made EL34s from the 1960s into the 1980s. Today Sovtek/Reflector, Svetlana, JJ and Ei, plus at least two Chinese versions, enjoy considerable sales. I have estimated that the current yearly world demand for EL34s may be as high as 350,000, with Marshall being the largest single consumer (about 100,000, mostly for new guitar amps). This figure is expected to increase slowly for the next few years. Even so, the glass-tube industry continues to be bedeviled by the greedy price-shaving antics of big OEMs and dealers, plus corruption at Russian and East European factory complexes. The recent shutdown of Svetlana USA's support operation is not a good sign. Whether EL34s will be available in ten years is difficult to say for certain at this time.

Electrical Behavior of the EL34

As is often the case with power tubes, audiophiles and guitarists have only an empirical and subjective view of the differences between different brands and production eras of a given type. The situation is especially chaotic with regards to the EL34, which is known to have been manufactured by at least a score of factories all over the world, in various versions.

Below is a summary of EL34 tests conducted over the past several years. Most of the data for the NOS types were taken in the mid-1990s and should be representative (assuming one ever sees a Type 1 Philips again). The later

tubes were tested on exactly the same equipment in the same manner.

EL34 Test Results - Including KT77, 6CA7

Tested at 500v plate, 300v screen, 75mA. All tested with 3200 ohm transformer primary, 8-ohm load on secondary, distortion tested at 1 watt into load at 1000 Hz. "Peak Vout" was taken by driving the tube into clipping, as indicated on oscilloscope, and measuring the RMS output voltage at that point. This measurement gives some indication of the tube's peak emission capability.

Old Stock Versions (no longer in production)

Type	# of samples	Peak Vout	Distortion %
Mull Type 1	3	15.2	.553
Mull Type 2	6	15.3	.665
Mull Type 3	11	15.2	.639
Sylv 6CA7/STR	16	14.4	.613
GE 6CA7/STR	6	14.8	.623
Telef 50s metal	2	14.5	.515
Telef late prod	6	14.3	.528
Siem Late prod	3	15.0	.640
Amp/GE 1961	2	16.0	.635
Amp/Japan 70s	1	14.5	.720
Tungsram 70s	2	14.0	.670
Tungsram 80s	8	14.8	.693
Tesla 80s EL34	7	14.7	.624
Tesla 80s E34L	4	14.1	.630
Shuguang 1980s	3	15.7	.643
Genx KT77 70s	3	14.5	.503

Recent Production EL34s (1990s)

JJ EL34 90s	2	16.0	.550
JJ E34L 90s	2	16.0	.650
Shuguang EL34G	3	15.0	.650
Sovtek EL34G	5	14.7	.659
Sovtek fat EL34	3	15.2	.623
Svetlana EL34	8	15.1	.645

Summary

This is quite a severe test, but virtually all of the older tubes handled it without showing any hot spots on their anodes or screens (except for three: a Type III Mullard that had plate overheating; a 1970s Japanese Amperex that showed red-hot screen wires in two places; and an Amperex/Mullard Bugle Boy of 1960s vintage that went bad due to loose elements. All of those were used).

Current production is a different story. One of the Sovtek 6CA7s, two of the Sovtek EL34Gs, two Svetlanas, and two of the current Shuguangs had serious hot spots on their screens (visible through the slots in the plate). All of these tubes were new out of the box. For pentode connection, this is unacceptable. Guitar amps are very hard on EL34 screen grids; when the amp is driven into clipping,

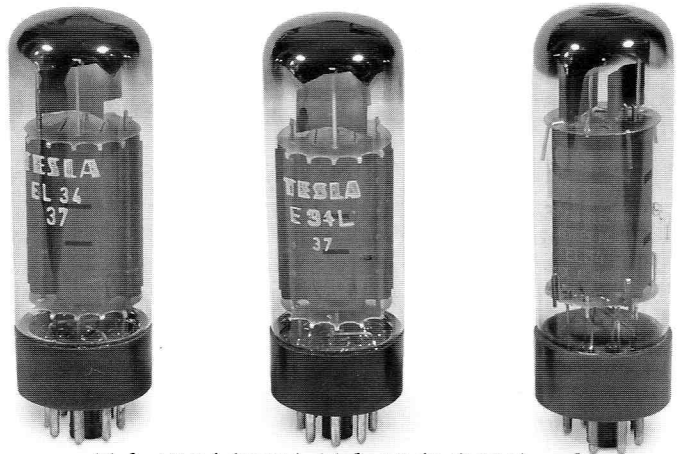

Tesla EL34 (1991), Tesla E34L (1991) and Svetlana EL34 (1999)

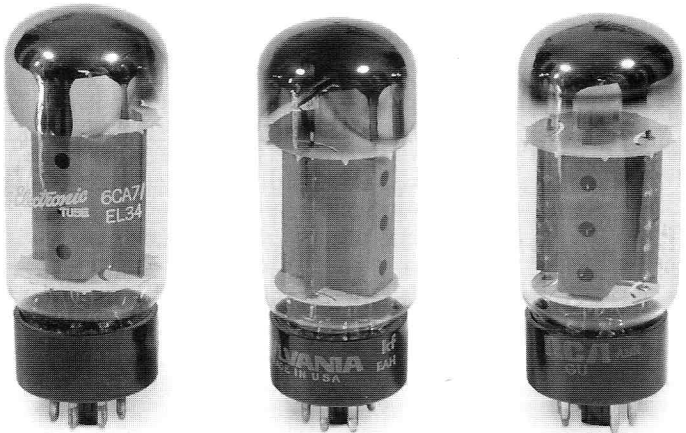

GE 6CA7 Large Bottle (1980s), Sylvania Large Bottle (1980s) and RCA (Actually a Sylvania) 6CA7 (1970s)

the screen draws a lot of current. If the screen doesn't run cool when idling, there will be trouble at full power.

Look closely at the distortion figures. Note that in general, the early EL34s had distortion of less than 0.6%, while later tubes were more than 0.6%. This is yet another piece of evidence for my thesis that overall quality control at tube factories declined after 1960. Tube dealers who are selling new production, and claiming its superiority over 1950s NOS, are probably full of it.

Exit

Our most sincere thanks must go to Alan Blake and Philip Taylor of the UK, Kevin Deal of www.upscale-audio.com, and Brendan Biever of www.tubeworld.com for providing EL34 information that would otherwise be forgotten. All tube audio users owe these gentlemen a tremendous debt. Also, thanks to Ludwell Sibley and Tube Collector magazine for publishing Alan's Philips date-code chart in their June 2000 issue.

Interconnects in Review

By David Bardes ©2001 All Rights Reserved

In issue 26 of The Audio Critic, Editor In Chief, Peter Aczel, claims the audio cable industry is fraudulent and that all the cables made by these manufacturers are without sonic merit. Mr. Aczel goes on to say that the improvement in sound claimed by manufacturer and music lover alike have been disproved again and again in controlled tests. I'm curious, does this mean Mr. Aczel is using molded interconnects and lamp cord in his mega-dollar reference system?

Fortunately, the audio community is large enough to encompass more than one point of view. Indeed, our direct experience shows that speaker cable, interconnects, and (yes) even power cords can impact the sound of your audio system. Further, the cable manufacturers that I met during this review, seemed to be honest audiophiles who truly believe that they are providing a quality product, with profit margins that are in line for small boutique businesses. Most of the cables in our review were hand assembled.

Good News

We gathered 9 one-meter interconnects from 3 different manufacturers, ranging in price from \$65 to \$240, and put them through their paces. We are very pleased to report that all of them sounded so much better than the molded cables we compared them to. The veiled, smeary, dynamically challenged sound of the molded cables was a sharp contrast to the cables in our review.

We also found differences between the cables that we tested, and in general terms the more expensive cables sounded better than the less expensive cables. If there is a point of diminishing returns we did not reach it with the most expensive cables we tested, but certainly one can spend more on interconnects than in our small sampling of cables.

Careful Listening

With the help of Ed Billeci, tube amp builder and critical listener, I auditioned all the cables in our group in my system. All the cables were broken in with twenty hours of music. We carefully followed directional arrows when they were provided. Using the cables under test, we connected my CD player straight into my amp so only one set of interconnects were involved.

We used the Kimber Kable PBJ's as the starting point since that is probably the best known cable in our price group. The PBJ has been around a long time and it's a known commodity. We then listened to the other cables switching manufacturers randomly and generally starting with the least expensive cables and saving the most expensive for last. Where there was a question, or where we thought two cables sounded similar, we listened again. We

occasionally went back to the PBJ's to check our reference point. Lastly we compared contenders for our favorite cables.

The differences we heard between the cables involved dynamics, soundstage, and a sense of openness and air. We did notice some differences in frequency extension and tonal balance, but they were more subtle.

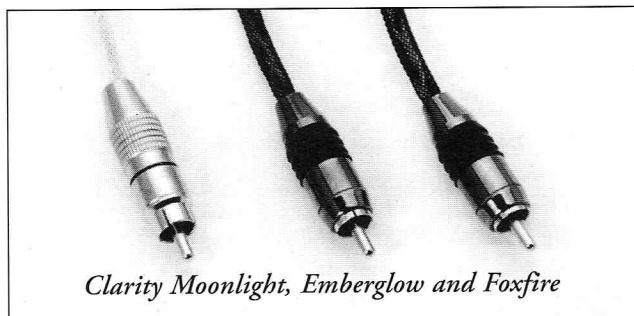

Clarity Moonlight, Emberglow and Foxfire

Clarity Wires Cables

Clarity Wire cables have a semi-opaque braided jacket which reveals the braided cables within, much like the cables from Kimber Kable. The Moonlight uses a stranded positive wire and the Emberglow a solid core positive wire. In the Firefox the positive strand is a solid core silver wire with stranded copper ground and drain.

Clarity Wires Moonlight - \$79

This cable seemed tilted towards the treble and sounded bright and edgy in our system. Perhaps a match for some vintage systems where treble detail is needed. We also noted a wide but shallow soundstage.

Clarity Wires Emberglow - \$85

This cable exhibited a bright lively sound with good pace and tempo. This cable seemed to cast a spotlight on the upper middle frequencies which may enhance its 'live' sound.

Clarity Wires Foxfire - \$199

This cable was smooth and liquid with a sweet, open, and airy sound. It had lots of detail and presence and great pace and tempo to boot.

Kimber Kable Cables

Kimber Kable cables use variable gauge OFC wire in a braid pattern we've all come to associate with the name Kimber Kable. The PBJ is their entry level cable with the Hero and Silverstreak placed at higher price points. The Hero and the Silverstreak use WBT lockdown RCA connectors, and the Silverstreak uses a silver variable gauge positive wire.

Kimber Kable PBJ - \$84

A smooth and dynamic cable that is well balanced and free of any nasties. More expensive cables in our review had more air and perhaps a bit more detail, but this cable is a great performer.



Kimber PBJ, Hero and Silver Streak

Kimber Kable Hero - \$150

This cable has great detail and frequency extension. Its open sound is a bit brighter than others, but not in an irritating way. Another excellent cable.

Kimber Kable Silverstreak - \$240

Better tonal balance than the Hero, the Silverstreak is sweet and open sounding with a great soundstage. The Silverstreak is all that the Hero is and just a bit more, with the extra detail and soundstage that the silver conductor provides.

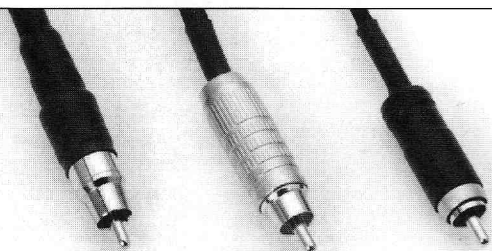

TEK LINE TL-2000, TL-420 and TL-600

TEK LINE Cables

Tek Line cables all have a black braid on the outside which keeps the construction a mystery. It looks like fairly fine gauge wire was placed inside a polyethylene(?) tube which is then covered with the braided jacket. Some of the models have some form of shielding (such as the silver cable which was not included in this review), but apparently some form of special grounding was employed in all their cables.

TEK LINE TL-2000 - \$65

This is a smooth and liquid sounding cable, with a solid, deep and specific soundstage. The tempo, transparency, and dynamics were also on the mark. At this price point, this cable is an outstanding value!

TEK LINE TL-420 - \$119

This cable has noticeably deeper bass extension than most others in our review. It was involving and well balanced with a strong dynamic punch. Possessing a wider soundstage and seemingly more neutral tonally, we felt it was a stronger performer than the more expensive TL-600.

TEK LINE TL-600 - \$189

Again, deep bass extension, smooth and liquid sounding

with good dynamics and tempo. While the soundstage is quite deep, it is a bit narrower as well. The treble has a dark quality to it that defies description, but is not really a detriment; it is just darker where some cables are brighter.

Our Favorites

Before I get to our favorites, please keep in mind that our results are influenced by our choice of amps and speakers and the preferences and limitations of the reviewers. What sounded lively and involving in our review and in our system may sound different in yours. With that in mind....

Ed and I both liked the silver cables over the copper cables and the **Clarity Foxfire** was our mutual first choice. No other cable in our review had the presence and well, clarity, that the Foxfire possessed, although the **Kimber Silverstreak** was close. For the copper cables, we liked **Kable PBJ** and the **TL-2000** by Tek Line. Both are well balanced, dynamic and involving. At \$65 the TL-2000 is a heck of a bargain. For a couple of bucks more the PBJ's are just a bit richer sounding. The **Tek Line TL-420** is also worth mentioning. At just over a hundred bucks, it offers up some solid performance at a great price point.

Take our advice and spend a few extra dollars and get one of the cables we reviewed for a great improvement in the music coming from your system.

Test System Components:

Jolida JD-603 CD player with Mullard CV4004 tubes in the analog output section. Assemblage 300 SET, single-ended 300B amp with Valve Art 300Bs and their Signature parts upgrade and volume pot. Klipsch, Klipschorn speakers with EV T-35B tweeters, JBL D130-A woofers and an upgraded crossover. Internal speaker wiring and speaker cables are home-brew fine wire cables using 30 awg silver coated copper wire in a kynar jacket. The speakers are bi-wired with an additional cable run to the woofers.

Our thanks to the cable makers who participated in this review:

Clarity Wires

Distributed by Response Audio (607) 785-3440

1011 Catherine Avenue

Endicott, New York 13760

Kimber Kable

www.kimber.com, (801) 621-5530

2752 South 1900 West

Ogden, Utah 844001

Tek Line

www.teklineaudio.com, (888) 9-TekLine

P.O. Box 598

Harbor City, CA 90710-0598

Special thanks to Ed Billeci of Portland, Oregon for his great help in the cable evaluation.

David can be reached at Bardes@earthlink.net

The Hagerman Vacu Trace Curve Tracer

A Review by John Atwood ©2001 All Rights Reserved

The characteristic curves of a vacuum tube, such as those seen in tube databooks, can provide nearly all the behavior of a tube needed to design a circuit. The curves can also show the defects, such as nonlinearity, that are difficult to discover with conventional tube testers. Where matched-tubes are needed, matching curves ensure a good match over all operating conditions. The benefits of curve tracing are further explained in my article, "Screening Vacuum Tubes," in issue 1 of VTV, page 9.

The main problem in curve-tracing vacuum tubes is the lack of affordable tracers. The Tektronix 570 curve tracer is very rare, and sells for thousands of dollars, if available at all. Audiomatica (Italy) made a good computer-controlled curve tracer, but it cost \$4000, and is no longer available. Now Hagerman Technology has brought out the "Vacu Trace," which connects to a conventional oscilloscope, for only \$999. It is fully analog and generates a display nearly identical to that of a Tektronix 570. In addition to the trace capability, there is a 3 1/2 digit digital meter that displays operating voltages, transconductance (gm), and output conductance (gp, equal to 1/rp). Mu can be easily calculated from the equation $\mu = gm/rp$. An analog tracer of this type does not have the storage and print-out of computer-controlled types, but at its price, it offers a lot of capabilities.

The Vacu Trace comes with a set of adapter boards that allow testing of: pairs of 6L6-pinout tubes (covering most audio power tubes), octal and noval dual triodes (e.g.

6SN7GT and 12AU7/6DJ8), power tubes (5V rectifier and a single 2A3/300B triode), and a blank board with two octal and two noval sockets for accommodating other types. It also comes with a power cord and three BNC-to-BNC coaxial cables for the oscilloscope connection.

The oscilloscope needed for displaying the curves must run in its "X-Y" mode with a sensitivity down to 0.1V/division. There is a Z-axis (intensity) connection which is used to create dotted lines in the A/B comparison mode. It is rated as a "TTL signal level" (0-5V), which is the standard on modern solid-state scopes. It was found that this signal also worked on older scopes that provide access to the CRT cathode. The high-frequency requirements are modest and should be accommodated by virtually any scope. However, DC-coupled vertical and horizontal amplifiers should be used, thus ruling out the old AC-coupled TV serviceman's scopes.

The Vacu Trace itself is solidly built with wood side-panels and a rugged powder-coated panel. The controls are clearly marked; however, some serve dual purposes, depending on whether curve-tracing or meter measurements are being done. There are no calibration marks on the front panel - you must make sure your oscilloscope is accurately calibrated, since it is the only indicator of currents or voltages in the curve tracer mode. In the measurement mode, the digital panel meter is used to accurately set the operating conditions. The design is conservative - a pair of 6L6s were left tracing at full power all night and the cabinet was only mildly warm the next day.

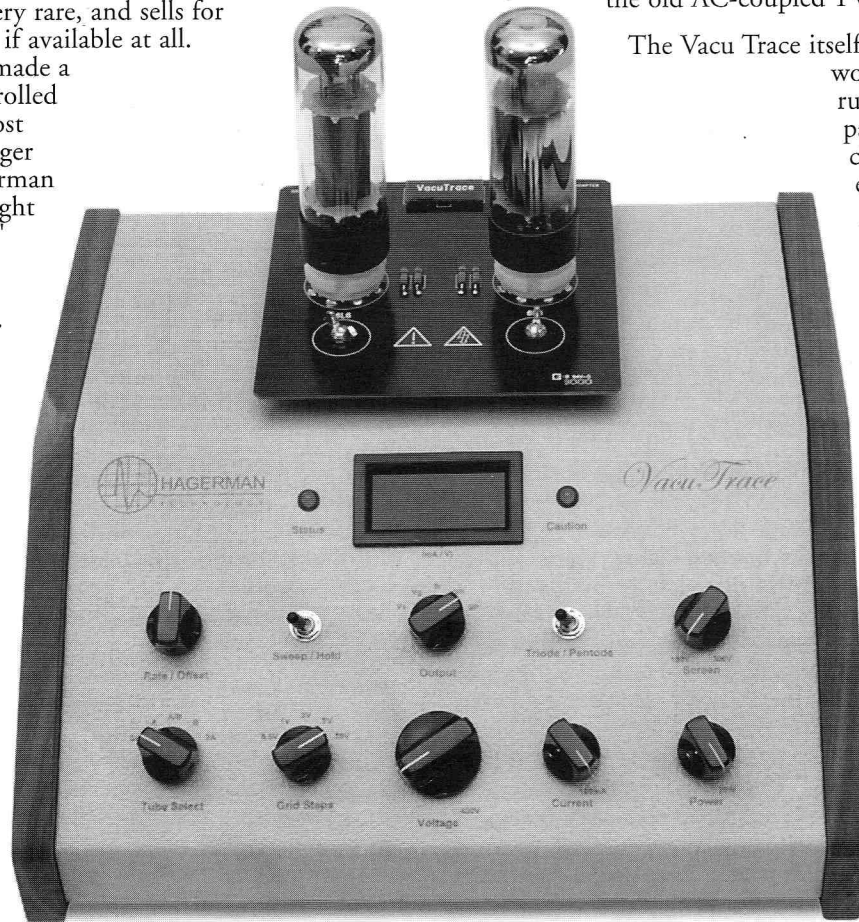

Hagerman Vacu Trace Curve Tracer

The 29-page user's manual is professionally laid-out and clearly covers set-up and operation. It assumes, however, you know how to interpret the curves.

Nearly half the manual contains the full set of schematics, unusual for equipment of this complexity and cost. Examination of the schematics shows clever analog circuit design and plenty of protection circuits. Going to www.hagtech.com gives even more information, including a comprehensive and honest FAQ (Frequently Asked Questions).

The manufacturer's performance specifications are:

Plate Voltage: 0V to 380V @ 200mA

Cathode Current: 0mA to 100mA (200mA in "2A" mode)

Grid Step Sizes: 0.5V, 1V, 2V, 5V, 10V with 8 steps @ 5mA

Plate Power: 20W peak, 40W in "2A" mode

Screen Voltage: 100V to 300V @ 10mA

Transconductance: 0.1mA/V to 20mA/V (100 μ mhos to 20,000 μ mhos)

Output Conductance: 0.001mA/V to 2mA/V (1Meg to 500 ohms)

Basic Accuracy: 2% voltage and current, 5% conductance

Heater Supplies: 6.3V @ 5A, 5.0V @ 3A

For purposes of comparison, the Tek 570 is rated at 0 to 500V @ 1A for its plate supply, has up to 13 grid steps, and has many more operating modes. However, its accuracy is 3% for the voltages it generates and 3% for its display. Thus the Vacu Trace is a somewhat more modest tester than the 570, although a bit more accurate. The accuracy of the scope used with the Vacu Trace needs to be accounted for, though. A limit of 380V and 200mA will not push power tubes throughout the full range they operate at within an amp. However, it is enough to generate valid curves for purposes of design and matching.

In the "normal" mode, two tubes can be swept at the same time. There is a 20 ohm resistor in the cathode of each tube which is used to measure the current through the tube. To measure high currents (up to 200mA), the Vacu Trace can be switched into its "2A" mode, where the two resistors are paralleled, giving 10 ohms, and doubling the vertical current scale. One tube can be swept at a time in this mode. For pentodes, cathode current is not really the same as plate current, since the screen current is included. This does not seriously compromise measurements, especially in the operating regions where tubes are used for audio amplifiers. The cathode resistor causes a small amount of degeneration, which only becomes noticeable when sweeping the transfer function curves for high power tubes.

When testing tubes, it is important to be able to limit the voltage and power applied to the tube, both to protect the tube, and to protect the tester in case a short-circuit develops in the tube. In addition to front-panel controls that vary the voltage and current to the tube, the Vacu

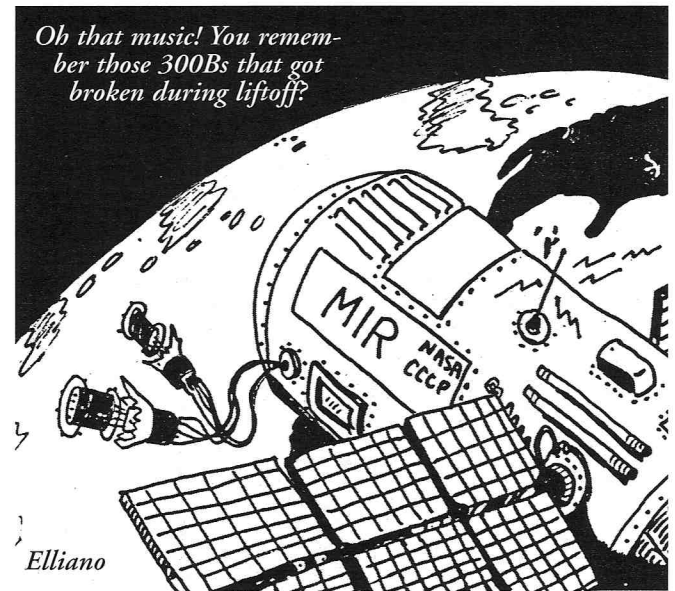

Trace is unique in having a power limit control. When displaying a set of curves, if the power limit is cranked down, a nice hyperbolic divot is taken out of the curves, showing that it is correctly calculating the maximum permissible power at all points of the curve. A downside of these limiting circuits is that it is not always obvious when they are coming into play, so you often find you need to twiddle all three controls to make sure you are getting the reading you expect.

A yellow "Caution" LED lights up when high voltages are present at the tube sockets. However, the base of the sockets are exposed, and if you try, you can touch high voltages. As a result, this should not be used around children or irresponsible people. It is hard to get shocked without trying, but the danger is still present.

The most commonly-used curves are the plate characteristic curves, which plot plate current vs plate voltage for a series of negative grid voltages, starting at 0 volts. An example of these curves for an old General Electric 6L6G in pentode mode is shown in fig. 1. (page 26) For comparison, the same tube pentode mode using the Tek 570 curve tracer is shown in fig. 2. The main difference between the curves is at low plate voltage and at low plate current. The minimum plate voltage for the Vacu-Trace stops at about 8 volts, at idle, but goes to zero while sweeping. The slight dip in the lower left corner of the 570 curves shows the effect of increasing screen current robbing some of the plate current.

In the Vacu Trace curves, these dips don't show up, because the cathode current (which includes the screen current) is what is being measured. The behavior of pentodes is more accurately reflected in the 570 curves. The oscilloscope used with the Vacu Trace for these tests was a Tektronix 502 in its X-Y mode.

Hooking a scope and DVM up to the pins of the tube being traced showed that the applied voltages closely match their specs. The built-in DVM was quite accurate - better than 0.4%. The screen voltage is regulated to with

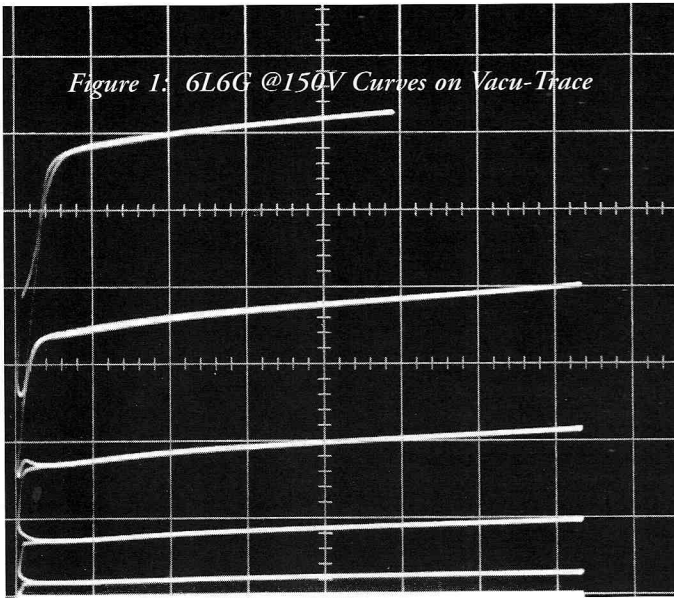

Figure 1: 6L6G @150V Curves on Vacu-Trace

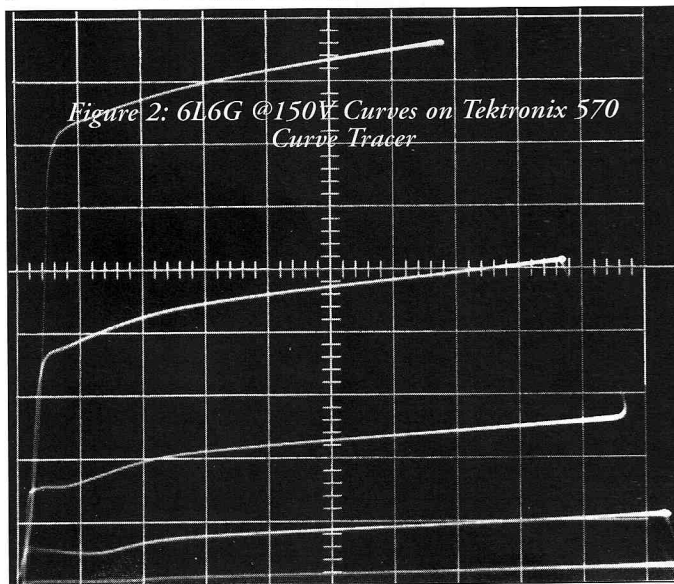

Figure 2: 6L6G @150V Curves on Tektronix 570 Curve Tracer

in 2 volts. The filament supply is unregulated, and runs a little high. With no tube plugged in, the filament voltage was 6.95 Vrms, with a single 6550, the voltage dropped to 6.70Vrms, and with two 6550s, the voltage was 6.50 Vrms. All voltages were measured with a line voltage of exactly 120V. The lack of regulation can make repeatable measurements difficult if there are voltage changes. If this is a problem, use a Sola or other ferro-resonant regulating transformer in the power line.

While testing the accuracy of the Vacu Trace, some discrepancies were noted in the display, visible as the plate current differences between Tek 570 and Vacu-Trace curves of the 6L6G. Doing some accurate measurements showed that the cathode current was 12.5mA/division, not the 10mA/division stated in the manual. Similarly, the grid voltage was actually 10V/div, not the 12.5V/div specified in the manual. Checking in with Jim Hagerman confirmed that there was an error in deriving the cathode current and

grid voltage specs from the actual design. All new manuals will have the correct readings specified.

For a complex instrument like the Vacu Trace, there are many parameters and features to consider when considering a purchase. Some of the important pros and cons I've discovered should help you make a decision.

First the cons:

- * The maximum plate voltage and current are a bit limited.
- * Cathode current, not plate current, is measured.
- * Unregulated filament voltage.
- * Only common audio tubes testable without making custom adapter boards.
- * Needs a decent oscilloscope.

Now the pros:

- * The accuracy of the instrument is good.
- * Well-designed and "bullet-proof."
- * Built-in meter facilitates measuring and matching tubes.
- * Handy A-B comparison mode.
- * Tube curves can often be very revealing.
- * The price is very good for what you get.

On the whole, I would recommend the Vacu-Trace for those who are seriously into testing their tubes, musical instrument, or hi-fi repair shops that need to accurately match tubes, or tube dealers that want to give their tubes a good screening. The only places I would not recommend it would be standards labs or other places where the utmost in performance is needed. Otherwise, it gives excellent value for the money, and allows far more detailed measurements than available with conventional tube testers or tube matchers.

Hagerman Technology also offers the Vacu Trace as a kit. Not having built the kit, I can't make a firm recommendation, but given the complexity of the circuitry, only those who are comfortable in reading and understanding schematics should even consider building the kit. This concern is not about ease of construction, but how well you can debug it if something goes wrong.

Vacu Trace Curve Tracer, price US\$999, US\$899 in kit form. Available from:

Hagerman Technology LLC, P.O. Box 26437, Honolulu, Hawaii 96825 USA tel: 1-808-383-2704 fax: 1-808-394-6076

<http://www.hagtech.com>

International Audio Group's 4.5SE Review

A Review by David Bardes ©2001 All Rights Reserved

When the International Audio Group (IAG) 4.5 SE amp arrived we were all pleasantly surprised. It certainly looked like an SE EL84 amp, but we were not expecting anything more than a plain black Bud box, especially at a low \$599. What a treat it was to see this curvy polished aluminum chassis emerge out of the shipping carton. We quickly inserted the supplied tubes, plugged the amp into the nearest tube audio system and turned it on. Sure enough, real music came through the speakers!

First impressions are important, so amp designer Horace Atkinson avoided designing the 4.5SE to look like yet another budget tube amp. This model is also designed for quality sound. True tube rectification is provided via a 6CA4, while the EL84s are triode wired for a sweeter sound. Two EF86 driver tubes round out the amp's tube compliment. Nestled beneath the chassis are Sowter output transformers and a toroidal power transformer. The point-to-point wiring is nicely arranged on a turret board designed for this amp. Gold plated speaker binding posts and RCA

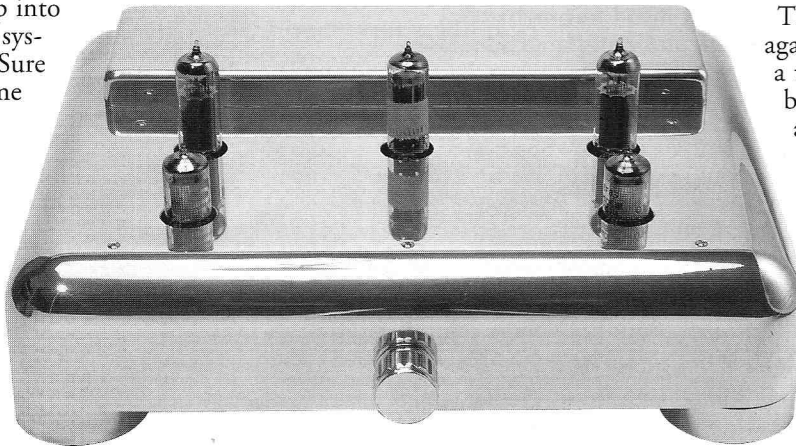

jacks populate the back, and a volume control pot adorns the front. The power switch is part of the IEC power plug assembly on the back.

In my system and driving those huge and efficient Klipschorns, the 4.5 SE had a smooth, balanced and accurate sound. All the music I played through the amp was lively and involving. There was no evidence of graininess or hash in the treble. We observed a stable and specific sound stage with a nice three-dimensional image. Overall presentation was not as huge as some other SE triode amps we have sampled, but it was certainly pleasing and musical.

The only grievance I had against the sound quality was a tiny bit of hum audible between music selections, and then only when playing through my K-Horns (104dB efficiency).

I did try this 3-watt-per-channel amp on some bookshelf speakers with good results at low to moderate volume levels. The 4.5 SE would be a good match for a small office or den system if the

speakers aren't too greedy, but this amp will soon run out of steam if you crank it up with inefficient speakers.

The AIG 4.5 SE is available as kit for \$599. The assembled and tested version is \$749. No assembly documentation was included with our amp, so I can't tell you how clear and complete they are, but the turret board is well laid out and there is plenty of room for easy soldering - a real plus for the kit version. And if polished aluminum is not colorful enough for you, the chassis can be powder coated on special order.

So what we have here is a great sounding amp that looks like no other. Styling is beautiful and your wife or significant other will admire it! Available as a kit or pre-assembled, the IAG is a one-of-a-kind amp at a bargain price.

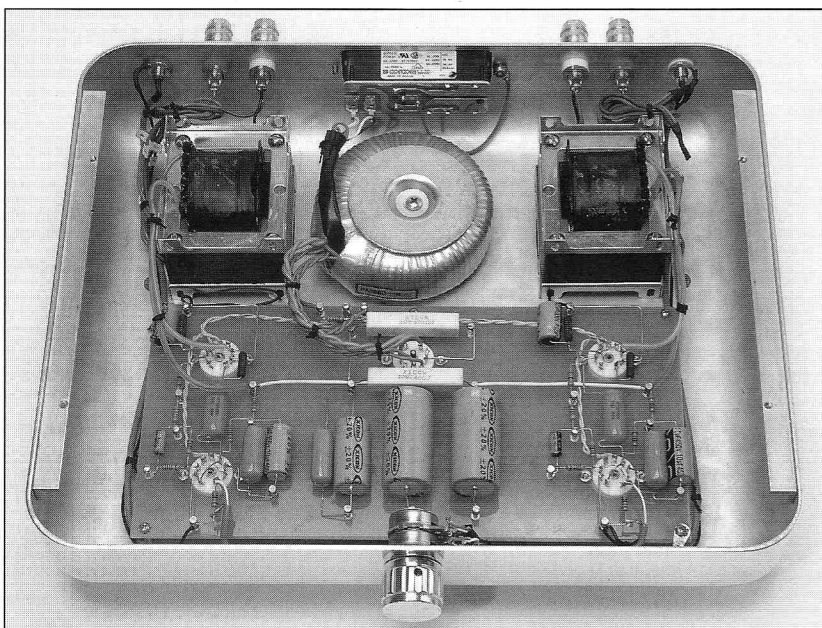

International Audio Group
4305 Brookside Drive
Killeen Texas, 76542
(254) 699-8702
hiag@dashlink.com

Tube Headphone Amplifier Project

By John Dickman ©2001 All Rights Reserved

This is a project that stemmed from the saying "is it loud enough? I can't hear the TV!" This happens to almost every audio nut unless he/she is single and doesn't have tenants.

I was in the market for a headphone amplifier for reasons we all have, so I traveled the local high-end stores to sample some head gear. During some of my stops, I purchased a set of Grado SR80 because I heard so much about them. I listened to all types of music through the Grados and loved them. The sound was realistic and just what the doctor ordered.

The search continued for the headphone amp. I got around to sampling about 4 or 5 amps and really liked three of them. However, they were way out of my price range. So I decided to build one myself.

I don't have an electrical engineering degree, but I do have a lot of background in audio and tube gear. So I was capable of researching circuits, building the unit, and tuning it to sound the best. Some of the commercial headphone amplifiers use small signal tubes like the 12AX7 and the 6DJ8. I was instructed by Eric Barbour that I should use meaty triodes like the 6SN7 instead of "pencil-neck geek" tubes.

I did my first trial circuit using an NOS 6SN7GTB as an OTL circuit. I powered it and wired the grids to the output of a preamp I built using Diego Nardi's bonus preamp schematic in Sound Practices Issue 14. This is a great sounding preamp using 6SN7s in an SRPP configuration.

When I connected everything and warmed up the tubes, I sampled some music and found there was a lack of presence and low frequency. I tried another tube with the same results. I noticed that the plate resistances were low so I tried a lower plate resistance triode, the 6BX7. This tube gave me a bit more bass, but was still lacking in presence.

About six months had passed, and I was still itching for a headphone amp. Nothing I tried gave me what I wanted. I studied circuits and tube manuals and the Antique Electronics Supply Catalog. I glanced at the transformer page and saw some universal tap output transformers made by Hammond and decided to try them.

I chose the Hammond model 125As rated at three watts. When they finally arrived, I inserted them in the circuit. It was basically like building a single-ended amp with the grids of the 6BX7 still in the output of the preamp. Warming everything up, I could hear the tubes clinking as the cathodes and plates heated in the 6BX7. Then it was time, so I sent a musical signal through-and it was sweet. There was a little hum, but that was wiring layout causing a ground loop.

The sound was improving, so I played with the transformer taps and found the right configuration, then listened to it with all types of music. There was the right amount of bass balance and the highs were crystal clear with the right touch of mids. I was on the road, so I tried a 6080 tube with a lower plate resistance. It sounded fine, but the output transformers heated up too fast.

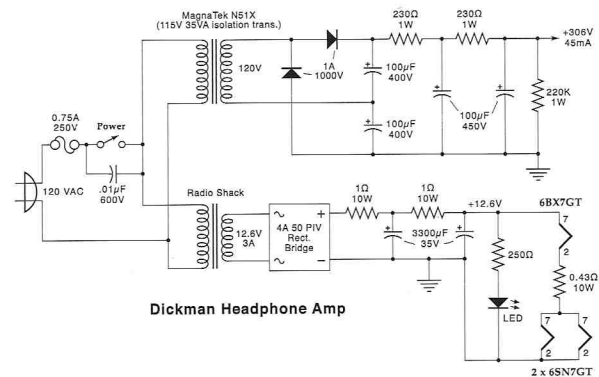
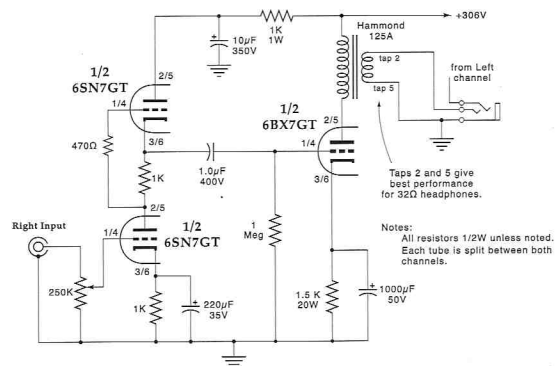
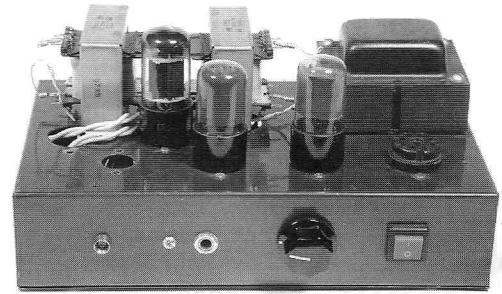

So back to the 6BX7, I decided on a circuit and built the output stage, then the driver stage. I tried various 9-pin miniature dual triodes, but could not find a good combination that gave me the sweet sounds of the preamp.

Listening to the headphone amp and reading the tube characteristic manual, I decided to duplicate Diego Nardi's preamp circuit into my headphone amp. After completing the driver circuit, I tweaked the power supply for minimal hum and silent operation. When the amp was completed, I let some of my friends try it and they loved it. Based upon these results, I decided to share this headphone amp with all of the DIYer's, just to keep the peace on the homestead.

John Dickman can be reached at: sdickey@aol.com

EL34 Shootout for Hi Fi

By Charlie Kittleson ©2001 All Rights Reserved

Introduction

EL34s are a popular valve for hi fi tube amplifiers, both vintage and modern. This tube is considered musical and sweet, especially in the midrange. Many tube enthusiasts favor the EL34 over both the 6L6 and the 6550 because of the midrange warmth. EL34s were used in many vintage amps including those from Acrosound, Altec, Dynaco, EICO, Fisher, Heathkit, Leak, Marantz, Pilot and H.H. Scott. They are also used in countless tube amps of recent and current manufacture.

The standard of quality by which all EL34s are judged is the venerable Mullard. Mullards were made in several different versions from the mid-fifties through the 1970s. Other legendary vintage EL34s were produced by Philips/Holland and Telefunken during the same period. However, as with most quality vintage audio glass, the price of vintage EL34s has gone through the roof, and such prices are unlikely to decline any time soon. The exciting news is that several manufacturers are currently producing high-quality EL34s at very reasonable prices. EL34s from Ei, JJ/Tesla, Sovtek, Svetlana, Shuguang, etc. are now available from most tube vendors at sane prices.

We decided to assemble 14 of the favorite NOS vintage and contemporary EL34s and 6CA7s for a group hi-fi tube shootout. Our host of the shootout was Brian Hartzell, proprietor of The Analog Room in San Jose, California. The Analog Room is considered one of the best high-end tube audio shops in Northern California. Not only that, but Brian has a huge collection of vintage and collector LPs on display and for sale. If you are in the Silicon Valley area and in the market for some great sounds, be sure to pay the Analog Room a visit. (408) 971-6158



EL34 Shootout Crew: Eric Barbour, John Eckland, Scott Frankland, Charlie Kittleson and Serge--- with Wavestream Kinetics V-8 Amplifiers, Avalon Eidolon Speakers, Marantz Model 8 Amplifier and EL34s

Test Setup

For our test amplifier, we used a vintage 1959 Marantz Model 8 tube stereo amplifier, restored by John Eckland and Steve Parr. The line stage was an Aesthetix Calisto with a 47 Labs Flatfish CD player. Loudspeakers were Avalon Eidolon (11 inch woofer, 3.5 inch mid and 1 inch ceramic dome tweeter). The speaker cables and interconnects were Harmonic Technology - Harmonic Magic. Musical selections were as follows: Sketches of Spain by Miles Davis and Gil Evans (1958), Jane Monheit (female jazz vocalist), and Verdi's Requiem.

Listening Panel Members and Rules

Our listening panel consisted of: Scott Barnhill, Eric Barbour, Scott Frankland, John Eckland, Steve Parr, Serge Fermanian and yours truly. The Analog Room had at least five high-quality listening areas, but we needed lots of

room for our relatively large group, so we picked the biggest one. **Once again, the test was performed blind.** None of the tube reviewers knew which tube was being played. This eliminated the "favorite brand" preference effect completely. **Please remember that if you try this test at home, your results may be different.** All reviews of this nature are subjective and are based upon equipment used, room acoustics,

music played and the review group's audio experience and learning curve. Fortunately, our group was VERY experienced in listening to high quality tube audio systems.

Sonic Evaluation Criteria

We asked the reviewers to subjectively rate the EL34 sonic characteristics in the following areas: dynamic range, transparency, frequency extension, musical involvement, three-dimensionality, and pace and rhythm. See shaded box on the next page for an explanation of the above terms. The rating was from one to five with five being the highest. A special tube evaluation form was used to numerically rate each tube. Each tube was listened through with three types of music, always at the same volume.



Lab 47 Flatfish CD Player and Aesthix Callisto Line Stage

EL34 Hi-Fi Results

1. Amperex Bugle Boy Double-D Getter Brown Base 1961 - Lots of vintage OEMs used this tube in its heyday. Our listening panel found it sounding cool, dry, and smooth. Transparency was very good as were frequency extension and dimensionality. Overall rating 3.82

2. Amperex (actually a Blackburn Mullard-made Xf4) Brown Base 1966 - An excellent-sounding tube with outstanding performance in our system. Dynamic range and frequency extension were exceptional and all other categories were rated as one of the best. These are not as expensive as the more collectable Xf2 version, so get yours now while you can! Overall rating is 4.03

3. Chinese (Shuguang) 2001 - This is a new production

Terms for Subjective Tonal Evaluation of High Fidelity Vacuum Tubes

Coloration: The emphasis on a particular frequency range that is noticeable or prevalent, ie; warm, cool, bright, etc.

Dynamic Range: Sonic performance from the quietest to the loudest, including the subtle differences in microdynamics and macrodynamics.

Transparency: How far you can see (hear) through to the musical source. The lack of any veiling.

Frequency Extension: The perceived bandwidth from the lowest to the highest frequencies.

Musical Involvement: The degree that you get sucked into the music. How much the music "grabs" you.

Three dimensionality: Accurate portrayal of relative instrument placement and front to back soundstage.

Pace and Rhythm: The proper emphasis of musical syllables and phrases. Does the music make you feel like dancing?

item from China that is obviously a copy of an Xf2 Mullard. Slightly above average rating with noticeably good transparency and frequency extension. Other categories were about average. Overall rating 3.22

4. Ei Small Bottle Tipped 2001 - This design has been around for a few years and is now available again. Reviewers felt that the tube was warm and kind of dry sounding. The tube was musical sounding with some noticeable liquidity. Use this tube with caution in high plate voltage amps. It may be subject to biasing problems and potential overheating. Overall rating 3.7

5. Ei Fat Bottle Tipped 2001 - A fat version of the above, this tube looks very impressive. It looks like a smaller version of the Ei KT90. Reviewers thought the tube was a little on the harsh side with all three musical selections. Predominant tonal character was dry and warm. Overall rating 3.2

6. Genalex KT77 Gold Lion 1974 - This ultra-rare EL34 type is the most collectable of all. It is a beautiful example of British valve art. KT77s came standard in amps like the Acrosound UL120 and some British valve amps of the 1960s. The KT77 sounded very liquid and warm with an overall pleasing tonal quality. Overall rating 3.66

7. Japanese Split-top Glass 1970s - Matsushita sold EL34s that were essentially copies of Xf2 Mullards during the 1960s and 1970s. They did not have the Philips date codes and can be typically identified by the split seam in the glass on top of the tube. Amperex and RCA rebranded and sold these tubes during the 1970s. Sound characteristics were dry and cool. Overall rating 3.4

8. Mullard Xf2 Single-Halo Getter 1964 - This is the classic Mullard that was standard equipment in Dynaco, Fisher, Marantz, Scott, and many other 1960s hi-fi amps. Now highly collectable and known for its smooth, rich sound, matched pairs of Xf2 Mullard EL34s can command prices in excess of \$275US. Don't look for the price to go down either! This tube sets the standard for liquid, smooth, and warm sonics. Overall rating 3.33

9. Siemens ITT Eastern Europe Dimple-Top 1991 - A few years ago, this tube was relatively common. Now, however, it is considered an NOS tube. This tube was liked by many reviewers who thought it was cool, liquid and smooth-sounding. Overall rating 3.44

10. Sovtek EH 1999 - Sovtek has redesigned their EL34 with more rugged construction including gold-plated screen grids. This tube is definitely an improvement over the earlier version. Priced at the low end of the scale, the EH EL34 is a great buy. The tube is musical, warm and detailed, but a little on the dry side. Overall rating 3.48

11. Svetlana Brown Base 2000 - The Svetlana EL34 is now available in the US from a variety of tube dealers. This tube sounds very Mullard-like and is used in a number of high fidelity tube amps. Tonal characteristics are smooth, warm and musical. Overall rating 3.18

VTV EL34 Hi Fi Tube Performance Comparison Chart

EL34 Type	Coloration	Dynamic Range	Transparency	Frequency Extension	Musical Involvement	3 Dimensionality	Pace & Rhythm	Overall Rating
Amperex Holland 1961	Cool, Dry, Smooth	3.5	4.0	4.4	3.4	4.0	3.6	3.82
Amperex UK Xf4 1964	Dry, Warm	4.2	3.8	4.2	4.0	4.0	4.0	4.03
Chinese 2001	Harsh, Warm	3.2	3.4	3.4	3.0	3.3	3.0	3.22
Ei Small 2001	Dry, Warm	3.8	3.3	3.9	3.3	3.3	3.7	3.55
Ei Large 2001	Dry, Warm, Harsh	2.8	2.8	2.2	2.3	2.8	3.2	2.68
Genalex KT77	Liquid, Warm	3.6	3.4	3.8	3.6	3.5	3.6	3.58
Japan Split 1970s	Dry, Warm	3.6	4.2	4.2	3.8	4.0	3.4	3.77
Mullard Xf2 1964	Liquid, Smooth	3.7	3.3	3.8	3.3	3.5	3.3	3.48
Siemens Dimple 1991	Dry, Cool Smooth	3.5	3.3	4.2	3.7	2.8	3.3	3.47
Sovtek EH 2001	Dry, Warm	3.3	3.8	3.5	3.3	3.3	3.7	3.48
Svetlana 2000	Liquid, Smooth, Warm	3.2	3.3	3.3	2.8	3.2	3.3	3.18
Sylvania Fat 1970s	Cool, Liquid	4.2	3.6	3.8	3.6	3.3	3.6	3.68
Tesla 1991	Liquid, Warm	4.6	4.2	4.6	4.6	4.0	4.2	4.36
JJ/Tesla 2001	Dry, Warm, Smooth	4.0	4.0	4.0	3.8	4.0	4.0	3.97

12. Sylvania Fat Bottle Double Getter USA 1970s - A US version of the EL34, the Sylvania 6CA7 has kind of a cult following in some circles. Prices have increased significantly over the last few years. This tube has a cool and liquid sound, but at least one reviewer did not like it very much. He thought it was a little on the harsh side. Overall rating 3.68

13. Tesla Brown Base (Mullard Xf2 copy) 1991 - Out of the blue, this once common EL34 was the top performer in our EL34 test. It was obvious that Tesla used some of the original Xf2 Mullard tooling they received from Philips to make this tube. Everyone liked its musical performance above any of the other tubes. Tonal coloration was on the liquid and warm side. Dynamic range and frequency extension were both rated as excellent. I personally used a quad of these in my Dynaco Stereo 70 for years and thought they sounded great. Some NOS dealers may still have some of these in stock at reasonable prices, but don't wait too long! Overall rating 4.36 - **Top Performer**

14. JJ/Tesla Round Top 2001 - To the surprise of many, this tube performed very well. Tonal coloration was dry,

warm and very smooth. Musical and balanced-sounding were other comments from the reviewers. Across the board, this tube was liked by all reviewers. Based on our results, the JJ/Tesla EL34 is a **Best Buy EL34** for hi fi applications. Overall rating 3.97

Conclusion

The bad news is that NOS Amperex and Mullard EL34s are getting hard to find and expensive. The good news is that several tube manufacturers are producing excellent quality EL34s. Tubes from Ei, Sovtek, Svetlana and Tesla should be able to satisfy the sonic tastes of most tonal connoisseurs. The current Tesla EL34 is the clear winner in this EL34 hi-fi shootout. It can be had at bargain prices and according to our ears, can sound as good or better than many of the classic NOS EL34s. The Sovtek EH EL34 and the Ei EL34 (small bottle) are no high fidelity slouches either. There are enough good EL34s around for the near future and then some.

Special thanks to: The Analog Room in San Jose, CA, Antique Electronics Supply, Mojo Music and New Sensor Corporation.

EL34 Shootout for Guitar Amps

By Charlie Kittleson ©2001 All Rights Reserved

In the Beginning

Since the early 1960s, the EL34 output tube was used in British-made guitar amps played by the likes of Duane Allman, Eric Clapton, Jimi Hendrix, Jimmy Page, Peter Dinklage and many other rock legends. Rock and heavy metal guitar players then and now depended on Hi Watt, Marshall, Park, Randall and other "British" amplifiers to get the maximum rock tone. The "British" sound is more aggressive, has more crunch and more "in-your-face" punch than a typical Fender type amp.

Amp design, components used, speakers and guitars all contribute to musical tone characteristics. However, many musicians are under the assumption that all tubes sound the same. They couldn't be more wrong. Input and/or output tubes can make a dramatic difference in the texture, crunch, coloration, etc. of your tone. The VTV EL34 evaluation that follows reveals significant sonic differences in each EL34 tested.

How We Kept The Score

Subjectively and/or objectively rating the sound or tone of guitar amp vacuum tubes is not an exact science. Desirable tube sonic characteristics for hi-fi applications can vary dramatically from those found desirable in guitar amplification. Results can vary, based upon your reviewing criteria, tubes, amp, speakers, guitar, room, player, reviewer's preferences/ears and style of music played. If everything remains constant except the tubes used, you can get a pretty good idea of basic tonal differences.

To assist us in keeping score, we used a tube sonics evaluation form that allowed the reviewers to objectively rate each tube's tonal characteristics on a scale of 1 to 5 with 5



*Terry Buddingh and Ron Veil with
test amp and EL34s*

being the best. For our standard tube, we used a pair of Mullard XF2 EL34s and gave them a median rating of 3.0. Tubes that sounded better could be rated higher than the Mullards, and tubes that sounded worse could be rated lower, depending on each reviewer's listening impressions. The tonal characteristics we used to rate each tube were: dynamic range, crunch, break-up, punch, coloration and musicality. (See shaded box on the next page for more detail on these terms.) Reviewers were encouraged to add subjective comments to their numerical ratings, giving more depth to the evaluations.

Gear, Equipment and Stuff

We decided to use a 1995 Fender Custom Shop Stratocaster with a rosewood fingerboard and a Fralin pick-up set. We did try a G&L ASAT Telecaster, but it was a little too fat sounding for our tone rig. The Strat offered more tonal clarity and higher highs. The amp used was a Rock Expression (a modified mid-1960s Fender Bassman chassis with 50 watts output) using a solid-state rectifier and four Sovtek 12AX7LPS signal tubes. The amp had 460 volts B+ on the plates and output tube bias was set to 35mA for all the tube sets listened to. For bias adjustment setting, we used an Alessandro Dual Bias Meter. The speaker cabinet was a slant-top Marshall 4 x 12 bottom with four Celestion Vintage 30 twelve inch speakers installed. For the test, we only used two of the twelve inch speakers to get the correct impedance match.

In order to get a handle on some of the sonic variations in EL34s, we assembled a substantial array of both current production EL34s and some of the favorite NOS types. Due to rarity and lack of availability, we were not able to get all variations of vintage EL34s for the test. However, we did find many of the Amperex, Mullard, Sylvania, and Siemens types. We matched them on a Maxi-Matcher output tube matcher for plate current and transconductance.

VTV Tone Panel

We were able to assemble a great group of guitar tone freaks for this shootout who were either guitar players, amp techs and/or musical journalists. The group included Terry Buddingh (Guitar Player and Bass Player magazines), Curt Emery (Emery Sound), Phil Loarie (guitarist/toner junkie), Ron Ott (King Amps), Ron Veil (Uncle Spot), and Charlie Kittleson (VTV). Our guitarist in residence was Jeramy Norris, a talented lead guitarist who plays with The Studebaker Blues Band out of Northern California.

Gentlemen, Hit the B+!

The following list contains 15 different EL34 matched pairs we tested in alphabetical order:

1. Amperex Bugle Boy Holland 1961 - Most reviewers loved this tube. It had excellent break-up characteristics with balanced and rich coloration. The crunch was chunky and punch was a knock out. Overall musicality was kick-ass according to most of the reviewers. This tube is getting hard to find in matched pairs these days. Overall rating 3.04

2. Amperex UK Xf4 Black Base 1964 - The Xf4 series Mullard can be marked GE, Sylvania, RCA, Zenith, or whatever. These are still available at reasonable prices now. This tube had excellent dynamic range with well-controlled-focused crunch and detailed break-up. Punch was strong with airy top-end detail. Musicality was sweet and rich. This was the top-rated tube in our test. Overall rating 3.06

3. China EL34B 2001 - The EL34B tube from China is a relatively new offering. This tube will undoubtedly find its way into lots of new guitar amps due to its super-cheap cost to OEMs. Its sonics were nothing stellar, though. There was limited dynamic range with weak crunch. Break-up was kind of nasty and punch was weak. Coloration was lean, harsh, and brittle. If you have this tube in your amp, upgrade to anything in this test over a 2.5 rating and see a dramatic improvement. Overall rating 2.24

4. Ei Small Bottle Tipped 2001 - This tube has been around a while and is used as original equipment in a few current production guitar amps. Dynamic range was good and the tube was responsive. Crunch and break-up were very good and focused. Punch and coloration were impressive. Tonal balance was Mullard-like and musicality was right-on. This tube is a **VTV Best Buy** and received the highest rating for a current production EL34 in this test. Overall rating 3.06. (Note however, that this tube may not work well in amps with plate current set at over 40mA. It may overheat with more current.)

6. Ei Large Bottle Tipped 2001 - The Fat EL34 is like a junior version of the Ei KT90. Dynamic range was good, but not spectacular. Crunch, break-up, and punch were OK, but a little on the light side. Break-up tended to get a little nastier when the volume was cranked up. Coloration was sweet with good top-end clarity. Overall musicality was good at lower volumes, but not when cranked. Overall rating 2.56

7. Genalex KT77 Gold Lion 1970s - This is the rarest of all the EL34 types in the test. Dynamic range is good, but



l to r: Jeramy Norris, Terry Buddingh, Ron Ott, Charlie Kittleson, Phil Loarie and Kurt Emery

its crunch lacked some lows and control. Break-up was slightly grungy and loose. Coloration was on the thin side and lacking bottom. Better save your money and let the hi-fi guys have these. Overall rating 2.4

8. Mullard Xf1 UK Wide Base 1957 - This is another rare NOS EL34 that is not getting cheaper. Dynamic range was only average with average crunch, compared to the Xf2. Break-up was dirtier and more unbalanced than the Xf2. Coloration was a little on the lean side. Probably not worth the money, save your cash and go after the Xf2s if you have to have Mullards. Overall rating 2.36

9. Mullard Xf2 UK 1964 - The "standard" tube by which all EL34s are currently judged-by performed very well in this test. Dynamic range was good. Break-up, crunch, and punch were all desirable. The tube had balanced, powerful distortion with rich coloration. Overall musicality was excellent. Overall rating 3.0 (standard)

10. Siemens East German (Ruby) 1991 - This is another glow bottle that may be available from some NOS dealers in limited quantities. Dynamic range was limited and crunch was not exceptional. Break-up was a little on the dirty and grungy side. This was a LOUD tube and it had above average punch. Musicality was primarily above average at lower, cleaner volumes. However, at higher volumes, it became less musical. Overall rating 2.7

11. Sovtek EH 2001 - Sovtek has improved their new EH EL34 significantly over their previous EL34. It now has better materials including a gold-plated screen grid. The EH had nice, effortless dynamic range. Crunch and punch were focused and strong. Break-up was articulate and strong (Stevie Ray Vaughan worthy). Coloration was bright, light, sweet, and warm with good balance. EH musicality was Mullard-like; detailed, nice and pleasant. This is a great-sounding guitar amp tube. The EH EL34 is a **VTV Best Buy**. Overall rating 2.94

12. Svetlana 2000 - The Svetlana EL34 was one of the first of the late 1990s Mullard copies to re-surface. This is

Subjective Tonal Terminology for Guitar Amp Vacuum Tubes

Break-Up: Musical distortion characteristics of the tube when overdriven.

Crunch: Midrange crispness, complexity, and presence.

Dynamic Range: How much clean headroom is there before the tube breaks up.

Musicality: Overall pleasing tonal qualities. How musical is the tube?

Punch: How well the tube goes from no signal to a loud signal. Clean power characteristics..

Tonal Coloration: Noticeable tonal characteristics: cool, dry, liquid, sweet, warm, etc.

VTV EL34 Guitar Amp Performance Comparison Chart

EL34 Type	Coloration	Dynamic Range	Break-up	Crunch	Punch	Musicality	Overall Rating
Amperex Holland 1961	Balanced, Rich Warm	2.9	3.1	2.7	3	3.5	3.04
Amperex UK Xf4 1964	Airy Top-End, Sweet and Warm	3.3	3.1	3.1	2.9	2.9	3.06
China EL34B 2001	Grungy, Rolled-off Highs	2.3	2.2	2.4	2.1	2.2	2.24
Ei Small 2001	Impressive, Mullard-Like Powerful	3	3.1	3	3.3	2.9	3.06
Ei Large 2001	Clear, Silky, Sweet	2.6	2.7	2.5	2.5	2.5	2.56
Genalex KT77	Balanced and Warm	2.6	2.1	2.6	2.6	2.1	2.4
Mullard Xf1 Wide Base 1957	Lean, Balanced	2.1	2.1	2.4	2.7	2.5	2.36
Mullard Xf2 1964	Balanced, Rich Distortion, Sweet	3	3	3	3	3	3
Siemens E German (Ruby)	Balanced, Clean, Sweet	3.1	2.4	2.4	2.9	2.7	2.7
Sovtek EH 2001	Bright, Light and Warm	2.9	3	3.1	2.8	2.9	2.94
Svetlana 2001	Lean, Liquid, Balanced	2.6	2.7	2.7	2.8	2.5	2.66
Sylvania Fat 1970s	Lean, Lacking Mids	2.3	1.9	2	1.9	2.2	2.06
Tesla 1991	Rich, Sweet and Warm	2.9	3.2	2.8	2.9	2.8	2.92
JJ/Tesla 2001	Bright, Crispy and Rich	2.8	2.9	2.8	3	3.1	2.92

a well-made tube that is now available from a variety of dealers. Dynamic range was good, but slightly on the thin side. It had nice crunch, but breakup was a little ice picky when driven hard. Some reviewers did not care for the Svetlana's break-up, calling it harsh. Punch was better than average and coloration was clean and balanced. Musicality was complex, percussive and responsive. Actually, the Svetlana is an above average tube, but a few other current production EL34s fared better in this test. Overall rating 2.66

13. Sylvania 6CA7 Fat Bottle 1970s - This was the US version of the EL34 made from the 1970s into the 1980s. Now getting hard to find in matched pairs or quads, this tube has its own group of core enthusiasts. Dynamic range was nothing special and crunch was a little loose. Break-up was a little dirty, and punch was OK, but far from excellent. Coloration was brittle, harsh and lean. Musicality was marginal. Overall rating 2.06 (lowest in test)

14. Tesla Brown Base 1991 - This tube is obviously a direct copy of the Mullard Xf2 design. They were quite plentiful in the 1980s to mid 1990s era. This is a very good design with excellent cathode emission and internal materials. Do not confuse these with the Teslas that came out in the late 1990s and were not as good in terms of quality and sonics. This tube has assertive punch with

good dynamic range. Crunch was strong and powerful with controlled break-up. Coloration was sweet, rich, and warm. In summary, this bottle sounded excellent. Overall rating 2.92.

15. JJ/Tesla Round Top 2001 - This is the new JJ/Tesla design that has a round glass top. Quality and sonics are much better than they were a few years ago with this tube. Sound quality featured strong mids with a nice sparkle on the top. The tube had good balance with a great bottom end. It also had excellent crunch, knock-out punch, and ballsy distortion. Musicality was rated as excellent. This is a current-production EL34 available from most tube dealers and is considered a **VTV Best Buy**. Overall rating 2.92

Conclusion

Our favorite NOS EL34s were the Amperex and Mullard Xf2s because of their balanced, complex, and rich tones. Our favorite new production EL34s were the Ei (small bottle), JJ/Tesla, and Sovtek EH for their crunch, power, and richness. For the money, the new EL34s are an excellent buy and highly recommended for most applications. If you must have NOS EL34s, don't wait too long as the supply is diminishing rapidly.

Special Thanks to CE Distribution, Mojo Music, Sovtek and especially Ron Ott of King Amps for hosting the event at his house.

Moth Audio Corporation

Introducing The New

si2A3

Same Great Sound as the s2A3
But now with 3 Input Selector Switch

Only **\$1695.00**



323 HOllywood 7-4300

Call now or visit us on the web at www.mothaudio.com

Fi-Sonik™

Parallel-Feed Single-Ended
Output Transformers

*Exquisitely hand-crafted . . .
only thirty pairs made per year.*

Available in:

- 3K to 8 Ohm, 8 Watt
- 3K to 16 Ohm, 8 Watt
- 5K to 8 Ohm, 8 Watt
- 5K to 16 Ohm, 8 Watt

with either SuperPerm 49 Nickel Alloy or
Amorphous Iron (Metglas®) core.

write, call, fax, or email for catalog



Fi-Sonik

P. O. Box 1080

Pinole, California 94564

Tel: (510) 724-7977

FAX: (510) 724-9439

email: FiSonik@aol.com

the Chaffee
Hickok Store,
Santa Rosa, CA.

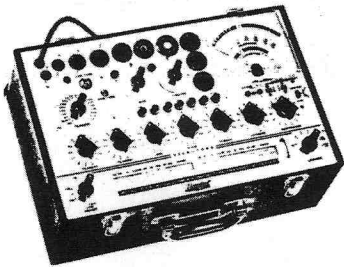

- Repair & calibration from 533 to Cardmatics
- **Hickok** testers for sale cleaned & calibrated with 90 day warranty
- Economical repairs
- We buy busted **Hickoks** too.
- See photos of all my testers for sale at:
www.Tubewizard.com
email: 6SN7@abac.com
Phone : (707) 544-4122

tubes and more

Single-Ended Output Transformers

High Quality for a Reasonable Price
Designed and Built in the USA

UBT-1

Designed for parallel operation of:
2A3s, EL34s, 300Bs, 6AS7s, etc. or
Sweep-tube in "enhanced triode" mode
1.6k primary
15 watts
160mA

\$99.00

UBT-2

Can be used with:
300B, 50, 5V811-3, etc.
4.8k primary
15 watts
110mA

\$119.00

UBT-3

Good for single ended:
2A3 or 300B
3k primary
15 watts
110mA

\$99.00

BFT-1B

Designed for use with UBT-1s
770vct / 520vct @ 340 ma
6.3vct @ 9.6a
6.3v @ 4a
5vct @ 4a

\$169.00

quantity pricing available

6221 S. Maple Ave. Tempe, AZ 85283
Ph: 480-820-5411 Fax: 480-820-4643 or
800-706-6789
www.tubesandmore.com



TUBE AMP BOOKS by Kevin O'Connor

Books boutique amp builders rely on:

THE ULTIMATE TONE - US \$55
Modifying and Custom Building
Tube Guitar Amps

THE ULTIMATE TONE - Volume 2
Systems Approach to
Stage Sound Nirvana US \$40

TONNES OF TONE - US \$25
Electronic Projects for Guitar & Bass

The hifi hobbyist's reference:

PRINCIPLES OF POWER - US \$35
A Practical Guide to Tube Power
Amplifier Design

READY SET GO! - US \$20
An Electronics Reference for
the Everyman

SHIPPING: US add 5% surface or 10% air
Int'l: add 10% surface or 40% air
MC, VISA, cheque or money order

POWER PRESS PUBLISHING

PO Box 1777, Station B,
London, Ontario, CANADA, N6A 5H9

Phone 519-668-3132 FAX 519-668-2055

Vintage NOS Audio and Guitar Tubes Premium Quality

One of the largest selections of genuine, tested, premium grade NOS audio tubes for sale:

5U4GB	5AR4	6CA7	6L6GC
6SL7GT	6SN7GT	6V6GT	12AT7
12AU7	12AX7A	45	50
807	811	5687	5881
6201	6550A	6681	6922
7308	7355	7581	7591
7868	8417	EF86	EL34
EL84	396A	417A	KT66
KT77	KT88	KT90	MORE!

www.vacuumtube.com

ELECTRA-PRINT AUDIO

Quality Handwound S.E. Output Transformers

- Primaries from 1.8K to 10K
- Exclusive wideband design
- Line Stage with Headphone Out
- Single Plate to PP Grids

Custom-Built Power Transformers / Chokes

- Wound to your requirements
- Heavy-duty design for Class A use
- DC Filament Supply Windings
- HV chokes to 15H, 300ma
- Low voltage, high current filament chokes

Component Pricing and Specifications
Catalog Available



**ELECTRA-PRINT
AUDIO**

4117 Roxanne Drive
Las Vegas, NV 89108

702-396-4909 FAX 702-396-4910

SILVER SONIC™

Audio Cables

*Making the High End
Affordable!*

"With tube amps and hybrids, the
Silver Sonic competed with the best."
Bound for Sound

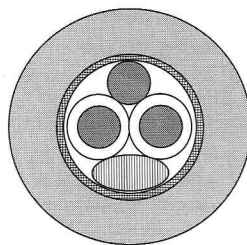

Silver Sonic T-14 Speaker Cable
Silver Sonic BL-1 Series II Interconnect
Silver Sonic D-110 AES/EBU Digital
Silver Sonic D-75 Digital Cable
Hook up wire & Connectors

D.H. Labs, Inc.
612 N. Orange Ave., Suite A-2
Jupiter, FL 33458
(561) 745-6406 (phone/fax)
www.silversonic.com

THE HOUSE OF TUBES

Putting the Glow in Your Audio System

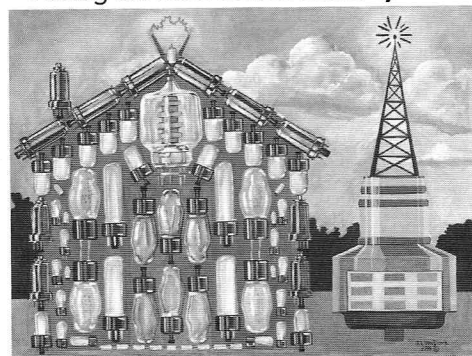

We know that tubes are the heart of a transceiver
and the soul of an amplifier. That's why we're
dedicated to reliable tubes at excellent prices.
We offer the finest in audio tubes and quality
components, and we've made ordering convenient.

Tubes—They're our foundation.

Visit us at: www.houseoftubes.com
e-mail: info@houseoftubes.com

VacuTrace™

Vacuum Tube Curve Tracer

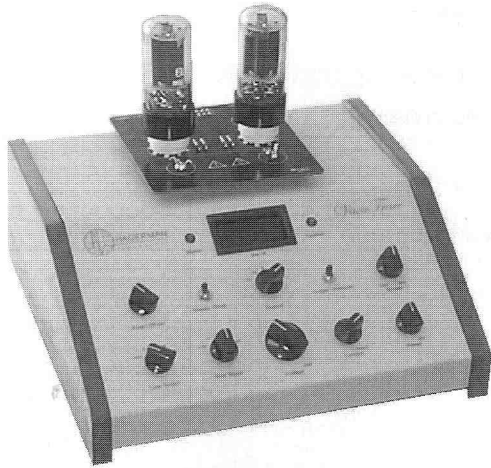

Assembled: \$999, Kit: \$899

Do you test tubes?

If you design amplifiers, chances are good that you prefer to use the best vacuum tubes possible. They work better and sound better too. Fortunately, you no longer have to pay excessive prices for somebody else to test and match them (and dictate the quality of your product). Do it yourself with a VacuTrace™. And have fun, too. Sweep curves in milliseconds, not minutes like other testers require. Easily compare both sections within a 12AX7 or a pair of EL34. Measure transconductance at any operating point.

Of course, the final judge should be your ears. But get a headstart. Invest in a VacuTrace™ today. Save tomorrow.

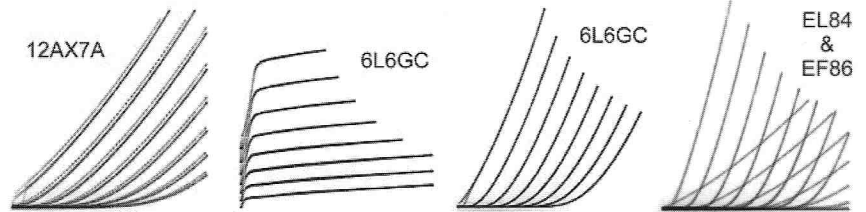

(Actual curves generated by VacuTrace)

For more information or to order, visit www.hagtech.com

Hagerman Technology LLC
PO Box 26437
Honolulu, HI 96825
Phone: (808)-383-2704
Fax: (808)-394-6076



CLARITY WIRES

*Audio Interconnect Cables
for the
Discriminating Listener*

....no other cable in our review had the presence and well, clarity that the Foxfire possessed....

.....smooth and liquid with a sweet, open, and airy sound. It had lots of detail, presence and great pace and tempo to boot.....

David Bardes, Vacuum Tube Valley -Issue #16

Distributed and sold by:
Response Audio
Endicott, NY

Toll free 1-888-785-9773 till 11pm Eastern/7 days
Email: Response34@aol.com
www.responseaudio.com

TEK LINE Audio Cables

Since 1993 Southern California-based TEK LINE has been providing one of the best cables values in the audio industry. We believe in manufacturing high quality cables that reproduce music accurately, but we don't believe in charging high prices for our efforts. Each TEK LINE product offers quality, hand-crafted workmanship utilizing only the finest parts. While TEK LINE cables are available in standard lengths, because each cable is hand-crafted, we can customize any cable to fit your specific needs.

We at TEK LINE believe that we have come up with the best mix of cables at the best possible prices. Our product line has cables for the beginner audiophile to the extreme purist. TEK LINE offers interconnects, speaker wire, power cords, digital and video cables. The mix includes pure silver, copper silver-plated and pure copper. We also offer a wide variety of connectors (RCA's, bananas, spades, and power plugs) from many manufacturers to make sure each cable is constructed to meet your needs. We also offer different color mesh to allow your cables to blend in with your living environment. TEK LINE has spent numerous hours of research and testing on our cables to create the best possible sound reproduction for the best possible price.

TEK LINE believes "everything in a system makes a difference". This is true for all components in one's system including cables. As a matter of fact, cables may make the biggest difference you can notice in your system at a fraction of the price of new equipment. The price/performance ratio regarding cables is possibly the largest in one's system. This is why we encourage you to audition TEK LINE audio cables to determine for yourself the sound improvement. We feel that after you have compared price to performance, you will become a believer in TEK LINE audio cables.

TEK LINE P.O. Box 598, Harbor City, CA 90710-0598
Phone (310) 835-2967 Fax: (310) 513-0720

Email: TEKLINEAUDIO@aol.com Web site: www.TekLineAudio.com

Purveyors of "Classic" Transformers & Enclosures

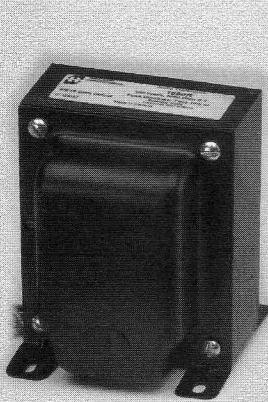

*Single Ended, Push-Pull
and Potted Tube Output
Transformers*

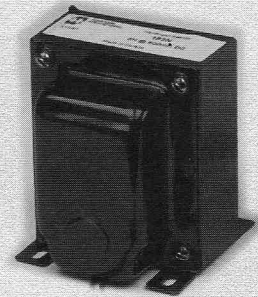
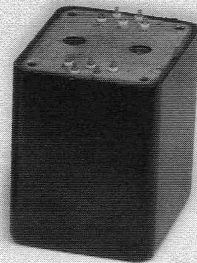
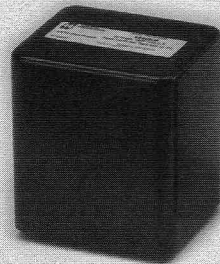

Filter Chokes

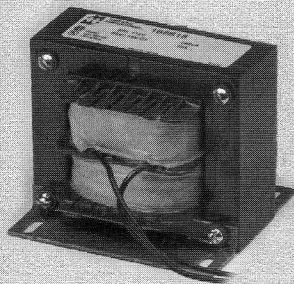

*Open & Enclosed
Filament Transformers*

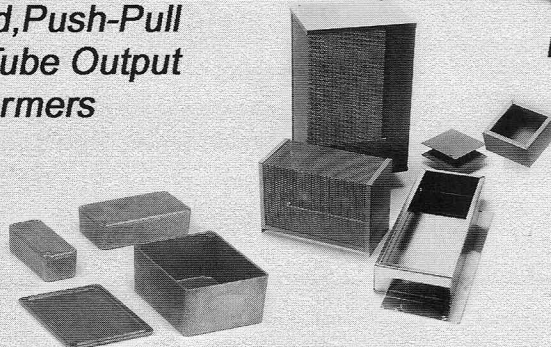

*Aluminum & Steel Chassis
and Diecast Aluminum
Enclosures*

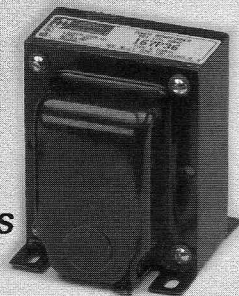

*High Voltage Plate
Transformers*

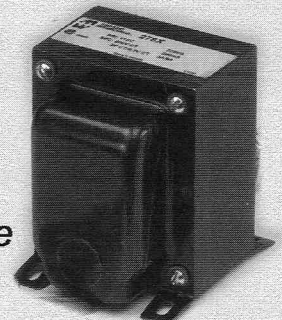

Contact us for a free catalog & list of stocking distributors

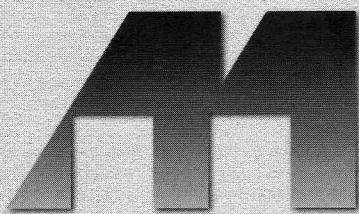

HAMMOND MANUFACTURING™

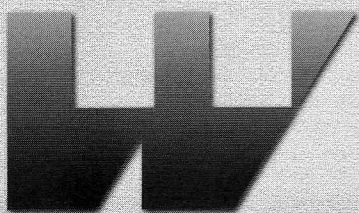

256 Sonwil Dr. - Cheektowaga, NY 14225 USA
Phone: (716) 651-0086 Fax: (716) 651-0726
394 Edinburgh Rd., N. - Guelph, Ontario N1H 1E5 Canada
Phone: (519) 822-2960 Fax: (519) 822-0715

www.hammondmfg.com

I TOLD YOU I WON'T PUT OUT
UNTIL YOU GET SOME OF THOSE
AMAZING

METASONIX

VACUUM-TUBE
ELECTRONIC MUSIC PRODUCTS!

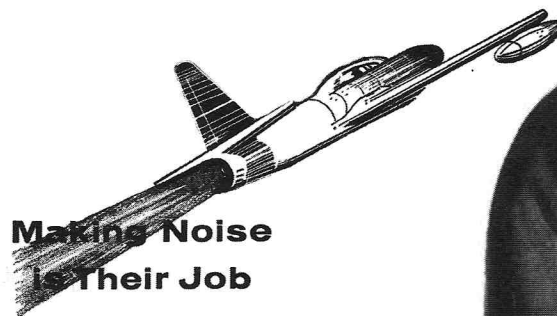
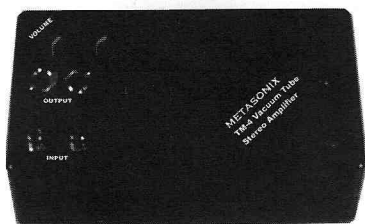

Making Noise
Is Their Job



YOU'VE BEEN A
Naughty Naughty
BOY, HAVEN'T YOU???



PRODUCTS

- Custom Terminal Boards
- EXPERIENCE Electronics Kits
- IAG Kits
- SOWTER Transformers
- Custom Transformers
- Chassis
- Transformer covers

IAG 4.5SE

- 3 Watts per channel
- Single Ended
- Class A triode connected
- EL84/6BQ5 Output tubes
- Tube Rectifier 6CA4/EZ81
- EF86 Driver tube
- 20Hz-20kHz +/- .2dB
- Polished Aluminum chassis
- Assembled or Kit
- Point to Point wired
- Gold plated connectors

IAG 4.5SE

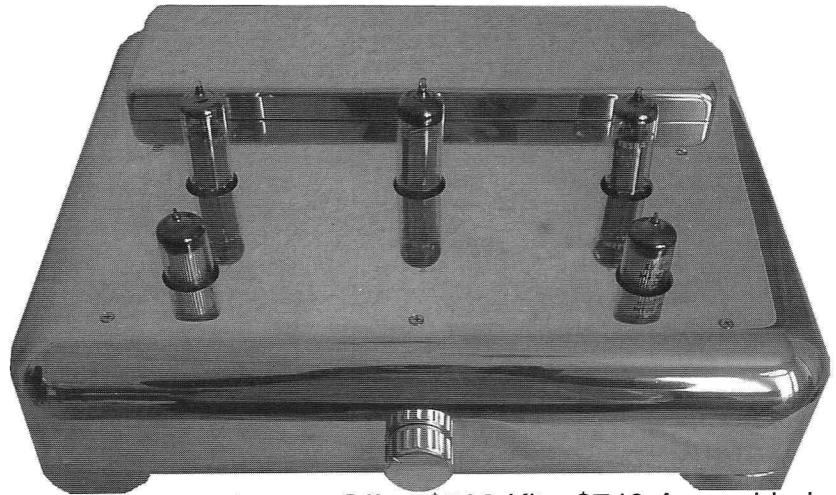

Special Introductory Offer: \$599 Kit - \$749 Assembled

Special introductory offer Assembled \$599.99 Kit \$499.00

International Audio Group PO Box 10096, Killeen TX 76547-0096. Tel/Fax (254) 699-8702 Email hiag@dashlink.

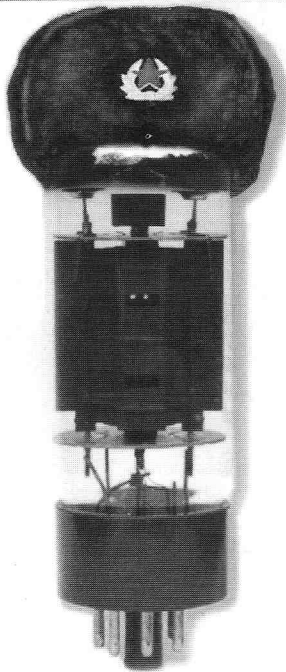

THE RUSSIANS ARE BACK.

The world famous Russian Svetlana 6L6 tubes.
Exclusively by Mojo Musical Supply.



Your Source for Svetlana, Ei, JJ, Valve Art, and NOS Vacuum Tubes.
1.800.927.MOJO (6656) www.mojofone.com

VACUUM TUBE VALLEY

"The finest tube-only magazine on the planet"

Ken Kessler - Hi Fi News and Record Review - June 2000



VTV #1 Spring 1995 \$12.95
Vintage Dynaco Tube Equipment - 1955-77
History and Testing of the 12AX7/ECC83 dual triode
Tube Testing Methods + Why Tubes Sound Better

VTV #2 Fall 1995 \$12.95
Heathkit - The Tube Williamson Years 1950-61
EL34/6CA7 History, Types and Tests
Magnum SE EL509 Amplifier Project by Dave Wolze
1927-34 Western Electric Theater Sound Systems

VTV #3 Winter 1995/96 \$12.95
Eico Mono Tube Gear - 1955-62
Altec Lansing 604 Coaxial Loudspeaker History
Western Electric 300B History and Listening Tests
300B SE Transformer Listening Tests

VTV #4 Spring 1996 \$12.95
6L6 History, Types and Listening Tests
Vintage Bookshelf Speakers 1955-1965
Early FM Broadcasting History
HK Citation I & II Amplifier History and Mods

VTV #5 Fall 1996 \$12.95
The Ultimate FM Tuner Shoot Out
Red Bank Guided Missile Tubes for Hi-Fi
The Birth of the Marantz 10B
Choosing Rectifier Tubes for your Guitar Amplifier

VTV #6 Winter 1997 \$12.95
Fisher 500 - History, Models and Restoration
A Tribute to Avery Fisher by the Fisher Doctor
6550 and KT88 History, Types and Listening Tests
Loftin-White Amplifier History by Alan Douglas

VTV #7 Summer 1997 \$12.95
6DJ8, 6922 and 7308 - History and Tests
Altec 1950s Theater Amps and Modifications
The Great Voice - Peter Jensen Story
Multi-Tube Line Stage Project - Eric Barbour
Uncle Eric's Tube Dumpster - 417A/5842

VTV #8 Fall 1997 \$12.95
EL84 History, Types & Listening Tests
RCA Tube Mfg at Harrison, New Jersey
200 watt OTL Amp Project by Allan Kimmel
300B Listening Tests: NOS and Vintage Types
Interview with Bruce Moore, Tube Audio Pioneer

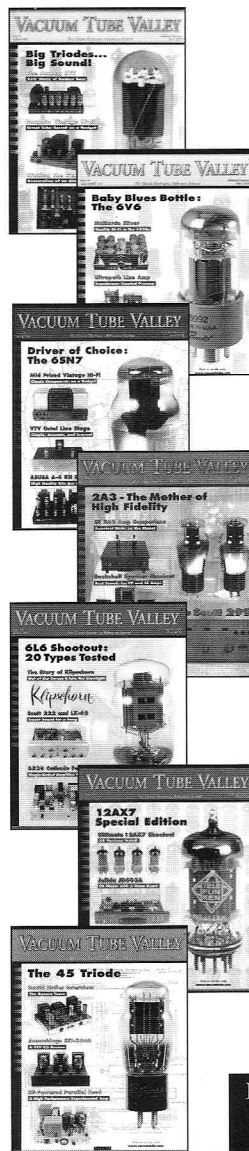

VTV #9 Spring 1998 \$12.95
Transmitting Tube Review, Ampeg SVT Guitar
Amp, Altec 287W amp, Bargain Vintage Hi-Fi

VTV #10 Summer/Fall 1998 \$12.95
Story of the 6V6 and listening tests, Hi-Fi radio
in the 30s, PP SV572 amp, Ultrathin Line Stage

VTV #11 Spring 1999 \$12.95
6SN7: History and Tests, Octal Line Stage
Project, Mid-Priced Vintage High-Fi, OTL
Headphone Amp, Capacitors and FREDs

**VTV #12 Summer 1999 - 2A3 History
and Tests, 2A3 SE Amp Reviews, Bookshelf
Speaker Test, Scott 299: History and Mods,
300 Watt SV572 Amp Project \$12.95**

VTV#13 Winter 2000
6L6 Shootout, Paul Klipsch Interview,
Klipschorn Lore and Mods, Scott 222 and
LK-48, PP 2A3 Amp Project \$12.95

VTV #14 Summer 2000 \$12.95
12AX7 History and Tests (52 Versions)
PPSV83 Amp Project
Elliano's Direct Reactance Preamp Project
David Hafler - The Acrosound Years

VTV# 15 Winter 2001 \$12.95
The 45 Triode - History and Tests
RF-Powered Parallel Feed Amp Project
David Hafler - The Dynaco Years
12AX7 Hi-Fi Shootout

For back issue orders, please add shipping and handling: US \$7.50, Canada \$12.50, Europe \$22.50, Asia/World \$28.50.

VTV is a highly researched and finely crafted reference publication covering the finest in tube audio electronics, vintage hi-fi, musical instrument amplification, loudspeakers, DIY, listening tests and honest equipment reviews. If you are into tubes, you need VTV!

VTV Subscription Rates

4 Issues / Year
\$49/year US First Class
\$40/year US Third Class
\$52/Canada-\$65/Europe
\$75/Asia & World
Pre-Payment Required Please
AMEX, MC or VISA OK

VTV Subscription and Back Issue Order Form (FAX or Mail)

Name _____
Address _____
City _____ State/Country _____
MailCode/ZIP _____ Telephone# _____
I want to subscribe for _____ Years - Payment Encl. _____
Send Me the following back issues _____
Payment Enclosed (including shipping) _____

VACUUM TUBE VALLEY

P.O. Box 1499
Lakeport, CA 95453 USA
Phone (707) 263-5881
FAX (707) 263-7648

email - triode@vacuumtube.com

Visit our on-line Pro-Tube Shop for the best selection of gourmet NOS audio tubes, quality tube amplifiers and more.

www.vacuumtube.com

“a major artistic achievement”

Dr. Harvey Gizmo Rosenberg, www.enjoythemusic.com/triode/towards

**The best
audio output
transformers
in the world
— with specs
to prove it.**

“The highest quality audio transformer
I have ever heard.

Incredible low-end response.”

Alex Aguilar, President
Aguilar Amplification, NY, NY.

“This new sample looks super!

Congratulations to you and Menno on great
design work. Consider this as an enthusiastic
acceptance of production.”

Christopher Russell, VP Engineering
Bryston Manufacturing, Peterborough, Ontario

“The build quality and reliability are
excellent. ...simply the best...”

Gilbert Yeung, President
Blue Circle Audio, Innerkip, Ontario

“...your design seems to be really elegant...”

Bill Chater, Journalist

“...absolutely amazed at the low
frequency performance of your design...”

Dr. Vincent McGinn, Chairman Electrical Engineering
Department, Northern Illinois University

Ultra Wide Bandwidth Toroidal Output Transformers for Tube Amplifiers

- o Single Ended
- o Push - Pull
- o Triode
- o Pentode / Super Pentode
- o Cathode Feedback
- o Unity Coupled



8, 601 Magnetic Drive
Toronto, ON, Canada M3J 3J2
www.plitron.com
e-mail: techinfo@plitron.com
1-800-PLITRON
(1-800-754-8766)
Tel. 416-667-9914
FAX 416-667-8928

www.plitron.com

We specialize in audio transformers.
Since 1983 Plitron has supplied
toroidal transformers to high-end equipment manufacturers.

Ultra-Tone Silvered Foil in Oil Capacitors

Now at reduced pricing!



Due to huge demand for these capacitors, we've made a large purchase from the factory. Our new reduced pricing now makes them more affordable to audio enthusiasts!

Specially designed for the audiophile, builder, OEM or equipment upgrader, Ultra-Tone Silvered Foil caps have astonishing musical realism, 3-D imaging and life! Bass response is full and powerful. Mids and highs are full and sweet, with balance and detail. Music appears magically from the silent blackness with no undesirable recording artifacts as some polystyrene and foil capacitors can exhibit. Our customers tell us that the Ultra-Tones perform several sonic notches above competitive copper and tin foil capacitors. Perfect for SE triode, PP tube and horn-type loudspeakers.

- Proprietary silvered alloy foil material for ultra-fast signal transfer
- Viscous oil dielectric for ultra-rich musicality (No PCBs)
- Most values have .9 mm solid silver lead-out wires for added fidelity
- Kraft dielectric paper for smooth sonics
- Sealed in epoxy
- One year replacement warranty

"Completely transparent, they nevertheless are deliciously sweet and liquid" Michael Elliot - Alta-Vista Audio

High-Voltage Coupling and Signal Capacitors

Value	DC Voltage	Dimensions (l x w)	Price ea
0.05uf	400 VDC	1 x 7/16 inches	\$8.00
0.01	650	1 1/8 x 1/2	9.00
0.02	650	1 5/16 x 7/16	10.00
0.05	650	1 5/8 x 5/8	12.00
0.1	650	1 5/8 x 5/8	13.00
0.22	650	1 7/8 x 7/8	19.00
0.47	650	2 3/16 x 1	30.00
1.0	650	2 3/16 x 1	38.00

Loudspeaker Crossover Capacitors

(extended silver foil in paper/oil)

Value	DC Voltage	Dimensions	Price ea
1.0uf	200 VDC	2 3/16 inches	\$22.00
2.0	200	2 3/16	32.00
4.0	200	3 x 2 1/4	45.00
8.0	200	4 x 2.1/4	60.00

NEW! High-Voltage Power Supply Capacitors

The finest high-voltage power supply capacitor on the market. Made with premium grade polypropylene film wound in aluminum foil. These caps are built to last a lifetime. They have super low ESR and never will dry out or need forming. Caps are sealed in epoxy fill and enclosed in a gleaming seamless aluminum can with a threaded stud mount and stranded copper radial leads. Better sonics than expensive electrolytics at a lower price!

HV Poly Film with Aluminum Foil Power Caps

Value	DC Rating	Dimensions (l x w)	Price ea
10uf	650VDC	3 7/8 x 1 3/16 inches	\$14.00
20	650	3 7/8 x 1 3/16	20.00
50	650	3 3/4 x 1 3/4	36.00
100	650	3 3/4 x 2 1/2	48.00

Visit our website to order online or to download and print an order form, FAX us your order or call our 24 hour secure order line and follow product ordering instructions. (Note: No other values available other than those listed.) \$35 MINIMUM ORDER plus shipping.

VACUUM TUBE VALLEY

P.O. Box 1499, Lakeport, CA 95453 USA
 Phone: 707-263-5881 - FAX 707-263-7648
www.vacuumtube.com

IF YOU WANT TO REACH THE STARS

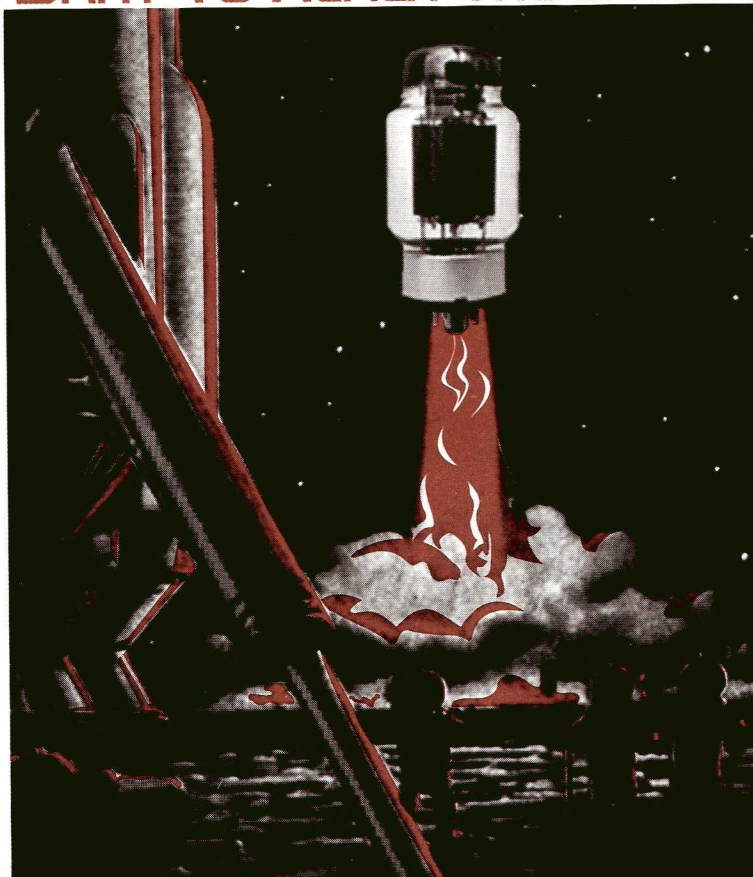

YOU NEED THE RIGHT EQUIPMENT*

* If you're looking for that unique mix of new and vintage components for a special project, Antique Electronic Supply has the right equipment. There's a good chance that we carry everything you are looking for, all in one place.

We specialize in vacuum tubes, both new-old stock and current production, and each tube comes with a guarantee! We also have a huge variety of transformers, capacitors, speakers, supplies, parts, and books related to vacuum tube technology.

Contact us today to receive your free 80 page catalog, or visit our website!



6221 S. Maple Ave.
Tempe, AZ 85283

Phone: 480.820.5411

Fax: 480.820.4643 or
800.706.6789

e-mail: info@tubesandmore.com

www.tubesandmore.com