

# VACUUM TUBE VALLEY<sup>®</sup>

Issue 19 Quarterly

The Classic Electronics Reference Journal

Price \$10.95

## 6550/KT88 The Power Kings

**6550/KT88 Shootout**

**Guitar and Hi-Fi Best Bets**

**Eckland KT88 Project**

**The Ultimate KT88 PP Amp**

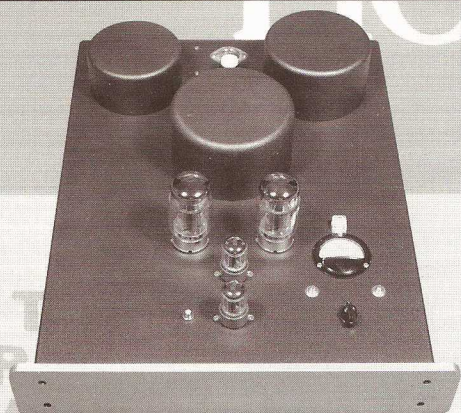

**Radio Craftsmen C500**

**The Story of a Classic Amp**



Display until 9/30/03



MANUFACTURED BY  
THE M.D. VALVE CO. LTD.  
A SUBSIDIARY OF  
THE GENERAL ELECTRIC CO. LTD.  
OF ENGLAND.

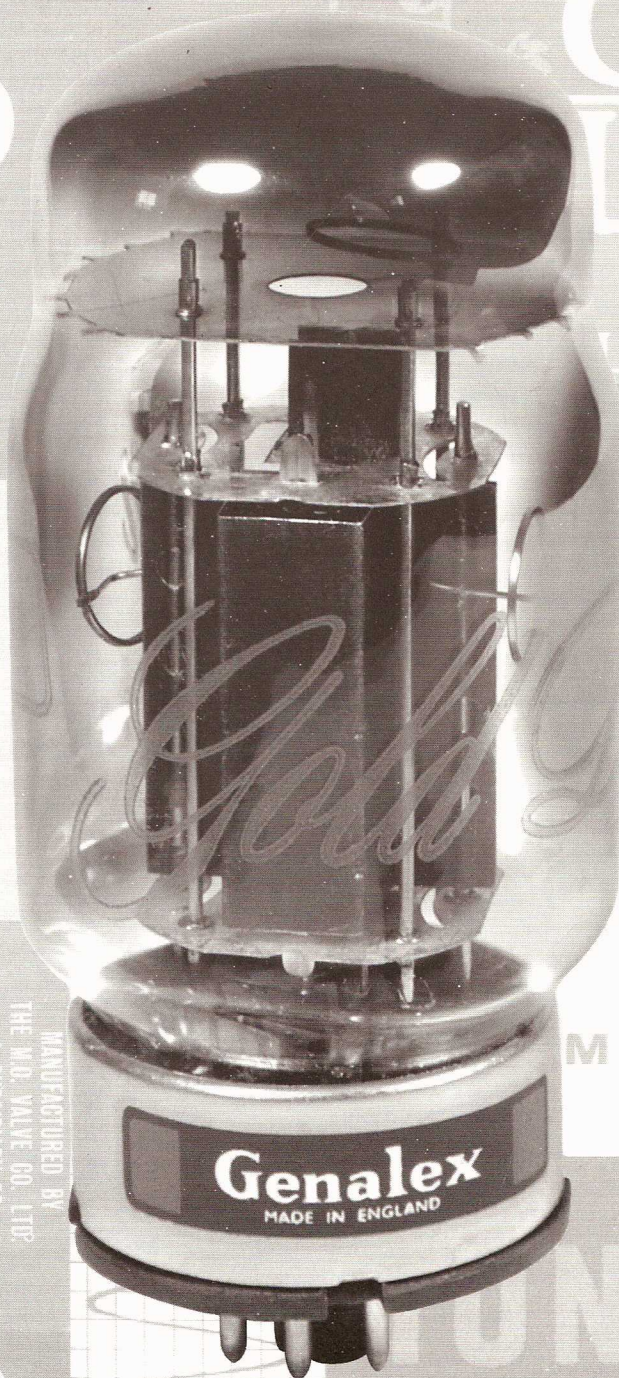

Visit us on the web [www.vacuumtube.com](http://www.vacuumtube.com)

My darling, will  
you ever leave  
me again?



**NYΣT!**

*-Svetlana*

The finest audio power tubes in the world are available again in the  
US and Canada, exclusively from PM of America, Inc.

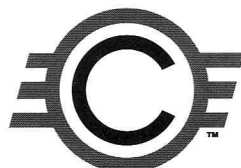

**Svetlana**

[www.svetlanausa.com](http://www.svetlanausa.com)



1687 Shelby Oaks Drive / Suite 8 / Memphis, TN 38134 / 901-388-2424 / fax 901-388-2405

**VTV Issue 19  
Table of Contents:**

- 6550/KT88 Power Kings.....4**
- Contest for High Fidelity II.....9**
- NOS Tubes Sound Better.....14**
- Klipsch RF-7 Speakers.....17**
- Berning Micro ZOTL Amp ....19**
- Craftsmen C 500 Amps .....21**
- Eckland KT88 Amp Project..26**
- 6550 Shoot Out Hi Fi.....28**
- 6550 Shoot Out Guitar.....32**

**VTV Visits the NAMM Show 2003**

In late January 2003, we visited the famed NAMM show in Anaheim, CA. There were dozens of tube amp guitar companies, distributors and even tube manufacturers including JJ of Slovakia.

We met with many of our vendors and customers face-to-face and had a great time. See our website under "Hot News" for color photos of the likes of Mike Matthews, Noreen Cravener, Ralph Trimarchi, etc.

In addition, we were treated to a grand tour of Aspen Pittman's Groove Tubes operation in San Fernando. He is now in production making the reissue GE 6L6GC output tube. They are planning a fat bottle EL34 and a 6V6GT as well. We are planning an extensive story on Groove Tubes and their boutique power tube manufacturing in VTV #20. Stay tuned!!!

**New Tubes from Sophia Electric**

Sophia Electric has recently introduced three new tubes aimed squarely at vacuum tube audio enthusiasts. Encased in a retro globe-shaped bottle, the 300B and 2A3 are identical in construction, and only the designation of the filament voltage on the base reveals the difference. The 274B is also a globe bottle, but has conventional solid plates for its dual diodes.



These tubes are the finishing touch to that retro looking amp project. The globe bottle conjures up the pioneer days of audio, and the glow of the filaments through the mesh plates is very cool. They look great!

I placed a pair of the 300Bs in my SE amp and they proved to be very musical. They possess a wonderful open and sweet treble that is the best I've heard in my living room. With these tubes in place, cymbal strikes were clear, real and decayed exquisitely. Midrange response was firm and detailed. Bass response was solid, but the Sophias didn't dig as deep as some other 300B tubes I've listened to. Still, the Sophias are detailed, revealing and warm, and while not as punchy and dynamic as the Sovtek or JJ 300Bs, are a delight to listen to.

**Phone: 703-204-1429 or 571-277-8823 www.sophiaelectric.com**

**Riccardo Kron Dies at 68**

As founder and owner of KR Audio, Riccardo believed in tube technology and in its development as the future of sound reproduction in audio. His designs and projects are the basis for the technological legacy he left at KR Audio Electronics in Prague, Czech Republic.

Kron designed a low cost television known as the "engineering miracle" in the 1960s. He is most remembered for his award winning design of the Kronzilla tube, the KR T-1610, the largest audio tube in production, and for the "Best Sound of the Show" prize awarded to him for the Kronzilla double monoblock amplifier at the Frankfurt High End Hi-Fi Fair in May 2002.

**Bay Area Tube Fest June 1, 2003**

The second annual Bay Area Tube Festival is being held at the Randall Museum in San Francisco on June 1 from 9AM to 6PM.

The all-day event will include presentations by: John Atwood, who will discuss audio spectrum analyzers; Alan Kimmel, who will present his choke mu stage amplifier; Gary Pimm, who will review AC current circuit analysis; Lynn Olson, who will discuss amp-speaker interface; and Jack Elliano, who will cover his SE and PP amp designs.

Vendor tables for tubes, parts and equipment will be available at the event. Beverages and sandwiches will be served on-site.

Admission is \$15, payable at the door. For more information, contact Chris Betcher at 415-554-9601. Check the VTV website for more info.

**Editorial Staff**

- Charles Kittleson** Editor and Publisher
- Eric Barbour** Senior Editor
- Lynn Olson** Technical Editor
- Ron Veil** Guitar Amp Tech Editor
- David Bardes** Associate Editor
- Steve Parr** Art Director
- Julie P. Werner** Copy Editor

Visit us on the web!  
[www.vacuumtube.com](http://www.vacuumtube.com)

Copyright 2003 **Vacuum Tube Valley**<sup>®</sup>  
All rights reserved.

No part of this publication may be reprinted or electronically reproduced without written permission of the publisher.

Send circulation and editorial correspondence to:

**Vacuum Tube Valley**  
P.O. Box 1499,  
Lakeport, CA 95453 USA  
e-mail [triode@vacuumtube.com](mailto:triode@vacuumtube.com)

**ISSN # 1095-4805**

**Vacuum Tube Valley**<sup>®</sup> is published quarterly for electronic enthusiasts interested in the colorful past, present and future of vacuum tube electronics.

Subscriptions: US\$45/4 issues 3rd Class-\$55 1st Class; Canada/\$60; Asia/\$75; Europe/\$70

**US Bank Check, Credit Cards or Cash are accepted for payment.**

**Phone (707) 263 - 5881  
FAX (707) 263 - 7648**

# 6550/KT88 Power Kings Part II

By Eric Barbour ©2002 All Rights Reserved

## 1. Intro

The concept that a power tube we use today was made "without compromise" amuses me to no end. Since our previous 6550/KT88 article in 1996, many more facts about the origin of these "popular" types has come to light. Some of the facts seem to contradict the commonly held audiophile snobbery surrounding these tubes--especially the KT88. First, we shall revisit the origin of the 6550 family.

## 2. 6550

In the halcyon days of hi-fi, getting more than 30 watts was very expensive. It required at least four 6L6Gs at typical 300-400v plate voltages, or transmitting tubes at much higher voltages. Even though a pair of 807s would do the job, the plate voltage would have to be more than 550--this usually required oil capacitors in the power supply, plus more expensive transformers that were rated for such operation. The price added up, and by the time the customer has paid for a tuner, turntable, speaker, and the mandatory cabinet, there wasn't much left for a transmitting-tube power amp.

There was unquestionably a strong desire for such products. Construction articles in *Audio Engineering* in the 1948-1954 frame often featured large tubes. The *Audio Anthology* books, volumes 1 thru 3, contain 21 amplifier construction articles, of which one used 211s, two used 807s, one used 845s, and one used the type 6146, which was new in 1952. The vast majority of the amp circuits were good for less than 15 watts, which most people

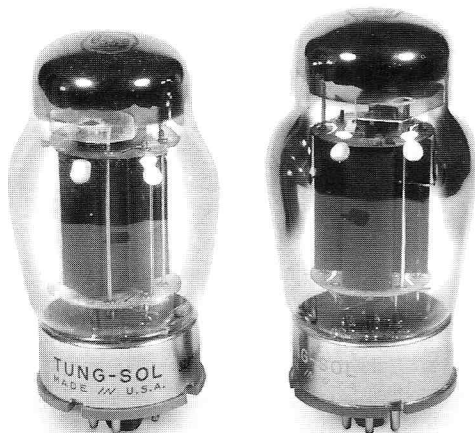

*Tung-Sol 6550 (first type 1955 black plate, no holes top getter) and Tung-Sol 6550 (late 1950's black plate, no holes and triple getter)*



*Tung-Sol 6550 (1963 triple getter-no holes with GE markings) and Tung-Sol 6550 (1965 triple getter-with holes)*

thought was plenty. The transmitting-tube circuits must have been seen as luxury projects intended only for the serious "audio bug." Such amps were not ordinarily available from early hi-fi dealers.

Power was the need, even though most people were using relatively efficient speakers and horns were at the peak of popularity. Bear in mind that these users were nearly all middle-aged men who listened primarily to classical music; hi-fis weren't used for rock'n roll until the late 1960s. They must have been desperate for louder crescendos, perhaps to drown out the wife's TV shows?

The RCA 6146 was a landmark tube in some ways. It was rated to take 750 volts on its plate, and a pair was good for 100 watts. But its high cost meant that it never saw commercial use in hi-fi. The only major audio amp to use it was the Altec 1530, an industrial-looking rack-mount PA amplifier. And the only well-known instrument amp with 6146s was the early Ampeg SVT bass-guitar amp, introduced in 1964, well after the time period we are covering. Obviously there was a demand for a tube that could do more than 50 watts, with low distortion, at a cost below that of the 6146. Mullard's EL37 could do it but was about as expensive as the 6146.

A need existed, and it was filled in February 1955. And it wasn't done by a giant like RCA, or GE, or Sylvania. It was done by Tung-Sol, a medium-size tube manufacturer in Newark, New Jersey that catered to the MIL-SPEC market. The 6550 appeared to be heavily influenced by the 6146, but are clearly intended for audio. This was the power tube that started the amplifier power wars.

The 6550 was designed for home audio equipment, and it was designed for compact size and cost-efficiency. No plate cap meant no plate cap connector, with the added advantage of less risk of electrocution to the user when replacing tubes. A large octal base with a metal ring at cathode potential was another safety feature which also improved electrical stability. Tung-Sol engineers had a distinctive envelope made for the tube, derived from the older "ST" shape. This squat, rounded "Coke bottle" appearance set the tube apart from the crowd.

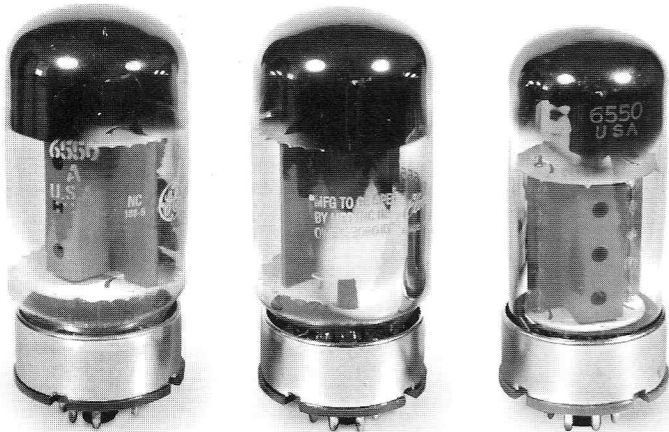

*GE 6550A (1970s), GE 6550A (1992 MPD-reissue)  
and Philips-USA 6550 (1970s)*

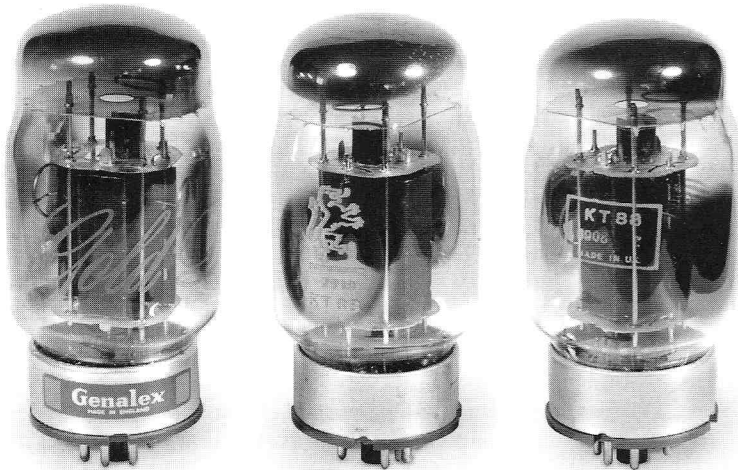

*Genalex KT88 (early 1960s with gold script on tube and red  
decal on base), Genalex KT88 (1970s) and Mullard KT88  
(1969 actually a Genalex tube)*

Realize this: until tube audio became a high-ticket specialist field in the 1980s, the market was extremely aggressive, and prices were forced down by competition. In 1969 a 6550 cost about \$21 at retail (about \$65 in 2003 dollars)--and you needed four for stereo--not that cheap.. Not only that, it was considered a "specialist" product, and never sold in the quantities typical of popular TV or radio tubes.

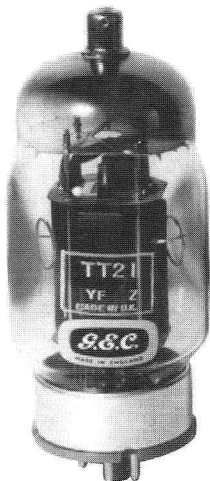

*Genalex TT21 with  
anode cap*

With rated plate dissipation of 35 watts in tetrode and 40 watts in triode, Tung-Sol advertisements bragged that "two 6550s in push-pull will provide the same power now attained in most existing designs by the use of four or more tubes." Thanks to the large low-loss base with molded-in dams between the pins, to discourage leakage currents, the 6550 was rated for 600 volts on the plate

and 400 volts on the screen for Ultralinear or triode operation.

It had about twice the transconductance of the 6L6 types, so it could produce 100 watts with about the same drive voltages as the 6L6s. The grids of the 6550 were gold-plated and the screen was also carbonized, to prevent grid emission and bias runaway. The result was a "downsized" transmitting tube at receiving tube prices.

Like its grandfather, the 6L6, this tube was an instant hit. Numerous hi-fi amps used it, most notably the popular Dynaco Mark III. And its toughness and low cost caused it to be used by engineers in applications like servo amplifiers for computer tape drives. A Univac 1101 computer's tape drive used 12 of them. Because the cathode was clearly rated to produce 175 milliamps, it became popular as a pass tube in regulated power supplies. A 6550 could produce nearly as much current as a 6AS7, and with greater regulation effectiveness and reliability.

GE came out with the straight-sided 6550A in 1971. It was called 6550A, because of the introduction of an exotic 5-ply metal plate material manufactured by Texas Instruments. This metal, produced by cladding a copper or aluminum core with steel outer layers using explosives, made for a more reliable tube with greater bias stability. The clad metal was better at dissipating plate heat, and it thus lessened plate and grid emission. There were two versions of the GE 6550A; earlier ones had rough-looking welds on the plate, while from about 1979 the plates were stamped and swaged. In spite of protestations from high-ticket tube dealers, there doesn't seem to be a major difference between these versions, although the overall quality declined during the 1980s.

Some NOS dealers like to claim that a welded plate is a critical, magical guarantee of quality. VTV does not agree. We feel that vacuum quality, manufacturing tolerances, and other factors (things that you can't see with the naked eye) are usually more important. These are areas where modern tube manufacturers and distributors can save money, and in most cases, that is exactly what they do.

Triode or Ultralinear operation of an aligned grid tetrode can easily overheat the screen, especially at full drive. The high voltages typically used on the 6550 family make the situation worse. Hard vacuum requires pumping and processing the tube for at least 1.5 hours, a procedure which is evidently not followed any longer. Due to the 6550s and KT88s returned by consumers, Shuguang improved their quality. Yet it was still not adequate to meet the severe demands of amps like the Marshall Major and the Jadis JA-200 and JA-80. The increasing popularity of tube hi-fi in the 1990s caused OEMs to demand better quality. This resulted in the National/Richardson KT88, the "Golden Dragon" 6550 and KT88, and the Svetlana 6550C and KT88 and Tesla/JJ KT88.

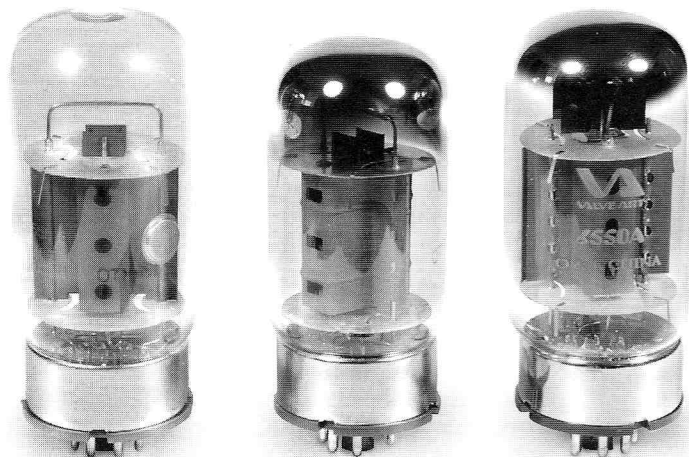

*Svetlana SV6550B (early 1990s with pill getter), Svetlana SV6550C (2001) and Valve Arts Chinese 6550CA (2002)*

**3. Tests** All tests were performed at 500v, 75 mA, in pentode connection with 300v on the screen grid. Plate load was 3200 ohms and the control grid resistance was 47k ohms. Note that many of the NOS samples represent many years of manufacture. The Tung-Sol samples here cover nearly 20 years of production, and the MOVs, GEs and Sylvania's were various samples from 10-20 year production timeframes.

**Table 1**

**6550/KT88 DISTORTION, 500 VOLTS PENTODE (arranged by increasing distortion)**

TYPE	DIST%	# OF SAMPLES
Sylvania 6550A	0.527%	7 (5 good used)
Svetlana KT88	.579	7
Sovtek KT88 (1998)	.605	2
TungSol 6550 late	.615	7 (4 good used)
MOV KT88	.616	14 (all good used)
TungSol 6550 2-get	.620	4 (all good used)
TungSol 6550 topget	.623	17 (all good used)
EI KT90	.647	3
Svetlana 6550C	.653	4
GE 6550A	.655	4 (3 good used)
Shuguang KT88	.665	4
Tesla/JJ KT88S	.670	2
Shuguang 6550	.690	2

**Table 2**

**PEAK POWER TEST, 500 VOLTS PENTODE (arranged by decreasing peak voltage)**

Svetlana 6550C	16.25
Svetlana KT88	16.05
Tesla/JJ KT88S	16.00
TungSol 6550 late	15.75 (tie)
GE 6550A	15.75 (tie)
Shuguang 6550	15.75 (tie)
MOV KT88	15.57
TungSol 6550 top get	15.38

Shuguang KT88	15.25
TungSol 6550 2-get	15.13
Sylvania 6550A	14.93
EI KT90	13.80

**Summary**

Tung-Sol's 6550 is still excellent in overall performance. It was made with a level of quality control which we may NEVER SEE AGAIN. However, I have put all the current production through very severe tests on a curve tracing system capable of really pounding the screen grid. NOS 6550s and KT88s could take a lot of abuse, thanks to their clean interiors and hard vacuum. All of the current production is inferior in this area.

When I worked at Svetlana USA, I was able to influence the factory to improve screen-grid dissipation in their KT88 before it was sent out for evaluations. They added radiator fins to the screen siderods, so even though the vacuum in the Svetlana KT88 is not much better than their other tubes, the screens can handle orange heat for considerable periods without causing gas-current runaway. This tube was originally made at the behest of McIntosh, for their MC2000 amplifier. It is probably the best such tube in current production. I feel that it gives snob-value NOS some very tough competition.

In 1961, Harman-Kardon sent a letter to its dealers, telling them that the Tung-Sol was superior to the MOV KT88 at controlling grid leakage, thus making its bias point more stable in the H-K Citation II amplifier; so they recommended against putting KT88s into Citation IIs. Tung-Sols were ridiculously common fifteen years ago, and many were crushed by scrap dealers along with the power supplies they inhabited. Now, NOS examples in original blue-and-white Tung-Sol brand boxes can bring \$200. Even NOS units in white military surplus boxes are hot. RCA, GE and Sylvania were all remarking and selling Tung-Sols in the 1950s and into the 1960s, so some will turn up with these other major brands on them.

In spite of Harman-Kardon's complaint, the original MOV KT88 is an excellent tube. It is rated to take more voltage and dissipation than any 6550. This applies only to the original MOV/Genalex/Gold Lion version, identifiable by its gray/blue decal on the tube glass. It does NOT apply to the current Shuguang or Golden Dragon versions sold by most dealers. The Shuguang looks like a small imitation of the MOV with a



6550 structure inside. And beware of bogus Gold Lion tubes! Golden Dragon makes a KT88 whose appearance is quite close to that of the original. We have seen them packaged in replica Gold Lion/Genalex cartons. A dead giveaway is the predominantly red printing on the boxes, and the lack of a blue-gray Genalex decal on the tube.

The old Sylvania tubes for the tests were provided by Terry Buddingh of *Guitar Player*. It seems that hi-fi users rarely see these, but guitarists sometimes have a few old ones kicking around. Note their extremely low distortion. Ironical that this tube was used in guitar amps, yet would be more suitable for high-end amps. The peak power was lower than for any other NOS type, which tends to indicate that it may have been another tube type which was modified for 6550 duty. Similarly, the EI KT90 is said to be derived from the PL509, a TV sweep tube. In any case, the Sylvania 6550A is definitely a scarce collectible today, and NOS pricing will be extreme.

As far as current production 6550s go, the Svetlana 6550C seems to be the best quality. We will not mention the older Svetlana versions 6550B and 6550B-3, as they were experiments which proved not to be popular. Svetlana is currently the world's top supplier of 6550s. Audio Research buys Svetlana 6550Cs every year in huge quantities. Virtually all of ARC's amplifiers use them.

The Shuguangs are acceptable, and no real problems were observed, so quality control is better than it was a few years ago. Still, I can't recommend Shuguangs for triode connection or for dissipation above 30 watts due to continuing problems with processing. They are cheap tubes, and some very questionable dealers are putting all kinds of brands on them. The KT88 doesn't look like the MOV, but the 6550 is very similar in appearance to later Tung-Sols with 6 plate holes. Shuguang's glass containers have a noticeable green/brown discoloration (recycled beer bottles?), and getter flashes in their tubes tend to be exces-



*Chinese KT88 (1990s branded Penta Labs), Richardson-made KT88 (1996) and JJ KT88 (2002) (Slovakian-made)*



*Svetlana KT88 2002 (PM Components), Electro-harmonix KT88EH (2002) and Svetlana (Sovtek) KT88 (2002)*

sively large compared to the original American and European versions. This is not a wise thing to do. Excess getter barium can deposit on the base and insulators, causing leakage currents. The vacuum in a tube should be made good while the tube is still on the pump. And cleanliness is critical, even though these are not micro-processors. The Chinese still have a problem in this area. (The rumor of a Shuguang 6550 with a cigarette butt inside is no rumor.) Furthermore, the Chinese "KT100" seems to have disappeared.

EI's KT90 is known to be a good tube, and is popular with audiophiles who have used Shuguangs in the past (and been dissatisfied). This tube is a modified TV sweep tube, and it is usable in a 6550 amp. Unaccountably, our samples had very low distortion at 300v triode, much lower than any of the other types could do. But since these tubes are never run at such low voltages, the results do not appear here. EI's KT99 is just a selected KT90, so none were tested here. The future availability of EI tubes is good, as Edicron is distributing their products. JJ's KT88S first appeared in 1996. We got two early samples from Terry Buddingh of



*Sovtek 6550WA, Sovtek 6550WE and Svetlana 6550C*

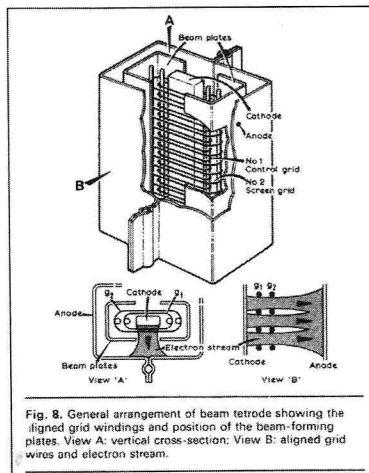

Fig. 8. General arrangement of beam tetrode showing the aligned grid windings and position of the beam-forming plates. View A: vertical cross-section; View B: aligned grid wires and electron stream.

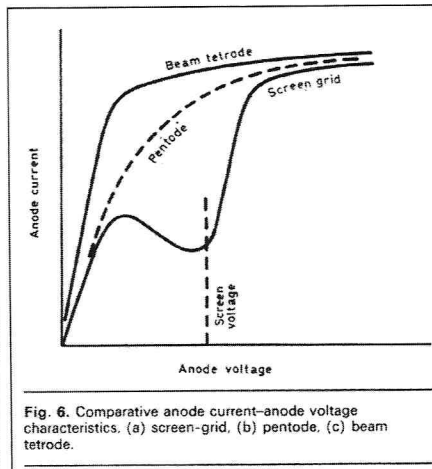

Fig. 6. Comparative anode current-anode voltage characteristics. (a) screen-grid, (b) pentode, (c) beam tetrode.

*Kinkless (Beam) tetrode: electrode structure and valve characteristic.*

*Guitar Player* magazine. These both had Groove Tube logos, which is not surprising as GT's Aspen Pittman WAS a part-investor in JJ (no longer). The KT88s did well in my 500v pentode test, and I ran one at 100 mA without any problems at all. This level of dissipation might be death to a Shuguang tube, and most other 6550s would show red spots on their plates. As originally introduced, it was claimed to have a plate dissipation rating of 50 watts. However, JJ has since derated their tube to match the original M-OV specs.

The Sovtek 6550, which was sold during 1992 and 1993, was made (briefly) by Svetlana. Reflector later produced another 6550 and KT88, and is now making a creditable copy of the Tung-Sol 6550. (We were unable to test these

tubes, as the original apparatus is no longer available.) Reflector's overall quality has improved dramatically in the last 2 years.

#### 4. NOS and the future

Real M-OV KT88s are very, VERY hot on the market. It's gotten much worse since our original report appeared. Factory-matched pairs, recognizable by the yellowed paper band around both cartons, can bring \$1500 in the USA. As we keep advising you, this cannot decrease. Few things annoy us more than the arrogant owners of giant Audio Research or VTL power amps, who casually demand that VTV sell them a set of 24 original KT88s--matched to within 0.1%. Such sets are no longer possible. Nor is such close matching even physically possible.

You have a better chance of hitching a ride on an alien spaceship, friend. Rumors abound that an M-OV licensee in the UK, partly supported by Charles Whitener's Western Electric, will start making "real" KT88s again soon. I've heard this for several years now, so one can only hope.

#### 5. Outro

The 6550 and KT88 will be available for the conceivable future. For your information, the 6550/KT88 market may be as big now as it was in the 1950s. My best indications are that the world is now consuming as many as 200,000 of these tubes annually--and a single amp manufacturer, Audio Research, accounts for perhaps one-third of this total. Remember that in the golden age of tube hi-fi, audio

tubes were a tiny fraction of total sales for factories. They made far more money from sales of boring TV tubes such as the 6BG6 and 6GH8--the latter was being consumed at a rate of more than 5 million tubes per MONTH by world markets. Such levels dwarfed the sales of hi-fi power tetrodes. However, hi-fi was a "status" market, and was seen as an opportunity to pump up the public images of makers. This is where the "Gold Lion" brand came from originally.

#### Acknowledgements

Thanks to John and Charlie for most of the old 6550 and KT88 samples, and to Terry Buddingh for the Sylvania's and Teslas. Also thanks to Svetlana/PM of America and Antique Electronic Supply for some sample tubes. Enormous thanks to Barry Vyse, author of *The Saga of Marconi-Osram Valve Co.* and to V. Howard Smith, past Technical Director of M-OV for valuable insights into the origin of the KT88. Historical data on audio tubes is always difficult to obtain, since these types were of little importance to the industry.





# The Contest for High Fidelity: Western Electric vs RCA

## Part 2

By Scott Frankland ©2002 All Rights Reserved

### Foreward

In Part 1 of this series (VTV issue 18) I gave an overview of the topics to be covered in the installments to follow. With this, Part 2, I begin to focus on the roots of the rivalry between RCA and Western Electric. In writing this history, my focus has been on the seminal events leading to the development of high fidelity in America; and, more specifically, to the decisive roles of RCA and Western Electric in pioneering and promoting that development. Everything else has, for the sake of clarity, been omitted.

In all cases where disputed material is concerned, I have been careful to cite references bearing on both sides of the issue. Unfortunately, there exists a great deal of bias either for or against Western Electric and RCA in the literature,



*Fig. 1. De Forest contemplating his 4-stage amplifier in 1913.*

with certain notable exceptions. It is my hope that this series will prove to be among the latter.

Finally, I have tried to list in the various references, all the important books and papers bearing upon the narrative. My choice of which references to include is based on my best efforts to identify them, and I would be grateful to any reader who can “fill in the blanks.”

### 1. Corporate Motives for Tube Research

In tracing the origins of the vacuum tube, one of the most fruitful questions one can ask is: “For what purpose

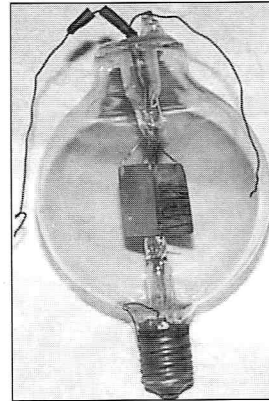

*Fig. 2. A de Forest audion in its virgin state.*

was it invented?” For Lee de Forest, that purpose was mainly detection of radio signals. Amplification, on the other hand, proved elusive for de Forest [1,2].

Although important steps toward amplification were provided by de Forest during the years 1906–1912 (Fig. 1), his “Audion” (three-element tube) proved to be a gaseous device with erratic characteristics (Fig. 2). The tube that de Forest invented was nonetheless interesting enough to the Telephone Company to induce them to buy the rights and expend vast resources on its development [1]. Meanwhile, GE hoped to circumvent the de Forest patent by developing a high-vacuum tube that would stand up in court as a newly patentable entity.

Even though the basic invention of the triode marks the turning point of a new era in electronics, the advent of high vacuum proved critical in forging the transition from the acoustic to the electronic era in audio [1–6]. The key application in this regard was *amplification*.

Of course, when the high-vacuum tube emerged simultaneously from the GE and Western Electric research labs in the spring of 1913, there was no thought of developing amplifiers for entertainment purposes. The initial impetus was *telecom*—i.e., voice communications via telephony and wireless—and that is what directed the respective tube groups in their development work.

Both companies badly needed the tube for their telecom projects. Faced with a land-based cable monopoly by the Telephone Company, GE chose to compete in the more rarified arena of wireless communications [1,4]. GE’s interest in wireless had been sparked by their association with Fessenden beginning circa 1900. Given this association, and their background in AC power generation, it was a natural step for GE to adapt the alternator as a generator

for carrier signals. Their research accordingly centered upon a tube sufficiently powerful for use as a modulator in the Alexanderson alternator system [1,4,5].

The Bell Telephone Company did not immediately pursue wireless, but instead focused on completing their Transcontinental Telephone Line—"a crowning achievement of 40 years of development in transmission over wires" [3]. The difficulty in achieving long-distance telephony was apparent from the start. Due to the accumulated resistance of long copper wires, coast-to-coast dialogue could not be sustained at audible levels due to attenuation of audio signals in the copper.

With the advent of the high-vacuum tube, however, speech currents could be boosted at discrete points along the line by "repeater" amps, thereby overcoming the copper losses. This was the breakthrough for which the Telephone Company had been struggling in their quest for "universal service."

Like a Monarch butterfly from its cocoon, the high-vacuum tube emerged from the research labs of GE and Western Electric within a single year's time. The men responsible were barely out of school, most of them, and just starting their careers in industry. In this light, their accomplishment seems almost a miracle, considering that high vacuum had been in development since the 18th century [1,15].

But what at first glance seems miraculous turns out in hindsight to be the payoff for a bold business stratagem. H.J. van der Bijl of Western Electric observed of the tube as it was received from de Forest:

*"As the result of a far-sighted policy based on the recognition of the influence of scientific research on industrial development, the fate of this device was placed in the hands of a number of well-trained research physicists and engineers [6]."*

When van der Bijl speaks of "scientific research," he refers to fundamental research in a new "industrial" sense. This is research into underlying principles of nature directed in areas deemed to have potential for future technology. This approach differed from that of traditional inventors, in that specialized training became an essential prerequisite for successful research. An experimental bent was no longer enough to produce new technology. Analysis and theory now came to play an essential role in the emerging battle against complexity.

## 2. Demise of the "Invention Factory"

Prior to 1900 the needs of American industry had been largely met by visionary inventors working expressly to create basic forms of new technology [7,8]. The names of Morse, Bell, and Edison spring immediately to mind. The discovery and explication of underlying principles played little or no role in their research methodology [7-14]. The famous "Edison effect" was an accidental discovery that Edison could not explain.

Edison's focus, however, was not on principles of nature but on patentable results. "I have little room for the purely aesthetic side of my work," he said [8]. Edison called his Menlo Park workshop the "Invention Factory." The monicker was less hype than fact: Edison logged over 1000 patents in his lifetime. Few inventors have achieved even half that number. The Edisonian brand of scientific pragmatism permeated American industry prior to 1900 [7-14].

Charles Steinmetz, however, believed that a different approach was possible; and that this approach could be used by industry to compete with naturally-gifted inventors. At GE, Steinmetz proposed to leverage discoveries made by in-house scientists working at ever deeper levels of specialization [7,8,14]. The most productive scientists were to be accorded the utmost independence to pursue whatever paths of discovery they might deem fruitful.

The scientific approach to product development was in pronounced contrast to that of Edison, who occasionally hired academic scientists as consultants, but insisted that their work serve the immediate needs of his commercial projects:

*"We can't be like those old German professors who, as long as they can get their black bread and beer, are content to spend their whole lives studying the fuzz on a bee [8]."*

Edison here refers to pure scientists, such as Max Planck of the University of Berlin, whose driving interest was in discovering those fundamental aspects of nature that might one day lead to a "unified world picture." Edison was Planck's opposite number. He always thought of himself as "an inventor and nothing more" [16].

This modest self-assessment is belied by Edison's contribution to modern life: it was the Edison lamp (1879) that provided the impetus to bring electric power into the home; and it was Edison's power distribution system (1882) that made it work. Edison Electric's 27-ton "Jumbo dynamos" could each supply 100kW (enough for 1200 lamps).

Unfortunately for Edison, his DC power system flowed down a blind alley, and Edison Electric along with it. In retrospect, Edison's biggest mistake was to ignore Nikola Tesla, his onetime employee, who advised him to abort DC and convert to AC in virtue of its transformability.

George Westinghouse, however, did *not* fail to heed Tesla's advice. Westinghouse hired Tesla to develop AC power sources, purchased his patents, and challenged the Edison empire. The ensuing failure of Edison's DC power system took a punishing toll on Edison's reputation as a technological visionary. Within ten years the writing was on the wall: DC was dead, and Edison was bought out by his own board.

Following a merger with Thomson-Houston Electric

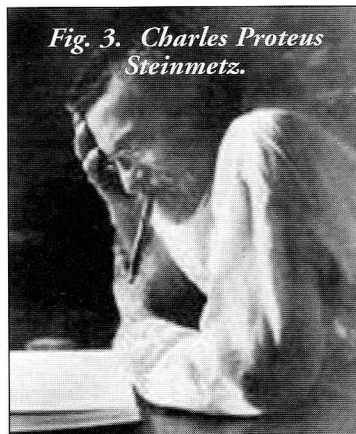

Fig. 3. Charles Proteus Steinmetz.

(1892), the newly formed General Electric Company (GE) placed Edison in a more or less advisory position, and turned to Elihu Thompson for future direction. Like Tesla, Thomson held key inventions relating to AC power generation. (Thomson held nearly 700 patents when he died in 1937.)

GE's new management, however, proved no more interested in pure science than Edison had been [7,8]. Like its rival, Westinghouse, GE sought to acquire new technology by brute force: purchasing patents and "leasing" the short-term consulting services of proven inventors like Edison, Fessenden, and Tesla. The idea of growing technology in-house on a Petri dish seemed too risky a concept in 1892.

Steinmetz, however, questioned the ongoing approach to new technology. He correctly foresaw that *basic research* would provide the best insurance against the natural genius of independent inventors. After emigrating from Germany, Steinmetz (Fig. 3, p.10) began promoting basic research at GE [7,8,14]. For three years (1897–1900) Steinmetz lobbied upper management with no success.

### 3. Industrial Research Comes of Age

Basic research, entailing as it does the discovery of nature's secrets, likewise entails extraordinary expense. At both GE and Western Electric, pure science proved difficult to push past management, as there was no track record at either company and very little precedent elsewhere. Worse, few in upper management understood what was meant by "fundamental knowledge," or what it might lead to in the long run. To their way of thinking, the patents they already controlled were adequate insurance against interlopers [3,8].

This complacent attitude was shattered at GE by mortal competition from Germany circa 1900 [7,8]. Edison's carbon filament had initially given GE an iron-clad control over the lamp market. Michael Eckert and Helmut Schubert describe the German response to the Edison carbon-filament:

*"The research laboratory of the Siemens works grew out of a small physics and chemistry laboratory housed in a makeshift building (referred to locally as a 'doctor dungeon') in Berlin-Siemensstadt. Its beginnings extend back to the last years of the 19th century, when the chemist W. Bolton was looking for materials to replace the delicate carbon filaments of the Edison light bulb. Edison's method of searching around the world for better materials was recognized as not the best way to attack the problem. In the Laboratory of Physics and*



**Fig. 4. Walther Hermann Nernst, Nobel laureate, teacher of Langmuir**

*Chemistry at the Siemens plant, Bolton worked his way systematically through the Periodic Table of the elements looking for a material which would show at the same time a high melting point and a vapor pressure that was as low as possible. Tantalum seemed like the most suitable metal, but up to that time it was known only as a powder oxide. After years of work, tantalum filaments were successfully produced, which assured the firm of competitive advantages for some years [13]."*

In 1897, Walther Nernst (Fig. 4) patented an electric lamp with an exotic, rare-earth filament consisting of zirconium oxide, yttrium oxide, and erbium oxide at a ratio of 90:7:3 (Fig. 5, p.11). Nernst, trained as a pure scientist, developed this filament at his physical-chemistry lab in Göttingen,

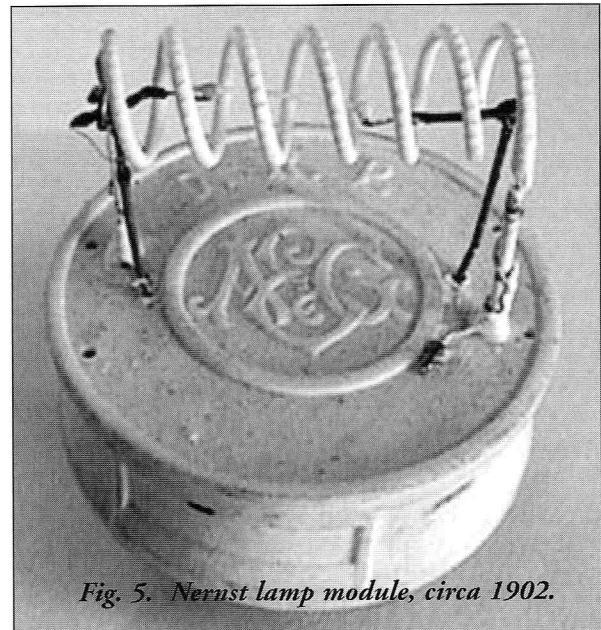

**Fig. 5. Nernst lamp module, circa 1902.**

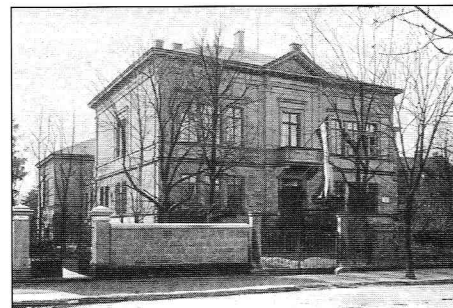

**Fig. 6. The Göttingen Physical Chemistry Institute, a materials research facility founded by Walther Nernst in 1895.**

Germany (Fig. 6, p.11) [19]. Eckert and Schubert explain the trend toward applied research in Germany:

*"Research at the new 'applied' institutes typically was concerned with the border areas between purely scientific and purely technical disciplines (e.g., electrochemistry, electro metallurgy, stress analysis, hydrodynamics, aerodynamics, and the theory and application of magnetism). The overlap of long-separated disciplines (physics at universities and technology at institutes of technology) was the consequence of science, economics, and government coming closer together [13]."*

The Nernst lamp created a great wave of foreboding at GE, as it required no vacuum and was 50% more efficient than the Edison/GE carbon-filament lamp [7,8]. In 1898, Nernst sold patent rights to the German electrical giant AEG, an act worrisome to GE, as AEG already possessed rights to the Edison lamp (in Germany).

Moreover, Nernst sold patent rights to GE's most feared rival in America, Westinghouse [16]. The noose tightened when Westinghouse built a 100,000-square-foot factory in Pittsburgh for the purpose of manufacturing "Nernst Glowers" [19].

There were other competitors besides Nernst: another high-tech filament was developed by von Welsbach, the German chemist. Von Welsbach excelled in the field of rare earths. Eckert and Schubert outline the emerging pattern of cooperation among German scientists, industry, and government that quickly led to new technologies:

*"The pattern of interaction can be described briefly as follows: industry spent money, the government created recognition and new positions for researchers, and science became oriented in the direction of applications. In Germany this pattern became the model for support societies and organizations in the 20th*

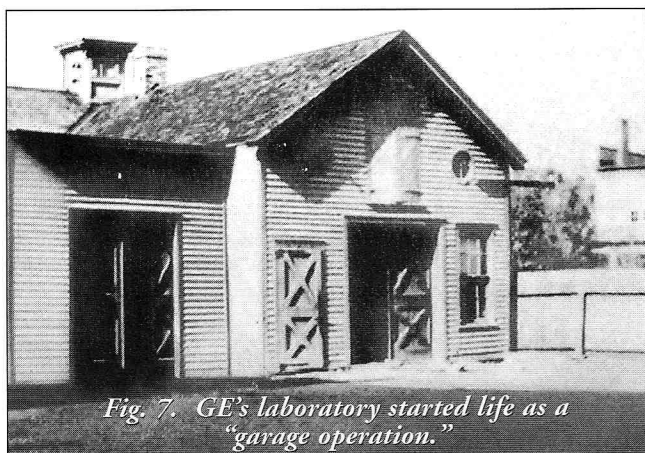

*Fig. 7. GE's laboratory started life as a "garage operation."*

*century (e.g., the Kaiser Wilhelm Society), where interdisciplinary research could be carried out on a large scale [13]."*

Prior to WWI, government support was lacking in America, and private industry was just plain skeptical [8]. The result was a pronounced technological lag behind Germany. After numerous rejections by GE's top brass, the decision to proceed with the Steinmetz plan was finally approved in 1900. It was decided to set up a provisional

laboratory in Steinmetz's carriage barn (Fig. 7). Attention then focused on a suitable director for the new "lab."

Steinmetz knew that in order to compete with the new German lamp technology, some extraordinary fundamental discovery in electrochemistry would be needed [7,8]. Steinmetz outlined his requirements in a letter to management:

*"The laboratory would require a good, well-paid practical chemist of considerable originality, able to follow and work out independently any suggestions that might be made. He should have a fair knowledge of electricity and general physics, be well familiar with glass blowing, and possess somewhat pronounced administrative abilities [8]."*

Steinmetz and his supporters in management (Thomson in particular) soon zeroed-in on a rising star at MIT: the young chemist Willis Whitney. Whitney's scientific training was undeniably first-rate [8,20]: after graduating from MIT with a BS in chemistry, Whitney received doctoral training in Germany under physical chemist Wilhelm Ostwald, a key mentor of Nernst. After further study at the Sorbonne, Whitney returned to MIT to teach chemistry. Whitney was as well-equipped as anyone to plumb nature's secrets. Although Steinmetz endorsed the effort to lure Whitney to GE, Whitney at first demurred. In later days, recalling his scruples with characteristic flair, Whitney would write:

*"When I was first tempted to leave a teaching position at Boston Tech [MIT] I thought I was deciding between working for myself and others by teaching and research, or burying my possible individuality in a large soulless industry [16,17]."*

George Wise explains how Whitney transformed a condescending attitude toward industry—an attitude commonly shared by academic scientists—into a working environment conducive to both innovation and research:

*"This laboratory succeeded because it created a new role for professional scientists—a blend of research freedom and practical usefulness not available before 1900 [16]."*

#### 4. GE's First Breakthrough

Whitney's first assignment was to attack the lamp problem and stave off the German lamp threat. His first experiments involved mercury-vapor glow tubes. These, however, proved unsatisfactory as lamps. With everything on the line, Whitney then performed a small miracle: he crowned the carbon era of incandescent lamps—by metallizing the Edison filament [8]. His GEM lamp, introduced in 1904, sold in the millions and gained Whitney and the Laboratory—until then an experiment in process—a vital reprieve.

GE's big breakthrough, however, did not come until after William Coolidge and Irving Langmuir joined the lab some five years later. In the meantime, Whitney helped GE develop a process for baking resistors [16]. He also began to implement the Steinmetz program, putting his own stamp on the deal by creating an environment in which his new recruits, Coolidge and Langmuir, could thrive. Whitney's approach was the antithesis of a structured, bureaucratic management style. George Wise com-

ments on Whitney's management style:

*"Whitney had little use for councils, or committees, or indeed, for the democratic process at all. He admitted to an elitism based, not on assumptions of class or hereditary superiority, but simply on the belief that only individuals could accomplish anything. 'A democracy does not appeal to me where high quality is the aim,' he wrote. 'Certainly in the matter of discovery and experimental work we find that committees cannot invent, and responsibility divided is as good as shifted' [8]."*



*Fig. 8. The GE Research Laboratory (left) added a development building (right) in 1925.*

Whitney was of course hugely successful with this approach. The surprise development of ductile tungsten by Coolidge (1910), together with the gas-filled lamp by Langmuir (circa 1912), overturned the German lamp threat, leaving GE in control of the US lamp market [7,8,20]. This favorable position provided ample financial means to ensure leeway in the GE research department for a certain amount of ongoing pure research. As a result, in 1914 the Steinmetz/Whitney program found a permanent home at GE (Fig. 8), and the way was open for an extended onslaught upon the problems of vacuum tubes and their circuits.

Leonard Reich sums up the transition from random invention to specialized research as the preferred weapon against technical complexity:

*"Although engineer-entrepreneurs such as Thomas Edison and Frank Sprague had made major contributions to industry, even they now began to find that the increasing complexity of technology required research into underlying principles. Those who, like Edison, could not or would not make the transition usually fell behind. The path to technical development and, ultimately, corporate security seemed to lie in the synthesis of scientific knowledge and methods with engineering know-how [7]."*

Daniel Kevles explains what became of the Edison approach:

*"As early as 1886, Electrical World fittingly declared: 'The day of rule-of-thumb methods has gone by.' A few years later, an assistant asked Edison for some technical advice, and the inventor brusquely told him to consult one of the mathematically adept members of the staff. 'He knows far more about [electricity] than I do. In fact, I've come to the conclusion that I never did know anything about it'. Edison, who had*

*opposed the introduction of alternating current, sold his interests to J.P. Morgan's new combine, the General Electric Company, and left the light and power business for good. General Electric relied for technical advice on a German immigrant with advanced training in physics, Charles Proteus Steinmetz [21]."*

Judging purely by results, there can be no doubt that GE and Western Electric were consistently successful in their attack on technical complexity. The key to their consistency turns out to have four sides: (1) the recruitment into industry of formally trained specialists—especially in chemistry, physics, pure analysis, and materials science; (2) the establishment of in-house research laboratories catering to the psychological profile of scientists; (3) the use of interdisciplinary research teams to discover the underlying principles related to specific technologies; and (4) the cooperation of research teams and engineers to fashion new products out of newly discovered principles.

The synthesis of science and engineering as pioneered by GE and Western Electric proved to be a potent combination that put technological innovation on a systematic basis in America. In retrospect, what began to standardize circa 1914, is the modern concept of R & D. This was a combination of research and development that has become the standard model for American industry. Virtually everything we know as "modern technology" has come about because of it—from the high-vacuum tube to the wireless internet. All within the frame of 88 years, the potential lifespan of a single human being.

*To be continued.*

## References

- [1] Gerald F.J. Tyne, *Saga of the Vacuum Tube*, © 1977, Third Printing 1994, Prompt Publications, Tempe, AZ.
- [2] Lillian Hoddeson, "The Emergence of Basic Research in the Bell Telephone System, 1875-1915," *Tech. and Cult.*, 22, 1981, pp. 512-544.
- [3] Fagen, M.D., ed., *A History of Engineering and Science in the Bell System, the Early Years (1875-1925)*, Bell Telephone Laboratories, Inc., 1975.
- [4] Hugh G.J. Aitken, *The Continuous Wave: Technology and American Radio, 1900-1932*, Princeton University Press, Princeton NJ, 1985.
- [5] Leonard S. Reich, "Irving Langmuir and the Pursuit of Science and Technology in the Corporate Environment," *Tech. and Cult.*, 24, 1983, pp. 199-221.
- [6] H.J. van der Bijl, *Theory of the Thermionic Tube and Its Applications*, McGraw-Hill, NY, 1920.
- [7] Leonard S. Reich, *The Making of American Industrial Research*, Cambridge University Press, Cambridge, 1985.
- [8] George Wise, *Willis R. Whitney, General Electric, and the Origins of U.S. Industrial Research*, Columbia University Press, NY, 1985.
- [9] David C. Mowery and Nathan Rosenberg, *Technology and the Pursuit of Economic Growth*, Cambridge University Press, Cambridge, 1989.
- [10] Mark J. de Vries, "Innovations and Technology Education," Proc. PATT-10 Conf., Apr 4-5, 2000.
- [11] W. Rupert MacLaurin and R. Joyce Harman, *Invention and Innovation in the Radio Industry*, Macmillan Co., NY, 1949.
- [12] Harold Vagtborg, *Research and American Industrial Development*, Pergamon Press, NY, 1976.

[13] Michael Eckert and Helmut Schubert, *Crystals, Electrons, Transistors: From Scholar's Study to Industrial Research*, American Institute of Physics, NY, 1990.

[14] GE, "Our History—Leaders Through the Years," © 1997-2001, [http://www.ge.com/news/exec\\_office/bio\\_ew\\_rice.htm](http://www.ge.com/news/exec_office/bio_ew_rice.htm).

[15] David L. Anderson, *The Discovery of the Electron*, Van Nostrand Reinhold Co., NY, 1964.

[16] George Wise, "A New Role for Professional Scientists in Industry: Industrial Research at General Electric, 1900-1916," *Tech. and Cult.*, 21, 1980, pp. 408-429.

[17] Willis R. Whitney, "Cooperation and Corporations," *GE Rev.* 32, 1929, pp. 133-136.

[18] Robert Rosenberg, "American Physics and the Origins of Electrical Engineering," *Phys. Today*, Oct 1983.

[19] Walther Nernst Memorial Site, <http://www.nernst.de/>.

[20] Laurence A. Hawkins, *Adventure into the Unknown*, The First Fifty Years of the GE Research Laboratory, Wm. Morrow & Co., NY, 1950.

[21] Daniel J. Kevles, *The Physicists*, Alfred A. Knopf, NY, 1978.

#### Footnotes

1 According to Lloyd Espenschied of the Telephone Company, de Forest learned the technique of grid bias from Fritz Loewenstein [2,3].

2 Fagen (et al) comments on the basic elements of the transcontinental line: Most of this New York-San Francisco line was built of No. 8 (BWG) copper (diameter about 1/6 inch), weighing 870 pounds per loop mile. Supported on 130,000 poles, the weight of copper in the line totaled 2,500 tons. Loading coils were placed every 8 miles, and the line was provided with three 2-way vacuum tube repeaters. Early in 1915 three more repeater points were added, and in 1918 two more for a total of eight [3].

3 The Edison effect apparently had little or no influence on the course of electron theory per se [15]. Edison's discovery nonetheless had a profound influence on engineers and inventors.

4 Steinmetz was promoting in America what he had seen work so effectively in German industry [7,13]. Steinmetz became head of the Calculating Department at GE, and was GE's chief consulting engineer. He excelled in alternating current calculations, and his work put AC power distribution on a quantitative basis. In 1901 Steinmetz was elected president of the AIEE, the foremost society for power engineers in America.

#### Figure Credits

Fig. 1. Source: Lee de Forest, Father of radio: *The Autobiography of Lee De Forest*, Wilcox & Follett, Chicago, 1950.

Fig. 2. Source: Kilokat's Antique Light Bulb and Vacuum Tube Site, <http://www.bulbcollector.com/>.

Fig. 3. Source: Bill Bottorff, MultiMedia Timeline, <http://www.ausbcomp.com/~bbott/wik/mmtimeln.htm>.

Fig. 4. Source: Walther Nernst Memorial, <http://www.nernst.de/>.

Fig. 5. Source: Landesmuseum fur Technik und Arbeit in Mannheim, <http://www.landmuseum-mannheim.de/Lta-Web-Text/nernstlampe/index.htm>.

Fig. 6. Source: Walther Nernst Memorial, <http://www.nernst.de/>.

Fig. 7. Source: Laurence A. Hawkins, *Adventure into the Unknown*, The First Fifty Years of the GE Research Laboratory, Wm. Morrow & Co., NY, 1950, p. 6. [Steve]

Fig. 8. Source: Laurence A. Hawkins, *Adventure into the Unknown*, The First Fifty Years of the GE Research Laboratory, Wm. Morrow & Co., NY, 1950, p.84. [Steve]

# Why NOS Tubes Are Better

By Eric Barbour ©2003 All Rights Reserved

Since our NOS price article in the last issue, we've gotten some feedback claiming that VTV is "hyping" certain tubes in order to profit by selling off a huge NOS stash. Since there is so much bizarre voodoo surrounding the demand for certain scarcities, perhaps this would be a good time to discuss some hard facts, and help to shine a light into the dark hole of NOS elitism.

The basic question is, why are NOS tubes better than current production? After all, haven't scientific practices and technology improved? They have--but not in the tube market. Tube audio is more of an arcane hobbyist field than a proper industry. The dealers of such tubes tend to be either individuals or small companies. This does not lend itself toward the improvement of the product in general. Only competition forces tube factories to improve their product. And more important, attitudes have changed over the years. Let's look at some hard, verifiable technical facts that directly influence the sound of audio tubes.

## 1. Cathodes

One major contributor to the sound of an audio tube is the ability of its cathode to emit electrons, especially when asked to handle transients. An oxide cathode is made of nickel alloy tubing, coated with a powder made of barium and strontium (and sometimes calcium) carbonates, plus a witch's brew of binders, emulsifiers, stabilizers and other ingredients. The cathode is installed in the tube, which is pumped to a high vacuum while an induction coil heats the entire tube structure to orange heat. This bakes the cathode coating, driving off the carbon and resulting in a fine powdered surface of barium/strontium oxides plus a few inorganic salts. Only then is the cathode "activated," ready to emit copious quantities of electrons. Everything in this recipe affects the final emission performance of the cathode, especially the specific mix of chemicals in the initial coating. For example, silicates must be kept to levels below 100 ppm, because barium silicate ions will migrate to the surface of the coating and poison emission, resulting in high plate resistance and low transconductance.

The presence of certain solvents in the vacuum system can also damage the coating during activation. Even the composition of the tubing is critical--activators are often added to the alloy, which is commonly nickel with cobalt, zirconium and a small amount of tungsten.

Reducing elements such as carbon and manganese can poison emission, yet in small quantities they remove destructive oxygen from the nickel melt; and the presence of iron particles in the tubing or the coating must be avoided at all costs. Aluminum in the tubing can cause the oxide coating to peel off.

Building a really good cathode requires reagent-grade chemicals, in just the right proportions. In the "good old days", manufacturers cared so much that they paid extra for high-purity ingredients. Companies such as Western Electric, International Nickel, Superior Tube, and Driver-Harris made cathode assemblies to very high standards of purity. This situation no longer applies, as audio tubes must compete in a market filling up with solid-state tube simulators. The few remaining tube factories must make their own cathodes in-house from whatever industrial-grade chemicals they can buy in China and Russia (If a supplier put rock salt in the barium carbonate to save a few rubles or yen). Or else they must place huge (and costly) quantity orders with tubing manufacturers, who are no longer interested in such a small industry.

Furthermore, lifetime can be improved by special treatments. One that was discovered long ago was to apply an extra overcoat of magnesium carbonate to the carbonate coating before tube assembly. The resulting magnesium oxide increased the life of the alkali electron-emission layer, by a chemical reaction which remains poorly understood to this day. Such extra steps are no longer followed by tube manufacturers, due to the endless cost pressures exerted by their large OEM customers. Even the purity of cathode coatings has been compromised by current manufacturers, under pressure to keep costs down. And vacuum "hardness" is another factor which can be traded off during manufacture to allow higher production rates, while decreasing lifespan of the cathode coating. Bombardment by free oxygen or nitrogen slowly harms emitter materials.

Eimac recently considered the discontinuance of one of their most popular RF power tubes, the 3CX800A7. This type is used daily by amateur-radio operators worldwide. Unfortunately, it uses a complex cathode with alternating stripes of oxide and bare metal, aligned with the grid wires. This scheme is costly and difficult to make, and improves the performance of the tube several percent. As if the modern ham cared. Even though the 3CX800A7 is a costly tube to make, it's still much cheaper (to buy and to use) than transistor RF power amps. Yet transistor linear amps continue to make inroads in the marketplace.

Only pressure from the makers of amateur-radio linear amps and the U.S. government saved the product from

extinction. This incident reveals the modern attitude, that the cheapening of the product is inevitable, so submit to it.

## 2. Quality Control

Today's middle-aged audio buyer does not have the morality standards that his father or grandfather endured. So, he fails to understand the motivations of manufacturers of consumer goods of the 1950s. It was routine, at that time, to deliver more than the usual, expected level of construction quality, because the firm was usually owner-operated, rather than being a small division in a huge public conglomerate. That owner considered himself a good person, and suffered sleepless nights if he skimmed on chassis metal thickness or hardware. Things were meant to last, and it was expected. Such attitudes no longer burden the operators of consumer electronics manufacturers. Generations of consumers have become inured to stereo receivers made of paper-thin sheet steel and molded polystyrene and having digital FM front ends with poor sensitivity and inferior image rejection. So a Fisher 500C--such a common thing at one time, and built by the boatload--is a revelation to people under 50.

So it is with tube manufacture. All present-day tube factories are pressured by their largest customers, which are not you, the end-user.

Amplifier builders such as Fender, Marshall, Audio Research and McIntosh have enormous clout with tube makers. These builders usually want to see a low price, foremost. In fact, some threaten to go to solid-state designs if tube factories raise their quantity pricing.

Pressure to keep prices low is not conducive to the manufacture of extended-life and high quality 300Bs or KT88s with time-consuming rock-hard vacuum and expensive reagent grade cathode chemicals. Cheaper import tubes have issues with either quality, sonics and/or reliability. We have found that high quality, genuine NOS tubes last longer, sound pleasing and can be more reliable, but not always. Be sure to buy from a reputable dealer who backs his product with a warranty for highest quality.

The winding of grids is a good example. It is done with a lathe, designed especially for the job. Both the construction of the lathe, and the winding of the grid wires, requires the holding of mechanical tolerances to 0.00005 inches (50 microns) or better. This is routinely done in aerospace work, where the profit margins are substantial and government contracts run for many years.

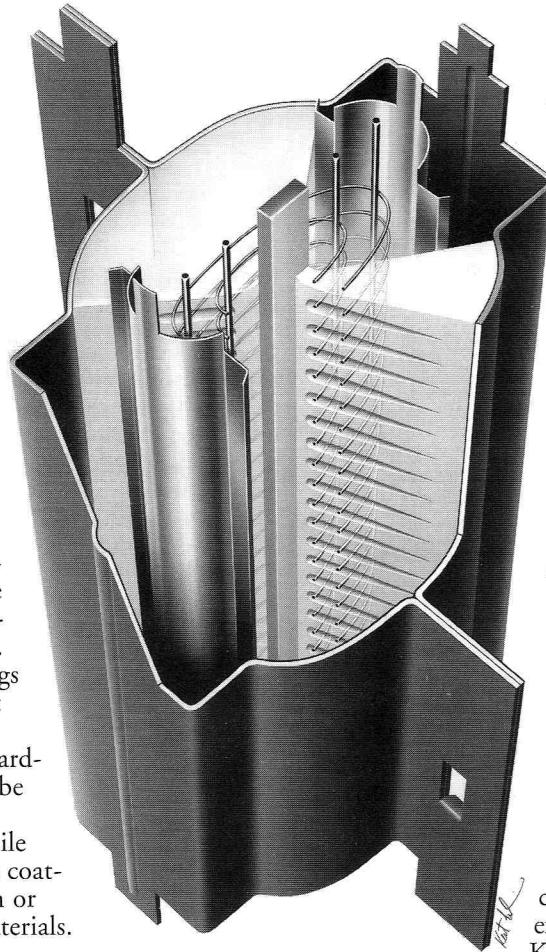

Unfortunately, tube manufacture today is on the short end of the economic stick, and barely surviving. Most factories are using battered old Soviet equipment from the 1960s, whose tolerances do not improve with time and use.

And tricks which contributed to low distortion in audio-specific tubes have been forgotten, as the rush to a price-sensitive market proceeds. Back in the 1920s, engineers at RCA discovered that if they wound the grid of a medium-mu triode so that each end was the exact mirror-image of the other, with the grid wire terminated in the same manner, the tube's distortion would be minimized further. This is considered a "fringing" effect, and not usually addressed in calculations of electron ballistics--yet it does affect the tube's performance. Such details do not usually receive attention today.

Take the grids out of some WWII-era 6SN7Ws and grids from current low-cost Russian-made 6SN7s. Examine multiple samples under a 25x microscope. You'd be surprised how rough the new grid looks, and how randomly the winding wire is terminated, compared to the old grid. This affects the distortion of the tube, as well as its transient response. And what happened to the wisdom of RCA's engineers? Most of it was left in old file cabinets when they vacated the Harrison plant in 1977. And local unemployed youths made bonfires out of it.

## Jolida JD3000

### 200 Watts of Triode Ecstasy



**Available From: VACUUM TUBE VALLEY**  
 P.O. Box 1499 Lakeport, CA 95453 USA  
 Phone (707) 263-5881 FAX (707) 263-7648

[www.vacuumtube.com](http://www.vacuumtube.com)

### 3. Attitudes

I cannot finish an article about NOS tubes and their image of divine superiority without discussing the typical consumer of such tubes--the perfectionist audiophile and the older guitarist. I am talking about a demographic which, in spite of their high personal incomes, most marketing people would regard as "hopeless." Advertisers prefer to pursue the white male 14-25 demographic, since endless research has shown that young men have not yet formed strong opinions and is easily influenced by subliminal advertising campaigns.

The perfectionist audiophile/older guitarist group, however, is almost entirely white (and, increasingly, Asian), male, and between 40 and 60 years. This perfectionist NOS-tube enthusiast is also a college-educated professional, though rarely in the fields of acoustics or electronics. Indeed, in our experience, the stereotype of an audiophile is a financial analyst, M.D. or attorney, whose actual knowledge of acoustics or electronics is limited. He reads *Stereophile* and *The Absolute Sound*, and believes them to be unbiased publications in spite of their "advertiser friendly" alliances.

"Sam Tellig's" column in *Stereophile* as a good example. Sam (which is NOT his real name, as all but his fans seem to know by now) writes a homey, chatty, and completely unfocused column each month. He does not bore his fan base with technical facts about the equipment he recommends, preferring instead to blather about the excellent Sonoma Chardonnay and feta-cheese salad he consumed while listening to a pair of \$60,000 speakers.

This *Wine Spectator* kind of chatter is proven to work miracles in wooing the "haute lifestyle" crowd. He knows well that his readers are shallow, materialistic, and possessed of short attention spans, in spite of their education, affluence and age. So he plays to the snobby cork-sniffing,

### STEREO TUBE AMP KIT \$139.95\*

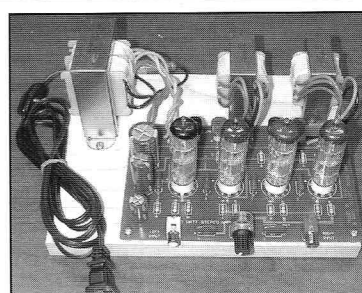

**ALL TUBE DESIGN RIVALS SOUND  
 OF \$1000 HIGH END AMPLIFIERS**

- **Power Output:** 8 Watts per channel
- **Frequency Response:** 20 TO 20 kHz
- **Distortion:** Less than 1% at 1 Watt
- **Input Impedance:** 100K Ohms
- **Output Impedance:** 8 Ohms
- **Minimum Input:** 0.4 V for full output

Uses type 11M58 tubes included in kit with circuit board, base board and all parts, including transformers, power cord, etc. Easy to follow instructions.

\*Assembled and tested \$169.95.  
 Add \$10 for shipping and handling.

**S-5 ELECTRONICS**  
 1625 Twin Acres, Chandler, AZ 85249  
 Phone: 480-895-2521 Fax: 480-895-4164



status-obsessed midlife-crisis boys and they lap it up.

Just as important is the susceptibility of your average NOS nerd to tube mystique. And much of the arcane mystique of NOS tubes originated in Japan, in the pages of magazines such as *MJ*, *Stereo Sound*, and *Radio Gyjutsu*. During the 1980s it was common to see *MJ* articles which closely dissected the design of a homebrew amp, with distortion and other performance specs presented in detail. So, the Japanese hobbyists slowly learned this simple fact: that the quality of audio tubes has declined since the 1960s. And they found, and presented, proof of it. Wannabes and latecomers have since added nothing to the body of facts, preferring simply to mumble mystical incantations over NOS Western Electric 300Bs and suchlike. Thereby jacking up the street price. Which collectors, who are also frequently the "journalists" pumping the tube in question, happen to have large personal stashes of. And this is another issue of importance to the NOS market: the ongoing role of underground NOS tube dealers, counterfeits, and eBay. We may examine this in a future issue.

For that matter, claims by some that VTV inflates the prices of certain NOS--in order to sell those same types--are specious. Good examples are the WWII Sylvania VT-231 metal base 6SN7W with green printing on the base, which can sell for \$150 or more. We gave it an excellent rating in issue 11, yet gave a similar rating to the 1950s Raytheon version and the 1952 Mullard CV181. Nobody ever calls VTV and asks for those! Bear in mind that these were blind listening tests.

The same applies to our 12AX7 tests in issue 14. Our rave about the 1950s Raytheon black-plate version did not result in calls for them; guitarists still ask for Mullards and audiophiles still ask for smooth-plate Telefunks, neither of which we have in vast quantities (but wish we did).

Similar results were observed with the EL34 article in issue 16--we don't get calls asking to buy 1991 Teslas. People want what gurus have been snobs about for years. So, some good tubes sell for outrageous prices, while other good tubes languish. The demand is driven by guru pronouncements, not necessarily sound quality. I'd like to be able to claim some power over the NOS market, but can't.

Worse still, the Japanese audiophile is beginning to ape his American imitators, thereby closing the circle of hype. How else to explain the 1998 failure of the reissue WE 300B in the Japan market, in spite of excellent product quality, exquisite packaging, and heavy advertising, plus a large dealer network? All it took was a few comments by the likes of *Stereo Sound* scribbler Tadaatsu Atarashi, who wrote a lengthy screed about the "limpid introspection of tone" in his NOS 300Bs, which the new production was claimed to lack. (We tested both tubes extensively, and found practically no difference between the NOS samples and the new production--in either electrical performance OR sonics. See VTV issues 3 and 8 for 300B tests.) His article had a major impact on the revived Western Electric company, causing the loss of many of their dealers in Japan.

## Klipsch RF-7 Powerful Speakers for Low Powered Amps

By David Bardes ©2003 All Rights Reserved

Many tube enthusiasts reach back to the vintage Klipsch speakers to get the big, dynamic sound they crave. Compared to today's power-hungry speakers, the Heresy, Forte, Chorus and Khorn speakers are an inexpensive sonic salvation. Unlike other speaker manufacturers which have sacrificed high efficiency for small size and cost reduction, Klipsch continues to make efficient speakers that are a great choice for low powered SE and vintage tube amps. Packaged in a contemporary tower design, Klipsch's RF-7 contains all the advantages of their classic speakers and serves them up with extended frequency response, improved resolution, and great imaging that define modern speaker design.

The RF-7 is a two-way tower design. A Tractrix horn-loaded, titanium-dome driver supplies the treble, and two 10" aluminum cones supply the lows and mids. The cones have been anodized on both front and back surfaces, which act as damping layers for the otherwise stiff but ring-prone aluminum. These drivers are crossed over at 2200 Hz using a fourth order Linkwitz-Riley type crossover. A relatively steep crossover was used to control sound dispersion and control "ring modes" in the aluminum cones. Two very large ports occupy the rear of the cabinet. These ports are larger than many other speaker manufacturers use, but are appropriate for the woofer configuration (it is easier and cheaper to use smaller diameter ports at the cost of potential port noise). The cabinet uses veneered MDF, veneered on the inside as well as the outside for improved cabinet damping. My samples were veneered in a beautiful cherry finish. Black ash and a light maple are the other options. Twin sets of binding posts are provided for biwiring and Monster Cable Zwire is used inside the cabinet. Most importantly, they are efficient enough for really low powered amps.

The RF-7s have a clean open sound. The titanium diaphragm provides great treble extension and a clear sound, but the tweeters sound just a bit frosty at first. Once the tweeters break in, the sound opens up to provide a nice image, both wide and deep. I heard real depth and a sense of the large recording venue for Diana Krall's *Besame*. I could distinguish the distance of the different sections of the London Philharmonic from the microphones as they backed up Diana's singing. Violins and violas were clearly delineated. Diana's voice was natural and I could not find a hint of coloration from the tweeter horn.

I thought I had found a weakness in the RF-7s bass performance which I felt was too pronounced and boomy,



*Klipsch RF-7 Speakers*

although the bass extension was impressive. This boominess turned out to be my single ended amp, because when I changed the amp out to David Berning's Micro ZOTL amp, the bass tightened right up and delved even deeper, even though the Micro ZOTL amp is rated at just 1 watt! I played several discs with deep, strong bass (Down to the Bone, Crystal Method, etc.) and the RF-7s were quite impressive. Ron Carter's acoustic bass was deep and visceral while playing his version of Cubano Chant (*When Skies are Gray*, Blue Note). Only a very good subwoofer would provide deeper bass. It may prove that some single ended amps may not have the damping power to get the full measure of bass punch from these speakers despite their high efficiency.

Compared to my beloved Khorns, the RF-7s had far superior imaging, better bass and treble extension, and I

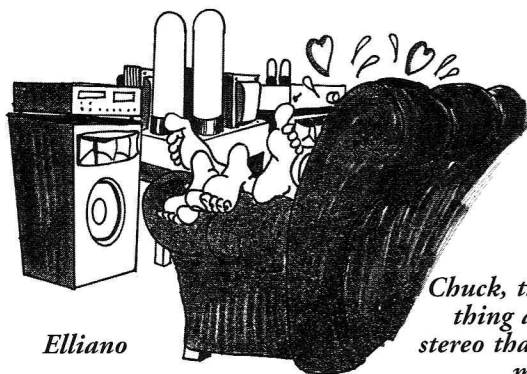

*Elliano*

*Chuck, there is something about your stereo that really turns me on!*

heard details in recordings I hadn't heard through the Khorns. For me this is impressive, as many speakers sound like toys when compared to the Khorns. True, the Khorns still sounded bigger, but this is a warm fuzzy big, and not the focused image that the RF-7s convey. And if anything, the RF-7s could produce a punchier, more dynamic sound than my corner horns.

These speakers deserve consideration for low powered tube rigs. Unlike full-range, single cone speaker designs which are the current rage, these speakers have more muscle, way more treble extension, and they "got bass!" It is important to try your amp with these speakers, as my 300B amp was a good match, but the Micro ZOTL amp was an amazing match with the RF-7's (\$2300/pr SRP).

**Klipsch RF-7 Subjective Evaluation**

Dynamic Range	Transparency	Frequency Extension
4.5	4	5
Dimensionality	Pace and Rhythm	Musical Involvement
4	4	4.25

The scale is 1 to 5 with a score of 5 being the very best

**Overall Rating: 4.25**

**Manufacturer Specifications**

Frequency Response: 32Hz-20kHz±3dB

Sensitivity: 102dB @ 1watt/1meter

Power Handling: 250 watts maximum continuous (1000 watts peak)

Nominal Impedance: 8 ohms

Dimensions: (H x W x D):

Height: 45" (115cm)

Width: 11.6" (29.7cm)

Depth: 16" (41cm)

Weight: 90 lbs. (40.8kg)

**Klipsch Audio Technologies**

3502 Woodview Trace, Suite 200

Indianapolis, IN 46268

(317) 860-8100

Toll Free: (800) 544-1482

**Test System Components:**

Jolida JD 603 CD player with Mullard CV4004 tubes in the analog output section

Assemblage SET 300 amp with Valve Art and JJ 300B tubes, Micro ZOTL amp

Homebrew fine wire speaker cables using three strands of 30 awg silver-coated copper wire in a kynar jacket

TEK LINE PC -12 Signature power cords for both the amp and CD player

VSE Super Clear interconnects

# Berning Micro ZOTL Amp

**Less Is Definitely More**

By David Bardes ©2003 All Rights Reserved

David Berning is on to something here. He calls his Micro ZOTL amp a personal triode amplifier, and indeed it is very personable! Based on his impedance conversion technology, the Micro ZOTL brings glorious tube sound to virtually anywhere with a 4 pound amp that can run on AC or 12V DC power sources. This amp is rated at 1 watt per channel, but that is enough to musically drive small speakers in a den or office setting, large efficient speakers to room filling levels in larger rooms, or a favorite pair of headphones.

The Micro ZOTL amp, like David Berning's other amps, uses a radio frequency carrier to transport the output signal through a device that acts as an impedance converter, replacing the need for a conventional output transformer. This avoids hysteresis and core saturation, significantly reducing audible and measurable distortion. This isn't your typical econo-tube amp or anything like your father's tube amp!

About the size and shape of a shoe box, the Micro ZOTL is available in blue, red and black. The amp has a power selector switch, a volume pot and a headphone jack on the

top. It also had an IEC jack, a mini plug for DC power, one set of RCA jacks and binding posts on the back. The front panel has a power indicating LED, and a window to view the tubes and electronics inside. A peek inside the window reveals a circuit board with the tubes surrounded by many parts and two mysterious cylinders of wire and magnets that must be the impedance converters.

This amp is just plain fun, because the sound just seems so much bigger than the amp! This amp spent time in my office driving a pair of Dynaco A-10's, in my bedroom driving a pair of Grado SR-60 headphones, and in my living room rocking with my Khorns. Bass was well damped and controlled and there was enough power for most applications and for most musical tastes. Head bangers and hopelessly inefficient speakers need not apply!

Best of all it makes music! This amp sounds different than other tube amps I have auditioned, and it certainly doesn't sound like some "sandy state" amp. It has a sound all its own. It has lots and lots of detail and dynamics but there is no hint of single-ended bloom. The sound is fast and clean like a more conventional, high quality push-pull amp.

And at first I thought it sounded a little too lean and clinical. I changed out the supplied Jan/Philips 12AT7's with some JJ brand 12AT7's and the amp warmed up nicely with no loss of detail. With the new AT7's in place, the amp was a joy to listen to. I bet more could be accomplished with a nice pair of NOS 6SN7's which are used as push-pull output tubes in this amp (Chinese 6SN7's are supplied).



While the amp is certainly balanced and doesn't highlight any portion of the frequency range, it has impressive bass depth and clarity at least through large efficient speakers and headphones. This is where the Micro ZOTL sounds way bigger than it should. Small amps typically have either weak anemic bass, or floppy, muddy, fuzzy bass. Not so the Micro ZOTL! Through my headphones and Khorns the bass notes of Mighty Mighty Fine (*Down To The Bone*, Atlantic Records) were clear and thunderous. The bass was cleaner and more muscular than when played through my 8-wpc 300B amp perhaps because there is no transformer core to saturate. Connected to a pair of Klipsch RF-7 loudspeakers the bass response was nothing short of spectacular!

When I have tried to run complex music through other very low-powered amps and bookshelf speakers, the result has been mush. To my delight, the Micro ZOTL was very composed playing orchestral music through the Dynaco A-10's which are not the most efficient speakers around. I did notice that the sound was not as dynamic as when the amp was playing through the Khorns or headphones, but it did make the A-10's sing. As I turned up the volume, the amp remained very musical, never sounding shouty or like it was running out of gas. Only at the very limits of the volume control did it start to sound compressed. Few amps have this level of composure when pushed hard. This certainly would be a great amp for the den or office!

With the headphones, the amp presented a nice open space around the music. Through the Khorns, the soundstage was good, but through the RF-7's, the soundstage was wide and deep, extending beyond the speakers and the back wall of my living room - very cool!

This is the most flexible, musical amp I have had the pleasure to review. It is compatible with headphones and all

reasonably efficient speakers. Add to this the convenience of light weight and the ability to run on 12VDC power, and the result is an amp that can provide real tube sound almost anywhere!

**Micro ZOTL**

Dynamic Range	Transparency	Frequency Extension
4.5	4	5
Dimensionality	Pace and Rhythm	Musical Involvement
4.5	4	4.25

The scale is 1 to 5 with a score of 5 being the very best

**Overall Rating: 4.5**

**Specifications:**

MSRP: \$750

Output Power: 1 watt per channel

Tube Complement: 2) 12AT7's, 2) 6SN7's

Hum and noise: 60mV RMS or 90dB below full output (20Hz-20kHz).

Carrier: -50dB (250kHz).

Current draw from 12V dc source: 2.1A.

Power consumption from ac power source: 33W.

Power output with 4-ohm load: 1W, 1% THD.

Size: 30.5cm (12 inches) wide, 11.5cm (4.5 inches) high, 14.6cm (5.75 inches) deep, not including connectors, controls and feet. Add 5cm to height and 3cm to depth for these.

Net weight: 1.8kg (4lb).

Finish: Aluminum case (colors: blue, red, dark olive-brown) with window.

**David Berning Co.**  
 12430 McCrossin Lane  
 Potomac, MD, 20854  
 301-926-3371  
 www.davidberning.com

**Test System Components:**

Jolida JD 603 CD player with Mullard CV4004 tubes in the analog output section

Dynaco A-10's, Klipschorns, Klipsch RF-7, Grado SR-60 Headphones

Homebrew fine wire speaker cables using three strands of 30-awg silver-coated copper wire in a kynar jacket

TEK LINE PC -12 Signature power cords for both the amp and CD player

VSE Super Clear interconnects

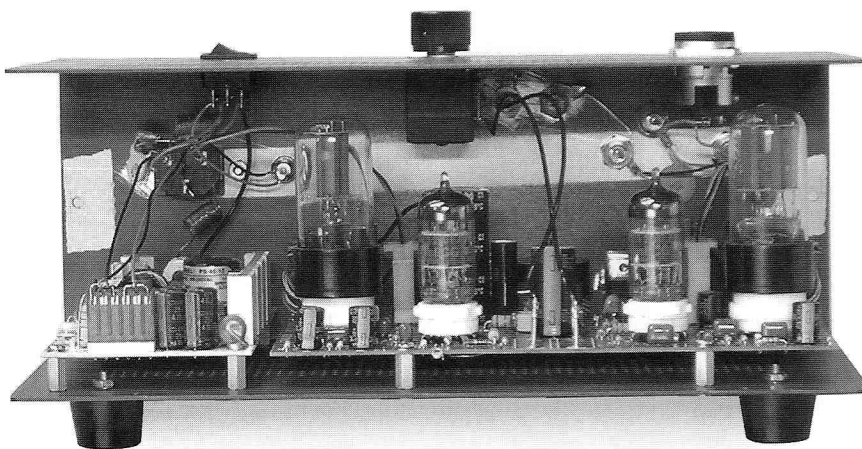

# Radio Craftsmen C500 Amplifiers #2 Vintage Hi-Fi Series

By Charlie Kittleson ©2003 All Rights Reserved

In the mid 1940s, many GIs who served in the European Theater experienced live classical and chamber music for the first time in their lives. This created an interest in the finer things in life, such as fine music reproduction in the home. Unfortunately, most home radios and 78 RPM records offered very little in the way of high-fidelity reproduction. Typical radios of that era had type 6F6G, 41 or 42 tubes in a cheap output stage driving a low quality output transformer and a low fidelity 6 to 10-inch electro-dynamic speaker. Most sets had a frequency response of 100 to 5,000Hz--pathetic by today's hi-fi performance standards. Many of the lower quality "high-fidelity" radios and phonographs had cheesy-sounding falsified bass and attenuated highs. And in the 1940s, after two decades of generally higher quality sets, manufacturing standards fell to a new low due to materials scarcity and the advent of "value engineering."

Most existing tube amps were mainly PA grade with low quality output transformers. There were few, if any, high quality tube amplifiers or preamps designed for fine record reproduction. Many music enthusiasts opted to build their own tube amp based on the 1947 D.T.N. Williamson article originally published in *Wireless World*. However, most people did not have the skills or the time for DIY, so a

new market was created for plug-and-play tube amplification for the home.



1952 Craftsmen C 500

The growing home audio market attracted several entrepreneurs such as Avery Fisher, Hermon H. Scott, Harry Ashley (EICO), Frank McIntosh, Saul Marantz and many others. John Cashman, formerly an executive with Hallicrafters Radio Company, saw the opportunity for selling home audio and television equipment and founded Radio Craftsmen in 1947. Cashman located the Craftsmen factory in a two story brick building at 4401 North Ravenswood Ave in North Chicago near the "EL" commuter-train tracks. They were in the same neighborhood as E H Scott Radio Laboratories, the premier radio manufacturer for the elite and wealthy in the 1930s. Also nearby were the Haldorsen and Stancor electrical transformer plants.

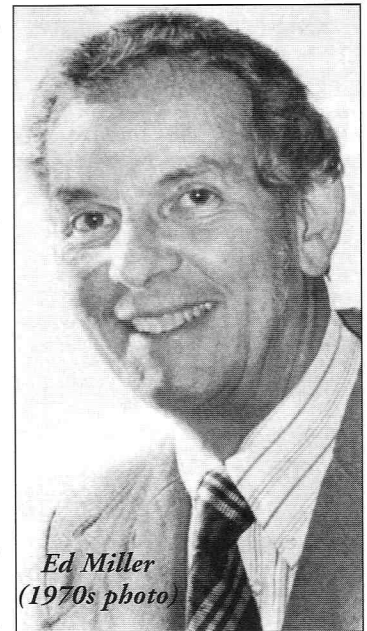

Ed Miller  
(1970s photo)

Ed Miller was one of the first engineers to work for Craftsmen. Ed received his electrical engineering degree from the University of Cincinnati in 1943 and was a radio hobbyist with a strong interest in FM technology. During his career, he worked for Stewart-Warner, US Navy Ordinance as a laboratory engineer, and in General Electric's research labs. He joined Radio Craftsmen of Chicago, Illinois in 1947 as an electrical engineer. Within a few years, he was promoted to vice president and director of engineering. He was the driving force for the company's manufacture of high-fidelity tuners and amplifiers. In the early-to-mid-1950s, Radio Craftsmen was among the largest producers of FM tuners, with Fisher Radio as their main competition. The RC-1 was Radio Craftsmen's first FM tuner. It, along with the matching 10-watt RC-2 push-pull 6V6 power amplifier, were made on beautifully chrome-plated chassis.

Another famous audio pioneer who worked for Radio Craftsmen was Sid Smith, who did most of the design work on the C 500 amplifiers. Sid went to work for Ed Miller in early 1950 and immediately started working on amplifier and transformer design. In April of 1951, he completed the design of the RC-10 AM/FM tuner preamp which was extremely popular. In addition, he designed the C 400 - 6V6 PP amp, the C 10 am/fm tuner and the 5- watt 6W6 amp designed for use with the chrome-plated Craftsmen TV chassis.

When I interviewed Sid in 1997, he mentioned that he began work on the C 500 amp design in 1951. The goal was to come up with a

design that had stable output with feedback. A significant component of the C 500 was the output transformer design. Sid told me that Herb Keroes of Acrosound taught him how to spec out a transformer for a given circuit. Eventually, the design was finalized and Stancor was chosen to produce the output transformer.

Sid left Radio Craftsmen in 1954 and went to New York to pursue a career as an opera singer. Between rehearsals and performances, he answered a help-wanted ad for a draftsman. It was of course, Saul Marantz who was looking for a draftsman. The rest, as they say, is history. Sid later designed the Marantz Model 2, 5, 8, 8B and 9 amps, Model 3 crossover, Model 6 stereo adapter, and the 7C audio consolette. He was also involved in the design of the fabulous Marantz Model 10 and 10B FM tuners along with Dick Sequerra and Saul Marantz.

#### Craftsmen C 500 (\$99 suggested retail)

The first of the larger Craftsmen amps was introduced in late 1951. Dubbed an Ultra-Fidelity Amplifier, the C 500 was a 10-watt RMS, pure Class A Williamson-type design. To quote Craftsmen's original ad copy:

*"Ultra-Fidelity is a new concept in audio amplifier performance previously found only in the research laboratory. With an Ultra-Fidelity amplifier, harmonic and other types of distortion either approach the point of vanishing or are truly negligible over the entire range from 20 to 20,000 cps. In order to maintain excellence throughout this range, the complete frequency range of an Ultra-Fidelity amplifier must be considerably wider than the audio range. The Craftsmen 500 amplifier now brings Ultra-Fidelity from the research laboratory to the home.*

*The use of an Ultra-Fidelity amplifier eliminates completely the audio power amplifier from being a source of distortion in a home music system. In addition to this, an Ultra-Fidelity amplifier, because of its excellent damping characteristics, can reduce transient distortions in the speaker system. These outstanding performance characteristics may be clearly and practically demonstrated to the listener by providing low listening fatigue and by recreating an intangible effect of "presence" approaching concert-hall realism."*

The C 500 circuit direct-coupled the first AF stage (one-half of a 6SN7) to a split-load phase inverter (the other triode of the 6SN7) which was RC coupled to a 6SN7 push-pull driver. The driver was RC coupled to a KT66 push-pull output stage. Matched pairs of British

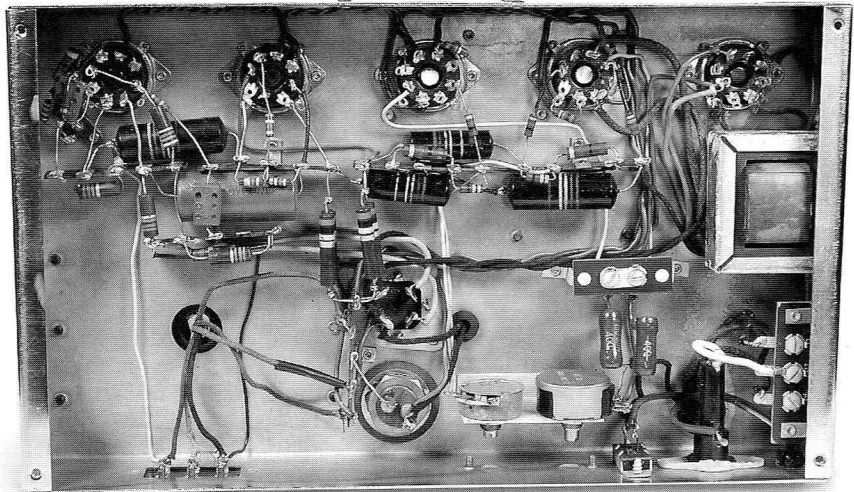

C 500 under chassis

KT66 tubes were used because they had higher triode output capabilities than 807s or 6L6s. They were also chosen because of their lower plate impedance. Feedback was taken from the 16-ohm tap of the output transformer and was fed to the cathode of the first 6SN7 triode through a 68pf capacitor and a 4.7K resistor for approximately 20dB of negative feedback. Basically, a subtly refined Williamson design.

The following quote from a 1954 Craftsmen product brochure describes how well the C 500A amplifier handled phase and transient response:

*"Since an analysis of the wave-shapes encountered in music and speech shows a preponderance of sharply peaked and steep-sided wave fronts, high fidelity audio equipment must be capable of duplicating these wave-shapes faithfully and without originating additional transient signals. Excellent square-wave response has been accomplished in the C 500 by following video amplifier design techniques that require an excellent phase response characteristic as well as a good frequency response far beyond the audio spectrum. In this amplifier, the excellent phase response showing less than 15 degrees shift at the extremes of the audio range has made possible almost perfect duplication of square-waves as low as 20 cps or as high as 20,000 cps with practically no transient tails or ringing that might mar musical reproduction."*

The large potted output transformer was meticulously designed by Sid Smith for best square wave performance, maximum fidelity and superb frequency response. It featured interleaved windings, 25mHy leakage inductance, 120Hy primary inductance and full output power from 10Hz to 50KHz. Core materials and windings were made with the finest available materials and utmost quality control. According to Sid, Stancor made this transformer for

Craftsmen. There were two versions of the transformer, one with square corners and a later one with rounded corners (made primarily by Stancor, and in some cases by other firms.) Over 12 years ago, John Atwood (former VTV Technical Editor), evaluated dozens of classic tube amplifier transformers and compared their performance to each other. The Craftsmen C 500 output transformer tested with minimal ringing and outstanding frequency response, yielding superb square wave response.

Beefy and well designed, the C 500 power supply had two filter chokes and a 4uf @ 500V oil cap to filter the high voltage (445 VDC) to the center tap of the output transformer. A dual 40uF @ 500V electrolytic capacitor provided filtered DC to the front-end of the amp. The power transformer was similar in specification to a Stancor PC8412 with a secondary winding of 840V center tap rated at 145mA. Most of these original power transformers failed, due either to poor quality or shorted filter capacitors. Most C 500s I have seen have had the power transformer replaced with a PC8412 or Chicago PV-200. Finally, a 5V4G rectifier tube provided the DC rectification.

Cosmetics of the C 500 were quite appealing with a beautifully chrome-plated chassis, attractive engraved nomenclature tags and aesthetically-pleasing component layout. According to Hal Cox, a Bay Area hi-fi historian, Craftsmen was inspired to chrome plate their chassis by nearby E. H. Scott Radio Company, who made beautiful chrome-plated radios during the 1930s and early post-war period.

1954 Craftsmen C 500A

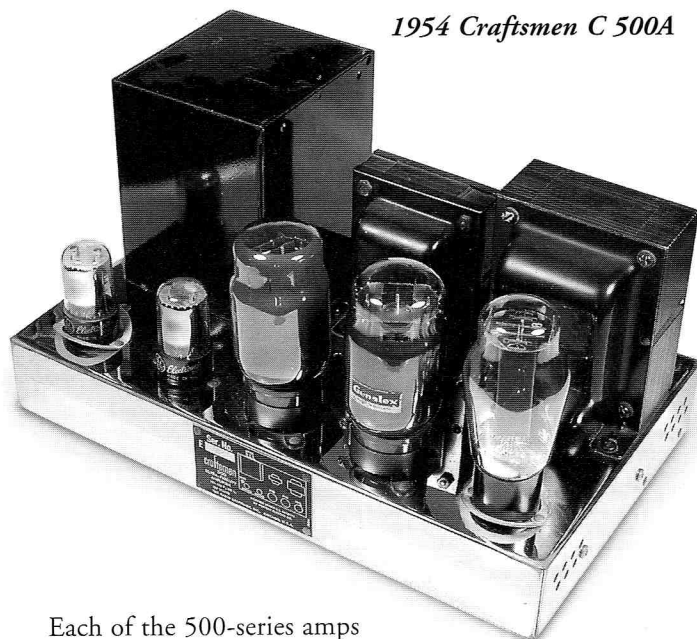

Each of the 500-series amps carried a stamped serial number on the front identification tag. Sid told me that C 500 amps began with the serial number E 1001 and production ended with E 6XXX or thereabouts with the C 500A amplifier. So essentially, that means that between 5,000 and 6,000 C 500s and C 500As were built. Craftsmen amps were extremely popular and were featured in custom, built-in systems shown in many 1950s audio-ophile books and magazines.

## INSTALLATION and SERVICE INSTRUCTIONS

# THE craftsmen 500<sup>A</sup>

## ULTRA FIDELITY AUDIO AMPLIFIER

### ELECTRICAL SPECIFICATIONS

- POWER OUTPUT:** 15 watts maximum.
- FREQUENCY RESPONSE:** +0.1 db., 20 cps. to 20,000 cps.  
+2 db., 5 cps. to 100,000 cps.
- POWER RESPONSE:** 12.5 watts, +1 db., 10 cps. to 50,000 cps.
- PHASE SHIFT:** +15 degrees, 20 cps. to 20,000 cps.
- TOTAL HARMONIC DISTORTION:** Less than 0.1% at 10 watts at mid-freqs.
- INTERMODULATION DISTORTION:** Less than 0.5% at 10 watts (40 & 12,000 cps.: 4/1)

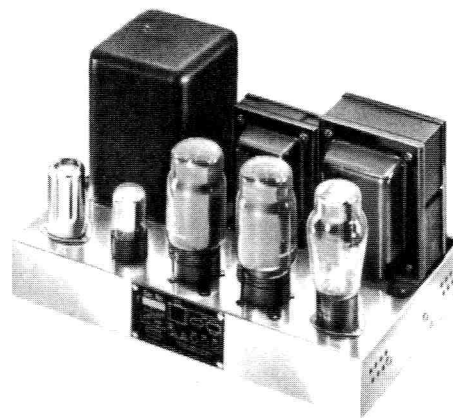

- HUM AND NOISE LEVEL:** 90 db. below rated output.
- SENSITIVITY:** 1.5 volts, rms. input for rated output.
- OVERALL GAIN:** 70 db. (470,000 ohm input resistance)
- DAMPING FACTOR:** 32:1
- OUTPUT INTERNAL IMPEDANCE:** 0.5 ohm on 16 ohm tap
- OUTPUT LOAD IMPEDANCE:** 8 and 16 ohms nominal
- POWER CONSUMPTION:** 105-125 volts, 60 cps., 125 watts
- TUBE COMPLEMENT:** 6SN7GTA amp, & inverter, 6SN7GTA push-pull driver, (2) KT66 power output, 5U4G rectifier.
- OVERALL DIMENSIONS:** 8 in. x 13½ in. x 7½ in. high
- SHIPPING WEIGHT:** 25 lbs.

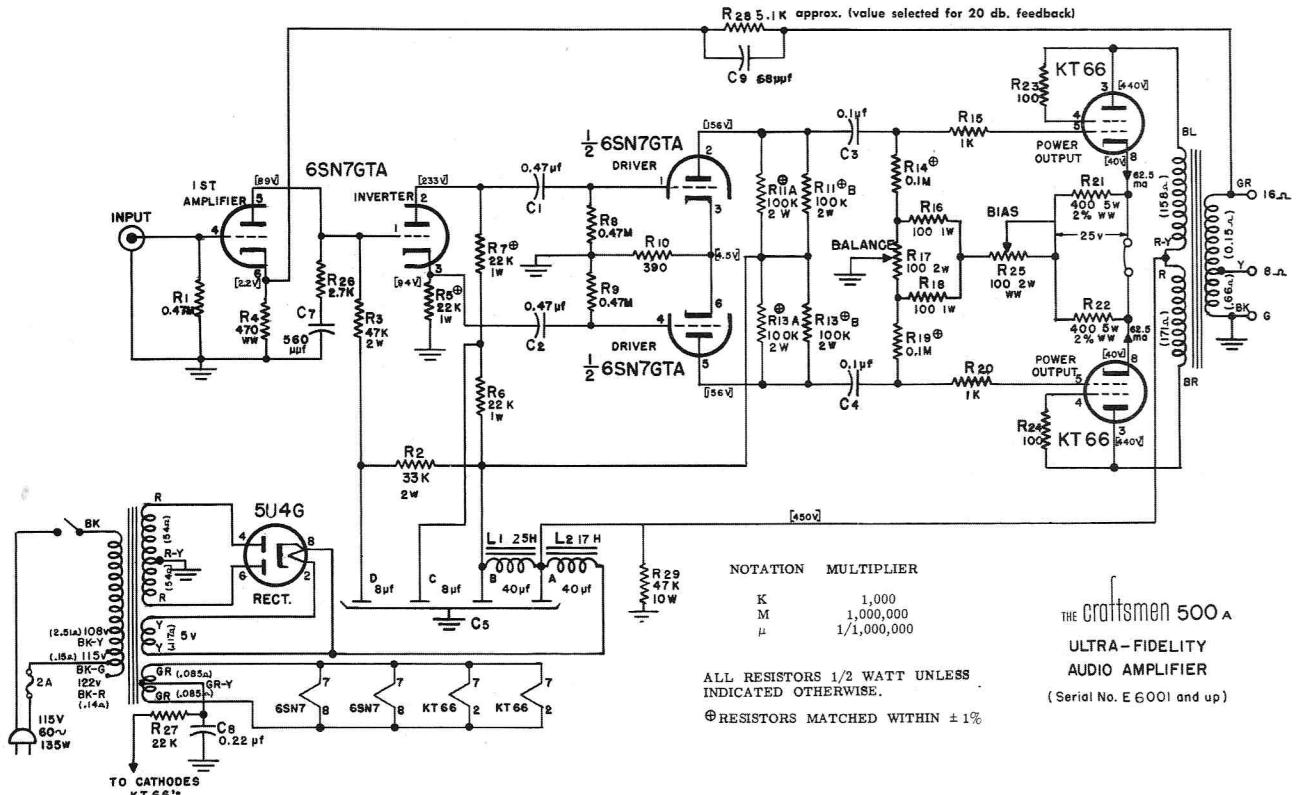

**Craftsmen C 500A (\$99 suggested retail)**

In late 1953, Craftsmen introduced the C 500A, an upgraded model of the original C 500. Generally, the circuit was similar with the same tube complement except for the 5U4G rectifier that replaced the original 5V4G. Plate voltage was upped another 10 volts and the 4uf oil cap was eliminated. The dual 40uF @500V can-type filter cap was relocated under the chassis. A larger 25Hy filter choke was added to the top of the chassis. Damping factor was increased to 32 and output power rating was increased to 15-watts RMS. The output transformers used were mainly the rounded-edge Stancor types with the same specifications and ratings as the C 500 amplifier. The power transformer was changed to a beefier one that was the equivalent of a Stancor PC8414 with 1128V center tap at 150mA rating.

Specifications of the C 500A were +0.1db from 20 to 20kHz with total harmonic distortion of less than 0.1% at 10 watts.

**Craftsmen C 550**

By 1954, the home hi-fi market was getting crowded. Altec, EICO, Fisher, Grommes, Heathkit, McIntosh, Marantz, H.H. Scott and dozens of other companies were all producing tube mono integrated and power amplifiers. In addition, less efficient speakers such as the AR-1 (often paired with Janzen Electrostatics) and others were showing up in the marketplace. 15 watts was no longer enough for many bookshelf speakers of the period. Craftsmen answered the call with the C 550, an uprated amp producing 30 watts RMS. This amp was designed by Bob Grodinski who took Sid Smith's place as design engineer of

amplifiers at Craftsmen in 1954. An Ultralinear output transformer took the place of the original larger C 500 iron. It is not known who made this transformer, although it is most likely Stancor as it is similar in specification to the Stancor A-8072 Ultralinear replacement output transformer. This amp also used a B+ delayed turn-on via a slow warmup, 60 second thermo-relay tube to preserve the cathodes on the KT66s.

Additional features on the C 550 included the use of a single terminal board to mount most of the capacitors and resistors. One choke in the power supply was eliminated and the power transformer was downsized to an 820V center-tap rated at 140mA.

**Repair and Restoration**

C 500s are very simple in design and easy to work on. The point-to-point wiring and open chassis make it easy to replace any component. They are built like classic cars from the 1950s, lots of heavy iron and chrome.

The power transformers on a 500 is usually blown and replaced with an aftermarket unit. If you get a 500 with a blown power transformer, there are close replacements available from Hammond or Schumacher. They will be cosmetically different and most likely smaller, but will do the job. Or, you can get the original transformer rewound.

Chrome chassis have a way of attracting dust. When the dust gets caked on, then damp or wet, the chrome will rust. Many dusty old Craftsmen amps wound up being stored in damp garages or basements. If you are lucky, you may find one that has good chrome.



The coupling caps can easily be replaced with whatever you choose. I have used everything from old Sprague Vitamin Qs, to Audicaps to ICMWR Illinois metalized polypropylene caps. You have to experiment around to find out what your preferences are. The electrolytics should be replaced, but the 4 uF@600V tubular oil cap only on the C 500 (not the C 500A) will generally test OK. Do not add more than 50% additional electrolytic capacitance value, because it can rob from the mid and high frequency response and overtax the rectifier tube.

**How Do They Sound?**

The C 500 is one of the finest sounding early 1950s tube amps. Use of KT66s in triode connection, beefy 6SN7 front-end, along with an outstanding output transformer make for superb 3-dimensional realism. Even by today's standards, the C 500 is clear, sweet and has superb musical performance. They match perfectly with speakers designed at the same time, such as efficient Tannoys, Bozaks, Altec 604s, Klipschorns, EV and University component speakers, etc. They are perfect for any horn-type speaker setup. You can even use them for bi-amp or tri-amp horn systems.

The Craftsmen amps are very solid and excellent-sounding amps. The only weakness is the power transformer which is generally replaced. Note that the C 500 puts out about 10 watts and the C 500A puts out about 15 watts due to higher plate voltages.

**The Beginning of the End**

By 1955, the home audio market was getting crowded with over 60 companies, large and small, producing tube amps, tuners, etc. Craftsmen was having problems with their distribution system that was mainly retail outlets and mail order houses like Allied Radio, Lafayette Radio, Newark Radio, etc. They briefly tried to bypass the retail dealer and catalog houses and sell directly to customers by mail, but this attempt failed and they went out of business in late 1955. The Radio Craftsmen business and name were sold to a company in Los Angeles later that year. They concentrated on integrated amplifiers such as the Solitaire and receivers such as the Stradivarius of the "flat" design. This company's products were cheaply made and they later failed.

By that time, Sid Smith had left the company for Marantz and Ed Miller started Sherwood with a group of engineers from Elrad, a coil manufacturer in Chicago. Sherwood was the name they chose, as it was the name of the suburb that Ed Miller lived in. We will cover the story of Sherwood in a future issue of VTV.

*Thanks to Hal Cox of Mill Valley, CA, John Eckland of Palo Alto, CA and Earl Yarrow of Newman, CA for their assistance with this article.*



**Some things should never sag.**

**And some things should.**

**Maven Peal® Zeeta**

**.5/15, .5/30 & .5/50**

Unprecedented response to your touch...

1270 Peck Hill Road • Plainfield, VT 05667  
802.456.1607 • [www.mavenpeal.com](http://www.mavenpeal.com)

**VTV Tube Audio Clinic**



**We have over 65 years of combined tube audio service and restoration experience.**

- High-End Tube Audio Repair and Service - All Makes
- Vintage Tube Hi-Fi Repair and Restoration - All Makes
- Vintage and Boutique Guitar Amplifier Repair
- Precision FM Tuner Alignment
- Pro-Audio Vintage and Modern Gear Service
- Custom Designs and Performance Upgrades

*VTV Tube Audio Clinic, a division of VTV, will restore your tube equipment in a professional manner with no hassles or delays.*

**NEW!! We now have a Bay Area Location**

Call for more details or visit our website at

**[www.vacuumtube.com](http://www.vacuumtube.com)**

**707-263-5881**

**[triode@vacuumtube.com](mailto:triode@vacuumtube.com)**

# The Ultimate PP KT88 Amp

By John Eckland ©2003 All Rights Reserved

Lots of people like to talk about quality. Nothing gets more lip service, especially in high-end audio. Yet the actual quality of tube amplifiers sold to the public today is literally all over the map. Some of the best-selling amps on today's market have overly-complicated circuit designs and poor quality output transformers. You would never discover that by reading the mass-market journals--they are in the advertising business, not the quality audio business.

I decided to try building a tube hi-fi amp that would give any other type the toughest competition. In short, this amplifier project is without compromise. As far as a new design, we decided that "new" was an over-used term. So we returned to the original classic--the D. T. N. Williamson circuit. In this case, the design originated in an article in the December 1955 issue of *Radio-Electronics* magazine authored by David Hafler of Dynaco. At the time, there was a push within the small high-fidelity community for higher power, to deliver maximum fidelity. Speakers with low efficiency, such as the Acoustic Research AR-1 and the early KLH acoustic-suspension designs, called for at least 30 watts. The timing was perfect, since the Tung-Sol 6550 had just been introduced--allowing more than 40 watts from two tubes, with low distortion and without the expense of using transmitting tubes.

The Tung-Sol 6550 was the first of its type--a ruggedized beam power tetrode with combined plate and screen dissipation of greater than 40 watts, intended especially for audio service. Tung-Sol's original ratings for push-pull

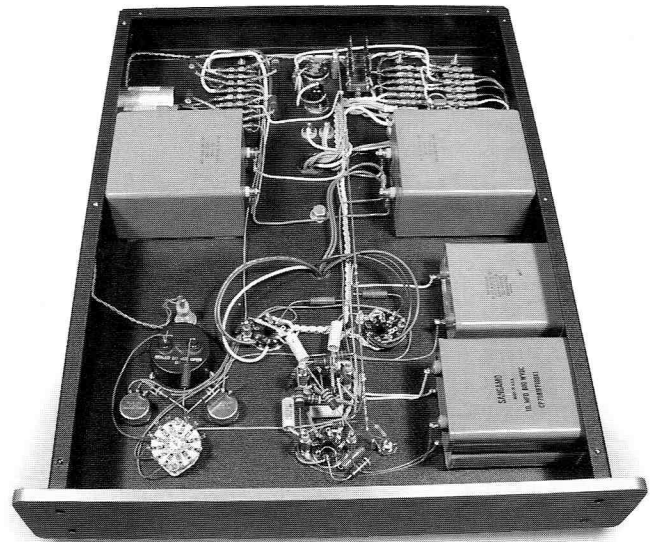

6550s gave triode-connection power output of 28 watts, or up to 100 watts output in tetrode connection with plate voltage at 600 volts. The 1955 article applied this new tube to the classic Williamson design, using two 6SN7s as drivers and a 5U4GB rectifier. The original article also specified two of the best audio output transformers available at the time, either the Dynaco A-430 or the awesome Acrosound TO-330.

Our 21st-century version is built to the best classic standards, since it is obvious that tube amplifier designs matured with the Williamson circuit (and have apparently not improved much since then). The best available output transformer was selected, the Plitron 4142. It has the ideal 4200-ohm plate-to-plate load, and allows Ultralinear connection, which we took advantage of. After much testing and research, I feel that this Plitron toroidal transformer is easily the equal of the costly and rare Acro TO-330, if not its better. Perhaps some "vintage snobs" will disagree, but they will have no facts to base their objections on. The small-signal frequency response of the Plitron easily exceeds 100 kHz, putting it in VERY rarified territory. Original Acrosounds sometimes reach that neighborhood, but not always!

We chose to use Svetlana KT88s for a simple reason--they are the best such tube currently available. Unlike other modern 6550s or KT88s, we observed no bias drift with the Svetlanas, while they also met the original KT88 specifications. No electrolytic capacitors are used, only high-quality oil-filled or film types. If the circuit is conservative (and this one certainly is), and the plate supply is adequately filtered, electronic regulation is unnecessary, and only adds reliability disadvantages. Again, there are snobs who will claim otherwise, with no real justification.

The prototype amplifiers were built on Plitron's massive aluminum chassis with built-in metering of cathode current for both tubes. The KT88s operate at 515 volts, idling at 45 mA each, with individual fixed-bias adjustments for each tube (a necessity). Instead of bowing to the bizarre practice of huge coupling capacitors, we stuck with

0.22 uF types of high quality (Illinois Capacitor ICMWR), because 0.22 uF is just enough, and is unlikely to cause self-inductance problems or "motorboating" oscillation. Excellent grounding is accomplished with solid silver buss bars.

IXYS FRED rectifiers (11 amp @1200V) were used in preference to tube rectifiers, both because modern FREDs are capable of performance equal to or better than any tube rectifier, and because bridge rectification is difficult to accomplish with tubes. The driver is the classic phase cathodyne circuit with split-load phase inverter. I feel that the complex phase inverters used in modern amplifiers are unnecessary, IF a very linear tube is used--such as the 6SN7GT. The finished amplifiers easily produced 50+ watts with no visible clipping, from 20 Hz to 20 kHz.

As the original article explained, the 6550 offered clean sound and less muddiness in "heavy passages." Because it could produce the extra power, a 6550 amp had extra stability margin, giving "instantaneous recovery on percussive sounds and translucent, smooth listening on high-frequency string and wind instruments. Small transient sounds, such as tambourines, assume different spatial

positions; possibly because the low phase shift does not disturb the harmonic pattern of complex, non-repetitive tones. The total effect is greater naturalness, and less impression of recorded sound." (Remember, they were talking about a monophonic system here.) That accurately sums up the sound we observed with these amplifiers. I would say that they perform as well as ANY vintage hi-fi amp I have ever heard.

*A special thanks to Plitron Transformer Company for their assistance with this project.*

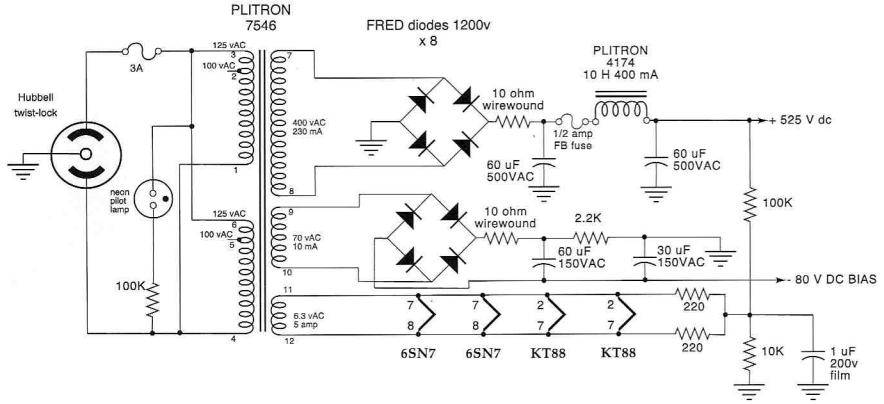

**Figure 2: power supply for Eckland-Plitron KT88 power amp.**

All resistors are 2 watt vintage carbon-composition types except as noted. All capacitors are film or oil-filled types.

Copyright 2002 Vacuum Tube Valley. All rights reserved.

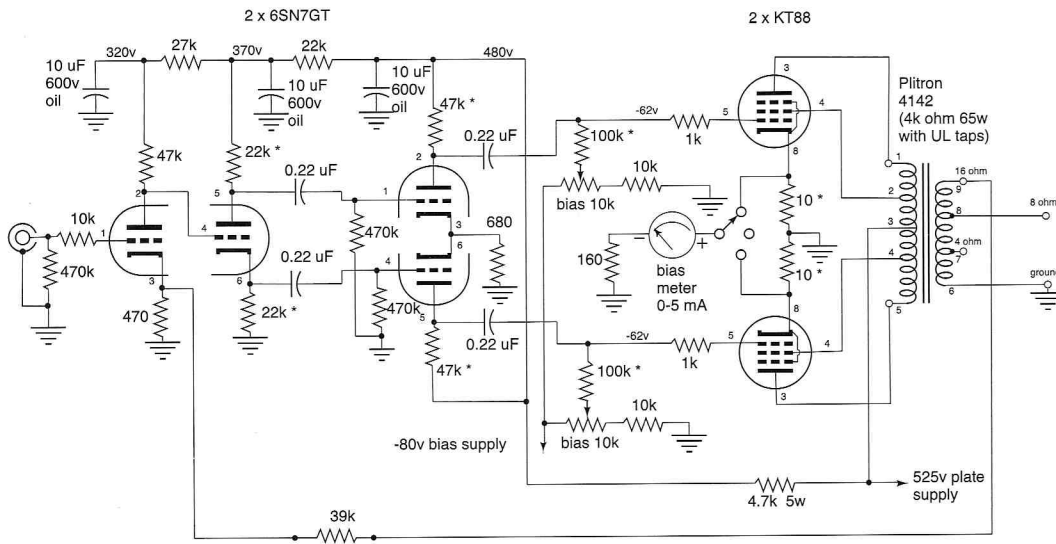

**Figure 1: schematic of Eckland-Plitron KT88 power amp.**

All resistors are 2 watt vintage carbon-composition types except as noted. All capacitors are 600v film or oil-filled types except as noted. Resistors marked \* are selected to match within 1%.

Copyright 2002 Vacuum Tube Valley. All rights reserved.

# 6550/KT88 Shootout: Hi Fi

By Charlie Kittleson ©2003 All Rights Reserved

We did our first article on 6550s and KT88s in VTV Issue #6 and now several new versions of these tubes are available. Since this issue is dedicated to 6550s and KT88 tubes, a serious listening evaluation was in order. So we gathered a group of tube audio enthusiasts from the Bay Area to have a listen to both NOS and new types. Included in the session were Scott Frankland, John Eckland, Brian Hartsell, Jeff Stevens, Richard Kozicki and Ben Reginato.

Brian Hartsell graciously allowed us to use the Analog Room in San Jose for our afternoon of tube evaluations. In case you don't know, the Analog Room (1416 Fruitdale Ave., San Jose, CA 408-971-6158) is a paradise for LP record collectors as well as the best place in Silicon Valley for high-end tube audio gear and service.

Our reference system included the following: an 80 wpc Air Tight ATM-2 PP KT88 power amp with a tube front end using a 12AX7, 12AU7 and a 12BH7; Air Tight ATC-1 tube preamp; Air Tight ATH-2 Moving Coil Step Up Unit; Quad 989 Dual Panel Electrostatic Speakers; Clearaudio Maximum Solution turntable, Graham 2.2 tone arm; Koetsu Onyx Platinum MC phono cartridge; Shunyata Lyra interconnects; and Shunyata Aries speaker cables. The sticker price on this super system was about \$55,000!

We chose to use high-quality vinyl for our listening session including reissue discs of Miles Davis doing *So What* from the *Kinda Blue* album; Michael Rabin performing *Paganini Concerto #1 in D Major*; and a pure vocal of Sam Cook from the *Nightbeat* album singing 'Lost and Lookin.'



Jeff Stevens, Ben Reginato, John Eckland, Scott Frankland,  
Richard Kozicki, Brian Hartsell



The system was synergistically matched for a musical, yet high-resolution sound allowing subtle differences in tube sonics to be very evident. In addition, the Air Tight ATM-2 was a good challenge for the tubes with over 550 volts of B+ on the plates. The amp also had adjustable bias for each tube and a bias balance control for each channel. All of the tubes, both new and NOS, were closely matched for plate current and transconductance within 2 to 5% with our Maxi-Matcher Digital Tube Matcher.

We rated the tubes on a scale of one to five, with five being the best. Tubes were rated subjectively in the following categories: coloration, dynamic range, transparency, frequency extension, musical involvement, three-dimensionality, and pace and rhythm. Reviewers were able to add their comments to any rating. All scores were tabulated and averaged for a final numerical score.

## 6550 Types

### Chinese 6550A

China has been producing 6550 types since the 1980s when they supposedly bought the tooling for the Tung-Sol 6550 and started producing very low quality 6550 clones. These babies could rarely handle B+ voltages in excess of 450-475 and often had "fireworks display under glass" in many amps. There have been several incarnations and updates of the Chinese 6550. The latest rendition, available from Magic Parts, Valve Arts and other distributors shows significant improvement over earlier versions. This version is similar in appearance to the GE 6550A and by all indications appears to be made to higher quality standards..

The latest Chinese 6550A biased up well and maintained stable bias throughout the test. It also handled the 550+ volts from the test amp with no problem. Reviewer comments of the tube were: neutral, slightly harsh, dry, louder than the Sovtek

6550, smooth, liquid, thin, wide response, excellent transparency, great soundstage, controlled bass, and fine sounding tube. The total average score for this tube is 3.89 out of 5.00, which is higher than the GE 6550A. For those on a budget, the Chinese 6550A is a bargain.

### GE 6550A

When GE came out with this tube in 1971, it was a direct competitor to the Tung-Sol 6550. It was used in many high-end amps from Audio Research, Conrad Johnson, VTL, etc. When GE sold off the Owensboro, Kentucky tube works (the old Ken-Rad plant), much of the tooling was sold to MPD (Microwave Power Devices). Since the mid 1980s, MPD manufactured the 6550A built to the same specs as the original GE 6550A. These were made until 1995, when they ceased production.

In general, the GE 6550A is a solid tube with great dynamic range and extension. They can be slightly harsh and up-front sounding in some applications. During our tests, the GE 6550A seemed to be noticeably louder than other 6550s. Reviewer comments included: slightly harsh, fat bottom, warm, smooth, clean, high gain, bright highs, cool, high and dry, lacks front-to-back delineation.

Overall score for the GE6550A is 3.78 out of 5.0, which is the lowest score of the test. This may be because the tubes were NOS, right out of the box with no break-in, but it does give us an idea of how they sound. My personal experience with GE 6550As is that once they mellow out, they sound fine.

### Philips/Sylvania 6550

In 1971, responding to the demand for 6550-type tubes, Philips (Sylvania) introduced their version of the 6550. It is the smallest in size, compared to other 6550s, and has a straight-sided glass envelope. Sonically, the Philips 6550 is warmer sounding and more like a super-sized EL34.

Reviewer comments included: bass a little boomy, spacious and deep soundstage, sometimes biting-but liquid, neutral, not involving, smooth and liquid, highs not as extended as Tung Sol, a little dry, loud, warm and like a big EL34. For somebody who wants a warmer sound with less dynamics, the Philips 6550s might be the ticket. These are scarce now, due to low production, so matched pairs and quads are difficult to find. Overall score for the Philips 6550 is 3.98.

### Reflector/Svetlana 6550

Sovtek-branded tubes made by the Reflector tube works in Russia have been available as a low cost alternative from New Sensor since the late 1980s. When the stocks of GE and Tung Sol 6550s started to dry up, Mike Matthews approached the Svetlana (St Petersburg) factory in 1991 to manufacture a 6550 type. Svetlana developed and started shipping the 6550WA in 1992 with New Sensor as the exclusive importer. Then the Svetlana factory made a deal with R and G International in late 1992 to import Svetlana tubes into the United States. Since then, Sovtek and EH have had several versions of the 6550 type.

The latest Reflector version is called the Svetlana SV6550C which is similar in appearance to the original Svetlana SV6550C. It was stable and held bias well. In addition, it handled the 550V B+ with ease. This was not the case with some of the earlier versions such as the Sovtek 6550WE, etc.

Reviewer comments included: smooth, liquid, mid-bass bloom, slightly dry, full, open, natural, plump, dark, opaque, most natural, full bass, like Tung Sol, recessed mids, excellent bass extension, excellent musical involvement. Total average score is 3.98. For those on a budget, the Sovtek/Svetlana SV6550C is reliable and an excellent bargain and is competitively priced.

### Svetlana 6550C

The Svetlana SV6550 has been imported by R and G International since 1992 with the Svetlana "S" logo. Early versions included the 6550B, 6550B-2 (pill getter and flash getter), and 6550B-3 (pill getter), which were not reliable. The SV6550C appeared in early 1995 and was more successful. The SV6550C was revised in 1997 to improve grid alignment (this is the version with large square holes in the plate). The latest version with stamped horizontal ridges on the plate appeared in 2001. These tubes have the "C" logo in a circle. Svetlana SV6550C have been used by most high-end audio manufacturers including Audio Research, Cary, Conrad Johnson, etc.

Reviewer comments for the Svetlana SV6550C included: liquid, smooth, wide response, excellent transparency, highs slightly bright, not as extended as the Tung Sol, wide soundstage, excellent detail, slightly compressed, good and deep bass, cool and detached, most neutral, sweet, and like Tung Sol. Total average score is 4.13.

### Tung Sol 6550 (1963 solid gray plate)

Tung Sol introduced their 6550 in late 1954 for the 1955 hi-fi season. This tube was designed specifically for high power hi-fi amps such as the Altec 340A and the McIntosh MC60 amplifiers. Many tube manufacturers (GE, RCA, Raytheon, etc.), bought 6550s from Tung-Sol and relabeled them with their logos. Starting in the mid 1980s, relabeled Chinese 6550s made by Shuguang were being sold as Tung-Sol 6550s and even KT88s! Somebody



*Clearaudio Maximum Solution Turntable*

is even selling them in reprinted Amperex (green and yellow) boxes. A few crooks on Ebay are selling these as original Tung Sols, so beware, learn to tell the difference before you buy.

The Tung Sol 6550 is legendary and has been revered by audiophiles since its introduction. In this test, it definitely lived up to its reputation. There have been many variations (black plate, top getter, gray plate, triple getter, etc.); for more detail on this see Eric Barbour's article on page 4. Many claim the earliest (1955) black plate top-getter Tung Sol 6550s have a warmer sound and better tone. Unfortunately, I was not able to match up a set of the black plate types for this test. I was able to closely match up some early 1960s with triple getters and solid gray plates. This set was near NOS and adequately broken in.

Reviewer comments included: liquid, beautiful, natural, dark, warm and smooth, sweet, seamless from top-to-bottom, excellent extension, very involved sound, excellent pace and rhythm, extremely accurate, and entirely satisfactory dynamic range. The Tung Sol 6550 is, without a doubt, the top 6550 with an overall score of 4.77. In case you haven't noticed, they are getting scarce and the prices are going up, so don't wait too long to get your personal stash.

## KT88 Types

### Genalex (MO-V) KT88

The granddaddy of all KT88s is the MO Valve KT88 that was originally introduced in 1957. Original versions had more of an "ST" shape, similar to the Tung Sol 6550. The first hi-fi amps to use them were the Leak TL-50+ and the Dynaco Mark III. Later, they were used in McIntosh MC75s, MC275, Harman-Kardon Citation 2s, etc. There are a few different versions of the KT88 including the top getter only, triple getter, smoked bottle (early 1960s), etc. MO Valve KT88s were sold under different labels including Genalex, Emitron, MO Valve, Mullard, etc. They are designed to have up to 800V on the plates and are extremely well made.

Reviewer comments included: big and open sound, liquid, relaxed, gorgeous timbres, huge sound, best mid clarity, beauty returns, accurate dynamics, perfect frequency extension, rich tones, vibrant details, perfect pace and rhythm, spacious three-dimensionality and reference quality. Overall score was a 4.87, the top-rated tube of the test. MO-V KT88s are already scarce, and finding matched pairs, yet alone quads, will be costly. But if you want the best, the MO-V KT88 is your ticket.

### JJ KT88

The JJ KT88 is one of the newest KT88 offerings. Initially developed by Tesla and Aspen Pittman in the mid-1990s, this tube was offered in clear, blue, and red glass versions. Since JJ bought the Tesla factory a few years ago, quality, reliability and sound quality have improved dramatically. This is a well-made and reliable tube that holds stable bias and handles high voltage well.

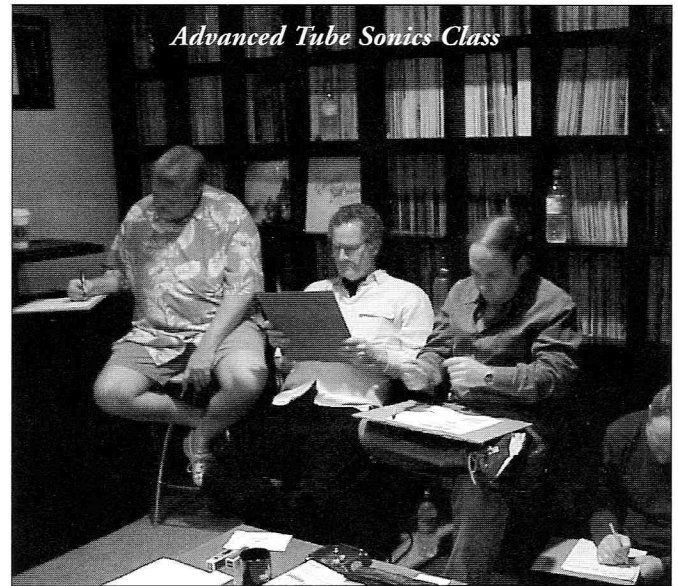

Reviewer comments included: smooth, liquid, clear, full-bodied dynamics, tight bass, detailed musical involvement, deep and natural sound stage, excellent pace and rhythm, nice highs and bass, top KT88! sweet and liquid, and awesome musical involvement. Total average score is 4.63 which is the highest of all the current production KT88s. The JJ KT88 is a best buy and highly recommended by VTV.

### Sovtek KT88EH

This is a new version of the Reflector KT88 and appears to be very well-built. Its glass shape is similar to the original MO Valve KT88 with noticeably thicker glass. The tube held stable bias and was able to handle the relatively high plate voltage of the Air Tight amp.

Reviewer comments included: smooth, liquid, wide dynamic range, excellent transparency, not veiled, deep and clear bass, recessed midrange, open and detailed sound, deep and wide soundstage, clean articulation, lean, dark, easy to listen to, neutral, similar to other Russian tubes, etc. Total average score is 4.16 for the Sovtek KT88EH. The Sovtek KT88EH is another good tube for low cost applications that require a reliable tube.

### Svetlana KT88

According to Eric Barbour, the SVKT88 was originally developed in 1998-2000 by Svetlana for McIntosh for use in their MC2000 150 wpc power amplifier. They a tube that was stable, powerful and had the same characteristics as the original MO Valve high vacuum, the final version KT88 was a huge success when it was introduced.

Reviewer comments included: turgid low bass, clear treble, bright frequency extension, vivid transparency, plummy low bass, slightly zippy, smooth and liquid, bass not as tight as Tung Sol, excellent mids and highs, bass bloom, detailed musical involvement, deep three-dimensionality, etc. Total average score is 4.09. The Svetlana KT88 is a very good tube for most applications that require a KT88 or 6550.

## 6550/KT88 Shoot Out for Hi-Fi

Tube Type	Coloration (subjective)	Dynamic Range	Transp arency	Frequency Extension	Musical Involvement	Three Dimensio nality	Pace and Rhythm	Total Average Score
Chinese 6550 Valve Arts 2002	Neutral, Harsh, Zippy	3.98	3.96	3.68	3.91	3.87	3.93	3.89
GE 6550A 1970s	Dry, Fat Bottom	4	4	4.1	3.71	3.46	3.4	3.78
Philips 6550 Sylvania 1970s	Smooth, Liquid	3.94	4.07	3.9	3.83	4.2	3.93	3.98
Svetlana SV6550C Reflector 2002	Dry, Full, Natural, Plump, Dark	4.09	3.93	4.06	3.91	3.76	4.1	3.98
Svetlana 6550 2001	Cool, Detached, Compressed	4.13	4.33	4.46	3.84	3.9	4.13	4.13
Tung-Sol 6550 1963 Grey PI	Liquid, Beautiful, Natural, Dark	4.66	4.61	4.67	4.89	4.89	4.89	4.77
Ei KT90 1999	Spacious, Neutral, Glassy	4.7	4.46	4.44	4.54	4.54	4.5	4.52
Genalex KT88 Gold Lion 1969	Relaxed, Gorgeous, Open, Warm	4.99	4.87	4.73	4.97	4.84	4.74	4.87
EH KT88 Reflector 2002	Natural, Bland, Dark	4.37	4.13	4.27	3.94	4.06	4.2	4.16
JJ KT88 2002	Tuneful, Vivid, Smooth, Liquid, Clear	4.61	4.66	4.46	4.76	4.5	4.79	4.63
Svetlana SVKT88 2002	Turgid Low Bass, Open, Clear, Lean	4.16	4.26	3.9	3.99	4.26	3.94	4.09

**Ei KT90**

Ei KT90s have been available since about 1990 when they were first used by David Manley in VTL amplifiers. KT90s are actually a modified 6KG6 sweep tube (minus a plate cap) originally designed as a horizontal video amplifier in TV sets. Since their introduction in 1990, there have been at least three versions of the KT90; but the latest one, Type 3, is the most reliable and has the best sonic characteristics. In addition, the Type 3 KT90 is electrically compatible with all 6550 and KT88 applications, while the two earlier versions were not.

According to a recent email to VTV from the president of Ei in Yugoslavia, the Ei tube factory was never bombed and is still producing quality vacuum tubes. KT90s are available from most tube vendors at reasonable prices.

Reviewer comments included: liquid, smooth, wide dynamics, very transparent, wide frequency extension, everything sounds right, perfect pace and rhythm, clean and spacious, no grit, really well-balanced, fast, incisive, neutral, slightly glassy, right sounding, warm, loud and smooth, great resolution, deep bass and very 3-D sounding. Total average score for the Ei KT90 is 4.52 which is excellent - the fourth highest score of the shoot out. These tubes are available for about the same price or less than most KT88s. The Ei KT90 is rated as a BEST VALUE and highly recommended.

**Conclusion**

The **Tung-Sol 6550** was voted the **Best 6550** of the shoot out. This tube was made from 1954 until the late 1970s when the Tung-Sol factory in Newark, New Jersey closed. It had several variations, which are described in greater detail in Eric Barbour's article starting on page 4.

The **Genalex KT88** was voted the **Best KT88** and the **Best Tube of the Shoot Out**. This tube did everything right. It had the magic of live music with huge tone, vibrancy and correct timbres. It lives up to its well-deserved reputation as king of the KT88s.

The **Ei KT90** was voted the **Best Value** of the shoot out. Reviewer comments included: wide dynamics, very transparent, deep and wide soundstage. It was liked by all the reviewers and many considered sonic characteristics on par with the Tung-Sol 6550.

The **JJ KT88** was voted the **Best New KT88** of the shoot out and is also a **KT88 Best Buy**. It was musical, powerful and had great dynamics.

If you try this yourself, your results may vary. However, you will have fun and learn something.

*Thanks to New Sensor, CE Distribution and Magic Parts.*

# 6550/KT88 Shootout: Guitar

By Charlie Kittleston ©2003 All Rights Reserved

For the most part, 6550s and KT88s are not used in guitar amps these days. Most players prefer the softer break up and crunch of 6L6s, 6V6GTs, EL34s, and EL84s. 6550s were used in 1970s and 1980s Marshall and Sunn amps as well as the venerable Ampeg SVT bass amps. KT88s were mated to the awesome 200 watt Marshall Majors that Hendrix and other rock artists used in the 1970s. It wasn't until fairly recently that there was any interest in 6550s and KT88s for guitar amps. With the advent of small single-ended guitar amps set up to take most octal power tubes, 6550s, KT88s and KT90s have found new homes in an electric guitarist's arsenal of tone.

Tube type, make and vintage are all important components in guitar tone. Unfortunately, most NOS audio tubes are getting more expensive, especially matched pairs and quads. However, it is easier and cheaper to find single NOS and good used tubes to experiment with. A few years ago, Curt Emery of Emery Sound in El Cerrito, CA, introduced the Super Baby, an amp that accepts most 8AC pinout output tubes. Andy Marshall at THD Labs with his THD Univalve amp has followed this. And now, even Groove Tubes has a single-ended amp that accepts 6V6s, 5881, EL34s, KT66, KT88, KT90s, 6550s and 6L6s, to name a few.

We were very interested in sampling most of the KT88 and 6550 types for guitar tone characteristics, so we contacted Andy Marshall of THD and he agreed to send us his Univalve SE guitar amp with matching 2-12 inch speaker cabinet. The Univalve is extremely popular with tone enthusiasts. We found it to be extremely versatile and is well made. In fact, at about \$1000 retail, we were simply amazed at the build quality of the amp.



As luck would have it, we assembled our tone crew comprised of local musicians and amp techs. Our tone panel consisted of Phil Loarie (resident tone enthusiast), Ron Veil (Uncle Spot himself), Curt Emery (amp builder and tech), Greg Cooper (San Francisco jazz and blues session player) and yours truly. Curt was so kind as to allow us to sample our tube collection in his hillside home with a view of the Golden Gate Bridge.

Greg Cooper served again as our guitar tone master. This time, however, he brought a guitar store with him; including a Fender Strat, Gibson ES347, Gibson ES175TD and a Gibson Les Paul Performer (double cutaway). Greg played in both the clean and overdriven modes using both single coil and humbucker pickups, with solid or archtop guitars. The Univalve functioned flawlessly and had literally hundreds of potential settings for clean, overdriven and other tonal modes. The amp allowed us to quickly change settings, power modes and degree of distortion as well as tone settings. Overall, the Univalve is a perfect amp for modern and contemporary rock sounds.

This test was done blind, in that the reviewers did not know what tube they were listening to. We rated the tubes on a scale of one to five, with five being the best. All tubes were rated subjectively and objectively by all the reviewers for both clean and overdriven modes. Categories of rating included: tonal coloration, dynamic range, break-up, crunch, punch, musicality and overall rating.

## 6550 Types

### Chinese 6550A

The new design 6550 is an improvement over earlier types. Many of you may remember the "fireworks in a bottle" trick that the early coke bottle Chinese 6550s displayed when they went ballistic. This resulted in many blown amps, speakers and frustrated amp owners. Well, the Chinese have done their homework and are now producing a stable, great-sounding 6550. It can now handle higher plate voltages with stable bias. In this test, it performed very well. Most reviewers felt the tube sounded quite good in the Univalve. It had musical break-up with complex tones and sweet, warm midrange. In the clean mode it was chimy and sweet. Overall, a great tube and a best buy. These are available from most tube vendors including Magic Parts, Antique Electronic Supply, etc.

Overall tone rating for clean mode is 3.9 and for distorted mode is 3.9.

### GE 6550A

GE's 6550A found a new home early on in the early 1970s when Sunn and Ampeg used this tube in their high power rock amps. Later, Marshall used it in their 50 and 100 watt heads. However, many players complained that the tube was hard sounding and did not have the same distortion characteristics of the EL34. One of the reasons Marshall may have switched to 6550s was that Mullard was winding down their EL34 production and quality probably slipped in the mid 1970s.

In the clean mode, the GE 6550A is dry and thin



## 6550/KT88 Shoot Out for Guitar Amps

Tube Type	Coloration (subjective)	Dynamic Range	Break-up	Crunch	Punch	Musical Vibe	Total Average Score
Chinese 6550 Valve Arts 2002	Warm tones, colorful in both overdriven and clean modes	Clean, good tonal range	Controlled break-up, early break-up	Complex, sweet, smooth	Great punch, good sustain	Musical	Clean 3.9 Distort 3.9
GE 6550A 1970s	Hard, thin, dry	Mid-rangy, thin	Quick break-up	Complex, nice	Harsh, mushy	Not musical Good for Power Rhythm	Clean 2.6 Distort 1.9
Philips 6550 Sylvania 1970s	Sweet and warm when overdriven, cold/harsh in clean mode	Nice harmonics	Complex, uneven, early break- up	Edgy crunch	Over the top, at little edgy	Good musicality	Clean 3.2 Distort 2.8
Svetlana SV6550C Reflector 2002	Warm when overdriven, a little colder/thinner in clean mode	Even harmonics	Great distortion	Loud, complex with rock chords	Sweet, hard rock sound, good definition	Great for heavy metal rock	Clean 2.6 Distort 2.3
Svetlana 6550 2001	Warm, sweet	Even harmonics	Good	Good	Hard rock sound	Great for heavy metal	Clean 2.3 Distort 2.3
Tung-Sol 6550 1963 Grey PI	Sweet, thick, warm	Very Good	Singing, sustains	Complex mids	Softer than others	Sweet, mid- rangish	Clean 2.3 Distort 2.3
Ei KT90 1999	Dull, dark, flat	Flat, dark	Even break-up	Well defined	Well defined	Good musicality	Clean 2.5 Distort 2.9
Chinese KT88	Sweet mids, bright	Nice overtones	Lively	Muddy, bloated	Sweet punch	Wide response	Clean 2.5 Distort 2.3
Genalex KT88 Gold Lion 1969	Clean, sweet, even	Very Good	Immediate, great with single coils	Slightly Compressed	Slightly compressed	Warmer, laid back quality	Clean 3.25 Distort 3.75
EH KT88 Reflector 2002	Buzzy, thin	Muffled	Nasal	Smearred	Not Complex	Thin sounding	Clean 2.2 Distort 2.1
JJ KT88 2002	Bright, articulate, thin, perfect for Soldano Amp	Mids and highs good	On the edge, mids constipated	No definition, weak	Hard, edgy	Good distortion	Clean 3.2 Distort 3.0
Richardson KT88 1996	Harsh, thin	Slightly recessed	Uneven, scooped mids, good distortion	No definition	Soft, mushy	Clear in clean mode, uneven in distorted mode	Clean 2.6 Distort 2.4
Svetlana SVKT88 2002	Clean, sweet	Excellent Response	Complex, vibrant	Modern, complex	Modern, complex	Excellent, top rated tube	Clean 4.2 Distort 4.1

sounding. In general, this tube is more of a hi-fi item. It has an incredible frequency extension, but mids are too harsh for the average guitarist. However, if you are into power rock rhythm chords, this tube may be your ticket for 1980s Marshalls. Break-up was quick, but not the most musical of the bunch. Our matched quad was not broken in and over the next 100 or so hours of operation, they will mellow out. As an NOS replacement in Ampeg, Sunn and some Marshall amps, it is an excellent choice. That's mainly due to its ability to handle high voltages-above and beyond the Chinese and Russian types.

Overall tone rating for clean mode is 2.6 and for distorted mode is 1.89.

### Philips 6550

Like the GE 6550A, the Philips 6550 was introduced in 1971, when heavy metal rock ruled. Loud was better and anything less than 100 watts was thought of as wimpy practice amp. Philips had purchased the original Sylvania

tube works in Emporium, PA and was also manufacturing fat bottle EL34s and fat bottle 6L6GCs. The Philips 6550 was probably used in early Sunn, Ampeg and other obscure guitar amps of the time. We believe that Philips did not make many of these tubes, as they are hard to find.

In the clean mode, the tube was warm and had nice harmonics. It had good break-up and crunch when pushed. Musicality was very nice.

Overall tone rating for clean mode is 3.2 and for distorted mode is 2.8.

### Svetlana SV6550C

In the early 1990s, the Svetlana 6550 became available to the Western world. It was a well-designed and reliable tube and continues to be. The latest version has a ribbed plate structure. The St. Petersburg Svetlana plant now uses their old "C" logo in a winged circle. However, some vendors still have

old stocks of the straight plate version with the "S" logo.

In the clean mode, with the Strat, tones were colored warm with even harmonics. However, break-up, crunch and punch were not the greatest. It sounded solid-statism. If you want loud and clean, this is your tube. In the distorted mode, the Svetlana SV6550C excelled. This is a good hard rock tube with nice break-up and punch. Punch was solid, making this a perfect hard rock or heavy metal tube. This is a perfect replacement tube for Ampeg, Marshall and Sunn amps that require this tube. It also works quite well in Leslies and other power amp applications.

Overall tone rating for clean mode is 2.3 and for distorted mode is 2.3.

### Svetlana (Reflector 2002) SV6550C

Mike Matthews at New Sensor has been the most devoted developer of audio and guitar tubes in the entire indus-

try. Mike has been instrumental in bringing reliable and reasonably priced tubes to the market. Since his relationship with the Reflector tube factory in Russia began in the late 1980s, Mike has brought a variety of 6550 and KT88 tubes in at very reasonable prices. The SV6550C from New Sensor is more of a hi-fi tube; at least that is what we found in this test.

In the clean mode, tonal coloration was thin and break-up was way too early. It does have crunch, but punch was hard and harsh. This one might be best left to hi-fi applications.

Overall tone rating for clean mode is 2.6 and for distorted mode is 2.3.

### Tung Sol 6550

The legendary Tung Sol 6550 has always been thought of as a musical tube for the hi-fi world. Hammond organ players prefer to use them in their vintage Leslie 122 and 145 rotary speakers for the warmest and sweetest tones. There are several variations of this tube that are described and depicted in Eric Barbour's article on page 4. Occasionally, they may have been used in 1970s guitar amps as a replacement tube. As the NOS tube supply dries up, the Tung Sol 6550 will become scarcer to find in matched pairs, let alone quads. Stock up now, for your lifetime stash, because if you think prices are high now, just wait a few years.

In the clean mode, it had warm mids with singing break-up and complex crunch. Musicality was sweet and easy to listen to. In the distorted mode, mids were nice and fat, but highs were not as extended as other 6550 types. In general, this is a warm and mid-rangy tube.

Overall tone rating for clean mode 2.3 and for distorted mode is 2.3.

## KT88 Types

### Chinese KT88

Shuguang and other Chinese tube factories are now producing good quality, low priced KT88s. They are primarily aimed at the tube hi-fi market, but are fun to experiment with in guitar amps.

In the clean mode, tonal coloration was a little bright, but sweet, and dynamic range was extended. Plus, they had nice harmonics. In the distorted mode they really came to life with lively break-up, perfect for rock and metal applications. Crunch and punch were nice, but a little on the bright side. For dark-sounding amps, this tube will lighten the tone. This is a real "Marshall" sounding tube for the hard rock enthusiast. Prices are very reasonable for the new Chinese KT88 and this tube is rated as a **Best Buy** by VTV.

Overall tone rating for the clean mode is 2.5 and for the distorted mode is 2.3.

### Ei KT90

Originally a horizontal video amplifier for TV sets, Ei



*Curt Emery, Phil Loarie, Greg Cooper and Ron Veil*

modified the KT90 in the early 1990s for use in VTL hi-fi amplifiers. This is a super beefy tube that can handle lots of power and abuse. Generally, it can be used as a replacement tube in many guitar amps that call for a 6550 or KT88. However, use caution if trying it in Marshall or Hi watt amplifiers, as their plate voltage can be too much for the KT90. KT90s are still available at reasonable prices from most tube vendors.

In the clean mode, tonal coloration was flat with good frequency response. Break-up was even and predictable. Crunch and punch were good with well-defined mids and highs. Musicality was very good. In the distorted mode, dynamic range was slightly recessed, but break-up was easy.

Overall tone rating for the clean mode is 2.5 and for distorted mode is 2.9.

### Genalex KT88

The first KT88s came from MO Valve and Genalex in 1957. They were first used in hi-fi amps, but eventually saw use in super power, 200 watt Marshall Major amps used by Jimi Hendrix and Ritchie Blackmore, as well as many other rock stars of the late 1960s and early 1970s. Production of the MO Valve KT88 ceased in the early 1980s and now they are priced in excess of \$250 each and up to \$1500 for a matched quad. In general, these are too pricey for the average electric guitarist.

In the clean mode, the MO Valve KT88 is clear and warm with complex crunch. Musicality was nice. In the distorted mode, dynamic range was good with great sustain. Break-up was immediate; crunch and punch were slightly compressed, but musical sounding. This is a top-rated tube in most applications, but costly and hard to find. If you get lucky and find some, check them out if you can afford them.

Overall tone rating for the clean mode is 3.25 and for distorted mode is 3.75.

### JJ KT88

Aspen Pittman worked with Tesla in the mid-1990s to bring a quality KT88 to the Western world. These were beautiful tubes available in clear, blue or red glass. However, reliability was spotty and due to management changes, Tesla was sold to JJ a few years later. Since then, JJ has been producing high quality tubes for the music

and hi-fi market including their excellent 6L6GC, E34L and EL84s types. Their new and redesigned KT88 is a very durable and stable tube that has seen great success in the hi-fi market.

We tried it in the clean mode and noted it to be slightly colored, with rolled-off highs. Break-up was a little weak. In the distorted mode, dynamic range was narrow, and it distorted very easily. Crunch and punch were edgy and powerful sounding. Ron Veil commented that this is a perfect tube for Soldano amplifiers, where they would perform better.

Overall tone rating for the clean mode is 3.2 and for the distorted mode is 2.95.

### Richardson KT88

When McIntosh reintroduced their legendary MC275 stereo power amp in the mid-1990s, Richardson Electronics produced a clone of the legendary Genalex KT88 specifically for that amp. They made a limited production run and stopped producing them after a couple of years. Since I had a matched quad of these laying around the shop, I figured what the hey, let's check em out.

In the clean mode, they sounded slightly thin with a slightly recessed dynamic range (scooped mids). Break-up was uneven and the crunch had little definition. In the distorted mode, tonal coloration was kind of harsh, but distortion characteristics were very good. Crunch was even, but mids scooped and punch was a little on the soft side. Musicality was very good, but these tubes will be almost impossible to find now. Richardson told me an Asian dealer cleaned out their entire stock of KT88s about 4 years ago.

Overall tone rating in the clean mode is 2.6 and the distorted mode is 2.4.

### Svetlana SVKT88

Another tube developed at the bequest of McIntosh was the Svetlana SVKT88. McIntosh was introducing their MC2000 – 150 WPC stereo power amp and needed a sturdy, reliable tube. Svetlana was put to the task, and after many prototypes, they developed the SVKT88. This tube is highly respected in the hi-fi world for its ability to handle high plate voltages and stable bias.

In the clean mode, tonal coloration was sweet and clean with excellent frequency range. Note articulation was very evident and musicality was very smooth. In the distorted mode, dynamic range was very even throughout the guitar's range. Break-up was very nice when driven hard. Crunch and punch were very modern sounding. Overall, the Svetlana SVKT88 is an excellent tube and highly recommended by VTV.

Overall tone rating in the clean mode is 4.2 and the distorted mode is 4.1.

### EH/Svetlana SVKT88 (Reflector)

The new "S" logo Svetlana SVKT88 is now available from New Sensor. Mike Matthews is now the new owner of the Svetlana US brand. These are similar in appearance to the original Svetlana, but sound completely different in the Univalve.

In the clean mode, tonal coloration was dark and sweet, but recessed. Dynamic range was slightly muffled, break-up was harsh and crunch was not very complex. In the distorted mode, they were a not as musical as some of the other KT88s in the test.

Overall tone rating for clean mode is 2.2 and for distorted mode is 2.1.

### Wrap Up

All of us agreed that this was a tough test for 6550s and KT88s. In general, most guitarists' ears are tuned to the softer, more predictable break-up of 6L6, 6V6, and EL34 tubes. The THD Univalve amp did a stellar job of handling any and all of the tubes we tested with absolute reliability. Univalve plate voltage in the higher power mode was right around 400 V, according to designer Andy Marshall. This is about 50-150 volts lower than the typical 6550/KT88 amp such as Marshall or Ampeg. In essence, the amp was not optimized for the higher power 6550 types, but it was the best choice for this test due to its ease of use and the ability to use just one tube without rebiasing every time we changed tubes.

Just for sake of comparison, we tried a few of the tubes in Curt Emery's Super Baby amp and noted that they sounded different than in the THD. Curt's amp has a tube rectifier, point-to-point wiring and a much simpler circuit. As always, your results may vary with your amp, guitar, tubes, speakers and ears. That's what's fun about these shoot-outs, you never know what to expect and you always learn something.

Surprisingly, the **Chinese 6550A** was the **best 6550** of the shootout (3.9 clean and 3.9 distorted), even exceeding the famed NOS Tung Sol! Tones were sweet, warm and chimey. Distortion was musical and predictable. Just remember that these cannot always handle the high voltage and current found in many amps like Marshall, etc. Also, they do not last as long as NOS GE or Tung Sol 6550s.

The **Best KT88** of the shoot out is the Svetlana (C Logo) SVKT88 (4.2 clean and 4.1 distorted). Clean note articulation was excellent and break-up was musical and sweet. These are extremely well made tubes and have a long service life. They are highly recommended for most guitar amp and pro-sound amps.

Much to the surprise of many, the famed NOS types did not do that well in our tests. They will sound different in a different amp with higher plate voltages including Marshall, Sunn, etc. amps. So if you are lucky enough to have matched sets of Genalex KT88s or Tung Sol 6550s, don't get rid of them just yet.

# VTV Pro Tube Shop

PO Box 1499

Lakeport, CA 95453 USA

www.vacuumtube.com 707-263-5881 Phone 707-263-7648 FAX

## New Tubes

Selected Low Noise

- 6L6GC JJ Matched Pair \$38
- 6L6GC JJ Matched Quad \$76
- 6L6GC Svetlana M/Pair \$39
- 6L6GC Svetlana M/Quad \$78
- 6SN7WGTB JAN/Sylvania \$35
- 6V6GT EH Sovtek M/Pair \$18
- 12AT7JJ \$12 ea
- 12AX7 Chinese \$12 ea
- 12AX7 Chinese 1991 \$16 ea
- 12AX7 Ei (flat plate) \$11.95 ea
- 12AX7EH Sovtek \$12.95 ea
- 12AX7S JJ \$15 ea
- EL84 JJ Matched Quad \$49
- EL34 Svetlana Matched Pair \$39
- EL34 Svetlana Matched Quad \$78
- EL34 JJ Matched Pair \$37
- EL34 JJ Matched Quad \$74
- 6550C Svetlana M/Pair \$65
- 6922 JJ \$18 ea (\$40 M/Pair)
- 6922 Sovtek \$14 ea (\$35 M/Pair)
- 6550C Svetlana M/Quad \$130
- 7591A EH Matched Pair \$45
- 7591A EH Matched Quad \$90
- KT66 Chinese Matched Pair \$72
- KT88 Svetlana M/Pair \$115
- KT88 Svetlana M/Quad \$230
- KT88 JJ Matched Quad \$190
- KT90 Ei Matched Pair \$100
- KT90 Ei Matched Quad \$200

## NOS Tube Treasures

- GE 5U4GB 1960s \$35
- Mullard EL84 \$175 Matched Pair
- 12AT7 JAN/Philips \$18 ea
- RCA 12AX7A 1960s \$75
- 7025 RCA 1960s (Fender amps) \$70
- 12AX7WA GE \$35 ea
- 12AX7A RCA 1960s \$85 ea
- 5814/12AU7 JAN \$18
- 7868 GE Matched Pair \$180
- Telefunken 1970s ECC81/12AT7 \$79
- 1963 Westinghouse 6V6GTA \$50
- 1972 Siemens 5814A/12AU7 \$50
- GE 6072A Black Plate 1963 \$65
- 1960s Sylvania 6SN7GTB \$75 ea
- Telefunken E88CC Platinum \$175 ea

## Auricaps - The Best Sounding

- Signal Capacitor We Know Of  
Super-High Quality with color-coded  
tinned leads. Polypropylene and Foil
- .01uf@600V \$4.75 ea
  - .02uf@600V \$5.05
  - .047uf@600V \$5.75
  - .1uf@600V \$8.75
  - .22uf@600V \$10.25
  - .47@600V \$14.25
  - 1.0uf@450V \$8.95

## High Voltage Electrolytic FP Can Capacitors

- 20,20,20,20uf@475V \$36 ea
- 40,20,20,20uf@525V \$48 ea
- 50,50uf @500V LCR \$24 ea (PC mt)
- 330uf@450V/clamp \$20 ea (PC mt)

## Illinois Capacitor ICMWR

*Vintage-Sounding Metallized  
Polypropylene Signal Caps*  
**The Best-Sounding Capacitor  
and for Vintage Tube Hi-Fi**

- .001uf@630V \$0.90 ea
- .0022uf@630V \$0.90
- .0033uf@630V \$0.90
- .0047uf@630V \$0.90
- .0068uf@630V \$0.90
- .01uf@630V \$1.00
- .015uf@630V \$1.25
- .022uf@630V \$1.10
- .033uf@630V \$1.20
- .047uf@400V \$1.20
- .047uf@630V \$1.25
- .068uf@630V \$1.35
- .1uf@400V \$1.25
- .1uf@630V \$1.40
- .22uf@400V \$1.50
- .22uf@630V \$2.00
- .47uf@630V \$2.50
- 1.0uf@400V \$3.50
- 2.2uf@400V \$3.75
- 3.3uf@250V \$4.00
- 4.7uf@250V \$4.50

## Illinois Capacitor Axial Electrolytic Capacitors

Great Value and Very Dependable

- 3.3uf@350V \$1.20
- 4.7uf@350V \$1.45
- 10uf@160V \$1.25
- 10uf@450V \$1.60
- 22uf@50V \$0.85
- 22uf@450V \$2.50
- 47uf@50V \$1.00
- 47uf@350V \$2.50
- 47uf@450V \$3.50
- 100uf@100V \$1.65
- 100uf@160V \$2.50
- 100uf@340V \$3.75
- 100uf@450V \$4.50

## Sprague Atom Axial Electrolytics

Made in USA Highest Quality

- 20uf@500V \$3.95
- 20uf@250V \$1.85
- 50uf@50V \$1.25
- 40uf@450V \$4.75
- 40uf@500V \$6.75
- 100uf@100V \$2.00
- 100uf@150V \$2.95
- 100uf@350V \$5.00

## Tube Sockets

- 9 pin NOS Micanol PC Mount \$4.50 ea
- 9 Pin Ceramic Chassis Mount \$2.50 ea
- 9 Pin Ceramic Chassis Mount \$2.00 ea
- Octal NOS Micanol Chassis Mt \$4.50 ea
- Octal Ceramic Chassis Mount \$3.00 ea
- Octal Ceramic PC Mount \$2.50 ea

**90 Day Warranty on All Tubes**  
**American Express, Master Card**  
**and VISA Credit Cards Accepted**  
**Shipping and handling extra**

**Call or Log in to our website for  
24 hour automated ordering.**

**707-263-5881**

**www.vacuumtube.com**

# VacuTrace™

## Vacuum Tube Curve Tracer

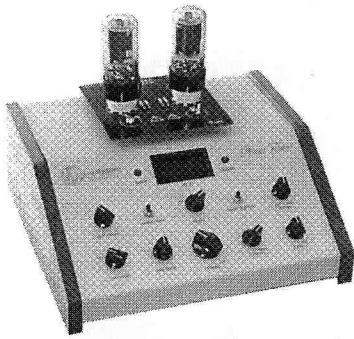

VacuTrace is your low-cost solution to accurate vacuum tube measurement. Quickly and easily generate characteristic curves for most popular audio and receiving tubes. Obtain static readings for voltage, current, transconductance and output conductance at any bias setting. \$1295



Now available with a flexible Jumper Adapter Card!

[www.hagtech.com](http://www.hagtech.com)

Hagerman Technology LLC  
PO Box 26437  
Honolulu, HI 96825 USA  
Phone: (808)-383-2704  
Fax: (808)-394-6076



# Vintage NOS Audio and Guitar Tubes Premium Quality



One of the largest selections of genuine, tested, premium grade NOS audio tubes for sale:

5U4GB	5AR4	6CA7	6L6GC
6SL7GT	6SN7GT	6V6GT	12AT7
12AU7	12AX7A	45	50
807	811	5687	5881
6201	6550A	6681	6922
7308	7355	7581	7591
7868	8417	EF86	EL34
EL84	396A	417A	KT66
KT77	KT88	KT90	MORE!

[www.vacuumtube.com](http://www.vacuumtube.com)  
**(707) 263-5881**

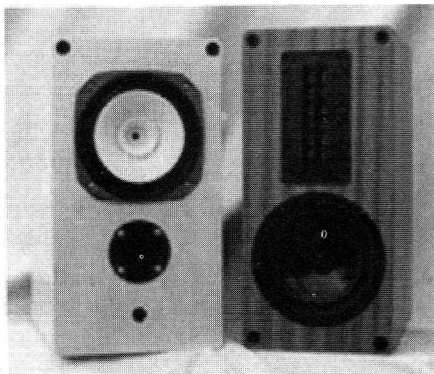

***Omega & Marathon***  
Affordable Crossoverless Single  
Driver and Ribbon 2-way High  
Efficiency Loudspeakers

***Perfect for all Tube Amplifiers***

Prices start at \$399/Pair  
8 Standard finishes  
Handcrafted in Norwalk, CT. U.S.A.  
10 Year Warranty  
Dealer program available  
203-847-2800

[www.omegaloudspeakers.com](http://www.omegaloudspeakers.com)  
[www.marathonspeakers.com](http://www.marathonspeakers.com)

***Pure Seamless Music***



When the deep  
purple falls ...  
And the  
stars begin  
to twinkle in  
the sky ...

**WE ARE NOT:** A repair facility. We repair the equipment we RESTORE, but we should not be confused with services which simply repair malfunctioning equipment. Our focus is the Restoration and Custom Enhancement of Vintage and Modern TUBE AMPLIFIER appearance and performance for use by our Client: not merely kept in some collection gathering rust and dust until the next Restoration Effort becomes necessary.

**WE ARE:** Consummate professionals, and exceptionally competent. A complete TUBE AUDIO EQUIPMENT RESTORATION SERVICE having 50 years experience with Tube Amplifiers of all types, sizes, and manufacturers. We can Restore your equipment, no matter what age or condition, to "like new, but different" or "nearly new" appearance, sounding as good as new or better, with an emphasis on extended reliability.

**TWILIGHT AUDIO**

c/o KARL M WIESSMANN -  
ELECTRONICS CONSULTANT (kmwec)  
9 Ridge Road - Lake Walkkill  
Sussex, New Jersey 07461-4307  
vox 973.875.2316 - fax 973.875.1172  
<http://www.twilighttubeaudio.com>

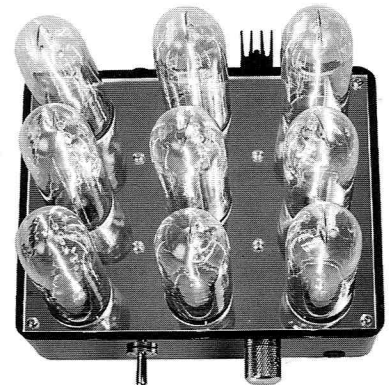

[www.TheTubeLamp.com](http://www.TheTubeLamp.com)

You will smile at my glowing tribute to glass audio.  
Two hundred twenty five watts of eye candy.

# VTV Dual Triode Characterizer

## The Best Tester *Ever* For Preamp Tubes!

List Price \$945 - Audiophile/Tech Price \$699



### Dual Triode Preamp Vacuum Tube Characterizer

Finally, an instrument-grade audio preamp tube tester for OEMs, tube dealers, audio techs and guitarists/audio enthusiasts. This valuable tool allows you to accurately test and grade new and old/used dual triode audio tubes. Our instrument performs tests on audio tubes that are not possible with Hickok and other radio/TV tube testers. It features a built-in four inch speaker and headphone jack so you can actually listen to the tube being tested for noise and microphonics. In addition, it tests for gain on both medium and high-mu types, triode balance and shorts. You can quickly check both triodes with the flick of a switch. This money-saving device is just what the doctor ordered for premium grading of audio tubes.

**Controls/Features:** Calibrated dual red illuminated meter (indicates gain and triode balance); toggle switches for power, 6/12 volt filaments, tube type selector, triode in test; rotary switch for high and medium mu, push-button for triode balance, volume control for audio output, high-quality NOS Micanol tube socket, BNC output for scope or distortion analyzer, four-inch internal speaker and headphone jack. It is housed in a sturdy, die-cast 3/16 inch thick metal enclosure.

**Tests the following dual triode preamp tubes:** 6CG7, 6FQ7, 6DJ8, 6922, E88CC, 7308, E188CC, 6SN7GT, VT-231, 6SL7GT, 12AT7, ECC81, 12AU7, ECC82, 5814, 12AX7, ECC83, 5751, 12SN7, 12SL7, etc.

\*Optional octal socket adapter and 9-pin socket saver are available for an additional **\$60**.

\*90 to 250V AC Universal Adapter for European or Asian Voltages additional **\$60 extra**

Available exclusively from: **Vacuum Tube Valley, PO Box 1499,**

**Lakeport, CA 95453 USA**

**707-263-5881 phone - 707-263-7648 FAX [www.vacuumtube.com](http://www.vacuumtube.com)**

## Introducing the world's smallest *triode* amplifier.

*That's right---*

*it's a true single-ended triode amplifier, and it fits in your coat pocket!*

Use it almost anywhere--home, office, on the road. Incredible sound from a tiny 5-pound package. Use with headphones or with high-efficiency speakers--delivers 1 watt/ch. of pure TRIODE stereo sound. Designed by VTV senior editor and longtime *Glass Audio* contributor Eric Barbour, the TM-4 is equipped only with NOS tubes.

only 8x5x3 inches!



# METASONIX

WWW.METASONIX.COM  
PMB 109, 881 11TH STREET,  
LAKEPORT CA 95453 USA - (707) 263-5343

AVAILABLE FROM VACUUM TUBE VALLEY AND OTHER MUSIC - ELECTRONICS DEALERS.

## ELECTRA-PRINT AUDIO

### Quality Handwound S.E. Output Transformers

- Primaries from 1.8K to 10K
- Exclusive wideband design
- Line Stage with Headphone Out
- Single Plate to PP Grids

### Custom-Built Power Transformers / Chokes

- Wound to your requirements
- Heavy-duty design for Class A use
- DC Filament Supply Windings
- HV chokes to 15H, 300ma
- Low voltage, high current filament chokes

Component Pricing and Specifications  
Catalog Available



**ELECTRA-PRINT  
AUDIO**

4117 Roxanne Drive  
Las Vegas, NV 89108

**702-396-4909 FAX 702-396-4910**



## Vintage Hi-Fi Equipment for Sale

Altec, Bell, Dynaco, Eico,  
Fisher, Harman-Kardon,  
McIntosh, Marantz, Pilot,  
Scott, Stromberg-Carlson, etc.  
**Power Amps, Preamps,  
Tuners, Receivers, Speakers,  
Crossovers, etc.**

Completely stock and original  
or fully restored, your choice.  
Our reputation for quality vintage  
hi-fi is the one of the  
best in the world!

**Check our website for  
the latest in cool vintage  
audio gear.**

**Charlie Kittleson  
PO Box 27**

**Lakeport, CA 95453 USA  
707-263-5881  
www.vacuumtube.com**

## SILVER SONIC™

Audio Cables

*Making the High End  
Affordable!*

"With tube amps and hybrids, the  
Silver Sonic competed with the best."  
*Bound for Sound*

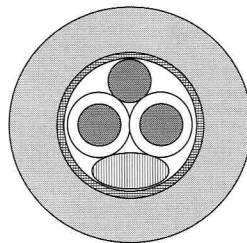

Silver Sonic T-14 Speaker Cable  
Silver Sonic BL-1 Series II Interconnect  
Silver Sonic D-110 AES/EBU Digital  
Silver Sonic D-75 Digital Cable  
Hook up wire & Connectors

D.H. Labs, Inc.  
612 N. Orange Ave., Suite A-2  
Jupiter, FL 33458  
(561) 745-6406 (phone/fax)  
www.silversonic.com

## Emery Sound

Lo-watt Tube Guitar Amps

*"indispensable in the studio,  
a great tone master..."*



*"the Superbaby sounds incredible!"*

**Buy Direct: 510.236.1176  
www.emerysound.com**

# EUROTUBES

IMPORTERS OF HAND CRAFTED EUROPEAN VACUUM TUBES AND HIGH-END AUDIO AMPLIFIERS BY JJ ELECTRONIC. "EXCELLENCE WITH EVERY DECIBEL"

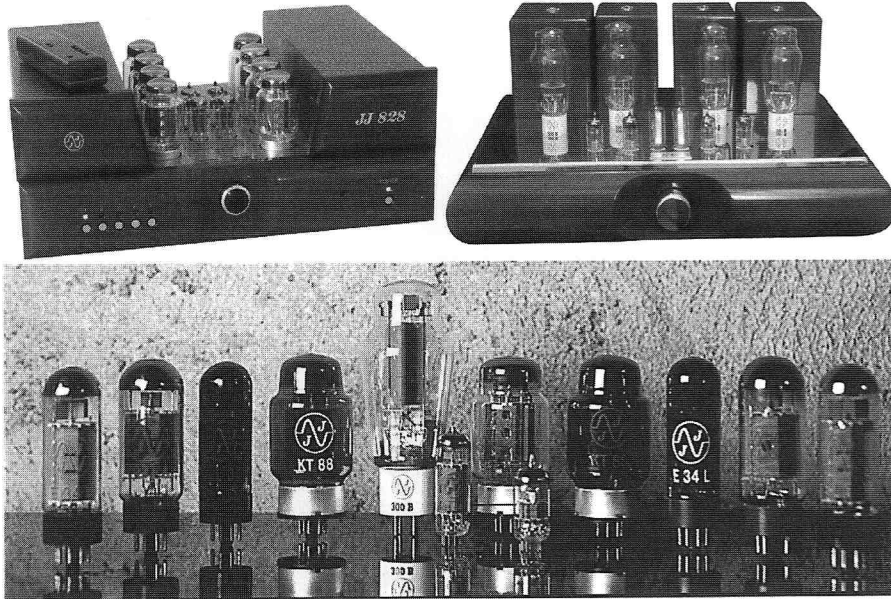

www.eurotubes.com

Eurotubes offers the full line of JJ Electronic vacuum tubes and high-end hifi amplifiers at wholesale prices, directly to the public.

The JJ 322 class 'A', single-ended amps surpass all other 300B amps in both power and sound quality.

The JJ 828 is an unvelievable power house of ultra linear sound quality.

We believe you will find these to be the very finest vacuum tubes and amplifiers being made today!

phone 503-659-7401

Chaffee **Hickok**  
And **TUBE AMP** service  
Alamo, CA.

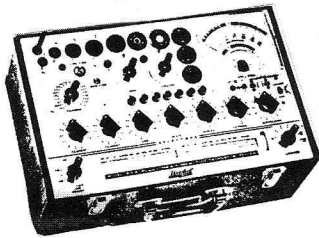

- Repair & calibration from 532 to Cardmatics
- **VINTAGE AMPLIFIER Repair/mod/upgrade**
- Economical shop rates
- Used **Hickoks** for sale.
- See website for testers And tube amp repair.  
[www.Tubewizard.com](http://www.Tubewizard.com)  
(Kara Chaffee, engineer at deHavilland)  
email: [6SN7@abac.com](mailto:6SN7@abac.com)  
Phone : (925) 837-7201

one electron

## Single-Ended Output Transformers

High Quality for a Reasonable Price  
Designed and Built in the USA



### UBT-1

Designed for parallel operation of:  
2A3s, EL34s, 300Bs, 6AS7s, etc. or  
Sweep-tube in "enhanced triode" mode  
1.6k primary  
15 watts  
160mA

\$99.00

### UBT-2

Can be used with:  
300B, 50, 5V81 I-3, etc.  
4.8k primary  
15 watts  
110mA

\$119.00

### UBT-3

Good for single ended:  
2A3 or 300B  
3k primary  
15 watts  
110mA

\$99.00

### BFT-1B

Designed for use with UBT-1s  
770vct / 520vct @ 340 ma  
6.3vct @ 9.6a  
6.3v @ 4a  
5vct @ 4a

\$169.00

quantity pricing available

NEW!

### P-RC-1 and P-RC-2 Audio Chokes

Designed for shunt-feed single-ended output applications, but are also useful where quality inductive loads are needed or as high-quality filter chokes. They have the same overall dimensions and use the same high-quality M6 laminations as the UBT transformers. Each have two identical windings, allowing series and parallel combinations.

6221 S Maple Avenue Tempe, AZ 85283  
ph: 480.820.5411 fax: 480.820.4643 or  
00.706.6789 e-mail: [info@tubesandmore.com](mailto:info@tubesandmore.com)  
[www.tubesandmore.com](http://www.tubesandmore.com)

## TUBE AMP BOOKS by Kevin O'Connor

Books boutique amp builders rely on:

THE ULTIMATE TONE - US \$55  
Modifying and Custom Building  
Tube Guitar Amps

THE ULTIMATE TONE - Volume 2  
Systems Approach to  
Stage Sound Nirvana US \$40

TONNES OF TONE - US \$25  
Electronic Projects for Guitar & Bass

The hifi hobbyist's reference:

PRINCIPLES OF POWER - US \$35  
A Practical Guide to Tube Power  
Amplifier Design

READY SET GO! - US \$20  
An Electronics Reference for  
the Everyman

SHIPPING: US add 5% surface or 10% air  
Int'l: add 10% surface or 40% air  
MC, VISA, cheque or money order

**POWER PRESS PUBLISHING**

PO Box 1777, Station B,  
London, Ontario, CANADA, N6A 5H9

Phone 519-668-3132 FAX 519-668-2055



# Purveyors of "Classic" Transformers & Enclosures

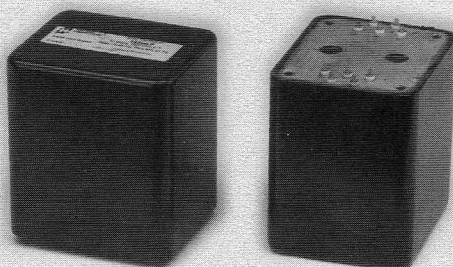
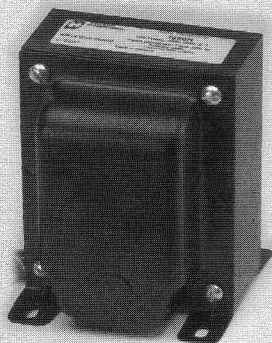

*Single Ended, Push-Pull  
and Potted Tube Output  
Transformers*



*Filter Chokes*

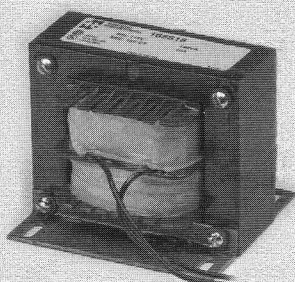

*Open & Enclosed  
Filament Transformers*

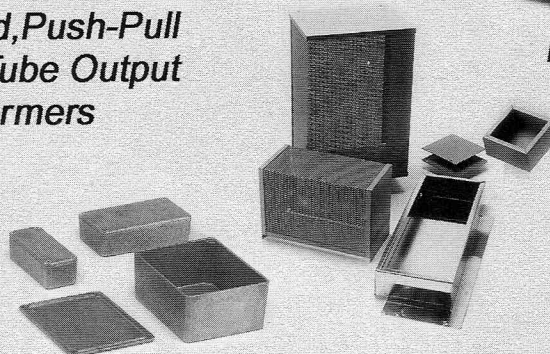

*Aluminum & Steel Chassis  
and Diecast Aluminum  
Enclosures*

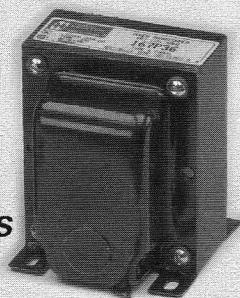

*High Voltage Plate  
Transformers*



*Contact us for a free catalog & list of stocking distributors*

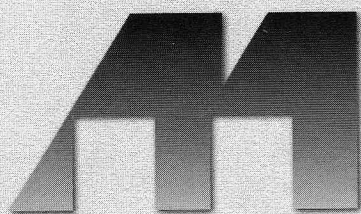

# HAMMOND MANUFACTURING™

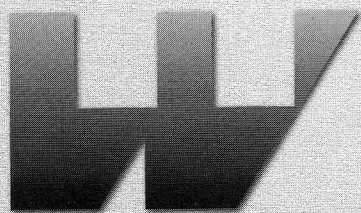

256 Sonwil Dr. - Cheektowaga, NY 14225 USA  
Phone: (716) 651-0086 Fax: (716) 651-0726  
394 Edinburgh Rd., N. - Guelph, Ontario N1H 1E5 Canada  
Phone: (519) 822-2960 Fax: (519) 822-0715

[www.hammondmfg.com](http://www.hammondmfg.com)

# VACUUM TUBE VALLEY

**"The finest tube-only magazine on the planet"**

Ken Kessler - Hi Fi News and Record Review - June 2000



**VTV #1 Spring 1995 \$15**  
Vintage Dynaco Tube Equipment - 1955-77  
History and Testing of the 12AX7/ECC83 dual triode  
Tube Testing Methods + Why Tubes Sound Better

**VTV #2 Fall 1995 \$15**  
Heathkit - The Tube Williamson Years 1950-61  
EL34/6CA7 History, Types and Tests  
Magnum SE EL509 Amplifier Project by Dave Wolze  
1927-34 Western Electric Theater Sound Systems

**VTV #3 Winter 1995/96 \$15**  
Eico Mono Tube Gear - 1955-62  
Altec Lansing 604 Coaxial Loudspeaker History  
Western Electric 300B History and Listening Tests  
300B SE Transformer Listening Tests

**VTV #4 Spring 1996 \$15**  
6L6 History, Types and Listening Tests  
Vintage Bookshelf Speakers 1955-1965  
Early FM Broadcasting History  
HK Citation I & II Amplifier History and Mods

**VTV #5 Fall 1996 \$15**  
The Ultimate FM Tuner Shoot Out  
Red Bank Guided Missile Tubes for Hi-Fi  
The Birth of the Marantz 10B  
Choosing Rectifier Tubes for your Guitar Amplifier

**VTV #6 Winter 1997 \$15**  
Fisher 500 - History, Models and Restoration  
A Tribute to Avery Fisher by the Fisher Doctor  
6550 and KT88 History, Types and Listening Tests  
Loftin-White Amplifier History by Alan Douglas

**VTV #7 Summer 1997 \$15**  
6DJ8, 6922 and 7308 - History and Tests  
Altec 1950s Theater Amps and Modifications  
The Great Voice - Peter Jensen Story  
Multi-Tube Line Stage Project - Eric Barbour  
Uncle Eric's Tube Dumpster - 417A/5842

**VTV #8 Fall 1997 \$15**  
EL84 History, Types & Listening Tests  
RCA Tube Mfg at Harrison, New Jersey  
200 watt OTL Amp Project by Allan Kimmel  
300B Listening Tests: NOS and Vintage Types  
Interview with Bruce Moore, Tube Audio Pioneer



**VTV #9 Spring 1998 \$15**  
Transmitting Tube Review, Ampeg SVT Guitar  
Amp, Altec 287W amp, Bargain Vintage Hi-Fi

**VTV #10 Summer/Fall 1998 \$15**  
Story of the 6V6 and listening tests, Hi-Fi radio  
in the 30s, PP SV572 amp, Ultrathat Line Stage

**VTV #11 Spring 1999 \$15**  
6SN7: History and Tests, Octal Line Stage  
Project, Mid-Priced Vintage High-Fi, OTL  
Headphone Amp, Capacitors and FREDs

**VTV #12 Summer 1999 \$15**  
2A3 History and Tests, 2A3 Amp Reviews,  
Bookshelf Speaker Test, Scott 299: History  
and Mods, 300 Watt SV572 Amp Project

**VTV#13 Winter 2000 \$15**  
6L6 Shootout, Paul Klipsch Interview,  
Klipschorn Lore and Mods, Scott 222 and  
LK-48, PP 2A3 Amp Project

**VTV #14 Summer 2000 \$15**  
12AX7 History and Tests (Guitar Amp Shootout)  
Elliano's Direct Reactance Preamp Project  
David Hafler - The Acrosound Years

**VTV# 15 Winter 2001 \$15**  
The 45 Triode - History and Tests  
RF-Powered Parallel Feed Amp Project  
David Hafler - The Dynaco Years  
12AX7 Hi-Fi Shootout

**VTV# 16 Spring 2001 \$15**  
The EL34 Complete History and Tests  
Ultra-Path Parallel Feed Amps  
Dating Philips Tubes and More

**VTV #17 Fall 2001 \$15**  
Rectifier Tubes For Audio  
6SN7 Line Stage Project  
Tube Amp Safety and More

**VTV #18 Spring 2002 \$15**  
Magic Eye Tubes, Rudy Bozak, Fisher  
FM100 Tuners, NOS Tube Investments, etc.

**VTV  
Subscription Rates**  
4 Issues / Year  
\$55/year US First Class  
\$45/year US Third Class  
\$60/Canada-\$70/Europe  
\$75/Asia & World  
Back Issue Orders add \$3.50  
ea for US orders, \$9.00 ea  
Foreign and \$4.00 ea Canada

**VTV Subscription and Back Issue Order Form (FAX or Mail)**

Name \_\_\_\_\_  
Address \_\_\_\_\_  
City \_\_\_\_\_ State/Country \_\_\_\_\_  
MailCode/ZIP \_\_\_\_\_ Telephone# \_\_\_\_\_  
I want to subscribe for \_\_\_\_\_ Years - Payment Encl. \_\_\_\_\_  
Send Me the following back issues \_\_\_\_\_  
Payment Enclosed (including shipping) \_\_\_\_\_

**VACUUM TUBE VALLEY**  
P.O. Box 1499  
Lakeport, CA 95453 USA  
Phone (707) 263-5881  
FAX (707) 263-7648  
email - triode@vacuumtube.com

Visit our on-line Pro-Tube Shop for the best  
selection of gourmet NOS audio tubes,  
quality tube amplifiers and more.

**www.vacuumtube.com**

# “a major artistic achievement”

Dr. Harvey Gizmo Rosenberg, [www.enjoythemusic.com/triode/tgawards](http://www.enjoythemusic.com/triode/tgawards)

**The best  
audio output  
transformers  
in the world  
— with specs  
to prove it.**

“The highest quality audio transformer  
I have ever heard.

Incredible low-end response.”

Alex Aguilar, President  
Aguilar Amplification, NY, NY.

“This new sample looks super!  
Congratulations to you and Menno on great  
design work. Consider this as an enthusiastic  
acceptance of production.”

Christopher Russell, VP Engineering  
Bryston Manufacturing, Peterborough, Ontario

“The build quality and reliability are  
excellent. ...simply the best...”

Gilbert Young, President  
Blue Circle Audio, Innerkip, Ontario

“...your design seems to be really elegant...”

Bill Chater, Journalist

“...absolutely amazed at the low  
frequency performance of your design...”

Dr. Vincent McGinn, Chairman Electrical Engineering  
Department, Northern Illinois University

## **Ultra Wide Bandwidth Toroidal Output Transformers for Tube Amplifiers**

- o Single Ended
- o Push - Pull
- o Triode
- o Pentode / Super Pentode
- o Cathode Feedback
- o Unity Coupled



We specialize in audio transformers.  
Since 1983 Plitron has supplied  
toroidal transformers to high-end equipment manufacturers.



8, 601 Magnetic Drive  
Toronto, ON, Canada M3J 3J2  
[www.plitron.com](http://www.plitron.com)  
e-mail: [techinfo@plitron.com](mailto:techinfo@plitron.com)  
1-800-PLITRON  
(1-800-754-8766)  
Tel. 416-667-9914  
FAX 416-667-8928

[www.plitron.com](http://www.plitron.com)



# EXTINCT?

You might think so, but we've probably got what you're looking for!

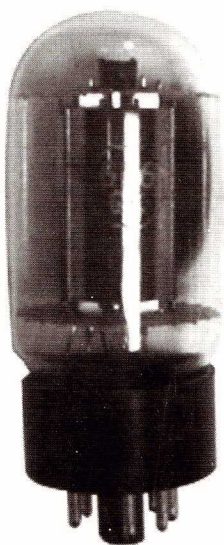

If you're looking for that unique mix of new and vintage components for a special project, Antique Electronic Supply has the right equipment. There's a good chance that we carry everything you're looking for, all in one place.

We specialize in vacuum tubes, both new-old stock and current production, and each tube comes with a guarantee! We also have a huge variety of transformers, capacitors, speakers, supplies parts, and books related to vacuum tube technology.

Contact us today to receive a free 100 page catalog or visit our website!



6221 S Maple Ave Tempe Arizona 85283 ph: 480.820.5411 fax: 480.820.4643 of 800.706.6789 e-mail: info@tubesandmore.com

[www.tubesandmore.com](http://www.tubesandmore.com)