

# Noise in Transistor Circuits

## 1. Mainly on fundamental noise concepts

by P. J. Baxandall\* B.Sc. (Eng.), F.I.E.E., F.I.E.R.E.

An enormous amount of literature exists on the theory of random noise, the theory and practice of low-noise amplifier design, and measuring techniques involving noise. However, for most engineers and physicists not specializing on noise topics as such, the need is to extract from this mass of knowledge a certain minimum amount of basic theoretical and practical information, sufficient to enable the normal types of noise problem which arise in the course of electronic work to be understood and dealt with in an intelligent manner.

The aim in this article is to provide this minimum basic information in, it is hoped, an easy-to-assimilate form, and to quote, for the benefit of those desiring to delve a little more deeply, a few references which have been found particularly worthy of attention.

### Gaussian Noise

The term "noise" has more than one technical meaning. For example, when computer engineers refer to "noise immunity" they are concerned mainly with the effects of unwanted but man-made interference caused by cross-talk between circuits in the computer, mains disturbances etc., and such "noise" does not have the full random properties of the really basic kind of "natural" noise which is inevitably present in all electrical circuits.

In this article, only truly random noise will be considered, i.e. noise generated by

random processes such as the thermal agitation of electrons or the random arrival of charge carriers at the collector of a transistor.

In all normal circumstances met in the design of practical amplifiers, the noise voltages and currents have a Gaussian distribution of instantaneous amplitudes†. The exact meaning of this statement is shown in Fig. 1, and the associated theory leads to the two facts enumerated in the caption.

It is very important to bear fact (1) in mind when noise measurements are being made, for it means that an amplifier used to provide a noise output of  $x$  volts r.m.s. must be able to handle instantaneous voltages of values approaching  $3x$  if significant errors due to overloading are to be avoided. This requirement is easily overlooked—for example, some mean-rectifier valve-voltmeters or transistor voltmeters do not have this signal-handling capacity and are therefore unsuitable for noise measurements.

### Appearance of Gaussian Noise

In Fig. 2, the top three photographs on the left, taken under "single-shot" conditions, show white Gaussian noise‡ after passage through sharp-cutting  $LC$  low-pass filters with the cut-off frequencies indicated. In all three cases, the timebase speed is the same, i.e. 5 ms per square. (The gains were

suitably readjusted to give a convenient size of waveform for clear photography.)

The top photograph on the right-hand side was obtained with the 600-Hz filter in operation, but with a 10 times slower timebase than that used for the 600-Hz picture on the left. It will be seen to have virtually the same appearance as the 6-kHz picture on its immediate left, which serves to emphasise that the appearance of such noise is controlled purely by the ratio of the timebase speed to the noise bandwidth and not by the absolute quantities involved.

The bottom photograph on the left was obtained by passing the wideband white noise through a 600-Hz noise-bandwidth circuit not having a sharp-cutting characteristic, but consisting of just a simple  $CR$  lag. This crude filter lets through, to some extent, quite high-frequency components of the noise, giving the picture a much "finer-grain" appearance than for the 600-Hz sharp-cutting filter whose output is shown in the picture immediately above it.

The bottom photograph on the right shows the appearance of white Gaussian noise after passing through a 1000-Hz selective circuit having a  $Q$ -value of approximately 23.\*\*

Whereas white noise, as already mentioned, has a flat spectral density curve, i.e. equal mean squared noise voltage per unit bandwidth throughout the spectrum, the terms "pink noise" and "red noise" are sometimes used, particularly in electro-acoustic work. Pink noise has a constant mean squared noise voltage (or power) per

Fig. 1. Gaussian noise. Facts: (1) instantaneous voltage lies within  $\pm 3$  times the r.m.s. voltage for 99.7% of the time; (2) using an ordinary mean-rectifier voltmeter (e.g. Avo), calibrated to read the r.m.s. value of a sine wave, we have: (r.m.s. noise voltage) =  $2/\sqrt{\pi} \times$  (meter reading).

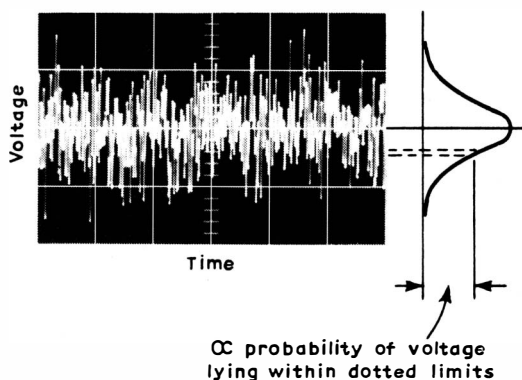
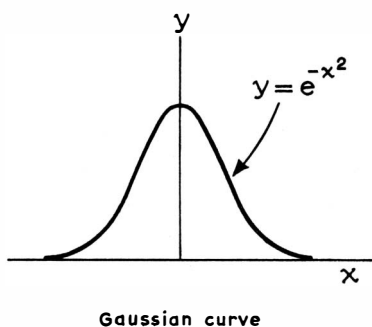

† The Gaussian curve, or normal distribution curve, is basic to probability theory. Suppose we toss a penny 100 times and note how many times it comes up heads. We now repeat the experiment many times, each time noting the number of heads that come up. If we now classify the results of all these trials into groups, e.g. 30 to 35 heads, 35 to 40 heads, 40 to 45, 45 to 50, 50 to 55 etc., and plot the number in each group against the head numbers just mentioned, we obtain an approximation to a Gaussian curve. See reference 1, p. 14 and/or reference 2, p. 369.

‡ By "white" is meant, by analogy with white light, that the spectral density, i.e. the mean square noise voltage per unit bandwidth, is independent of frequency.

\*\* The envelope of such a noise waveform, and therefore the output of a diode detector to which it is fed, does not have a Gaussian amplitude distribution—it can never have a negative value but can go without limit positively. The resulting unsymmetrical distribution of instantaneous values is called a Rayleigh distribution—see reference 2, p. 392.

octave, i.e. the mean squared voltage per unit bandwidth rises at 10dB/decade (3dB per octave) with falling frequency. (So-called flicker noise, excess noise, or "1/f" noise is of this type and is discussed later on.)

Red noise has an even greater low-frequency content, the mean squared noise voltage per unit bandwidth rising at 20dB/decade (6dB/octave) with falling frequency.

Fig. 3 shows examples of red noise—obtained by passing Gaussian white noise through a Blumlein integrator. For these pictures, unlike for Fig. 2, the system gain was left unaltered when switching from 6kHz to 600Hz bandwidth, and it will be seen that while reducing the bandwidth 10 times reduced the magnitude of the white noise voltage about  $\sqrt{10}$  times, as expected, the effect on the amplitude of the red noise was very small—because the biggest components of the red noise are at very low frequencies.

### Correlation

The concept of "correlation" is used later in this article, and will now be briefly explained.

When two noise voltages are produced by two completely independent systems, they are said to be "uncorrelated". If we were to photograph their waveform, under "single-shot" conditions, on a double trace oscilloscope, the wiggles on one waveform would be found to have no particular tendency to coincide with those on the other.

Suppose we connect two noise voltage sources in series, as shown in Fig. 4, where  $v_1$  and  $v_2$  refer to the instantaneous values. Then, if the voltages are uncorrelated, it is easily shown that:

$$\overline{v_{tot}^2} = \overline{v_1^2} + \overline{v_2^2} \dots (1)$$

(The bars signify "mean value of")

Since, by definition, the square of an r.m.s. value is the mean square value, equation (1) may be written in terms of r.m.s. values as follows:

$$V_{tot}^2 = V_1^2 + V_2^2 \dots (2)$$

from which:

$$V_{tot} = \sqrt{V_1^2 + V_2^2} \dots (3)$$

(No correlation)

When two noise voltage waveforms are of identical shape, differing only in magnitude if at all, they are said to be 100% correlated. Thus  $v_1$  and  $v_2$  in Fig. 5 are 100% correlated. The  $v_3$  waveform is an antiphase version of  $v_1$  and  $v_2$ , of somewhat smaller magnitude, and is said to have 100% negative correlation with respect to the latter waveforms.

It is obvious that under the conditions of Fig. 5, simple addition or subtraction of r.m.s. values must apply, so that, instead of equations (2) or (3), we now have:

$$V_{tot} = V_1 + V_2 \dots (4)$$

(100% positive correlation)

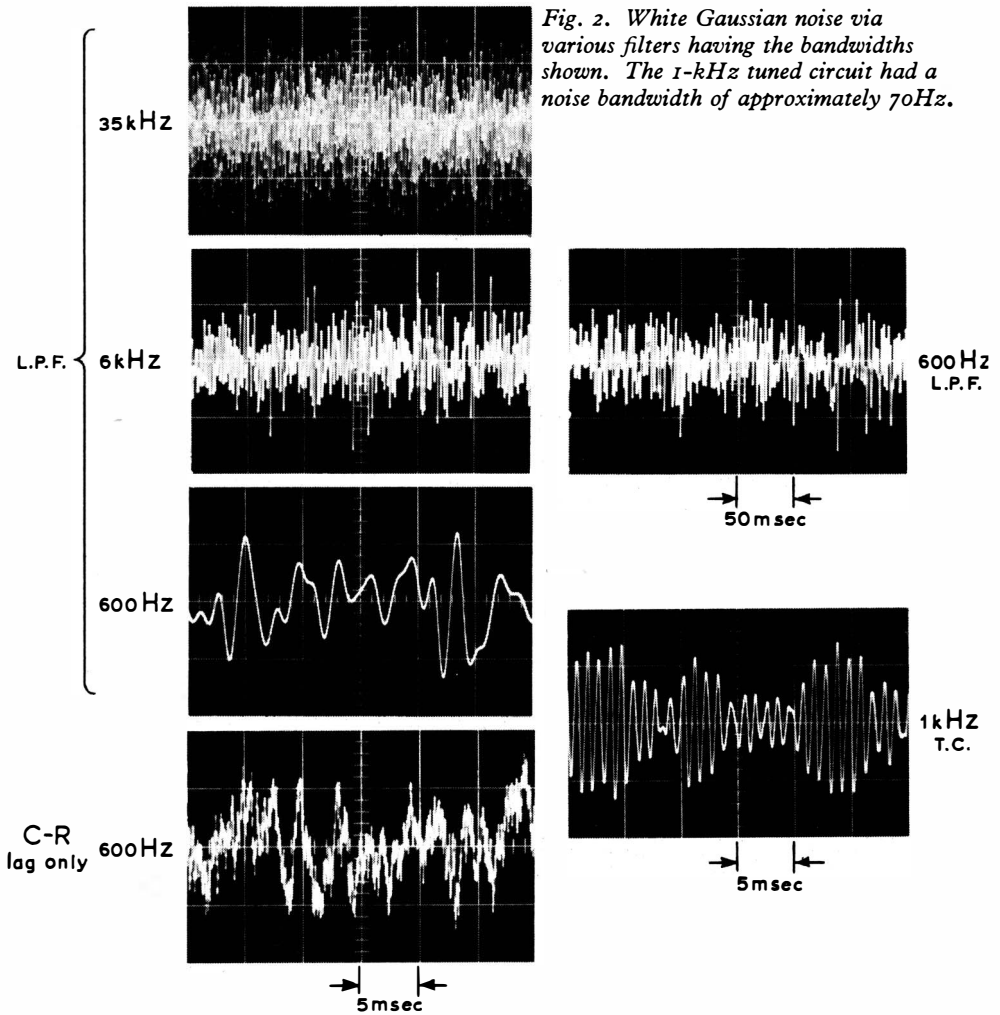

Fig. 2. White Gaussian noise via various filters having the bandwidths shown. The 1-kHz tuned circuit had a noise bandwidth of approximately 70Hz.

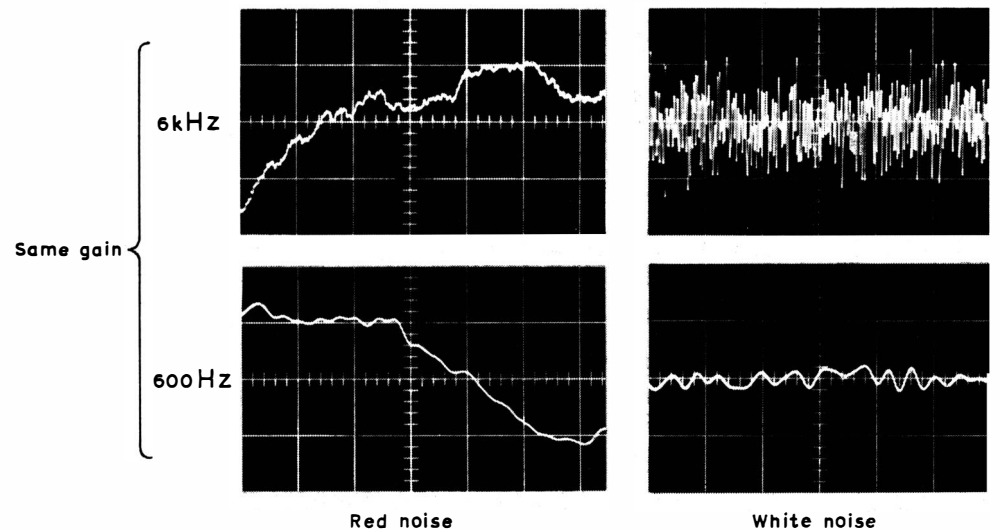

Fig. 3. Red noise and white noise. The time scale is 5ms per square in all cases.

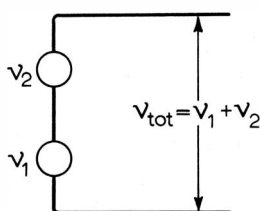

Fig. 4. (Above) Two noise sources in series.

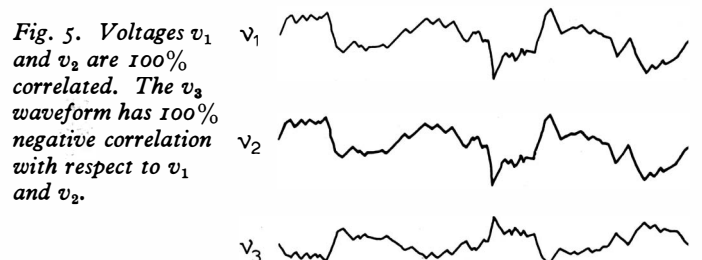
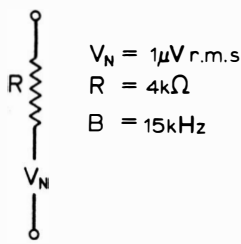
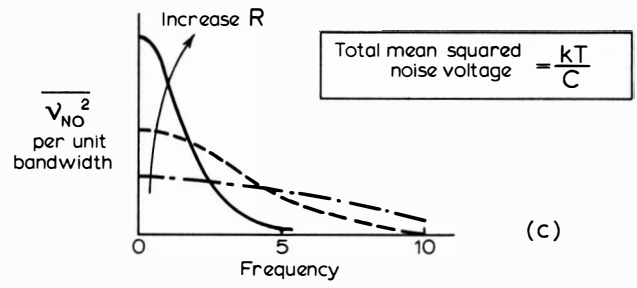

Fig. 5. Voltages  $v_1$  and  $v_2$  are 100% correlated. The  $v_3$  waveform has 100% negative correlation with respect to  $v_1$  and  $v_2$ .



(a)



(c)

Fig. 6. Thermal agitation noise (Johnson noise).

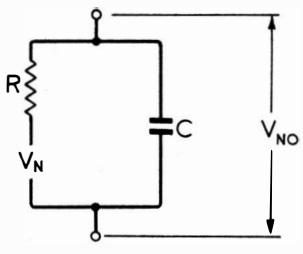

(b)

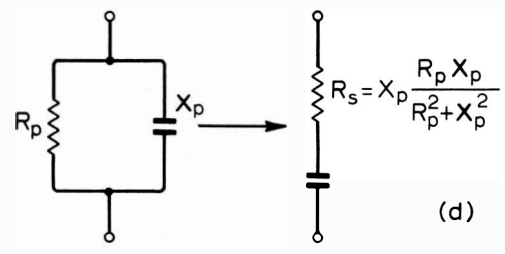

(d)

Fig. 7. Shot-noise current,  $I_N$ , in a reverse-biased diode.

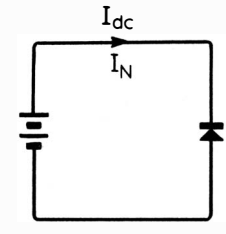

or  $V_{tot} = V_1 - V_3 \dots \dots (5)$   
 (100% negative correlation)

Two noise voltages which are only partially correlated often occur in practice, i.e. each contains some noise arising from a common source, but also contains some independently-generated noise. We then have:

$$V_{tot}^2 = V_1^2 + V_2^2 + 2\gamma V_1 V_2 \dots \dots (6)$$

(General case)

where  $\gamma$  is called the correlation coefficient and can have any value between +1 and -1.

When  $\gamma = 0$  (no correlation) it will be seen that equation (6) becomes the same as (2). When  $\gamma = 1$  (full "in-phase" correlation), (6) becomes:

$$V_{tot}^2 = V_1^2 + 2V_1 V_2 + V_2^2 = (V_1 + V_2)^2$$

or  $V_{tot} = V_1 + V_2$

which is the same as (4).

When  $\gamma = -1$  (full "antiphase" correlation), (6) becomes:

$$V_{tot}^2 = V_1^2 - 2V_1 V_2 + V_2^2 = (V_1 - V_2)^2$$

or  $V_{tot} = V_1 - V_2$

### Thermal Agitation (or Johnson) Noise

This mechanism of Gaussian noise voltage generation occurs spontaneously in all resistors, or any other devices having resistive, or partially resistive, electrical impedance, and involves the random thermal motion of electrons.

The basic relationship, giving the noise voltage acting in series with a resistance  $R$  as shown in Fig. 6(a), is:

$$\left. \begin{aligned} V_N &= \sqrt{4kTRB} \\ \text{or } \overline{v_N^2} &= 4kTRB \end{aligned} \right\} \dots \dots (7)$$

where:  $V_N$  = r.m.s. noise voltage in volts  
 $k$  = Boltzmann's constant =  $1.380 \times 10^{-23}$  joules/°C  
 $T$  = Absolute temperature in °K  
 $R$  = Resistance in ohms.  
 $B$  = Effective bandwidth in Hz over which the noise is measured.

Equation (7) is often called Nyquist's formula. The background to its discovery in 1928, and ways of deriving it, are discussed in the pages following page 385 of reference 3.

To facilitate rapid determination of approximate noise voltages, it is worth committing to memory a set of values such as those shown in Fig. 6(a), which apply to room temperature conditions.

The Nyquist formula is actually a very fundamental one, being applicable to mechanical systems as well as electrical ones. Thus, if we have a viscous mechanical resistance which is constrained to have no velocity between its ends, the Nyquist formula enables us to calculate the random mechanical force developed. It may be used, for example, to calculate the random motion imparted to a capacitor microphone diaphragm by the viscous damping present<sup>4</sup>.

The Nyquist formula predicts that an infinite resistance should generate an infinite noise voltage, yet there is no evidence of this happening in practice! This is not because the theory is in any way wrong, but simply because of the inevitable presence in practice of stray capacitance. Thus any practical resistor and its associated wiring inevitably looks more like a resistor and a capacitor in parallel, as shown in Fig. 6(b). As we increase the resistance, we increase  $V_N$ , but, at any finite frequency, we also increase the attenuation of  $V_N$  produced by the  $R$ - $C$  circuit. Except at low frequencies, the increase in voltage attenuation (approx.  $\propto R$ ) more than outweighs the effect of the increase in  $V_N$  ( $\propto \sqrt{R}$ ), and the noise voltage obtained at the terminals thus varies as shown in the graphs of Fig. 6(c).

The value of  $V_{NO}$  (Fig. 6(b)) may be calculated in either of two ways. The first way is to calculate  $V_N$  from the Nyquist

formula, and then determine, at any given frequency, the attenuation of  $V_N$  produced by the  $CR$  circuit.

The second way is to determine, at the given frequency, the series combination of  $R$  and  $C$  which is equivalent to the original values in parallel, using the formula shown in Fig. 6(d). The noise voltage at the terminals is then simply that given, according to the Nyquist formula, by the series resistance  $R_s$ . Both methods give, of course, exactly the same answer.

The above methods enable us to calculate the noise voltage, or the mean square noise voltage, in a small band of frequencies centred on any given frequency. However, because of the filtering action introduced by the shunt capacitance, the noise output is quite finite even if considered over an infinite bandwidth, and it is of practical interest to calculate this total noise output.

The total mean square noise output voltage of the Fig. 6(b) circuit may be obtained, using either of the above methods, by integrating the noise output (mean square) in each small bandwidth from zero to infinite frequency. If this is done (and the integration is not difficult) it will be found that the answer is independent of  $R$ , which is equivalent to saying that the areas under the several curves shown in Fig. 6(c) are all the same. The total mean squared noise voltage turns out, in fact, to be equal to  $kT/C$ , and this simple result may also be obtained by equating the mean thermal noise energy per degree of freedom,  $\frac{1}{2}kT$ , to the mean energy,  $\frac{1}{2}CV^2$  stored in the capacitor.

An important practical consequence of the above matters is that, in low-noise amplifiers designed to operate from capacitive signal sources, such as capacitor microphone amplifiers or TV camera head amplifiers, the shunt resistor value in the input circuit must be made very high to keep the noise at signal frequencies down to an adequately low value—it is desirable to make the value much higher than mere considerations of frequency response would demand.

To conclude this section on Johnson noise, it is worth noting that whereas the Nyquist formula is usually given in the

form of eqn. (7) already mentioned, it may be rearranged to give the short-circuit noise current of a resistor instead of the open-circuit voltage; the formula then becomes:—

$$\left. \begin{aligned} I_N &= \sqrt{4kTB/R} \\ \text{or } i_N^2 &= 4kTB/R \end{aligned} \right\} \dots \dots (8)$$

### Shot Noise

In devices such as thermionic valves, semiconductor diodes, and transistors, one of the mechanisms of noise generation is known as shot noise, and involves the fact that the output current is not smooth and continuous but is the sum of numerous small pulses caused by the passage within the device of discrete electronic charges.

When plenty of reverse bias voltage is applied to a semiconductor diode as shown in Fig. 7, the magnitude of the current fluctuation which constitutes shot noise is given by††:

$$\left. \begin{aligned} \overline{i_N^2} &= 2qI_{dc} B \\ \text{(or } I_N &= \sqrt{2qI_{dc} B}) \end{aligned} \right\} \dots \dots (9)$$

†† This is sometimes known as the Schottky formula—an amusing instance of a man having a name peculiarly well suited to his work! The basic derivation of this formula is discussed very clearly in reference 2, page 200.

where:  $q$  = electronic charge  
 $= 1.60 \times 10^{-19}$  coulomb.  
 $I_{dc}$  is in amps.  
 $B$  is in Hz.

For equation (9) to apply, three fundamental conditions must be satisfied:

- (a) All the carriers must have the same charge.
- (b) The frequency range of interest must be small compared with the reciprocal of the transit time across the vacuum or semiconductor junction—otherwise the shape and duration of each pulse becomes significant.
- (c) The motion of any one charge carrier must be statistically independent of the motions of the other charge carriers.

In addition, the frequency band over which the noise is measured must be high enough to avoid a significant contribution from flicker effect, and the bias voltage must be well below the breakdown voltage—otherwise excessive noise of a “spiky” nature will occur.

While the above conditions are sufficient to ensure that the noise will be white, a further condition must be satisfied if the noise waveform is to have a Gaussian distribution of instantaneous values, viz:

- (d) A large number of charge carriers must arrive during a period equal to the reciprocal of the system’s bandwidth.
- (This last condition is normally very fully

satisfied, since one milliamp corresponds to the arrival of about six thousand million electrons every microsecond! However, the noise output from a photomultiplier tube may cease to be Gaussian at exceedingly low light intensities because of failure to satisfy condition (d).)

To give some physical insight into these matters, an experimental system was set up, and gave the waveforms shown in Fig. 8.

Normal Gaussian white noise, as illustrated in Fig. 1, was fed at high level to a limiter circuit with trigger action, so that the output voltage made traversals between the two limiting values every time the input noise waveform crossed zero. Waveform (a) was obtained with an input noise bandwidth of 6 kHz, waveform (b) being with the bandwidth reduced to 600 Hz.

Waveform (c) is as for (b), but a 100  $\mu$ s a.c. coupling has been introduced. For waveform (d), a biased-off amplifier stage was inserted, capable of passing only the positive peaks of the previous waveform.

Waveform (e) is seen to consist of randomly-timed uni-directional impulses of constant magnitude‡‡, and may be taken to represent the output current of a device exhibiting shot noise and operating at an extremely small current. (A waveform like this can be obtained from a photo-multiplier tube, as already mentioned.)

In practice, the output load resistor of a device exhibiting shot effect is likely to have a significant amount of stray capacitance across it—this is represented in Fig. 8(e), for a shunt capacitor value giving a time-constant of 0.6 ms.

In waveform (f), the bandwidth of the input noise has been increased from 600 Hz to 2000 Hz, giving a correspondingly larger mean number of pulses per second. It will be observed that an output pulse now frequently occurs before the effect of the previous one has died out, and that the mean d.c. level has risen noticeably.

In waveform (g), the input noise bandwidth has been further increased, to 6 kHz. The fine detail in this waveform is due, of course, to the individual pulses, but it is evident that there is an increase in the low-frequency random variations also. It was mentioned that, in real life, a very large number of pulses normally occurs in a time equal to the reciprocal of the maximum frequency reproduced, so that the fine detail due to the pulses themselves will not then be seen. An attempt to simulate this state of affairs is shown in (h), where the simple filter shown has been inserted at the c.r.o. input to attenuate the high-frequency components. The two waveforms in (h) both have their zero at the bottom of the picture, and were obtained with noise bandwidths of 400 Hz and 3 kHz at the input to the limiter. It will be seen that the filtering action is not severe enough to remove evidence of the pulses themselves from the lower trace, but has almost done so in the upper trace, which consequently looks almost like normal Gaussian noise. For waveform (j), also for 400 Hz and 3 kHz input bandwidth, the capacitors in the CR filter shown were increased to 0.5  $\mu$ F each,

Fig. 8. Waveforms illustrating shot-noise principles. The zero-levels are marked “o”. All waveforms except (j) have a time scale of 5ms per square. A filter of the form shown was inserted before the c.r.o. for waveforms (h) and (j)—see text.

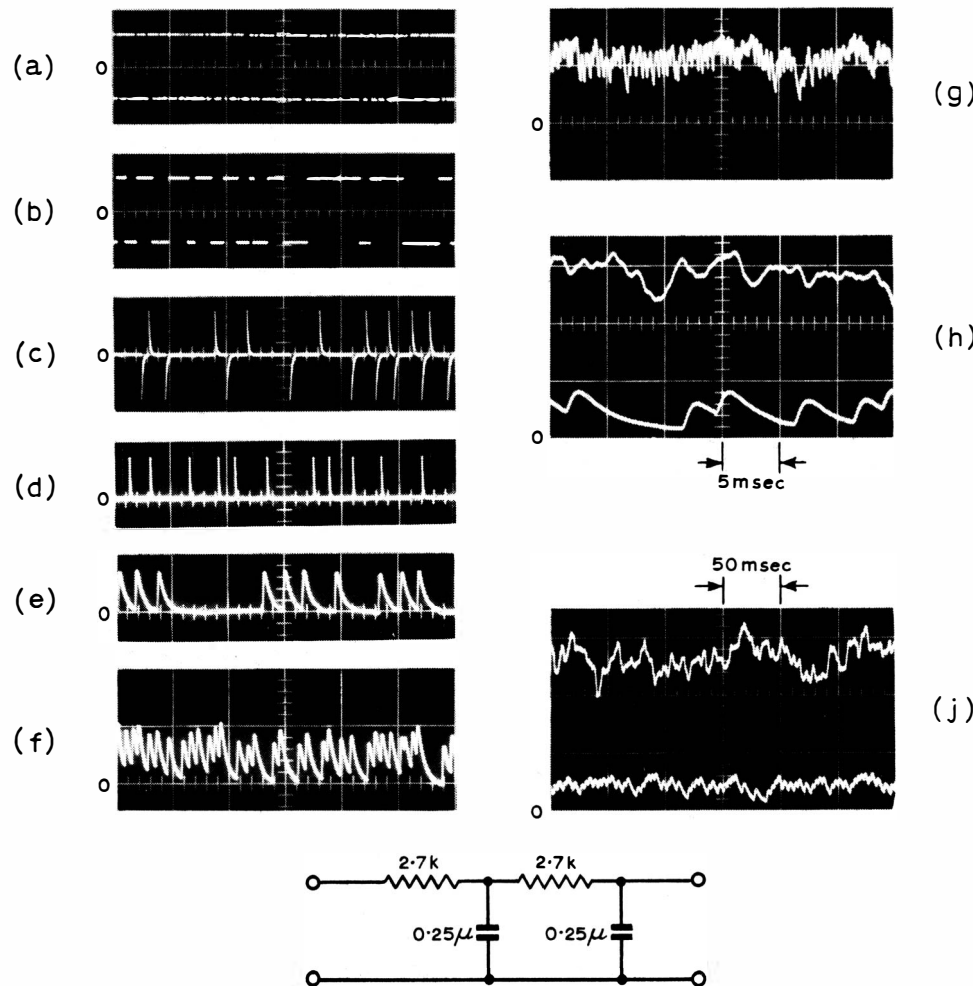

‡‡ While this is white noise (up to a certain frequency), it is far from having a Gaussian distribution.

and the timebase is ten times as slow. It is now seen that the noise amplitude increases as the mean current increases, and that even the lower trace shows some semblance of a Gaussian distribution.

(Note: In waveform (e), it will be seen that the sharp vertical edges of the pulses are all of substantially equal heights, whereas in (f), and to an even greater extent in (g), this is not always true. This is a defect of the system very hastily rigged up, and occurs because, at high mean pulse rates, a negative-going pulse (see waveform (c)) sometimes occurs so soon after a positive-going one that it prevents the unidirectional pulse (see (d)) generated from the positive going pulse from having as large an area as it should have. This defect, however, does not invalidate the general conclusions.)

The Schottky formula, i.e. equation (9), may be used to determine the shot-noise current in a semiconductor diode to which a constant d.c. voltage of either polarity is applied, *provided the diode current is virtually all reverse current or all forward current*. Referring to the diode equation below, this means one of the terms "A" or "B" must dominate. However, when the applied voltage is very small,

$$I = I_0 \left( \frac{e^{qV_{ac}/kT}}{A} - 1 \right) \dots (10)$$

the two terms are of the same order, and then each will contribute its own separate component of shot noise. Since the two components are uncorrelated, the total shot noise current is given by:

$$\overline{i_N^2} = 2qBI_0(e^{qV_{ac}/kT} + 1) \dots (11)$$

In particular, when  $V_{ac} = 0$ , the above equation shows that we get equal contributions from the two terms, giving:—

$$\overline{i_N^2}_{V_{ac}=0} = 4qI_0B \dots (12)$$

Now by differentiating equation (10) above with respect to  $V_{ac}$ , it is easily shown that:—

$$I_0 = \frac{kT}{qr_0} \dots (13)$$

where  $r_0$  is the small signal a.c. resistance of the diode with zero d.c. voltage applied.

Hence equation (3) above becomes:—

$$\overline{i_N^2}_{V_{ac}=0} = \frac{4kTB}{r_0} \dots (14)$$

This, as one would expect, agrees with equation (8), the Nyquist formula for the short-circuit Johnson noise current from a resistance, and indeed points the way to one method for proving Nyquist's formula.

A further interesting fact easily deduced, is that if a semiconductor diode is forward biased, so that the forward shot noise component dominates, then the mean squared noise current in the diode (if biased by a fixed voltage), or the noise voltage across the diode (if biased by a fixed current), is of only half the magnitude which would apply for a resistor having a value equal to the diode a.c. resistance.

That a device can produce *less* noise than pure Johnson noise, yet have a purely resistive impedance, may seem very surprising at first sight; but it should be noted that a diode passing current is receiving energy and is not in thermal equilibrium—thus violating a basic assumption on which the theory leading to the Nyquist formula is based. (Another situation giving less noise than would be predicted by the Nyquist formula is when we obtain a low resistive impedance at the input of an amplifier by means of shunt negative feedback via a high value of feedback resistor—this resistive input impedance is also unusually noise-free.)

If we feed a diode with steady d.c. from a high voltage supply via a high resistance, there cannot be any appreciable shot noise current, so the charge carriers must traverse the diode junction at regularly spaced time intervals. It would seem a fair question, however, to ask how the carriers inside the diode know they must behave in this noise-free manner! The answer, of course, is that the voltage across the diode develops a random noise fluctuation of just the right magnitude to make the carriers arrive at a constant rate. This effect is somewhat similar, in essence, to the "space-charge smoothing" effect in a thermionic diode in which the available emission from the cathode is much greater than necessary for supplying the anode current. A cloud of electrons, or space charge, forms near the cathode, and movements of this space charge under the influence of the anode current charge carriers affects the velocities of the latter in such a way that they arrive at the anode with less randomness of timing than would be the case if there were no space charge.

In semiconductor diodes, under normal circumstances, there is no space-charge smoothing, and "full shot noise", as given by the Schottky formula\*\*\*, is obtained. The main complicating factor in practice is flicker noise, but this will be discussed later.

## REFERENCES

1. "Fluctuation Phenomena in Semi-Conductors" by A. van der Ziel. Butterworths Scientific Publications, London (1959). This is mainly concerned with transistor noise theory, and includes a chapter on flicker noise. There is a short summary (10 pages) of mathematical methods—probability, correlation, etc.—but the book gives little information on circuit design aspects.
2. "Information Transmission, Modulation, and Noise" by M. Schwartz. McGraw-Hill (1959). This book, though fairly advanced, has the great virtue for engineers of using only the simple sort of mathematics most of us can understand! Chapter 7, on Statistical Methods, is an excellent summary of many important ideas. Noise in a.m. and f.m. radio systems is discussed very clearly. The section on semiconductor noise (13 pages) is a brief but useful summary.
3. "Frequency Analysis, Modulation and Noise" by S. Goldman. McGraw-Hill (1948). This is another very good book, which deals with some of the thermodynamic fundamentals

\*\*\* The shot noise formula is usually given in the form shown in Fig. 5, i.e.  $I_N^2 = 2qI_{dc}B$ . If, however, the device giving shot noise is fed with constant current, then the shot noise voltage across it is given by:  $e_N^2 = 2qI_{dc}B \times r^2$ , where  $r$  is the small-signal a.c. resistance of the device.

of noise much more fully than the above two references. (It also has a very full and clear treatment of Fourier principles for steady-state and transient analysis of radio problems.)  
4. "Noise in Condenser Microphones" by A. G. T. Becking and A. Rademakers. *Acustica*, Vol. 4. No. 1, p. 96. (1954).

## Improved 525/625 TV Standards Converter

One major drawback of the B.B.C.'s existing television standards converter\* for converting American 525-line pictures to British 625-line pictures—a black border round the displayed picture—has now been overcome, as viewers of the Mexico Olympic Games programmes will have seen. A new type of electronic converter, developed by the B.B.C. Research Department, has been put into operation at the B.B.C. Television Centre, London, and this redistributes the information from the American 525/60-field p.s. pictures into European 625/50-field p.s. picture format in a different and more complex manner.

The redistribution is achieved partly by an "interpolator" which, from the 525/60 input signal, produces a new set of lines together with an extra 50 lines during each input field, and puts into these "empty" 50 lines (100 for a complete picture) signal information obtained by interpolation. The process involves filling in information between adjacent lines of an input field, and in order to derive the correct signal values to be interpolated one television line must be temporarily stored until the next arrives. This is done in ultrasonic delay units of one-line delay time. There is also signal interpolation between adjacent lines of a picture, and this requires ultrasonic stores of one-field delay time.

Since each input field already has its full complement of lines the generation of 50 extra lines means that occasionally two separately interpolated lines occur simultaneously. The output of the interpolator is therefore fed into a unit called the main store which re-times the lines so that they emerge in a continuous train, and this process of re-timing results in the expansion of each "American" field by  $3\frac{1}{3}$ ms to the full time of a British field (20ms). In the final displayed picture it is not possible to point to particular lines and say that these are the "extras" because in fact the interpolated signal information is distributed over the entire picture.

The earlier standards converter entailed the use of an intermediate video tape recorder because the American/British field frequency ratio is not the integral ratio of precisely 6:5 required by that converter but actually 59.94:50. In the new machine this problem has been avoided in the timing system, which allows a non-integral ratio to exist between the input and output field frequencies, so that now direct "live" standards conversion is possible.

\*Colour TV Standards Converter", *Wireless World*, Oct. 1967, p.476.

# Noise in Transistor Circuits

## 2. Noise figure : Negative Feedback : Measurements

by P. J. Baxandall\* B.Sc. (Eng.), F.I.E.E., F.I.E.R.E.

The theoretical mechanisms producing noise in transistors have been thoroughly investigated by Van der Ziel and others in several important papers<sup>5,6,7,8,9</sup>. While these papers are by no means easy to read and understand, some quite simple and useful conclusions may fortunately be deduced from them.

Equivalent circuits representing the internal noise mechanisms of a transistor have usually been of the common-base T type<sup>1,8</sup>. However, the advantages of thinking in terms of the hybrid  $\pi$  equivalent circuit for noise purposes<sup>10</sup> are considerable, just as they are, in the author's opinion, for other aspects of transistor circuit work. Further, a

very welcome simplification of the noise theory as put forward by Van der Ziel can now be made, because the thermally-generated leakage currents, which play a significant role in determining the noise performance of germanium transistors, can normally be neglected when silicon planar transistors are used, as will usually be the case nowadays.

With this simplification, and ignoring flicker noise for the time being, there are three significant noise mechanisms in a transistor, which are very easily remembered when described in the following manner:

- (a) Johnson noise in the extrinsic base resistance  $r_{bb'}$ .
- (b) Shot noise on the base current.
- (c) Shot noise on the collector current.

The corresponding three generators, which are uncorrelated at low frequencies, are shown in Fig. 9(a), and are shaded to emphasise that they are noise generators in contrast to the normal "mutual conductance" generator of the hybrid  $\pi$  circuit.<sup>†</sup>

It should be emphasised that the Fig. 9(a) circuit is based on low-frequency considerations only, and that the noise performance at frequencies which are a substantial fraction of  $f_T$  cannot be satisfactorily obtained merely by adding the usual hybrid  $\pi$  capacitances to it. The intrinsic noise mechanisms become partially correlated at higher frequencies, leading to a poorer noise performance. However, up to frequencies approaching  $f_T/\sqrt{\beta}$ , which includes all normal audio work and some r.f. applications as well, these effects do not need to be taken into account for ordinary engineering design work.<sup>‡</sup>

While the attractively easy-to-remember three-noise-generator equivalent circuit of Fig. 9(a) could be used as it stands for calculating the noise performance of existing transistor amplifier stages, it is found much more convenient, for design purposes, to represent the noise behaviour of a transistor, or any other linear amplifying device for that matter, by only two noise generators placed right at the input terminals, i.e. arranged as in Fig. 10.\*\*

<sup>†</sup> Mr. S. W. Noble, of the Royal Radar Establishment, has shown that the circuit of Fig. 9(a) is exactly equivalent at low frequencies to the well-known T-circuit, as given, for example, in Fig. 5 of reference 11, and that, assuming no correlation between the three noise generators in the latter circuit, the three generators in Fig. 9(a) are also uncorrelated. An independent check on the equivalence of the two circuits was obtained by calculating the low-frequency noise-figure formula from Fig. 9(a), without introducing any approximations, and this agreed exactly with equation (19) of reference 11.

<sup>‡</sup> At audio frequencies, as explained later, it is best, for good noise performance, to operate at a very low value of collector current, e.g. 10  $\mu$ A. Even a fast silicon planar transistor, such as the BC109, then has an  $f_T$  of only a few hundred kHz, so that the "low-frequency regime" only just includes the whole audio spectrum. However, in most r.f. applications, where flicker noise is not involved, it is better, from several points of view, to operate at much higher values of collector current. and then the "low-frequency regime" may extend up to some MHz.

\*\* By choosing the values of  $V_N$  and  $I_N$  correctly, together with the right degree of correlation between them, the noise of any linear amplifier, and its variation with source impedance, may be correctly represented. This is considered in more detail in reference 11.

Fig. 9. Noise generators in the hybrid- $\pi$  equivalent circuit.

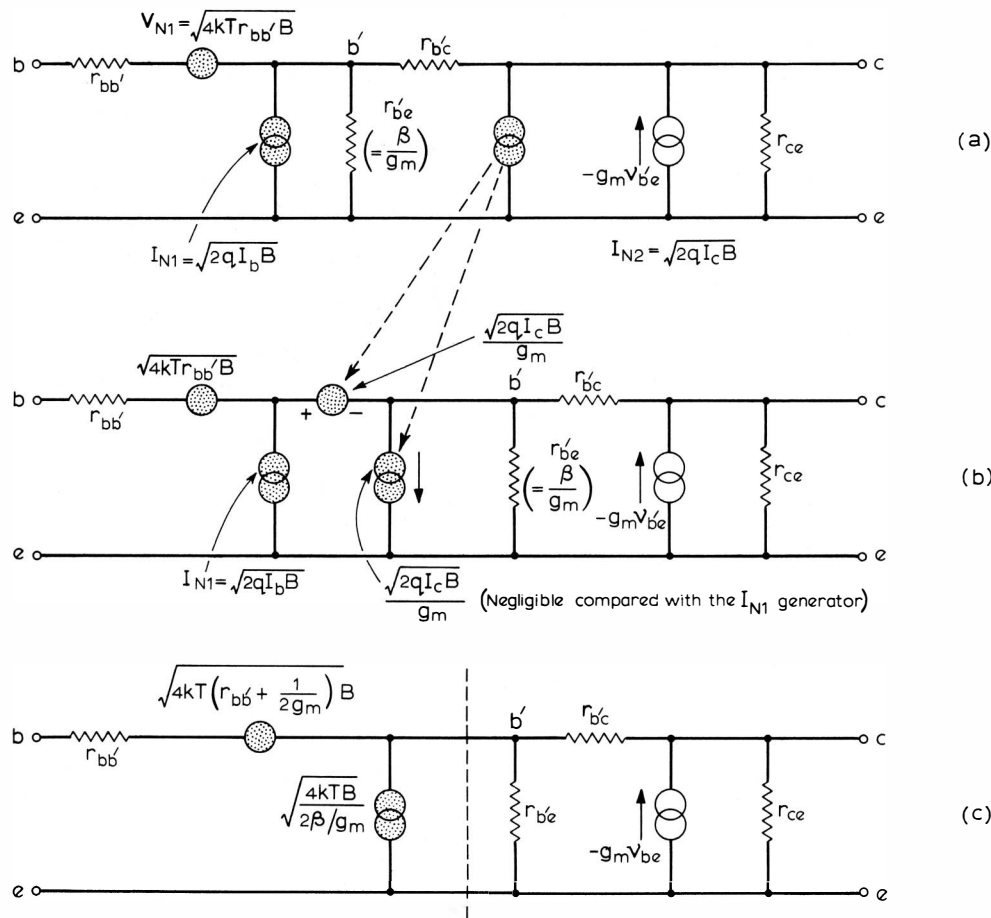



The problem is thus to convert Fig. 9(a) into the form of Fig. 10. The first move is to exploit the fact that the right-hand noise-current generator in Fig. 9(a) may be replaced by the two 100%-correlated generators of Fig. 9(b), as indicated by the broken-line arrows. It will be found that these two generators produce the same noise output from the transistor, whatever source or load are connected to it, as does the single generator from which they are derived. (It is interesting to find that, taking  $r_{b'e}$  as infinite, the two generators cancel each other as far as feeding noise current into the base signal source is concerned—this ought to be so, because the single generator they represent is purely in the output circuit.)

Now in Fig. 9(b), since  $r_{b'e} g_m = \beta$  and since  $I_c/I_b \approx \beta$ , the right-hand noise current generator is of approximately  $\sqrt{\beta}$  times smaller magnitude than the left-hand one and can therefore be neglected without serious error.

The next move, which will be seen later to be sensible, is to express all the remaining three uncorrelated generators in Fig. 9(b) in terms of resistance values which would produce the same magnitude of noise by one of the Johnson noise formulae (7) or (8); the generator labelled  $\sqrt{4kTr_{bb'}B}$  is, of course, already in that form. This can be done by utilizing the basic fact for a transistor that  $g_m = qI_c/kT$ . Thus, substituting  $q = kTg_m/I_c$  in the formula for the right-hand voltage generator in Fig. 9(b), this generator becomes  $\sqrt{4kTB(I/2g_m)}$ , i.e. as for the Johnson noise voltage in a resistance of  $I/2g_m$ .

Similarly, the current generator  $\sqrt{2qI_bB}$  in Fig. 9(b) becomes:

$$\sqrt{\frac{4kTB}{2I_c/g_m I_b}}$$

Taking  $I_c/I_b$  as being equal to the small-signal current gain  $\beta$ —which is a more accurate approximation with some transistors than with others—the last expression becomes equal to:

$$\sqrt{\frac{4kTB}{2\beta/g_m}}$$

i.e. as for the short-circuit Johnson-noise current in a resistance of  $2\beta/g_m$ .

We thus arrive at the approximate equivalent circuit of Fig. 9(c), and it will be seen that this is of the same form as Fig. 10, except for the presence of the noiseless resistance  $r_{bb'}$ . However, it is shown in the Appendix that, provided  $g_m r_{bb'}$  is  $\ll 2\beta$ , the effect of  $r_{bb'}$  may be neglected with little error. For a fairly typical modern transistor with  $r_{bb'} = 200 \Omega$  and  $\beta = 200$ ,  $g_m r_{bb'}$  is less than a tenth of  $2\beta$  for collector currents up to 5 mA. In all normal audio applications, and many others too, the working current will be well under this value, and we may then take the noise equivalent circuit as being nearly enough that of Fig. 9(c) without  $r_{bb'}$  and with no correlation between  $V_N$  and  $I_N$ .

The final conclusion is thus that, for many practical purposes, we may represent the

Fig. 10. Representation of amplifier noise by two generators right at the input terminals.

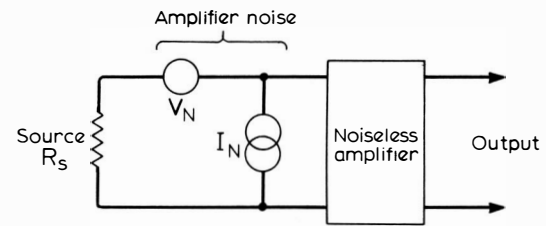
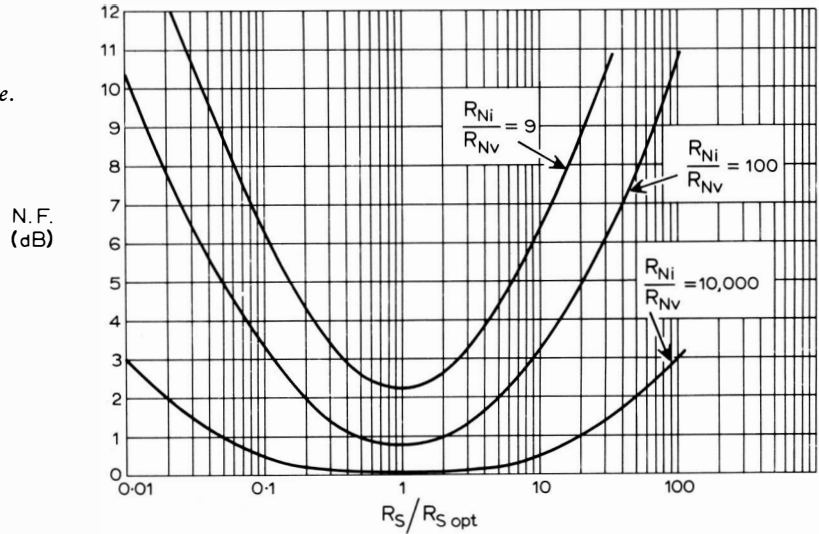

Fig. 11. Variation of Noise Figure with source resistance.



noise of a transistor (ignoring flicker noise) sufficiently accurately by means of two uncorrelated noise generators as shown in Fig. 10, where:

$V_N$  is as for the Johnson-noise voltage in a resistance

$$R_{Nv} \approx r_{bb'} + I/2g_m \dots (15)$$

and  $I_N$  is as for the Johnson-noise short-circuit current from a resistance

$$R_{Ni} \approx 2\beta/g_m \dots (16)$$

It is the usual present-day practice to express  $V_N$  and  $I_N$  in terms of microvolts and microamps in a bandwidth of 1 Hz,†† but their expression in terms of  $R_{Nv}$  and  $R_{Ni}$  seems very much preferable and has been strongly advocated by Dr. E. A. Faulkner of Reading University<sup>11,13</sup>. The full virtue of Dr. Faulkner's method will become apparent from what follows in the next section of the article.

### Noise Figure

The noise figure of an amplifier, fed from a resistive signal source  $R_S$  as in Fig. 10, is a measure of the amount by which the total noise output exceeds what it would be if the amplifier were ideal and the only noise came from thermal agitation in  $R_S$ . Thus:

$$\text{Noise Figure} = \frac{\text{Total noise output power}}{\text{Noise output power due to source only}} \dots (17)$$

†† Often the rather barbarian expressions "microvolts per root cycle" and "microamps per root cycle"—or "..." per root hertz—are used!

This ratio is often expressed in dB, and when there is no correlation between  $V_N$  and  $I_N$  (Fig. 10), it is easily shown that:

$$\text{N.F.} = 10 \log_{10} \left[ 1 + \frac{R_{Nv}}{R_S} + \frac{R_S}{R_{Ni}} \right] \text{ dB} \dots (18)$$

where  $R_{Nv}$  and  $R_{Ni}$  have already been defined.

It is evident from the form of equation (18) that there must be an optimum value of  $R_S$  which will make the noise figure a minimum, i.e. give the best noise performance. Calling this optimum value of source resistance  $R_{Sopt}$ , we have, not surprisingly, the result:

$$R_{Sopt} = \sqrt{R_{Nv}R_{Ni}} \dots (19)$$

It is also obvious from (18) that for a good, i.e. low, noise figure,  $R_{Ni}$  must be very much greater than  $R_{Nv}$ . For example, if  $R_{Nv} = 200 \Omega$  and  $R_{Ni} = 20 \text{ k}\Omega$ , it is immediately evident that a fairly good noise figure is achievable and that the optimum source resistance is the geometric mean of  $200 \Omega$  and  $20 \text{ k}\Omega$ , which is  $2 \text{ k}\Omega$ . The ease with which these things may be seen at a glance when the transistor noise information is given in the form of  $R_{Nv}$  and  $R_{Ni}$  values is a great advantage of the method when compared with the usual practice of quoting  $V_N$  and  $I_N$  values for a bandwidth of 1 Hz.

On substituting the value of  $R_S$  given by equation (19) in equation (18), we get the result:

$$(\text{N.F.})_{\min} = 10 \log_{10} \left[ 1 + 2\sqrt{\frac{R_{Nv}}{R_{Ni}}} \right] \dots (20)$$

and by further substituting the values of  $R_{Nv}$  and  $R_{Ni}$  given by equations (15) and (16) into (20), we obtain:

$$(N.F.)_{\min} = 10 \log_{10} \times \left[ 1 + \sqrt{\frac{1 + 2g_m r_{bb'}}{\beta}} \right] \dots (21)$$

This gives the minimum noise figure that will be obtainable, at a given value of d.c. working current in the transistor, if  $R_S$  is adjusted (e.g. by suitably choosing the ratio of an input transformer) for optimum performance. However, we are also free in many cases to choose the value of the d.c. working current, and this may be varied, keeping  $R_S$  optimized all the time, to obtain the lowest possible value of minimum noise figure. This latter operation involves finding the minimum value of  $(1 + 2g_m r_{bb'})/\beta$ . Now  $2g_m r_{bb'}$  normally reaches unity at a collector current somewhere in the region of  $50 \mu A$ , so no large improvement would be expected to result from reducing the collector current to a

very much lower value than this. Indeed, with some transistors, the fall-off in  $\beta$  at very low currents, say less than  $10 \mu A$ , more than offsets the slight further reduction in  $(1 + 2g_m r_{bb'})$  achieved, and the minimum noise figure then gets worse again. However, in situations where flicker noise is significant, there is a marked overall advantage, as will be seen later, in operating at very low values of collector current, such as  $1 \mu A$  or even less.

Sometimes, in practice, the value of  $R_S$  is fixed by circumstances over which the designer has no control, and the problem is to choose the value of collector current which will then give the minimum noise figure. On substituting the values of  $R_{Nv}$  and  $R_{Ni}$  given in equations (15) and (16) in equation (18), and then differentiating with respect to  $g_m$ , we find that the condition for minimum noise figure is  $g_m = \sqrt{\beta}/R_S$ . Thus, if  $R_S = 1 \text{ k}\Omega$ , and  $\beta = 100$ , we get  $g_m = 10 \text{ mA/V}$ , which corresponds to  $I_c = 0.25 \text{ mA}$ .

As an example of what can be achieved when we are free to choose the value of  $R_S$ , consider a transistor such as a BC109 running at a collector current of  $10 \mu A$ . Take  $\beta = 200$ ,  $r_{bb'} = 200 \Omega$ . The  $g_m$  value will be  $0.4 \text{ mA/V}$ , so that, from (15),  $R_{Nv} = 1.45 \text{ k}\Omega$ , and from (16),  $R_{Ni} = 1 \text{ M}\Omega$ . From equation (19) we then get  $R_{Sopt} = 38 \text{ k}\Omega$ , and substituting this in (18), or from (20) or (21), we obtain a noise figure of  $0.32 \text{ dB}$ .

Noise figures not much greater than this are indeed achievable in practice with good modern silicon planar transistors at audio frequencies, but it is important not to overlook the fact that, having obtained a very good noise figure for the first stage of an amplifier, the second stage may easily contribute as much noise as the first, or even more.

With regard to the last point, the danger arises particularly when the second stage, as is often the case in practical designs, is run

at a much higher current than the first. The trouble is caused by the current noise generator (see Fig. 9(c)) of the second transistor, which, because of the high working current, will be of relatively large magnitude. It may thus produce more noise current, particularly at low frequencies, because of flicker noise, than that coming from the collector of the (very-low- $g_m$ ) first stage. Dr. Faulkner has recommended that the second stage of a low-noise amplifier should be run at the same low collector current as the first stage, though it is not always worth carrying things quite as far as this—some compromise with other requirements will often be struck, even in an enlightened design.

Fig. 11 is simply based on equations (18) and (19), and shows how the noise figure increases as  $R_S$  is changed from its optimum value  $R_{Sopt}$ . The important point is that provided the optimum noise figure is good enough, i.e. provided  $R_{Ni}/R_{Nv}$  is large enough, the value of source resistance becomes very uncritical. Thus it may be worth aiming at a very good minimum noise figure not so much for its own sake but rather because it makes the amplifier capable of giving a tolerably good noise performance over a wide range of source resistance values.

Fig. 12, based on a contribution to *Electronics Letters* from Dr. Faulkner<sup>13</sup>, is a plot, on a "straight line approximation" basis, of equations (15) and (16), and also illustrates the meaning of equation (19).

A slight complication in all the above, which should now be mentioned, is that, according to reference (10), the value of  $r_{bb'}$  which gives the correct input impedance does not, in general, give the correct value for the noise generator. At low currents, however,  $r_{bb'}$  is in any case swamped by  $1/2g_m$  (see Fig. (12)), so uncertainty about its value does not matter much. But the true value of much of the above simple theory is not so much that it enables precise calculations to be made, but rather that it helps one to appreciate the principles involved and avoid misdesign caused by ignorance. It is often sufficient to obtain the correct order of magnitude of noise effects in the design stage, and to make experimental checks later if necessary.

Another method of presenting noise data for a transistor is shown in Fig. 13, and is self explanatory. (Taken from S.T.C. data sheet; the Mullard data sheets do not give such detailed noise information.)

### Flicker Noise<sup>1</sup>

Flicker noise, or "1/f" noise, is exhibited by all normal amplifying devices, and transistors are no exception. To quote from reference 10: "Flicker noise is known to arise from the generation or recombination of carriers on the surface, although other physical processes can also produce it. For example, it can also arise as a result of temperature fluctuations. Note that only  $0.001^\circ C$  fluctuation in temperature can cause 2 to 3 microvolts of fluctuation in voltage across a forward biased diode."

From reference 14, on which the following

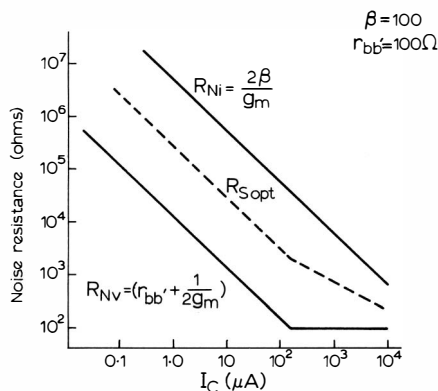
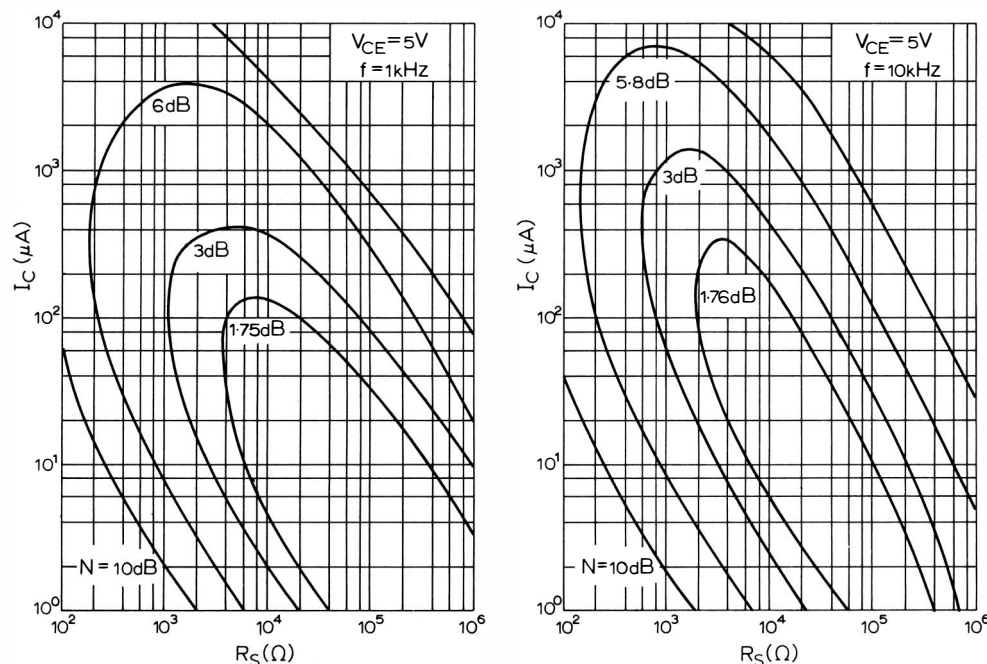

Fig. 12. Variation of  $R_{Nv}$  and  $R_{Ni}$  with collector current.

Fig. 13. Contours of constant Noise Figure vs. collector current and source resistance for type BC109 transistor.





information is based, it would seem that, for a planar transistor, flicker noise can be represented as an increase in the current noise generator (see Fig. 9(c)) below a certain frequency, the voltage noise generator not exhibiting flicker effect. Thus the resistance  $R_{Ni}$  representing the current noise generator falls in value below a certain frequency, so we replace equation (16) by:—

$$R_{Ni} = \frac{2\beta}{g_m(1 + \omega_F/\omega)} \dots (22)$$

Actually there is evidence that  $R_{Nv}$  does exhibit flicker effect, but its value does not begin to rise until a much lower frequency than  $\omega_F$ .

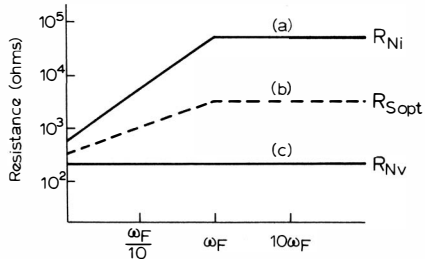

Fig. 14. Input noise generators for a transistor exhibiting flicker noise.  $\beta = 100$ ,  $r_{bb'} = 100 \Omega$ ,  $I_C = 100 \mu A$ .

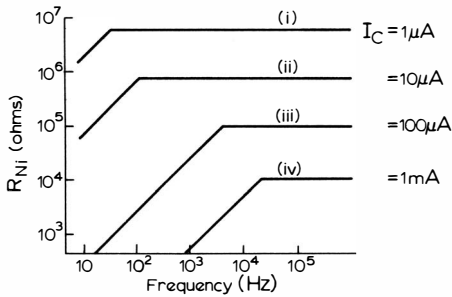

Fig. 15. Variation of  $R_{Ni}$  with frequency and collector current for selected 2N3707.

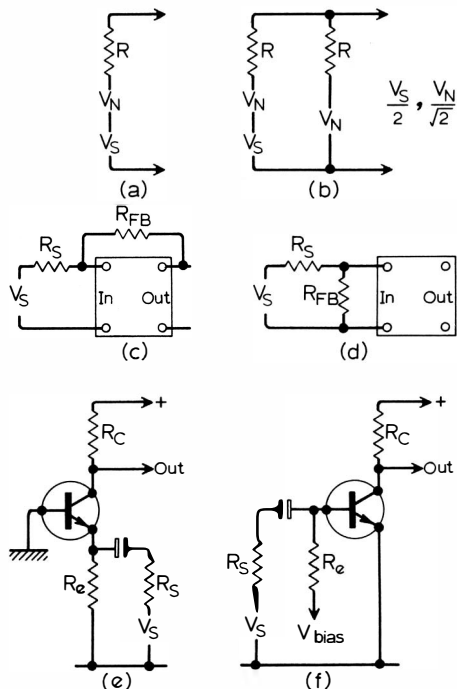

Fig. 16. Negative feedback and noise.

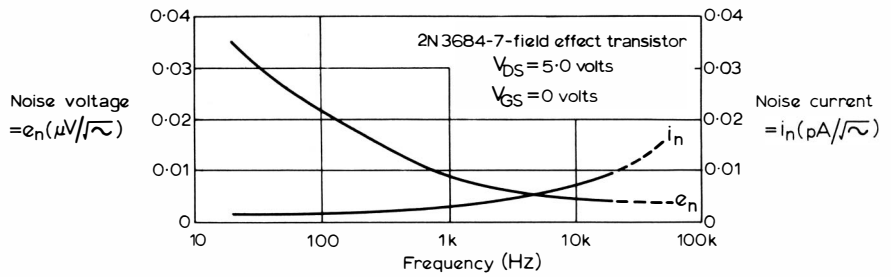

Fig. 17. Equivalent input noise voltage and current vs. frequency, for a junction f.e.t.

Fig. 14 shows the variation of  $R_{Ni}$ ,  $R_{Nv}$  and  $R_{Sopt}$  with frequency.

The parameter  $\omega_F$ , the flicker-noise corner frequency, characterises the "flicker-noisiness" of the transistor; it is a function of the collector current,  $I_C$ . Fig. 15 shows the behaviour of a transistor with regard to flicker noise, as a function of frequency and collector current. The lines are best-fit lines, of the same form as in Fig. 14, to a series of experimental measurements done at Reading University on a selected specimen of the low-noise transistor 2N3707, and represent an exceptionally good transistor from the flicker-noise point of view. It will be seen that, for a collector current of  $1 \mu A$ ,  $\omega_F/2\pi$  is only about 60 Hz, and this particular specimen will give a noise figure of better than 1 dB from a 100-k $\Omega$  source over the whole frequency range 25 Hz to 40 kHz. Clearly it is particularly advantageous to operate a transistor at very low current when a good noise figure is required at very low frequencies.

### Negative Feedback and Noise

Negative feedback as such has no effect whatever on the noise figure of an amplifier at any given frequency, though the passive components introduced for the purpose of applying the feedback may do so.

The golden rule for preserving good noise figure is to avoid introducing passive resistive attenuation of the signal.

Consider a resistive signal source, with a signal voltage  $V_S$  and a Johnson noise voltage  $V_N$ , as shown in Fig. 16(a). Now, as shown in Fig. 16(b), imagine an extra resistor of the same value as the signal source resistance to be shunted across. This shunt reduces by a factor of two the signal voltage appearing at the output leads shown, and does likewise for the source Johnson noise voltage, but it also produces its own Johnson noise voltage  $V_N$  which appears attenuated by a factor of two at the output leads. There are thus two uncorrelated noise voltage components of  $V_N/2$  at the output, so that the total output noise voltage is  $V_N/\sqrt{2}$ . The net effect of adding the extra resistor is thus to attenuate the signal by a voltage factor of two, but to reduce the noise voltage by a factor of only  $\sqrt{2}$ .

Clearly, to minimise the loss of signal-to-noise ratio caused by a shunt resistor, the resistor value must be much higher than that of the source. A practical example of a situation in which these issues arise is shown in Fig. 16(c) and (d), where, for good s/n,

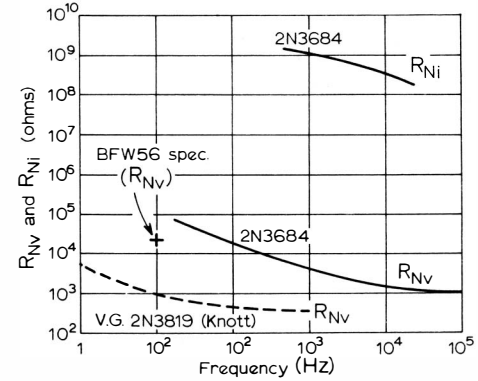

Fig. 18. Variation of  $R_{Nv}$  and  $R_{Ni}$  with frequency for 2N3684 and 2N3819 f.e.t.s.

$R_{FB}$  should be made several times  $R_S$  at least. The s/n, at any one frequency, will be just the same for the two circuits shown.

Another example of the same broad principle is shown in Fig. 16(e) and (f). Here the significant thing is that there is passive resistive attenuation of signal because the signal source is shunted by a resistor  $R_e$ ; the fact that in the left-hand circuit the output current is allowed to flow through the parallel combination of  $R_S$  and  $R_e$  to provide negative feedback does not in itself affect the signal-to-noise ratio.

### Noise in f.e.t.s

The noise performance of an f.e.t., like that of an ordinary transistor or any other amplifying device, may be expressed in terms of  $V_N$  and  $I_N$  noise generators in the input circuit of an imaginary noiseless f.e.t.

Fig. 17, which is taken from Union Carbide Application Note AN-1 (June 1965), shows experimental values of  $V_N$  and  $I_N$  (here called  $e_n$  and  $i_n$ ) as a function of frequency. It is stated that the values of  $V_N$  and  $I_N$  are not very dependent on the d.c. operating current, provided the drain-to-source voltage exceeds the pinch-off value.

The same information as is presented in Fig. 17 is given in a form much easier to appreciate in Fig. 18 (full-line curves); this diagram also includes (broken-line curve) data on a specially-selected and unusually good sample of 2N3819 reported upon by K. F. Knott of Salford University.<sup>16</sup>

While the sample of f.e.t. giving the broken-line curve has a quite splendid noise performance, it is unfortunately the case, at present, that very large variations indeed in

flicker noise occur between different samples of nominally the same f.e.t. However, f.e.t.s with a definite specification on flicker noise can now be bought—e.g. the Texas BF56, which has an upper limit on  $R_{Nv}$  as indicated by the cross in Fig. 18. This transistor costs over £3 at present.

Comparing Fig. 18 with Figs. 12 and 14, it will be seen that an f.e.t. has an enormously greater ratio of  $R_{Ni}$  to  $R_{Nv}$  than an ordinary transistor, and it will also be noticed that flicker noise appears in the voltage generator (represented by  $R_{Nv}$ ) rather than in the current noise generator. Indeed the current-noise generator magnitude appears to fall off as the frequency is reduced, if one can believe this  $R_{Ni}$  curve. According to reference 17, the increased current noise at high frequencies is due to "induced gate noise", analogous to "induced grid noise"<sup>18</sup> which appears at much higher frequencies in valves. Nevertheless it would seem that, at sufficiently low frequencies flicker noise on the gate current must become dominant, causing  $R_{Ni}$  to fall off again at very low frequencies.

However, because of the enormous ratio of  $R_{Ni}$  to  $R_{Nv}$  in an f.e.t., very low noise figures can be obtained under suitable operating conditions. For example, from Fig. 18, with a 1 MΩ source, which is about the optimum, being half way between  $R_{Nv}$  and  $R_{Ni}$  on the log scale, equation (18)

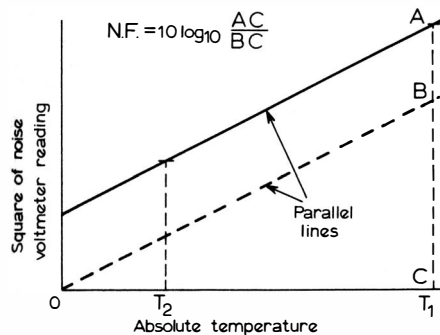
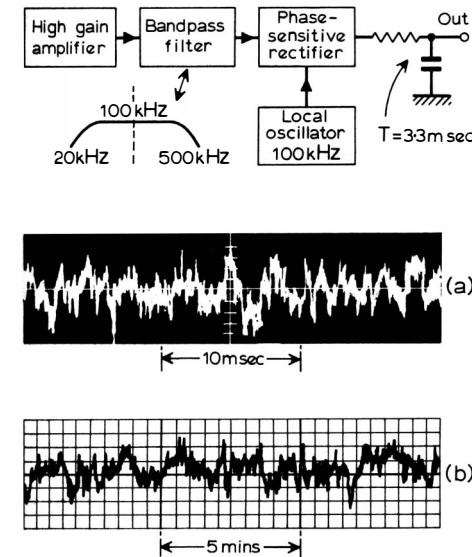

Fig. 19. Technique for measuring noise figure.  $T_1$  = room temperature  $\approx 290^\circ\text{K}$ .  $T_2$  = liquefied gas temperature.

Fig. 20. System used for generating white noise: (a) result from system shown; (b) l.f. version with  $T = 10\text{s}$ .



yields a noise figure at 1,000 Hz of 0.02 dB.

In many applications, with source resistances not exceeding a few hundred kilohms, only  $R_{Nv}$  need be taken into account, just as with the equivalent noise resistance of a thermionic valve.

The following simple formula is often quoted for the voltage noise of an f.e.t.:

$$R_{Nv} = 0.7/g_m \quad \dots (23)$$

in which  $R_{Nv}$  is in kΩ if  $g_m$  is in mA/V

Knott reports, as a result of measurements on large numbers of f.e.t.s, that above about 10 kHz,  $R_{Nv}$  does in fact approach the value given by this formula—so that at these high frequencies increasing the working current does reduce  $R_{Nv}$ —but that at much lower frequencies, where flicker noise is dominant, increasing the current increases  $R_{Nv}$ . Since these effects are in opposite directions, there will be a frequency band over which varying the working current has very little effect on  $R_{Nv}$ , and this may be the reason for the remark, in the Union Carbide Application Note referred to above, that  $V_N$  and  $I_N$  are not very dependent on the d.c. operating current.

An important point to appreciate is as follows. With ordinary transistors, whilst very good noise performance can be obtained at audio and sub-audio frequencies, the low collector current required necessarily makes the high frequency performance very poor, even using fast silicon planar transistors. With f.e.t.s, however, the good low-frequency noise performance is maintained up to frequencies of some MHz. Thus, using f.e.t.s, it is possible to design an amplifier with a first-class noise performance over a very wide frequency band, to an extent which is quite impossible with a straightforward amplifier using ordinary transistors.

### Measuring Noise Figures

In the opinion of the author, who has used no other method for over ten years, much the easiest and generally most satisfactory way of measuring the noise figure of an amplifier is to dip the source resistor in liquid nitrogen or other liquefied gas and observe the drop in the output noise level of the amplifier.\*\*\* A check should be made that the resistance value of the source resistor does not change significantly on cooling it down, though a normal wire-wound resistor will be found satisfactory in this respect. It is not essential to use a true r.m.s. reading output meter, as only the ratio of two mean squared output voltages is required—indeed an AVO on an a.c. volts range will often suffice. The noise figure is deduced in the manner shown in Fig. 19.

This technique is particularly effective for measuring good noise figures, e.g. 1 dB, where slight uncertainties regarding noise bandwidths, or the calibration of noise-generating diodes, often render more normal methods very difficult.

\*\*\* More conveniently, the amplifier input is switched between two resistors of equal value, one at a low temperature and one at room temperature.

### Generating White Noise at Low Frequencies

Noise diodes, and several other methods of generating Gaussian noise for test purposes, suffer from the difficulty that unwanted flicker noise tends to be produced below, say, 100 Hz.

A technique which is quite free from this difficulty is to generate the noise at around some easy frequency, such as 100 kHz, and then heterodyne it down to zero frequency in the manner shown in Fig. 20. This is the technique that was used to generate the white noise shown in some of the earlier illustrations. The local oscillator and frequency changer were, in fact, part of a transistor b.f.o. designed at R.R.E. some years ago, and the high-gain amplifier was a general-purpose valve laboratory amplifier of even greater age! The same basic set-up is an inherent part of a "lock-in amplifier" system designed at R.R.E. by E. F. Good, and the lower recording in Fig. 20 was obtained with this equipment. The time base speed has been adjusted to have the same ratio to the noise bandwidth in both pictures, and it is interesting to note that, despite the enormously different absolute time scales, the general appearance is the same.

### Needle Fluctuations of Noise Meters

In some noise measurements the noise-indicating meter will give a nice steady reading, whereas in other circumstances it may be found that the needle dithers about so much that it is difficult to decide what reading to note down.

The narrower the bandwidth of the noise being measured, the longer must be the effective time-constant of the rectifier and meter to produce a given amount of needle fluctuation. For the case where the noise bandwidth is determined by a sharp-cutting filter, the relationship between the quantities involved is as shown in Fig. 21. The factor "2" inside the square-root sign is different for other shapes of noise pass-band, but nevertheless the formula given will still give an answer which is of the right order, and this is usually all that is needed.

Gaussian noise is, of course, assumed in deriving this formula.

### Some Noise Bandwidths

It is sometimes inadvertently overlooked that the noise bandwidth of a circuit is not, in general, the same as its "3 dB down" bandwidth.

For an ordinary tuned circuit, as for the CR lag in Fig. 22, the noise bandwidth is  $\pi/2$  times the 3 dB-down bandwidth.

With two equal lags, each of time-constant CR, not loading one another, the response will be 6 dB down at  $1/2\pi CR$ , and the noise bandwidth is  $1/8CR$ .

With a simple CR a.c.-coupling, giving a low-frequency cut which is -3 dB at  $1/2\pi CR$ , the lower limit of the equivalent rectangular noise response will extend down to  $1/4CR$ .

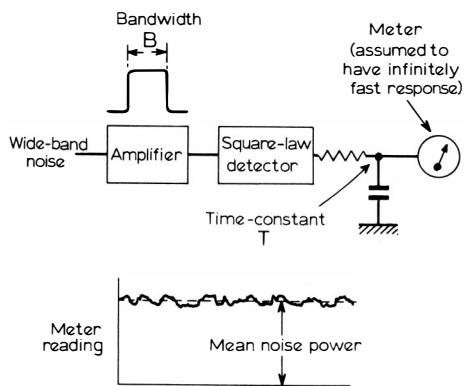
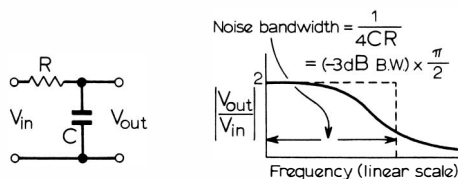

Fig. 21. Noise-meter needle fluctuations:

$$\frac{\text{r.m.s. reading fluctuations}}{\text{mean reading}} = \frac{1}{\sqrt{2BT}}$$

(e.g. for a bandwidth of 1 Hz, a smoothing time constant of 50s is required to reduce the r.m.s. meter fluctuations to 10% of the mean reading.)

Fig. 22. Noise bandwidth. The area under the broken-line rectangle is the same as that under the curve.



**Acknowledgement.** The author would like to thank this colleague, Mr. S. W. Noble, for having helped him, over a period of many years, to acquire a better understanding of noise problems—and, in particular, for having shown that Fig. 9(a) is exactly equivalent to the usual *T* circuit at low frequencies, when the author had concluded, through a slip in algebra, that this was not strictly the case!

Thanks are also due to Dr. E. A. Faulkner, whose contributions on noise topics have been found very helpful and thought-provoking.

This article, which is based on an internal lecture given by the author at R.R.E., is contributed by permission of the Director. Copyright Controller H.M.S.O.

## Appendix

Values of  $V_N$  and  $I_N$  in Fig. 10 to make Fig. 10 exactly equivalent to Fig. 9(c).

The problem is to find the values of the two noise generators in Fig. 10 which will make this circuit equivalent to Fig. 9(c) under conditions when the presence of  $r_{bb'}$  cannot be neglected. These generators will necessarily be partially correlated, even though those of Fig. 9(c) are not. Their magnitudes, however, are easily obtained, since the noise e.m.f.s seen looking back towards the source from the terminals of the noiseless amplifier must be the same in both circuits for the simple conditions of a short circuit, and an open circuit, across the source terminals.

In the circuit of Fig. 9(c), with a short circuit between 'b' and 'e', we see, looking to the left of the broken line, an e.m.f. 'E' acting in series with  $r_{bb'}$  given by:

$$E^2 = 4kTB \left( r_{bb'} + \frac{1}{2g_m} \right) + \frac{4kTB}{2\beta/g_m} r_{bb'}^2$$

or

$$E^2 = 4kTB \left( r_{bb'} + \frac{1}{2g_m} + \frac{r_{bb'}^2}{2\beta/g_m} \right)$$

For the Fig. 10 situation, with  $R_s = 0$ , the e.m.f. seen from the noiseless amplifier input terminals is simply  $V_N$ . For equivalence of the two circuits we therefore have:

$$V_N^2 = 4kTB \left( r_{bb'} + \frac{1}{2g_m} + \frac{r_{bb'}^2}{2\beta/g_m} \right) \quad \dots (i)$$

With an open circuit between 'b' and 'e' in Fig. 9(c), we see, looking to the left of the broken line, a current source of value:

$$\sqrt{\frac{4kTB}{2\beta/g_m}}$$

In Fig. 10, with  $R_s = \infty$ , we simply see  $I_N$ . Hence:

$$I_N = \sqrt{\frac{4kTB}{2\beta/g_m}} \quad \dots (ii)$$

Looking at equation (i), it will be noticed that  $V_N^2$  involves, in the third term, the same noise current generator

$$\sqrt{\frac{4kTB}{2\beta/g_m}}$$

which appears in (ii), so that  $V_N$  and  $I_N$  are partially correlated. Provided, however

$$\frac{r_{bb'}^2}{2\beta/g_m} \text{ is } \ll r_{bb'} + \frac{1}{2g_m} \quad \dots (iii)$$

the amount of correlation will be negligible. It is easily shown that the condition for the two sides of (iii) to be equal, is approximately:

$$g_m = 2\beta/r_{bb'} \quad \dots (iv)$$

If  $r_{bb'} = 100 \Omega$  and  $\beta = 100$ , (iv) gives  $g_m = 2000 \text{ mA/V}$ , which corresponds to a collector current of 50 mA.

We have thus established that the last term in (i), which may be called the correlation term, may be neglected, for normal engineering purposes, provided the working current does not exceed, say, 5 mA.††† This condition will be satisfied with a large factor to spare, except in some high-frequency amplifiers.

Thus equation (15) may be used to determine  $R_{Nv}$  in most practical design

††† Reference 11, in equation (21), gives a condition for negligible correlation, which, whilst correct, appears to be unnecessarily stringent for normal practical purposes.

work, but at high values of collector current, the expression becomes:

$$R_{Nv} = r_{bb'} + \frac{1}{2g_m} + \frac{r_{bb'}^2}{2\beta/g_m} \dots (v)$$

Equation (16) is, however, applicable even at high currents. Equations (v) and (16) are plotted in reference 15 as universal curves, though in terms of  $V_N$  and  $I_N$  for a 1 Hz bandwidth instead of in terms of  $R_{Nv}$  and  $R_{Ni}$ .

## REFERENCES

- "Theory of Shot Noise in Junction Diodes and Junction Transistors" by A. van der Ziel. *Proc. I.R.E.*, Vol. 43, No. 11, pp. 1639-1646 (Nov. 1955).
- "Theory of Shot Noise in Junction Diodes and Junction Transistors" by A. van der Ziel. *Proc. I.R.E.*, Vol. 45, No. 7, p. 1011 (July 1957). See also Vol. 48, pp. 114-115 (Jan. 1960). (Letters).
- "Shot Noise in Transistors" by G. H. Hansen and A. van der Ziel. *Proc. I.R.E.*, Vol. 45, No. 11, pp. 1538-1542 (Nov. 1957).
- "Behaviour of Noise Figure in Junction Transistors" by E. G. Nielsen. *Proc. I.R.E.*, Vol. 45, No. 7, pp. 957-963 (July 1957).
- "Theory and Experiments on Semiconductor Junction Diodes and Transistors" by W. Guggenbuehl and M. J. O. Strutt. *Proc. I.R.E.*, Vol. 45, No. 6, pp. 839-854 (June 1957).
- "Characteristics and Limitations of Transistors" by R. D. Thornton, D. DeWitt, E. R. Chenette and P. E. Gray. Vol. 4 of Semiconductor Electronics Education Committee series. John Wiley (1966). Chapter 4 (44 pages), on noise in general and transistor noise in particular, though on the whole excellent, is recommended with some reservations, because the high-frequency noise treatment for transistors seems to have been simplified too far, and because the "noise temperature" concept is used throughout instead of "noise figure"—this is perfectly sound and correct, but may be confusing to readers of the present article.
- "The Design of Low-Noise Audio Frequency Amplifiers" by E. A. Faulkner. *The Radio and Electronic Engineer (J.I.E.R.E.)*, Vol. 36, No. 1, pp. 17-30. (July 1968). Strongly recommended.
- "Some Measurements on Low-Noise Transistors for Audio-frequency Applications" by E. A. Faulkner and D. W. Harding. *The Radio and Electronic Engineer*, Vol. 36, No. 1, pp. 31-33 (July 1968). Very useful information for designers.
- "Optimum Design of Low-Noise Amplifiers" by E. A. Faulkner. *Electronics Letters (I.E.E.)*, Vol. 2, No. 11, pp. 426-427 (Nov. 1966).
- "Flicker Noise in Silicon Planar Transistors" by E. A. Faulkner and D. W. Harding. *Electronics Letters*, Vol. 3, No. 2, pp. 71-72 (Feb. 1967). (See p. 176 of same vol. for errata.)
- "The Influence of Transistor Parameters on Transistor Noise Performance—a Simplified Presentation" by M. C. Swiontek and R. Hassun. *Hewlett-Packard Journal*, Vol. 16, No. 7, pp. 8-12 (March 1965).
- "Comparison of Varactor-Diode and J.-F.E.T. Low-Noise L.F. Amplifiers" by K. F. Knott. *Electronics Letters*, Vol. 3, No. 11, p. 512 (Nov. 1967). See also March 1968, p. 92.
- "Field Effect Transistors as Low-Noise Amplifiers" by P.O. Lauritzen and O. Leistiko. Fairchild Report AR93.
- "Vacuum Tube Amplifiers" by Valley and Wallman. (M.I.T. Series). McGraw-Hill (1948). See p. 625.
- "Spontaneous Fluctuations of Voltage" by E. B. Moullin. Oxford Press (1938). This is a fascinating book, because it conveys vividly the atmosphere of achievement, technical difficulty, and occasionally sheer mystery, which accompanied the unravelling of the basic principles of electrical noise.